



POINT I/O 24V DC Expansion Power Supply

Catalog Numbers 1734-EP24DC, Series B

Table of Contents

Topic	Page
Important User Information	2
Environment and Enclosure	3
Prevent Electrostatic Discharge	3
North American Hazardous Location Approval	5
European Hazardous Location Approval	6
About the Power Supply	7
Install the Power Supply	8
Remove the Power Supply	8
Wire the Power Supply	9
Specifications	13

Important User Information

Solid-state equipment has operational characteristics differing from those of electromechanical equipment. Safety Guidelines for the Application, Installation and Maintenance of Solid State Controls (Publication [SGI-1.1](#) available from your local Rockwell Automation sales office or online at <http://www.rockwellautomation.com/literature/>) describes some important differences between solid-state equipment and hard-wired electromechanical devices. Because of this difference, and also because of the wide variety of uses for solid-state equipment, all persons responsible for applying this equipment must satisfy themselves that each intended application of this equipment is acceptable.





In no event will Rockwell Automation, Inc. be responsible or liable for indirect or consequential damages resulting from the use or application of this equipment.

The examples and diagrams in this manual are included solely for illustrative purposes. Because of the many variables and requirements associated with any particular installation, Rockwell Automation, Inc. cannot assume responsibility or liability for actual use based on the examples and diagrams.

No patent liability is assumed by Rockwell Automation, Inc. with respect to use of information, circuits, equipment, or software described in this manual.

Reproduction of the contents of this manual, in whole or in part, without written permission of Rockwell Automation, Inc., is prohibited.

Throughout this manual, when necessary, we use notes to make you aware of safety considerations.

	WARNING: Identifies information about practices or circumstances that can cause an explosion in a hazardous environment, which may lead to personal injury or death, property damage, or economic loss.
	ATTENTION: Identifies information about practices or circumstances that can lead to personal injury or death, property damage, or economic loss. Attentions help you identify a hazard, avoid a hazard and recognize the consequences.
	SHOCK HAZARD: Labels may be on or inside the equipment (for example, drive or motor) to alert people that dangerous voltage may be present.
	BURN HAZARD: Labels may be on or inside the equipment (for example, drive or motor) to alert people that surfaces may reach dangerous temperatures.
IMPORTANT	Identifies information that is critical for successful application and understanding of the product.

Environment and Enclosure



ATTENTION: This equipment is intended for use in a Pollution Degree 2 industrial environment, in overvoltage Category II applications (as defined in IEC publication 60664-1), at altitudes up to 2000 meters (6562 ft) without derating.

This equipment is considered Group 1, Class A industrial equipment according to IEC/CISPR Publication 11. Without appropriate precautions, there may be potential difficulties ensuring electromagnetic compatibility in other environments due to conducted as well as radiated disturbance.

This equipment is supplied as open-type equipment. It must be mounted within an enclosure that is suitably designed for those specific environmental conditions that will be present and appropriately designed to prevent personal injury resulting from accessibility to live parts. The enclosure must have suitable flame-retardant properties to prevent or minimize the spread of flame, complying with a flame spread rating of 5VA, V2, V1, V0 (or equivalent) if non-metallic. The interior of the enclosure must be accessible only by the use of a tool. Subsequent sections of this publication may contain additional information regarding specific enclosure type ratings that are required to comply with certain product safety certifications.

In addition to this publication, see:

- Industrial Automation Wiring and Grounding Guidelines, for additional installation requirements, Allen-Bradley publication [1770-4.1](#).
- NEMA Standards publication 250 and IEC publication 60529, as applicable, for explanations of the degrees of protection provided by different types of enclosure.

Prevent Electrostatic Discharge



ATTENTION: This equipment is sensitive to electrostatic discharge, which can cause internal damage and affect normal operation. Follow these guidelines when you handle this equipment:

- Touch a grounded object to discharge potential static.
 - Wear an approved grounding wriststrap.
 - Do not touch connectors or pins on component boards.
 - Do not touch circuit components inside the equipment.
 - Use a static-safe workstation, if available.
 - Store the equipment in appropriate static-safe packaging when not in use.
-

4 POINT I/O 24V DC Expansion Power Supply



WARNING: When you insert or remove the module while backplane power is on, an electrical arc can occur. This could cause an explosion in hazardous location installations. Be sure that power is removed or the area is nonhazardous before proceeding. Repeated electrical arcing causes excessive wear to contacts on both the module and its mating connector. Worn contacts may create electrical resistance that can affect module operation.



WARNING: If you connect or disconnect the communication cable with power applied to this module or any device on the network, an electrical arc can occur. This could cause an explosion in hazardous location installations.



ATTENTION: To comply with the CE Low Voltage Directive (LVD), field power and all connected I/O must be powered from a source compliant with the following:
Safety Extra Low Voltage (SELV) or Protected Extra Low Voltage (PELV).



ATTENTION: If this equipment is used in a manner not specified by the manufacturer, the protection provided by the equipment may be impaired.





ATTENTION: To comply with UL restrictions, field power and all connected devices must be powered from a single source compliant with the following:
Class 2.



ATTENTION: POINT I/O is grounded through the DIN rail to chassis ground. Use zinc plated yellow-chromate steel DIN rail to assure proper grounding. The use of other DIN rail materials (for example, aluminum, plastic) that can corrode, oxidize, or are poor conductors, can result in improper or intermittent grounding.
Secure DIN rail to mounting surface approximately every 200 mm (7.8 in.) and use end-anchors appropriately.

North American Hazardous Location Approval

The following information applies when operating this equipment in hazardous locations:	Informations sur l'utilisation de cet équipement en environnements dangereux:
<p>Products marked "CL I, DIV 2, GP A, B, C, D" are suitable for use in Class I Division 2 Groups A, B, C, D, Hazardous Locations and nonhazardous locations only. Each product is supplied with markings on the rating nameplate indicating the hazardous location temperature code. When combining products within a system, the most adverse temperature code (lowest "T" number) may be used to help determine the overall temperature code of the system. Combinations of equipment in your system are subject to investigation by the local Authority Having Jurisdiction at the time of installation.</p>	<p>Les produits marqués "CL I, DIV 2, GP A, B, C, D" ne conviennent qu'à une utilisation en environnements de Classe I Division 2 Groupes A, B, C, D dangereux et non dangereux. Chaque produit est livré avec des marquages sur sa plaque d'identification qui indiquent le code de température pour les environnements dangereux. Lorsque plusieurs produits sont combinés dans un système, le code de température le plus défavorable (code de température le plus faible) peut être utilisé pour déterminer le code de température global du système. Les combinaisons d'équipements dans le système sont sujettes à inspection par les autorités locales qualifiées au moment de l'installation.</p>
<div style="display: flex; align-items: center;">  <div> <p>EXPLOSION HAZARD</p> <ul style="list-style-type: none"> • Do not disconnect equipment unless power has been removed or the area is known to be nonhazardous. • Do not disconnect connections to this equipment unless power has been removed or the area is known to be nonhazardous. Secure any external connections that mate to this equipment by using screws, sliding latches, threaded connectors, or other means provided with this product. • Substitution of components may impair suitability for Class I, Division 2. • If this product contains batteries, they must only be changed in an area known to be nonhazardous. </div> </div>	<div style="display: flex; align-items: center;">  <div> <p>RISQUE D'EXPLOSION</p> <ul style="list-style-type: none"> • Couper le courant ou s'assurer que l'environnement est classé non dangereux avant de débrancher l'équipement. • Couper le courant ou s'assurer que l'environnement est classé non dangereux avant de débrancher les connecteurs. Fixer tous les connecteurs externes reliés à cet équipement à l'aide de vis, loquets coulissants, connecteurs filetés ou autres moyens fournis avec ce produit. • La substitution de composants peut rendre cet équipement inadapté à une utilisation en environnement de Classe I, Division 2. • S'assurer que l'environnement est classé non dangereux avant de changer les piles. </div> </div>

European Hazardous Location Approval

The following applies when the product bears the Ex Marking

This equipment is intended for use in potentially explosive atmospheres as defined by European Union Directive 94/9/EC.

DEMKO certifies that this equipment has been found to comply with the Essential Health and Safety Requirements relating to the design and construction of Category 3 equipment intended for use in Zone 2 potentially explosive atmospheres, given in Annex II to this Directive.

Compliance with the Essential Health and Safety Requirements has been assured by compliance with EN 60079-0:2012+A11:2013, EN 60079-15:2010, reference certificate number DEMKO 04ATEX0330347X.



WARNING: This equipment shall be mounted in an ATEX certified enclosure with a minimum ingress protection rating of at least IP54 (as defined in IEC60529) and used in an environment of not more than Pollution Degree 2 (as defined in IEC 60664-1) when applied in Zone 2 environments. The enclosure must utilize a tool removable cover or door.

WARNING: This equipment shall be used within its specified ratings defined by Rockwell Automation.

WARNING: Provision shall be made to prevent the rated voltage from being exceeded by transient disturbances of more than 140% of the rated voltage when applied in Zone 2 environments.

WARNING: This equipment must be used only with ATEX certified Rockwell Automation backplanes.

WARNING: Secure any external connections that mate to this equipment by using screws, sliding latches, threaded connectors, or other means provided with this product.

WARNING: Do not disconnect equipment unless power has been removed or the area is known to be nonhazardous.

WARNING: The secondary of a current transformer shall not be open-circuited when applied in Class I, Zone 2 environments.



ATTENTION: This equipment is not resistant to sunlight or other sources of UV radiation.

ATTENTION: Do not connect 120/240V AC power to this supply.

ATTENTION: Use the 1734-EP24DC expansion power supply only with 1734 POINT I/O adapters, such as the 1734-ADN DeviceNet adapter.

About the Power Supply

The expansion power supply passes 24V DC field power to the I/O modules to the right of it. The expansion power supply extends the backplane bus power for up to 17 I/O modules to the right of the supply and creates a new field voltage partition segment for driving field devices. The expansion power supply separates field power from I/O modules to the left of the unit, effectively providing functional and logical partitioning for the following.

- Separate field power between input and output modules.
- Separate field power to the analog and digital modules.
- Group modules to perform a specific task or function.

The dark-gray color of the expansion power supply allows for easy visual inspection and identification. Refer to the figure to identify external power supply components.

Use multiple expansion power supplies with POINT I/O adapters to assemble a full system. With any POINT I/O adapter, use an expansion power supply to add additional modules in 4...17 module increments, for a total of 63 I/O modules.

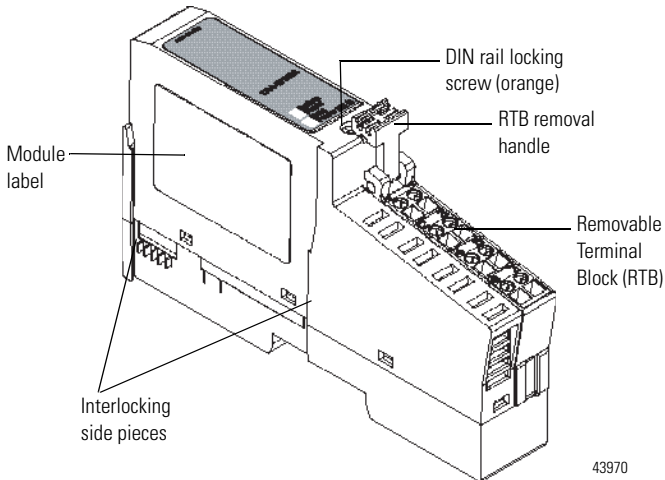

Install the Power Supply

To install the expansion power supply on the DIN rail, proceed as follows.

1. Position the power supply vertically above the DIN rail.
2. Engage the interlocking side pieces with the unit on the left.
3. Press down firmly to install the power supply on the DIN rail.
The locking mechanism locks the module to the DIN rail.

Remove the Power Supply

To remove an expansion power supply, proceed as follows.

1. Pull up on the RTB removal handle to remove the terminal block.

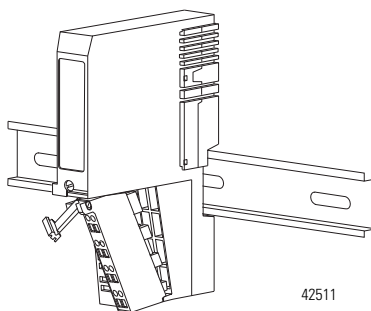

2. Remove the module to the right of the 1734-EP24DC module from its base unit.
3. Use a small-bladed screwdriver to rotate the DIN rail locking screw to a vertical position.
This releases the locking mechanism.
4. Lift straight up to remove.

Replace the Power Supply

To install a replacement expansion power supply, proceed as follows.

1. Remove the module to the right of the power supply from its base unit.
2. Position the power supply vertically above the DIN rail.

- Slide the power supply down allowing the interlocking side pieces to engage the adjacent modules (both left and right sides).
- Press firmly to seat the power supply on the DIN rail.
The power supply locking mechanism snaps into place.
- Reinsert the module into the base next to the expansion power supply.

Wire the Power Supply

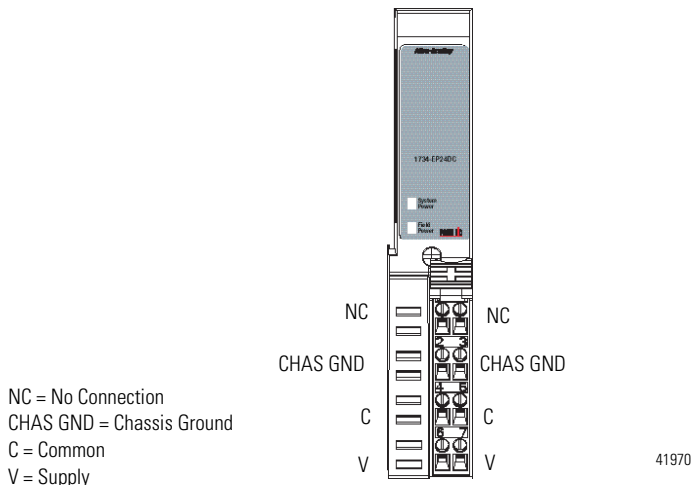

WARNING: If you connect or disconnect wiring while the field-side power is on, an electrical arc can occur. This could cause an explosion in hazardous location installations. Be sure that power is removed or the area is nonhazardous before proceeding.



ATTENTION: Use the 1734-EP24DC expansion power supply only with adapter class products.

ATTENTION: Use the 1734-EP24DC expansion power supply only with 1734 POINT I/O adapters, such as the 1734-ADN DeviceNet adapter.

12/24V DC Wiring

12/24V DC
Do not connect 120/240V AC
power to this supply.

V = 12/24V DC C = Common
CHAS GND = Chassis Ground

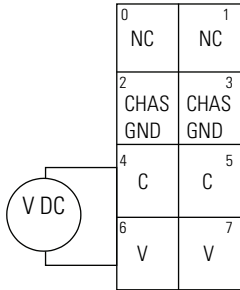

This supply will be
connected to the internal
field power bus.

43960

Connect	Terminal	Terminals (for continuing power)
+V DC	6	7
-V DC	4	5
Chas Gnd	2	3

12/24V DC becomes the internal field power bus for modules to the right.



Example of Continuing Power

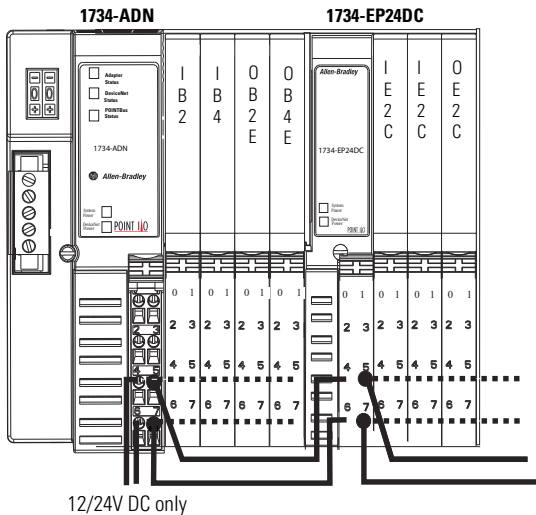

Example of Functional Partitioning

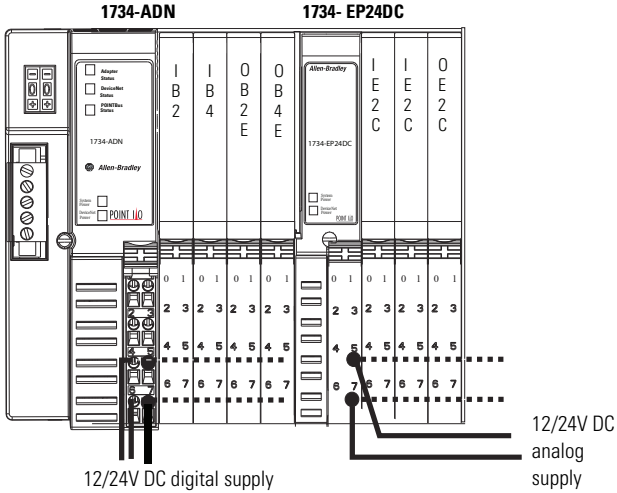

Example of Logical Partitioning

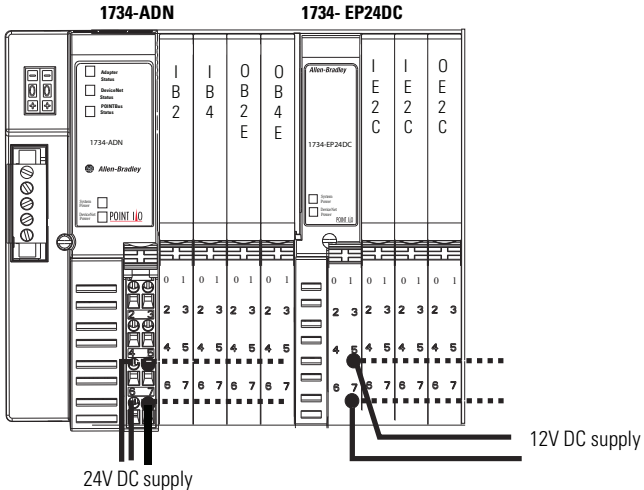

Specifications

POINT I/O 24V DC Expansion Power Supply - 1734-EP24DC

Attributes	Value
I/O module capacity	4...17 modules, depending on current rating of each module
Input voltage rating	24V DX nom 10...28.8V DC range
Field side power requirements	24V DC (+20 % = 28.8V DC max) @ 400 mA max
Inrush current, max	6 A for 10 ms
Indicators	1 – Green field power status 1 – Green 5V system power
POINTBus output current	Horizontal mounting – 1 A @ 10...19.2V input; 1.3 A @ 19.2...28.8V input Vertical mounting – 1 A @ 10...28.8V input
Input overvoltage protection	Reverse polarity protected
Interruption	Output voltage stays within specifications when inputs drops out for 10 ms @ 10V with max load
Module location	Between I/O modules in 1734 system Breaks field power bus
Limitations	Use with POINT I/O adapters only
Dimensions (HxWxD), approx.	76.2 x 25.4 x 133.4 mm (3.0 x 1.0 x 5.25 in.)
Weight, approx.	120 g (4.3 oz)
Terminal base screw torque	0.6 Nm (7 lb-in)

General

Attribute	Value
Power consumption, max	9.8 W @ 28.8V DC
Power dissipation, max	3.0 W @ 28.8V DC
Thermal dissipation, max	10.0 BTU/hr @ 28.8V DC
Field power bus, nominal voltage	24V DC

General

Attribute	Value
Field power bus, supply voltage range	10...28.8V DC
Field power bus, supply current, max	10 A
Isolation voltage	50V continuous, tested to withstand 2600V DC for 60 s
Enclosure type rating	None (open-style)
Conductor size	0.324...2.08 sq. mm (#22...#14 AWG) solid or stranded copper wire rated @ 75 °C or greater 1.2 mm (3/64 inch) insulation max
Conductor category ⁽¹⁾	1 – on power ports

⁽¹⁾ Use this Conductor Category information for planning conductor routing. Refer to publication [1770-4.1](#), Industrial Automation Wiring and Grounding Guidelines.

Environmental Specifications

Attribute	Value
Temperature, operating	IEC 60068-2-1 (Test Ad, operating cold), IEC 60068-2-2 (Test Bd, operating dry heat), IEC 60068-2-14 (Test Nb, operating thermal shock) -20...55 °C (-4...131 °F)
Temperature, storage	IEC60068-2-1 (Test Ab, unpackaged non-operating cold) IEC60068-2-2 (Test Bb, unpackaged non-operating dry heat) IEC60068-2-14 (Test Na, unpackaged non-operating thermal shock) -40...85 °C (-40...185 °F)
Relative humidity	IEC60068-2-30 (Test Db, unpackaged damp heat) 5...95% non-condensing
Vibration	IEC 60068-2-6 (Test Fc, operating): 5 g @ 10...500 Hz
Shock, operating	IEC60068-2-27 (Test Ea, unpackaged shock): 30 g
Shock, non-operating	IEC60068-2-27 (Test Ea, unpackaged shock): 50 g
Emissions	CISPR 11: Group 1, Class A

Environmental Specifications

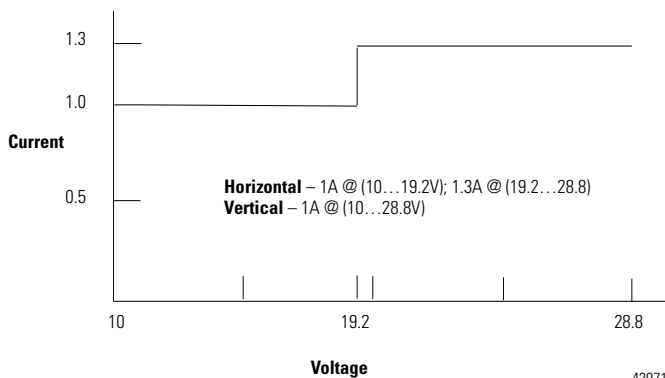

Attribute	Value
ESD immunity	IEC6100-4-2: 6 kV contact discharges 8 kV air discharges
Radiated RF immunity	IEC 61000-4-3: 10V/m with 1 kHz sine-wave 80%AM from 30...2000 MHz 10V/m with 200 Hz 50% Pulse 100%AM @ 900 MHz 10V/m with 200 Hz 50% Pulse 100%AM @ 1890 MHz
EFT/B immunity	IEC 61000-4-4: ±4 kV @ 5 kHz on power ports
Surge transient immunity	IEC 61000-4-5: ±1 kV line-line(DM) and ±2 kV line-earth(CM) on power ports
Conducted RF immunity	IEC61000-4-6 10V rms with 1 kHz sine-wave 80%AM from 150 kHz...80 MHz

Current Derating for Mounting



43971

Certifications

Certification (when product is marked) ⁽¹⁾	Value
c-UL-us	UL Listed Industrial Control Equipment, certified for U.S. and Canada UL Listed for Class I, Division 2, Group A,B,C,D Hazardous Locations, certified for U.S. and Canada
CE	European Union 89/336/EEC EMC Directive, compliant with: EN 61000-6-4; Industrial Emissions EN 50082-2; Industrial Immunity EN 61326; Meas./Control/Lab., Industrial Requirements EN 61000-6-2; Industrial Immunity
C-Tick	Australian Radiocommunications Act, compliant with: AS/NZS CISPR11; Industrial Emissions
Ex  	European Union 94/9/EC ATEX Directive, compliant with: EN 60079-0:2012+A11: 2013; General Requirements EN 60079-15: 2010; Potentially Explosive Atmospheres, Protection "n" II 3 G Ex nA IIC T4 Gc DEMKO 04 ATEX 0330347X

⁽¹⁾ See the Product Certification link at <http://www.ab.com> for Declaration of Conformity, Certificates, and other certification details.

Notes:

Notes:



Notes:

Rockwell Automation Support

Rockwell Automation provides technical information on the Web to assist you in using its products. At <http://www.rockwellautomation.com/support/>, you can find technical manuals, a knowledge base of FAQs, technical and application notes, sample code and links to software service packs, and a MySupport feature that you can customize to make the best use of these tools.

For an additional level of technical phone support for installation, configuration and troubleshooting, we offer TechConnect support programs. For more information, contact your local distributor or Rockwell Automation representative, or visit <http://www.rockwellautomation.com/support/>.

Installation Assistance

If you experience a problem within the first 24 hours of installation, please review the information that's contained in this manual. You can also contact a special Customer Support number for initial help in getting your product up and running.

United States or Canada	1.440.646.3434
Outside United States or Canada	Use the Worldwide Locator at http://www.rockwellautomation.com/support/americas/phone_en.html , or contact your local Rockwell Automation representative.

New Product Satisfaction Return

Rockwell Automation tests all of its products to ensure that they are fully operational when shipped from the manufacturing facility. However, if your product is not functioning and needs to be returned, follow these procedures.

United States	Contact your distributor. You must provide a Customer Support case number (call the phone number above to obtain one) to your distributor to complete the return process.
Outside United States	Please contact your local Rockwell Automation representative for the return procedure.

Documentation Feedback

Your comments will help us serve your documentation needs better. If you have any suggestions on how to improve this document, complete this form, publication [RA-DU002](#), available at <http://www.rockwellautomation.com/literature/>.

Allen-Bradley, Rockwell Automation, POINT I/O, POINTBus, and TechConnect are trademarks of Rockwell Automation, Inc. DeviceNet is a trademark of Open DeviceNet Vendor Association. DeviceNet is a trademark of the Open DeviceNet Vendor Association.

Trademarks not belonging to Rockwell Automation are property of their respective companies.

Rockwell Otomasyon Ticaret A.Ş., Kar Plaza İş Merkezi E Blok Kat:6 34752 İçerenköy, İstanbul, Tel: +90 (216) 5698400

www.rockwellautomation.com

Power, Control and Information Solutions Headquarters

America: Rockwell Automation, 1201 South Second Street, Milwaukee, WI 53204-2496 USA, Tel: (1) 414.382.2000, Fax: (1) 414.382.4444
Europe/Middle East/Africa: Rockwell Automation, Voorlaan/Boulevard du Souverain 36, 1170 Brussels, Belgium, Tel: (32) 2 663 0600, Fax: (32) 2 663 0640
Asia Pacific: Rockwell Automation, Level 14, Core F, Cyberport 3, 100 Cyberport Road, Hong Kong, Tel: (852) 2887 4788, Fax: (852) 2508 1846

Publication 1734-IN058C-EN-P - October 2015

PN-331160

Supersedes Publication 1734-IN058B-EN-P - June 2005

Copyright © 2015 Rockwell Automation, Inc. All rights reserved. Printed in Singapore.