

# Liquidtight ST Series Plain Throat and STB Series Insulated Throat Connectors And External Grounding Lugs

For Liquidtight Flexible Metal Conduit

Suitable for use in Class I, Division 2

## Applications

- For use with liquidtight flexible metal conduit where an external, visible equipment bonding jumper is desired.

## Features

- ST-L Series has plain throat.
- STB-L Series has insulated throat to protect against wire damage.
- Unique long ferrule with more pronounced threads provides over four times UL pull-out requirements.
- Ferrule provides maximum surface contact for better sealing and a continuous, permanent, positive metal-to-metal ground.
- Adequately sized bonded lugs provide excellent grounding continuity and allow for visible ground path inspection.
- Liquidtight/raintight/oiltight.
- Suitable for outdoor use.
- Full, machined tapered threads (NPT).

## Standard Material/Finish

- 3/8" thru 1" straight: steel body and compression nut
- 1-1/4" thru 5" straight: malleable iron body and compression nut
- 3/8" thru 4" 45° and 90°: malleable iron body
- 3/8" thru 1" 45° and 90° caps: steel
- 1-1/4" thru 4" 45° and 90° caps: malleable iron
- 3/8" thru 1" ferrule: steel
- 1-1/4" thru 4" ferrule: aluminum
- Steel: zinc electroplate
- Malleable iron: zinc electroplate, chromate and epoxy powder/zinc electroplate

## Certifications and Compliances

- UL Standard: 467
- UL Listed: E6581
- CSA Standard: C22.2 No. 18.3
- CSA Certified: 065178
- NEMA: FB-1

## STD Conduit Thread Size

Flexible Conduit Size (Inches)	NPT Size
3/8	1/2
1/2	1/2
3/4	3/4
1	1
1-1/4	1-1/4
1-1/2	1-1/2
2	2
2-1/2	2-1/2
3	3
3-1/2	3-1/2
4	4
5	5

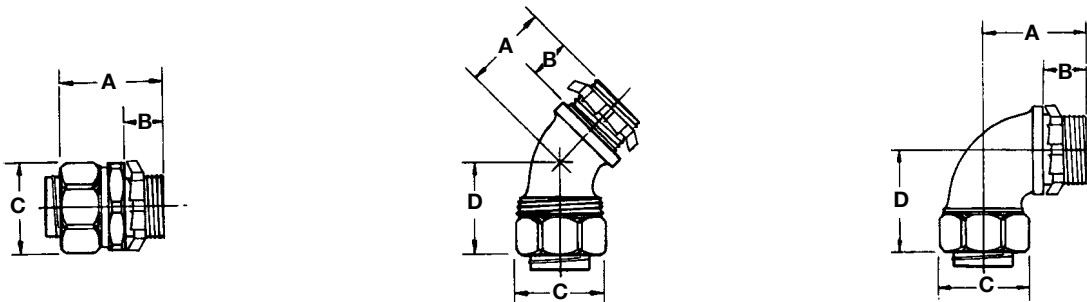

## Dimensions



# Liquidtight ST Series Connectors with Plain Throat and External Grounding Lugs

For Liquidtight Flexible Metal Conduit

Suitable for use in Class I, Division 2

	Catalog Number	Conduit Size (Inches)	Dimensions in Inches/Millimeters				Grounding Lugs Wire Size	Weight Lbs./Kgs. Per 100
			A	B	C	D		
<b>Straight</b>								
	ST-38L	3/8 flex, 1/2 hub	1.44/36.6	0.63/16.0	1.13/28.7	—	14-4	19.00/8.62
	ST-50L	1/2	1.44/36.6	0.63/16.0	1.25/31.8	—	14-4	18.00/8.16
	ST-75L	3/4	1.50/38.1	0.63/16.0	1.50/38.1	—	14-4	28.00/12.70
	ST-100L	1	1.63/41.4	0.75/19.1	1.81/45.9	—	14-4	40.00/18.14
	ST-125L	1-1/4	2.00/50.8	0.63/16.0	2.31/58.7	—	8-1/0	90.00/40.82
	ST-150L	1-1/2	2.25/57.2	0.63/16.0	2.63/66.8	—	8-1/0	126.00/57.15
	ST-200L	2	2.50/63.5	0.69/17.5	3.19/81.0	—	8-1/0	174.00/78.93
	ST-250L	2-1/2	3.38/85.9	1.06/26.9	3.94/100.1	—	1-4/0	359.00/162.84
	ST-300L	3	3.69/93.7	1.19/30.2	4.38/111.3	—	1-4/0	459.00/208.20
	ST-350L	3-1/2	3.69/93.7	1.19/30.2	5.00/127.0	—	1-4/0	534.00/242.22
ST-400L	4	4.00/101.6	1.25/31.8	5.50/139.7	—	1-4/0	677.00/307.08	
<b>45°</b>								
	ST-4538L	3/8 flex, 1/2 hub	0.88/22.4	0.63/16.0	1.13/28.7	1.13/28.7	14-4	22.00/9.98
	ST-4550L	1/2	0.88/22.4	0.63/16.0	1.25/31.8	1.13/28.7	14-4	22.00/9.98
	ST-4575L	3/4	1.13/28.7	0.63/16.0	1.50/38.1	1.25/31.8	14-4	38.00/17.24
	ST-45100L	1	1.38/35.1	0.75/19.1	1.81/45.9	1.81/45.9	14-4	52.00/23.59
	ST-45125L	1-1/4	1.63/41.4	0.63/16.0	2.31/58.7	1.81/45.9	8-1/0	109.00/49.44
	ST-45150L	1-1/2	1.81/45.9	0.63/16.0	2.63/66.8	2.13/54.1	8-1/0	171.00/77.56
	ST-45200L	2	2.00/50.8	0.69/17.5	3.19/81.0	2.38/60.5	8-1/0	254.00/115.21
	ST-45250L	2-1/2	3.56/90.4	1.06/26.9	3.94/100.1	5.00/127.0	1-4/0	269.00/122.02
	ST-45300L	3	4.31/109.5	1.19/30.2	4.38/111.3	5.81/147.6	1-4/0	971.00/440.44
	ST-45400L	4	4.63/117.6	1.25/31.8	5.50/139.7	4.00/101.6	1-4/0	1525.00/691.73
<b>90°</b>								
	ST-9038L	3/8 flex, 1/2 hub	1.25/31.8	0.63/16.0	1.13/28.7	1.50/38.1	14-4	26.00/11.79
	ST-9050L	1/2	1.25/31.8	0.63/16.0	1.25/31.8	1.50/38.1	14-4	26.00/11.79
	ST-9075L	3/4	1.44/36.6	0.63/16.0	1.50/38.1	1.56/39.6	14-4	45.00/20.41
	ST-90100L	1	1.38/35.1	0.75/19.1	1.81/45.9	1.88/47.8	14-4	68.00/30.84
	ST-90125L	1-1/4	1.81/45.9	0.63/16.0	2.31/58.7	2.38/60.5	8-1/0	120.00/54.43
	ST-90150L	1-1/2	2.44/61.9	0.63/16.0	2.63/66.8	3.19/81.0	8-1/0	201.00/91.17
	ST-90200L	2	2.63/66.8	0.69/17.5	3.19/81.0	3.56/90.4	8-1/0	299.00/135.62
	ST-90250L	2-1/2	7.19/182.6	1.06/26.9	3.94/100.1	8.44/214.4	1-4/0	1852.00/840.05
	ST-90300L	3	8.63/219.2	1.19/30.2	4.38/111.3	10.13/257.3	1-4/0	1109.00/503.03
	ST-90400L	4	11.25/285.8	1.25/31.8	5.50/139.7	12.81/325.4	1-4/0	2130.00/966.15



Commercial Products

COMMERCIAL PRODUCTS: LIQUIDTIGHT CONDUIT FITTINGS

# Liquidtight STB Series Connectors Insulated Throat and External Grounding Lugs

For Liquidtight Flexible Metal Conduit

Suitable for use in Class I, Division 2

Catalog Number	Conduit Size (Inches)	Dimensions in Inches/Millimeters				Grounding Lugs Wire Size	Weight Lbs./Kgs. Per 100	
		A	B	C	D			
<b>Straight</b>								
	STB-38L	3/8 flex, 1/2 hub	1.44/36.6	0.63/16.0	1.13/28.7	—	14-4	18.00/8.16
	STB-50L	1/2	1.44/36.6	0.63/16.0	1.25/31.8	—	14-4	19.00/8.62
	STB-75L	3/4	1.50/38.1	0.63/16.0	1.50/38.1	—	14-4	29.00/13.15
	STB-100L	1	1.63/41.4	0.75/19.1	1.81/45.9	—	14-4	40.00/18.14
	STB-125L	1-1/4	2.00/50.8	0.63/16.0	2.31/58.7	—	8-1/0	90.00/40.82
	STB-150L	1-1/2	2.25/57.2	0.63/16.0	2.63/66.8	—	8-1/0	125.00/56.70
	STB-200L	2	2.50/63.5	0.69/17.5	3.19/81.0	—	8-1/0	179.00/81.19
	STB-250L	2-1/2	3.38/85.9	1.06/26.9	3.94/100.1	—	1-4/0	349.00/158.30
	STB-300L	3	3.69/93.7	1.19/30.2	4.38/111.3	—	1-4/0	459.00/208.20
	STB-350L	3-1/2	3.69/93.7	1.19/30.2	5.00/127.0	—	1-4/0	539.00/244.49
	STB-400L	4	4.00/101.6	1.25/31.8	5.50/139.7	—	1-4/0	668.00/303.00
	<b>45°</b>							
	STB-4538L	3/8 flex, 1/2 hub	0.88/22.4	0.63/16.0	1.13/28.7	1.13/28.7	14-4	21.00/9.53
	STB-4550L	1/2	0.88/22.4	0.63/16.0	1.25/31.8	1.13/28.7	14-4	21.00/9.53
	STB-4575L	3/4	1.13/28.7	0.63/16.0	1.50/38.1	1.25/31.8	14-4	36.00/16.33
	STB-45100L	1	1.38/35.1	0.75/19.1	1.81/45.9	1.81/45.9	14-4	55.00/24.95
	STB-45125L	1-1/4	1.63/41.4	0.63/16.0	2.31/58.7	1.81/45.9	8-1/0	108.00/48.99
	STB-45150L	1-1/2	1.81/45.9	0.63/16.0	2.63/66.8	2.13/54.1	8-1/0	166.00/75.30
	STB-45200L	2	2.00/50.8	0.69/17.5	3.19/81.0	2.38/60.5	8-1/0	239.00/108.41
	STB-45250L	2-1/2	3.56/90.4	1.06/26.9	3.94/100.1	5.00/127.0	1-4/0	769.00/348.81
	STB-45300L	3	4.31/109.5	1.19/30.2	4.38/111.3	5.81/147.6	1-4/0	1009.00/457.67
	STB-45400L	4	4.63/117.6	1.25/31.8	5.50/139.7	4.00/101.6	1-4/0	1813.00/822.36
<b>90°</b>								
	STB-9038L	3/8 flex, 1/2 hub	1.25/31.8	0.63/16.0	1.13/28.7	1.50/38.1	14-4	26.00/11.79
	STB-9050L	1/2	1.25/31.8	0.63/16.0	1.25/31.8	1.50/38.1	14-4	27.00/12.25
	STB-9075L	3/4	1.44/36.6	0.63/16.0	1.50/38.1	1.56/39.6	14-4	44.00/19.96
	STB-90100L	1	1.38/35.1	0.75/19.1	1.81/45.9	1.88/47.8	14-4	64.00/29.03
	STB-90125L	1-1/4	1.81/45.9	0.63/16.0	2.31/58.7	2.38/60.5	8-1/0	122.00/55.34
	STB-90150L	1-1/2	2.44/61.9	0.63/16.0	2.63/66.8	3.19/81.0	8-1/0	198.00/89.81
	STB-90200L	2	2.63/66.8	0.69/17.5	3.19/81.0	3.56/90.4	8-1/0	291.00/132.00
	STB-90250L	2-1/2	7.19/182.6	1.06/26.9	3.94/100.1	8.44/214.4	1-4/0	849.00/385.10
	STB-90300L	3	8.63/219.2	1.19/30.2	4.38/111.3	10.13/257.3	1-4/0	1109.00/503.03
	STB-90400L	4	11.25/285.8	1.25/31.8	5.50/139.7	12.81/325.4	1-4/0	2163.00/981.12

Commercial Products

COMMERCIAL PRODUCTS: LIQUIDTIGHT CONDUIT FITTINGS