



[Catalog Home](#)

Product Datasheet

ANDERSON FARGO

WTH403 -- Bus Support, Aluminum Weldment



Bus Support, Aluminum Weldment, Open, Rigid or Slip Fit, 4 IPS/EHIPS Tube to Insulator, 3 in B.C.

Product Specifications

Family Image



Bus Supports

Bus Supports



WTH Series

Tube to Insulator, Open Clamp
Slip-Fit or Rigid Aluminum
Weldment Bus Supports

PDF Catalog Page

[Click HERE to view the web page.](#)

Bolt Circle Diameter

3

Mounting Hardware Material

Galvanized Steel

Dimension C

4.50 in (114.3 mm)

Dimension J

.50 in (12.7 mm)

Dimension K

.56 in X .75 in

Dimension L

9.13 in (231.78 mm)

Dimension W

6.5 in (165.1 mm)

Material Type

Non-Standard

UPC Code

09635934281

Standard Package

15

Standard Package Unit	Each
Min Order Qty	1
Weight / Ea.	3.822 lbs

Compressed Product Number

WTH403

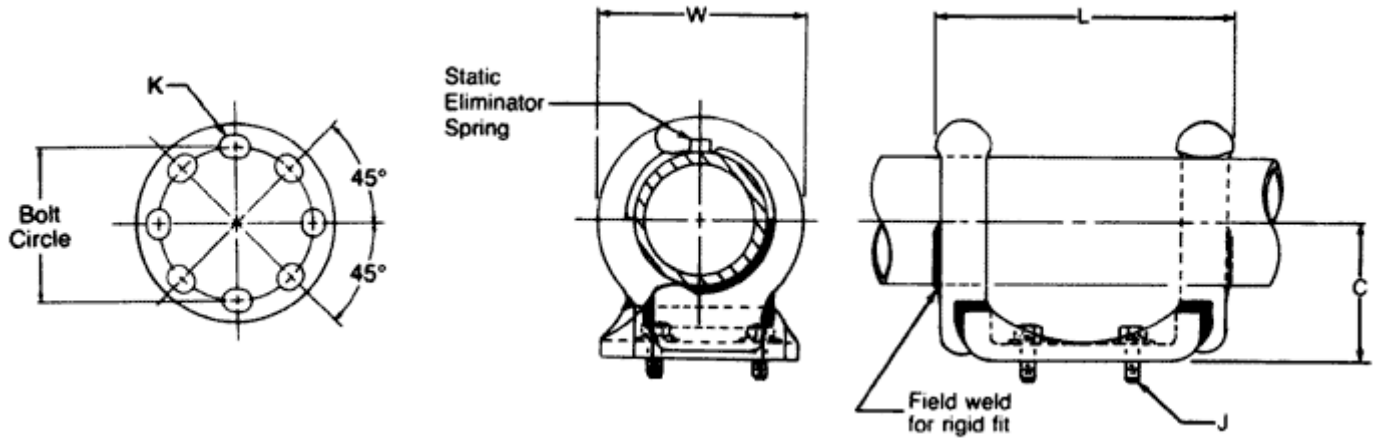

[Catalog Home](#)



[Warranty Info](#) | [Trademarks](#) | [Terms of Use](#)

All contents Copyright © 2007 Hubbell Power Systems, Inc. All rights reserved.

NOTE: Because Hubbell has a policy of continuous product improvement, we reserve the right to change design and specifications without notice.