

Straight Blade Devices
 20A, 125V, 2 Pole, 3 Wire Grounding
 Commercial Specification Grade Duplex
 Receptacles

HUBBELL

Features

- Easy access split circuit tab
- Fork terminal capable
- Finder Groove Face
- Triple wipe contacts

Ordering Information

Description	Device Color	UPC	Catalog Number
Finder groove, side wired only	Office White	783585107868	CRF20OW

Listings

UL Listed to UL498 File No. E2186
 Certified to CSA, C22.2, No. 42
 Fed. Spec. W-C-596
 NEMA® WD-6 Compliant

Specifications

Face	Nylon
Base	Nylon
Power Contacts	.030 in. (.8) Brass
Mounting Strap	.040 in. (1) Galvanized steel
Terminal Screws	Plated steel
Automatic Self-grounding Staple	Stainless steel
Mounting Screws	Galvanized steel

Performance

Electrical	
Current Interrupting	Certified for current interrupting at full rated current
Dielectric Voltage	Withstands 2,000V minimum
Mechanical	
Product Identification	Ratings are a permanent part of the device
Terminal Accommodation	#12-#10 AWG copper stranded or solid conductor only
Terminal Identification	Terminals identified in accordance with UL 498 and CSA
Environmental	
Flammability	UL 94 V-2
Operating Temperatures	Maximum continuous 75°C; minimum -40°C (w/o impact)

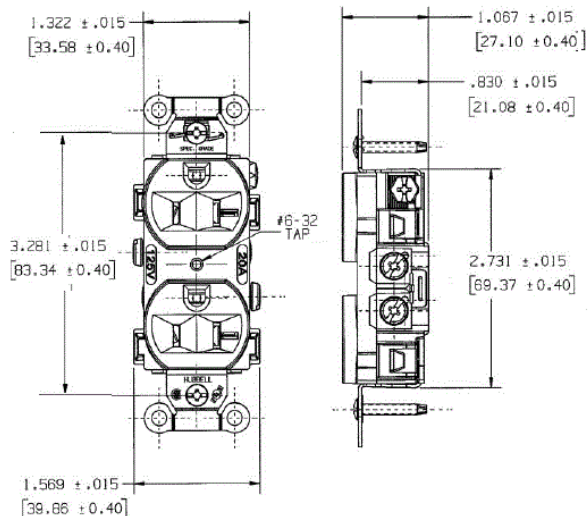

Accessories

Wallplate or Weatherproof Cover Duplex Opening

Resources

Customer Use Drawing
 eCatalog

Dimensions in Inches (mm)

Hubbell Wiring Device-Kellems • Hubbell Incorporated (Delaware) • 40 Waterview Drive • Shelton, CT 06484

Phone (800) 288-6000 • Fax (800) 255-1031 • Specifications subject to change without notice.

