



HALO[®]

RECESSED LIGHTING



SMART LIGHTING | HOUSINGS | TRIMS | LED MODULES



Table of Contents

	<ul style="list-style-type: none"> LED Product Overviews 1 Halo Recessed Housings 8 Halo Recessed Trims 16 Compliances & Listings 20 Lighting Properties 21 Lighting Effects 23 Light Sources 24
HALO Home	<ul style="list-style-type: none"> LED Modules 28 LED Outdoor 30 Smart Controls 32 Accessories 36
LED Recessed	<ul style="list-style-type: none"> LED Housings 40 LED Modules 54 Integrated LED 83
LED Direct & Surface Mount	<ul style="list-style-type: none"> Direct Mount 112 Surface Mount 126
3 INCH	<ul style="list-style-type: none"> H3 Series IC Housings 144 IC Trims 148 Non-IC Housings 152 Non-IC Trims 159
4 INCH	<ul style="list-style-type: none"> E44 LED Lamp Low Voltage Housings 166 Line Voltage Housings 168 Wafer Thin Trims 170 Full Overlap Trims 174 E26 Screw Base IC Housings & Trims 180 Non-IC Housings & Trims 185 Low Voltage IC Housings 193 Non-IC Housings 194 Trims 197
5 INCH	<ul style="list-style-type: none"> E26 Screw Base IC Housings 203 IC Trims 208 IC Housings – No Socket Bracket 217 IC Trims – No Socket Bracket 220 Non-IC Housings 230 Non-IC Trims 234 Non-IC Housings – No Socket Bracket .. 242 Non-IC Trims – No Socket Bracket 244
6 INCH	<ul style="list-style-type: none"> E26 Screw Base IC Housings 254 IC Trims 260 H7UICAT Housings & Trims 272 IC Housings – No Socket Bracket 285 IC Trims – No Socket Bracket 288 IC Shallow Housings 296 IC Shallow Trims 300 Non-IC Housings 310 Non-IC Trims 315 Non-IC Housings – No Socket Bracket .. 332 Non-IC Trims – No Socket Bracket 334 Non-IC Shallow Housings 342 Non-IC Shallow Trims 346 H47 Series Slope Housings & Trims 356 H645IC Slope Housings & Trims 360 Specialty Products & Accessories 362

HALO Recessed Lighting



Smart Lighting solutions for the whole home

HALO Home Collection

HALO Home is a flexible new approach to smart home lighting. Our system offers a range of Bluetooth fixtures, controls and accessories that work seamlessly together. From a single light to an entire home, your smart lighting search starts and ends here.

HALO Home app

Our user-friendly mobile app lets you control lighting from your fingertips, and from anywhere in the world (with the optional Smart Internet Access Bridge). Available for iOS and Android, it features dimming, adjustable white tuning, grouping, automatic scheduling and more.



Voice control compatible

Customize your home lighting with with anywhere in the world access and voice control. HALO Home is compatible with Amazon Alexa and Google Assistant products, when paired with the optional Smart Internet Access Bridge.



Flexible and scalable

HALO Home is a simple and flexible connected option, with the ability to install as little as one smart light or scale up to control the entire home through the easy-to-use HALO Home app.

Adjustable white tuning

Select the perfect color for your mood and beautifully complement your home. The HALO Home smart lighting fixtures provide the ability to adjust color temperatures from 2700K (warm white) to 5000K (daylight).

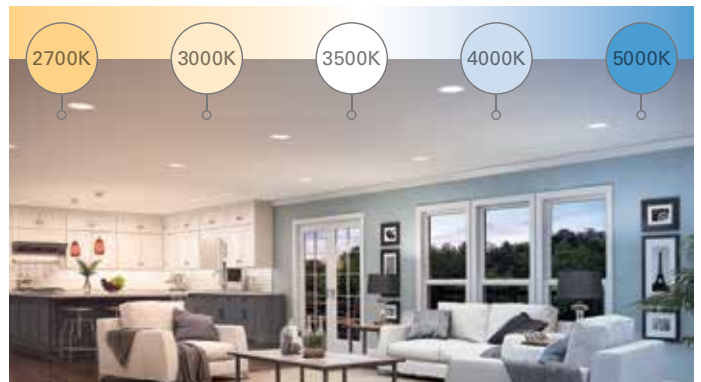

Halo Recessed Lighting

LED Products

ML56 Collection

Halo ML56 LED downlight collection is comprised of LED modules with 5" and 6" trims. ML56 LED modules are offered in three lumen packages across the 600, 900, and 1200 Series - a versatile collection of energy-efficient LED downlights for general lighting in commercial and residential applications. The ML56 LED 600, 900, 1200 Series modules are designed for either new construction or retrofitting existing 5" and 6" compatible housings (Edison screw base adapter included). Halo LED ML56 Collection features excellent color in 90 CRI (90 CRI is $R9 > 50$), and offers a wide selection of color temperatures (2700K, 3000K, 3500K and 4000K). Halo LED is ENERGY STAR® certified and can be used for California Title 24 and IECC High Efficacy compliance with designated LED modules and LED trims.



ML4 Collection

The ML4 system is comprised of a housing, LED module, and round or square 2-inch aperture pinhole trims. This compact assembly installs from below the ceiling in standard 4-inch line voltage housings suitable for 2x6 residential framing or shallow plenum commercial construction.

For even tighter spacing an ultra-shallow install from below housing is available and is suitable for 2x4 framing. For ceiling types that make recessed lighting difficult, like concrete pour, round and surface cylinders support direct attachment to finished ceiling surfaces.

Although diminutive in size the up to 1200 lumen series ML4 delivers powerful beams of light providing the optical control and color quality typically associated with low voltage tungsten-halogen MR16 lamps. Delivered center beam candlepower (CBCP) of ML4 LED exceeds 50W low voltage MR16 lamps with significantly higher candela per watt (Cd/W).



Halo Recessed Lighting

LED Products

RL Collection

Halo RL series is a complete 4" and 5"/6" LED baffle-trim module for recessed downlights. The RL series is designed for use in new construction, remodel and retrofit installation in Halo and other compatible 4", 5" and 6" recessed downlight housings. The integral LED driver offers 120 volt dimming capability. RL4 is offered in 600 lumen, and 600 and 900 lumens on the field selectable. RL56 is offered in 600, 900 and 1200 lumen series. RL is ENERGY STAR® certified and can be used for California Title 24 (Title 20 Certified for residential compliance), and IECC High Efficacy compliance with designated LED modules and LED trims. RL models in 90 CRI (90 CRI is R9 > 50), are offered in 2700K, 3000K, 3500K, 4000K and 5000K or field selectable color temperature models. Optional accessories include designer trims in white (paintable), satin nickel, and tuscan bronze.



RA Collection

Halo RA LED is a complete 4" and 5"/6" adjustable gimbal LED module; suitable for new construction, remodel and retrofit installation in Halo and other compatible 4", 5" and 6" recessed downlight housings. The RA adjustable gimbal offers 35-degree tilt and up to 360-degree rotation. The integral LED driver offers 120 volt dimming capability. RA4 and RA56 is ENERGY STAR® certified and can be used for California Title 24 (Title 20 Certified for residential compliance), and IECC High Efficacy compliance with designated LED modules and LED trims. The RA4 and RA56 adjustable gimbals are offered with 90 CRI (R9 > 50), in 2700K and 3000K or field selectable color temperature models; and with beam spread options in Very Wide Flood (VWFL) and Narrow Flood (NFL) models.



Halo Recessed Lighting

LED Products

HL6 AllSlope Collection

Featuring unique interchangeable beam-forming optics, full range dimming and multiple color temperatures and trim options, the Halo HL6 AllSlope LED 6" downlight system is specifically designed for slope ceiling applications with pitch aiming from 2/12 (10 degrees) to 12/12 (45 degrees). The innovative design allows the LED light engine full adjustment capability so it can be aimed straight down in accordance with the ceiling pitch, resulting in outstanding performance and appearance. The three piece system consists of a 6-inch aperture housing, available in 1200 lumen series or 1800 lumen series; LED light engines are offered with 90 CRI (R9 > 50), in 2700K, 3000K, 3500K, 4000K; and available with three interchangeable optics. The trim selection is from a full line of slope ceiling trims including reflectors, baffles and lens choices. AllSlope is ENERGY STAR® certified and can be used for California Title 24 (Title 20 Certified for residential compliance), and IECC High Efficacy compliance with designated LED modules and LED trims.

The high-efficiency, energy-saving solution provides up to 73% in energy savings with virtually no maintenance.



SLD Collection

Halo Surface LED downlight (SLD) incorporates WaveStream™ technology to create an ultra-low profile 4" and 6" surface mounting luminaire with the performance and look of a traditional downlight. SLD is designed for installation in many square, octagon, or round junction boxes. Supply wire adapter with LED quick wiring connector included. Suitable for residential or commercial installations. Ideal for closets, storage areas, attics and basements. When used in 4", 5" and 6" recessed downlights, the included retrofit kit's dedicated LED wiring connector meets high efficacy code requirements. The SLD is ENERGY STAR® certified and can be used for California Title 24, and IECC High Efficacy compliance with designated products. SLD is available in SLD4, SLD6-600 lumen series and SLD6-1200 lumen series. SLD models in 90 CRI (90CRI is R9 > 50), are offered in 2700K, 3000K, 3500K, 4000K. Optional accessories include designer trims in white (paintable), satin nickel, and tuscan bronze.



Halo Recessed Lighting

LED Products

MicroEdge™ - HLB/HLA Collection

The MicroEdge series is made up of the HLB ultra-thin LED lens downlight and HLA adjustable. Both are powered by a remote driver / junction box ideal for new construction and renovation work. Simplified installation in drywall or suspended ceilings eliminates recessed cans saving time and money. Both the HLB and HLA can install from below the ceiling in as little as a 1-1/2" plenum height and can be used in direct contact with insulation and is airtight. Distribution patterns work well in low to medium ceiling heights, applications are virtually universal including living and dining areas, bedrooms, closets, hallways, bathrooms, kitchens, basements, soffits, entryways and porches.



HL3 Collection

Halo now offers a complete family of 3-inch LED recessed downlights ideal for your next demanding project. Choose from round or square apertures available in broad range of trim styles and optical distributions meeting demanding architectural factors including ceiling height, square footage and fixture spacing criteria.

Trims are available in a range of finishes to match many décors. Magnets pulls trims tight to the ceiling eliminating gaps and light leaks. Trims may be installed rimless with a true knife-edge interface creating a quiet ceiling appearance. Symmetrical trims can be used for both general area and accent lighting creating a consistent visual appearance.

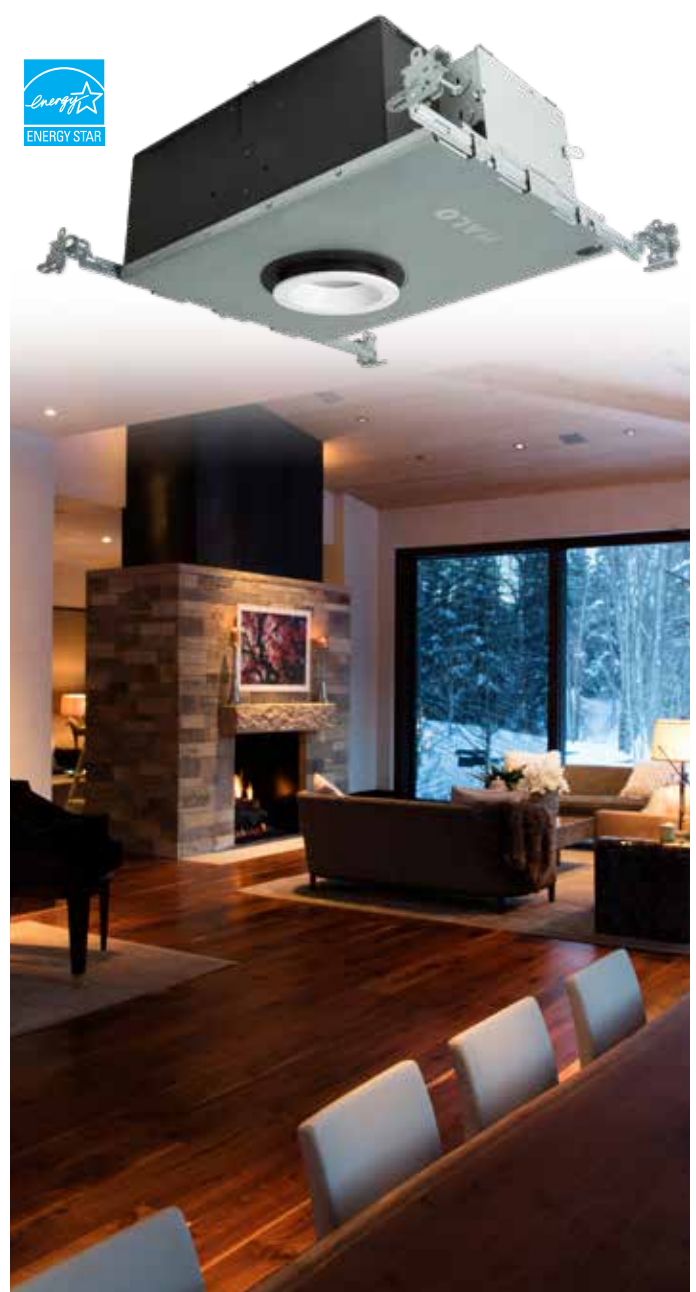

Halo Recessed Lighting

LED Products

E44 Collection

A family of 4-inch housings and trims optimized for use with LED lamps delivering longer life and energy savings. The ultra-shallow housings are available in new construction and remodel types suitable for 2x4 framing or shallow plenum installation. The compact plaster frame with repositionable junction box fits in tight spacing.

The line voltage housings with GU10 base are available in 10 or 20 watt ratings and can be used with LED or halogen lamp types. The low voltage housings with Gx5.3 base and integral 120/277V step down transformer is rated at 10 watts maximum, ideal for use with LED MR16 lamps.

Trims are also optimized for use with LED lamps and are available in round and square apertures in a range of finishes to match many decors. The E44 round and square pinhole trims match the appearance of the ML4 series allowing lamp and light engine based solutions to be combined while maintaining a consistent look.



SMD Collection

The Halo Surface Mount LED Downlight (SMD) is an ultra-low profile surface mounting luminaire with a modern look and high performance. SMD4 (4") and SMD6 (6") are designed for installation in recessed housings and many 3-1/2" and 4" square, octagon, or round junction boxes. Supply wire adapter with LED quick wiring connector included. Suitable for residential or commercial installations. Ideal for closets, storage areas, attics and basements. The SMD4 and SMD6 may also retrofit in a 4" or 5" and 6" aperture IC and Non-IC recessed housings. Dedicated LED wiring connector meets high efficacy code requirement when used in recessed downlighting. Suitable for use in clothes closets when installed with NEC® 410.16 spacing requirements. The SMD series offers modern and elegant stylings with exceptional value.

The SMD4 and SMD6 series also offers a direct mount (DM) version which can be installed directly into the ceiling with no additional junction box or housing required. Utilizing the integral Halo enclosure, this version of the SMD provides a quick installation and flush finish with the ceiling.





Halo Recessed Lighting

SeleCCTable Products



2700K

3000K

3500K

4000K

5000K



RL4/RL56
LED Baffle Trim
2700K - 5000K



RL4-DM / RL6-DM
LED Direct Mount
2700K - 5000K



RA4/RA56
LED Gimbal Module
2700K - 5000K



HLB4 / HLB6
LED Direct Mount
2700K - 5000K



HLBS4 / HLBS6
LED Direct Mount
2700K - 5000K



RSQ4 / RSQ5 / RSQ6
LED Square
2700K - 5000K



BLD4 / BLD6
LED Surface Mount
2700K - 5000K



CLD
LED Surface Mount
3000K, 4000K, 5000K



Halo Recessed Lighting

Types of Housings

Insulated Ceiling (IC)



Insulated Ceiling type (IC) rated luminaires are tested to UL 1598 standards for installation with blown-in or batting-type dry insulation materials. This allows the insulation layer to remain unbroken and prevent heating and air conditioning losses. These housings are also equipped with thermal protectors to guard against overlampping by cycling the lamp off and on until the problem is corrected.

The blown-in or batting-type dry insulation allows convective heat transfer away from the recessed light fixture, and allows direct access to the luminaire for inspection and servicing. Type IC luminaires are not for use in direct contact with spray-in foam insulation. Spray-in foams should be kept 3" from all sides of recessed luminaires. Alternate installation when spray-in foam is used, might include but not be limited to, wrapping the luminaire in fiberglass batting to maintain energy efficiency while preserving access to the luminaire. Refer to National Electrical Manufacturing Association document: NEMA LSD57-2013, "Polyurethane Foam Application: Lighting Equipment."

Air-Tite™ (AT)



- Air-Tite fixtures are designed to reduce airflow between heated or air conditioned spaces and unconditioned areas
- Standard recessed housings may allow up to 5.0 cubic ft. per minute of air leakage to escape into unconditioned spaces
- Air-Tite fixtures reduce this leakage by sealing air pathways
- Air-Tite fixtures may be IC for use in insulated ceilings or they may be Non-IC for non-insulated ceilings
- When an IC housing is Air-Tite that combination meets California Title 24 residential compliance
- Other state energy building codes now have restricted airflow requirements for recessed lighting fixtures
- Air-Tite fixtures are test certified to the American Society for testing and materials procedure ASTM E283 as having an air leakage rate not more than 2.0 cfm (0.944 L/s) when tested at a 1.57 psf (75 Pa) pressure differential
- Additional benefits include: Savings in HVAC bills, preventing moisture damage to attic areas, reduced sound transmission between floors, and eliminating drafts for greater comfort

"T" Housing – Non-Insulated Ceiling (Non-IC)



Type (T) thermally protected housings (Non-IC) are designed for use in non-insulated ceilings. When installed in a ceiling with insulation, the insulation must be kept 3" from all sides of the unit and there must be a least 1/2" clearance from the top of the fixture to any ceiling material. The integral thermal protector or insulation detector on Halo recessed fixtures provides positive protection against misuse of ceiling insulation and overlampping by cycling the lamp on and off until the problem is corrected. Halo fixtures with ballasts or drivers are thermally protected in the unit. To meet specific municipal standards, many fixtures in this category carry an "IP" rating.

Halo Recessed Lighting

Types of Housings

Small Aperture - 3" and 4"



Small aperture 3" and 4" housings are well suited for task and accent lighting especially over counters and in display areas. And 4" housings are increasingly used for general lighting with a trim providing for wide beam distribution, in conjunction with an appropriate lighting layout. Small aperture housings are available in Insulated Ceiling (IC), Non-Insulated Ceiling (T) / (Non-IC), and Air-Tite (AT) models.

Remodel



Remodel housings simplify installation when fixtures need to be added to existing ceilings. They can be installed from below in existing ceilings by cutting a precise hole, bringing power to the fixture and installing the housing. The spring clips or speed clamps lock the fixture in place. The integral thermal protector provides positive protection against overlampping. Housings are available in Insulated Ceiling (IC), Non-Insulated Ceiling (Non-IC), Air-Tite (AT) and shallow models.

Shallow Housing



Shallow housings are designed to solve installation problems where lower joist construction is used in the ceiling. These housings accept a wide variety of trims for different lighting effects. Shallow housings are available in Insulated Ceiling (IC), Non-Insulated Ceiling (T) / (Non-IC), and Air-Tite (AT) models.

Slope Ceiling



Slope or "cathedral" type ceilings require special housings to keep the lamp aimed straight down rather than following the slope of the ceiling. A lamp aiming mechanism in these fixtures allows the lamp to be aimed vertically in sloped ceilings. Ceiling pitch is measured from 2/12 to 12/12 (the first number refers to the amount of "drop" per 12 inches of horizontal measurement).

A built-in slope indicator provides quick and consistent lamp settings (factory set for 3/12 slope). Halo offers slope ceiling fixtures for incandescent lamps and for LED the HL6 AllSlope series. Slope ceiling housings are available in Insulated Ceiling (IC), Non-Insulated Ceiling (T) / (Non-IC), and Air-Tite (AT) models.

Halo Recessed Lighting

H3 (3"), H99/H1499 & H4 (4") Housing Installation Features

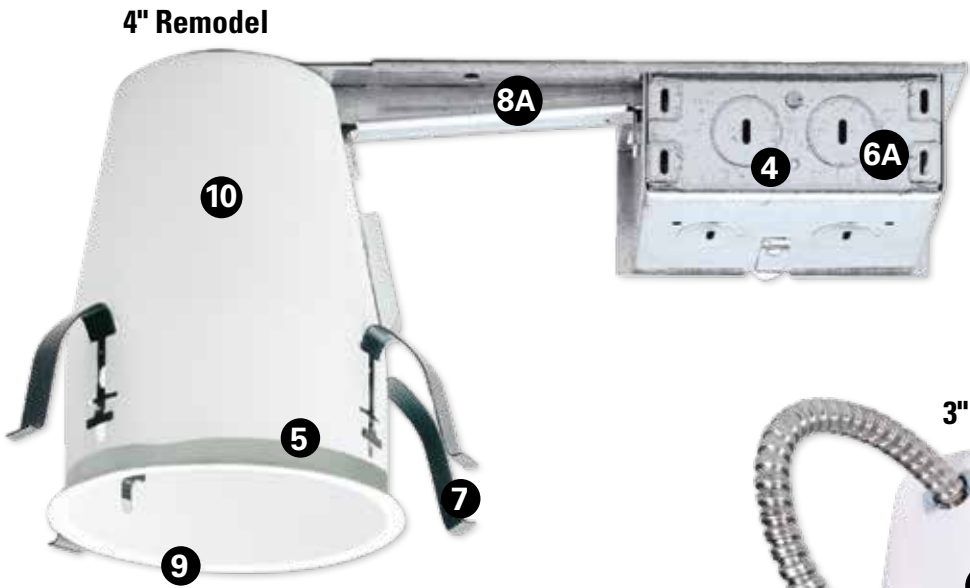
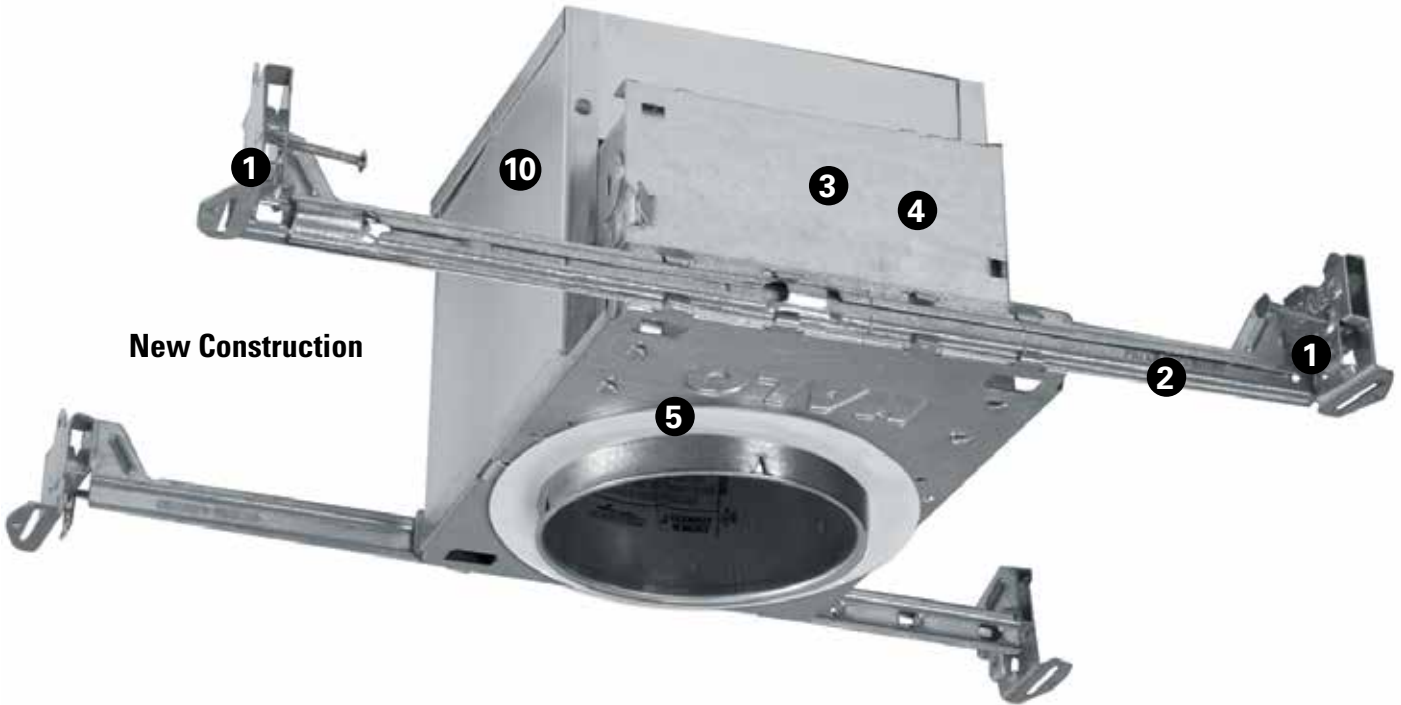

Halo Recessed Lighting

H3 (3"), H99/H1499 & H4 (4") Housing Installation Features

1 Patented Got Nail!™ Hanger Bracket

- Pre-installed nail easily installs in regular lumber, engineered lumber and laminated beams
- Safety and guidance system prevents nail snagging, ensures smooth straight nail penetration and allows bar hangers to be easily removed if necessary
- Automatic levelling flange aligns the housing and lets you hold the housing in place with one hand while driving nails
- Five additional mounting points
- Mounting point on top for hanger wire connection
- Integral T-bar clips snaps onto T-bars - no additional clips required



2 Patented Pass-N-Thru™ Bars

- Pass-N-Thru™ allows the bars to pass through each other for tool-less shortening in tight spots less than 12" without removing from the plaster frame. Push bars together and flex at score lines until excess can be removed
- Housing positions at any point within 24" joist span
- Bar hangers may be repositioned 90° on the frame on select housings
- (1) Locking screw and multiple crimp points on plaster frame secure bars in place



3 Patented Slide-N-Side™ Junction Box

- (3) Slide-N-Side™ wire traps allow non-metallic (NM) sheathed cable to be installed without tools or without removing knockouts
 - Allows wiring connections to be made outside the junction box
 - Simply insert the cable directly into the trap after connections are made
 - Accommodates the following standard non-metallic (NM) sheathed cable types for both U.S. and Canada:
(US) #14/2, #14/3, #12/2, #12/3
(Canada) #14/2, #14/3, #12/2
- (7) 1/2" conduit pry-outs positioned to accommodate straight conduit runs [(4) 1/2" conduit pry-outs in Non-IC housing]
- cULus Listed 24 in³ box volume, listed for through-branch (8) No. 12 AWG branch circuit 90° C conductors through the box



4 Quick Connect™ Push Wire Nuts

- (3) 4-Port push-in wire nuts included
- Speeds installation and increases reliability
- Simply strip and insert supply wires
- No additional wire nuts required



5 Air-Tite™ Code Compliant

- H3 & H4 Housings feature a pre-installed gasket in an Air-Tite housing that limits airflow between unconditioned areas and conditioned spaces
- Standard recessed housings may allow up to 5.0 cubic ft. per minute of air leakage into unconditioned spaces
- Air-Tite fixtures are test certified to the American Society for Testing and Materials procedure ASTM E283 as having an air leakage rate not more than 2.0 cfm (0.944 L/s) when tested at a 1.57 psf (75 Pa) pressure differential
- Meets building energy codes that require a gasket between the housing and ceiling
- Additional benefits include: Savings in HVAC bills, preventing moisture damage to attic areas, reduced sound transmission between floors, and eliminating drafts for greater comfort



Remodel Junction Boxes*

6A H99/H1499 Series

- (7) 1/2" conduit (flex) pry-outs
- (4) Non-metallic (NM) cable pryouts
- Allow metallic and non-metallic sheathed cable to be installed
- cULus Listed 12 in³ box volume, listed for (4) No. 12 AWG through branch circuit 90° C conductors

H3 Series

- (3) 1/2" conduit (flex) pry-outs
- cULus Listed 9.6 in³ box volume, listed for (4) No. 12 AWG through branch circuit 90° C conductors
- (3) Slide-N-Side™ wire traps allow non-metallic (NM) sheathed cable to be installed without tools or without removing knockouts.

H4 Series

LED remodels - See bullet 3

7 Remodel Springs

- (4) Remodel spring clips secure housing to finished ceiling
- Allow installation in standard 1/2" and 5/8" ceiling material

8A Remodel Single-Arm Design

H99/H1499 Series

- Single arm design allows box to pass through the ceiling aperture

8B H3 Series

- "Boat-shaped" remodel plate passes through the ceiling aperture to sit flat on ceiling
- Inner can passes through remodel plate and is secured with tab locks

9 Remodel Flange

- Integral flange secures fixture against the ceiling

10 cULus Listed

- UL1598 Luminaires
- Designed and manufactured to Underwriters Laboratories Standard for Safety - UL1598
- Luminaires additionally comply with National Electric Code (NEC), NFPA70



Halo Recessed Lighting

Halo H5 (5") & H7 (6") Housing Installation Features

H5 & H7 Housings

- Robust, full-frame construction
- Integral thermal protector guards against over-lamping
- Plaster lip notched at 90° intervals for laser centering
- Halo assured – logo on frame

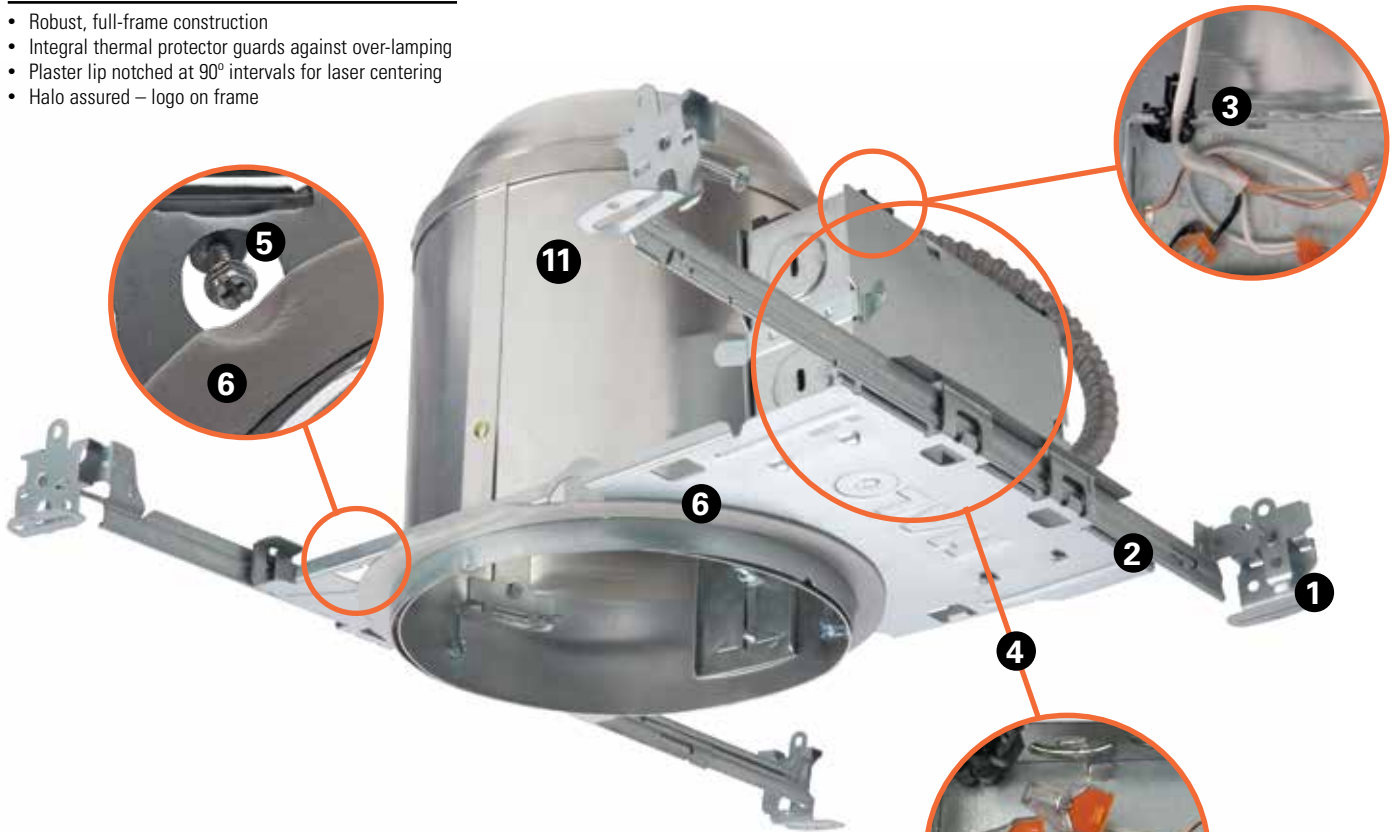

H5 & H7 Remodel Housings

- Install from below the finished ceiling aperture
- Robust construction
- Integral thermal protector guards against over-lamping
- Halo assured – logo on can top

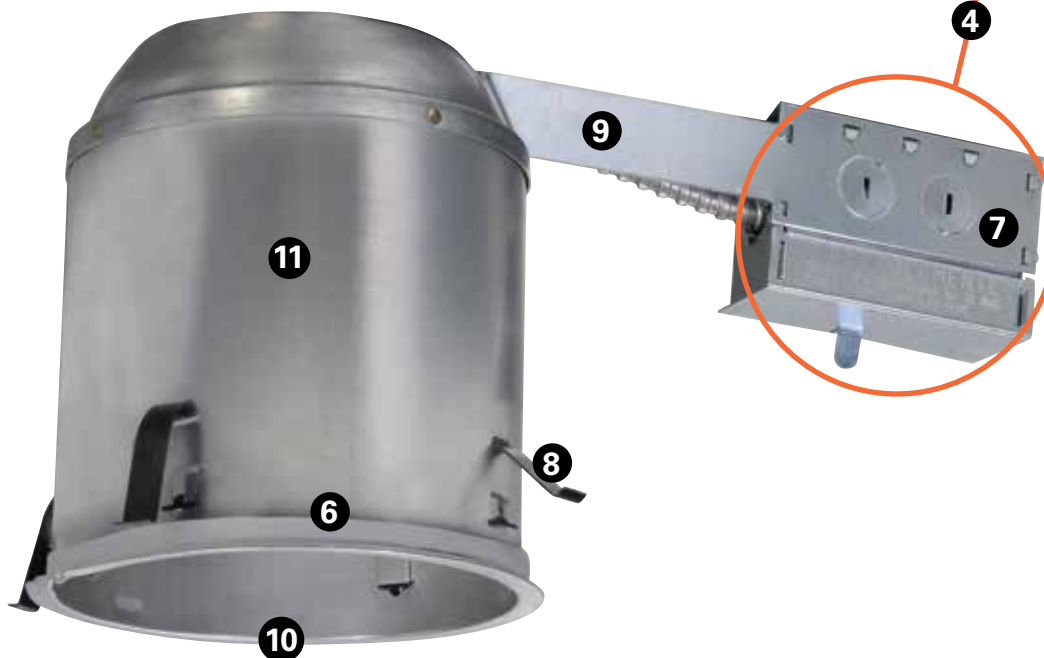

Halo Recessed Lighting

H5 (5") & H7 (6") Housing Installation Features

1 Patented Got Nail!™ Hanger Bracket

- Pre-installed nail easily installs in regular lumber, engineered lumber and laminated beams
- Safety and guidance system prevents nail snagging, ensures smooth straight nail penetration and allows bar hangers to be easily removed if necessary
- Automatic levelling flange aligns the housing and lets you hold the housing in place with one hand while driving nails
- Five additional mounting points
- Mounting point on top for hanger wire connection
- Integral T-bar clips snaps onto T-bars - no additional clips required



2 Patented q-Channel Bars with Pass-N-Thru™

- q-Channel bars feature a unique inverted "q" interlocking channel for rigidity and stability
- Pass-N-Thru™ allows the bars to pass through each other for tool-less shortening in tight spots less than 12" without removing from the plaster frame. Push bars together and flex at score hole break points
- Housing positions at any point within 24" joist span
- Bar hangers may be repositioned 90° on the frame on select housings



3 Patented Slide-N-Side™ Junction Box

- Full-size junction box
- (3) Slide-N-Side™ wire traps allow non-metallic (NM) sheathed cable to be installed without tools or without removing knockouts
 - Allows wiring connections to be made outside the junction box
 - Simply insert the cable directly into the trap after connections are made
 - Accommodates the following standard non-metallic (NM) sheathed cable types for both U.S. and Canada:
(US) #14/2, #14/3, #12/2, #12/3
(Canada) #14/2, #14/3, #12/2
- (7) 1/2" conduit pry-outs accommodate straight conduit runs
- cULus Listed 26 in³ box volume, listed for through-branch (8) No. 12 AWG branch circuit 90° C conductors through the box



4 Quick Connect™ Push Wire Nuts

- (3) 4-Port push-in wire nuts included
- Speeds installation and increases reliability
- Simply strip and insert supply wires
- No additional wire nuts required



5 Universal Locking Screw

- (1) Locking screws accessible from below the ceiling
- Universal screw head (hex, slot or Phillips)
- (6) Additional bar crimping points

6 Air-Tite™ Code Compliant

- H5 & H7 housings feature a pre-installed gasket in an Air-Tite housing that limits airflow between unconditioned areas and conditioned spaces
- Standard recessed housings may allow up to 5.0 cubic ft. per minute of air leakage into unconditioned spaces
- Air-Tite fixtures are test certified to the American Society for Testing and Materials procedure ASTM E283 as having an air leakage rate not more than 2.0 cfm (0.944 L/s) when tested at a 1.57 psf (75 Pa) pressure differential
- Meets codes that require a gasket between a recessed housing and ceiling. Additional benefits include: Savings in HVAC bills, preventing moisture damage to attic areas, reduced sound transmission between floors, and eliminating drafts for greater comfort.
- Gasket GA-ATH5-6PK and GA-ATH7-6PK are available for covering gaps on the finished ceiling aperture (See specialty products and accessories section)



7 Remodel Junction Box - Full Access

- Full-size remodel junction box
- (7) 1/2" conduit (flex) pry-outs
- (4) Non-Metallic (NM) cable pryouts
- Allow metallic and non-metallic sheathed cable to be installed
- cULus Listed 17 in³ box volume, listed for (4) No. 12 AWG through branch circuit 90° C conductors

8 Remodel Springs

- (4) Remodel spring clips secure housing to finished ceiling
- Allow installation in standard 1/2" and 5/8" ceiling material

9 Remodel Single-Arm Design

- Single arm design allows box to pass through the ceiling aperture
- Flexible arm can bend or flex side-to-side around obstructions

10 Remodel Flange

- Integral flange secures fixture against the ceiling

11 cULus Listed

- UL 1598 Luminaires
- Designed and manufactured to Underwriters Laboratories Standard for Safety – UL 1598
- Luminaires additionally comply with National Electric Code (NEC), NFPA70



Halo Recessed Lighting

E5 (5") & E7 (6") Housing Installation Features

E5 & E7 Housings

- Compact and economical construction
- Integral thermal protector guards against over-lamping
- Plaster lip notched at 90° intervals for laser centering
- Halo assured – logo on junction box can top and q-Channel bars



E5 & E7 Remodel Housings

- Install from below the finished ceiling aperture
- Compact junction box designed for ease of installation
- (2) Speed clamps securely lock housing to ceiling
- Integral thermal protector guards against over-lamping
- Halo assured – logo on junction box and can top



Halo Recessed Lighting

E5 (5") & E7 (6") Housing Installation Features

1 Patented All-Nail™ Hanger Bracket

- Pre-installed nail easily installs in regular lumber, engineered lumber and laminated beams
- Mini foot levelling flange aligns the housing to the bottom of the joist
- Integral T-bar clip snaps on to T-bars - no additional clips are required
- Additional screw points provided for securing to grid where required by code



2 Patented q-Channel Bars with Pass-N-Thru™

- q-Channel bars feature a unique inverted "q" interlocking channel for rigidity and stability
- Housing positions at any point within 24" joist span
- Pass-N-Thru™ allows the bars to pass through each other for tool-less shortening in tight spots less than 12" without removing from the plaster frame. Push bars together and flex at score hole break points
- Bar hangers need not be removed from frame for shortening



3 Patented Repositionable J-Box with Slide-N-Side™

- Hinged and captive door for easy access
- Repositionable J-box can be moved to alternate side of frame to avoid obstructions
- (4) Slide-N-Side™ wire traps allow non-metallic (NM) sheathed cable to be installed without tools or removing knockouts
 - Allows wiring connections to be made outside the junction box
 - Simply insert the cable directly into the trap after connections are made
 - Accommodates the following standard non-metallic (NM) sheathed cable types for both U.S. and Canada:
(US) #14/2, #14/3, #12/2, #12/3
(Canada) #14/2, #14/3, #12/2
- (4) 1/2" conduit pry-outs
- cULus Listed Compact 16 in³ box volume, listed for maximum (10) No. 12 AWG or (14) No. 14 AWG 90° C splice conductors in box

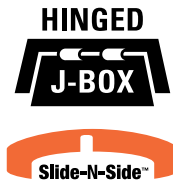

4A Quick Connect™ Push Wire Nuts

- (3) 4-Port push-in wire nuts included
- Speeds installation and increases reliability
- Simply strip and insert supply wires
- No additional wire nuts required



4B Patent Pending Quick Connect™ Remodel Wiring Tray

- (3) 4-Port push-in wire nuts included
- Captive tray holds color-coded push-nuts in place allowing for one-handed connections to line, neutral & ground
- Speeds installation and increases reliability
- Simply strip and insert supply wires
- No additional wire nuts required



5 Universal Locking Screw

- (2) Locking screws accessible from below the ceiling
- Universal screw head (hex, slot or Phillips)

6 Patent Pending Air-Tite™ Construction

- E5 & E7 feature a gasket seal between the housing aperture, frame, & ceiling in a special design that limits airflow between unconditioned areas and conditioned spaces for a true Air-Tite installation without additional gaskets or caulk
- Standard recessed housings may allow up to 5.0 cubic ft. per minute of air leakage into unconditioned spaces
- Air-Tite fixtures are test certified to the American Society for Testing and Materials procedure ASTM E283 as having an air leakage rate not more than 2.0 cfm (0.944 L/s) when tested at a 1.57 psf (75 Pa) pressure differential
- Meets codes that require a gasket between a recessed housing and ceiling
- Additional benefits include: Savings in HVAC bills, preventing moisture damage to attic areas, reduced sound transmission between floors, and eliminating drafts for greater comfort



7 Patent Pending Remodel J-Box with Slide-N-Side™

- Compact design for ease in remodel installation
- Hinged and captive door for easy access
- (2) Slide-N-Side™ wire traps allow non-metallic (NM) sheathed cable to be installed without tools or removing knockouts
 - Allows wiring connections to be made outside the junction box
 - Simply slide the cable into the trap after connections are made
 - Accommodates the following standard non-metallic (NM) sheathed cable types for both U.S. and Canada:
(US) #14/2, #14/3, #12/2, #12/3
(Canada) #14/2, #14/3, #12/2
- (3) 1/2" conduit pry-outs
- cULus Listed Compact 10 in³ box volume, listed for maximum (6) No. 12 AWG or (8) No. 14 AWG 90° C splice conductors in box

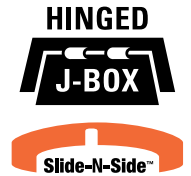

8 Patented Remodel Speed Clamps

- (2) Exclusive integral speed clamps securely lock housing to ceiling
- Locking tabs securely lock to ceiling and can be easily repositioned
- Tabs engage and tighten with internal drive screws – a low torque power screwdriver speeds installation
- Two-tier tabs adjust for 3/8" to 2" for various ceiling materials

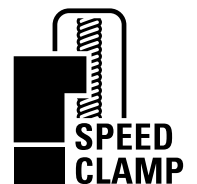

9 Remodel Attached - Box Design

- Attached box gets into tight spaces
- Allows ease of installation passing through the ceiling aperture

10 Remodel Flange

- Die formed flange maintains precise concentricity
- Integral flange secures fixture against the ceiling

11 cULus Listed

- UL1598 Luminaires
- Designed and manufactured to Underwriters Laboratories Standard for Safety – UL 1598
- Luminaires additionally comply with National Electric Code (NEC), NFPA70



Halo Recessed Lighting

Types of Trims

Halo's 3", 4", 5", 6" apertures offer full vocabulary of trim styles, finishes and design features. Smaller 3" and 4" trims are used for task and accent lighting, and many 4" trims with a wide beam are used for general downlighting. Larger 5" and 6" trims are used for general downlighting as many offer a wide beam for even illumination. Halo trims may be used with a wide variety of light sources including Incandescent, Halogen, CFL, and LED.

Full Reflectors

Reflector trims create wide light patterns and maximize the efficiency of the light source. Haze reflectors reduce glare yet maximize light distribution, satin nickel and gold finished reflectors add warmth and tuscan bronze and black reflectors minimize glare.



Reflector Cones

Reflector cones are generally shorter and are designed for use with reflector style lamps (R, BR, MR, GU10, and PAR). They direct the full output of these lamps to the illumination task.



Baffles

Baffle trims trap and shape light to minimize aperture glare and reduce ceiling brightness; varied depending on baffle finish. Baffles narrow the focus of the downlighting beam and many are used with reflector lamps (R, BR, MR, GU10, and PAR lamps).



Eyeballs/Gimbals/Adjustables

These trims provide precise, variable directional lighting. They are especially useful for directing light to accent wall hangings, mantels and task areas. Directional reflector style lamps are typically used (R, BR, MR, GU10 and PAR).



Wall Washers

Wall Wash trims provide same vertical surface illumination. Special reflectors allow both wall washing and downlighting. Depending on the light source and fixture positioning along a wall, these trims will provide same illumination higher up on the wall.



Lens and Diffusers

Lenses and diffusers are designed to typically soften and direct the light, and depending upon the lens the light may be directed more to horizontal surfaces or to higher angles on vertical surfaces. Designated trims can be used as shower lights and have cULus wet location listing.



Open Trims

Open trims create an attractive finished look of the lamp face without compromising the natural efficiency of reflector style lamps (R, BR and PAR).



Halo Recessed Lighting

Sizes & Finishes of Trims

Halo gives you the tools to create the exact interior environment you envision. Choose from Halo trims that range in size of 3", 4", 5" and 6". Selections round out the choices available for residential and light commercial applications.

Reflector Finishes

Reflectors are offered in several finishes for high efficiency, to soften illumination, or to make a defined decorating statement.



Baffles

Available in either black for the most effective shielding or white for an inconspicuous daytime appearance.



Trim Ring Finishes

Trim rings are offered in a wide choice of painted or metallic finishes to either blend in with an existing decor or to make a well defined decorating statement.



Trim Styles

Typically trims have round apertures and Halo offers a wide selection of round trims; Halo offers a number of square trims that reinforce rectilinear decor lines and make a distinctive designer statement.



Halo Recessed Lighting

Trim – Features & Designs

A full line of trim styles, finishes and design features are expanding in the Halo trim collection. With these trim and feature expansions, Halo is bringing ways to help ease installation process. While keeping products classy and the ability to personalize your lighting fixtures to best suit the space. These trims are specifically modeled to work with the E26 screw base housings and are compatible with EISA halogen, incandescent, CFL & LED equivalent lamps.

1 Patent Pending Perfex™ 5" & 6" Baffle

- **NEW** Halo exclusive perforated design pattern
- A fine perforated pattern design of overlapping density, self-flanged
- 5110 & 6110 series trims



2 Coilex® 3", 4", 5" & 6" Baffle

- Fine thread pattern with crisp edges
- Precise triple lead-in thread design
- Timeless Halo signature for over 50 years

3 Self-flanged Trim Rings

- For simplicity and ease of installation

4 Torsion Spring Design

- Torsion springs are easy to install and hold flange tight to ceiling

5 Coil Spring Design

- Coil springs are easy to install with flexible coils that allow adjustment in holding flange tight to ceiling

6 5" & 6" Chamfered Inner Transition

- **New** 5" (5100/5200) and 6" (6100/6200) series
- The new chamfered trims are designed to reduce the visual impact on the ceiling
- Tapered profile to limit shadows



Air-Tite™ Code Compliant Trims

- Air-Tite trims are test certified to the American Society for Testing and Materials procedure ASTM E283 as having an air leakage rate not more than 2.0 cfm (0.944 L/s) when tested at a 1.57 psi (75 Pa)
- Form fitting socket collar for tight seal with self-flange trim ring sealing aperture
- Benefits include: Savings in HVAC bills, preventing moisture damage to attic areas, reduced sound transmission between floors, and eliminating drafts for greater comfort
- **New** 6" Air-Tite trims include: 6120, 6121, 6125, 6126, 6145, 6146
- **Classic** 6" Air-Tite trims include: 30, 78PAT, 170PS, 171PS, 172PS, 173PS, 430

air-tite



Halo Recessed Lighting

Trim – Features & Designs



3" & 4" Trim Features

- Small aperture trims have less ceiling presence, and celebrate simple and clean lines around circumference
- Smaller aperture trims may be used to visually differentiate the room interior design
- Trims are also a functional element in lighting design as used for accent, task and general downlighting
- Designed for similar appearance regardless of lamp source whether line voltage PAR20 or low voltage MR16

3" Trim Designs



4" Trim Designs



5" Trim Features

- Halo 5" trims are now available for use in socket bracket or no socket bracket housing models
- **New** 5100/5200 series half cone reflector and baffle trims are designed for 5" H5 and E5 housings that include a socket plate with adjustment bracket
- **New** innovative designs in adjustable and lens trims; and new open wet location Showerlight trims for use with outdoor rated lamps
- Note: 5" 5000 series trims are all full-height socket supporting for use in H5 and E5 "NB" no socket bracket housings only

6" Trim Features

- Halo 6" trims are designed to offer the greatest flexibility in lamp types and trim styles
- The 6" trim balances proportion of larger scale with narrower trim ring visibility with various tapered styles
- **New** 6100/6200 series trims focus on simplicity of self-flanged rings, these forgiving size trims expand coverage of ceiling gaps and construction tolerances
- **New** designs in lens trims and new open wet location showerlight trims for use with outdoor rated lamps are offered
- 6" trims are offered in full-height socket supporting designs and in half cone designs for customer choice of housings with "NB" no socket bracket or a socket plate with adjustment bracket

NEW 5" (5100/5200) & 6" (6100/6200) – E26 Screw Base Styles & Finishes

Full Cone Baffle



- WB**
White Baffle
White Trim
- BB**
Black Baffle
White Trim
- BKBB**
Black Baffle
Black Trim

Full Cone Reflector



- WH**
White Reflector
White Trim
- SN**
Satin Nickel Reflector
Satin Nickel Trim
- TBZ**
Tuscan Bronze Reflector
Tuscan Bronze Trim

Half Cone Baffle



- WB**
White Baffle
White Trim
- BB**
Black Baffle
White Trim
- BKBB**
Black Baffle
Black Trim

Squirgle – Frost Glass Lens



- AH**
Aluminum Haze
- PN**
Polished Nickel
- SN**
Satin Nickel

Open Showerlight



- WH**
White
- SN**
Satin Nickel
- TBZ**
Tuscan Bronze

Lens/Showerlight – Frost Glass Lens



- WH**
White
- SN**
Satin Nickel
- TBZ**
Tuscan Bronze

Adjustable



- WH**
White
- BK**
Black
- SN**
Satin Nickel
- TBZ**
Tuscan Bronze

Regressed Adjustable



- WB**
White Baffle
- BB**
Black Baffle
- SC**
Specular Clear
Reflector
- H**
Haze Reflector

Halo Recessed Lighting

Listings, Compliance & Industry Associations

Rising energy demand and corresponding costs are a fact of life and lighting fixtures play a two fold role in the energy equation – besides the light sources and fixtures themselves, their effect on heating and air conditioning costs must also be considered.

IC Fixtures

If lighting fixtures are being installed in an insulated attic area, choose IC (Insulated Ceiling) and for additional benefits choose ICAT (Insulated Ceiling Air-Tite) fixtures. These fixtures allow you to maintain an unbroken layer of insulation. IC rated luminaires are tested to UL1598 standards where insulation materials such as blown-in or batting type dry insulation may be placed in direct contact with the luminaire.

Blown-in or batting type insulation allows convective heat transfer away from the recessed light fixture, and allows direct access to the luminaire for inspection and servicing, as required by National Electric Code. In accordance with NEMA LSD57-2013 industry guidelines, the use of spray-in foam insulation in direct contact with recessed luminaires is not recommended. As such, NEMA recommends that spray-in foams be kept 3" from recessed luminaires. Alternate installation might include, but not be limited to, wrapping the luminaire in fiberglass batting to maintain energy efficiency while preserving access to the luminaire.

Air-Tite™ Fixtures

Air-Tite fixtures are qualified under test standard ASTM E-283, to restrict air flow between unconditioned areas and heated or air conditioned spaces. Standard recessed housings allow up to 5.0 cubic ft. per minute of air leakage to escape into unconditioned spaces. Air-Tite fixtures reduce this leakage by sealing air pathways. Air-Tite fixtures may be IC for use in insulated ceilings (such as H7ICAT) or they may be Non-IC for non-insulated ceilings (such as H36TAT). Air-Tite fixtures qualified to ASTM E-283 have 2.0 cfm (0.944 L/S) or less air flow rate at 1.57 PSF (75 Pa) pressure differential.

Additional benefits include: Savings in HVAC bills, preventing moisture damage to ceilings, reduced sound transmission between floors, and eliminating drafts for greater comfort.



Air-Tite™ Trims

An Air-Tite designated trim makes a housing Air-Tite. Simply add the Air-Tite trim to a Halo housing to meet code, and enjoy the additional benefits of an Air-Tite fixture.



Wet Location Listed Showerlights

Halo offers wet location listed trims which are designed for use over tubs, in showers, and protected outdoor ceiling areas such as porches and soffits. Where noted, models have trim rings and lenses manufactured of non-conductive and non-corrosive polymer and glass materials that are "dead-front". Trims suitable for use in showers carry a wet location cULus listing and are identified with one of the following icons.



Cooper Lighting Solutions is a participating member and significant contributor in industry associations to assure that our lighting and control systems adhere to the highest performance and efficiency standards.

The US Environmental Protection Agency's ENERGY STAR® program is designed to identify and promote energy efficient products and buildings. Cooper Lighting Solutions is proud to be an industry leader of certified products including many of our Halo recessed downlights. www.energystar.gov



The American Lighting Association is a lighting industry trade association. Members include lighting and ceiling fan manufacturers, retail showrooms, sales representatives and professional residential lighting designers. www.americanlightingassoc.com/



Cooper Lighting Solutions supports state codes enforcing more stringent and environmentally protective standards such as California Energy Commission's Title 24 or Title 20 Energy Efficiency standards. www.energy.ca.gov/title24 and www.energy.ca.gov/appliance



The LIRC works to enhance communication between professional lighting designers and lighting manufacturers to improve products, services, business practices, and lighting design education. <http://www.iald.org>



The mission of the National Association of Homebuilders is to enhance the housing and the building industry. Cooper Lighting Solutions is a proud participating member of the NAHB. www.nahb.org



International Energy Conservation Code (IECC) establishes energy-related heating, cooling, water heating, electrical and lighting system standards for residential, multi-family, and commercial buildings. www.iccsafe.org



RoHS Directive - Restriction of Hazardous Substances. This global initiative seeks to eliminate hazardous materials in products. Key materials being eliminated from products through RoHS include: cadmium, mercury and lead among others.



Cooper Lighting Solutions is a proud participating member of the IESNA, Illuminating Engineering Society of North America. www.iesna.org



HALO luminaires are manufactured and designed in accordance with the specifications outlined in Underwriters Laboratories Standard for Safety – Luminaires 1598. These luminaires additionally comply with the applicable requirements found within the National Electrical Code (NEC), NFPA 70.



ASHRAE/IESNA 90.1 standard is generally regarded as the definitive source of guidelines for achieving energy efficiency requiring certain watts per square foot (w/ft²) depending on the application. www.ashrae.org



Products bearing the cULus Listed marks indicate that the luminaires have been evaluated by Underwriters Laboratories, and are found to be compliant with the product specific requirements for the United States and Canada. www.ul.com/



As a U.S. Green Building Council member, Cooper Lighting Solutions supports their mission to promote buildings that are environmentally responsible, profitable and healthy places to live and work. www.usgbc.org



Cooper Lighting Solutions was the first major lighting manufacturer to partner with the Clinton Climate Initiative (CCI), and work with the C40 Large Cities Climate Leadership Group (C40) to reduce greenhouse gas emissions and serve as models for other cities. <http://c40cities.org> www.clintonfoundation.org/cf-pgm-ccihome.htm



Halo Recessed Lighting

Lighting Properties

Luminous Flux (Lumens)

Luminous flux (lumens) is the measure of the total light producing power of the light source. It is the amount of light leaving the source without regards to direction. A halogen 72W A19 clear lamp has 1520 nominal lamp lumens. The luminous flux is provided by the lamp manufacturers in a listing of common lamp and lumen values.

Units: Lumens (lm)

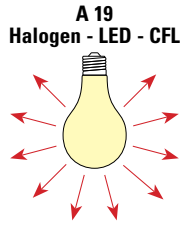

Luminous Intensity (Candela)

The luminous intensity (candelas) is the strength of the light produced in a specific direction. The luminous intensity of an optical system is compiled graphically into diagrams known as candela or candlepower distribution curves. Both polar and cartesian graphs are used within the lighting industry for this purpose. This information is also available in numeric tabular form.

Units: Candela (cd)

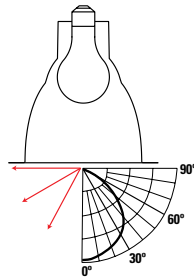

Illuminance (Footcandles)

Illuminance is the measure of the quantity of luminous flux that arrives on a surface. Illuminance is affected by the luminous intensity from the fixture in the direction of the lighted surface, the distance from the luminaire to the surface, and the angle of incidence of the arriving light. Although illuminance cannot be detected by the eye, it is the most often used criteria in specifying lighting designs.

Units: Footcandles (fc)

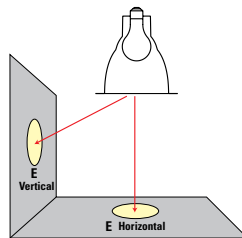

Luminance (Candelas/Meter²)

Luminance is the measure of light leaving a surface in a given direction. It is what the eye perceives. Typically, luminance reveals more about the quality and comfort of a lighting system than just illuminance alone.

Units: Candelas per Square Meter (cd/m²)

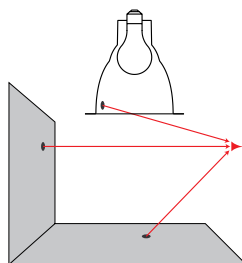

Correlated Color Temperature (CCT)

The color temperature (chromaticity) of a light source describes the actual color appearance of the light produced with regard to its warmth or coolness. Measured on the temperature scale of Kelvin, it is defined with the use of a reference light source termed a blackbody radiator. This reference is completely black when cold, and as it is heated begins to glow, taking on a reddish orange appearance. Heated further, its color appearance shifts towards yellow, then white and eventually bluish white at the high end of the scale. An orange red color light has a lower color temperature than a blue white light. Psychologically, the lower Kelvin temperatures are perceived as "warm", the higher as "cool", the opposite of what might be expected. With solid state LED and discharge sources such as compact fluorescent and HID light is produced by methods other than heating a filament and the color is measured by its correlated color temperature (CCT). It is the measure of the color of the light, not the actual operating temperature of the lamp.

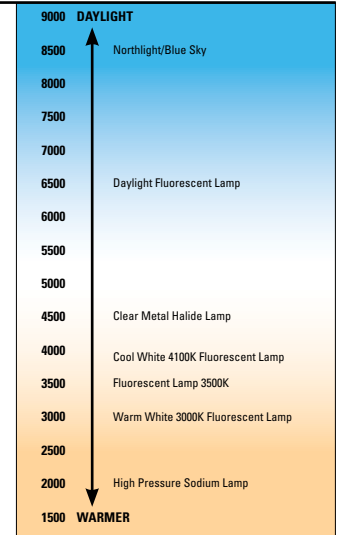

Color Temperature & Effects of Lighting

Color Temp Kelvin Range	WARM 2700K	WHITE 3000K	NEUTRAL 3500K	COOL 4100K	DAYLIGHT 5000K
Effects	Warm Cozy Open	Friendly Intimate Personal	Friendly Safe Neutral	Neat Clean Efficient	Bright Alert Crisp
Typical Applications	Homes Restaurants Hotels Boutiques	Homes Libraries Office Areas Retail Stores Office Areas	Public Areas Showrooms Bookstores Hospitals	Office Areas Conference Rooms Classrooms Printing Companies	Museum Displays Jewelry Displays Medical Exam Areas

Color Rendering Index (CRI)

The color rendering index (CRI) of a light source describes the influence of light on the color appearance of objects being illuminated. CRI describes the apparent color shift undergone by a standard set of test colors illuminated by a source as compared to their appearance under the blackbody reference source. The apparent shift in colors is measured and averaged on the CRI chromaticity diagram, and the higher the number, the closer the apparent match. Since CRI is an average it is not possible to predict the effect on one particular color, and consequently, different lamps with the same CRI may not render colors alike. CRI is only a valid comparison when comparing lamps of the same color temperature since the appearance of the test colors vary as the reference blackbody radiator varies.

Units: CRI (on a scale up to 100)

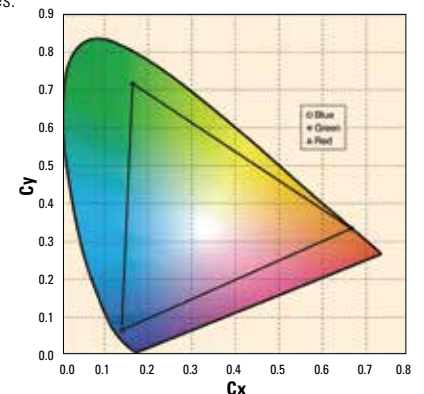

Halo Recessed Lighting

Lighting Properties

Illuminating Engineering Society (IES) Evaluating Light Source Color Rendition

Illuminating Engineering Society (IES) TM-30-15 method for evaluating light source color rendition. IES TM-30-15 is a technical memorandum published by the IES that details a new method for evaluation and identification of color rendition properties of a light source. The IES notes that no single measure can accurately identify all aspects of the color rendition of light. Therefore the TM-30-15 Technical Memorandum describes a method for evaluating color rendition of a light source based upon quantifying the fidelity (closeness to a reference color illuminate) through a Fidelity Index (R_f) and gamut (increase or decrease in chroma or saturation relative to a reference color illuminate) through a Gamut Index (R_g) of a light source. The method also generates a color vector graphic that indicates average hue and chroma shifts, which visually plots values of R_f and R_g, and aids with interpreting the method's results. TM-30-15 method provides equations and direction for calculating R_f and R_g, including the spectral reflectance functions for 99 Color Evaluation Samples (CES). A software tool is included with TM-30-15 as provided to aid in calculation and display of the results.

IES Method for Color Rendition

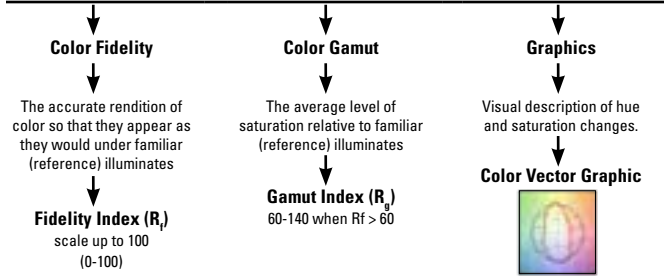

Luminaire Efficiency

Luminaire efficiency is the ratio of lumens emitted by a luminaire in relation to lumens produced initially by the lamp contained within. It includes both the optical and thermal characteristics of the luminaire and is measured under controlled ambient conditions of 77°F (25°C). Luminaire efficiency does not indicate any information on the direction of the light leaving the fixture or its visual appearance.

Units: Percentage %

$$\text{Efficiency \%} = \frac{\text{Luminaire Lumens}}{\text{Lamp Lumens}}$$

Efficiency is a comparison of like terms; in the case of a lighting fixture, lumens from the luminaire vs. from the lamp. This measure of efficiency is concerned with the amount of light a luminaire can provide given the specific light source it employs.

Efficacy

Efficacy is the ratio of the luminous flux (lumens) produced by a source in relation to the energy (watts) it consumes. While efficiency is a comparison of like terms, efficacy is a comparison of unlike terms — the lumen and the watt. It is analogous to the miles per gallon rating of automobiles. It compares how a light source converts power into light. For example:

13.5W LED Luminaire (LED, Driver, Optic/Trim)
1100 lm/13.5W = 81 LPW (Total Luminaire Efficacy)

26W CFL lamp
1800 lm/28W = 64.2 LPW (Bare Lamp Efficacy)

26W CFL Luminaire (Lamp, Ballast, Trim) with 70% Luminaire (Trim) Efficiency
1260 lm/28W = 45 LPW
Units: Lumens per watt (LPW or lm/W)

$$\text{LED LPW} = \frac{\text{Delivered Luminaire Lumens}}{\text{Luminaire Watts}}$$

$$\text{CFL, Halogen LPW} = \frac{\text{Lamp Lumens X Luminaire Efficiency}}{\text{Luminaire Watts}}$$

Cutoff & Shielding Angle

The lamp cutoff angle of a luminaire is the angle between the vertical axis (nadir) and the first line of sight when the bare source is no longer visible. Lamp image cutoff is measured the same way as lamp cutoff, but it occurs when the image of the lamp is no longer visible in the reflector. The shielding angle is the complement of the cutoff angle.

When both the lamp cutoff and lamp image cutoff are equal, the optical system has no spill light and uses all of the light in the useful beam. Equal cutoff to lamp and lamp image also provide higher visual comfort for the space.

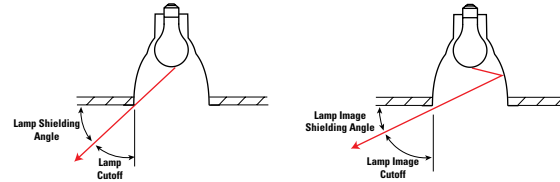

Candela Diagrams (Candle Power Distribution)

Candela diagrams provide an illustration of the intensity and distribution of light. This allows quick estimates on how useful a particular fixture would be in an application. Polar graphs provide a visual indication on how narrow or wide a beam a fixture produces. Two sets of angles are referenced, vertical and horizontal angles. Vertical angles range from 0° at nadir to 90° along the ceiling line. The number of horizontal angles referenced depends on the rotational shape and symmetry of the light distribution. Sections, or planes of data, are cut at various intervals to describe the intensity changes at the same elevation angles. The 0°-180° plane slices the luminaire along the axis of the lamp, the 90°-270° plane cuts across the lamp axis. Additional planes are supplied every 22.5° where the light distribution becomes more asymmetric. In general, numerical data instead of small polar diagrams should be used for calculations, since the diagrams become difficult to read at the higher elevation angles and at angles surrounding the fixture.

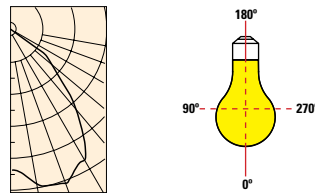

Reflectance

Reflectance is the ratio of luminous flux (lumens) reflected from a surface in relation to luminous flux (lumens) incident onto the surface. Types of surface reflectance range from the specular to the diffuse (Lambertian), with many objects exhibiting combinations. Typically, reflectance becomes more specular with larger incident angles. Reflectances of room surfaces are important consideration when calculating illuminances using the "Lumen Method."

$$\text{Reflectance \%} = \frac{\text{Reflected Lumens}}{\text{Incident Lumens}}$$

Units: Percentage % Symbol: p

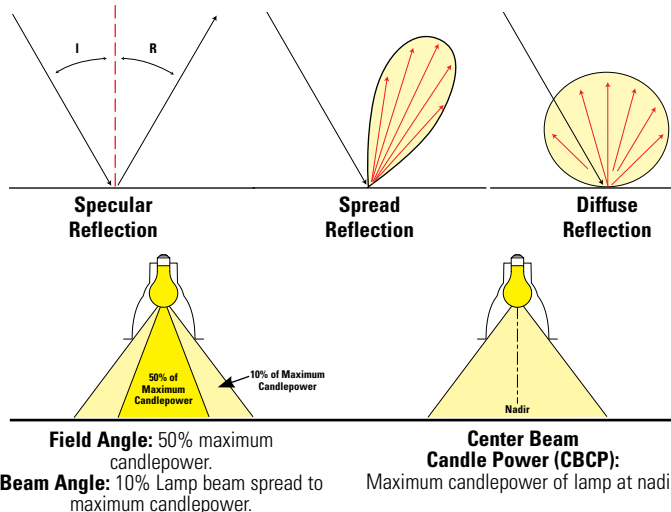

Halo Recessed Lighting

Lighting Effects

Point-to-Point Calculations

The calculation of foot-candles at a point, no matter if it is on a horizontal, vertical or tilted surface, can be accomplished with the inverse square law. The law states that the illuminance is proportional to the candlepower of the source in the given direction and inversely proportional to the square of the distance from the source. In addition, as a surface is tilted away from the source, illuminance will decrease in a ratio equal to the cosine of the angle of incidence.

The inverse square law formula can be expressed in various ways; the two most useful follow. Version 1 is ideal for the complexities of three-dimensional space as no trigonometry (cosine) is needed, just the simple X, Y and Z coordinates of the layout. It is also very useful in calculating foot-candles from the CBCP of accent lights. Version 2 is useful for calculations that can be laid out in two dimensions and when it is easy to find the cosine of the aiming angle. Insert your data into either easy-to-use formula to calculate the initial foot-candle level at a point.

Version 1

$$FC = \frac{I \times N}{D^2}$$

Where: I = CD towards Point

D = Distance to Point (square root of $X^2 + Y^2 + Z^2$)

N = Distance Normal to the Surface

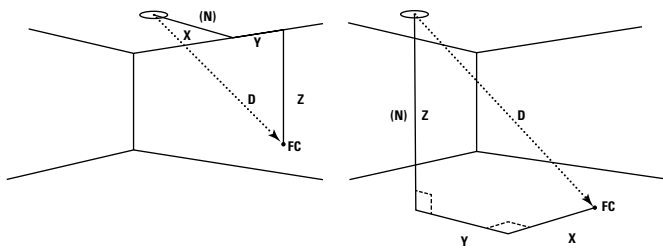

Version 2

$$FC = \frac{I \times \cos \theta}{D^2}$$

Where: I = CD towards Point

D = Distance to Point (square root of $X^2 + Y^2$)

θ = Angle between incident light ray and normal to the surface

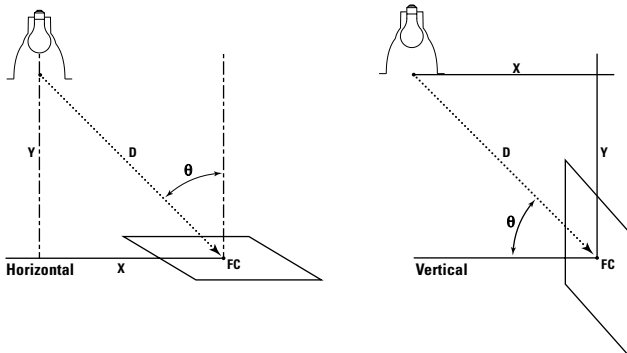

θ	$\cos \theta$	$\tan \theta$
0°	1.0	.000
5°	.996	.087
10°	.985	.176
15°	.966	.268
20°	.940	.364
25°	.906	.466
30°	.866	.577
35°	.819	.700
40°	.766	.889
45°	.707	1.0

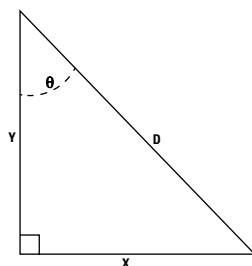

To find distance D: $D = \sqrt{X^2 + Y^2}$ or $D = \frac{Y}{\cos \theta}$

To find aiming angle θ : $\tan \theta = \frac{X}{Y}$ or $\cos \theta = \frac{Y}{D}$

Ambient Lighting

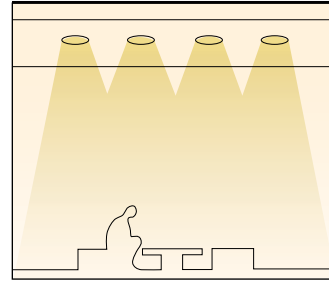

Lighting throughout an area which produces general illumination. The appropriate Halo recessed fixtures are available to provide patterns of light distribution for this purpose. These units direct light in specific patterns to illuminate areas without drawing attention to the fixtures themselves.

Task Lighting

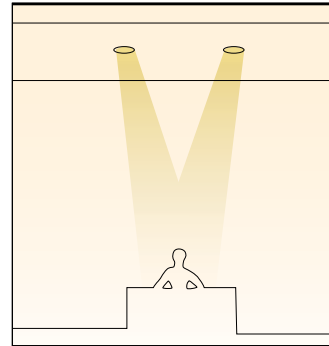

Lighting directed to a specific area to perform a specific task. Use Halo fixtures with narrower beam patterns and high illumination levels. Task-Ambient Lighting—The combination of task and ambient lighting should provide a level of ambient lighting that is lower than the task yet is designed so the ambient complements the task lighting. Here luminance ratio should be considered. Luminance ratio is the measure of task or accent to surrounding ambient lighting. For example, retail stores may use 5-to-1 task-to-ambient lighting on cash registers for transactions and 10-to-1 accent-to-ambient lighting on displays to draw maximum attention to the products.

Wall Washing

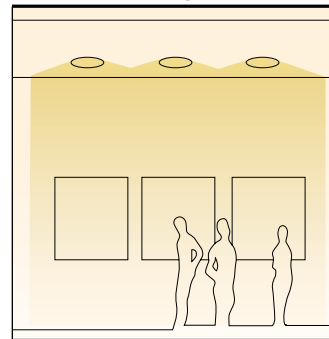

Lighting of vertical surfaces defines form, space and texture. It can visually increase the apparent size of a room while improving visual comfort. Halo has skillfully engineered fixtures designed to direct a spread of illumination on these surfaces. Halo fixtures may be selected based on the size of the space, the level of illumination and intensity desired, energy efficiency and controllability.

Accent Lighting

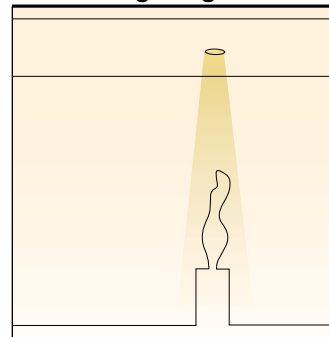

Directional lighting used to focus attention on a particular object or surface. Its intensity levels vary according to ambient illumination levels. Higher ambient levels require higher accent illumination to provide the necessary contrast (luminance ratio). This requires adjustable fixtures which can deliver higher illumination levels and precise beam distributions. Halo adjustable trims are often used in accent lighting and offer the range of intensities and beam spreads necessary for controlled quality lighting.

Halo Recessed Lighting

Light Sources

Light Emitting Diodes (LED)



Solid State Lighting (LED) once only known to the electronics industry are now a common component used for general lighting. And the reason is LED's superior energy efficiency and extremely long operational life compared to traditional incandescent technology. LED's have been used in automotive and signal products for some time because of LEDs natural generation of red, blue, and green color. With recent breakthroughs in LED chip set technology a LED is now capable of generating "white light". Combined with technological advances in LED driver power electronics, LED may be applied successfully to general lighting products. LED is also referred to as Solid State Lighting (SSL) because it is composed of various semiconductor materials and when an electrical current passes through the diode, the recombination of positive and negative charges results in the emission of photons or light. As a result LED luminaires are high-efficiency alternatives to less efficient light sources.

The Benefits of LED

- Energy Savings - Significant savings over traditional sources (Halo ML56 - 600 Series consumes 86% less energy than comparable 65W BR30 incandescent lamps)
- High Efficacy - LED offers more lumens per Watt (Halo ML56 - 600 Series delivers up to 92 LpW compared to 9.5 LpW of 65W BR30 incandescent lamps)
- Long Operational Life - LED offers significant life values, with many models offering over 50,000 hours (Compare to 65W BR30 incandescent lamp with typical life of 2,500 hours)
- Reduced maintenance cycle - LED can perform for years, even in 24 hours 7 days a week operation
- Dimmable - Designated LED drivers are capable of full range dimming and may operate with many standard dimmers
- Improved quality of light - LED downlight optics offer smooth, even illumination across the visual field
- Soffit applications - LED downlighting may be used in protected canopies, porches, and soffits in colder climates than fluorescent sources (where designated for "Wet Location" listing)
- Code compliance - LED lighting may be used to meet stringent code requirements requiring higher luminaire efficacy (Lumens per Watt) and lower building power density (watts per square foot)
- Reduced environmental impact - Significant reduction in energy loads with LED lighting offers reduction of carbon emissions in electrical generation

Color Selection choices for Halo LED:

- Color Rendering Index (CRI): 90 CRI (R9 > 50)
- Correlated Color Temperature (CCT): 2700K, 3000K, 3500K, 4000K, 5000K are offered, based upon model series

LED Warranty:

- Cooper Lighting Solutions provides a five year limited warranty on designated HALO LED luminaires. Consult www.cooperlighting.com/legal

Applications: General, Task, Wall Wash, Accent (depending upon model selected)

Halogen Low Voltage (MR16)

Multifaceted Reflector (MR) lamps produce crisp, white light; with more typical sparkle than PAR lamps. Low voltage halogen lamps offer the best light control and are ideal for accenting. Low voltage lamps require a transformer in the fixture to step line voltage down to nominal lamp operating voltage.

Applications: Task, Accent, Wall Wash, Grazing

Sizes: MR16

Beam Spread: Many available. Measured in beam angles.

Typical Rated Life: 4,000 to 6,000 hours



Incandescent and Halogen (INC/HAL)

These are popular because they are easy to install, are relatively inexpensive and are available in a wide range of wattages and bulb styles. Halogen lamps are a type of incandescent with filaments of tungsten wire heated by the passage of electrical current to incandescence. All clear halogen lamps are considered to have a color rendering index of 100.

A-Lamps

General service "A" lamps emit a warm light. These require reflectors to effectively control light.

Applications: General, Wall Wash

Typical Sizes: A17, A19, A21

Typical Rated Life: 1000 hours



R and BR Lamps

Reflector (R) and Bulge Reflector (BR) lamps emit a warm amber light. These have built-in reflectors to control light in flood and spot beam patterns.

Applications: General, Task, Accent, Wall Wash, Grazing

Sizes: R20, BR30, BR40

Beam Spread: Flood, Spot

Typical Rated Life: 2,500 hours



PAR Halogen Lamps

Parabolic aluminized reflector lamps produce a crisp, white light. These use built-in reflectors with internal reflective coatings and lenses to control light in many beam patterns.

Applications: General, Task, Accent, Wall Wash, Grazing

Sizes: PAR16, PAR20, PAR30S (short neck), PAR30L (long neck), PAR38

Beam Spread: Narrow Spot, Spot, Flood, Narrow Flood, Wide Flood

Typical Rated Life: 2,500 hours





HALO Home Smart Lighting System

LED Modules	28
LED Outdoor	30
Flood	30
Flood + Motion	31
Smart Controls	32
Smart Dimmer	32
Accessory Dimmer	33
Battery Scene Keypad	34
Anyplace Dimmer	35
Accessories	36
Bridge	36
Lamp Dimmer	37
Smart Light Adapter	38



HALO Home Smart Lighting System

LED Products



HALO Home Collection

HALO Home is a flexible new approach to smart home lighting. Our system offers a range of Bluetooth® fixtures, controls and accessories that work seamlessly together. From a single light to an entire home, your smart lighting search starts and ends here.

HALO Home offers lots of control options – from Bluetooth in-wall wired switches to Bluetooth-enabled wireless “anyplace” controls, user-friendly mobile apps, web application, or all of the above. No internet connection or hub is required to get started; you can easily configure the lights using Bluetooth connection and any smart device.



Install

Install HALO Home Bluetooth-enabled products



Connect

Download the secure HALO Home App

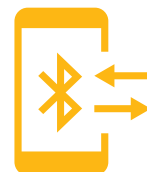

Control

Control your lights with your mobile device

HALO Home Smart Lighting System

LED Products



HALO Home app

Our user-friendly mobile app lets you control lighting from your fingertips, and from anywhere in the world (with the optional Smart Internet Access Bridge). Available for iOS and Android, it features dimming, adjustable white tuning, grouping, automatic scheduling and more.



Voice control compatible

Customize your home lighting with anywhere in the world access and voice control. HALO Home is compatible with Amazon Alexa and Google Assistant products, when paired with the optional Smart Internet Access Bridge.



Flexible and scalable

HALO Home is a simple and flexible connected option, with the ability to install as little as one smart light or scale up to control the entire home through the easy-to-use HALO Home app.

Adjustable white tuning

Select the perfect color for your mood and beautifully complement your home. The HALO Home smart lighting fixtures provide the ability to adjust color temperatures from 2700K (warm white) to 5000K (daylight).

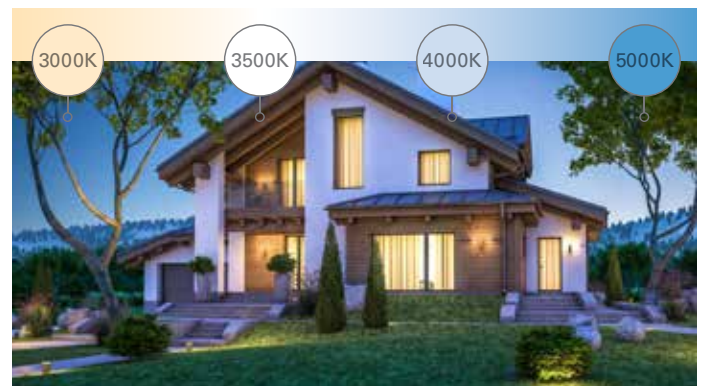
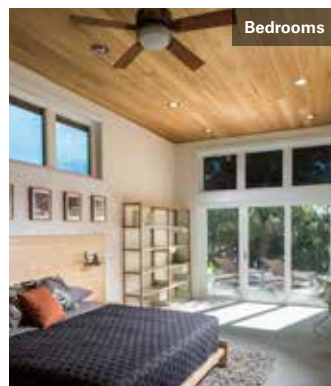
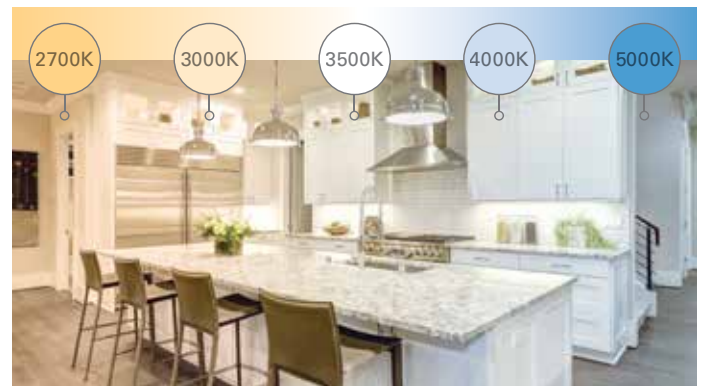
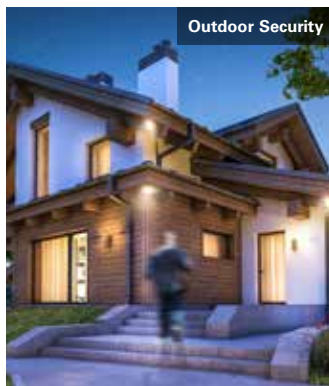

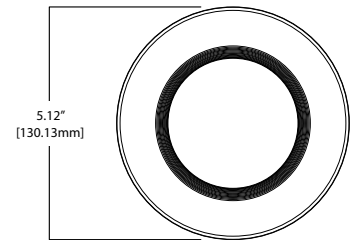
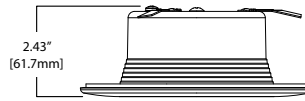

RL4

4" LED All-Purpose Retrofit Module with Bluetooth Mesh Connectivity

The Halo Home RL4 is an integrated LED module with Bluetooth® Mesh connectivity for 4" aperture recessed downlights. When paired with the Halo Home mobile app or Halo Home Accessory dimmers, the RL4 can be wirelessly controlled. Suitable for new construction, remodel and retrofit installation. Listed for use with Halo 4" housings and classified for use with other 4" housings, airtight and can be used with housings in direct contact with insulation. The RL4 is designed to connect to the Halo Home Bluetooth Mesh network with no hub or internet connection required.



Features

Wireless System

- For use with the Halo Home mobile app.
- Bluetooth low energy (BLE) mesh allows on/off, white tuning and lumen output to be controlled wirelessly with companion wall switches, smart phones and tablets using Halo Home mobile application.
- Group, schedule, scenes and automate lighting actions through Halo Home mobile app. HALO Home products work better together. Smartphone will need to be within range to control a HALO Home device. Expand and strengthen the Bluetooth network range by adding more HALO Home devices. Visit www.cooperlighting.com to learn more.

Wireless Pairing

- See Halo quick start guide for wireless setup, guidance and troubleshooting.

Module - Trim

- Module construction includes LED Array, heat sink, reflector, lens, baffle and trim ring.
- Regressed baffle
- Heat sink designed to conduct heat away from the LED Array, keeping the junction temperatures below specified maximums, even when installed in insulated ceiling environments.

LED Array

- Mid power LED array provides a uniform source with high efficiency and no pixilation.
- 90 CRI minimum, R9 greater than 50
- Color accuracy within 3 SDCM at the CCT endpoints and 4 SDCM in between endpoints, provide color accuracy and uniformity.
- Color Temperature (CCT) has an adjustable range from 2700K to 5000K within the mobile app (factory default 3000K)
- 50,000 hour life

RL4 Series Ordering Information

Models	Lumens	CRI / CCT	Protocol	Finish	Accessories
RL4 = 4" all-purpose retrofit LED module	06 = 600 lumens (nominal)	9 = 90 CRI minimum, white tuning, select CCT 2700K – 5000K, in the mobile app	BLE40A = Bluetooth Mesh wireless control, 4.0	WH = matte white baffle	RL4TRMWHB = 4" White Paintable Trim Ring, Baffle RL4TRMSNB = 4" Satin Nickel Trim Ring, Baffle RL4TRMTBZB = 4" Tuscan Bronze Trim Ring, Baffle RL4TRMWH = 4" White Paintable Trim Ring RL4TRMSN = 4" Satin Nickel Trim Ring RL4TRMTBZ = 4" Tuscan Bronze Trim Ring

Optical Assembly

- Regressed lens
- Impact-resistant polycarbonate
- Convex form and lamp-like appearance
- Diffuse for even illumination

Driver

- Integral 120V 50/60 Hz constant current driver provides noise free operation
- Inline electrical quick connect and E26 adapter (provided) provides mains connections
- Consult instruction sheets and quick start guide for more information

Dimming

- In the mobile app, continuous, flicker-free dimming from 100% to 5%.
- It is not recommended with any in wall dimmers.

Retention

- Push-N-Twist universal installation clips
- Clips are pre-installed and designed to fit 4" compatible recessed housings

Designer Skins (sold separately)

- RL4 skins are accessory rings that attach to the RL4 for a permanent finish. Refer to the RL4 accessories specification sheet for details.
 - White (Paintable)
 - Satin Nickel
 - Tuscan Bronze

Gaskets

- Closed cell gaskets achieve restrictive airflow requirements without additional caulking

Factory Reset

Using the wall switch repeat this process 4 times: OFF for 2 seconds + ON for 6 seconds. The RL4 will flash twice after successful reset.

Compliance

- cULus certified for use with Halo housings and other's housings
- Wet and Damp location listed
- Airtight certified per ASTM-E283
- Suitable for use in clothes closets when installed in accordance with the NEC 410.16 spacing requirements
- EMI/RFI emissions per FCC 47CFR Part 15 consumer limits
- Contains no mercury or lead and RoHS compliant
- Photometric testing in accordance with IES LM-79-08
- Lumen maintenance projections in accordance with IES LM-80-08 and TM-21-11
- Can be used for State of California Title 24 high efficacy luminaire compliance. Complies with Title 24 JA8-2016-E.
- Can be used International Energy Conservation Code (IECC) high efficiency luminaire compliance.
- ENERGY STAR® listed, reference database for current listings
- Lighting Facts labeled
- FCC ID: 2AKCY-RL4BLE
- IC Code: 4706A-RL4BLE

Warranty

Five year limited warranty, consult website for details. www.cooperlighting.com/legal

RL4 Energy Data

Input Voltage	120V
Input Current	.069 A
Input Power	8 W
Inrush (A)	2.3 A
THD: ≤ 20%	
PF: ≥ 0.90	
T Ambient -40 - +40°C	
Sound Rating ≤ 22.5dba	

HALO Home

RL56 - Bluetooth

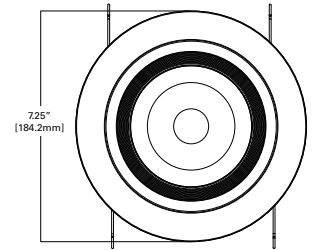
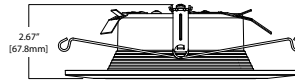

RL56

5" / 6" LED All-Purpose Retrofit Module with Bluetooth Mesh Connectivity

The Halo Home RL56 is an integrated LED module with Bluetooth® Mesh connectivity for 5" & 6" aperture recessed downlights. When paired with the Halo Home mobile app or Halo Home Accessory dimmers, the RL56 can be wirelessly controlled. Suitable for new construction, remodel and retrofit installation. Listed for use with Halo 5" & 6" housings and classified for use with other 5" & 6" housings, airtight and can be used with housings in direct contact with insulation. The RL56 is designed to connect to the Halo Home Bluetooth Mesh network with no hub or internet connection required.



Features

Wireless System

- For use with the Halo Home mobile app.
- Bluetooth low energy (BLE) mesh allows on/off, white tuning and lumen output to be controlled wirelessly with companion wall switches, smart phones and tablets using Halo Home mobile application.
- Group, schedule, scenes and automate lighting actions through Halo Home mobile app.
- HALO Home products work better together. Smartphone will need to be within range to control a HALO Home device. Expand and strengthen the Bluetooth network range by adding more HALO Home devices. Visit www.cooperlighting.com to learn more.

Wireless Pairing

- See Halo quick start guide for wireless setup, guidance and troubleshooting.

Module - Trim

- Module construction includes LED Array, heat sink, reflector, lens, baffle and trim ring.
- Regressed baffle
- Heat sink designed to conduct heat away from the LED Array, keeping the junction temperatures below specified maximums, even when installed in insulated ceiling environments.

LED Array

- Mid power LED array provides a uniform source with high efficiency and no pixilation.
- 90 CRI minimum, R9 greater than 50
- Color accuracy within 3 SDCM at the CCT endpoints and 4 SDCM in between endpoints, provide color accuracy and uniformity.
- Color Temperature (CCT) has an adjustable range from 2700K to 5000K within the mobile app (factory default 3000K)
- 50,000 hour life

RL56 Series Ordering Information

Models	Lumens	CRI / CCT	Protocol	Finish	Accessories
RL56 = 5"/6" all-purpose retrofit LED module	06 = 600 lumens (nominal)	9 = 90 CRI minimum, white tuning, select CCT 2700K - 5000K, in the mobile app	BLE40A = Bluetooth Mesh wireless control, 4.0	WH = matte white baffle	RL56TRMW/WH = 5"/6" White Paintable Trim Ring, Baffle RL56TRMSNB = 5"/6" Satin Nickel Trim Ring, Baffle RL56TRMTBZB = 5"/6" Tuscan Bronze Trim Ring, Baffle RL56TRMWH = 5"/6" White Paintable Trim Ring RL56TRMSN = 5"/6" Satin Nickel Trim Ring RL56TRMTBZ = 5"/6" Tuscan Bronze Trim Ring

Optical Assembly

- Regressed lens
- Impact-resistant polycarbonate
- Convex form and lamp-like appearance
- Diffuse for even illumination

Driver

- Integral 120V 50/60 Hz constant current driver provides noise free operation
- Inline electrical quick connect and E26 adapter (provided) provides mains connections
- Consult instruction sheets and quick start guide for more information

Dimming

- In the mobile app, continuous, flicker-free dimming from 100% to 5%.
- It is not recommended with any in wall dimmers.

Retention

- Integral torsion springs and Push-N-Twist universal installation clips offer two mounting options
- Clips are pre-installed and designed to fit 5" & 6" compatible recessed housings

Designer Skins (sold separately)

- RL56 skins are accessory rings that attach to the RL56 for a permanent finish. Refer to the RL56 accessories specification sheet for details.
 - White (Paintable)
 - Satin Nickel
 - Tuscan Bronze

Gaskets

- Closed cell gaskets achieve restrictive airflow requirements without additional caulking

Factory Reset

Using the wall switch repeat this process 4 times: OFF for 2 seconds + ON for 6 seconds. The RL56 will flash twice after successful reset.

Compliance

- cULus certified for use with Halo housings and other's housings
- Wet and Damp location listed
- Airtight certified per ASTM-E283
- Suitable for use in clothes closets when installed in accordance with the NEC 410.16 spacing requirements
- EMI/RFI emissions per FCC 47CFR Part 15 consumer limits
- Contains no mercury or lead and RoHS compliant
- Photometric testing in accordance with IES LM-79-08
- Lumen maintenance projections in accordance with IES LM-80-08 and TM-21-11
- Can be used for State of California Title 24 high efficacy luminaire compliance. Complies with Title 24 JA8-2016-E.
- Can be used International Energy Conservation Code (IECC) high efficiency luminaire compliance.
- ENERGY STAR® listed, reference database for current listings
- Lighting Facts labeled
- FCC ID: 2AKCY-RL56BLE
- IC code: 4706A-RL56BLE

Warranty

Five year limited warranty, consult website for details. www.cooperlighting.com/legal

RL56 Energy Data

Input Voltage	120V
Input Current	.082 A
Input Power	9.7 W
Inrush (A)	1.4 A
THD: ≤ 20%	
PF: ≥ 0.90	
T Ambient -40 - +40°C	
Sound Rating ≤ 22.5dba	

HALO Home

FTS20C Flood - Bluetooth



Front View

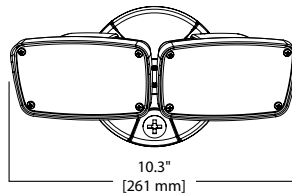

Side View

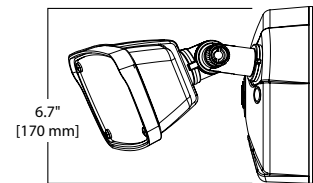

Eave Mount

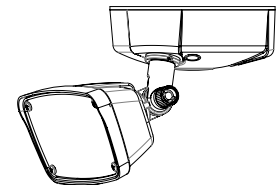

FTS20C

Twin Head LED Flood with Bluetooth Mesh Connectivity

The HALO Home smart LED floodlight incorporates Bluetooth® Mesh technology into a durable, twin head design for an advanced outdoor lighting solution built for high performance. Featuring a multitude of configurable settings including grouping, scheduling, dimming and white color tuning, the FTS20C does not require a hub and can be wirelessly controlled directly from any compatible smart device utilizing the Halo Home app, or any Halo Home wireless switch or dimmer.

Features

Wireless System

- For use with the HALO Home mobile app.
- Bluetooth low energy (BLE) mesh allows on/off and dimming to be controlled wirelessly with companion wall switches, smart phones and tablets using HALO Home mobile app.
- White tuning, grouping, scheduling and countdown timer controlled through HALO Home mobile app. HALO Home products work better together. Smartphone will need to be within range to control a HALO Home device. Expand and strengthen the Bluetooth network range by adding more HALO Home devices. Visit www.cooperlighting.com to learn more.

Construction

- Durable die-cast aluminum housing with UV stable clear lens
- Powder coated bronze or white finish
- Optically enhanced reflector improves efficiency and delivered lumens
- Tool-less head adjustment
- Wall or eave mounted to recessed or surface junction boxes

Electrical

- For use with 120-277V, 50/60Hz power source
- Maintenance-free LED's with 70,000 hours of life
- Operating temperature of -30°C to 40°C
- cULus listed for wet locations
- External supply wiring 75°C minimum

Optics

- Two-stage optics for maximum coverage
- Wirelessly controlled white tuning from 3000K to 5000K CCT (factory default 4000K)
- Wirelessly controlled dimming to 5%

Warranty

- Five year limited warranty

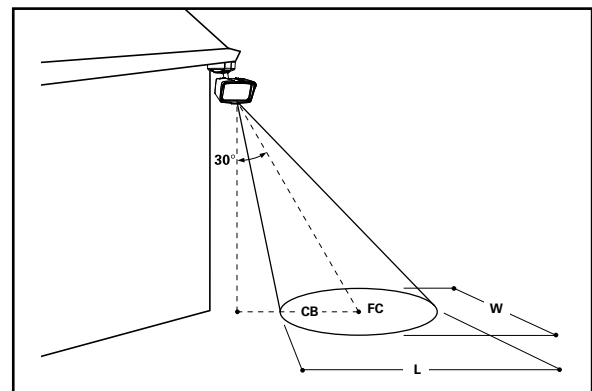

Note: Specifications and Dimensions subject to change without notice.

Area Coverage

Mounting Height	Length (L)	Width (W)	Area (Sq. Ft.)	Max F.C.
10 ft.	18	40	720	4.3
15 ft.	20	40	800	1.9
20 ft.	20	40	800	1.1

Note: Bronze fixture at a typical mounting angle of 30° from vertical

All figures based on minimum footcandle (FC) of 0.5 and 4000K CCT

FTS20C Energy Data @ 4000K

Voltage	120-277V, 50/60Hz
Power	22.8 W
Delivered Lumens*	2034
Efficacy*	89.2 (lm/w)
CCT	3000K - 5000K
CRI*	84
Protocol	Bluetooth Mesh 4.0

* Based on factory default setting of 4000K CCT

FTS20C Series Ordering Information

Application	Size	Nominal Wattage	Protocol	Finish
FT = Flood, Twin Head	S = Small	20 = 20W	C = Connected Bluetooth Mesh Wireless Control, 4.0	B = Bronze W = White

HALO Home

MST20C Motion Flood - Bluetooth



Front View

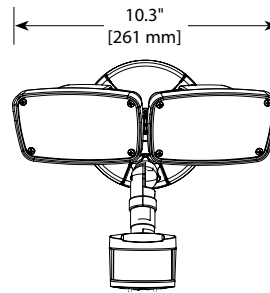

Side View

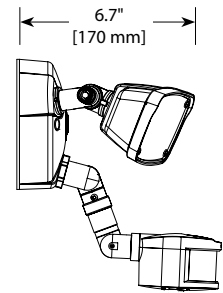

MST20C

Smart Motion Floodlight Twin Head LED Motion with Bluetooth Mesh Connectivity

The HALO Home Smart Motion Floodlight incorporates Bluetooth® Mesh technology into a durable, twin head LED motion sensor flood design for an advanced outdoor lighting solution built for high performance. Features configurable settings for both the motion sensor and floodlight, including sensitivity, duration and scene control, as well as grouping, scheduling, dimming and white color tuning. The MST20C does not require a hub and can be wirelessly controlled directly from any compatible smart device utilizing the HALO Home app, or any HALO Home controllers.

Eave Mount

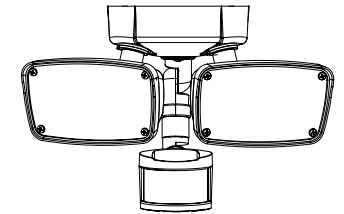

Features

Wireless System

- For use with the HALO Home mobile app
- Bluetooth low energy (BLE) mesh allows on/off and dimming to be controlled wirelessly with companion wall switches, smart phones and tablets using Halo Home mobile app
- Dual Bluetooth module design allows for separate floodlight (device) and motion sensor (controller) function
- White tuning, grouping, scheduling, scenes and countdown timer controlled through HALO Home mobile app
- Motion sensitivity control from 0-100%
- Photocontrol sensitivity from 0-100% HALO Home products work better together. Smartphone will need to be within range to control a HALO Home device. Expand and strengthen the Bluetooth network range by adding more HALO Home devices. Visit www.cooperlighting.com to learn more.

Construction

- Durable die-cast aluminum housing with UV stable clear lens
- Powder coated bronze or white finish
- Optically enhanced reflector improves efficiency and delivered lumens
- Tool-less head and motion sensor adjustment
- Wall or eave mounted to recessed or surface junction boxes

Electrical

- For use with 120-277V, 50/60Hz power sources
- Maintenance-free LED's with
- 70,000 hours of life

- Operating temperature of -30°C to 40°C
- cULus listed for wet locations
- External supply wiring 75°C minimum
- Motion sensor detects motion 180° up to 50 feet

Optics

- Two-stage optics for maximum coverage
- Wirelessly controlled white tuning from 3000K to 5000K CCT (factory default 4000K)
- Wirelessly controlled dimming to 5%

Warranty

- Five year limited warranty

Reset to Factory Settings

- Using the wall switch, repeat this process 4 times: OFF 2 seconds + ON for 6 seconds.
- The LED floodlight will flash twice after a successful reset.

Note: This will revert both the Floodlight and the associated Motion Sensor to their Factory Setting.

Making the most of Bluetooth Mesh

- HALO Home products communicate with each other and your mobile device using Bluetooth Mesh technology. As with any Bluetooth-enabled product, your smartphone will need to be within range to control a HALO Home device. You can strengthen and expand your Bluetooth network range by adding more HALO Home devices within your house.
- Visit www.cooperlighting.com to learn more.

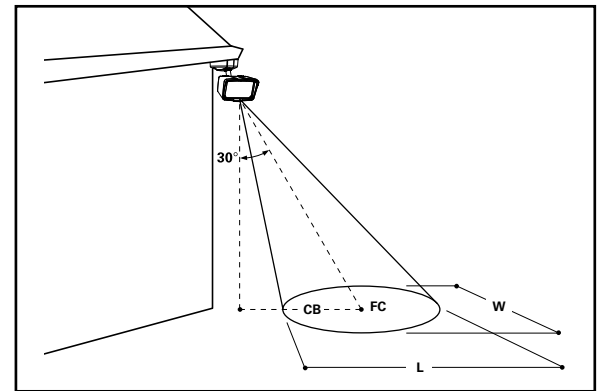

Note: Specifications and Dimensions subject to change without notice.

Area Coverage

Mounting Height	Length (L)	Width (W)	Area (Sq. Ft.)	Max F.C.
10 ft.	18	40	720	4.3
15 ft.	20	40	800	1.9
20 ft.	20	40	800	1.1

Note: Bronze fixture at a typical mounting angle of 30° from vertical

All figures based on minimum footcandle (FC) of 0.5 and 4000K CCT

MST20C Energy Data @ 4000K

	MST20C18B	MST20C18W
Voltage	120-277V, 50/60Hz	120-277V, 50/60Hz
Power	22.8 W	22.8 W
Delivered Lumens*	2034	2034
Efficacy*	89.2 (lm/w)	89.2 (lm/w)
CCT	3000K - 5000K	3000K - 5000K
CRI*	84	84
Motion Sensor	Single PIR, 180° Detection	Single PIR, 180° Detection

* Based on factory default setting of 4000K CCT

FTS20C Series Ordering Information

Application	Head	Nominal Wattage	Protocol	Motion Sensor	Finish
MS = Motion Sensor	T = Twin	20 = 20W	C = Connected Bluetooth Mesh Wireless Control, 4.0	18 = 180° Detection	B = Bronze W = White

HALO Home

HIWMA1BLE40AWH In-Wall Smart Dimmer - Bluetooth



Only use with non-smart lights

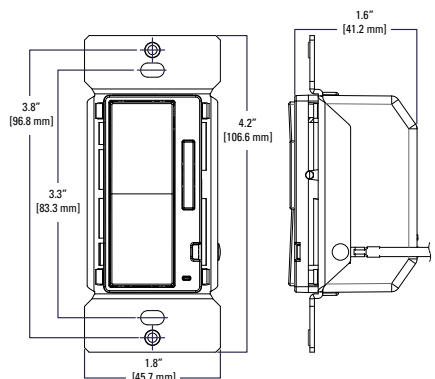

HIWMA1BLE40AWH

In-Wall Smart Dimmer

Turn standard/non-smart lights into smart lights – enabling mobile ON/OFF, dimming, groups, scenes and schedules via Bluetooth, even when switched OFF at the dimmer. Control a single light or an entire room with group settings within the mobile app.

Features

Wireless System

- Utilizes Bluetooth Mesh 4.0
- Wireless range of up to 100 feet from Bluetooth device to device and up to 33 feet from Bluetooth smartphone/tablet to closest device.
- 2.4GHz signal frequency
- HALO Home products work better together. Smartphone will need to be within range to control a HALO Home device. Expand and strengthen the Bluetooth network range by adding more HALO Home devices. Visit www.cooperlighting.com to learn more.

Wireless Pairing

- See Halo quick start guide for wireless setup, guidance and troubleshooting.

Features

- Control standard lights with the switch or free HALO Home app
- Features ON/OFF, Dimming, Groups, Schedules, and Scenes
- Works with dimmable LEDs, CFL, halogen, and incandescent bulbs and light fixtures

Environmental

- Rated for Indoor Use only. 32°F to 104°F (0°C to 40°C) damp locations

Design Features

- Range: Up to 100 feet line of sight
- Dimmer to have four 6" pre-stripped wire leads for line (black), load (red), ground (green) and neutral (white)
- Air-gap switch disconnects power from load forcing an OFF condition to safely work on the light fixtures.

- Air-gap switch will also disconnect power from the internal circuitry of the dimmer.
- Air-gap switch is a 1 way switch – power is connected through the air-gap switch when the air-gap plastic is in, and power does not go through the air-gap switch when the air-gap plastic is pulled out.
- Neutral wire will be required for installation
- Large paddle switch that actuates 2 switches. Upper part of paddle actuates one switch ON, and lower part of paddle actuates the other switch OFF for ON and OFF functions listed below.
- Thin dimmer rocker switch that also actuates 2 more switches. Upper part of rocker actuates one switch Brighten, and lower part of paddle actuates the other switch Dim for Brighten and Dim functions listed below.
- One status LED under firmware control
- Dimming state shall be retained in the event of AC power loss.
- Acoustic noise not to exceed 22 dBa SPL at 1 ft

Button Functions

- Dim up (Brighten) will brighten the lamps associated to the Smart Dimmer
- Dim down will dim the lamps associated to the Smart Dimmer
- ON will turn on the lamps associated to the Smart Dimmer
- OFF will turn off the lamps associated to the Smart Dimmer
- Holding the ON button for 12 seconds will factory reset the dimmer and it will also be in Bluetooth pairing mode.

Factory Reset

- Hold the ON button for 12 seconds to reset and claim to your account.

Certifications & Compliance

- cULus Listed, NOM Certified. Complies with FCC Part 15, Class B,
- Industry Canada RSS-Gen and RSS-247
- Title 24 and Title 20 Compliant
- NEMA SSL 7A Compliant type 1 Dimmer
- Bluetooth Certification 4.1 or higher + Mesh
- ROHS-2

Warranty

- Five year limited warranty, consult website for details. www.cooperlighting.com/legal

HIWMA1BLE40AWH Ordering Information

Device	Generation	Radio	Finish
HIWMA = HALO In-Wall Accessory Dimmer ¹	1=1st generation	BLE40A=Bluetooth Low Energy 4.0	WH=White BL=Black LA=Light Almond

Multi-Unit Installation Chart

Device	Load Type	1-Gang	2-Gang	3-Gang
RF9540-N	INC/ELV/FLR/Halogen/MLV	600W/VA	550W/VA	500W/VA
	LED/CFL	300W	300W	300W

Single Switch



HALO Home™ Smart Dimmer

Standard Light Fixtures

3-Way or multi-switch



HALO Home™ Smart Dimmer (Sold Separately)

Standard Light Fixtures

HALO Home™ Accessory Dimmers

HALO Home

HIWAC1BLE40AWH In-Wall Accessory Dimmer - Bluetooth



Only use with HALO Home lights

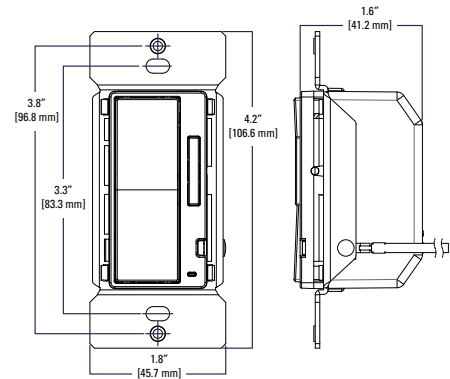

HIWAC1BLE40AWH

In-wall Accessory Dimmer

The HALO Home In-Wall Accessory Dimmer controls your HALO Home lighting devices from a central location. The Accessory Dimmer is designed to connect to the HALO Home Bluetooth Mesh network with no hub or internet connection required. The Accessory Dimmer can occupy any position in a multi-gang junction box, while the other positions of the junction box can be occupied by switches or other dimmers. The Accessory Dimmer can operate HALO Home lighting fixtures with single, 3-way or multi-switch controls. For standard lights, the Accessory Dimmer can be used for multi-switch control when paired with HALO Home In-wall Smart Dimmer.

Features

Wireless System

- Utilizes Bluetooth Mesh 4.0
- Wireless range of up to 100 feet from Bluetooth device to device and up to 33 feet from Bluetooth smartphone/tablet to closest device.
- 2.4GHz signal frequency
- HALO Home products work better together. Smartphone will need to be within range to control a HALO Home device. Expand and strengthen the Bluetooth network range by adding more HALO Home devices. Visit www.cooperlighting.com to learn more.

Wireless Pairing

- See Halo quick start guide for wireless setup, guidance and troubleshooting.

Features

- Control HALO Home smart lights with the switch or free HALO Home app
- Features ON/OFF, Dimming Groups, Schedules, and Scenes
- Works with HALO Home smart LED lights only

Environmental

- Rated for Indoor Use only. 32°F to 104°F (0°C to 40°C) damp locations

Design Features

- Range: Up to 100 feet line of sight
- Dimmer to have four 6" pre-stripped wire leads for line (black), load (red), ground (green) and neutral (white)
- Air-gap switch disconnects power from load forcing an OFF condition to safely work on the light fixtures.

- Air-gap switch will also disconnect power from the internal circuitry of the dimmer.
- Air-gap switch is a 1 way switch – power is connected through the air-gap switch when the air-gap plastic is in, and power does not go through the air-gap switch when the air-gap plastic is pulled out.
- Neutral wire will be required for installation
- Large paddle switch that actuates 2 switches. Upper part of paddle actuates one switch ON, and lower part of paddle actuates the other switch OFF for ON and OFF functions listed below.
- Thin dimmer rocker switch that also actuates 2 more switches. Upper part of rocker actuates one switch Brighten, and lower part of paddle actuates the other switch Dim for Brighten and Dim functions listed below.
- One status LED under firmware control
- Dimming state shall be retained in the event of AC power loss.
- Acoustic noise not to exceed 22 dBA SPL at 1 ft

Button Functions

- Dim up (Brighten) will brighten the lamps associated to the Smart Dimmer
- Dim down will dim the lamps associated to the Smart Dimmer
- ON will turn on the lamps associated to the Smart Dimmer
- OFF will turn off the lamps associated to the Smart Dimmer
- Holding the ON button for 12 seconds will factory reset the dimmer and it will also be in Bluetooth pairing mode.

Factory Reset

- Hold the ON button for 12 seconds to reset and claim to your account.

Certifications & Compliance

- cULus Listed, NOM Certified. Complies with FCC Part 15, Class B
- Industry Canada RSS-Gen and RSS-247
- Title 24 and Title 20 Compliant
- NEMA SSL 7A Compliant type 1 Dimmer
- Bluetooth Certification 4.1 or higher + Mesh
- ROHS-2

Warranty

- Five year limited warranty, consult website for details. www.cooperlighting.com/legal

HIWMA1BLE40AWH Ordering Information

Device	Generation	Radio	Finish
HIWAC = HALO In-Wall Accessory Dimmer ¹	1=1st generation	BLE40A=Bluetooth Low Energy 4.0	WH=White BL=Black LA=Light Almond

Multi-Unit Installation Chart

Device	Load Type	1-Gang	2-Gang	3-Gang
HIWAC1BLE40AWH	INC/ELV/FLR/Halogen/MLV	600W/VA	550W/VA	500W/VA
	LED/CFL	300W	300W	300W

Single Switch, 3-way or multi-switch with HALO Home Lighting Fixtures



Smart Lighting 3-way or multi-switch for standard lighting fixtures



HALO Home

HIWSKB1BLE40AWH Multi-Room Scene Keypad- Bluetooth



Battery Powered

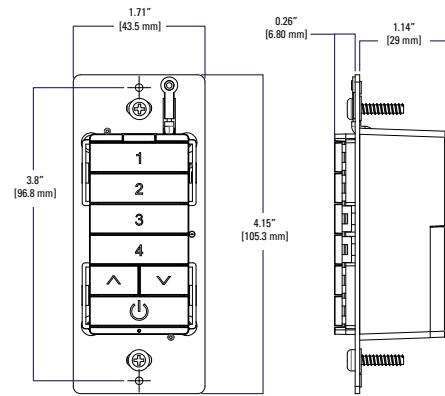

HIWSKB1BLE40AWH

Battery Powered Multi-Room Scene Keypad

The HALO Home Multi-Room Scene Keypad allows you to control up to four lighting scenes or groups, ON/OFF and dimming throughout your home from a central location. The Keypad contains four (4) scene buttons, dim-up and dim-down buttons, and all scene OFF button. The Keypad is designed to connect to the HALO Home Bluetooth Mesh network with no hub or internet connection required. The battery powered keypad connects wirelessly to control HALO Home lights, controls and accessories throughout the home. It can be added to an existing bank of switches or placed in-wall wherever lighting control is desired.

Features

Wireless System

- Utilizes Bluetooth 4.1 with mesh networking topology.
- Wireless range of up to 100 feet from Bluetooth device to device and up to 33 feet from Bluetooth smartphone/tablet to closest device.
- 2.4GHz signal frequency.
- HALO Home products work better together. Smartphone will need to be within range to control a HALO Home device. Expand and strengthen the Bluetooth network range by adding more HALO Home devices. Visit www.cooperlighting.com to learn more.

Wireless Pairing

- See HALO Quick Start Guide for wireless setup, guidance and troubleshooting.

Features

- Turn scenes ON/OFF from the Scene Keypad or the free HALO Home app.
- Features four scene buttons, dim-up and dim-down buttons, and an all-off button.
- Works with HALO Home smart LED lights or group of lights on the same circuit with the HALO Home Smart Dimmer.

Environmental

- Rated for Indoor Use only. 32°F to 104°F (0°C to 40°C) damp locations.

Design Features

- Range: Up to 100 feet line of sight.
- One status LED under firmware control.
- Acoustic noise not to exceed 22 dBA SPL at 1 ft.

Button Functions

- Four (4) buttons to turn on up to four scenes or groups.
- Dim up (Brighten) will brighten the lamps associated to an active scene.
- Dim down will dim the lamps associated to an active scene.
- OFF will turn off the lamps associated to an active scene.

Factory Reset

- Press the 1 button 4 times, then the OFF button 4 times, then the 1 button 4 times.
- The LED indicator will stay on for 5 seconds then blink for 30 seconds on a successful reset.

Certifications & Compliance

- cULus Listed. Complies with FCC Part 15, Class B, Industry Canada RSS-Gen and RSS-247.
- Title 24 and Title 20 Compliant.
- Bluetooth Certification 4.1 or higher + Mesh networking topology.
- ROHS-2.

Warranty

- Five year limited warranty, consult website for details. www.cooperlighting.com/legal

HIWSKB1BLE40AWH Ordering Information

Device	Power Source	Generation	Radio	Finish
HIWSK = HALO In-Wall Scene Keypad	B=Battery powered	1=1st generation	BLE40A=Bluetooth Low Energy 4.0	WH=White

HALO Home

HWAS1BLE40AWH Anyplace Bluetooth Dimmer- Bluetooth

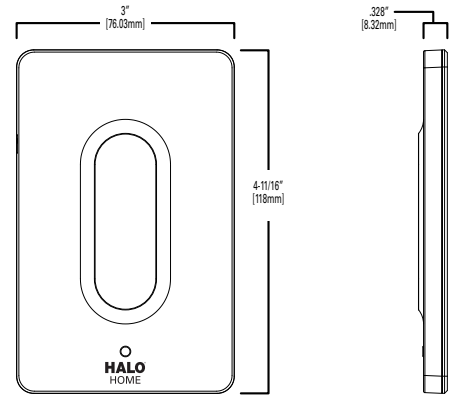

HWAS1BLE40AWH

Anyplace Bluetooth Dimmer

The HALO Home Anyplace Bluetooth Dimmer allows for HALO Home Bluetooth Mesh compatible light fixtures to be controlled from a handheld remote controller, through the Bluetooth Mesh connection. The light fixture can be controlled from the remote controller or through the HALO Home mobile app, using a smart phone or other device. The Anyplace Dimmer is designed to connect to the HALO Home Bluetooth Mesh network with no hub or internet connection required.

Features

Wireless System

- Utilizes Bluetooth Mesh 4.0
- Wireless range of up to 100 feet (line of sight) to nearest device 2.4GHz signal frequency.
- HALO Home products work better together. Smartphone will need to be within range to control a HALO Home device. Expand and strengthen the Bluetooth network range by adding more HALO Home devices. Visit www.cooperlighting.com to learn more.

Features

- Using the HALO Home app and the Anyplace Dimmer, each Bluetooth Mesh lighting fixture has the ability for:
 - On/Off
 - Dimming
- Turn on/off and adjust dim levels using the battery operated switch or via smartphone or tablet equipped with Bluetooth.
- HALO Home RLs dim down to 5%

Mounting

- Use 2 screws or provided double sided tape to mount to walls

Compatible Products

- The Anyplace Dimmer must be paired with another HALO Home device.
- Contents:
 - 3 replaceable CR2032 batteries
 - Adhesive mounting tape
 - Mounting screws

Compliance

- EMI/RFI emissions per FCC 47CFR Part 15 consumer limits

Warranty

- Five year limited warranty, consult website for details. www.cooperlighting.com/legal

HWAS1BLE40AWH Ordering Information

Device	Protocol	Finish
HWAS1= HALO Home Anyplace Dimmer	BLE40A=Bluetooth wireless mesh 4.0 control	WH=White

HALO Home

HWB1BLE40AWH Internet Access Bridge- Bluetooth

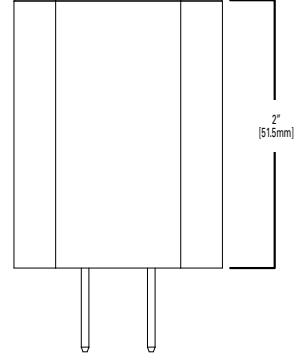
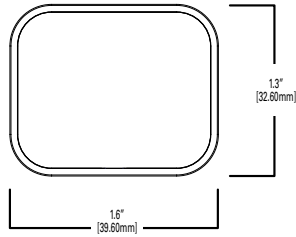

HWB1BLE40AWH

Internet Access Bridge

The HALO Home Internet Access Bridge (Bridge) enables you to control your HALO Home devices and accessories from anywhere in the world. The Bridge establishes a secure connection between your local Bluetooth network and the HALO Home Cloud, enabling you to take advantage of an ever-increasing lineup of Cloud services, including Amazon Alexa and Google Assistant. Wireless router and Internet connection are required.

Features

Wireless System

- Utilizes Bluetooth Mesh 4.0
- Wireless range of up to 50 feet of closest HALO Home Bluetooth devices and Wi-Fi router.
- 2.4GHz signal frequency
- HALO Home products work better together. Smartphone will need to be within range to control a HALO Home device. Expand and strengthen the Bluetooth network range by adding more HALO Home devices. Visit www.cooperlighting.com to learn more.

Features

- Using the HALO Home app and the HHIAB each lighting fixture has the ability for:
- Control your lighting system from anywhere in the world
- Control your lighting system using Amazon Alexa and Google Assistant

Integration

- HHIAB allows for integration and control of any Halo Home device through the following Cloud services.
- Amazon Alexa
- Google Assistant

Indicators

- Bluetooth and Wi-Fi LED indicators inform you once connection is made

Manual Reset

- Manual reset button located on the device to reset to factory settings

Driver

- For use with 110/220V compatible sockets

Compatible Products

- Any HALO Home lighting device and the HALO Home app

Compliance

- cULus listed
- EMI/RFI emissions per FCC 47CFR Part 15 consumer limits

Warranty

- Five year limited warranty, consult website for details www.cooperlighting.com/legal

HWB1BLE40AWH Ordering Information

Device	Generation	Protocol	Finish
HWB = Portable Wireless Switch	1 = First	BLE40A=Bluetooth wireless mesh 4.0 control	WH=White

HALO Home

HWP1BLE40AWH Smart Plug-In Lamp Dimmer - Bluetooth

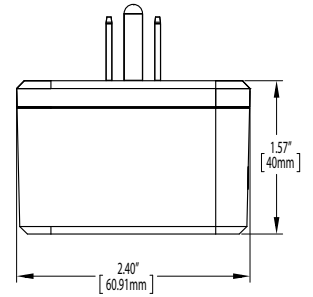
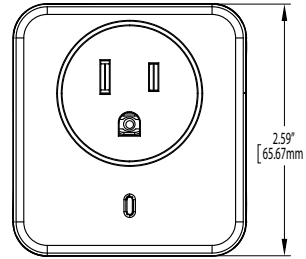

HWP1BLE40AWH

Smart Plug-In Lamp Dimmer

The HALO Home Smart Plug-In Lamp Dimmer enables convenient control for standard floor and table lamps using the HALO Home mobile app. Combine with more HALO Home light fixtures and accessories to create groups and scenes throughout the home. Smart Plug-In Lamp Dimmer is for lamps only.

Features

Wireless System

- Utilizes Bluetooth Mesh 4.0
- HALO Home products work better together. Smartphone will need to be within range to control a HALO Home device. Expand and strengthen the Bluetooth network range by adding more HALO Home devices. Visit www.cooperlighting.com to learn more.

Features

- Manual ON/OFF and brightness control with the side panel push button
- Using the HALO Home app with the Lamp Dimmer you can program the following controls:
 - On/Off
 - Dimming
 - Groups
 - Scheduling
 - Scenes

Driver

- Grounded 3-wire power connection for safety
- Power: 120VAC, 60Hz
- For use with 110/120V compatible sockets

Compatible Products

- 2.5A; 300W Incandescent or 150W Dimmable CFL/LED
- Maximum load for the Bluetooth-controlled outlet: 2.5A, 300W Incandescent or 150W Dimmable CFL/LED.

Factory Reset

- Hold the ON button for more than 15 seconds
- Constant flashing of blue status indicator light indicates successful reset.

Compliance

- UL Certified for US and Canada
- EMI/RFI emissions per FCC 47CFR Part 15 consumer limits
- Operating Temperature Range: -30 C to +45C

Warranty

- Five year limited warranty, consult website for details www.cooperlighting.com/legal

HWP1BLE40AWH Ordering Information

Device	Driver	Finish
HWP1 = Smart Plug-In Lamp Dimmer	BLE40A=Bluetooth wireless mesh 4.0 control	WH=White

HALO Home

HWAD1BLE40AWH Smart Light Adapter- Bluetooth

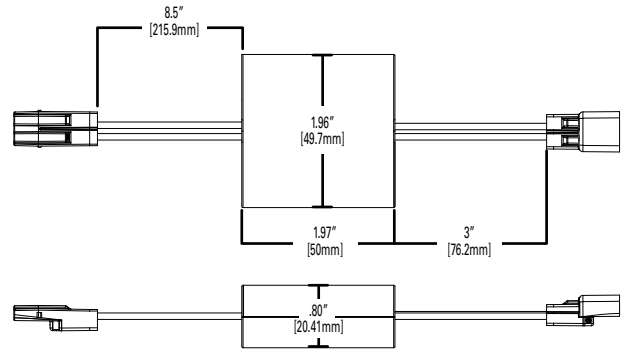

HWAD1BLE40AWH

Smart Light Adapter

The HALO Home Smart Light Adapter lets you control non-smart fixtures wirelessly with the HALO Home app. The Smart Light Adapter can be used to add wireless control to any light or group of lights. The Smart Light Adapter enables individual fixture control, dimming, groups scenes and schedules from a mobile device or tablet. Combine with more HALO Home products to create a whole home lighting system.

Features

Wireless Systems

- Wireless Range Up to 100 feet from Bluetooth device.
- Up to 33 feet from Bluetooth smartphone/tablet to closest device
- Signal (frequency) 2.4 GHz
- HALO Home products work better together. Smartphone will need to be within range to control a HALO Home device. Expand and strengthen the Bluetooth network range by adding more HALO Home devices. Visit www.cooperlighting.com to learn more.

Features

- Using the HALO Home app and the Wireless Adapter lighting device has the following capabilities:
 - On/Off
 - Dimming
 - Groups
 - Scheduling
 - Scenes
- Works with dimmable LED fixtures only
- Control any LED module with adapter

Input

- For use with 85-120V, 60Hz
- Max mains current 0.65A. No load standby power less than 0.2W

Output

- Dimmable LED 15W @120V
- Max output current 0.65A
- Minimum load requirement of 1W

Environmental

- Rated for Indoor Use only. 32°F to 104°F (0°C to 40°C) damp locations

Module

- Module construction includes smart light adapter, two connection points

Compatible Products

- Connects to dedicated LED recessed housing
- Connects to non-LED recessed housing with and Edison Adapter (not included)

Factory Reset

- Repeat this process 4 times: Disconnect for 0.5 to 4 seconds then ON for 5 to 9 seconds

Compliance

- cULus listed
- EMI/RFI emissions per FCC 47 CRF Part 15 consumer limits
- Operating Temperature Range: -30C to +40C

Warranty

- Five year limited warranty, consult website for details. www.cooperlighting.com/legal

HWAD1BLE40AWH Ordering Information

Device	Protocol	Finish
HWAD1 = Smart Light Adapter	BLE40A=Bluetooth wireless mesh 4.0 control	WH=White

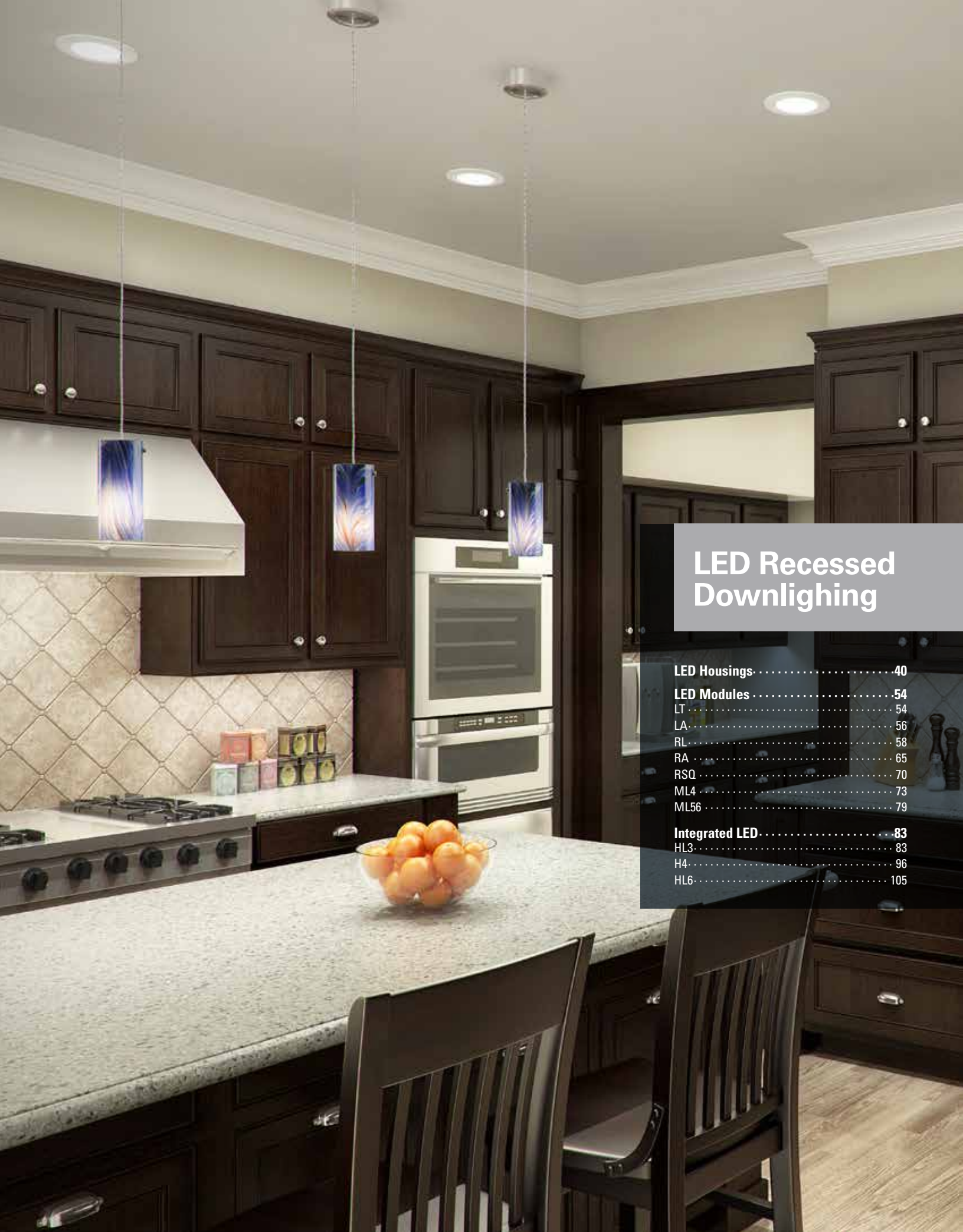

LED Recessed Downlighting

LED Housings	40
LED Modules	54
LT.....	54
LA.....	56
RL.....	58
RA.....	65
RSQ.....	70
ML4.....	73
ML56.....	79
Integrated LED	83
HL3.....	83
H4.....	96
HL6.....	105

LED Recessed Housing

H995ICAT

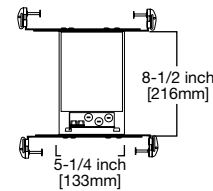
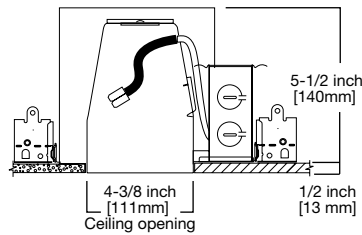

H995ICAT

4" IC, Air-Tite, New Construction LED Housing

The H995ICAT is a dedicated LED small aperture IC Air-Tite™ housing for use with Halo RA4, RL4, LT4 series LED modules and may be used with SLD4 series with the SLD spring kit. It is designed for use in insulated ceilings where it will be in direct contact with insulation*. It is an Air-Tite™ housing designed to restrict air flow between conditioned spaces and unconditioned areas. The LED connection is non-screw base to preserve the high efficacy rating of the luminaire.



Special Features

- Got Nail!™ bar hangers
- Pass-N-Thru™ bars
- Slide-N-Side™ junction box
- Quick Connect™ push wire nuts
- Air-Tite™ code compliant

Compatible LED Modules

RA4	LA4	BLD4
RL4	RSQ4	ML4
SLD4	RLD4	
LT4	SMD4	

Features

Housing

- Double wall aluminum construction helps dissipate heat. The inner housing can be adjusted in the plaster frame to compensate for different ceiling materials.
- Designed for insulated ceilings in direct contact with insulation* (May also be installed in non-insulated ceilings)
- Inner housing adjusts for ceilings up to 1" thick

Plaster Frame

- Galvanized steel die-formed construction
- The housing can be removed from plaster frame to provide access to the junction box
- Plaster frame features include:
 - Patented regressed locking screw positioned for securing hanger bars from below the ceiling
 - Cutouts for easily crimping hanger bars in position
 - Air-Tite aperture gasket is pre-installed
 - Halo identity embossed on plaster frame

Includes:

- Got Nail!™ bar hangers (Details Pg. 13)
- Pass-N-Thru™ bars (Details Pg. 13)
- Slide-N-Side™ junction box wire traps (Details Pg. 13)
- Quick Connect™ push wire nuts (Details Pg. 13)
- Air-Tite™ code compliant (Details Pg. 13)

LED Module Connection

Compatible Halo LED modules simply install with a plug-in line voltage wiring connector (UL and CSA Listed Luminaire Disconnect). This non-screw base LED connection preserves the high efficacy rating of the luminaire (see also LED Module specifications).

Compliance

- cULus Listed 1598 luminaire
- cULus Listed for damp location
- cULus Listed for wet location, covered ceiling, with select trims
- cULus Listed for feed through

- cULus Listed for direct contact with insulation and combustible material*
- Use with designated Halo LED systems for ENERGY STAR® certification
- Can be used for State of California Title 24 high efficacy compliance with designated Halo LED lighting systems.
- Can be used for International Energy Conservation Code (IECC) high efficacy compliance with designated Halo LED lighting systems.
- Air-Tite code compliant. Certified under ASTM E283; not exceeding 2.0 cfm (0.944 L/s) air leakage rate tested at a 1.57 psf (75 Pa) pressure differential

*Not to be used in direct contact with spray foam insulation (consult NEMA LSD57-2013)

LED Recessed Housing

H995RICAT

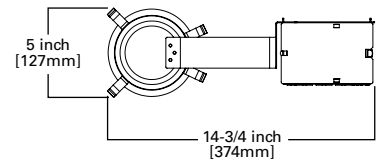
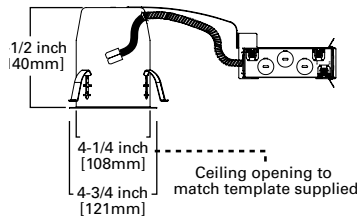

H995RICAT

4" IC, Air-Tite, Remodel LED Housing

The Halo H995RICAT is a dedicated LED remodel small aperture IC Air-Tite housing for use with Halo RA4, RL4, LT4 series LED modules and may be used with SLD4 series with the SLD spring kit. It is designed for installation into existing insulated ceilings where it will be in direct contact with insulation*. It is an Air-Tite housing designed to restrict air flow between conditioned spaces and unconditioned areas. The LED connection is non-screw base to preserve the high efficacy rating of the luminaire.



Special Features

- Slide-N-Side™ junction box
- Quick Connect™ push wire nuts
- Air-Tite™ code compliant

Compatible LED Modules

RA4	LA4	BLD4
RL4	RLQ4	ML4
SLD4	RLD5	
LT4	SMD4	

Features

Housing

- Single wall formed aluminum construction. Openings are gasketed for Air-Tite installation.
- 5-1/2" height allows use in shallow joist construction
- Air-Tite aperture gasket is pre-installed

Remodel Arm

Spring steel construction designed for ease of installation and ceiling support

Remodel Springs

Four remodel clips secure housing and accommodate 1/2" and 5/8" ceiling material

Includes:

- Slide-N-Side™ junction box wire traps (Details Pg. 13)
- Quick Connect™ push wire nuts (Details Pg. 13)
- Air-Tite™ code compliant (Details Pg. 13)

LED Module Connection

Compatible Halo LED modules simply install with a plug-in line voltage wiring connector (UL and CSA Listed Luminaire Disconnect). This non-screw base LED connection preserves the high efficacy rating of the luminaire (see also LED Module specifications).

Compliance

- cULus Listed 1598 luminaire
- cULus Listed for damp location
- cULus Listed for wet location, with select trims

- cULus Listed for direct contact with insulation and combustible material*
- Use with designated Halo LED systems for ENERGY STAR® certification
- Can be used for State of California Title 24 high efficacy compliance with designated Halo LED lighting systems
- Can be used for International Energy Conservation Code (IECC) high efficacy compliance with designated Halo LED lighting systems
- Air-Tite code compliant. Certified under ASTM E283; not exceeding 2.0 cfm (0.944 L/s) air leakage rate tested at a 1.57 psf (75 Pa) pressure differential

*Not to be used in direct contact with spray foam insulation (consult NEMA LSD57-2013)

LED Recessed Housing

H245ICAT

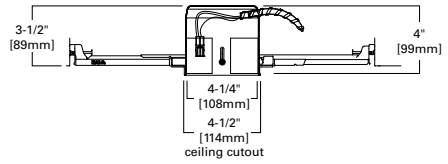
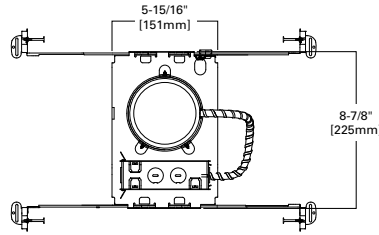

H245ICAT

4" IC, Air-Tite, Ultra-Shallow New Construction LED Housing

The H245ICAT is a 4" aperture ultra-shallow new construction housing for use with LED integrated trims. Suitable for 2x4 residential framing or shallow plenum commercial construction, type IC rated and can be used in direct contact with insulation and is air tight rated. Use with HALO LT4, RL4, RA4, RSQ4, SMD4, SLD4 LED integrated trims and the ML4 LED modular recessed lighting system.



Special Features

- Got Nail!™ bar hangers
- Pass-N-Thru™ bars
- Slide-N-Side™ junction box
- Quick Connect™ push wire nuts
- Air-Tite™ code compliant

Compatible LED Modules

RA4	LA4	BLD4
RL4	RSQ4	ML4
SLD4	RLD4	
LT4	SMD4	

Features

Housing

- Single wall deep drawn aluminum housing painted matte black for a visually dark interior
- Adjusts vertically to accommodate 1/2" to 1-1/4" thick ceilings and locks in position with (3) set screws
- V notches on plaster lip facilitate use of guide strings or laser lines for precise positioning
- Integral gasket provides for airtight compliance
- Shipped with overspray protector installed
- Housing can be removed from below the ceiling for service or splice inspection

Plaster Frame

- Compact galvanized steel plaster frame with integral bar hanger receivers
- Regressed screw provide positive horizontal bar hanger locking from below the ceiling
- Crimp points also provide for horizontal bar hanger locking

Includes:

- Got Nail!™ bar hangers (Details Pg. 13)
- Pass-N-Thru™ bars (Details Pg. 13)
- Slide-N-Side™ junction box wire traps (Details Pg. 13)
- Quick Connect™ push wire nuts (Details Pg. 13)
- Air-Tite™ code compliant (Details Pg. 13)

LED Module Connection

Compatible Halo LED modules simply install with a plug-in line voltage wiring connector (UL and CSA Listed Luminaire Disconnect). This non-screw base LED connection preserves the high efficacy rating of the luminaire (see also LED Module specifications).

Compliance

- cULus Listed 1598 luminaire
- cULus Listed for damp location
- cULus Listed for wet location, covered ceiling, with select trims
- cULus Listed for feed through

- cULus Listed for direct contact with insulation and combustible material*
- Use with designated Halo LED systems for ENERGY STAR® certification
- Can be used for State of California Title 24 high efficacy compliance with designated Halo LED lighting systems.
- Can be used for International Energy Conservation Code (IECC) high efficacy compliance with designated Halo LED lighting systems.
- Air-Tite code compliant. Certified under ASTM E283; not exceeding 2.0 cfm (0.944 L/s) air leakage rate tested at a 1.57 psf (75 Pa) pressure differential

*Not to be used in direct contact with spray foam insulation (consult NEMA LSD57-2013)

LED Recessed Housing

H245RICAT

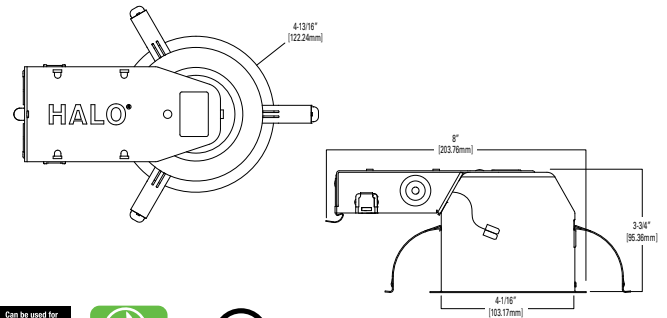

H245RICAT

4" IC, Air-Tite, Ultra-Shallow Remodel LED Housing

The H245RICAT is a 4" aperture ultra-shallow remodel housing for use with LED integrated trims. Installs from below the ceiling and suitable for 2x4 residential or shallow plenum commercial construction. Suitable for direct contact with insulation and is air tight rated. Use with HALO LT4, RL4, RA4, RSQ4, SMD4, SLD4 LED integrated trims and the ML4 LED modular recessed lighting system.



Special Features

- Slide-N-Side™ junction box
- Quick Connect™ push wire nuts
- Air-Tite™ code compliant

Compatible LED Modules

RA4	LA4	BLD4
RL4	RSQ4	ML4
SLD4	RLD4	
LT4	SMD4	

Features

Housing

- Die formed aluminum housing can be installed from below the ceiling and accommodate ceilings from 3/8" – 3/4" thick.
- Shipped with paint overspray protector installed.

Mounting Springs

- Captive preinstalled mounting springs retain housing securely in ceiling.
- Housing can be removed for service or splice inspection.

Gasket

- Closed cell gaskets achieve restrictive airflow requirements without additional caulking.

Includes:

- Slide-N-Side™ junction box wire traps (Details Pg. 13)
- Quick Connect™ push wire nuts (Details Pg. 13)
- Air-Tite™ code compliant (Details Pg. 13)

LED Module Connection

Compatible Halo LED modules simply install with a plug-in line voltage wiring connector (UL and CSA Listed Luminaire Disconnect). This non-screw base LED connection preserves the high efficacy rating of the luminaire (see also LED Module specifications).

Compliance

- Type IC inherently protected, suitable for direct contact to air permeable insulation and cULus listed for damp locations.
- Not for use in direct contact with spray foam insulation, consult NEMA LSD57-2013.
- Wet location listed in covered ceilings and IP56 certified with select lens trims.
- Airtight per ASTM-E283.
- Can be used for State of California Title 24 high efficacy luminaire compliance with designated integrated LED trims.
- Suitable for use in clothes closets when installed in accordance with the NEC 410.16 spacing requirements.

LED Recessed Housing

H45ICATD010

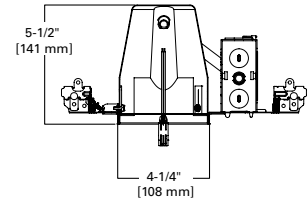
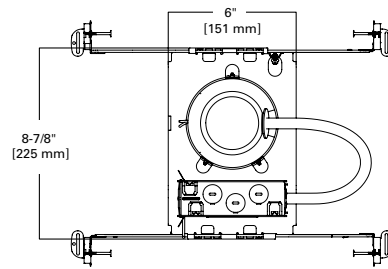

H45ICATD010

4" IC, Air-Tite, Shallow New Construction LED Housing

The H45ICATD010 is a 4" aperture shallow new construction housing for use with LED integrated trims. Installs during electrical rough in 2x6 residential or shallow plenum commercial construction. Suitable for direct contact with insulation and is air tight rated. Use with HALO LT4, RL4, RA4, RSQ4, SMD4, SLD4 LED integrated trims and the ML4 LED modular recessed lighting system.



Special Features

- Got Nail!™ bar hangers
- Pass-N-Thru™ bars
- Slide-N-Side™ junction box
- Quick Connect™ push wire nuts
- Air-Tite™ code compliant

Compatible LED Modules

RA4	LA4	BLD4
RL4	RSQ4	ML4
SLD4	RLD4	
LT4	SMD4	

Features

Housing

- Single wall deep drawn aluminum housing painted matte black for a visually dark interior
- Adjusts vertically to accommodate 1/2" to 1-1/4" thick ceilings and locks in position with (3) set screws
- V notches on plaster lip facilitate use of guide strings or laser lines for precise positioning
- Integral gasket provides for airtight compliance
- Shipped with overspray protector installed
- Housing can be removed from below the ceiling for service or splice inspection

Plaster Frame

- Compact galvanized steel plaster frame with integral bar hanger receivers
- Regressed screw provide positive horizontal bar hanger locking from below the ceiling
- Crimp points also provide for horizontal bar hanger locking

Includes:

- Got Nail!™ bar hangers (Details Pg. 13)
- Pass-N-Thru™ bars (Details Pg. 13)
- Slide-N-Side™ junction box wire traps (Details Pg. 13)
- Quick Connect™ push wire nuts (Details Pg. 13)
- Air-Tite™ code compliant (Details Pg. 13)

LED Module Connection

Compatible Halo LED modules simply install with a plug-in line voltage wiring connector (UL and CSA Listed Luminaire Disconnect). This non-screw base LED connection preserves the high efficacy rating of the luminaire (see also LED Module specifications).

Compliance

- cULus Listed 1598 luminaire
- cULus Listed for damp location
- cULus Listed for wet location, covered ceiling, with select trims
- cULus Listed for feed through

- cULus Listed for direct contact with insulation and combustible material*
- Use with designated Halo LED systems for ENERGY STAR® certification
- Can be used for State of California Title 24 high efficacy compliance with designated Halo LED lighting systems.
- Can be used for International Energy Conservation Code (IECC) high efficacy compliance with designated Halo LED lighting systems.
- Air-Tite code compliant. Certified under ASTM E283; not exceeding 2.0 cfm (0.944 L/s) air leakage rate tested at a 1.57 psf (75 Pa) pressure differential

*Not to be used in direct contact with spray foam insulation (consult NEMA LSD57-2013)

LED Recessed Housing

H45RICATD010

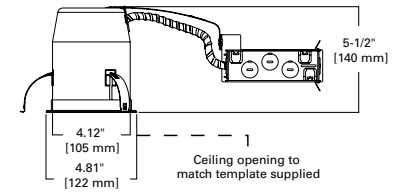
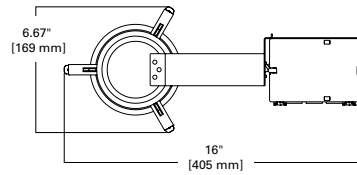

H45RICATD010

4" IC, Air-Tite, Shallow Remodel LED Housing

The H45RICATD010 is a 4" aperture shallow remodel housing for use with LED integrated trims. Installs from below the ceiling and is suitable for 2x6 residential or shallow plenum commercial construction. Suitable for direct contact with insulation and is air tight rated. Use with HALO LT4, RL4, RA4, RSQ4, SMD4, SLD4 LED integrated trims and the ML4 LED modular recessed lighting system.



Special Features

- Slide-N-Side™ junction box
- Quick Connect™ push wire nuts
- Air-Tite™ code compliant

Compatible LED Modules

RA4	LA4	BLD4
RL4	RSQ4	ML4
SLD4	RLD4	
LT4	SMD4	

Features

Housing

- Die formed aluminum housing can be installed from below the ceiling
- Accommodate ceilings from 3/8" to 1-1/4" thick
- Shipped with paint overspray protector installed

Mounting Springs

- Captive preinstalled mounting springs retain housing securely in ceiling.
- Housing can be removed for service or splice inspection.

Gasket

- Closed cell gaskets achieve restrictive airflow requirements without additional caulking.

Includes:

- Slide-N-Side™ junction box wire traps (Details Pg. 13)
- Quick Connect™ push wire nuts (Details Pg. 13)
- Air-Tite™ code compliant (Details Pg. 13)

LED Module Connection

- Two-conductor wire mount connector is rated for 120-277V and mates with Halo® LT4, RL4, RA4 and ML4 family of LED integrated trims.
- CAUTION: verify LED module input voltage is compatible with the input voltage of the housing. If uncertain, consult a qualified electrician
- Separate two-conductor wire mount connector for 0 – 10V low voltage control

Compliance

- Type IC inherently protected, suitable for direct contact to air permeable insulation and cULus listed for damp locations.
- Not for use in direct contact with spray foam insulation, consult NEMA LSD57-2013.
- Wet location listed in covered ceilings and IP56 certified with select lens trims.
- Airtight per ASTM-E283.
- Suitable for use in clothes closets when installed in accordance with the NEC 410.16 spacing requirements
- Contains no mercury or lead and RoHS compliant
- Can be used for State of California Title 24 high efficacy LED compliance under JA8, reference Modernized Appliance Efficiency Database System (MAEDBS) for 2016 JA8 High Efficacy Lighting

LED Recessed Housing

H550ICAT

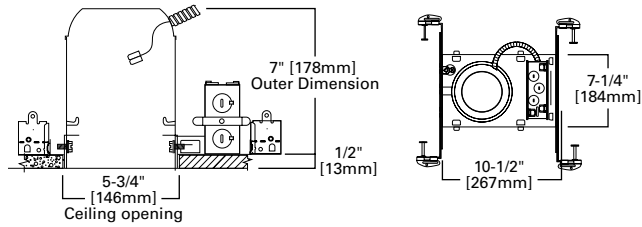

H550ICAT

5" IC, Air-Tite, New Construction, LED Housing

The H550ICAT is a dedicated LED new construction housing to be used with compatible Halo LED modules and trims. The H550ICAT is designed for insulated ceilings and can be in direct contact with ceiling insulation*. This Air-Tite housing design restricts airflow between conditioned spaces and unconditioned areas. The H550ICAT connector system provides high efficacy code compliance when used with a compatible Halo LED lighting systems.



Special Features

- Got Nail!™ bar hangers
- q-Channel bars with Pass-N-Thru™
- Slide-N-Side™ junction box
- Quick Connect™ push wire nuts
- Air-Tite™ code compliant

Compatible LED Lighting Systems

ML56 with 59x Series Trims	
SLD6	LA56
RL56	RSQ5
RA56	BLD6
LT56	SMD6

Features

Housing

- Single wall aluminum housing
- Designed for insulated ceilings in direct contact with insulation* (May also be installed in non-insulated ceilings)

Plaster Frame

- Galvanized steel die-formed construction
- Housing adjusts in plaster frame to accommodate up to 1-3/8" ceiling thickness
- Plaster frame features include:
 - Patented regressed locking screw positioned for securing hanger bars from below the ceiling
 - Cutouts for easily crimping hanger bars in position
 - Air-Tite™ aperture gasket is pre-installed
 - Halo identity embossed on plaster frame

Includes:

- Got Nail!™ bar hangers (Details Pg. 13)
- q-Channel bars with Pass-N-Thru™ (Details Pg. 13)
- Slide-N-Side™ junction box wire traps (Details Pg. 13)
- Quick Connect™ push wire nuts (Details Pg. 13)
- Air-Tite™ code compliant (Details Pg. 13)

LED Module Connection

- Halo LED modules install with a plug-in 120V-277V rated line voltage wiring connector (UL and CSA Listed luminaire disconnect)
- This non-screw base connection preserves the high efficacy rating and prevents use of low efficacy sources (see LED module specifications)
- LED connection is rated for 120V and 277V input. Installer must verify LED module voltage is compatible with the applicable voltage input. If uncertain, consult a qualified electrician.

Compliance

- cULus Listed 1598 luminaire
- cULus Listed for feed through
- cULus Listed for damp location
- cULus Listed for wet location, covered ceiling, with select trims
- cULus Listed for direct contact with insulation and combustible material*
- Air-Tite code compliant. Certified under ASTM E283; not exceeding 2.0 cfm (0.944 L/s) air leakage rate tested at a 1.57 psf (75 Pa) pressure differential.

- Rated for 20W maximum
- Use with designated HALO LED systems for ENERGY STAR® certification
- Can be used for State of California Title 24 high efficacy compliance with Title 20 Certified Halo LED
- Can be used for International Energy Conservation Code (IECC) high efficacy compliance with designated Halo LED modules and trims
- Refer to specification sheets online for additional compliance information
- RoHS compliant

*Not to be used in direct contact with spray foam insulation (Consult NEMA LSD57-2013)

LED Recessed Housing

H550RICAT

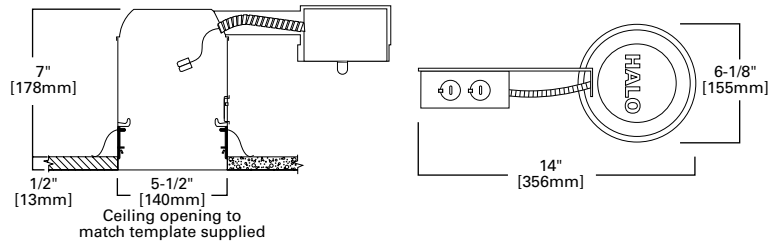

H550RICAT

5" IC, Air-Tite, Remodel, LED Housing

The H550RICAT is a dedicated LED remodel housing to be used with compatible Halo LED modules and trims. The H550RICAT is designed for remodel applications in insulated ceilings and can be in direct contact with ceiling insulation*. This Air-Tite housing design restricts airflow between conditioned spaces and unconditioned areas. The H550RICAT LED connector system provides high efficacy code compliance when used with compatible Halo LED lighting systems.



Special Features

- Quick Connect™ push wire nuts
- Air-Tite™ code compliant

Compatible LED Lighting Systems

- | | |
|----------------------------|------|
| ML56 with 59x Series Trims | |
| SLD6 | LA56 |
| RL56 | RSq5 |
| RA56 | BLD6 |
| LT56 | SMD6 |

Features

Housing

- Single wall aluminum housing
- Designed for insulated ceilings in direct contact with insulation* (May also be installed in non-insulated ceilings)
- For installation from below the finished ceiling Integral flange secures fixture against ceiling
- Halo identity embossed on can top

Junction Box

- Seven 1/2" trade size conduit knockouts with true pry-out slots
- Four type non-metallic (NM) cable pry-outs simplify installation

Includes:

- Quick Connect™ push wire nuts (Details Pg. 13)
- Air-Tite™ code compliant (Details Pg. 13)

Remodel Springs

Four remodel clips secure housing and accommodate 1/2" and 5/8" ceiling material

LED Module Connection

- Halo LED modules install with a plug-in 120V-277V rated line voltage wiring connector (UL and CSA Listed luminaire disconnect)
- This non-screw base connection preserves the high efficacy rating and prevents use of low efficacy sources (See LED module specifications)
- LED connection is rated for 120V and 277V input. Installer must verify LED module voltage is compatible with the applicable voltage input. If uncertain, consult a qualified electrician.

Compliance

- cULus Listed 1598 luminaire
- cULus Listed for feed through
- cULus Listed for damp location
- cULus Listed for wet location with select trims
- cULus Listed for direct contact with insulation and combustible material*
- Air-Tite code compliant. Certified under ASTM E283; not exceeding 2.0 cfm (0.944 L/s) air leakage rate tested at a 1.57 psf (75 Pa) pressure differential.

- Rated for 20W maximum
- Use with designated HALO LED systems for ENERGY STAR® certification
- Can be used for State of California Title 24 high efficacy compliance with Title 20 Certified Halo LED
- Can be used for International Energy Conservation Code (IECC) high efficacy compliance with designated Halo LED modules and trims
- Refer to specification sheets online for additional compliance information
- RoHS compliant

*Not to be used in direct contact with spray foam insulation (Consult NEMA LSD57-2013)

LED Recessed Housing

H750ICAT

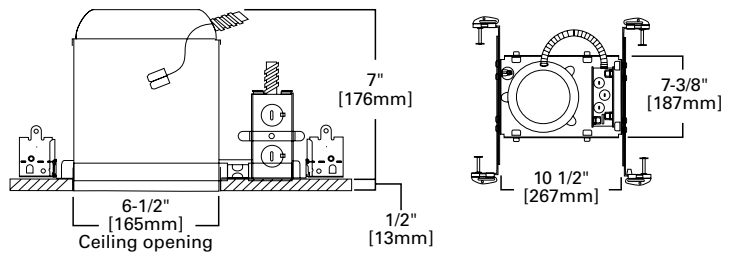

H750ICAT

6" ICAT, Air-Tite, New Construction, LED Housing

The H750ICAT is a LED new construction housing to be used with compatible Halo LED modules and trims. The H750ICAT is designed for insulated ceilings and can be in direct contact with ceiling insulation*. The Air-Tite™ housing design restricts airflow between conditioned spaces and unconditioned areas. The H750ICAT connector system provides high efficacy code compliance when used with a Halo LED lighting systems.



Special Features

- Got Nail!™ bar hangers
- q-Channel bars with Pass-N-Thru™
- Slide-N-Side™ junction box
- Quick Connect™ push wire nuts
- Air-Tite™ code compliant

Compatible LED Modules & Trims

ML56 with 69x series trims	
SLD6	RLD6
RL56	RSQ6
RA56	BLD6
LT56	SMD6
LA56	

Features

Housing

- Single wall aluminum housing
- Openings are gasketed for Air-Tite™ ready installation
- Designed for insulated ceilings in direct contact with insulation* (May also be installed in non-insulated ceilings)

Plaster Frame

- Galvanized steel die-formed construction
- Housing adjusts in plaster frame to accommodate up to 1" ceiling thickness
- Plaster frame features include:
 - Patented regressed locking screw positioned for securing hanger bars from below the ceiling
 - Cutouts for easily crimping hanger bars in position
 - Air-Tite™ aperture gasket is pre-installed
 - Halo identity embossed on plaster frame

Includes:

- Got Nail!™ bar hangers (Details Pg. 13)
- q-Channel bars with Pass-N-Thru™ (Details Pg. 13)
- Slide-N-Side™ junction box wire traps (Details Pg. 13)
- Quick Connect™ push wire nuts (Details Pg. 13)
- Air-Tite™ code compliant (Details Pg. 13)

LED Module Connection

- Halo LED modules install with a plug-in 120V-277V rated line voltage wiring connector (UL and CSA Listed luminaire disconnect)
- This non-screw base connection preserves the high efficacy rating and prevents use of low efficacy sources (See LED module specifications)

Application Note

LED connection is rated for 120V and 277V input. Installer must verify LED module voltage is compatible with the applicable voltage input. If uncertain, consult a qualified electrician.

Compliance

- cULus Listed 1598 luminaire
- cULus Listed damp location
- cULus Listed for wet location, covered ceiling, with select trims
- cULus Listed for feed through
- cULus Listed for direct contact with insulation and combustible material*
- CE Marking - "Conformité Européene" conformity with the Council of European Communities Directives, meeting internationally recognized compliance with used with ML56 series LED modules

- Air-Tite code compliant. Certified under ASTM E283; not exceeding 2.0 cfm (0.944 L/s) air leakage rate tested at a 1.57 psf (75 Pa) pressure differential (with ceiling gasket GA-ATH7-6PK or caulk)
- Rated for 20W maximum
- Use with designated Halo LED systems for ENERGY STAR® certification
- Can be used for State of California Title 24 high efficacy compliance with Title 20 Certified Halo LED
- Can be used for International Energy Conservation Code (IECC) high efficacy compliance with designated LED modules and trims
- Refer to LED module specification sheets online for additional compliance information
- RoHS compliant

*Not to be used in direct contact with spray foam insulation (Consult NEMA LSD57-2013)

LED Recessed Housing

H750RICAT

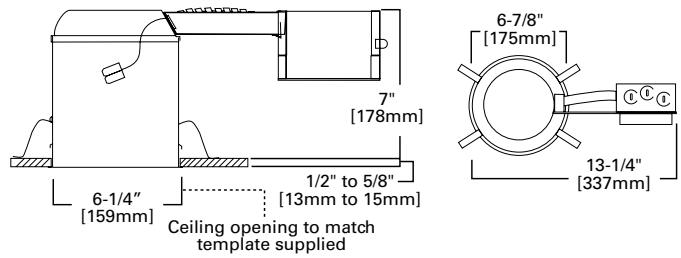

H750RICAT

6" ICAT, Air-Tite, Remodel, LED Housing

The H750RICAT is a LED remodel housing to be used with compatible Halo LED modules and trims. The H750RICAT is designed for remodel applications in insulated ceilings and can be in direct contact with ceiling insulation*. The Air-Tite™ housing design restricts airflow between conditioned spaces and unconditioned areas. The H750RICAT LED connector system provides high efficacy code compliance when used with compatible Halo LED lighting systems.



Special Features

- Slide-N-Side™ junction box
- Quick Connect™ push wire nuts
- Air-Tite™ code compliant

Compatible LED Modules & Trims

ML56 with 69x series trims	
SLD6	RLD6
RL56	RSQ6
RA56	BLD6
LT56	SMD6
LA56	

Features

Housing

- Single wall aluminum housing
- Openings are gasketed for Air-Tite™
- Designed for insulated ceilings in direct contact with insulation* (May also be installed in non-insulated ceilings)
- For installation from below the finished ceiling. Integral flange secures fixture against ceiling.
- Halo identity embossed on can top

Remodel Springs

Four remodel clips secure housing and accommodate 1/2" and 5/8" ceiling material

Includes:

- Slide-N-Side™ junction box wire traps (Details Pg. 13)
- Quick Connect™ push wire nuts (Details Pg. 13)
- Air-Tite™ code compliant (Details Pg. 13)

LED Module Connection

- Halo LED modules install with a plug-in 120V-277V rated line voltage wiring connector (UL and CSA Listed luminaire disconnect)
- This non-screw base connection preserves the high efficacy rating and prevents use of low efficacy sources (See LED module specifications)

Application Note

LED connection is rated for 120V and 277V input. Installer must verify LED module voltage is compatible with the applicable voltage input. If uncertain, consult a qualified electrician.

Compliance

- cULus Listed 1598 luminaire
- cULus Listed damp location
- cULus Listed for wet location, covered ceiling, with select trims
- cULus Listed for feed through
- cULus Listed for direct contact with insulation and combustible material*

- CE Marking - "Conformité Européenne" conformity with the Council of European Communities Directives, meeting internationally recognized compliance with used with ML56 series LED modules
- Air-Tite code compliant. Certified under ASTM E283; not exceeding 2.0 cfm (0.944 L/s) air leakage rate tested at a 1.57 psf (75 Pa) pressure differential.
- Rated for 20W maximum
- Use with designated Halo LED systems for ENERGY STAR® certification
- Can be used for State of California Title 24 high efficacy compliance with Title 20 Certified Halo LED
- Can be used for International Energy Conservation Code (IECC) high efficacy compliance with designated LED modules and trims
- Refer to LED module specification sheets online for additional compliance information
- RoHS compliant

*Not to be used in direct contact with spray foam insulation (Consult NEMA LSD57-2013)

LED Recessed Housing

H750T

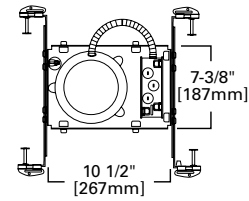
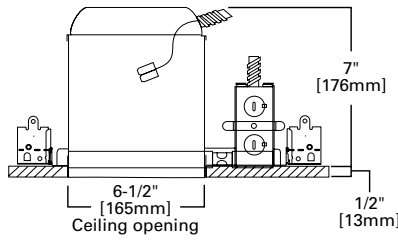

H750T

6" Non-IC, New Construction, LED Housing

The H750T is a LED new construction housing to be used with compatible Halo LED modules and trims. The H750T is designed for non-insulated ceilings. If insulation is present it must be kept three inches from all sides of the housing. The H750T LED connector system provides high efficacy code compliance when used with compatible Halo LED lighting systems.



Special Features

- Got Nail!™ bar hangers
- q-Channel bars with Pass-N-Thru™
- Slide-N-Side™ junction box
- Quick Connect™ push wire nuts

Compatible LED Modules & Trims

ML56 with 69x series trims	
SLD6	RLD6
RL56	RSQ6
RA56	BLD6
LT56	SMD6
LA56	

Features

Housing

- Single wall aluminum housing with white semi-gloss paint finish

Plaster Frame

- Galvanized steel die-formed construction
- Housing adjusts in plaster frame to accommodate up to 1" ceiling thickness
- Plaster frame features include:
 - Patented regressed locking screw positioned for securing hanger bars from below the ceiling
 - Cutouts for easily crimping hanger bars in position
 - Air-Tite™ aperture gasket is pre-installed
 - Halo identity embossed on plaster frame

Includes:

- Got Nail!™ bar hangers (Details Pg. 13)
- q-Channel bars with Pass-N-Thru™ (Details Pg. 13)
- Slide-N-Side™ junction box wire traps (Details Pg. 13)
- Quick Connect™ push wire nuts (Details Pg. 13)

LED Module Connection

- Halo LED modules install with a plug-in 120V-277V rated line voltage wiring connector (UL and CSA Listed luminaire disconnect)
- This non-screw base connection preserves the high efficacy rating and prevents use of low efficacy sources (See LED module specifications)

Application Note

LED connection is rated for 120V and 277V input. Installer must verify LED module voltage is compatible with the applicable voltage input. If uncertain, consult a qualified electrician.

Compliance

- cULus Listed 1598 luminaire
- cULus Listed damp location
- cULus Listed for wet location, covered ceiling, with select trims
- cULus Listed for feed through

- CE Marking - "Conformité Européene" conformity with the Council of European Communities Directives, meeting internationally recognized compliance with used with ML56 series LED modules
- Rated for 20W maximum
- Use with designated Halo LED systems for ENERGY STAR® certification
- Can be used for International Energy Conservation Code (IECC) high efficacy compliance with designated LED modules and trims
- Can be used for State of California Title 24 non-residential high efficacy compliance with Halo LED systems
- Refer to LED module specification sheets online for additional compliance information
- RoHS compliant

LED Recessed Housing

H750TCP

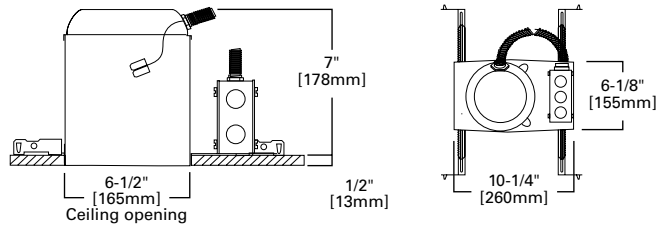

H750TCP

6" Non-IC, New Construction or Remodel, Chicago Plenum, LED Housing

The H750TCP is a LED new construction/remodel Non-IC housing to be used with compatible Halo LED modules and trims. The H750TCP is designed for Chicago Plenum ceilings. Insulation must be kept a minimum of 3" from all sides of housing. The H750TCP LED connector system provides high efficacy code compliance when used with compatible Halo LED lighting systems.



Special Features

Quick Connect™ push wire nuts

Compatible LED Modules & Trims

ML56 with 69x series trims	
SLD6	RLD6
RL56	RSQ6
RA56	BLD6
LT56	SMD6
LA56	

Features

Housing

- Single wall aluminum housing with white semi-gloss paint finish
- Constructed and gasketed to meet Chicago CCEA requirements

Plaster Frame

- "Boat shaped" plaster frame design for new construction or remodel in existing ceilings
- Galvanized steel die-formed construction
- Housing adjusts in plaster frame to accommodate up to 1" ceiling thickness

Bar Hangers

- Bar hangers overlap for housing adjustment within joist spans
- Crimp tabs on plaster frame lock bars into position
- Optional TB-7 T-bar clips secure bar hangers to suspended grid ceilings

Junction Box

- Positioned to accommodate straight conduit runs
- Seven 1/2" trade size conduit knockouts with true pry-out slots

Includes:

- Quick Connect™ push wire nuts (Details Pg. 13)

LED Module Connection

- Halo LED modules install with a plug-in 120V-277V rated line voltage wiring connector (UL and CSA Listed luminaire disconnect)
- This non-screw base connection preserves the high efficacy rating and prevents use of low efficacy sources (see LED module specifications)

Application Note

LED connection is rated for 120V and 277V input. Installer must verify LED module voltage is compatible with the applicable voltage input. If uncertain, consult a qualified electrician.

Compliance

- cULus Listed 1598 luminaire
- cULus Listed damp location
- cULus Listed for wet location, covered ceiling, with select trims
- cULus Listed for feed through
- Rated for 20W maximum
- Use with designated Halo LED systems for ENERGY STAR® certification
- Can be used for International Energy Conservation Code (IECC) high efficacy compliance with designated LED modules and trims
- City of Chicago Plenum construction
- Refer to LED module specification sheets online for additional compliance information

LED Recessed Housing

E750ICAT

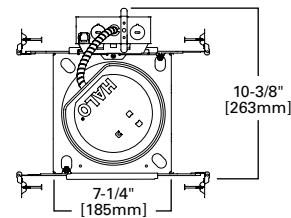
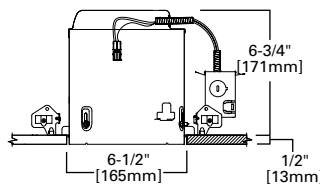

E750ICAT

6" IC, New Construction, LED Housing

Recessed 6" aperture new construction housing for use with LED integrated trims or modules. Suitable for 2x8 residential framing or commercial plenum construction, type IC rated and can be used in direct contact with insulation. Airtight rating reduces airflow between living spaces and unconditioned areas providing additional energy savings. Use with Halo LT56, SMD6, RL56, RA56, SLD6 LED integrated trims and the ML56 LED modular recessed lighting system.



Special Features

- Got Nail!™ bar hangers
- q-Channel bars with Pass-N-Thru™
- Slide-N-Side™ junction box
- Quick Connect™ push wire nuts

Compatible LED Modules & Trims

LT56	RSQ6	ML56 modular lighting system
LA56	SLD6	
RL56	SMD6	
RA56		

Features

Housing

- Single wall precision rolled aluminum housing with interlocking construction maintains concentricity
- Adjusts vertically to accommodate 3/8" to 1" thick ceilings and locks in position with (3) setscrews
- V notches facilitate use of guide strings or laser lines for precise positioning
- Shipped with paint overspray protector installed
- Housing can be removed from below the ceiling for service or splice inspection

Plaster Frame

- Compact galvanized steel plaster frame with integral bar hanger receivers
- (2) regressed screws provide positive horizontal bar hanger locking from below the ceiling
- Integral gasket achieves ASTM-E283 airtight code compliance without additional gaskets or caulk

Junction Box

- Compact galvanized steel junction box with 16in³ internal volume
- Listed for (10) #12 or (14) #14 AWG 90° C splice conductors

- (4) 1/2" conduit pry-outs positioned to allow straight conduit runs
- (3) Slide-N-Side™ non-metallic (NM) wire traps allows wiring outside the box
- Accepts 14-2, 14-3, 12-2, 12-3 U.S. and 14-2, 14-3, 12-2 Canadian NM cable
- (3) 4-port push wire nuts with clear caps for quick and reliable mains voltage connections
- Hinged door with offset cover for easy wire access
- Junction box is repositionable 90° on plaster frame to avoid obstructions

Bar Hangers

- Captive preinstalled All-Nail™ bar hangers support housing at any point along span
- Pass-N-Thru™ feature adjust bars from 7-1/4" to 24" wide without removal
- Score lines allow "tool-less" shortening for 12" joists
- Captive nail penetrates standard and engineered lumber
- Leveling flange aligns plaster frame with framing
- Integral clip attaches directly to tee-bar

Connector

- Two-conductor wire mount connector is rated for 120-277V. CAUTION – verify LED module input voltage is compatible with the input voltage of the housing. If uncertain, consult a qualified electrician
- cULus listed with Halo® LT56, SMD6, RL56, RA56, SLD6 and ML56 family of LED integrated trims

Compliance

- Type IC inherently protected, suitable for direct contact to air permeable insulation and cULus listed for damp locations
- Not for use in direct contact with spray foam insulation, consult NEMA LSD57-2013
- Wet location listed in covered ceilings and IP56 certified with select trims
- Airtight per ASTM-E283
- Can be used for State of California Title 24 high efficacy luminaire compliance
- Suitable for use in clothes closets when installed in accordance with the NEC 410.16 spacing requirements
- Contains no mercury or lead and RoHS compliant

LED Recessed Housing

E750RICAT

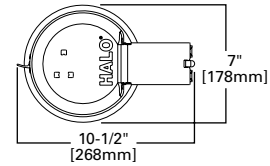
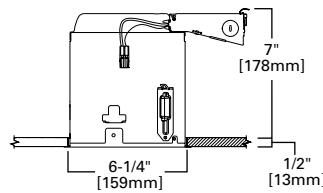

E750RICAT

6" IC, Remodel, LED Housing

Recessed 6" aperture install from below remodeler type housing for use with LED integrated trims or modules. Suitable for 2x8 residential framing or commercial plenum construction, type IC rated and can be used in direct contact with insulation*. Airtight rating reduces airflow between living spaces and unconditioned areas providing additional energy savings. Use with Halo® LT56, SMD6, RL56, RA56, SLD6 LED integrated trims and the ML56 LED modular recessed lighting system.



Special Features

Quick Connect™ push wire nuts

Compatible LED Modules & Trims

LT56	RSQ6	ML56 modular lighting system
LA56	SLD6	
RL56	SMD6	
RA56		

Features

Housing

- Single wall precision rolled aluminum housing maintains concentricity
- Mounting flange secures housing to building structure for below the ceiling installation
- Integral gasket achieves ASTM-E283 airtight code compliance without additional gaskets or caulk
- Shipped with overspray protector installed

Speed Clamps

- (2) exclusive speed clamps adjust to accommodate 3/8" to 2" thick ceilings
- Combination hex, slot and Philips drive screws actuate clamps and speed installation
- Clamps can be loosened from below the ceiling for repositioning or splice inspection

Junction Box

- Integral compact galvanized steel junction box with 10in³ internal volume is attached directly to housing to clear obstructions and fit in tight spaces
- Listed for (6) #12 or (8) #14 AWG 90° C splice conductors

- (3) 1/2" conduit pry-outs positioned to allow straight conduit runs
- (2) Slide-N-Side™ non-metallic (NM) wire traps allows wiring outside the box
- Accepts 14-2, 14-3, 12-2, 12-3 U.S. and 14-2, 14-3, 12-2 Canadian NM cable
- Rotatable wiring tray holds wire nuts captive for one-handed wire termination
- (3) 4-port push wire nuts with clear caps are color coded for quick and reliable mains voltage connections
- Junction box is repositionable 90° on plaster frame to avoid obstructions
- Hinged door for easy wire access

Connector

- Two-conductor wire mount connector is rated for 120-277V. CAUTION – verify LED module input voltage is compatible with the input voltage of the housing. If uncertain, consult a qualified electrician
- cULus listed with Halo® LT56, SMD6, RL56, RA56, SLD6 and ML56 family of LED integrated trims

Compliance

- Type IC inherently protected, suitable for direct contact to air permeable insulation and cULus listed for damp locations
- Not for use in direct contact with spray foam insulation, consult NEMA LSD57-2013
- Wet location listed in covered ceilings and IP56 certified with select trims
- Airtight per ASTM-E283
- Can be used for State of California Title 24 high efficacy luminaire compliance
- Suitable for use in clothes closets when installed in accordance with the NEC 410.16 spacing requirements
- Contains no mercury or lead and RoHS compliant

LED Recessed

LT4 Series

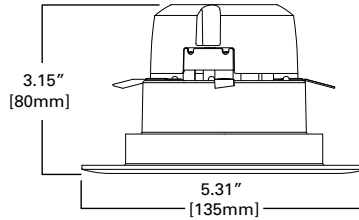

LT4

4" LED Retrofit Module

The Halo LT4 is an LED baffle-trim module for 4" aperture recessed downlights; suitable for new construction, remodel and retrofit installation. The LT4 is UL Certified for use with Halo, and other compatible 4" housings. Precision construction makes any housing Air-Tite for added HVAC savings and code compliance.



LT4 Energy Data

Input Voltage: 120V
Input Current: 0.069A
Input Power: 8.0W
THD: ≤ 24%
Power Factor: ≥ 0.90
T Ambient: -30°C to +40°C
Sound Rating: Class A
(all values at 25° C without a dimming control in circuit)

Features

Mechanical - Module

Module construction includes LED, heat sink, reflector, lens, baffle and trim ring

Lens

- Regressed lens
- Polycarbonate
- Diffusing for even illumination

Mounting

Friction clips are pre-installed and adjust to fit 4" compatible housings

LED

- Correlated Color Temperature (CCT): 2700K, 3000K, 3500K, 4000K, and 5000K
- Color Rendering Index (CRI): 90 (R9 > 50)
- Lumen maintenance L70 at 35,000 hours
- 600 nominal lumen

LED Chromaticity

- LED chromaticity of 4 SDCM exceeds ENERGY STAR® color standards per ANSI C78.377-2008

Electrical Power Connections

- LED connector is a non-screw base luminaire disconnect offering easy installation with the matching Halo 4" LED housings
- LED connector meets California Title 24 high efficacy luminaire requirement for a non-screw base socket, and where required to qualify as a high efficacy luminaire
- The included E26 medium screw base Edison adapter provides easy retrofit of incandescent housings (See housing compatibility)

Ground Connection

Separate grounding cable included on the module for attachment to the housing during installation

LED Driver

- 120V 50/60 Hz constant current dimmable driver provides high-efficiency operation
- If dimming is not required the fixture can be operated from a standard wall switch

Dimming

- Designed for continuous dimming capability to nominally 10% with many 120V Leading Edge (LE) and Trailing Edge (TE) phase control dimmers (Dimmers with low end trim adjustment offer greater assurance of achieving 10% level)
- Consult dimmer manufacturer for compatibility and conditions of use (Note, some dimmers require a neutral in the wallbox)

Compliance

- UL Certified for US and Canada
- UL Certified (with other housings) see specifications
- UL Certified for damp location
- UL Certified for wet location, covered ceiling – (shower rated)
- IP56 Ingress Protection rated
- May be installed in housings in direct contact with insulation* and combustible material
- Air-Tite code compliant. Certified under ASTM E283; not exceeding 2.0 cfm (0.944 L/s) air leakage rate tested at a 1.57 psf (75 Pa) pressure differential.
- 90 CR (R9 > 50): Can be used to comply with California Title 24 high efficacy requirements. Title 20 Certified for residential compliance.
- Can be used for International Energy Conservation Code (IECC) high efficiency luminaire compliance
- ENERGY STAR® certified downlight retrofit
- EMI/RFI per FCC 47CFR Part 15 Class B consumer limits, suitable for use in residential and commercial
- Contains no mercury or lead and RoHS compliant
- Photometric testing in accordance with IES LM-79
- Lumen maintenance projections in accordance with IES LM-80 and TM-21
- Can be used in closets. Compliant with NFPA 70, NEC section 410.16 (A)(1) and 410.16 (C)(3)

*Not to be used in housings in direct contact with spray foam insulation (Consult NEMA LSD57-2013)

LT4 Ordering Information

Models	Finish	Lumen	CRI / CCT	Accessory (Order Separately)
LT460 = 4" Retrofit baffle	WH = matte white baffle	6 = 600 lumen nominal	927 = 90CRI, 2700K 930 = 90CRI, 3000K 935 = 90CRI, 3500K 940 = 90CRI, 4000K 950 = 90CRI, 5000K	HE26LED = Replacement screw base adapter (one included with unit)

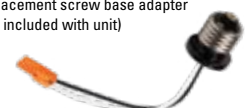

LED Recessed

LT56 Series

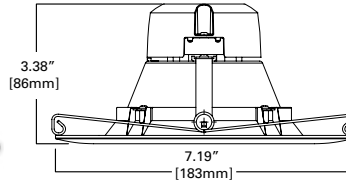

High Lumen

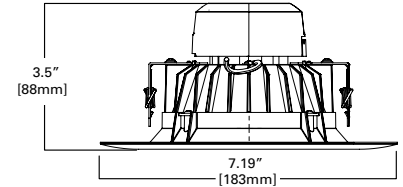

LT560

5" / 6" LED Retrofit Module – 5 Inch Application

The Halo LT560 is an LED baffle-trim module for 5" and 6" aperture recessed downlights; suitable for new construction, remodel and retrofit installation. The LT560 is UL Certified for use with Halo and other compatible 5" and 6" housings. Precision construction makes any housing Air-Tite for added HVAC savings and code compliance.



LT560 Energy Data

	600 Lumen	1200 Lumen
Input Voltage:	120V	120V
Input Current:	0.085A	0.101A
Input Power:	10.2W	11.9W
THD:	≤ 24%	
Power Factor:	≥ 0.90	
T Ambient:	-30°C to +40°C	
Sound Rating:	Class A	

(all values at 25° C without a dimming control in circuit)

Features

Mechanical - Module

Module construction includes LED, heat sink, reflector, lens, baffle and trim ring

Lens

- Regressed lens
- Polycarbonate
- Diffusing for even illumination

Mounting

Torsion springs are pre-installed and adjust to fit 5" and 6" compatible housings

LED

- Correlated Color Temperature (CCT): 2700K, 3000K, 3500K, 4000K, and 5000K
- Color Rendering Index (CRI): 90
- 680 nominal lumen
- Lumen maintenance L70 at 35,000 hours

LED Chromaticity

- A tight chromaticity specification ensures LED color uniformity, sustainable Color Rendering Index (CRI) and Correlated Color Temperature (CCT) over the useful life of the LED
- LED chromaticity of 4 SDCM exceeds ENERGY STAR® color standards per ANSI C78.377-2008
- 90 CRI features high color performance with R9 > 50
- Halo LED serialized testing and measurement ensures color and lumen consistency on a per-unit basis, and validates long-term product consistency over time

Electrical Power Connections

- LED connector is a non-screw base luminaire disconnect offering easy installation with the matching Halo 5" and 6" LED housings
- LED connector meets California Title 24 high efficacy luminaire requirement for a non-screw base socket, and where required to qualify as a high efficacy luminaire
- The included E26 medium screw base Edison adapter provides easy retrofit of incandescent housings (see specifications online for housing compatibility)

Ground Connection

Separate grounding cable included on the module for attachment to the housing during installation

LED Driver

- 120V 50/60 Hz constant current dimmable driver provides high efficiency operation
- If dimming is not required the fixture can be operated from a standard wall switch

Dimming

- Designed for continuous dimming capability to nominally 10% with many 120V Leading Edge (LE) and Trailing Edge (TE) phase control dimmers. Dimmers with low end trim adjustment offer greater assurance of achieving 10% level.
- Consult dimmer manufacturer for compatibility and conditions of use
- Note, some dimmers require a neutral in the wallbox

Compliance

- UL Certified for US and Canada
- UL Certified (with other housings) see specifications online for housing compatibility
- UL Certified for damp location
- UL Certified for wet location, covered ceiling – (Shower Rated)
- IP56 Ingress Protection rated
- May be installed in housings in direct contact with insulation* and combustible material
- Air-Tite code compliant. Certified under ASTM E283; not exceeding 2.0 cfm (0.944 L/s) air leakage rate tested at a 1.57 psf (75 Pa) pressure differential.
- 90 CRI (R9 > 50) can be used to comply with California Title 24 high efficacy requirements. California Title 20 Certified for residential compliance.
- Can be used for International Energy Conservation Code (IECC) high efficiency luminaire compliance
- ENERGY STAR® certified downlight retrofit
- EMI/RFI per FCC 47CFR Part 15 Class B consumer limits, suitable for use in residential and commercial installations
- Contains no mercury or lead and RoHS compliant
- Photometric testing in accordance with IES LM-79
- Lumen maintenance projections in accordance with IES LM-80 and TM-21
- Can be used in closets. Compliant with NFPA 70, NEC section 410.16 (A)(1) and 410.16 (C)(3).

*Not to be used in housings in direct contact with spray foam insulation (Consult NEMA LSD57-2013)

LT560 Ordering Information

Models	Finish	Lumen	CRI / CCT	Accessory (Order Separately)
LT560 = 5"/6" Retrofit baffle	WH = matte white baffle	6 = 600 lumen nominal 12 = 1200 lumen nominal	927 = 90CRI, 2700K 930 = 90CRI, 3000K 935 = 90CRI, 3500K 940 = 90CRI, 4000K 950 = 90CRI, 5000K	HE26LED = Replacement screw base adapter (one included with unit)

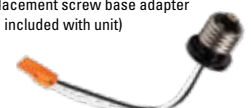

LED Recessed

LA4 Series

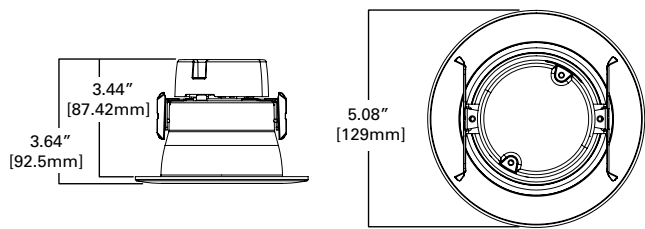

LA4

4" LED All-Purpose Adjustable Gimbal

The Halo LA4 LED Adjustable Downlight series are adjustable LED Modules for 4" aperture recessed downlights. The LA4 gimbals feature adjustment of 35-degree tilt and up to 360-degree rotation. The lens provides uniform illumination and wet location listing. Precision construction makes any housing AIR-TITE for added savings and code compliance.



Features

Mechanical - Module

- Module construction includes LED Array, heat sink, reflector, lens, baffle and trim ring.
- Heat sink designed to conduct heat away from the LED Array, keeping the junction temperatures below specified maximums, even when installed in insulated ceiling environments

Lens

- Regressed lens
- Impact-resistant polycarbonate
- Diffusing for even illumination

LED Array

- Mid power LED array provides a uniform source with high efficiency and no pixilation.
- 90 CRI minimum, R9 greater than 50
- Color accuracy within 3 SDCM provide color accuracy and uniformity.
- Color Temperatures (CCT) available in 2700K, 3000K, 3500K, 4000K, or 5000K

Optical Assembly

- Regressed lens
- Impact-resistant polycarbonate
- Diffuse for even illumination

Driver

- Integral 120V 60 Hz constant current driver provides noise free operation
- Continuous, flicker-free dimming from 100% to 10%.
- Inline electrical quick connect and E26 adapter (provided) provides mains connections
- Consult instruction sheets and for more information

Retention

- Push-N-Twist universal installation clips
- Clips are pre-installed and designed to fit 4" compatible recessed housings

Gaskets

- Closed cell gaskets achieve restrictive airflow requirements without additional caulking

Compliance

- UL Certified
- Wet and Damp location listed.
- Airtight certified per ASTM-E283
- Suitable for use in clothes closets when installed in accordance with the NEC 410.16 spacing requirements
- EMI/RFI emissions per FCC 47CFR Part 15 consumer limits
- Contains no mercury or lead and RoHS compliant
- Photometric testing in accordance with IES LM-79-08

- Lumen maintenance projections in accordance with IES LM-80-08 and TM-21-11
- Can be used for State of California Title 24 high efficacy luminaire compliance. Complies with Title 24 JA8-2016-E.
- Can be used International Energy Conservation Code (IECC) and Washington State Energy Code high efficiency luminaire compliance.
- ENERGY STAR® listed, reference database for current listings

LA4 Energy Data

Input Voltage: 120V
Input Current: 74 (mA)
Input Power: 8.6W
THD: ≤ 20%
Power Factor: ≥ 0.90
T Ambient: -30°C to +40°C
Sound Rating: ≤ 22dba

LA4 Series Ordering Information

Models	Lumens	CRI / CCT	Driver	Finish	Accessory (Order Separately)
LA4 = 4" LED Adjustable Gimbal	06 = 600 lumen (nominal)	927 = 90CRI, 2700K 930 = 90CRI, 3000K 935 = 90CRI, 3500K 940 = 90CRI, 4000K 950 = 90CRI, 5000K	1E = 120V 60Hz leading or trailing edge phase cut 10% dimming	WH = matte white baffle	HE26LED = Replacement screw base adapter (one included with unit)

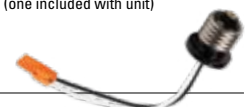

LED Recessed

LA56 Series

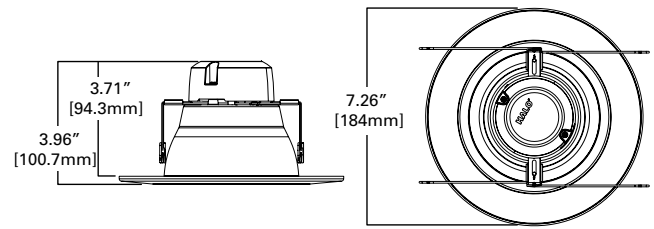

LA56

5" / 6" LED All-Purpose Adjustable Gimbal

The Halo LA56 LED Adjustable Downlight series are adjustable LED Modules for 5" or 6" aperture recessed downlights. The LA56 gimbals feature adjustment of 35-degree tilt and up to 360-degree rotation. The lens provides uniform illumination and wet location listing. Precision construction makes any housing AIR-TITE for added savings and code compliance.



Features

Mechanical - Module

- Module construction includes LED Array, heat sink, reflector, lens, baffle and trim ring.
- Heat sink designed to conduct heat away from the LED Array, keeping the junction temperatures below specified maximums, even when installed in insulated ceiling environments

Lens

- Regressed lens
- Impact-resistant polycarbonate
- Diffusing for even illumination

LED Array

- Mid power LED array provides a uniform source with high efficiency and no pixilation.
- 90 CRI minimum, R9 greater than 50
- Color accuracy within 3 SDCM provide color accuracy and uniformity.
- Color Temperatures (CCT) available in 2700K, 3000K, 3500K, 4000K, or 5000K

Optical Assembly

- Regressed lens
- Impact-resistant polycarbonate
- Diffuse for even illumination

Driver

- Integral 120V 60 Hz constant current driver provides noise free operation
- Continuous, flicker-free dimming from 100% to 10%.
- Inline electrical quick connect and E26 adapter (provided) provides mains connections
- Consult instruction sheets for more information

Retention

- Torsion springs are pre-installed and adjust to fit 5" or 6" compatible housings

Gaskets

- Closed cell gaskets achieve restrictive airflow requirements without additional caulking

Compliance

- UL Certified
- Wet and Damp location listed.
- Airtight certified per ASTM-E283
- Suitable for use in clothes closets when installed in accordance with the NEC 410.16 spacing requirements
- EMI/RFI emissions per FCC 47CFR Part 15 consumer limits
- Contains no mercury or lead and RoHS compliant
- Photometric testing in accordance with IES LM-79-08

- Lumen maintenance projections in accordance with IES LM-80-08 and TM-21-11
- Can be used for State of California Title 24 high efficacy luminaire compliance. Complies with Title 24 JA8-2016-E.
- Can be used International Energy Conservation Code (IECC) and Washington State Energy Code high efficiency luminaire compliance.
- ENERGY STAR® listed, reference database for current listings

LA56 Energy Data

Input Voltage: 120V
Input Current: 74 (mA)
Input Power: 8.6W
THD: ≤ 20%
Power Factor: ≥ 0.90
T Ambient: -30°C to +40°C
Sound Rating: ≤ 22dba

LA56 Series Ordering Information

Models	Lumens	CRI / CCT	Driver	Finish	Accessory (Order Separately)
LA56 = 5"/6" LED Adjustable Gimbal	06 = 600 lumen (nominal)	927 = 90CRI, 2700K 930 = 90CRI, 3000K 935 = 90CRI, 3500K 940 = 90CRI, 4000K 950 = 90CRI, 5000K	1E = 120V 60Hz leading or trailing edge phase cut 10% dimming	WH = matte white baffle	HE26LED = Replacement screw base adapter (one included with unit)



LED Recessed

RL4 - 600 & 900 SeleCCTable Series

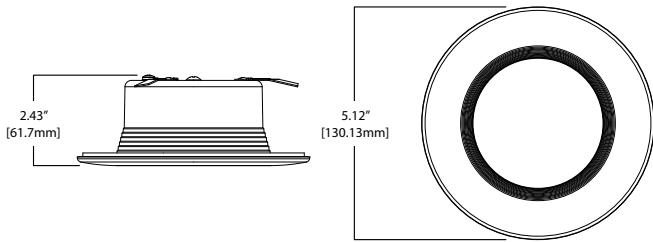

RL4

4" LED All-Purpose Retrofit Module with SeleCCTable switch

The Halo RL4 SeleCCTable™ is a complete LED Baffle-Trim Module for 4-inch aperture recessed downlights; suitable for new construction, remodel and retrofit installation. Using the CCT selectable switch users can choose between five different color temperatures. The lens provides uniform illumination and wet location listing. Precision construction makes any housing AIR-TITE for added savings and code compliance.



Features

CCT Select System

- Use the switch to choose between 2700K, 3000K, 3500K, 4000K, and 5000K CCT.

Module - Trim

- Module construction includes LED array, heat sink, reflector, lens, baffle and trim ring.
- Regressed baffle
- Heat sink designed to conduct heat away from the LED array, keeping the junction temperatures below specified maximums, even when installed in insulated ceiling environments.

LED Array

- Mid power LED array provides a uniform source with high efficiency and no pixilation.
- 90 CRI minimum, R9 greater than 50
- Color accuracy at 4 SDCM in between endpoints, provide color accuracy and uniformity.
- Color Temperature (CCT) has a selectable range from 2700K to 5000K (factory default 3000K)

Optical Assembly

- Regressed lens
- Impact-resistant polycarbonate
- Convex form and lamp-like appearance
- Diffuse for even illumination

Driver

- Integral 120V 60 Hz constant current driver provides noise free operation
- Continuous, flicker-free dimming from 100% to 5%.

- Inline electrical quick connect and E26 adapter (provided) provides mains connections
- See Dimming Guide for compatible dimmers

Retention

- Push-N-Twist universal installation clips
- Clips are pre-installed and designed to fit 4" compatible recessed housings

Designer Trims (Sold Separately)

RL4 skins are accessory rings that attach to the RL4 for a permanent finish. Refer to the RL4 accessories specification sheet for details.

- White (Paintable)
- Satin Nickel
- Tuscan Bronze

Gaskets

- Closed cell gaskets achieve restrictive airflow requirements without additional caulking

Compliance

- UL Certified
- Wet and Damp location listed
- Airtight certified per ASTM-E283
- Suitable for use in clothes closets when installed in accordance with the NEC 410.16 spacing requirements
- EMI/RFI emissions per FCC 47CFR Part 15 consumer limits
- Contains no mercury or lead and RoHS compliant
- Photometric testing in accordance with IES LM-79-08

- Lumen maintenance projections in accordance with IES LM-80-08 and TM-21-11
- Can be used for State of California Title 24 high efficacy luminaire compliance. Complies with Title 24 JA8-2016-E.
- Can be used International Energy Conservation Code (IECC) high efficiency luminaire compliance.
- ENERGY STAR® listed, reference database for current listings

RL4 Energy Data

	RL4069S1EWH	RL4099S1EWH
Lumens	621 @ 4000K	1006 @ 5000K
Voltage	120V	120V
Frequency	50/60 Hz	50/60 Hz
Input Power	7.6W	11.7W
Input Current	0.075A - 0.0875A (Per input power)	0.075A - 0.0875A (Per input power)
Power Factor	>0.90	>0.90
THD	<20%	<20%
EMI/RFI	FCC Title 47 CFR, Part 15, Class B (Consumer)	FCC Title 47 CFR, Part 15, Class B (Consumer)
Sound Rating	Class A	Class A
Minimum Starting Temp.	-30°C (-22°F)	-30°C (-22°F)

RL4 Series Ordering Information

Models	Lumens	CRI / CCT	Driver	Finish	Accessory (Order Separately)
RL4 = 4" All-Purpose Retrofit LED Module	06 = 600 lumens (nominal) 09 = 900 lumens (nominal)	9S = 90 CRI minimum, white tuning, selectable CCT 2700K-5000K	1E = 120V 60Hz leading or trailing edge phase cut 1% dimming	WH = matte white baffle	RL4TRMWHB = 4" White Paintable Trim Ring, Baffle RL4TRMSNB = 4" Satin Nickel Trim Ring, Baffle RL4TRMTBZB = 4" Tuscan Bronze Trim Ring, Baffle RL4TRMWH = 4" White Paintable Trim Ring RL4TRMSN = 4" Satin Nickel Trim Ring RL4TRMTBZ = 4" Tuscan Bronze Trim Ring HE26LED = Replacement screw base adapter (one included with unit)

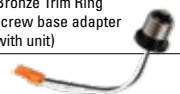

LED Recessed

RL4 Series

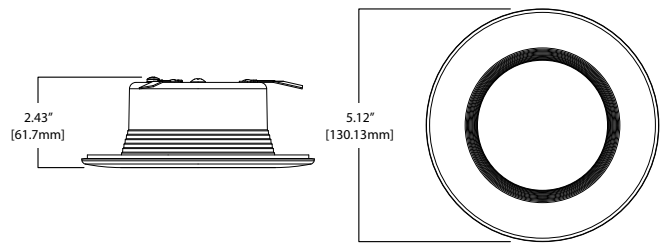

RL4

4" LED All-Purpose Retrofit Module

The Halo RL4 series is a retrofit LED baffle-trim module for 4" aperture recessed downlights. The RL4 is designed for use with compatible 4" housings. The RL4 integral LED driver is dimmable at 120 volts. The RL4 lens provides uniform illumination and wet location listing. Precision construction makes any housing Air-Tite for added HVAC savings and code compliance.



Features

Mechanical Module - Trim

- Module construction includes LED, heat sink, reflector, lens, baffle and trim ring
- Durable aluminum construction
- Regressed baffle
- Heat sink designed to conduct heat away from the LED keeping the junction temperatures below specified maximums, even in insulated ceilings

Designer Trims (Sold Separately)

RL4 designer trims are accessories

- White (paintable)
- Satin nickel
- Tuscan bronze

Lens

- Regressed lens
- Impact-resistant polycarbonate
- Convex form for lamp-like appearance
- High lumen transmission
- Diffusing for even illumination

Mounting

- Push-N-Twist universal installation clips
- Clips are pre-installed and designed to fit 4" compatible recessed housings

LED

- Correlated Color Temperature (CCT): 2700K, 3000K, 3500K, 4000K, and 5000K
- Color Rendering Index (CRI): 90 CRI
- LED is a chip on board design consisting of a multiple LED package with proximity phosphor coating to create one virtual white light source for a productive "cone of light"
- 600 nominal lumens, range dependent on CCT and CRI
- Lumen maintenance L70 at 50,000 hours

LED Driver

- With the latest "driver-on-board" electronic technology, the driver is integrated in the module
- Integral to the housing, 120V 50/60 Hz constant current dimmable driver provides high-efficiency operation
- Driver meets FCC 47CFR Part 15 EMI/RFI consumer limits for use in residential and commercial installations
- Driver features high power factor and low THD and has integral thermal protection in the event of over temperature or internal failure
- If dimming is not required the fixture can be operated from a standard wall switch

Electrical Power Connections

- LED connector is a non-screw base luminaire disconnect offering easy installation with the matching Halo H995 series housings
- LED Connector meets California Title 24 high efficacy luminaire requirement for a non-screw base socket, and to qualify as a high efficacy luminaire
- The included E26 medium screw base Edison adapter provides easy retrofit of incandescent housings
- Separate grounding cable included on the RL4 module for attachment to the housing during installation

Dimming

- Designed for continuous dimming capability to nominally 5% with many 120V Leading Edge (LE) and Trailing Edge (TE) phase control dimmers (Dimmers with low end trim adjustment offer greater assurance of achieving 5% level)
- Consult dimmer manufacturer for compatibility and conditions of use (Note some dimmers require a neutral in the wallbox)

Compliance

- UL Certified for US and Canada
- UL Certified for damp location
- UL Certified for wet location, covered ceiling, shower rated
- IP65 Ingress Protection rated
- May be installed in IC rated housings in direct contact with insulation** and combustible material
- Air-Tite certified per ASTM E283 not exceeding 2.0 CFM under 1.57psf (75 Pascals) pressure difference
- 90 CRI (R9 > 50) can be used to comply with California Title 24 high efficacy requirements. Title 20 Certified for residential compliance.
- 80 CRI can be used to comply with California Title 24 non-residential lighting controls requirements as a LED luminaire
- Can be used for International Energy Conservation Code (IECC) high efficiency luminaire compliance
- ENERGY STAR® certified downlight retrofit
- EMI/RFI per FCC 47CFR Part 15 Class B consumer limits, suitable for use in residential and commercial
- Contains no mercury or lead and RoHS compliant
- Photometric testing in accordance with IES LM-79
- Lumen maintenance projections in accordance with IES LM-80 and TM-21
- Suitable for use in closets. Compliant with NFPA 70, NEC Sec. 410.16 (A)(1) and 410.16 (C)(3)

RL4 Energy Data

RL4 Series (Values at non-dimming line voltage)

Minimum Starting Temp: -30°C (-22°F)

EMI/RFI: FCC Title 47 CFR, Part 15, Class B (Consumer)

Sound Rating: Class A

Input Voltage: 120V

Power Factor: >0.90

Input Frequency: 50/60Hz

THD: <20%

Input Power: 7.3W - 10.0W (per CRI and CCT)

Input Current: 0.075A - 0.0875A (per input power)

RL4 Series Ordering Information

RL4 LED Module

90 CRI

- RL460WH927PK = 4" Retrofit baffle, 2700K, matte white
- RL460WH930PK = 4" Retrofit baffle, 3000K, matte white
- RL460WH935PK = 4" Retrofit baffle, 3500K, matte white
- RL460WH940PK = 4" Retrofit baffle, 4000K, matte white

Accessories (Order Separately)

- RL4TRMWH = 4" White paintable trim ring
- RL4TRMSN = 4" Satin nickel trim ring
- RL4TRMTBZ = 4" Tuscan bronze trim ring
- RL4TRMWHB = 4" White paintable trim ring, baffle
- RL4TRMSNB = 4" Satin nickel trim ring, baffle
- RL4TRMTBZB = 4" Tuscan bronze trim ring, baffle
- HE26LED = Replacement screw base adapter (one included with unit)

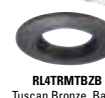

**Not to be used in housings in direct contact with spray foam insulation. (Consult NEMA LSD57-2013)

LED Recessed

RLD4 Series

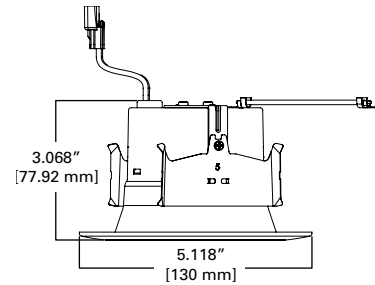

RLD4

4" LED Deep Baffle Retrofit Module

The Halo RL4 Deep Baffle is a complete LED Baffle-Trim Module for 4-inch aperture recessed downlights; suitable for new construction, remodel and retrofit installation. The regressed lens provides uniform illumination and wet location listing. Precision construction makes any housing AIR-TITE for added savings and code compliance.

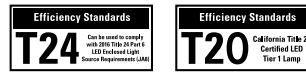

Features

Module - Trim

- Module construction includes LED Array, heat sink, reflector, lens, baffle and trim ring.
- Regressed Coilex baffle
- Heat sink designed to conduct heat away from the LED Array, keeping the junction temperatures below specified maximums, even when installed in insulated ceiling environments.

LED Array

- Mid power LED array provides a uniform source with high efficiency and no pixilation.
- 90 CRI minimum, R9 greater than 50
- Color accuracy within 3 SDCM provide color accuracy and uniformity

Optical Assembly

- Regressed lens
- Impact-resistant polycarbonate
- Convex form and lamp-like appearance
- Diffuse for even illumination

Baffles

- Each unit comes with a white baffle insert and black baffle insert.

Driver

- Integral 120V 50/60 Hz constant current driver provides noise free operation
- Continuous, flicker-free dimming from 100% to 5%.
- Inline electrical quick connect and E26 adapter (provided) provides mains connections
- Consult instruction sheets and quick start guide for more information

Retention

- Precision formed spring blades secure module with friction fit to compatible housings.
- Friction blade design allows the RA4 to be installed in any position within the housing aperture (360 degrees)

Gaskets

- Closed cell gaskets achieve restrictive airflow requirements without additional caulking

Compliance

- UL Certified
- Wet and Damp location listed
- Airtight certified per ASTM-E283
- Suitable for use in clothes closets when installed in accordance with the NEC 410.16 spacing requirements
- EMI/RFI emissions per FCC 47CFR Part 15 consumer limits
- Contains no mercury or lead and RoHS compliant
- Photometric testing in accordance with IES LM-79-08
- Lumen maintenance projections in accordance with IES LM-80-08 and TM-21-11
- Can be used for State of California Title 24 high efficacy luminaire compliance. Complies with Title 24 JA8-2016-E.
- Can be used International Energy Conservation Code (IECC) and Washington State Energy Code high efficiency luminaire compliance.
- ENERGY STAR® listed, reference database for current listings
- Meets State of California voluntary lamp standards
- Lighting Facts labeled

RLD4 Energy Data @ 3000K

Lumens: 681
Input Voltage: 120V
Input Current: 0.073A
Input Power: 8.5W
THD: 17.5%
Frequency: 60 Hz
Efficacy: 80.1 LPW
Power Factor: 0.99
T Ambient: -30°C to +40°C
Sound Rating: Class A

RLD4 Series Ordering Information

Models	Lumens	CRI / CCT	Driver	Finish	Accessory (Order Separately)
RLD4 = 4" deep baffle retrofit LED module	06 = 600 lumens (nominal)	930 = 90 CRI minimum, 3000K CCT	1E = 120V 50/60Hz leading or trailing edge phase cut 1% dimming	WH = matte white trim, white baffle and black baffle included	HE26LED = Replacement screw base adapter (one included with unit)

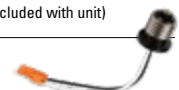

LED Recessed

RL56 - 600, 900 & 1200 SeleCCTable Series



600/900 Lumen

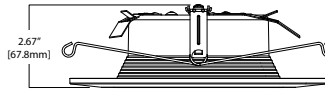

1200 Lumen

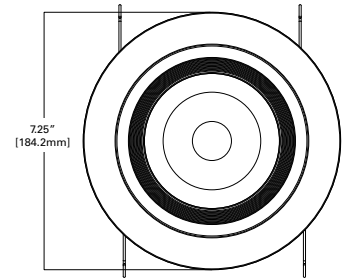
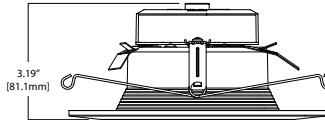

RL56

5" / 6" LED All-Purpose Retrofit Module with SeleCCTable switch

The Halo RL56 SeleCCTable™ is a complete LED Baffle-Trim Module for 5 inch and 6 inch aperture recessed downlights; suitable for new construction, remodel and retrofit installation. Using the CCT selectable switch users can chose between five different color temperatures. The lens provides uniform illumination and wet location listing. Precision construction makes any housing AIR-TITE for added savings and code compliance.



2700K • 3000K • 3500K
4000K • 5000K



Features

CCT Select System

- Use the switch to choose between 2700K, 3000K, 3500K, 4000K, and 5000K CCT.

Module - Trim

- Module construction includes LED array, heat sink, reflector, lens, baffle and trim ring.
- Regressed baffle
- Heat sink designed to conduct heat away from the LED array, keeping the junction temperatures below specified maximums, even when installed in insulated ceiling environments.

LED Array

- Mid power LED array provides a uniform source with high efficiency and no pixilation.
- 90 CRI minimum, R9 greater than 50
- Color accuracy at 4 SDCM in between endpoints, provide color accuracy and uniformity.
- Color Temperature (CCT) has a selectable range from 2700K to 5000K (factory default 3000K)

Optical Assembly

- Regressed lens
- Impact-resistant polycarbonate
- Convex form and lamp-like appearance
- Diffuse for even illumination

Driver

- Integral 120V 60 Hz constant current driver provides noise free operation
- Continuous, flicker-free dimming from 100% to 5%.
- Inline electrical quick connect and E26 adapter (provided) provides mains connections
- See Dimming Guide for compatible dimmers

Retention

- Integral torsion springs and Push-N-Twist clips offer two mounting options
- Torsion springs are pre-installed and adjust to fit 5" or 6" compatible housings
- Push-N-Twist universal installation clips are pre-installed and designed to fit 5" or 6" compatible housings

Designer Trims (Sold Separately)

RL4 skins are accessory rings that attach to the RL4 for a permanent finish. Refer to the RL4 accessories specification sheet for details.

- White (Paintable)
- Satin Nickel
- Tuscan Bronze

Gaskets

- Closed cell gaskets achieve restrictive airflow requirements without additional caulking

Compliance

- UL Certified
- Wet and Damp location listed.
- Airtight certified per ASTM-E283
- Suitable for use in clothes closets when installed in accordance with the NEC 410.16 spacing requirements
- EMI/RFI emissions per FCC 47CFR Part 15 consumer limits
- Contains no mercury or lead and RoHS compliant
- Photometric testing in accordance with IES LM-79-08
- Lumen maintenance projections in accordance with IES LM-80-08 and TM-21-11
- Can be used for State of California Title 24 high efficacy luminaire compliance. Complies with Title 24 JA8-2016-E.
- Can be used International Energy Conservation Code (IECC) high efficiency luminaire compliance.
- ENERGY STAR® listed, reference database for current listings

RL56 Energy Data

	RL56069S1EWH	RL56099S1EWH	RL56129S1EWH
Lumens	721 @ 4000K	1006 @ 4000K	1272 @ 5000K
Input Power	7.6W	12.1W	14W
Voltage	120V		
Frequency	50/60 Hz		
Input Current	0.15 A		
Power Factor	>0.90		
THD	<20%		
EMI/RFI	FCC Title 47 CFR, Part 15, Class B (Consumer)		
Sound Rating	Class A		
Minimum Starting Temp.	-30°C (-22°F)		

RL56 Series Ordering Information

Models	Lumens	CRI / CCT	Driver	Finish	Accessory (Order Separately)
RL56 = 5" / 6" All-Purpose Retrofit LED Module	06 = 600 lumens (nominal) 09 = 900 lumens (nominal) 12 = 1200 lumens (nominal)	9S = 90 CRI minimum, white tuning, selectable CCT 2700K-5000K	1E = 120V 60Hz leading or trailing edge phase cut 1% dimming	WH = matte white baffle	RL56TRMWHB = 5" / 6" White Paintable Trim Ring, Baffle RL56TRMSNB = 5" / 6" Satin Nickel Trim Ring, Baffle RL56TRMTBZB = 5" / 6" Tuscan Bronze Trim Ring, Baffle RL56TRMVH = 5" / 6" White Paintable Trim Ring RL56TRMSN = 5" / 6" Satin Nickel Trim Ring RL56TRMTBZ = 5" / 6" Tuscan Bronze Trim Ring HE26LED = Replacement screw base adapter (one included with unit)

LED Recessed

RL56 - 600, 900 & 1200 Series

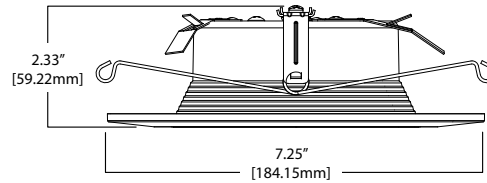

RL560WH6xxx – 600 Series RL560WH9xxx – 900 Series RL560WH12xxx – 1200 Series

5" / 6" LED Retrofit Module

The Halo RL560 is a complete LED baffle-trim module for 5" and 6" aperture recessed downlights; suitable for new construction, remodel and retrofit installation. The RL560 is UL Certified for use with Halo housings and other compatible 5" and 6" housings. The RL560 with integral LED driver offers 120 volt dimming capability. The RL560 lens provides uniform illumination and wet location listing. Precision construction makes any housing Air-Tite code compliant. Compliant with NFPA 70, NEC section 410.16 (A)(1) and 410.16 (C)(3).

90 CRI



Features

Mechanical - Module

- Module construction includes LED, heat sink, reflector, lens, baffle and trim ring
- Trim ring is sized to fit 5" and 6" recessed housings and features a visually appealing graduated step design
- Regressed baffle
- Heat sink designed to conduct heat away from the LED keeping the junction temperatures below specified maximums, even in insulated ceilings
- Durable aluminum construction

Lens

- Regressed lens
- Impact-resistant polycarbonate
- Convex form for lamp-like appearance
- Diffusing for even illumination

Mounting

- Integral torsion springs and Push-N-Twist clips offer two mounting options
 - Torsion springs are pre-installed and adjust to fit 5" or 6" compatible housings
 - Push-N-Twist universal installation clips are pre-installed and designed to fit 5" or 6" compatible housings

LED

- Correlated Color Temperature (CCT): 2700K, 3000K, 3500K, 4000K, and 5000K
- Color Rendering Index (CRI): 90 (See ordering table for available models)
- 600 nominal lumen series, range dependent on CCT and CRI
- 900 nominal lumens, range dependent on CCT and CRI
- Lumen maintenance L70 at 50,000 hours

LED Chromaticity

- A tight chromaticity specification ensures LED color uniformity, sustainable Color Rendering Index (CRI) and Correlated Color Temperature (CCT) over the useful life of the LED
- LED chromaticity of 3 SDCM exceeds ENERGY STAR® color standards per ANSI C78.377-2008
- Every Halo LED is quality tested, measured, and serialized in a permanent record to register lumens, wattage, CRI and CCT

Electrical Power Connections

- LED connector is a non-screw base luminaire disconnect offering easy installation with the matching Halo 5" H550 and 6" H750, H2750 LED housings
- LED connector meets California Title 24 high efficacy luminaire requirement for a non-screw base socket, and where required to qualify as a high efficacy luminaire
- The included E26 medium screw base Edison adapter provides easy retrofit of incandescent housings (see specifications online for housing compatibility)

LED Driver

- With the latest "driver-on-board" electronic technology, the driver is integrated in the module
- 120V 50/60 Hz constant current dimmable driver provides high efficiency operation
- Driver meets FCC 47CFR Part 15 EMI/RFI consumer limits for use in residential and commercial installations
- Driver features high power factor and low THD and has integral thermal protection in the event of over temperature or internal failure
- If dimming is not required the fixture can be operated from a standard wall switch

Dimming

- Designed for continuous dimming capability to nominally 5% with many 120V Leading Edge (LE) and Trailing Edge (TE) phase control dimmers. Dimmers with low end trim adjustment offer greater assurance of achieving 5% level.
- Consult dimmer manufacturer for compatibility and conditions of use
- Note, some dimmers require a neutral in the wallbox

Compliance

- UL Certified for US and Canada
- UL Certified (with other housings) see specifications online for housing compatibility
- UL Certified for damp location
- UL Certified for wet location covered ceiling – shower rated
- IP56 Ingress Protection rated
- May be installed in housings in direct contact with insulation* and combustible material
- Air-Tite code compliant. Certified under ASTM E283; not exceeding 2.0 cfm (0.944 L/s) air leakage rate tested at a 1.57 psf (75 Pa) pressure differential.
- 90 CRI (R9 > 50) can be used to comply with California Title 24 high efficacy requirements. Title 20 Certified for residential compliance.
- Suitable for use in closets. Compliant with NFPA 70, NEC Sec. 410.16 (A)(1) and 410.16 (C)(3).
- ENERGY STAR® certified downlight retrofit
- EMI/RFI per FCC 47CFR Part 15 Class B consumer limits, suitable for use in residential and commercial installations
- Contains no mercury or lead and RoHS compliant
- Photometric testing in accordance with IES LM-79
- Lumen maintenance projections in accordance with IES LM-80 and TM-21

*Not to be used in housings in direct contact with spray foam insulation (Consult NEMA LSD57-2013)

LED Recessed

RL56 - 600, 900 & 1200 Series

RL56 600, 900 & 1200 Series Ordering Information

600 Series - 90 CRI

RL560WH6927 = 5/6" Retrofit baffle, 2700K, matte white
 RL560WH6930 = 5/6" Retrofit baffle, 3000K, matte white
 RL560WH6935 = 5/6" Retrofit baffle, 3500K, matte white
 RL560WH6940 = 5/6" Retrofit baffle, 4000K, matte white
 RL560WH6950 = 5/6" Retrofit baffle, 5000K, matte white

900 Series - 90 CRI

RL560WH9927 = 5/6" Retrofit baffle, 2700K, matte white
 RL560WH9930 = 5/6" Retrofit baffle, 3000K, matte white
 RL560WH9935 = 5/6" Retrofit baffle, 3500K, matte white
 RL560WH9940 = 5/6" Retrofit baffle, 4000K, matte white
 RL560WH9950 = 5/6" Retrofit baffle, 5000K, matte white

1200 Series - 90 CRI

RL560WH12927 = 5/6" Retrofit baffle, 2700K, matte white
 RL560WH12930 = 5/6" Retrofit baffle, 3000K, matte white
 RL560WH12935 = 5/6" Retrofit baffle, 3500K, matte white
 RL560WH12940 = 5/6" Retrofit baffle, 4000K, matte white
 RL560WH12950 = 5/6" Retrofit baffle, 5000K, matte white

Accessories (Order Separately)

Designer Trims

Fit over the RL56 for a designer finish

RL56TRMWH = 5/6" White paintable trim ring
 RL56TRMSN = 5/6" Satin nickel trim ring
 RL56TRMTBZ = 5/6" Tuscan bronze trim ring
 RL56TRMWHB = 5/6" White paintable trim ring, baffle
 RL56TRMSNB = 5/6" Satin nickel trim ring, baffle
 RL56TRMTBZB = 5/6" Tuscan bronze trim ring, baffle

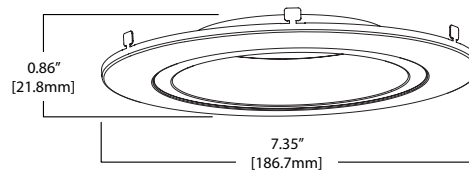

RL56TRMWH
White (Paintable)



RL56TRMTBZ
Tuscan Bronze



RL56TRMSN
Satin Nickel



RL56TRMWHB
White (Paintable) Baffle



RL56TRMTBZB
Tuscan Bronze Baffle



RL56TRMSNB
Satin Nickel Baffle

Oversize Trim Rings

OT400P = Oversize flat white metal trim ring 6" ID x 9-1/4" OD (ring slips behind RL56 ring, in stepped configuration)

OT403P = Oversize white plastic trim ring 6" ID x 8" OD (ring slips behind RL56 ring, in stepped configuration)

TRM690WH = Oversize matte white metal trim ring. Designed for RL56 ring to inset into oversize ring for an even (non-stepped) trim surface



OT400P
Flat White Metal Trim



OT403P
White Plastic Trim



TRM690WH
Matte White Metal Trim

E26 Screw Base Adapter

HE26LED = Replacement screw base adapter (one included with unit)



RL56 Energy Data

600 Series

Minimum Starting Temp: -30°C (-22°F)
 EMI/RFI: FCC Title 47 CFR, Part 15, Class B (Consumer)
 Sound Rating: Class A
 Input Voltage: 120V
 Power Factor: >0.90
 Input Frequency: 60Hz
 THD: <20%
 Input Power: 7.3W – 9.7W (per CRI and CCT)
 Input Current: 0.15A

900 Series

Minimum Starting Temp: -30°C (-22°F)
 EMI/RFI: FCC Title 47 CFR, Part 15, Class B (Consumer)
 Sound Rating: Class A
 Input Voltage: 120V
 Power Factor: >0.90
 Input Frequency: 60Hz
 THD: <20%
 Input Power: 13.5W
 Input Current: 0.15A

1200 Series

Minimum Starting Temp: -30°C (-22°F)
 EMI/RFI: FCC Title 47 CFR, Part 15, Class B (Consumer)
 Sound Rating: Class A
 Input Voltage: 120V
 Power Factor: >0.90
 Input Frequency: 60Hz
 THD: <20%
 Input Power: 17.3W – 18.0W (per CRI and CCT)
 Input Current: 0.15A

Refer to specification online for further information www.cooperlighting.com.

LED Recessed

RLD6 Series

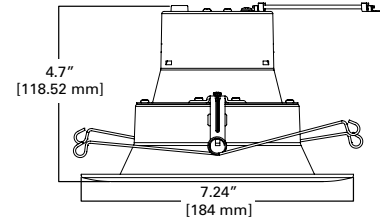

RLD6

6" LED Deep Baffle Retrofit Module

The Halo RL6 Deep Baffle is a complete LED Baffle-Trim Module for 6 inch aperture recessed downlights; suitable for new construction, remodel and retrofit installation. The regressed lens provides uniform illumination and wet location listing. Precision construction makes any housing AIR-TITE for added savings and code compliance.



Features

Module - Trim

- Module construction includes LED Array, heat sink, reflector, lens, baffle and trim ring.
- Regressed Coilex baffle
- Heat sink designed to conduct heat away from the LED Array, keeping the junction temperatures below specified maximums, even when installed in insulated ceiling environments.

LED Array

- Mid power LED array provides a uniform source with high efficiency and no pixilation.
- 90 CRI minimum, R9 greater than 50
- Color accuracy within 3 SDCM provide color accuracy and uniformity

Optical Assembly

- Regressed lens
- Impact-resistant polycarbonate
- Convex form and lamp-like appearance
- Diffuse for even illumination

Baffles

- Each unit comes with a white baffle insert and black baffle insert.

Driver

- Integral 120V 50/60 Hz constant current driver provides noise free operation
- In the mobile app, continuous, flicker-free dimming from 100% to 5%.

- Inline electrical quick connect and E26 adapter (provided) provides mains connections
- Consult instruction sheets and quick start guide for more information

Retention

- Torsion Springs**
- Integral torsion springs offer two mounting options
 - Torsion springs are pre-installed and adjust to fit 5" or 6" compatible housings
- Friction Blades**
- Provide alternative to torsion springs for retrofit in 5" and 6" housings without torsion spring mounting tabs.
 - Friction blade design allows the RL560 to be installed in any position within the housing aperture (360 degrees).

Gaskets

- Closed cell gaskets achieve restrictive airflow requirements without additional caulking

Compliance

- UL Certified
- Wet and Damp location listed.
- Airtight certified per ASTM-E283
- Suitable for use in clothes closets when installed in accordance with the NEC 410.16 spacing requirements
- EMI/RFI emissions per FCC 47CFR Part 15 consumer limits
- Contains no mercury or lead and RoHS compliant
- Photometric testing in accordance with IES LM-79-08

- Lumen maintenance projections in accordance with IES LM-80-08 and TM-21-11
- Can be used for State of California Title 24 high efficacy luminaire compliance. Complies with Title 24 JA8-2016-E.
- Can be used International Energy Conservation Code (IECC) and Washington State Energy Code high efficiency luminaire compliance.
- ENERGY STAR® listed, reference database for current listings
- Meets State of California voluntary lamp standards
- Lighting Facts labeled

RLD6 Energy Data @ 3000K

Lumens: 668
Input Voltage: 120V
Input Current: 0.073A
Input Power: 8.5W
THD: 17.5%
Frequency: 60 Hz
Efficacy: 78.6 LPW
Power Factor: 0.99
T Ambient: -30°C to +40°C
Sound Rating: Class A

RLD6 Series Ordering Information

Models	Lumens	CRI / CCT	Driver	Finish	Accessory (Order Separately)
RLD6 = 6" deep baffle retrofit LED module	06 = 600 lumens (nominal)	930 = 90 CRI minimum, 3000K CCT	1E = 120V 50/60Hz leading or trailing edge phase cut 1% dimming	WH = matte white trim, white baffle and black baffle included	HE26LED = Replacement screw base adapter (one included with unit)

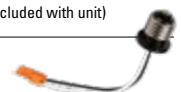

LED Recessed

RA4 SeleCCTable Series

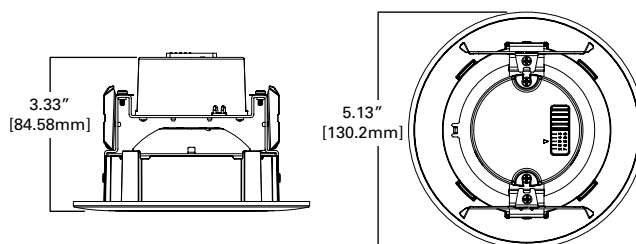

RA4

4" LED All-Purpose Retrofit Module with SeleCCTable switch

The Halo RA4 SeleCCTable™ LED Adjustable Gimbal is a complete LED Baffle-Trim Module for 4-Inch aperture recessed downlights. It is suitable for new construction, remodel and retrofit installation. Using the CCT selectable switch users can choose between five different color temperatures. The RA4 SeleCCTable Gimbals feature adjustment of 35-degree tilt and up to 360-degree rotation.



2700K • 3000K • 3500K
4000K • 5000K

Features

CCT Select System

- Use the switch to choose between 2700K, 3000K, 3500K, 4000K, and 5000K CCT.

Module - Trim

- Module construction includes LED array, heat sink, reflector, lens, baffle and trim ring.
- Regressed baffle
- Heat sink designed to conduct heat away from the LED array, keeping the junction temperatures below specified maximums, even when installed in insulated ceiling environments.
- Up to 360-degree rotation
- 35-degree tilt
- Halo matte white paint finish

LED Array

- Mid power LED array provides a uniform source with high efficiency and no pixilation.
- 90 CRI minimum, R9 greater than 50
- Color accuracy at 4 SDCM in between endpoints, provide color accuracy and uniformity.
- Color Temperature (CCT) has a selectable range from 2700K to 5000K (factory default 3000K)

Optical Assembly

- Regressed lens
- Impact-resistant polycarbonate
- Convex form and lamp-like appearance
- Diffuse for even illumination

Driver

- Integral 120V 60 Hz constant current driver provides noise free operation
- Continuous, flicker-free dimming from 100% to 5%.
- Inline electrical quick connect and E26 adapter (provided) provides mains connections
- See Dimming Guide for compatible dimmers

Retention

- Precision formed spring blades secure module with friction fit to compatible housings.
- Friction blade design allows the RA4 to be installed in any position within the housing aperture (360 degrees)

Gaskets

- Closed cell gaskets achieve restrictive airflow requirements without additional caulking

Compliance

- UL Certified
- Damp location listed
- EMI/RFI emissions per FCC 47CFR Part 15 consumer limits
- Contains no mercury or lead and RoHS compliant
- Photometric testing in accordance with IES LM-79-08
- Lumen maintenance projections in accordance with IES LM-80-08 and TM-21-11
- Can be used for State of California Title 24 high efficacy luminaire compliance. Complies with Title 24 JA8-2016-E.
- Can be used International Energy Conservation Code (IECC) high efficiency luminaire compliance.
- ENERGY STAR® listed, reference database for current listings

RA4 Energy Data @ 3000K

Lumens: 600 Series

Input Voltage: 120V

Input Current: .065 (mA)

Input Power: 7.0W

Efficiency: 87.9%

Inrush (A): .51

THD: ≤ 20%

Power Factor: ≥ 0.90

T Ambient: -30°C to +40°C

Sound Rating: ≤ 22dba

RA4 Series Ordering Information

Models	Lumens	CRI / CCT	Driver	Finish	Accessory (Order Separately)
RA4 = 4" LED adjustable gimbal	06 = 600 lumens (nominal)	9S = 90 CRI minimum, white tuning, selectable CCT 2700K-5000K	1E = 120V 60Hz leading or trailing edge phase cut 1% dimming	WH = matte white baffle	HE26LED = Replacement screw base adapter (one included with unit)

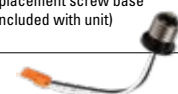

LED Recessed

RA4 Series

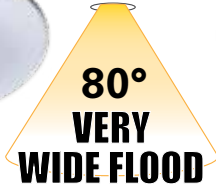

RA4 (VWFL)



RA4 (NFL)

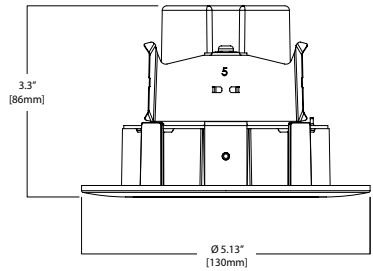

4" Adjustable Gimbals All-Purpose LED Retrofit Modules

The Halo RA4 LED adjustable gimbal series are retrofit LED modules for 4" aperture recessed downlights. The RA4 gimbals feature adjustment of 35-degree tilt and up to 360-degree rotation. In addition the RA4 gimbals offer selection of narrow flood (NFL) and very wide flood (VWFL) models for beam distributions suitable for accent, task, grazing and general area lighting. The RA4 integral LED 120V driver is dimmable with most leading edge and trailing edge phase control dimmers.



Features

Mechanical Module - Trim

- Module includes LED, heat sink, reflector, lens optic, baffle reveal, and trim ring
- Durable die-cast aluminum construction
- Integrated heat sink design conducts heat away from the LED keeping the junction temperatures below specified maximums, even in insulated ceilings
- Halo matte white paint finish
- 35-degree tilt
- Up to 360-degree rotation

Optics - Narrow Flood (NFL)

- Precision acrylic lens
- Optical design creates a clean, uniform 25-degree beam distribution

Optics - Very Wide Flood (VWFL)

- Impact-resistant polycarbonate
- Convex form for lamp-like appearance
- Diffusing, wide beam for even illumination

Mounting - Friction Blades

- Friction formed spring blades secure module with friction fit to compatible housings
- Friction blade design allows the RA4 to be installed in any position within the housing aperture (360 degrees)

LED

- Correlated Color Temperature (CCT): 2700K, 3000K
- Color Rendering Index (CRI): 90 CRI (R9 > 50)
- LED is a chip on board design consisting of a multiple LED package with proximity phosphor coating to create one virtual white light source for a productive "cone of light"

- 600 nominal lumens, range dependent on CCT and optic
- Lumen maintenance L70 at 50,000 hours

LED Driver

- Dimmable driver is a 120 Volt, high efficiency, electronic power supply providing DC power to the LED
- Driver meets FCC 47CFR Part 15 EMI/RFI consumer level limits for use in residential and commercial installations
- Driver features high power factor, low THD, and has integral thermal protection in the event of over temperature or internal failure
- If dimming is not required the fixture can be operated from a standard wall switch

Electrical Power Connections

- LED connector is a non-screw base luminaire disconnect offering easy installation with the matching Halo H995 series housings
- LED connector meets high efficacy luminaire requirements for a non-screw base socket, and to qualify as a high efficacy luminaire (California Title 24)
- The included E26 medium screw base Edison adapter provides easy retrofit of incandescent housings
- Separate grounding cable included on the module for attachment to the housing during installation

Dimming

- The Halo RA4 LED is designed for dimming capability to nominally 5% with many standard 120V leading edge (LE) and trailing edge (TE) phase control dimmers
- Dimming to 5% is best assured using dimmers with low end trim adjustment
- Consult dimmer manufacturer for dimmer details (Note, some dimmers require a neutral in the wallbox)

Compliance

- UL Certified for US and Canada
- UL Certified (with other housings - see specification sheet online)
- UL Certified for damp location
- May be installed in housings in direct contact with insulation** and combustible material
- IP ingress protection rating
 - NFL models: IP25
 - VWFL models: IP34
- ENERGY STAR® certified downlight retrofit
- Can be used for State of California Title 24 high efficacy requirements. Title 20 Certified for residential compliance.
- Can be used for International Energy Conservation Code (IECC) high efficacy luminaire compliance
- EMI/RFI per FCC 47CFR Part 15 Class B consumer limits, suitable for use in residential and commercial
- Contains no mercury or lead and RoHS compliant
- Photometric testing in accordance with IES LM-79
- Lumen maintenance projections in accordance with IES LM-80 and TM-21

RA4 Energy Data

RA4 Series (Values at non-dimming line voltage)

Minimum Starting Temp: -30°C (-22°F)

EMI/RFI: FCC Title 47 CFR, Part 15, Class B (Consumer)

Sound Rating: Class A standards

Input Voltage: 120V

Power Factor: >0.90

Input Frequency: 50/60Hz

THD: <20%

Input Power: 10W

Input Current: 85mA

Driver-Safety Agency Approvals:

- UL60950-1 Recognized
- LPS output
- UL8750 Compliant

RA4 Series Ordering Information

RA4 LED Adjustable Gimbal

Very Wide Flood - VWFL Models

- RA406927VWH = 4" LED adjustable gimbal, 90 CRI, 2700K, matte white
- RA406930VWH = 4" LED adjustable gimbal, 90 CRI, 3000K, matte white

Narrow Flood - NFL Models

- RA406927NFLWH = 4" LED adjustable gimbal, 90 CRI, 2700K, matte white
- RA406930NFLWH = 4" LED adjustable gimbal, 90 CRI, 3000K, matte white

Accessories (Order Separately)

- HE26LED = Replacement screw base adapter (one included with unit)



**Not to be used in housings in direct contact with spray foam insulation. (Consult NEMA LSD57-2013)

LED Recessed

RA56 SeleCCTable Series

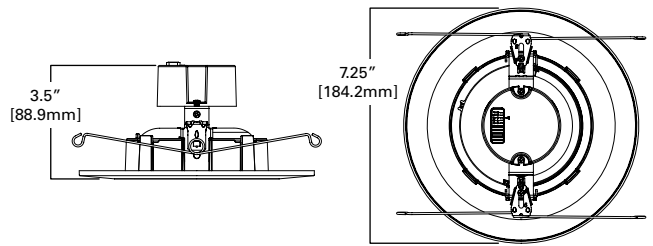

RA56

5" / 6" LED All-Purpose Retrofit Module with SeleCCTable switch

The Halo RA56 SeleCCTable™ LED Adjustable Gimbal is a complete LED Baffle-Trim Module for 5-Inch or 6-Inch aperture recessed downlights. It is suitable for new construction, remodel and retrofit installation. Using the CCT selectable switch users can choose between five different color temperatures. The RA56 SeleCCTable Gimbals feature adjustment of 35-degree tilt and up to 360-degree rotation.



2700K • 3000K • 3500K
4000K • 5000K

Features

CCT Select System

- Use the switch to choose between 2700K, 3000K, 3500K, 4000K, and 5000K CCT.

Module - Trim

- Module construction includes LED array, heat sink, reflector, lens, baffle and trim ring.
- Regressed baffle
- Heat sink designed to conduct heat away from the LED array, keeping the junction temperatures below specified maximums, even when installed in insulated ceiling environments.
- Up to 360-degree rotation
- 35-degree tilt
- Halo matte white paint finish

LED Array

- Mid power LED array provides a uniform source with high efficiency and no pixilation.
- 90 CRI minimum, R9 greater than 50
- Color accuracy at 4 SDCM in between endpoints, provide color accuracy and uniformity.
- Color Temperature (CCT) has a selectable range from 2700K to 5000K (factory default 3000K)

Optical Assembly

- Regressed lens
- Impact-resistant polycarbonate
- Convex form and lamp-like appearance
- Diffuse for even illumination

Driver

- Integral 120V 60 Hz constant current driver provides noise free operation
- Continuous, flicker-free dimming from 100% to 5%.
- Inline electrical quick connect and E26 adapter (provided) provides mains connections
- See Dimming Guide for compatible dimmers

Retention

- Integral torsion springs and Push-N-Twist clips offer two mounting options
- Torsion springs are pre-installed and adjust to fit 5" or 6" compatible housings
- Push-N-Twist universal installation clips are pre-installed and designed to fit 5" or 6" compatible housings

Gaskets

- Closed cell gaskets achieve restrictive airflow requirements without additional caulking

Compliance

- UL Certified
- Damp location listed.
- EMI/RFI emissions per FCC 47CFR Part 15 consumer limits
- Contains no mercury or lead and RoHS compliant
- Photometric testing in accordance with IES LM-79-08
- Lumen maintenance projections in accordance with IES LM-80-08 and TM-21-11
- Can be used for State of California Title 24 high efficacy luminaire compliance. Complies with Title 24 JA8-2016-E.
- Can be used International Energy Conservation Code (IECC) high efficiency luminaire compliance.
- ENERGY STAR® listed, reference database for current listings

RA56 Energy Data @ 3000K

Lumens: 600 Series
Input Voltage: 120V
Input Current: .065 (mA)
Input Power: 7.0W
Efficiency: 90%
Inrush (A): .91
THD: ≤ 20%
Power Factor: ≥ 0.90
T Ambient: -30°C to +40°C
Sound Rating: ≤ 20dba

RA56 Series Ordering Information

Models	Lumens	CRI / CCT	Driver	Finish	Accessory (Order Separately)
RA56 = 5" / 6" LED adjustable gimbal	06 = 600 lumens (nominal)	9S = 90 CRI minimum, white tuning, selectable CCT 2700K-5000K	1E = 120V 60Hz leading or trailing edge phase cut 1% dimming	WH = matte white baffle	HE26LED = Replacement screw base adapter (one included with unit)

LED Recessed

RA56 Series



RA56069xxNFLWH



RA56069xxWH

5"/6" LED Adjustable Gimbal – 5 Inch Application

The Halo RA56 LED adjustable gimbal series are retrofit LED modules for 5" and 6" aperture recessed downlights; suitable for new construction, retrofit and remodel. The RA56 gimbals feature adjustment of 35-degree tilt and up to 360-degree rotation. In addition the RA56 gimbals offer selection of narrow flood (NFL) and very wide flood (VWFL) models for beam distributions suitable for accent, task, grazing and general area lighting.

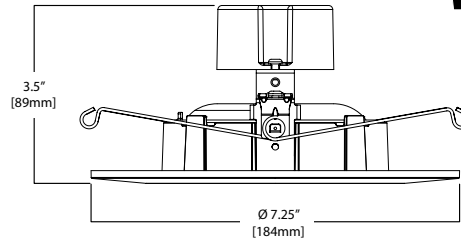

Features

Mechanical - Module

- Module includes LED, heat sink, reflector, lens optic, baffle reveal, and trim ring
- Trim ring is sized to fit 5" and 6" recessed housing openings, and features a visually appealing graduated step design
- Durable die-cast aluminum construction
- Integrated heat sink design conducts heat away from the LED keeping the junction temperatures below specified maximums, even in insulated ceilings
- 35-degree tilt
- Pre-installed torsion spring adjust to fit 5" or 6" compatible housings
- Up to 360-degree rotation

Narrow Flood (NFL) Optics

- Precision acrylic lens
- Optical design creates a clean, uniform 25-degree beam

Very Wide Flood (VWFL) Optics

- Impact-resistant polycarbonate
- Convex form for lamp-like appearance
- Diffusing, wide beam for even illumination

LED Chromaticity

- A tight chromaticity specification ensures LED color uniformity, sustainable Color Rendering Index (CRI) and Correlated Color Temperature (CCT) over the useful life of the LED
- LED chromaticity of 3 SDCM exceeds ENERGY STAR® color standards per ANSI C78.377-2008
- Every Halo LED is quality tested, measured, and serialized in a permanent record to register lumens, wattage, CRI and CCT

LED

- Correlated Color Temperature (CCT): 2700K, 3000K
- Color Rendering Index (CRI): 90
- LED is a chip on board design consisting of a multiple LED package with proximity phosphor coating to create one virtual white light source for a productive "cone of light"
- 650 nominal lumens, range dependent on CCT and optic
- Lumen maintenance L70 at 50,000 hours

Electrical Power Connections

- LED connector is a non-screw base luminaire disconnect offering easy installation with the matching Halo 5" H550 and 6" H750, H2750 LED housings
- LED connector meets California Title 24 high efficacy luminaire requirement for a non-screw base socket, and where required to qualify as a high efficacy luminaire
- The included E26 medium screw base Edison adapter provides easy retrofit of incandescent housings (See specifications online for housing compatibility)

LED Driver

- Dimmable driver is a 120 Volt, high efficiency, electronic power supply providing DC power to the LED
- Driver meets FCC EMI/RFI Consumer Level limits for use in residential and commercial installations
- Driver features high power factor, low THD, and has integral thermal protection in the event of over temperature or internal failure
- If dimming is not required the fixture can be operated from a standard wall switch

Dimming

- Designed for continuous dimming capability to nominally 5% with many 120V Leading Edge (LE) and Trailing Edge (TE) phase control dimmers (Dimmers with low end trim adjustment offer greater assurance of achieving 5% level)
- Consult dimmer manufacturer for compatibility and conditions of use
- Note: some dimmers require a neutral in the wallbox

Compliance

- UL Certified for US and Canada
- UL Certified (with other housings) see specifications online for housing compatibility
- UL Certified for damp location
- May be installed in housings in direct contact with insulation* and combustible material
- Air-Tite code compliant. Certified under ASTM E283; not exceeding 2.0 cfm (0.944 L/s) air leakage rate tested at a 1.57 psf (75 Pa) pressure differential.
- 90 CRI (R9 > 50) can be used to comply with California Title 24 high efficacy requirements. Title 20 Certified for residential compliance.
- Suitable for use in closets. Compliant with NFPA 70, NEC Sec. 410.16 (A)(1) and 410.16 (C)(3).
- ENERGY STAR® certified downlight retrofit
- EMI/RFI per FCC 47CFR Part 15 Class B consumer limits, suitable for use in residential and commercial installations
- Contains no mercury or lead and RoHS compliant
- Photometric testing in accordance with IES LM-79
- Lumen maintenance projections in accordance with IES LM-80 and TM-21

*Not to be used in housings in direct contact with spray foam insulation (Consult NEMA LSD57-2013)

LED Recessed

RA56 Series

RA56 Series Ordering Information

Very Wide Flood - VWFL Models

RA5606927WH = 5/8" Adjustable gimbal, 90 CRI, 2700K, matte white, very wide flood
RA5606930WH = 5/8" Adjustable gimbal, 90 CRI, 3000K, matte white, very wide flood

Narrow Flood - NFL Models

RA5606927NFLWH = 5/8" Adjustable gimbal, 90 CRI, 2700K, matte white, narrow flood
RA5606930NFLWH = 5/8" Adjustable gimbal, 90 CRI, 3000K, matte white, narrow flood

Accessories (Order Separately)

Oversize Trim Rings

OT400P = Oversize flat white metal trim ring 6" ID x 9-1/4" OD (ring slips behind RA56 ring, in stepped configuration)

OT403P = Oversize white plastic trim ring 6" ID x 8" OD (ring slips behind RA56 ring, in stepped configuration)

TRM690WH = Oversize matte white metal trim ring. Designed for RA56 ring to inset into oversize ring for an even (non-stepped) trim surface



OT400P
Flat White Metal Trim



OT403P
White Plastic Trim



TRM690WH
Matte White Metal Trim

Replacement Friction Clips

RL56CLIP = Replacement kit of 5" and 6" friction clips for retrofitting into an existing housing without torsion spring receiving brackets (One set of clips included with the unit)

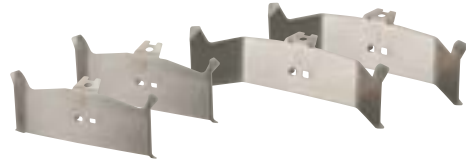

E26 Screw Base Adapter

HE26LED = Replacement screw base adapter (One included with unit)



RA56 Energy Data

Minimum Starting Temp: -30°C (-22°F)

EMI/RFI: FCC Title 47 CFR, Part 15, Class B (Consumer)

Sound Rating: Class A standards

Input Voltage: 120V

Power Factor: >0.90

Input Frequency: 50/60Hz

THD: <20%

Input Power: 10W

Input Current: 85mA

Driver-Safety Agency Approvals:

- UL60950-1 Recognized

- LPS output

- UL8750 Compliant

Refer to specification online for further information www.cooperlighting.com.



LED Recessed

RSQ4 Series

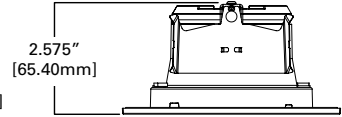
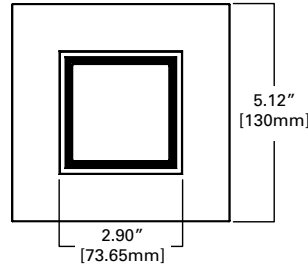

RSQ4

4" LED All-Purpose Square Retrofit Module

The RSQ4 is an integrated LED module / trim with a square shallow lens suitable for new construction, remodel and retrofit installation. Certified for use with Halo and compatible 4" housings and can be used with housings in direct contact with insulation. Integral gasket provides airtight compliance in non-airtight housings, provides code compliance and additional energy savings. Use for general area lighting in low to medium height ceilings where energy savings and long life are desired.



2700K • 3000K • 3500K
4000K • 5000K

Features

Module - Trim

- Module / trim is field interchangeable and upgradable, LED module consists of LED array, optical assembly, driver and self-flanged trim
- Integral aluminum heat sink provides passive thermal cooling achieving L70 at 70,000 hours in IC and non-IC applications.

LED Array

- Plurality of mid-power LEDs provide a uniform source with high efficiency and long life
- Available in 90 CRI minimum, R9 greater than 50 and color accuracy within 4 SDCM provides color accuracy and uniformity
- Available in 2700, 3000, 3500 and 4000 K fixed CCT
- Optional field selectable color temperature, select from 2700, 3000, 3500, 4000 and 5000 K CCT

Optical Assembly

- Precision molded optic organizes source flux into wide distribution, useful for general area lighting
- Regressed flat lens provides uniformity
- Meets Energy Star color angular uniformity requirements, color deviation is less than 0.006 u' v

Connectors

- Two-conductor wire mount CJT type connector is rated for 120V and mates with LED housings or E26 adapter (provided)

Driver

- Standard 1E constant current driver option with 120V 60 Hz input provides quiet operation

- Leading or trailing edge phase cut dimming to 5% with select controls, meets CA T24 flicker requirements

Retention

- Stainless steel friction blades hold module securely in the housing
- Can be installed in any orientation allowing trim to be aligned with architecture
- Module / trim can be removed from below the aperture for service or replacement

Trim

- Die cast aluminum trim can be removed in the field and replaced with optional designer series trims to match many décors
- Step baffle provides additional cutoff to source

Gaskets

- Closed cell gaskets achieve restrictive airflow requirements without additional caulking

Compliance

- UL Certified Safety, US & CA when used with Halo and other's housings, see instruction sheet for conditions of acceptability
- Wet location listed and IP44 ingress protection rated, covered ceiling only
- Airtight per ASTM-E283-04
- Suitable for use in clothes closets when installed in accordance with the NEC 410.16 spacing requirements
- EMI/RFI emissions per FCC 47CFR Part 15 consumer limits

- Contains no mercury or lead and RoHS compliant
- Photometric testing in accordance with IES LM-79-08
- Lumen maintenance projections in accordance with IES LM-80-08 and TM-21-11
- Can be used for State of California Title 24 high efficacy LED compliance under JA8, reference Modernized Appliance Efficiency Database System (MAEDBS) for 2016 JA8 High Efficacy Lighting
- Certified to State of California Title 20, State-regulated LED Lamp; reference Modernized Appliance Efficiency Database System (MAEDBS) for State-regulated LED Lamp
- ENERGY STAR certified, reference "Certified Light Fixtures" database

RSQ4 Energy Data

Lumens: 800 Series

Input Voltage: 120V

Input Current: 82 (mA)

Input Power: 9.8 W

Inrush (A): 0.69 @ 14ms

THD: ≤ 20%

Power Factor: ≥ 0.90

T Ambient: -40°C to +40°C

Sound Rating: ≤ 21dba

RSQ4 Series Ordering Information

Models	Lumens	CRI / CCT	Driver	Finish	Accessories (Order Separately)
RSQ4 = 4" all-purpose square LED module	08 = 800 lumens (nominal)	927 = 90 CRI (min), 2700 K CCT 930 = 90 CRI (min), 3000 K CCT 935 = 90 CRI (min), 3500 K CCT 940 = 90 CRI (min), 4000 K CCT 9FS = 90 CRI minimum, field selectable CCT, choose 2700, 3000, 3500, 4000 or 5000 K CCT	1E = 120V 60Hz, LE & TE phase cut 5% dimming with select dimmers	MWWB = matte white flange and baffle	RSQ4TRMMW = 4" square trim, matte white flange and splay, field paintable RSQ4TRMSNB = 4" square trim, satin nickel flange and baffle RSQ4TRMTBZB = 4" square trim, tuscon bronze flange and baffle HE26LED = Replacement screw base adapter (one included with unit)

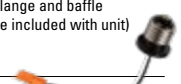

LED Recessed

RSQ5

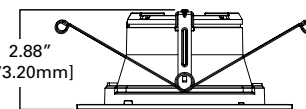
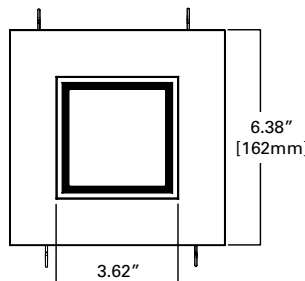

RSQ5

5" LED All-Purpose Square Retrofit Module

The RSQ5 is an integrated LED module / trim with a square shallow lens suitable for new construction, remodel and retrofit installation. Certified for use with Halo and compatible 5" housings and can be used with housings in direct contact with insulation. Integral gasket provides airtight compliance in non-airtight housings, provides code compliance and additional energy savings. Use for general area lighting in low to medium height ceilings where energy savings and long life are desired.



2700K • 3000K • 3500K
4000K • 5000K

Features

Module - Trim

- Module / trim is field interchangeable and upgradable, LED module consists of LED array, optical assembly, driver and self-flanged trim
- Integral aluminum heat sink provides passive thermal cooling achieving L70 at 70,000 hours in IC and non-IC applications.

LED Array

- Plurality of mid-power LEDs provide a uniform source with high efficiency and long life
- Available in 90 CRI minimum, R9 greater than 50 and color accuracy within 4 SDCM provides color accuracy and uniformity
- Available in 2700, 3000, 3500 and 4000 K fixed CCT
- Optional field selectable color temperature, select from 2700, 3000, 3500, 4000 and 5000 K CCT

Optical Assembly

- Precision molded optic organizes source flux into wide distribution, useful for general area lighting
- Regressed flat lens provides uniformity
- Meets Energy Star color angular uniformity requirements, color deviation is less than 0.006 u' v

Connectors

- Two-conductor wire mount CJT type connector is rated for 120V and mates with LED housings or E26 adapter (provided)

Driver

- Standard 1E constant current driver option with 120V 60 Hz input provides quiet operation

- Leading or trailing edge phase cut dimming to 5% with select controls, meets CA T24 flicker requirements

Retention

- Steel torsion springs hold module securely in the housing
- Rotates ± 45° allowing trim to be aligned with architecture
- Module / trim can be removed from below the aperture for service or replacement
- Optional friction blades (provided) for installation in housings without torsion spring receivers

Trim

- Die cast aluminum trim can be removed in the field and replaced with optional designer series trims to match many décors
- Step baffle provides additional cutoff to source

Gaskets

- Closed cell gaskets achieve restrictive airflow requirements without additional caulking

Compliance

- UL Certified Safety, US & CA when used with Halo and other's housings, see instruction sheet for conditions of acceptability
- Wet location listed and IP55 ingress protection rated, covered ceiling only
- Airtight per ASTM-E283-04
- Suitable for use in clothes closets when installed in accordance with the NEC 410.16 spacing requirements
- EMI/RFI emissions per FCC 47CFR Part 15 consumer limits

- Contains no mercury or lead and RoHS compliant
- Photometric testing in accordance with IES LM-79-08
- Lumen maintenance projections in accordance with IES LM-80-08 and TM-21-11
- Can be used for State of California Title 24 high efficacy LED compliance under JA8, reference Modernized Appliance Efficiency Database System (MAEDBS) for 2016 JA8 High Efficacy Lighting
- Certified to State of California Title 20, State-regulated LED Lamp; reference Modernized Appliance Efficiency Database System (MAEDBS) for State-regulated LED Lamp
- ENERGY STAR® certified, reference "Certified Light Fixtures" database

RSQ5 Energy Data

Lumens: 800 Series
Input Voltage: 120V
Input Current: 82 (mA)
Input Power: 9.8 W
Inrush (A): 0.69 @ 14ms
THD: ≤ 20%
Power Factor: ≥ 0.90
T Ambient: -40°C to +40°C
Sound Rating: ≤ 21dba

RSQ5 Series Ordering Information

Models	Lumens	CRI / CCT	Driver	Finish	Accessories (Order Separately)
RSQ5 = 5" all-purpose square LED module	08 = 800 lumens (nominal)	927 = 90 CRI (min), 2700 K CCT 930 = 90 CRI (min), 3000 K CCT 935 = 90 CRI (min), 3500 K CCT 940 = 90 CRI (min), 4000 K CCT 9FS = 90 CRI minimum, field selectable CCT, choose 2700, 3000, 3500, 4000 or 5000 K CCT	1E = 120V 60Hz, LE & TE phase cut 5% dimming with select dimmers	MWWB = matte white flange and baffle	RSQ5TRMMW = 5" square trim, matte white flange and splay, field paintable RSQ5TRMSNB = 5" square trim, satin nickel flange and baffle RSQ5TRMTBZB = 5" square trim, tuscon bronze flange and baffle HE26LED = Replacement screw base adapter (one included with unit)

LED Recessed

RSQ6 Series

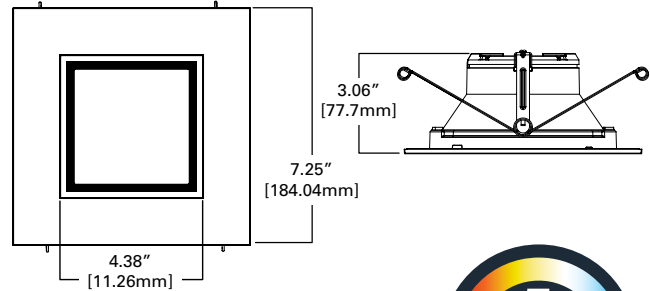

RSQ6

6" LED All-Purpose Square Retrofit Module

The RSQ6 is an integrated LED module / trim with a square shallow lens suitable for new construction, remodel and retrofit installation. Certified for use with Halo and compatible 6" housings and can be used with housings in direct contact with insulation. Integral gasket provides airtight compliance in non-airtight housings, provides code compliance and additional energy savings. Use for general area lighting in low to medium height ceilings where energy savings and long life are desired.



Features

Module - Trim

- Module / trim is field interchangeable and upgradable, LED module consists of LED array, optical assembly, driver and self-flanged trim
- Integral aluminum heat sink provides passive thermal cooling achieving L70 at 70,000 hours in IC and non-IC applications.

LED Array

- Plurality of mid-power LEDs provide a uniform source with high efficiency and long life
- Available in 90 CRI minimum, R9 greater than 50 and color accuracy within 4 SDCM provides color accuracy and uniformity
- Available in 2700, 3000, 3500 and 4000 K fixed CCT
- Optional field selectable color temperature, select from 2700, 3000, 3500, 4000 and 5000 K CCT

Optical Assembly

- Precision molded optic organizes source flux into wide distribution, useful for general area lighting
- Regressed flat lens provides uniformity
- Meets Energy Star color angular uniformity requirements, color deviation is less than 0.006 u' v

Connectors

- Two-conductor wire mount CJT type connector is rated for 120V and mates with LED housings or E26 adapter (provided)

Driver

- Standard 1E constant current driver option with 120V 60 Hz input provides quiet operation

- Leading or trailing edge phase cut dimming to 5% with select controls, meets CA T24 flicker requirements

Retention

- Steel torsion springs hold module securely in the housing
- Rotates ± 45° allowing trim to be aligned with architecture
- Module / trim can be removed from below the aperture for service or replacement
- Optional friction blades (provided) for installation in housings without torsion spring receivers

Trim

- Die cast aluminum trim can be removed in the field and replaced with optional designer series trims to match many décors
- Step baffle provides additional cutoff to source

Gaskets

- Closed cell gaskets achieve restrictive airflow requirements without additional caulking

Compliance

- UL Certified Safety, US & CA when used with Halo and other's housings, see instruction sheet for conditions of acceptability
- Wet location listed and IP44 ingress protection rated, covered ceiling only
- Airtight per ASTM-E283-04
- Suitable for use in clothes closets when installed in accordance with the NEC 410.16 spacing requirements
- EMI/RFI emissions per FCC 47CFR Part 15 consumer limits

- Contains no mercury or lead and RoHS compliant
- Photometric testing in accordance with IES LM-79-08
- Lumen maintenance projections in accordance with IES LM-80-08 and TM-21-11
- Can be used for State of California Title 24 high efficacy LED compliance under JA8, reference Modernized Appliance Efficiency Database System (MAEDBS) for 2016 JA8 High Efficacy Lighting
- Certified to State of California Title 20, State-regulated LED Lamp; reference Modernized Appliance Efficiency Database System (MAEDBS) for State-regulated LED Lamp
- ENERGY STAR® certified, reference "Certified Light Fixtures" database

RSQ6 Energy Data

Lumens: 800 Series
Input Voltage: 120V
Input Current: 82 (mA)
Input Power: 9.8 W
Inrush (A): 0.69 @ 14ms
THD: ≤ 20%
Power Factor: ≥ 0.90
T Ambient: -40°C to +40°C
Sound Rating: ≤ 21dba

RSQ6 Series Ordering Information

Models	Lumens	CRI / CCT	Driver	Finish	Accessories (Order Separately)
RSQ6 = 6" all-purpose square LED module	08 = 800 lumens (nominal)	927 = 90 CRI (min), 2700 K CCT 930 = 90 CRI (min), 3000 K CCT 935 = 90 CRI (min), 3500 K CCT 940 = 90 CRI (min), 4000 K CCT 9FS = 90 CRI minimum, field selectable CCT, choose 2700, 3000, 3500, 4000 or 5000 K CCT	1E = 120V 60Hz, LE & TE phase cut 5% dimming with select dimmers	MWWB = matte white flange and baffle	RSQ6TRMMW = 6" square trim, matte white flange and splay, field paintable RSQ6TRMSNB = 6" square trim, satin nickel flange and baffle RSQ6TRMTBZB = 6" square trim, tuscon bronze flange and baffle HE26LED = Replacement screw base adapter (one included with unit)

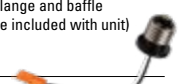

LED Recessed

ML4 Series

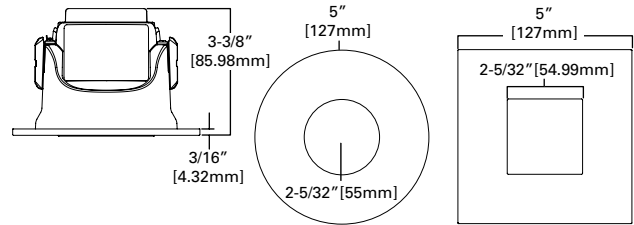

ML4D - TL41R & TL42S

4" LED Module, 2-inch Round and Square Pinhole Downlight

Recessed LED module with interchangeable 2-inch round or square open pinhole apertures are available in various finishes to suit many décors. Use with 4-inch nominal recessed housings suitable for residential and shallow plenum commercial construction or can be used to retrofit existing installations. Field interchangeable primary optics provide various distribution patterns and spacing to mounting height ratios. Use for general and task lighting in low to medium height ceilings where energy savings, long life and optical control are required.



Features

Module

- Field interchangeable and upgradable LED module consists of LED array, primary optic and driver
- Integral die cast aluminum heat sink provides passive thermal cooling achieving L70 at 50,000 hours in IC and non-IC applications

Retention

- Stainless steel springs hold module securely in the housing, can be removed thru the aperture for service or replacement

LED Array

- Proximity phosphors over chip on board LEDs provide a uniform source with high efficiency and no pixilation
- Available in 90 CRI minimum, R9 greater than 50 and color accuracy within 3 SDCM provide color accuracy and uniformity

Gaskets

- Closed cell gaskets achieve restrictive airflow requirements without additional caulking

Trims

- Die formed steel trims are available in 2-inch round or square pinhole apertures and can be interchanged in the field
- Available in a broad range of painted or plated finishes, can be painted in the field to match any décor
- Magnetic attachment holds trim tightly to ceiling and eliminates light leaks.

Media

- Integral media holder provided accepts (1) 2" diameter 3.0mm thick color filters, lens or louvers
- Order media separately

Primary Optic

- Precision molded TIR optic organizes source flux into useful beams without stray lumens in the field
- Two-piece construction with matte black mounting ring and polarized turn and lock mounting aligns optic to source and minimizes backlight in the housing
- Exceeds ENERGY STAR® color angular uniformity requirements, color deviation is typically less than 0.002 u' v'.
- Available in spot, narrow flood, flood and wide flood distributions, ships with narrow flood or flood factory installed, order alternate distributions or replacement separately
- Integral media holder accepts (1) lens or louver

VividTune

- D2W™ dim-to-warm option shifts color temperature from 3000 K to 1850 K as fixture dims mimicking the black body dimming response of halogen sources

Driver

- Integral UNV 120 - 277V 50/60 Hz constant current driver provides noise free operation and can be replaced in the field
- Continuous, flicker-free dimming from 100% to 5% with select leading or trailing edge 120V phase cut dimmers
- Optional UNV 120-277V 50/60 Hz driver with 0 -10V analog dimming from 100% to 5%, provided with inline electrical quick connect for low voltage connections
- Medium base (E26) to CJT adapter (provided) provides mains connection.

Compliance

- cULus listed for use with Halo housings, classified for use with other's housings, see instruction sheet for conditions of acceptability

- Damp location listed
- Airtight per ASTM-E283
- Suitable for use in clothes closets when installed in accordance with the NEC 410.16 spacing requirements
- EMI/RFI emissions per FCC 47CFR Part 15 consumer limits
- Contains no mercury or lead and RoHS compliant
- Photometric testing in accordance with IES LM-79-08
- Lumen maintenance projections in accordance with IES LM-80-08 and TM-21-11
- Can be used for State of California Title 24 high efficacy LED compliance under JA8, reference Modernized Appliance Efficiency Database System (MAEDBS) for 2016 JA8 High Efficacy Lighting
- Certified to State of California Title 20, State-regulated LED Lamp; reference Modernized Appliance Efficiency Database System (MAEDBS) for State-regulated LED Lamp
- ENERGY STAR® certified, reference Certified Light Fixtures database.

ML4D Energy Data

Lumens	900 Series	
Input Voltage	120V	277V
Input Current	107 (mA)	50 (mA)
Input Power	12.8 (W)	12.5 (W)
Inrush (A)	1.1 (A)	1.9 (A)
THD	≤ 20%	
Power Factor:	≥ 0.90	
T Ambient	-40°C to +40°C	
Sound Rating	≤ 20dba	

ML4D Series Ordering Information

Models	Lumens	Distribution	CRI / CCT	Driver	Accessories (Order Separately)
ML4D = 4" LED module	09 = 900 lumens (nominal)	NFL = 25° narrow flood FL = 40° flood	927 = 90 CRI (min), 2700 K CCT 930 = 90 CRI (min), 3000 K CCT 935 = 90 CRI (min), 3500 K CCT 940 = 90 CRI (min), 4000 K CCT D2W = 90 CRI (min) color shifts from 3000 to 1850K mimicking black body dimming2	E = UNV 120 - 277V 50-60Hz, LE & TE phase cut 5% dimming at 120V only E010 = UNV 120 - 277V 50-60Hz, 0 - 10V analog 5% dimming1	TIR45SP15 = 15° spot TIR45NFL25 = 25° narrow flood TIR45FL40 = 40° flood TIR45WFL55 = 55° wide flood TIR50AWW25 = 25° narrow flood asymmetric / wall wash TIR45MH12PK = replacement media holder, package of 12 L100 Series = 2.0" lens and filters, see spec sheet HE26LED = Replacement screw base adapter (one included with unit)

LED Recessed

ML4 Series

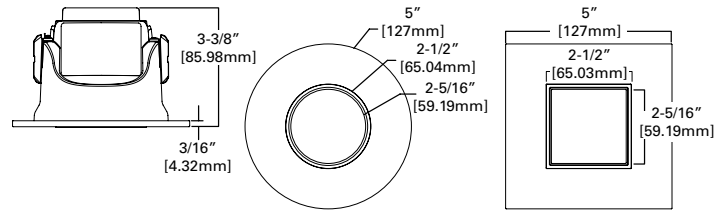

ML4D - TL43R & TL44S

4" LED Module, 2-inch Round and Square Pinhole Downlight

Recessed LED module with interchangeable 2-inch round or square lens pinhole apertures are available in various finishes to suit any décor. Use with 4-inch nominal recessed housings suitable for residential and shallow plenum commercial construction or can be used to retrofit existing installations. Field interchangeable primary optics provide various distribution patterns and spacing to mounting height ratios. Use for general and task lighting in low to medium height ceilings where energy savings, long life and optical control are required.



Module

- Field interchangeable and upgradable LED module consists of LED array, primary optic and driver
- Integral die cast aluminum heat sink provides passive thermal cooling achieving L70 at 50,000 hours in IC and non-IC applications

Retention

- Stainless steel springs hold module securely in the housing, can be removed thru the aperture for service or replacement

LED Array

- Proximity phosphors over chip on board LEDs provide a uniform source with high efficiency and no pixilation
- Available in 90 CRI minimum, R9 greater than 50 and color accuracy within
- 3 SDCM provide color accuracy and uniformity

Gaskets

- Closed cell gaskets achieve restrictive airflow requirements without additional caulking

Trims

- Die formed steel trims are available in 2-inch round or square pinhole apertures and can be interchanged in the field
- Available in a broad range of painted or plated finishes, can be painted in the field to match any décor
- Magnetic attachment holds trim tightly to ceiling and eliminates light leaks

Media

- Integral media holder provided accepts (1) 2" diameter 3.0mm thick color filters, lens or louvers
- Order media separately

Primary Optic

- Precision molded TIR optic organizes source flux into useful beams without stray lumens in the field
- Two-piece construction with matte black mounting ring and polarized turn and lock mounting aligns optic to source and minimizes backlight in the housing
- Exceeds ENERGY STAR® color angular uniformity requirements, color deviation is typically less than 0.002 u' v'.
- Available in spot, narrow flood, flood and wide flood distributions, ships with narrow flood or flood factory installed, order alternate distributions or replacement separately
- Integral media holder accepts (1) lens or louver

VividTune

- D2W™ dim-to-warm option shifts color temperature from 3000 K to 1850 K as fixture dims mimicking the black body dimming response of halogen sources

Driver

- Integral UNV 120 - 277V 50/60 Hz constant current driver provides noise free operation and can be replaced in the field
- Continuous, flicker-free dimming from 100% to 5% with select leading or trailing edge 120V phase cut dimmers
- Optional UNV 120-277V 50/60 Hz driver with 0 -10V analog dimming from 100% to 5%, provided with inline electrical quick connect for low voltage connections
- Medium base (E26) to CJT adapter (provided) provides mains connection

Compliance

- cULus listed for use with Halo housings, classified for use with other's housings, see instruction sheet for conditions of acceptability

- Damp location listed
- Airtight per ASTM-E283
- Suitable for use in clothes closets when installed in accordance with the NEC 410.16 spacing requirements
- EMI/RFI emissions per FCC 47CFR Part 15 consumer limits
- Contains no mercury or lead and RoHS compliant
- Photometric testing in accordance with IES LM-79-08
- Lumen maintenance projections in accordance with IES LM-80-08 and TM-21-11
- Can be used for State of California Title 24 high efficacy LED compliance under JA8, reference Modernized Appliance Efficiency Database System (MAEDBS) for 2016 JA8 High Efficacy Lighting
- Certified to State of California Title 20, State-regulated LED Lamp; reference Modernized Appliance Efficiency Database System (MAEDBS) for State-regulated LED Lamp
- ENERGY STAR® certified, reference Certified Light Fixtures database

ML4D Energy Data

Lumens	900 Series	
Input Voltage	120V	277V
Input Current	107 (mA)	50 (mA)
Input Power	12.8 (W)	12.5 (W)
Inrush (A)	1.1 (A)	1.9 (A)
THD	≤ 20%	
Power Factor:	≥ 0.90	
T Ambient	-40°C to +40°C	
Sound Rating	≤ 20dba	

ML4D Series Ordering Information

Models	Lumens	Distribution	CRI / CCT	Driver	Accessories
ML4D = 4" LED module	09 = 900 lumens (nominal)	NFL = 25° narrow flood FL = 40° flood	927 = 90 CRI (min), 2700 K CCT 930 = 90 CRI (min), 3000 K CCT 935 = 90 CRI (min), 3500 K CCT 940 = 90 CRI (min), 4000 K CCT D2W = 90 CRI (min) color shifts from 3000 to 1850K mimicking black body dimming ²	E = UNV 120 - 277V 50-60Hz, LE & TE phase cut 5% dimming at 120V only E010 = UNV 120 - 277V 50-60Hz, 0 - 10V analog 5% dimming ¹	TIR45SP15 = 15° spot TIR45NFL25 = 25° narrow flood TIR45FL40 = 40° flood TIR45WFL55 = 55° wide flood TIR50AWW25 = 25° narrow flood asymmetric / wall wash TIR45MH12PK = replacement media holder, package of 12 L100 Series = 2.0" lens and filters, see spec sheet HE26LED = Replacement screw base adapter (one included with unit)

LED Recessed

ML4 Series

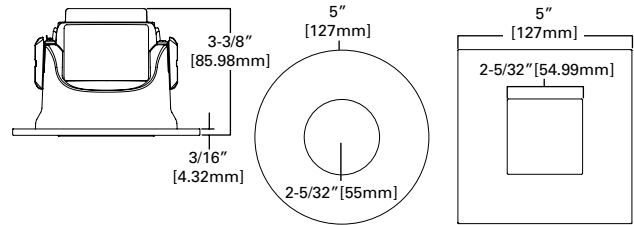

ML4D - TL45R & TL46S

4" LED Module, 2-Inch Round and Square Lens Wall Washer

Recessed LED module with interchangeable 2-inch round or square wall wash apertures are available in various finishes to suit any décor. Use with 4-inch nominal recessed housings suitable for residential and shallow plenum commercial construction or can be used to retrofit existing installations. Asymmetric primary optic redirects light through linear spread lens providing useful vertical foot-candles. Use to light walls, paintings and textured surfaces including stone, masonry and wood when energy savings, long life and optical control are required.



Features

Module

- Field interchangeable and upgradable LED module consists of LED array, primary optic and driver
- Integral die cast aluminum heat sink provides passive thermal cooling achieving L70 at 50,000 hours in IC and non-IC applications

Retention

- Stainless steel springs hold module securely in the housing, can be removed thru the aperture for service or replacement

LED Array

- Proximity phosphors over chip on board LEDs provide a uniform source with high efficiency and no pixilation
- Available in 90 CRI minimum, R9 greater than 50 and color accuracy within 3 SDCM provide color accuracy and uniformity

Gaskets

- Closed cell gaskets achieve restrictive airflow requirements without additional caulking

Trims

- Die formed steel trims are available in 2-inch round or square pinhole apertures and can be interchanged in the field
- Available in a broad range of painted or plated finishes, can be painted in the field to match any décor
- Magnetic attachment holds trim tightly to ceiling and eliminates light leaks.

Media

- Integral media holder provided accepts (1) 2" diameter 3.0mm thick color filters, lens or louvers
- Order media separately

Primary Optic

- Precision molded TIR optic organizes source flux into useful beams without stray lumens in the field
- Two-piece construction with matte black mounting ring and polarized turn and lock mounting aligns optic to source and minimizes backlight in the housing
- Exceeds ENERGY STAR® color angular uniformity requirements, color deviation is typically less than 0.002 u' v'.
- Available in spot, narrow flood, flood and wide flood distributions, ships with narrow flood or flood factory installed, order alternate distributions or replacement separately
- Integral media holder accepts (1) lens or louver

VividTune

- D2W™ dim-to-warm option shifts color temperature from 3000 K to 1850 K as fixture dims mimicking the black body dimming response of halogen sources

Driver

- Integral UNV 120 - 277V 50/60 Hz constant current driver provides noise free operation and can be replaced in the field
- Continuous, flicker-free dimming from 100% to 5% with select leading or trailing edge 120V phase cut dimmers
- Optional UNV 120-277V 50/60 Hz driver with 0 -10V analog dimming from 100% to 5%, provided with inline electrical quick connect for low voltage connections
- Medium base (E26) to CJT adapter (provided) provides mains connection.

Compliance

- cULus listed for use with Halo housings, classified for use with other's housings, see instruction sheet for conditions of acceptability

- Damp location listed
- Airtight per ASTM-E283
- Suitable for use in clothes closets when installed in accordance with the NEC 410.16 spacing requirements
- EMI/RFI emissions per FCC 47CFR Part 15 consumer limits
- Contains no mercury or lead and RoHS compliant
- Photometric testing in accordance with IES LM-79-08
- Lumen maintenance projections in accordance with IES LM-80-08 and TM-21-11
- Can be used for State of California Title 24 high efficacy LED compliance under JA8, reference Modernized Appliance Efficiency Database System (MAEDBS) for 2016 JA8 High Efficacy Lighting
- Certified to State of California Title 20, State-regulated LED Lamp; reference Modernized Appliance Efficiency Database System (MAEDBS) for State-regulated LED Lamp
- ENERGY STAR® certified, reference Certified Light Fixtures database.

ML4D Energy Data

Lumens	900 Series	
Input Voltage	120V	277V
Input Current	107 (mA)	50 (mA)
Input Power	12.8 (W)	12.5 (W)
Inrush (A)	1.1 (A)	1.9 (A)
THD	≤ 20%	
Power Factor:	≥ 0.90	
T Ambient	-40°C to +40°C	
Sound Rating	≤ 20dba	

ML4D Series Ordering Information

Models	Lumens	Distribution	CRI / CCT	Driver	Accessories
ML4D = 4" LED module	09 = 900 lumens (nominal)	NFL = 25° narrow flood FL = 40° flood	927 = 90 CRI (min), 2700 K CCT 930 = 90 CRI (min), 3000 K CCT 935 = 90 CRI (min), 3500 K CCT 940 = 90 CRI (min), 4000 K CCT D2W = 90 CRI (min) color shifts from 3000 to 1850K mimicking black body dimming2	E = UNV 120 - 277V 50-60Hz, LE & TE phase cut 5% dimming at 120V only E010 = UNV 120 - 277V 50-60Hz, 0 - 10V analog 5% dimming1	TIR45SP15 = 15° spot TIR45NFL25 = 25° narrow flood TIR45FL40 = 40° flood TIR45WFL55 = 55° wide flood TIR50AWW25 = 25° narrow flood asymmetric / wall wash TIR45MH12PK = replacement media holder, package of 12 L100 Series = 2.0" lens and filters, see spec sheet HE26LED = Replacement screw base adapter (one included with unit)

LED Recessed

ML4 Series



TL41R 2" Round Open Pinhole

- Die formed steel trim with 2" pinhole
- Field interchangeable
- Available in painted or plated finishes
- Paint in the field to match any décor
- Magnetic attachment holds trim tight to ceiling and eliminates light leaks



Dimensions**

A: 2-5/32" [55mm]
H: 3/16" [4.32mm]
OD: 5" [127mm]



TL42S 2" Square Open Pinhole

- Die formed steel trim with 2" pinhole
- Field interchangeable
- Available in painted or plated finishes
- Paint in the field to match any décor
- Magnetic attachment holds trim tight to ceiling and eliminates light leaks

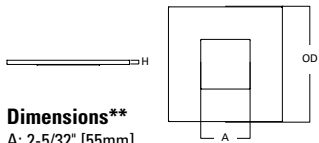

Dimensions**

A: 2-5/32" [55mm]
H: 3/16" [4.32mm]
OD: 5" [127mm]



TL43R 2" Round Lens Pinhole

- Die formed steel trim with 2" pinhole
- Field interchangeable
- Available in painted or plated finishes
- Paint in the field to match any décor
- Magnetic attachment holds trim tight to ceiling and eliminates light leaks

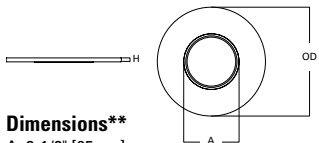

Dimensions**

A: 2-1/2" [65mm]
H: 3/16" [4.32mm]
OD: 5" [127mm]



TL44S 2" Square Lens Pinhole

- Die formed steel trim with 2" pinhole
- Field interchangeable
- Available in painted or plated finishes
- Paint in the field to match any décor
- Magnetic attachment holds trim tight to ceiling and eliminates light leaks

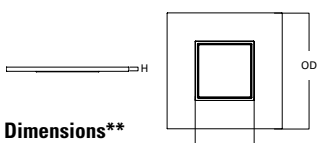

Dimensions**

A: 2-1/2" [65mm]
H: 3/16" [4.32mm]
OD: 5" [127mm]



LED Recessed

ML4 Series



TL45R 2" Round Lens Wall Wash Pinhole

- Die formed steel trim with 2" pinhole
- Field interchangeable
- Available in painted or plated finishes
- Paint in the field to match any décor
- Magnetic attachment holds trim tight to ceiling and eliminates light leaks



TL45R6GMWVB
matte white flange,
white lens frame



TL45R6GMWBB
matte white flange,
black lens frame

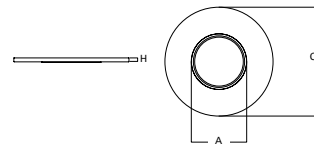

Dimensions**
A: 2-1/2" [65mm]
H: 3/16" [4.32mm]
OD: 5" [127mm]

TL46S 2" Square Lens Wall Wash Pinhole

- Die formed steel trim with 2" pinhole
- Field interchangeable
- Available in painted or plated finishes
- Paint in the field to match any décor
- Magnetic attachment holds trim tight to ceiling and eliminates light leaks



TL46S6GMWVB
matte white flange,
white lens frame



TL46S6GMWBB
matte white flange,
black lens frame

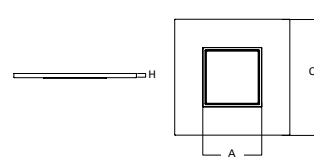

Dimensions**
A: 2-1/2" [65mm]
H: 3/16" [4.32mm]
OD: 5" [127mm]

ML4 Optics

TIR45SP15 = 15° spot

TIR45NFL25 = 25° narrow flood

TIR45FL40 = 40° flood

TIR45WFL55 = 55° wide flood

TIR50AWW25 = 25° narrow flood asymmetric / wall wash

TIR45MH12PK = replacement media holder, package of 12



TIR45SP15
15 degree spot



TIR45NFL25
25 degree narrow flood



TIR45FL40
40 degree flood



TIR45WFL55
55 degree wide flood



TIR50AWW25
25 degree narrow flood
asymmetric / wall wash



TIR45MH12PK
replacement media
holder



media holder with lens
installed on optic

LED Recessed Housing

ML4 Series - HS4R / HS4S

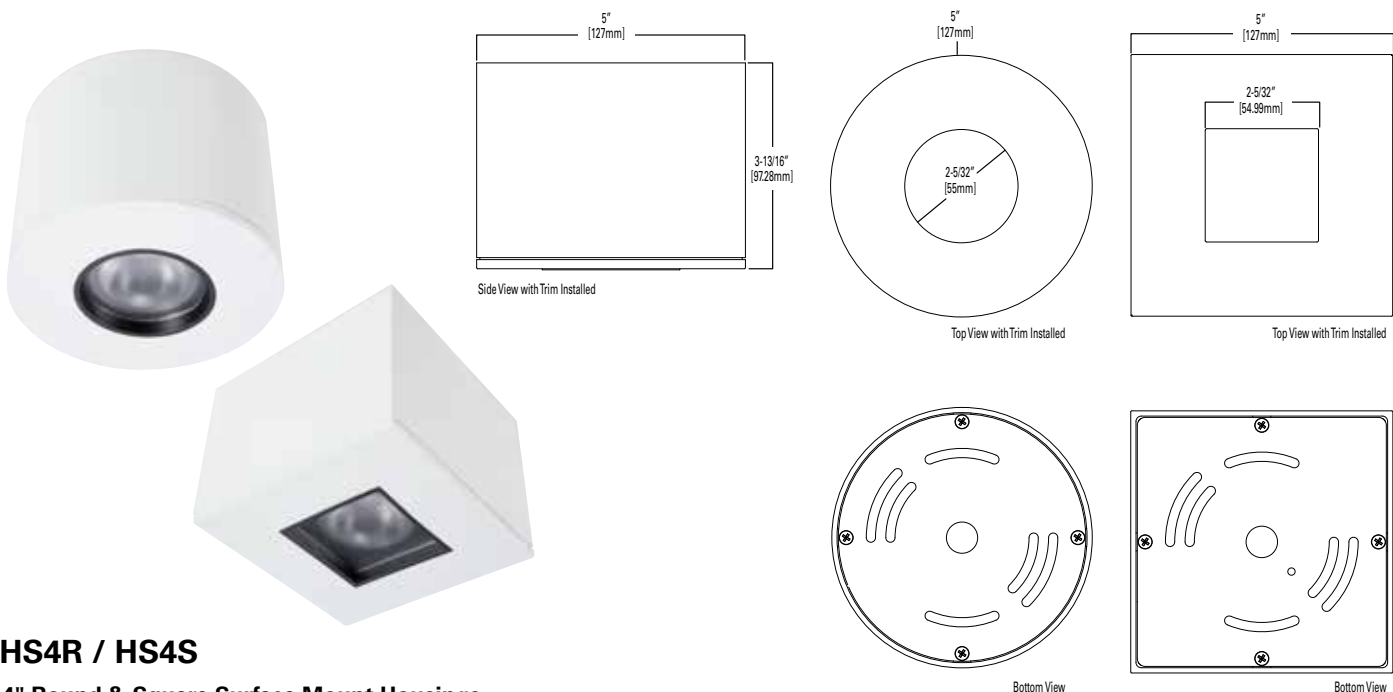

HS4R / HS4S

4" Round & Square Surface Mount Housings

The HS4R round and HS4S square housings adapt ML4 LED module and associated 2" aperture open, lens and lens wall wash trims to complete a surface mount luminaire. Installs to recessed or surface mounted junction boxes with hardware provided. Use with compatible Halo LED integrated trims and modules providing general, task and accent lighting when energy savings, long life and optical control are required. ML4 LED module and trims ordered separately.



Compatible LED Modules

ML4 LED series

Features

Housing

- Extruded aluminum round or square housing with die formed aperture accepts ML4 LED modules and trims.

Mounting

- Attaches directly to 3-1/2" and 4" round ceiling pans, 3-1/2" and 4" octagon boxes, 4" and 4-11/16" square fixture mud rings and single gang handy boxes with hardware provided
- Spider plate allows for $\pm 45^\circ$ rotation to align square with architecture.

Gasket

- Provided with die cut white and black gasket for use in wet locations, covered ceilings only

Connector

- Two-conductor wire mount connector is rated for 120 - 277V and mates with ML4 LED integrated module
- CAUTION:** verify LED module input voltage is compatible with the input voltage of the housing. If uncertain, consult a qualified electrician
- Separate two-conductor wire mount connector for 0 - 10V low voltage control.

Compliance

- cULus damp location listed with open trims, wet location listed, covered ceilings only and IP65 certified when used with supplied gasket and lens trims
- Suitable for use in clothes closets when installed in accordance with the NEC 410.16 spacing requirements
- Can be used for State of California Title 24 high efficacy LED compliance under JA8, reference Modernized Appliance Efficiency Database System (MAEDBS) for 2016 JA8 High Efficacy Lighting
- ENERGY STAR certified, reference Certified Light Fixtures database



LED Recessed

ML56 – 600 & 900 Series

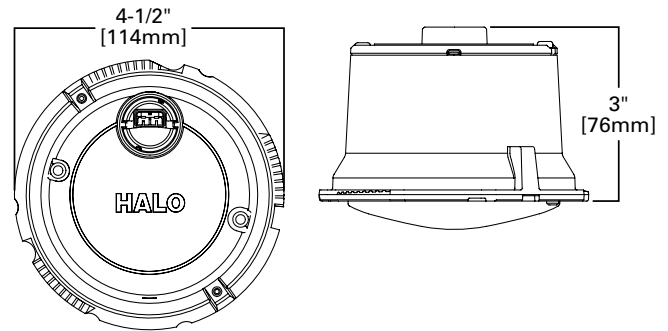

ML5606xxx – 600 Series ML5609xxx – 900 Series

5" / 6" LED Retrofit Module – 6 Inch Application

The ML56 LED downlighting system is a series of LED light modules for use with designated 6" ML56 LED trims in new construction, remodel and retrofit housings. Compatible with Halo 6" housings. ML56 light modules are offered in 600 series, 900 series, and 1200 series, 90 CRI, and four color temperatures 2700K, 3000K, 3500K, 4000K. ML56 light modules are universal voltage 120V – 277V and dimmable at 120V. The ML56 lens provides uniform diffuse illumination.

90 CRI



Features

Mechanical – Module

- Module includes LED driver, heat sink, and lens
- Durable die-cast aluminum construction
- Heat sink designed to conduct heat away from the LED keeping the junction temperatures below specified maximums, including insulated ceiling environments

Lens

- Impact-resistant polycarbonate
- Convex form for lamp-like appearance
- High lumen transmission
- Diffusing for even illumination

Mounting

- Light modules attach to reflector and baffle trims via locking tabs, and attach to eyeballs via keyed twist-to-lock mating bosses
- The complete light module and trim assembly installs into housings with precision formed torsion springs located on the trim

LED

- Correlated Color Temperature (CCT): 2700K, 3000K, 3500K, and 4000K
- Color Rendering Index (CRI): 90
- 600 nominal lumens, range dependent on CCT, CRI and trim
- 900 nominal lumens, range dependent on CCT, CRI and trim
- Lumen maintenance L70 at 50,000 hours

Electrical Power Connections

- LED connector is a non-screw base luminaire disconnect offering easy installation with the matching Halo 6" H750 and H2750 series housings (Use with ML56 6" LED trims)
- LED connector is a non-screw base, and where required to qualify as a high efficacy luminaire
- E26 medium screw base retrofit adapter included

LED Driver

- Driver is universal voltage 120V-277V, and may be controlled from a switch (Switchable at 120V, 220V, 230V, 240V, and 277V)
- Driver is dimmable at 120V operation when connected to a compatible dimmer
- Driver is a high efficiency, electronic power supply providing DC power to the LED
- Driver meets FCC EMI/RFI consumer level limits on 120V main inputs, and is compliant for use in residential and commercial installations
- Driver features high power factor, low THD, and has integral thermal protection in the event of over temperature or internal failure

Compliance

- cULus Listed 1598 luminaire, with listed Halo housings
- UL Classified, with other housings (See specifications online for housing compatibility)
- cULus Listed for damp locations
- cULus Listed wet location, covered ceiling (shower rated) with ML56 baffle and reflector trims only

- Air-Tite code compliant. Certified under ASTM E283; not exceeding 2.0 cfm (0.944 L/s) air leakage rate tested at a 1.57 psf (75 Pa) pressure differential
- IP66 Ingress Protection rated with baffle and reflector trims only
- RoHS compliant
- May be used in IC (insulated ceiling) housings in direct contact with insulation* and combustible material
 - 90 CRI (R9 > 50) can be used for California Title 24 compliance, Title 20 Certified for residential compliance
- Can be used for International Energy Conservation Code (IECC) high efficacy luminaire compliance
- ENERGY STAR® certified downlight recessed system
- EMI/RFI per FCC 47CFR Part 15 Class B consumer limits (commercial and residential compliant)
- Photometric testing in accordance with IES LM-79
- Lumen maintenance projections in accordance with IES LM-80 and TM-21
- CE Mark - "Conformité Européenne" conformity with the Council of European Communities Directives, meeting internationally recognized compliance when used with Halo H750, and H2750 series LED housings only

*Not to be used in direct contact with spray foam insulation (Consult NEMA LSD57-2013)

ML56 LED System

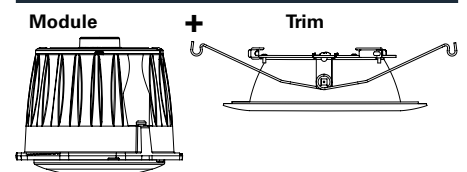

LED Recessed

ML56 – 1200 Series



ML5612xxx – 1200 Series

5" / 6" LED Retrofit Module – 6 Inch Application

The ML56 LED downlighting system is a series of LED light modules for use with designated 6" ML56 LED trims in new construction, remodel and retrofit housings. Compatible with Halo 6" housings. ML56 light modules are offered in 600 series, 900 series, and 1200 series, 90 CRI, and four color temperatures 2700K, 3000K, 3500K, 4000K. ML56 light modules are universal voltage 120V – 277V and dimmable at 120V. The ML56 lens provides uniform diffuse illumination standard. ML56 - 1200 series offers narrow flood (NFL) beam forming reflector as an optional accessory. Wet location listed with reflector and baffle trims (directional eyeball trims are damp listed). Halo ML56 series offers high performance LED downlighting in a flexible modular selection.

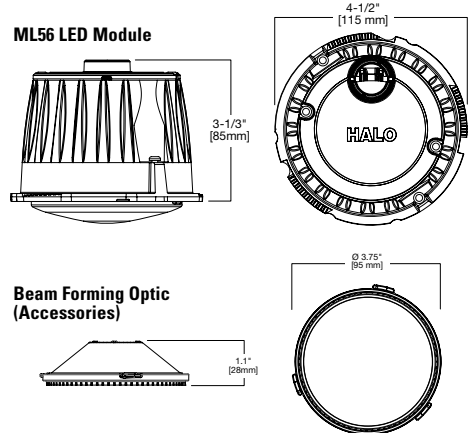

90 CRI



Features

Mechanical Module

- Module includes LED, LED driver, heat sink, and lens
- Durable die-cast aluminum construction
- Heat sink designed to conduct heat away from the LED keeping the junction temperatures below specified maximums, including insulated ceiling environments

Lens Optics

- Diffuse lens is standard on all 1200 series LED light modules
 - Impact-resistant polycarbonate
 - Convex form for lamp-like appearance
 - High lumen transmission
- Optional beam forming optic replaces diffuse lens and provide narrow flood (NFL) 25° nominal distribution. Beam forming optic is field installed. Order separately (accessories).

Mounting

- Light modules attach to reflector and baffle trims via locking tabs, and attach to eyeballs via keyed twist-to-lock mating bosses
- The complete light module and trim assembly installs into housings with precision formed torsion springs located on the trim

LED

- Correlated Color Temperature (CCT): 2700K, 3000K, 3500K, and 4000K
- Color Rendering Index (CRI): 90
- 1200 nominal lumens, range dependent on CCT, CRI and trim
- Lumen maintenance L70 at 50,000 hours

Electrical Power Connections

- LED connector is a non-screw base luminaire disconnect offering easy installation with the matching Halo 6" H750 and H2750 series housings (use with ML56 6" LED trims)
- LED connector is a non-screw base, and where required to qualify as a high efficacy luminaire
- E26 medium screw base retrofit adapter included

LED Driver

- Driver is universal voltage 120V-277V, and may be controlled from a switch (switchable at 120V, 220V, 230V, 240V, and 277V)
- Driver is dimmable at 120V operation when connected to a compatible dimmer
- Driver is a high efficiency, electronic power supply providing DC power to the LED
- Driver meets FCC EMI/RFI consumer level limits on 120V main inputs, and is compliant for use in residential and commercial installations
- Driver features high power factor, low THD, and has integral thermal protection in the event of over temperature or internal failure

Compliance

- cULus Listed 1598 luminaire, with listed Halo housings
- UL Classified, with other housings (See specifications online for housing compatibility)
- cULus Listed for damp locations
- cULus Listed wet location, covered ceiling (shower rated) with ML56 baffle and reflector trims only
- Air-Tite code compliant. Certified under ASTM E283; not exceeding 2.0 cfm (0.944 L/s) air leakage rate tested at a 1.57 psf (75 Pa) pressure differential.
- IP66 Ingress Protection rated with baffle and reflector trims only
- RoHS compliant
- May be used in IC (Insulated Ceiling) housings in direct contact with insulation* and combustible material
 - 90 CRI (R9 > 50) can be used for California Title 24 compliance, Title 20 Certified for residential compliance
- Can be used for International Energy Conservation Code (IECC) high efficacy luminaire compliance
- ENERGY STAR® certified downlight recessed LED system
- EMI/RFI per FCC 47CFR Part 15 Class B consumer limits (commercial and residential compliant)
- Photometric testing in accordance with IES LM-79
- Lumen maintenance projections in accordance with IES LM-80 and TM-21
- CE Mark - "Conformité Européene" conformity with the Council of European Communities Directives, meeting internationally recognized compliance when used with Halo H750, and H2750 series LED housings only

Accessories

BFR56NFL
Beam forming reflector kit, narrow flood, 25° nominal



BFR56MH
Media holder, accepts one 3.45" lens
Requires BFR56NFL and L345SF (Order separately)



L345SF
3.45" diameter soft focus lens
Requires BFR56NFL and BFR56MH (Order separately)



LED Recessed

ML56 – 600, 900 & 1200 Series Details

ML56 Ordering Information

600 Series - 90 CRI	900 Series - 90 CRI	1200 Series - 90 CRI
ML5606927 = 600 lumen, 2700K	ML5609927 = 900 lumen, 2700K	ML5612927 = 1200 lumen, 2700K
ML5606930 = 600 lumen, 3000K	ML5609930 = 900 lumen, 3000K	ML5612930 = 1200 lumen, 3000K
ML5606935 = 600 lumen, 3500K	ML5609935 = 900 lumen, 3500K	ML5612935 = 1200 lumen, 3500K
ML5606940 = 600 lumen, 4000K	ML5609940 = 900 lumen, 4000K	ML5612940 = 1200 lumen, 4000K

690 Series - 6" LED Trims

- 691WB = 6" LED trim, polymer "dead-front", white shallow baffle & flange
– shallow and standard housings (For use with 600 series LED light modules only)
- 692SC = 6" LED trim, specular reflector & white flange
- 692H = 6" LED trim, haze reflector & white flange
- 692W = 6" LED trim, white reflector & flange
- 693WB = 6" LED trim, white micro-step baffle & flange
- 693BB = 6" LED trim, black micro-step baffle & white flange
- 693SNB = 6" LED trim, satin nickel micro-step baffle & flange
- 693TBZB = 6" LED trim, tuscan bronze micro-step baffle & flange
- 694WB = 6" LED directional trim, white eyeball, baffle & flange – shallow and standard housings
- 694SNB = 6" LED directional trim, satin nickel eyeball, baffle & flange – shallow and standard housings
- 694TBZB = 6" LED directional trim, tuscan bronze eyeball, baffle & flange – shallow and standard housings
- 695WW = 6" LED trim, wall wash – specular reflector, repositionable specular kick reflector, white flange
- 696WB = 6" LED trim, white shallow baffle & flange – for use with shallow and standard housings
(600 & 900 series LED light modules ONLY)

ML56 1200 series for use in shallow housing with 694x trims only.

System Accessories

- ML56CLIP = 6" Friction clip mounting kit – for retrofitting non-torsion spring housings*
 - WW695SC = 6" Wall wash insert – kick reflector for 695WW
(1-included with trim) double or corner wall wash**
 - TRM690WH = 6" LED oversize trim ring for use with 69* series trims,
white 6.9" ID, 9.5" OD ring slips over LED trim. Inset design allows
6" trim to fit into oversize ring for an even trim surface
 - ML7RAB = Retrofit adapter band – installs in non-torsion spring 6" housings
- *ML56CLIP is compatible with 6" baffle and reflector trims only (691, 692, 693, 695, 696 series)
For eyeball trim (694 series) use ML7RAB retrofit adapter band
- HE26LED = Replacement screw base adapter (One included with unit)



ML56 Energy Data

600 Series	900 Series	1200 Series
(Values at non-dimming line voltage)	(Values at non-dimming line voltage)	(Values at non-dimming line voltage)
Minimum Starting Temp: -30°C (-22°F)	Minimum Starting Temp: -30°C (-22°F)	Minimum Starting Temp: -30°C (-22°F)
EMI/RFI: FCC Title 47 CFR, Part 15, (Consumer)	EMI/RFI: FCC Title 47 CFR, Part 15, (Consumer)	EMI/RFI: FCC Title 47 CFR, Part 15, (Consumer)
Sound Rating: Class A	Sound Rating: Class A	Sound Rating: Class A
Input Voltage: UNV 120V-277V	Input Voltage: UNV 120V-277V	Input Voltage: UNV 120V-277V
Power Factor: >0.95 @ 120V and >0.9 @277V	Power Factor: >0.95 @ 120V and >0.9 @277V	Power Factor: >0.95 @ 120V and >0.9 @277V
Input Frequency: 50/60Hz	Input Frequency: 50/60Hz	Input Frequency: 50/60Hz
THD: <20%	THD: <20%	THD: <20%
Input Power: 9.5W (90 CRI)	Input Power: 9.4W (90 CRI)	Input Power: 12.3W (90 CRI)
Input Current at 120V: 0.15A	Input Current at 120V: 0.15A	Input Current at 120V: 0.14A
Input Current at 277V: 0.08A	Input Current at 277V: 0.08A	Input Current at 277V: 0.07A
Driver Compliance: UL8750, Class II rated	Driver Compliance: UL8750, Class II rated	Driver Compliance: UL8750, Class II rated

Dimming

Designed for dimming capability on 120V input to nominal 5% in normal operation with 120V Leading Edge (LE) and Trailing Edge (TE) phase control dimmers. Dimmers with low end trim adjustment offer greater assurance of achieving 5% level. (Consult dimmer manufacturer for dimmer compatibility and conditions of use. Note, Some dimmers require a neutral in the wallbox)

Color Specification & Quality Standards

- A tight chromaticity specification ensures LED color uniformity, sustainable Color Rendering Index (CRI) and Correlated Color Temperature (CCT) over the useful life of the LED
- LED color uniformity of 3 SDCM, exceeds ENERGY STAR® color standards per ANSI C78.377-2008
- Halo LED serialized testing and measurement process ensures color and lumen consistency on a per-unit basis, and validates long-term product consistency over time

LED Recessed

ML56 69x Trims

691 Shallow Polymer Baffle, Self-flange

- Shallow polymer (plastic) baffle with self-flange
- For use with ML56 600 series LED modules ONLY
- Non-conductive polymer (plastic) "dead-front" construction
- Shallow height allows use in shallow or standard ceiling housings
- Wet location shower listed with ML56 LED modules
- For use with 600 series ML56 LED modules ONLY



691WB
White Shallow Polymer Baffle, White Self-flange

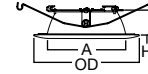

Dimensions**
A: 4-7/8" [123mm]
H: 1-1/2" [39mm]
OD: 6-1/2" [166mm]



692 Reflector, Self-flange

- Reflectors with self-flange
- For use with ML56 series LED modules
- Aluminum construction
- For use in standard housings
- Wet location shower listed with ML56 LED light modules



692W
White Reflector, White Self-flange



692SC
Specular Reflector, White Self-flange



692H
Haze Reflector, White Self-flange

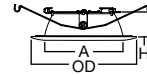

Dimensions**
A: 4-7/8" [123mm]
H: 1-1/2" [39mm]
OD: 6-1/2" [166mm]



693 Micro-Step Baffle, Self-flange

- Baffles with self-flange
- For use with ML56 series LED modules
- Aluminum construction
- For use in standard housings
- Wet location shower listed with ML56 LED light modules



693WB
White Baffle, White Self-flange



693BB
Black Baffle, White Self-flange



693SNB
Satin Nickel Baffle, Satin Nickel Self-flange



693TBZB
Tuscan Bronze Baffle, Tuscan Bronze Self-flange

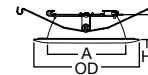

Dimensions**
A: 4-7/8" [123mm]
H: 1-1/2" [39mm]
OD: 6-1/2" [166mm]



694 Eyeball, 30° Tilt, Self-flange

- Eyeball with baffle and self-flange
- For use with ML56 series LED modules
- Aluminum construction
- For use in standard and shallow housings
- Eyeball tilts from 0 to 30 degrees



694WB
White Reflector, White Self-flange



694SNB
Satin Nickel Reflector, Satin Nickel Self-flange



694TBZB
Tuscan Bronze Reflector, Tuscan Bronze Self-flange

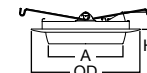

Dimensions**
A: 4-1/2" [113mm]
H: 1" [26mm]
OD: 6-1/2" [166mm]



695 Wall Wash Reflector, Self-flange

- Specular reflector and specular "kick" reflector insert
- For use with ML56 series LED light modules
- Aluminum construction reflector and precision molded "kick" reflector
- Repositionable kick reflector allows wall wash adjustment
- Optional accessory kick reflector for double or corner wall wash (WW695SC)
- Wet location shower listed with ML56 LED modules



695WW
Wall Wash - Specular Reflector, Repositionable Specular Kick Reflector, White Self-flange



WW695SC
Optional Accessory - Wall Wash Kick Reflector

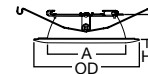

Dimensions**
A: 4-7/8" [123mm]
H: 1-1/2" [39mm]
OD: 6-1/2" [166mm]



696 Shallow Baffle, Self-flange

- Shallow baffle with self-flange
- For use with ML56 series LED light modules
- Aluminum construction
- Shallow height allows use in shallow or standard ceiling housings (For use in shallow housings with ML56 600 series and 900 series LED modules only)
- Wet location shower listed with ML56 LED modules



696WB
White Shallow Baffle, White Self-flange

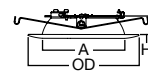

Dimensions**
A: 4-7/8" [123mm]
H: 1-1/2" [39mm]
OD: 6-1/2" [166mm]

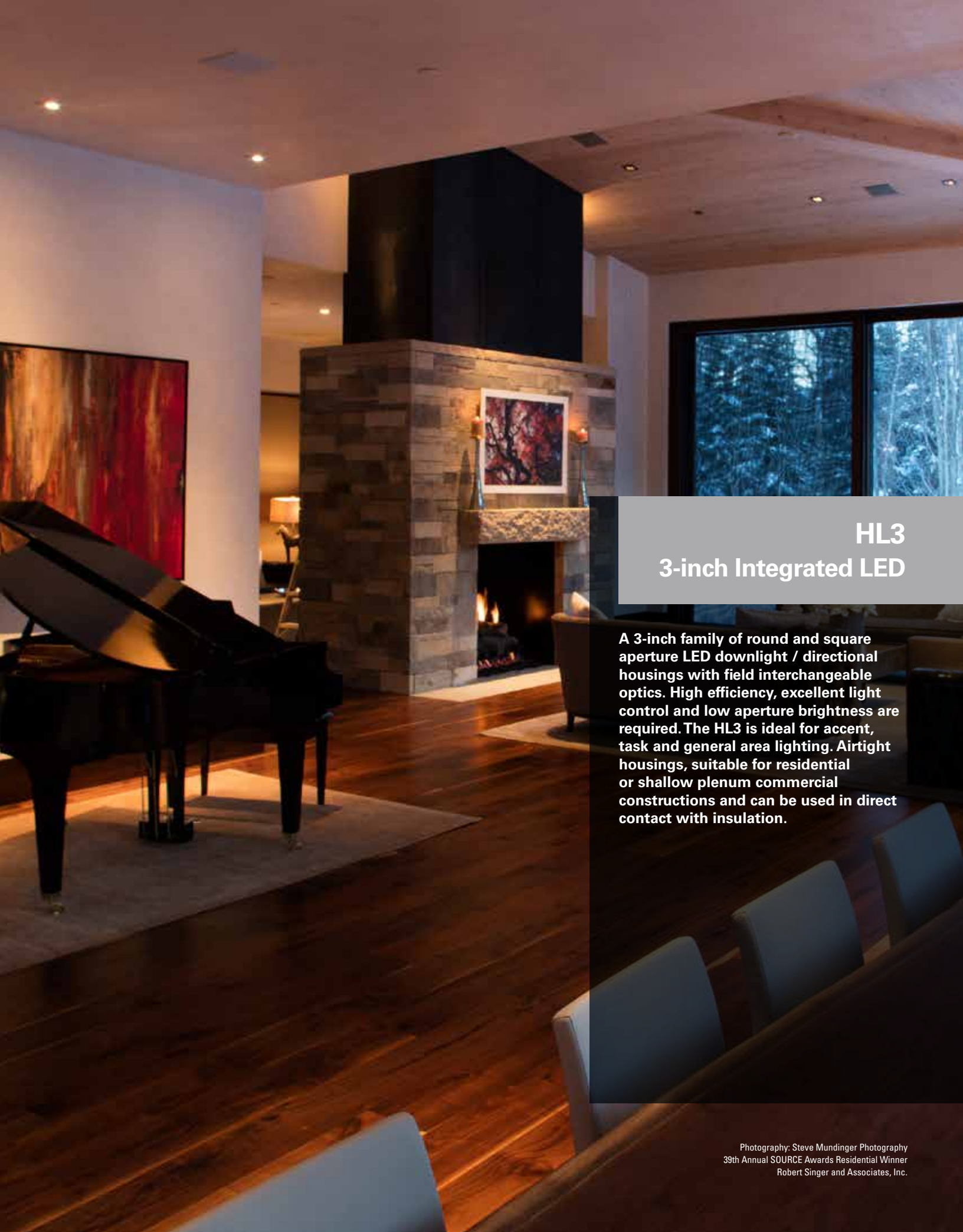

HL3 3-inch Integrated LED

A 3-inch family of round and square aperture LED downlight / directional housings with field interchangeable optics. High efficiency, excellent light control and low aperture brightness are required. The HL3 is ideal for accent, task and general area lighting. Airtight housings, suitable for residential or shallow plenum commercial constructions and can be used in direct contact with insulation.

HALO™ HL3 3-inch LED housings and trims

Seamless Ceiling Integration

Halo now offers a complete family of 3-inch LED recessed downlights ideal for your next demanding project. Choose from round or square apertures available in broad range of trim styles and optical distributions meeting demanding architectural factors including ceiling height, square footage and fixture spacing criteria.

Trims are available in a range of finishes to match many décors. Magnets pulls trims tight to the ceiling eliminating gaps and light leaks. Trims may be installed rimless with a true knife-edge interface creating a quiet ceiling appearance. Symmetrical trims can be used for both general area and accent lighting creating a consistent visual appearance.



HL36A

3" shallow round new construction directional housing

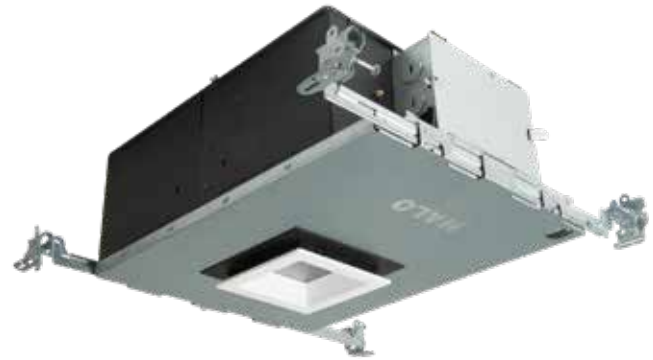

HL36SA

3" shallow square new construction directional housing



open reflector

open baffle

wall wash

lens

Rimless trims

Standard round and square housings can be converted to a rimless applications using the rimless adapter. A true knife-edge interface with the trim provides a "quiet ceiling" appearance.

The rimless adapter replaces the standard collar and adjusts to level with the finished ceiling. The perforated pattern and tapered flange facilitates blending with the ceiling surface.



RA3R

RA3S



Ease of installation

High-end residential and prestige commercial ceiling construction is complex. Housings have numerous proprietary contractor features and install quickly saving time and money. The same housing type is used for task, accent, wall washing and general area illumination simplifying planning and installation. Optical distribution can be easily changed in the field to adapt to changes in the field.

Whether a single accent fixture is installed in a new project to keep up with the homeowner's growing artwork collection or hundreds are used in the common areas of a hotel a unified design theme across all trim types and finishes creates a visually seamless installation allowing the architecture or other features to be the primary focus.

Optics

Primary optics are field interchangeable and are available in Spot (SP), Narrow Flood (NFL), Flood (FL) and Wide Flood (WFL) distribution patterns.



TIR45SP15
spot, 15°



TIR45NFL25
narrow flood, 25°



TIR45FL40
flood, 40°



TIR45WFL55
wide flood, 55°



Trim installation

Each Halo HL3 housing is fitted with (8) rare earth Neodymium magnets that securely hold the trim in place. This allows for subtle repositioning to align apertures.



Aim and focus

The housings have a built-in adjustment mechanism that will rotate 365°, tilt 45° and locks in position maintaining any aiming angle. Angle markings assist in repeatable settings. The primary optics are field interchangeable and are available in spot, narrow flood, flood and wide flood distribution patterns.



HL3 LED Series Housing

HL36A Series

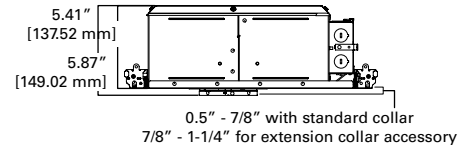
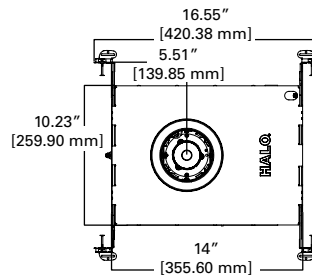

HL36A

3" IC, Shallow New Construction, LED Housing

Recessed 3-inch aperture LED downlight / directional with field interchangeable optics provide various distribution patterns. Ideal for accent, task and general area lighting. Housing is airtight, suitable for 2x6 residential or shallow plenum commercial constructions and can be used in direct contact with insulation. Trims are available in a range of finishes and can be installed rimless with an optional rimless adaptor. Use where high efficiency, excellent light control and low aperture brightness are required.



Special Features

- Got Nail!™ bar hangers
- q-Channel bars with Pass-N-Thru™
- Slide-N-Side™ junction box
- Quick Connect™ push wire nuts
- Air-Tite™ code compliant

Compatible Trims

TL3R	TL3R2G
TL3RMWRL	TL3R2GMWRL
TL3BBWF / TL3WBWF	TL3PR2GMW
TL3PIN	TL3R2GBBWF / TL3R2GWBWF
TL3PINMWWBRL	TL3PIN2G

Features

Frame

- Galvanized steel plaster frame with integral bar hanger receivers
- Setscrew provide positive horizontal locking
- Collar adjusts vertically to accommodate 1/2" to 7/8" thick ceilings and locks in position with (4) screws
- Use optional collar extender for 7/8" to 1-1/4" thick ceilings
- Integral gun sights facilitate the use of guide strings or laser lines
- Shipped with overspray protector installed

Housing

- Steel housing painted matte black for a visually dark interior
- Removable top allows service from above

Bar Hangers

- GOT NAIL! Gen 3 bar hangers adjust from 10-1/2" to 24" wide
- Pass thru feature allows shortening without removal
- Captive nail penetrates standard and engineered lumber
- Mounting flange levels platform with ceiling
- Integral clip attaches directly to tee-bar

Gaskets

- Gaskets achieve restrictive airflow requirements without additional caulking

Adjustment Mechanism

- Rotates 360°, tilts 45° and locks in position maintaining any aiming angle
- Angle markings assist in repeatable settings
- Translating center beam optics aligns axis of primary reflector with aperture from nadir to 45°

Trim Retention

- Attached by (8) rare earth Neodymium magnets, holds trim securely to the ceiling
- Tether secures trim to housing during service or adjustment

LED Module

- LED array is field replaceable
- Proximity phosphors over chip on board LEDs provide a uniform source with high efficiency and no pixilation
- Color accuracy within 3 SDCM and 90 CRI minimum
- Passive cooling achieves L70 at 50,000 hours

Primary Optic

- Precision molded optics deliver highly efficient and uniform patterns
- Various patterns are available and can be interchanged without tools

Media

- Integral media holder accepts up to (2) 2" diameter 3.0mm thick color filters or lens
- Order color filters and lens separately

Trims

- Die cast aluminum trims are available in open, lens and lens wall wash styles
- Polymer non-conductive trim meets many local code requirements for 'dead front'
- Physical and optical cutoff provides visual comfort
- Light trap eliminates spill light with flange
- Multiple finishes to match many décors
- Available in self-flanged or rimless styles with optional rimless adaptor accessory

Shielding

- Micro-prismatic lens standard with lens trims
- Hinged to allow rimless trim removal
- Order color filters and lens separately

Driver

- Field replaceable constant current driver provides noise free operation
- UNV 120-277VAC 50/60Hz input
- Continuous, flicker-free 1% dimming, available with LE and TE phase cut (at 120V only) and 0-10V analog control

Junction Box

- Galvanized steel junction box with 18in3 internal volume
- Listed for (12) #12 AWG 90° C splice conductors
- (7) 1/2" conduit pry-outs positioned to allow straight conduit runs
- (3) Slide-N-Side™ non-metallic (NM) wire traps
- Accepts 14-2, 14-3, 12-2, 12-3 U.S. and 14-2, 14-3, 12-2 Canadian NM cable
- (3) 4-port push wire nuts mains voltage connections

Compliance

- Type IC inherently protected, suitable for direct contact to air permeable insulation and cULus listed for damp locations
- Not for use in direct contact with spray foam insulation, consult NEMA LSD57-2013
- Wet location listed in covered ceilings and IP44 certified with select trims
- Airtight per ASTM-E283-04
- Suitable for use in clothes closets when installed in accordance with the NEC 410.16 spacing requirements
- EMI/RFI emissions per FCC 47CFR Part 15 consumer limits
- Contains no mercury or lead and RoHS compliant
- Photometric testing in accordance with IES LM-79-08
- Lumen maintenance projections in accordance with IES LM-80-08 and TM-21-11
- Can be used for State of California Title 24 high efficacy LED compliance under JA8, reference Modernized Appliance Efficiency Database System (MAEDBS) for 2016 JA8 High Efficacy Lighting
- ENERGY STAR® certified, reference certified light fixtures database

HL3 Round Trim Series

Use with HL36A Series Housings

Directional Open

TL3R Conical Reflector, Open, Self Flanged



- Recessed 3-inch aperture LED downlight / directional with field interchangeable optics provide various distribution patterns.
- Ideal for accent, task and general area lighting.
- Housing is airtight, suitable for 2x6 residential or shallow plenum commercial constructions.
- Can be used in direct contact with insulation.
- Trims are available in a range of finishes and can be installed rimless with an optional rimless adapter.
- Use where high efficiency, excellent light control and low aperture brightness are required.



TL3RH
Semi-specular clear reflector and flange



TL3RHWF
Semi-specular clear reflector and matte white flange



TL3RBN
Brushed nickel reflector and flange



TL3RORB
Oil rubbed bronze reflector and flange



TL3RMW
Matte white reflector and flange



TL3RMB
Matte white reflector and flange

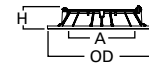

Dimensions**
A: 3.22" [81.67mm]
H: .77" [19.43mm]
OD: 4.36" [110.84mm]

TL3RMWRL Conical Reflector, Open, Rimless



- Recessed 3-inch aperture LED downlight / directional with field interchangeable optics provide various distribution patterns.
- Ideal for accent, task and general area lighting.
- Housing is airtight, suitable for 2x6 residential or shallow plenum commercial constructions and
- Can be used in direct contact with insulation.
- Trims are available in a range of finishes and can be installed rimless with an optional rimless adapter.
- Use where high efficiency, excellent light control and low aperture brightness are required



TL3RMWRLMW
Matte white reflector and flange

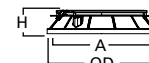

Dimensions**
A: 3.37" [85.60mm]
H: .74" [18.88mm]
OD: 3.56" [90.42mm]

TL3BBWF / TL3WBWF Conical Baffle, Open, Self Flanged



- Recessed 3-inch aperture LED downlight / directional with field interchangeable optics provide various distribution patterns.
- Ideal for accent, task and general area lighting.
- Housing is airtight, suitable for 2x6 residential or shallow plenum commercial constructions.
- Can be used in direct contact with insulation.
- Trims are available in a range of finishes and can be installed rimless with an optional rimless adapter.
- Use where high efficiency, excellent light control and low aperture brightness are required.



TL3BBWF
Matte black baffle, matte white flange



TL3WBWF
Matte white baffle, matte white flange

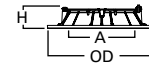

Dimensions**
A: 3.22" [81.67mm]
H: .77" [19.43mm]
OD: 4.36" [110.84mm]

TL3PIN Round Pinhole w/Oculus, Open, Self Flanged



- Recessed 3-inch aperture LED downlight / directional with field interchangeable optics provide various distribution patterns.
- Ideal for accent, task and general area lighting.
- Housing is airtight, suitable for 2x6 residential or shallow plenum commercial constructions.
- Can be used in direct contact with insulation.
- Trims are available in a range of finishes and can be installed rimless with an optional rimless adapter.
- Use where high efficiency, excellent light control and low aperture brightness are required.



TL3PINBNBB
Brushed nickel flange, black oculus



TL3PINORBBB
Oil rubbed bronze flange, black oculus



TL3PINMWWB
Matte white flange, white oculus



TL3PINMWBB
Matte white flange, black oculus



TL3PINMBBB
Matte black flange, black oculus

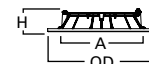

Dimensions**
A: 3.06" [77.67mm]
H: .84" [21.23mm]
OD: 4.36" [110.84mm]

HL3 Round Trim Series

Use with HL36A Series Housings



TL3PINMWWBRL Round Pinhole w/Oculus, Open, Rimless

- Recessed 3-inch aperture LED downlight / directional with field interchangeable optics provide various distribution patterns.
- Ideal for accent, task and general area lighting.
- Housing is airtight, suitable for 2x6 residential or shallow plenum commercial constructions.
- Can be used in direct contact with insulation.
- Trims are available in a range of finishes and can be installed rimless with an optional rimless adapter.
- Use where high efficiency, excellent light control and low aperture brightness are required.



TL3PINMWWBRL
Matte white flange,
white oculus

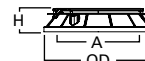

Dimensions**
A: 3.37" [85.60mm]
H: .77" [19.63mm]
OD: 3.56" [90.42mm]

Directional Lens

TL3R2G Conical Reflector, Diffuse Lens, Self Flanged



- Recessed 3-inch aperture LED downlight / directional with field interchangeable optics provide various distribution patterns.
- Ideal for accent, task and general area lighting.
- Housing is airtight, suitable for 2x6 residential or shallow plenum commercial constructions.
- Can be used in direct contact with insulation.
- Trims are available in a range of finishes and can be installed rimless with an optional rimless adapter.
- Use where high efficiency, excellent light control and low aperture brightness are required.



TL3R2GH
Semi-specular clear reflector
and flange



TL3R2GHWF
Semi-specular clear reflector
and matte white flange



TL3R2GBN
Brushed nickel reflector
and flange



TL3R2GORB
Oil rubbed bronze reflector
and flange



TL3R2GMW
Matte white reflector
and flange



TL3R2GMB
Matte white reflector
and flange

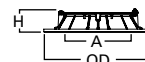

Dimensions**
A: 3.22" [81.67mm]
H: .77" [19.43mm]
OD: 4.36" [110.84mm]

TL3R2GMWRL Conical Reflector, Diffuse Lens, Rimless



- Recessed 3-inch aperture LED downlight / directional with field interchangeable optics provide various distribution patterns.
- Ideal for accent, task and general area lighting.
- Housing is airtight, suitable for 2x6 residential or shallow plenum commercial constructions.
- Can be used in direct contact with insulation.
- Trims are available in a range of finishes and can be installed rimless with an optional rimless adapter.
- Use where high efficiency, excellent light control and low aperture brightness are required.



TL3R2GMWRL
matte white reflector
and flange

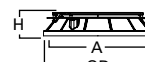

Dimensions**
A: 3.37" [85.60mm]
H: .74" [18.88mm]
OD: 3.56" [90.42mm]

TL3PR2GMW Conical Polymer Reflector, Diffuse Lens, Self Flanged



- Recessed 3-inch aperture LED downlight / directional with field interchangeable optics provide various distribution patterns.
- Ideal for accent, task and general area lighting.
- Housing is airtight, suitable for 2x6 residential or shallow plenum commercial constructions.
- Can be used in direct contact with insulation.
- Trims are available in a range of finishes and can be installed rimless with an optional rimless adapter.
- Use where high efficiency, excellent light control and low aperture brightness are required.



TL3PR2GMW
Matte white reflector
and flange



Dimensions**
A: 3.22" [81.67mm]
H: .77" [19.43mm]
OD: 4.36" [110.84mm]

HL3 Round Trim Series

Use with HL36A Series Housings



TL3R2GBBWF / TL3R2GWBWF Conical Baffle, Diffuse Lens, Self Flanged

- Recessed 3-inch aperture LED downlight / directional with field interchangeable optics provide various distribution patterns.
- Ideal for accent, task and general area lighting.
- Housing is airtight, suitable for 2x6 residential or shallow plenum commercial constructions.
- Can be used in direct contact with insulation.
- Trims are available in a range of finishes and can be installed rimless with an optional rimless adapter.
- Use where high efficiency, excellent light control and low aperture brightness are required.



TL3R2GBBWF
Matte black baffle,
matte white flange



TL3R2GWBWF
Matte white baffle,
matte white flange

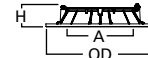

Dimensions**
A: 3.22" [81.67mm]
H: .77" [19.43mm]
OD: 4.36" [110.84mm]

TL3PIN2G Round Pinhole w/Oculus, Diffuse Lens, Self Flanged



- Recessed 3-inch aperture LED downlight / directional with field interchangeable optics provide various distribution patterns.
- Ideal for accent, task and general area lighting.
- Housing is airtight, suitable for 2x6 residential or shallow plenum commercial constructions.
- Can be used in direct contact with insulation.
- Trims are available in a range of finishes and can be installed rimless with an optional rimless adapter.
- Use where high efficiency, excellent light control and low aperture brightness are required.



TL3PIN2GBNBB
Brushed nickel flange,
black oculus



TL3PIN2GORBBB
Oil rubbed bronze flange,
black oculus



TL3PIN2GMWWB
Matte white flange,
white oculus



TL3PIN2GMWBB
Matte white flange,
black oculus



TL3PIN2GMBBB
Matte black flange,
black oculus

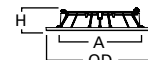

Dimensions**
A: 3.06" [77.67mm]
H: .84" [21.23mm]
OD: 4.36" [110.84mm]

TL3PIN2GMWWBRL Round Pinhole w/Oculus, Diffuse Lens, Rimless



- Recessed 3-inch aperture LED downlight / directional with field interchangeable optics provide various distribution patterns.
- Ideal for accent, task and general area lighting.
- Housing is airtight, suitable for 2x6 residential or shallow plenum commercial constructions.
- Can be used in direct contact with insulation.
- Trims are available in a range of finishes and can be installed rimless with an optional rimless adapter.
- Use where high efficiency, excellent light control and low aperture brightness are required.



TL3PIN2GMWWBRL
Matte white flange,
white oculus

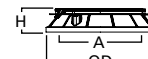

Dimensions**
A: 3.37" [85.60mm]
H: .77" [19.63mm]
OD: 3.56" [90.42mm]

HL3 Round Trim Series

Use with HL36A Series Housings

Lens Wall Wash

TL3LWW6G Conical Angle Cut Lens Wall Wash, Self Flanged



- Recessed 3-inch aperture LED downlight / directional with field interchangeable optics provide various distribution patterns.
- Ideal for accent, task and general area lighting.
- Housing is airtight, suitable for 2x6 residential or shallow plenum commercial constructions.
- Can be used in direct contact with insulation.
- Trims are available in a range of finishes and can be installed rimless with an optional rimless adapter.
- Use where high efficiency, excellent light control and low aperture brightness are required.



TL3LWW6GH
Semi-specular clear reflector and flange



TL3LWW6GHWF
Semi-specular clear reflector and matte white flange



TL3LWW6GMW
Matte white reflector and flange



Dimensions**
A: 3.50" [88.91mm]
H: .96" [24.45mm]
OD: 4.36" [110.84mm]

TL3LWW6GMWRL Conical Angle Cut Lens Wall Wash, Rimless



- Recessed 3-inch aperture LED downlight / directional with field interchangeable optics provide various distribution patterns.
- Ideal for accent, task and general area lighting.
- Housing is airtight, suitable for 2x6 residential or shallow plenum commercial constructions.
- Can be used in direct contact with insulation.
- Trims are available in a range of finishes and can be installed rimless with an optional rimless adapter.
- Use where high efficiency, excellent light control and low aperture brightness are required.



TL3LWW6GMWRL
Matte white reflector and flange

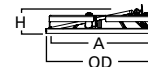

Dimensions**
A: 3.36" [85.26mm]
H: .87" [22.10mm]
OD: 3.56" [90.42mm]

HL3 LED Series Housing

HL36SA Series

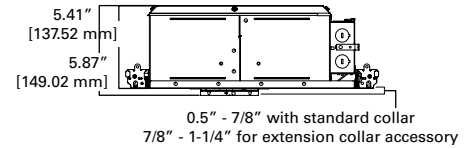
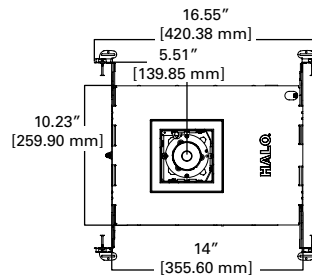

HL36SA

3" IC, Square Shallow New Construction, LED Housing

Recessed 3-inch square aperture LED downlight / directional with field interchangeable optics provide various distribution patterns. Ideal for accent, task and general area lighting. Housing is airtight, suitable for 2x6 residential or shallow plenum commercial constructions and can be used in direct contact with insulation. Trims are available in a range of finishes and can be installed rimless with an optional rimless adaptor. Use where high efficiency, excellent light control and low aperture brightness are required.



Special Features

- Got Nail!™ bar hangers
- q-Channel bars with Pass-N-Thru™
- Slide-N-Side™ junction box
- Quick Connect™ push wire nuts
- Air-Tite™ code compliant

Compatible Trims

- | | |
|---------------------|---------------------------|
| TLS3R | TLS3R2G |
| TLS3RMWRL | TLS3R2GMWRL |
| TLS3BBWF / TLS3WBWF | TLS3PR2GMW |
| TLS3PIN | TLS3R2GWBWF / TLS3R2GWBWF |
| TLS3PINMWWBRL | TLS3PIN2G |

Features

Frame

- Galvanized steel plaster frame with integral bar hanger receivers
- Setscrew provide positive horizontal locking
- Collar adjusts vertically to accommodate 1/2" to 7/8" thick ceilings and locks in position with (4) screws
- Use optional collar extender for 7/8" to 1-1/4" thick ceilings
- Integral gun sights facilitate the use of guide strings or laser lines
- Shipped with overspray protector installed

Housing

- Steel housing painted matte black for a visually dark interior
- Removable top allows service from above

Bar Hangers

- GOT NAIL! Gen 3 bar hangers adjust from 10-1/2" to 24" wide
- Pass thru feature allows shortening without removal
- Captive nail penetrates standard and engineered lumber
- Mounting flange levels platform with ceiling
- Integral clip attaches directly to tee-bar

Gaskets

- Gaskets achieve restrictive airflow requirements without additional caulking

Adjustment Mechanism

- Rotates 360°, tilts 45° and locks in position maintaining any aiming angle
- Angle markings assist in repeatable settings
- Translating center beam optics aligns axis of primary reflector with aperture from nadir to 45°

Trim Retention

- Attached by (8) rare earth Neodymium magnets, holds trim securely to the ceiling
- Tether secures trim to housing during service or adjustment

LED Module

- LED array is field replaceable
- Proximity phosphors over chip on board LEDs provide a uniform source with high efficiency and no pixilation
- Color accuracy within 3 SDCM and 90 CRI minimum
- Passive cooling achieves L70 at 50,000 hours

Primary Optic

- Precision molded optics deliver highly efficient and uniform patterns
- Various patterns are available and can be interchanged without tools

Media

- Integral media holder accepts up to (2) 2" diameter 3.0mm thick color filters or lens
- Order color filters and lens separately

Trims

- Die cast aluminum trims are available in open, lens and lens wall wash styles
- Polymer non-conductive trim meets many local code requirements for 'dead front'
- Physical and optical cutoff provides visual comfort
- Light trap eliminates spill light with flange
- Multiple finishes to match many décors
- Available in self-flanged or rimless styles with optional rimless adaptor accessory

Shielding

- Micro-prismatic lens standard with lens trims
- Hinged to allow rimless trim removal

Driver

- Field replaceable constant current driver provides noise free operation
- UNV 120-277VAC 50/60Hz input
- Continuous, flicker-free 1% dimming, available with LE and TE phase cut (at 120V only) and 0-10V analog control

Junction Box

- Galvanized steel junction box with 18in3 internal volume
- Listed for (12) #12 AWG 90° C splice conductors
- (7) 1/2" conduit pry-outs positioned to allow straight conduit runs
- (3) Slide-N-Side™ non-metallic (NM) wire traps
- Accepts 14-2, 14-3, 12-2, 12-3 U.S. and 14-2, 14-3, 12-2 Canadian NM cable
- (3) 4-port push wire nuts mains voltage connections

Compliance

- Type IC inherently protected, suitable for direct contact to air permeable insulation and cULus listed for damp locations
- Not for use in direct contact with spray foam insulation, consult NEMA LSD57-2013
- Wet location listed in covered ceilings and IP44 certified with select trims
- Airtight per ASTM-E283-04
- Suitable for use in clothes closets when installed in accordance with the NEC 410.16 spacing requirements
- EMI/RFI emissions per FCC 47CFR Part 15 consumer limits
- Contains no mercury or lead and RoHS compliant
- Photometric testing in accordance with IES LM-79-08
- Lumen maintenance projections in accordance with IES LM-80-08 and TM-21-11
- Can be used for State of California Title 24 high efficacy LED compliance under JA8, reference Modernized Appliance Efficiency Database System (MAEDBS) for 2016 JA8 High Efficacy Lighting
- ENERGY STAR® certified, reference certified light fixtures database

HL3 Square Trim Series

Use with HL36SA Series Housings

Directional Open

TLS3R Square Reflector, Open, Self Flanged



- Recessed 3-inch aperture LED downlight / directional with field interchangeable optics provide various distribution patterns.
- Ideal for accent, task and general area lighting.
- Housing is airtight, suitable for 2x6 residential or shallow plenum commercial constructions.
- Can be used in direct contact with insulation.
- Trims are available in a range of finishes and can be installed rimless with an optional rimless adapter.
- Use where high efficiency, excellent light control and low aperture brightness are required.



TLS3RH
Semi-specular clear reflector and flange



TLS3RHWF
Semi-specular clear reflector and matte white flange



TLS3RBN
Brushed nickel reflector and flange



TLS3RORB
Oil rubbed bronze reflector and flange



TLS3RMW
Matte white reflector and flange



TLS3RMB
Matte white reflector and flange

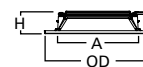

Dimensions**
A: 3.22" [81.67mm]
H: .77" [19.43mm]
OD: 4.36" [110.84mm]

TLS3RMWRL Square Reflector, Open, Rimless



- Recessed 3-inch aperture LED downlight / directional with field interchangeable optics provide various distribution patterns.
- Ideal for accent, task and general area lighting.
- Housing is airtight, suitable for 2x6 residential or shallow plenum commercial constructions.
- Can be used in direct contact with insulation.
- Trims are available in a range of finishes and can be installed rimless with an optional rimless adapter.
- Use where high efficiency, excellent light control and low aperture brightness are required.



TLS3RMWRL
Matte white reflector and flange

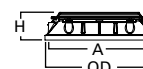

Dimensions**
A: 3.44" [87.41mm]
H: .74" [18.88mm]
OD: 3.56" [90.42mm]

TLS3BBWF / TLS3WBWF Square Baffle, Open, Self Flanged



- Recessed 3-inch aperture LED downlight / directional with field interchangeable optics provide various distribution patterns.
- Ideal for accent, task and general area lighting.
- Housing is airtight, suitable for 2x6 residential or shallow plenum commercial constructions.
- Can be used in direct contact with insulation.
- Trims are available in a range of finishes and can be installed rimless with an optional rimless adapter.
- Use where high efficiency, excellent light control and low aperture brightness are required.



TLS3BBWF
Matte black baffle, matte white flange



TLS3WBWF
Matte white baffle, matte white flange

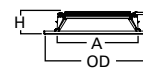

Dimensions**
A: 3.22" [81.67mm]
H: .77" [19.43mm]
OD: 4.36" [110.84mm]

TLS3PIN Square Pinhole w/Oculus, Open, Self Flanged



- Recessed 3-inch aperture LED downlight / directional with field interchangeable optics provide various distribution patterns.
- Ideal for accent, task and general area lighting.
- Housing is airtight, suitable for 2x6 residential or shallow plenum commercial constructions.
- Can be used in direct contact with insulation.
- Trims are available in a range of finishes and can be installed rimless with an optional rimless adapter.
- Use where high efficiency, excellent light control and low aperture brightness are required.



TLS3PINBNBB
Brushed nickel flange, black oculus



TLS3PINORBBB
Oil rubbed bronze flange, black oculus



TLS3PINMWWB
Matte white flange, white oculus



TLS3PINMWBB
Matte white flange, black oculus



TLS3PINMBBB
Matte black flange, black oculus

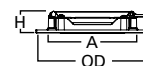

Dimensions**
A: 3.38" [85.86mm]
H: .82" [20.83mm]
OD: 4.36" [110.84mm]

**Key: A: Luminous Aperture, H: Height, OD: Trim Outside Diameter

HL3 Square Trim Series

Use with HL36SA Series Housings



TLS3PINMWWBRL Square Pinhole w/Oculus, Open, Rimless

- Recessed 3-inch aperture LED downlight / directional with field interchangeable optics provide various distribution patterns.
- Ideal for accent, task and general area lighting.
- Housing is airtight, suitable for 2x6 residential or shallow plenum commercial constructions.
- Can be used in direct contact with insulation.
- Trims are available in a range of finishes and can be installed rimless with an optional rimless adapter.
- Use where high efficiency, excellent light control and low aperture brightness are required.



TLS3PINMWWBRL
Matte white flange,
white oculus



Dimensions**
A: 3.39" [86.20mm]
H: .84" [21.29mm]
OD: 3.56" [90.42mm]

Directional Lens

TLS3R2G Conical Reflector, Diffuse Lens, Self Flanged



- Recessed 3-inch aperture LED downlight / directional with field interchangeable optics provide various distribution patterns.
- Ideal for accent, task and general area lighting.
- Housing is airtight, suitable for 2x6 residential or shallow plenum commercial constructions.
- Can be used in direct contact with insulation.
- Trims are available in a range of finishes and can be installed rimless with an optional rimless adapter.
- Use where high efficiency, excellent light control and low aperture brightness are required.



TLS3R2GH
Semi-specular clear reflector
and flange



TLS3R2GHWF
Semi-specular clear reflector
and matte white flange



TLS3R2GBN
Brushed nickel reflector
and flange

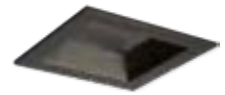

TLS3R2GORB
Oil rubbed bronze reflector
and flange



TLS3R2GMW
Matte white reflector
and flange



TLS3R2GMB
Matte white reflector
and flange

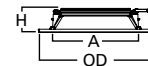

Dimensions**
A: 3.22" [81.67mm]
H: .77" [19.43mm]
OD: 4.36" [110.84mm]

TLS3R2GMWRL Square Reflector, Diffuse Lens, Rimless



- Recessed 3-inch aperture LED downlight / directional with field interchangeable optics provide various distribution patterns.
- Ideal for accent, task and general area lighting.
- Housing is airtight, suitable for 2x6 residential or shallow plenum commercial constructions.
- Can be used in direct contact with insulation.
- Trims are available in a range of finishes and can be installed rimless with an optional rimless adapter.
- Use where high efficiency, excellent light control and low aperture brightness are required.



TLS3R2GMWRL
matte white reflector
and flange

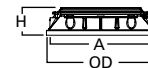

Dimensions**
A: 3.44" [87.41mm]
H: .74" [18.88mm]
OD: 3.56" [90.42mm]

TLS3PR2GMW Square Polymer Reflector, Diffuse Lens, Self Flanged



- Recessed 3-inch aperture LED downlight / directional with field interchangeable optics provide various distribution patterns.
- Ideal for accent, task and general area lighting.
- Housing is airtight, suitable for 2x6 residential or shallow plenum commercial constructions.
- Can be used in direct contact with insulation.
- Trims are available in a range of finishes and can be installed rimless with an optional rimless adapter.
- Use where high efficiency, excellent light control and low aperture brightness are required.



TLS3PR2GMW
Matte white reflector
and flange

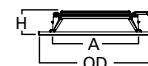

Dimensions**
A: 3.22" [81.67mm]
H: .77" [19.43mm]
OD: 4.36" [110.84mm]

**Key: A: Luminous Aperture, H: Height, ID: Trim Inside Diameter, OD: Trim Outside Diameter

HL3 Square Trim Series

Use with HL36SA Series Housings



TLS3R2GBBWF / TLS3R2GWBWF Square Baffle, Diffuse Lens, Self Flanged

- Recessed 3-inch aperture LED downlight / directional with field interchangeable optics provide various distribution patterns.
- Ideal for accent, task and general area lighting.
- Housing is airtight, suitable for 2x6 residential or shallow plenum commercial constructions.
- Can be used in direct contact with insulation.
- Trims are available in a range of finishes and can be installed rimless with an optional rimless adapter.
- Use where high efficiency, excellent light control and low aperture brightness are required.



TLS3R2GBBWF
Matte black baffle,
matte white flange



TLS3R2GWBWF
Matte white baffle,
matte white flange



Dimensions**
A: 3.22" [81.67mm]
H: .77" [19.43mm]
OD: 4.36" [110.84mm]

TLS3PIN2G Square Pinhole w/Oculus, Diffuse Lens, Self Flanged



- Recessed 3-inch aperture LED downlight / directional with field interchangeable optics provide various distribution patterns.
- Ideal for accent, task and general area lighting.
- Housing is airtight, suitable for 2x6 residential or shallow plenum commercial constructions.
- Can be used in direct contact with insulation.
- Trims are available in a range of finishes and can be installed rimless with an optional rimless adapter.
- Use where high efficiency, excellent light control and low aperture brightness are required.



TLS3PIN2GBNBB
Brushed nickel flange,
black oculus



TLS3PIN2GORBBB
Oil rubbed bronze flange,
black oculus



TLS3PIN2GMWWB
Matte white flange,
white oculus



TLS3PIN2GMWBB
Matte white flange,
black oculus



TLS3PIN2GMBBB
Matte black flange,
black oculus

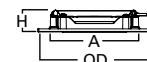

Dimensions**
A: 3.38" [85.86mm]
H: .82" [20.83mm]
OD: 4.36" [110.84mm]

TLS3PIN2GMWWBRL Square Pinhole w/Oculus, Diffuse Lens, Rimless



- Recessed 3-inch aperture LED downlight / directional with field interchangeable optics provide various distribution patterns.
- Ideal for accent, task and general area lighting.
- Housing is airtight, suitable for 2x6 residential or shallow plenum commercial constructions.
- Can be used in direct contact with insulation.
- Trims are available in a range of finishes and can be installed rimless with an optional rimless adapter.
- Use where high efficiency, excellent light control and low aperture brightness are required.



TLS3PIN2GMWWBRL
Matte white flange,
white oculus

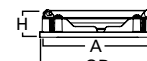

Dimensions**
A: 3.39" [86.20mm]
H: .84" [21.29mm]
OD: 3.56" [90.42mm]

**Key: A: Luminous Aperture, H: Height, OD: Trim Outside Diameter

HL3 Square Trim Series

Use with HL36SA Series Housings

Lens Wall Wash



TLS3LWW6G Square Angle Cut Lens Wall Wash, Self Flanged

- Recessed 3-inch aperture LED downlight / directional with field interchangeable optics provide various distribution patterns.
- Ideal for accent, task and general area lighting.
- Housing is airtight, suitable for 2x6 residential or shallow plenum commercial constructions.
- Can be used in direct contact with insulation.
- Trims are available in a range of finishes and can be installed rimless with an optional rimless adapter.
- Use where high efficiency, excellent light control and low aperture brightness are required



TLS3LWW6GH
Semi-specular clear reflector and flange



TLS3LWW6GHWF
Semi-specular clear reflector and matte white flange



TLS3LWW6GMW
Matte white reflector and flange

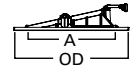

Dimensions**
A: 3.48" [88.42mm]
OD: 4.36" [110.84mm]

TLS3LWW6GMWRL Square Angle Cut Lens Wall Wash, Rimless



- Recessed 3-inch aperture LED downlight / directional with field interchangeable optics provide various distribution patterns.
- Ideal for accent, task and general area lighting.
- Housing is airtight, suitable for 2x6 residential or shallow plenum commercial constructions.
- Can be used in direct contact with insulation.
- Trims are available in a range of finishes and can be installed rimless with an optional rimless adapter.
- Use where high efficiency, excellent light control and low aperture brightness are required



TLS3LWW6GMWRL
Matte white reflector and flange

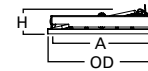

Dimensions**
A: 3.33" [84.53mm]
H: .87" [22.10mm]
OD: 3.56" [90.42mm]

Key: **A: Luminous Aperture, **H:** Height, **ID:** Trim Inside Diameter, **OD:** Trim Outside Diameter

H4 LED Series Housing

H457ICAT1E

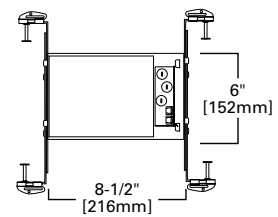
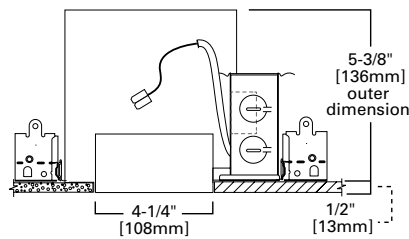

H457ICAT1E

4" IC, Air-Tite, Shallow New Construction, LED Housing

The Halo H4 LED is a family of 4" aperture recessed downlight H457 series of housings designed for exclusive use with Halo EL406, ELG406, ELSG406 series LED light engines and compatible 4" TL4 and TLS4 LED trims. Halo H4 LED housings have LED drivers that offer dimming as a standard feature. This is an insulated ceiling* Air-Tite™ housing offering 120 volt dimming capability. The H4 LED series offers high quality downlighting along with high efficacy – the result being great lighting and significant energy savings.



Special Features

- Got Nail!™ bar hangers
- Pass-N-Thru™ bars
- Slide-N-Side™ junction box
- Quick Connect™ push wire nuts
- Air-Tite™ code compliant

Compatible Light Engines

EL406927	ELG406927	ELSG406927
EL406930	ELG406930	ELSG406930
EL406935	ELG406935	ELSG406935
EL406940	ELG406940	ELSG406940

Compatible Trims

TL402	TL409	TL411
TL403	TL410	TL422
TL408		

Features

Housing

- Enclosure of formed aluminum construction
- Openings are gasketed Air-Tite
- Designed for insulated ceilings in direct contact with insulation* (May also be installed in non-insulated ceilings)

Plaster Frame

- Galvanized steel die-formed construction
- The collar can be removed from plaster frame to provide access to the junction box
- Collar adjusts for ceilings up to 1-1/4" thick
- Plaster frame features include:
 - Patented regressed locking screw positioned for securing hanger bars from below the ceiling
 - Cutouts for easily crimping hanger bars in position
 - Air-Tite aperture gasket is pre-installed
 - Halo identity embossed on plaster frame

Includes:

- Got Nail!™ bar hangers (Details Pg. 13)
- Pass-N-Thru™ bars (Details Pg. 13)
- Slide-N-Side™ junction box wire traps (Details Pg. 13)
- Quick Connect™ push wire nuts (Details Pg. 13)
- Air-Tite™ code compliant (Details Pg. 13)

LED Light Engine Connection

- LED connector is a non-screw base connector offering easy installation with the H4 LED EL406, ELG406, ELSG406 series LED light engines
- This non-screw base connection preserves the high efficacy rating and prevents use of low efficacy sources (see LED module specification)

LED Driver

- LED dimmable driver mounts in the junction box.
- Driver is a 120 volt, high efficiency, electronic power supply providing low voltage power to EL series LED light engines
- Driver meets FCC EMI/RFI consumer level limits for use in residential and commercial installations
- Driver features high power factor and low THD and has integral thermal protection in the event of over temperature or internal failure
- If dimming is not required the fixture can be operated from a standard wall switch

Dimming

- Designed for continuous dimming capability to nominally 5% with many 120V Leading Edge (LE) and Trailing Edge (TE) phase control dimmers. Dimmers with low end trim adjustment offer greater assurance of achieving 5% level.
- Consult dimmer manufacturer for compatibility and conditions of use (Note, some dimmers require a neutral in the wallbox)

Compliance

- cULus Listed 1598 luminaire
- cULus Listed for damp location
- cULus Listed for wet location, covered ceiling, with select trims
- cULus Listed for direct contact with insulation* and combustible material
- Use with designated HALO LED systems for ENERGY STAR® certification
- Can be used for State of California Title 24 high efficacy luminaire compliance with EL series LED light engines
- Can be used for International Energy Conservation Code (IECC) high efficacy luminaire compliance
- Air-Tite code compliant. Certified under ASTM E283; not exceeding 2.0 cfm (0.944 L/s) air leakage rate tested at a 1.57 psf (75 Pa) pressure differential

*Not to be used in direct contact with spray foam insulation (consult NEMA LSD57-2013)

H457ICAT1E Energy Data

H4 Series LED (Values at non-dimming line voltage)

Minimum Starting Temp: -30°C (-22°F)

EMI/RFI: FCC Title 47 CFR, Part 18, (Consumer)

Sound Rating: Class A standards

Input Voltage: 120V

Power Factor: >0.90

Input Frequency: 50/60Hz

THD: <20%

Input Power: 13W

Input Current: 121mA

Driver Compliance: UL6950, LPS rated

H4 LED Lighting System

A LED Housing



B LED Light Engine



C LED Trim



OR

B/C LED Adjustable Gimbal and Light Engine



H4 LED Series Housing

H457RICAT1E

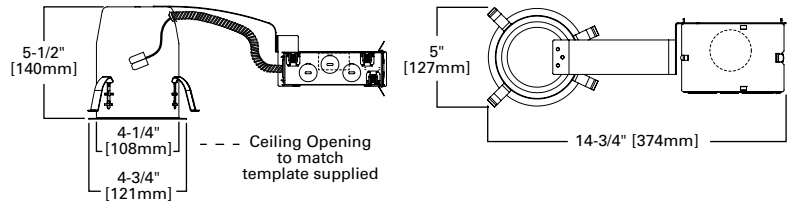

H457RICAT1E

4" IC, Air-Tite, Shallow Remodel, LED Housing

The Halo H4 LED is a family of 4" aperture recessed downlight H457 series of housings designed for exclusive use with Halo EL406, ELG406, ELSG406 series LED light engines and compatible TL4 and TLS4 LED trims. Halo H4 LED housings have LED drivers that offer dimming as a standard feature. This is an insulated ceiling*, Air-Tite™, remodel housing offering 120 Volt dimming capability. The H4 LED series offers high quality downlighting along with high efficacy – the result being great lighting and significant energy savings.



Special Features

- Slide-N-Side™ junction box
- Quick Connect™ push wire nuts
- Air-Tite™ code compliant

Compatible Light Engines

EL406927	ELG406927	ELSG406927
EL406930	ELG406930	ELSG406930
EL406935	ELG406935	ELSG406935
EL406940	ELG406940	ELSG406940

Compatible Trims

TL402	TL409	TL411
TL403	TL410	TL422
TL408		

Features

Housing

Single wall formed aluminum construction. Openings are gasketed for Air-Tite installation. 5-1/2" height allows use in shallow joist construction. Air-Tite aperture gasket is pre-installed.

Remodel Arm

Spring steel construction designed for ease of installation and ceiling support of LED driver

Remodel Springs

Four remodel clips secure housing and accommodate 1/2" and 5/8" ceiling material

Includes:

- Slide-N-Side™ junction box wire traps (Details Pg. 13)
- Air-Tite™ code compliant (Details Pg. 13)
- Quick Connect™ push wire nuts (Details Pg. 13)

LED Light Engine Connection

- LED connector is a non-screw base connector offering easy installation with the H4 LED EL406, ELG406, ELSG406 series LED light engines
- This non-screw base connection preserves the high efficacy rating and prevents use of low efficacy sources (See LED module specification)

LED Driver

- LED dimmable driver mounts in the junction box
- Driver is a 120 Volt, high efficiency, electronic power supply providing low voltage power to EL series LED light engines
- Driver meets FCC EMI/RFI consumer level limits for use in residential and commercial installations
- Driver features high power factor and low THD and has integral thermal protection in the event of over temperature or internal failure
- If dimming is not required the fixture can be operated from a standard wall switch

Dimming

- Designed for continuous dimming capability to nominally 5% with many 120V Leading Edge (LE) and Trailing Edge (TE) phase control dimmers. Dimmers with low end trim adjustment offer greater assurance of achieving 5% level.
- Consult dimmer manufacturer for compatibility and conditions of use (Note, some dimmers require a neutral in the wallbox)

Compliance

- cULus Listed 1598 luminaire
- cULus Listed for damp location
- cULus Listed for wet location, covered ceiling, with select trims
- cULus Listed for direct contact with insulation and combustible material
- Use with designated HALO LED systems for ENERGY STAR® certification
- Can be used for State of California Title 24 high efficacy luminaire compliance with EL series LED light engines
- Can be used for International Energy Conservation Code (IECC) high efficacy luminaire compliance
- Air-Tite code compliant. Certified under ASTM E283; not exceeding 2.0 cfm (0.944 L/s) air leakage rate tested at a 1.57 psf (75 Pa) pressure differential.

*Not to be used in direct contact with spray foam insulation (consult NEMA LSD57-2013)

H457RICAT1E Energy Data

H4 Series LED (Values at non-dimming line voltage)

Minimum Starting Temp: -30°C (-22°F)

EMI/RFI: FCC Title 47 CFR, Part 18, (Consumer)

Sound Rating: Class A standards

Input Voltage: 120V

Power Factor: >0.90

Input Frequency: 50/60Hz

THD: <20%

Input Power: 13W

Input Current: 120mA

Driver Compliance: UL8750, Class II rated

H4 LED Lighting System

A LED Housing



B LED Light Engine



C LED Trim



OR

B/C LED Adjustable Gimbal and Light Engine



H4 LED Series Housing

H457TATE010

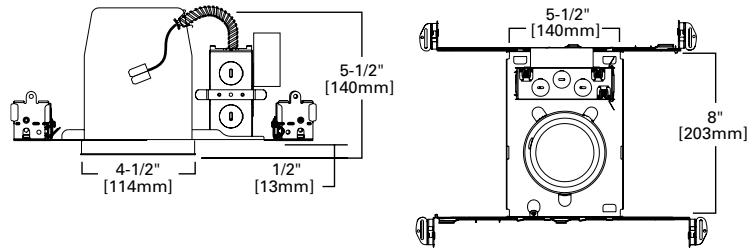

H457TATE010

4" Non-IC, Shallow New Construction, Dimmable LED Housing

The Halo H4 LED is a family of 4" aperture recessed downlight H457 series of housings designed for exclusive use with Halo EL406, ELG406, ELSG406 series LED light engines and compatible 4" TL4 and TLS4 LED trims. Halo H4 LED housings have integral LED drivers that offer dimming as a standard feature.

This is a Non-IC, Air-Tite™ housing for non-insulated ceiling installations, universal voltage 120V-277V input, and dimming with either 120V phase control dimmers, or 0-10V DC control systems. The H4 LED series offers high quality downlighting along with high efficacy – the result being great lighting and significant energy savings.



Special Features

- Got Nail!™ bar hangers
- Pass-N-Thru™ bars
- Slide-N-Side™ junction box
- Quick Connect™ push wire nuts
- Air-Tite™ code compliant

Compatible Light Engines

EL406927	ELG406927	ELSG406927
EL406930	ELG406930	ELSG406930
EL406935	ELG406935	ELSG406935
EL406940	ELG406940	ELSG406940

Compatible Trims

TL402	TL409	TL411
TL403	TL410	TL422
TL408		

Features

Housing

- Single wall die-formed construction
- Openings are gasketed

Plaster Frame

- Galvanized steel die-formed construction
- Housing can be removed from plaster frame for access to junction box
- Housing adjusts for ceilings up to 1" thickness
- Plaster frame features include:
 - Patented regressed locking screw positioned for securing hanger bars from below the ceiling
 - Cutouts for easily crimping hanger bars in position
 - Air-Tite aperture gasket is pre-installed
 - Halo identity embossed on plaster frame

Includes:

- Got Nail!™ bar hangers (Details Pg. 13)
- Pass-N-Thru™ bars (Details Pg. 13)
- Slide-N-Side™ junction box wire traps (Details Pg. 13)
- Quick Connect™ push wire nuts (Details Pg. 13)
- Air-Tite™ code compliant (Details Pg. 13)

LED Light Engine Connection

- LED connector is a non-screw base connector offering easy installation with the H4 LED EL406, ELG406, ELSG406 series LED light engines
- This non-screw base connection preserves the high efficacy rating and prevents use of low efficacy sources (See LED module specification)

LED Driver

- LED dimmable driver mounts to the housing junction box
- Driver is a 120V-277V universal voltage, high efficiency, electronic power supply providing low voltage power to EL series LED light engines
- Driver meets FCC EMI/RFI consumer level limits for use in residential and commercial installations
- Driver features high power factor and low THD, and has integral thermal protection in the event of over temperature or internal failure
- If dimming is not required the fixture can be operated from a standard wall switch

Dimming - Phase Control

Designed for continuous dimming to nominally 5% with many 120V Leading Edge (LE) and Trailing Edge (TE) phase control dimmers. Dimming to 5% is best assured using dimmers with low end trim adjustment. Consult dimmer manufacturer for compatibility and conditions of use. (Note, some dimmers require a neutral in the wallbox)

Dimming - 0-10V

- Dimmable to 10% with compatible 0-10V DC low voltage dimmers
- 0-10V DC dimmers operate using two low voltage dimming wires (color coded violet and gray). The low voltage dimming wires are separate from the 120V AC or 277V AC power.
- Switching on/off is controlled via the line voltage (120V AC or 277V AC) power, and dimming is controlled via the 2-wire 0-10V DC low voltage wiring

Compliance

- cULus Listed 1598 luminaire
- cULus Listed for damp location
- cULus Listed for wet location, covered ceiling, with select trims
- For non-insulated ceilings. If ceiling insulation is present, it must be kept 3 inches from all sides of housing.
- Use with designated HALO LED systems for ENERGY STAR® certification
- Can be used to comply with State of California Title 24 non-residential lighting controls requirements as part of an LED luminaire
- Air-Tite code compliant. Certified under ASTM E283; not exceeding 2.0 cfm (0.944 L/s) air leakage rate tested at a 1.57 psf (75 Pa) pressure differential

H457TATE010 Energy Data

H4 Series LED (Values at non-dimming line voltage)

Minimum Starting Temp: -30°C (-22°F)

EMI/RFI: FCC Title 47 CFR, Part 18, (Consumer)

Sound Rating: Class A standards

Input Voltage: 120V-277V

Power Factor: >0.90

Input Frequency: 50/60Hz

THD: <25%

Input Power: 13W

Input Current: 121mA

Driver Compliance: UL8750, Class II rated

H4 LED Lighting System



H4 LED Series Housing

H457RTATE010

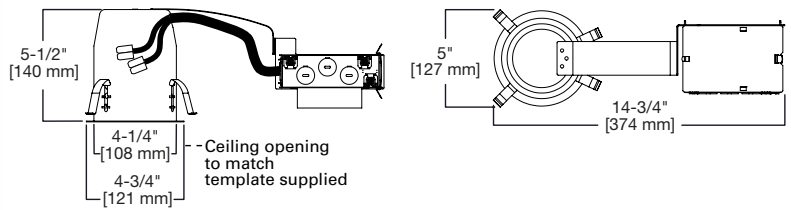

4" Non-IC, Shallow Remodel, Dimmable LED Housing

The Halo H4 LED is a family of 4" aperture recessed downlight H457 series of housings designed for exclusive use with Halo EL406, ELG406, ELSG406 series LED light engines and compatible 4" TL4 and TLS4 LED trims. Halo H4 LED housings have integral LED drivers that offer dimming as a standard feature. This is a Non-IC, Air-Tite™ remodel housing designed for non-insulated ceiling installations, universal voltage 120V-277V input, and dimming with either 120V phase control dimmers, or 0-10V DC control systems. The H4 LED series offers high quality downlighting along with high efficacy – the result being great lighting and significant energy savings.



Special Features

- Slide-N-Side™ junction box
- Quick Connect™ push wire nuts
- Air-Tite™ code compliant

Compatible Light Engines

EL406927	ELG406927	ELSG406927
EL406930	ELG406930	ELSG406930
EL406935	ELG406935	ELSG406935
EL406940	ELG406940	ELSG406940

Compatible Trims

TL402	TL409	TL411
TL403	TL410	TL422
TL408		

Features

Housing

Single wall aluminum housing. Openings are gasketed for Air-Tite installation. 5-1/2" height allows use in shallow joist construction. Air-Tite aperture gasket is pre-installed.

Remodel Arm

Spring steel construction designed for ease of installation and ceiling support of LED driver

Remodel Springs

Four remodel clips secure housing and accommodate 1/2" and 5/8" ceiling material

Includes:

- Air-Tite™ code compliant (Details Pg. 13)
- Slide-N-Side™ junction box wire traps (Details Pg. 13)
- Quick Connect™ push wire nuts (Details Pg. 13)

LED Light Engine Connection

- LED connector is a non-screw base connector offering easy installation with the H4 LED EL406, ELG406, ELSG406 series LED light engines
- This non-screw base connection preserves the high efficacy rating and prevents use of low efficacy sources (See LED module specification)

LED Driver

- LED dimmable driver mounts to the housing junction box
- Driver is a 120V-277V universal voltage, high efficiency, electronic power supply providing low voltage power to EL series LED light engines
- Driver meets FCC EMI/RFI consumer level limits for use in residential and commercial installations
- Driver features high power factor and low THD and has integral thermal protection in the event of over temperature or internal failure
- If dimming is not required the fixture can be operated from a standard wall switch

Dimming - Phase Control

Designed for continuous dimming to nominally 5% with many 120V Leading Edge (LE) and Trailing Edge (TE) phase control dimmers. Dimming to 5% is best assured using dimmers with low end trim adjustment. Consult dimmer manufacturer for compatibility and conditions of use. (Note, some dimmers require a neutral in the wallbox)

Dimming - 0-10V

- Dimmable to 10% with compatible 0-10V DC low voltage dimmers
- 0-10V DC dimmers operate using two low voltage dimming wires (color coded violet and gray). The low voltage dimming wires are separate from the 120V AC or 277V AC power.

- Switching on/off is controlled via the line voltage (120V AC or 277V AC) power, and dimming is controlled via the 2-wire 0-10V DC low voltage wiring

Compliance

- cULus Listed 1598 luminaire
- cULus Listed for damp location
- cULus Listed for wet location, covered ceiling, with select trims
- Air-Tite code compliant. Certified under ASTM E283; not exceeding 2.0 cfm (0.944 L/s) air leakage rate tested at a 1.57 psf (75 Pa) pressure differential
- Use with designated HALO LED systems for ENERGY STAR® certification
- Can be used to comply with State of California Title 24 non-residential lighting controls requirements as part of an LED luminaire
- For non-insulated ceilings. If ceiling insulation is present, it must be kept 3 inches from all sides of housing.

H457RTATE010 Energy Data

H4 Series LED (Values at non-dimming line voltage)

Minimum Starting Temp: -30°C (-22°F)

EMI/RFI: FCC Title 47 CFR, Part 15, (Consumer)

Sound Rating: Class A standards

Input Voltage: 120V-277V

Power Factor: >0.90

Input Frequency: 50/60Hz

THD: <25%

Input Power: 13W

Input Current: 121mA

Driver Compliance: UL8750, Class II rated

H4 LED Lighting System



H4 LED Series Housing

H457TCPE010

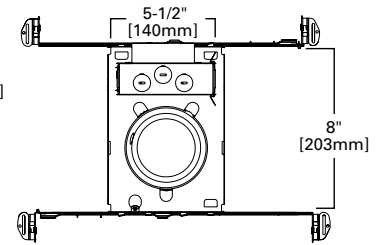
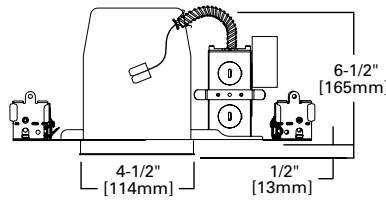

H457TCPE010

4" Non-IC, New Construction, Dimmable LED Housing, Chicago Plenum

The Halo H4 LED is a family of 4" aperture recessed downlight H457 series of housings designed for exclusive use with Halo EL406, ELG406, ELSG406 series LED light engines and compatible 4" TL4 and TLS4 LED trims. Halo H4 LED housings have integral LED drivers that offer dimming as a standard feature. This is a Non-IC, Air-Tite™ housing for non-insulated Chicago Plenum rated installations, universal voltage 120V-277V input, and dimming with either 120V phase control dimmers, or 0-10V DC control systems. The H4 LED series offers high quality downlighting along with high efficacy – the result being great lighting and significant energy savings.



Special Features

- Got Nail!™ bar hangers
- Pass-N-Thru™ bars
- Quick Connect™ push wire nuts
- Air-Tite™ code compliant

Compatible Light Engines

EL406927	ELG406927	ELSG406927
EL406930	ELG406930	ELSG406930
EL406935	ELG406935	ELSG406935
EL406940	ELG406940	ELSG406940

Compatible Trims

TL402	TL409	TL411
TL403	TL410	TL422
TL408		

Features

Housing

- Single wall die-formed construction
- Constructed and gasketed to meet Chicago CCEA requirements
- Sealed flex connection from junction box to housing for Chicago Plenum rating
- Openings are gasketed for Air-Tite installation (in Non-IC ceilings)

Plaster Frame

- Galvanized steel die-formed construction
- Housing can be removed from plaster frame for access to junction box
- Housing adjusts for ceilings up to 1-1/4" thickness
- Plaster frame features include:
 - Patented regressed locking screw positioned for securing hanger bars from below the ceiling
 - Cutouts for easily crimping hanger bars in position
 - Air-Tite aperture gasket is pre-installed
- Halo identity embossed on plaster frame

Includes:

- Got Nail!™ bar hangers (Details Pg. 13)
- Pass-N-Thru™ bars (Details Pg. 13)
- Quick Connect™ push wire nuts (Details Pg. 13)
- Air-Tite™ code compliant (Details Pg. 13)

LED Light Engine Connection

- LED connector is a non-screw base connector offering easy installation with the H4 LED 2nd generation EL406, ELG406, ELSG406 series LED light engines
- This non-screw base connection preserves the high efficacy rating and prevents use of low efficacy sources (See LED module specification)

LED Driver

- LED dimmable driver mounts to the housing junction box
- Driver is a 120V-277V universal voltage, high efficiency, electronic power supply providing low voltage power to EL series LED light engines
- Driver meets FCC EMI/RFI consumer level limits for use in residential and commercial installations
- Driver features high power factor and low THD and has integral thermal protection in the event of over temperature or internal failure
- If dimming is not required the fixture can be operated from a standard wall switch

Dimming - Phase Control

Designed for continuous dimming to nominally 5% with many 120V Leading Edge (LE) and Trailing Edge (TE) phase control dimmers. Dimming to 5% is best assured using dimmers with low end trim adjustment. Consult dimmer manufacturer for compatibility and conditions of use. (Note, some dimmers require a neutral in the wallbox)

Dimming - 0-10V

- Dimmable to 10% with compatible 0-10V DC low voltage dimmers

- 0-10V DC dimmers operate using two low voltage dimming wires (color coded violet and gray). The low voltage dimming wires are separate from the 120V AC or 277V AC power.
- Switching on/off is controlled via the line voltage (120V AC or 277V AC) power, and dimming is controlled via the 2-wire 0-10V DC low voltage wiring

Compliance

- cULus Listed 1598 luminaire
- cULus Listed for damp location
- cULus Listed for wet location, covered ceiling, with select trims
- Meets City of Chicago Plenum requirements
- For non-insulated ceilings. If ceiling insulation is present, it must be kept 3 inches from all sides of housing
- Use with designated HALO LED systems for ENERGY STAR® certification
- Air-Tite code compliant. Certified under ASTM E283; not exceeding 2.0 cfm (0.944 L/s) air leakage rate tested at a 1.57 psf (75 Pa) pressure differential
- Can be used to comply with The State of California Title 24 non residential lighting controls as part of an LED luminaire

H457TCPE010 Energy Data

H4 Series LED (Values at non-dimming line voltage)

Minimum Starting Temp: -30°C (-22°F)

EMI/RFI: FCC Title 47 CFR, Part 18, (Consumer)

Sound Rating: Class A standards

Input Voltage: 120V-277V

Power Factor: >0.90

Input Frequency: 50/60Hz

THD: <25%

Input Power: 13W

Input Current: 121mA

Driver Compliance: UL8750, Class II rated

H4 LED Lighting System



H4 LED Series Light Engine

EL4069xx

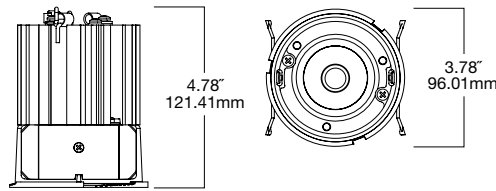

EL4069xx

4" LED Light Engine

The Halo H4 LED is a family of 4" aperture recessed downlights with H457 series housings designed for use with Halo EL406 series LED light engines and compatible TL4 and TLS4 series LED trims. Halo H4 LED is a three part system: EL406 light engines, with TL4/TLS4 trims and H457 housings. H4 LED features 90 CRI color rendering index and offers a superior optical design that yields productive beam lumens, good cutoff and low glare.



Compatible Housings

H457ICAT1E	H457TATE010
H457RICAT1E	H457RTATE010
	H457TCPE010

Compatible Trims

TL402	TL409	TL411
TL403	TL410	TL422
TL408		

Features

Upper Heat Sink

- Durable extruded aluminum construction
- Conducts heat away from the LED keeping the junction temperatures below specified maximums, even when installed in insulated ceilings

Lower Heat Sink

- Durable die-cast aluminum construction
- Precision keyed flange designed to lock with matching keyed slots in H4 trim rings
- Works in conjunction with the upper heat sink for heat conduction away from the LED

Friction Blades:

- Precision formed stainless steel spring blades provide retention of the EL406 series of light engines in the H457 series housings
- Friction blade design allows the light engine to be installed in any position within the housing aperture (360 degrees)

LED Connection

- LED connector is non-screw base offering easy installation with the H457 series housings
- LED connector is compliant with high efficacy luminaire code requirements as a non-screw base socket
- Separate grounding cable included on the module for attachment to the housing during installation

Color Specification & Quality Standards

- Halo employs a tight chromaticity specification and LED color binning process to ensure LED color uniformity, sustainable Color Rendering Index (CRI) and Correlated Color Temperature (CCT) consistency over the useful life of the LED
- Halo H4 LED chromaticity specification is 3 SDCM which exceeds ENERGY STAR® color standards (as per ANSI 78.377)
- Every Halo LED module is quality tested and performance measured on the production line, and serialized to register lumens, wattage, CRI and CCT
- Halo LED's serialized testing and measurement process further ensures color and lumen consistency to meet stringent lighting specifications and exceed ENERGY STAR® and State of California standards

LED

- Correlated Color Temperature (CCT): 2700°K, 3000°K, 3500°K, 4000°K*
- Color Rendering Index (CRI): 90 (R9 > 50)
- LED package consisting of an engineered array of multiple LEDs to create one virtual source, for a productive "cone of light"
- Lumen maintenance L70 at 50,000 hours
- 450-900 lumens, range dependent on CCT and trim*
- Designed for interchangeable trim choices, with selection from multiple reflector, baffle, and lens trim options

Compliance

- Use with designated HALO LED systems for ENERGY STAR® certification
- Can be used to comply with California Title 24 high efficacy requirements. Title 20 Certified for residential compliance.
- International Energy Conservation Code – IECC high efficacy requirements when used with designated LED trims
- LED emits no ultraviolet and only minimal infrared wavelengths
- RoHS compliant
- Wet location listed, protected ceiling with H4 lensed downlight trims
- Electrical/energy data - refer to H457 housings (LED driver is integral to housing)

Selection of Light Engine

Model Number	Nominal CCT
EL406927	2700
EL406930	3000
EL406935	3500
EL406940	4000

*Trim type and color temperature determines the delivered lumen value. Refer to specification sheets and photometric files at www.cooperlighting.com.

H4 LED Lighting System

A LED Housing



B LED Light Engine



C LED Trim



H4 LED Series Trims

Use with EL4069xx Light Engines



TL402 Solite® Regressed Lens Reflector

- Precision formed aluminum reflector
- Die cast trim ring
- Standard trim ring provides clearance for remodeler flange and gasket
- Trim and gasket provides Air-Tite™ installation
- Solite® lens high-clarity low-iron glass for high-lumen transmission and diffusion of source brightness
- Wet location listed, covered ceilings
- Compatible with optional TL400 designer trim rings



TL402SCS
Specular Clear Reflector,
White Trim



TL402SBKS
Specular Black Reflector,
White Trim



TL402HS
Haze Reflector, White Trim



TL402WHS
White Reflector, White Trim



TL402SNS
Satin Nickel Reflector,
Satin Nickel Trim



TL402TBZS
Tuscan Bronze Reflector,
Tuscan Bronze Trim

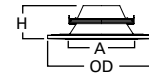

Dimensions**
A: 3-3/8" [86mm]
H: 1-3/4" [43mm]
OD: 5" [129mm]

TL403 Solite® Regressed Lens Baffle

- Precision formed aluminum baffle
- Die cast trim ring
- Standard trim ring provides clearance for remodeler flange and gasket
- Trim and gasket provides Air-Tite™ installation
- Solite® lens high-clarity low-iron glass for high-lumen transmission and diffusion of source brightness
- Wet location listed, covered ceilings
- Compatible with optional TL400 designer trim rings



TL403WBS
White Baffle, White Trim



TL403BBS
Black Baffle, White Trim

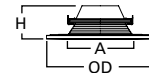

Dimensions**
A: 3-3/8" [86mm]
H: 1-3/4" [43mm]
OD: 5" [129mm]



TL408 Solite® Square Glass Lens Baffle

- Precision formed aluminum baffle
- Die cast trim ring
- Standard trim ring provides clearance for remodeler flange and gasket
- Trim and gasket provides Air-Tite™ installation
- Solite® lens high-clarity low-iron glass for high-lumen transmission and diffusion of source brightness
- Wet location listed, covered ceilings



TL408WHWB
White Baffle,
White Trim



TL408WHBB
Black Baffle,
White Trim



TL408SNBB
Black Baffle,
Satin Nickel Trim



TL408TBZBB
Black Baffle,
Tuscan Bronze Trim

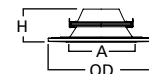

Dimensions**
A: 3-3/8" [86mm]
H: 1-3/4" [43mm]
OD: 5" [129mm]



TL409 Wall Wash Reflector with Diffuse Dome Lens

- Precision formed aluminum reflector
- Die cast trim ring
- Standard trim ring provides clearance for remodeler flange and gasket
- Polymer (plastic) diffusing dome lens
- Wet location listed, covered ceilings
- Trim and gasket provides Air-Tite™ installation
- Compatible with optional TL400 designer trim rings
- High-reflectance, specular wall wash kick reflector



TL409WW
Semi-Specular Clear
Reflector, White Trim
Specular Kick Reflector



TL409WHWW
White Reflector, White Trim
Specular Kick Reflector

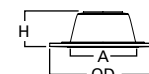

Dimensions**
A: 3-3/8" [86mm]
H: 1-3/4" [43mm]
OD: 5" [129mm]



Solite® is a registered trademark of AGC Flat Glass North America

**Key: A: Luminous Aperture, H: Height, OD: Trim Outside Diameter

H4 LED Series Trims

Use with EL4069xx Light Engines



TL410 Deep Regressed Reflector with Diffuse Dome Lens

- Precision formed aluminum reflector
- Die cast trim ring
- Standard trim ring provides clearance for remodeler flange and gasket
- Trim and gasket provides Air-Tite™ installation
- Polymer (plastic) diffusing dome lens
- Wet location listed, covered ceilings
- Compatible with optional TL400 designer trim rings



TL410SC
Specular Clear Reflector,
White Trim



TL410H
Haze Reflector, White Trim



TL410WH
White Reflector, White Trim



TL410SBK
Specular Black Reflector,
White Trim



TL410SN
Satin Nickel Reflector,
Satin Nickel Trim



TL410TBZ
Tuscan Bronze Reflector,
Tuscan Bronze Trim

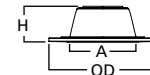

Dimensions**
A: 3-3/8" [86mm]
H: 1-3/4" [43mm]
OD: 5" [129mm]

TL411 Deep Regressed Baffle Trims with Diffuse Dome Lens



- Precision formed aluminum baffle
- Die cast trim ring
- Standard trim ring provides clearance for remodeler flange and gasket
- Trim and gasket provides Air-Tite™ installation
- Polymer (plastic) diffusing dome lens
- Wet location listed, covered ceilings
- Compatible with optional TL400 designer trim rings



TL411WB
White Baffle, White Trim



TL411BB
Black Baffle, White Trim

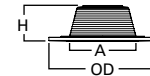

Dimensions**
A: 3-3/8" [86mm]
H: 1-3/4" [43mm]
OD: 5" [129mm]

TL422 "Dead-Front" Polymer Shower Baffle with Prismatic Lens



- Precision formed polymer (plastic) baffle and trim ring
- Prismatic, clear flat polymer (plastic) lens
- Standard trim ring provides clearance for remodeler flange and gasket
- Shower trim front is non-electrically conductive "dead-front"
- Trim and gasket provides Air-Tite™ installation
- Wet location listed, covered ceilings



TL422PS
White Plastic Baffle, Trim Ring
and Prismatic Plastic Lens

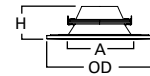

Dimensions**
A: 3-3/8" [86mm]
H: 1-3/4" [43mm]
OD: 5" [129mm]

TL400 Designer Trim Rings



- Optional accessory
- Replaces standard ring included with TL4 round trims
- Die cast trim ring
- Thin tapered profile provides subtle ceiling appearance (0.120" at OD and 0.180" at ID)



TL400PC
Polished Chrome Trim



TL400SBK
Black Trim



TL400WH
White Trim Ring



TL400SN
Satin Nickel Trim Ring



TL400TBZ
Tuscan Bronze Trim

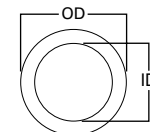

Dimensions**
ID: 3-3/8" [86mm]
OD: 5-1/8" [130mm]

Compatibility

TL402	TL409	TL411
TL403	TL410	

**Key: A: Luminous Aperture, H: Height, ID: Trim Inside Diameter, OD: Trim Outside Diameter

Specifications, compliances and dimensions subject to change without notice

HALO Halo Recessed Catalog - LED Recessed Downlighting

103

H4 LED Series Adjustable/Light Engine

ELG4069xx & ELSG4069xx



ELG4069xx

ELSG4069xx

4" LED Gimbal, 2nd Generation

Halo H4 LED adjustable gimbals, ELG406 series, combine an adjustable gimbal trim and LED light engine for use with H457 series housings. The H4 LED adjustable gimbals feature 35° tilt and offer interchangeable optics with three beam distributions of 25°, 35°, and 50°. H4 LED offers 90 CRI color rendering index and four color temperatures 2700K, 3000K, 3500K, 4000K. Three high-quality trim finishes of white, satin nickel, and tuscan bronze are available. Halo LED offers high quality, fit, finish, and performance in an energy-efficient, high efficacy gimbal.

Compatible Housings

H457ICAT1E	H457TATE010
H457RICAT1E	H457RTATE010
	H457TCPE010



Features

Upper Heat Sink

- Durable aluminum construction
- Conducts heat away from the LED keeping the junction temperatures below specified maximums, even when installed in insulated ceiling housings

Gimbal

- Precision designed fit and finish
- Die-cast aluminum with snap-in front loading ring allowing interchange of beam forming reflectors
- Gimbal front ring holds one lens media. Clear glass lens is included. Optional lens media such as L111 soft focus may be used in place of clear glass lens.
- 35° tilt adjustment with friction fit to heat sink
- Smooth travel from nadir to 35°
- Works with the upper heat sink for thermal conduction away from the LED

Friction Blades:

- Precision formed stainless steel spring blades provide retention of the EL406 series of light engines in the H457 series housings
- Friction blade design allows the light engine to be installed in any position within the housing aperture (360 degrees)

LED Connection

- LED connector is non-screw base offering easy installation with the H457 series housings
- LED connector is compliant with high efficacy luminaire code requirements as a non-screw base socket
- Separate grounding cable included on the module for attachment to the housing during installation

Optics

- Three beam distribution options with interchangeable round beam forming reflectors
- Gimbal is supplied with 25° reflector pre-installed
- Reflector options: 25°, 35°, 50° beam angle order (TL412RK kit)
- Clear glass cover lens included with gimbal. One optional accessory lens may be used in place of clear lens.
- Reflector and lens are accessible behind the gimbal's snap-in front ring

Optical Accessory Reflector Kit – TL412RK

- Includes all three reflector options
 - 25° beam angle reflector (one included with gimbal)
 - 35° beam angle reflector
 - 50° beam angle reflector

Color Specification & Quality Standards

- LED is a chip on board design consisting of a multiple LED package with proximity phosphor coating to create one virtual white light source for a productive "cone of light"
- Halo employs a tight chromaticity specification and LED color binning process to ensure LED color uniformity, sustainable Color Rendering Index (CRI) and Correlated Color Temperature (CCT) consistency over the useful life of the LED
- Halo H4 LED chromaticity specification is 3 SDCM which exceeds ENERGY STAR® color standards (as per ANSI 78.377)
- Every Halo LED module is quality tested and performance measured on the production line, and then serialized to register lumens, wattage, CRI and CCT

LED

- Correlated Color Temperature (CCT): 2700°K, 3000°K, 3500°K, 4000°K*
- Color Rendering Index (CRI): 90 (R9 > 50)
- LED emits no ultraviolet and minimal infrared wavelengths
- 700-930 nominal lumens, dependent on CCT and trim*
- Lumen maintenance L70 at 50,000 hours

Compliance

- Use with designated HALO LED systems for ENERGY STAR® certification
- Can be used to comply with California Title 24 high efficacy requirements. Title 20 Certified for residential compliance.
- International Energy Conservation Code (IECC) high efficacy requirements when used with designated LED trims
- RoHS compliant
- Damp location listed with H457 LED housings
- Electrical/Energy Data refer to H457 LED housings (LED driver is integral to housing)

Selection of Gimbal Light Engine

Model Number	Nominal CCT
ELG406927 • ELSG406927	2700
ELG406930 • ELSG406930	3000
ELG406935 • ELSG406935	3500
ELG406940 • ELSG406940	4000

*Trim type and color temperature determines the delivered lumen value. Refer to specification sheets and photometric files at www.cooperlighting.com.

H4 LED Lighting System

A LED Housing

OR

B LED Adjustable Gimbal and Light Engine





HL6 LED AllSlope Slope Ceiling Solutions

Featuring unique interchangeable beam-forming optics, full range dimming and multiple color temperatures and trim options, the Halo AllSlope LED downlight system is specifically designed for slope ceiling applications with pitch aiming from 2/12 (10°) to 12/12 (45°). The innovative design allows the LED light engine full adjustment capability so it can be aimed straight down in accordance with the ceiling pitch, resulting in outstanding performance and appearance. The three piece system consists of a choice of a 6" aperture housing, available in 1200 series or 1800 series, LED light engines with three interchangeable optics and a trim selection from a full line of compatible trims including reflectors, baffles and lens choices. The high-efficiency, energy-saving solution provides up to 73% in energy savings with virtually no maintenance for residential, hospitality, retail and institutional needs.

AllSlope LED IC Housing

HL612ICAT

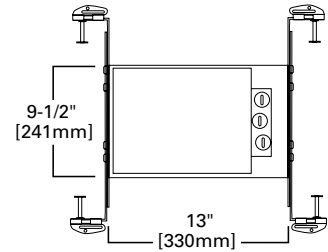
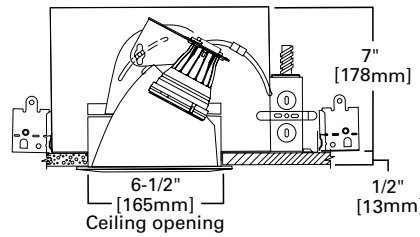

HL612ICAT - HLM69xx

6" IC, Air-Tite, New Construction, LED Housing, 120V – 277V

Recessed 6" sloped ceiling LED ICAT housing for insulated ceilings* from 2/12 to 12/12 pitch. The socket aiming mechanism tilts the lamp straight down regardless of ceiling pitch. Rotational collar allows trim alignment of up to 20 degree rotation. The HL612 system consists of 1) housing with integral LED driver, 2) high efficacy LED light engine with a selection of beam-forming lenses, and 3) slope trim. Housing is suitable for residential or commercial installations in insulated ceilings* and features Air-Tite code compliant construction.



Special Features

- Got Nail!™ bar hangers
- Pass-N-Thru™ bars
- Slide-N-Side™ junction box
- Quick Connect™ push wire nuts
- Air-Tite™ code compliant

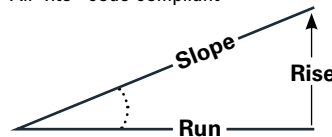

Roof Pitch = Rise/Run

Compatible LED Light Engines & Trims

Light Engines	Trims
HLM6927	455
HLM6930	456
HLM6935	70
HLM6940	71
	73

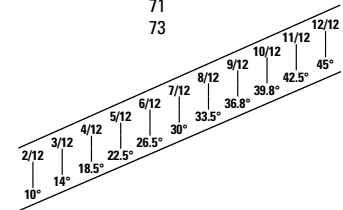

Features

Housing

- Single wall square aluminum housing construction
- Sealed and gasketed for Air-Tite ASTM E283 compliance
- Shipped with overspray protector installed
- Mechanism can be removed from the plaster frame to provide access to the junction box

Plaster Frame

- Galvanized steel frame. Housing adjusts in plaster frame to accommodate up to 1-3/8" ceiling thickness.
- Regressed locking screw for securing hanger bars
- Cutouts included for easily crimping hanger bars in position
- Bar hangers can be repositioned at 90°

Aiming Mechanism

- Exclusive socket aiming mechanism tilts and rotates to properly align the LED light engine
- LED light engine may be tilted and locked to accommodate 2/12 to 12/12 pitch
- LED light engine and trim may be rotated laterally up to 20 degrees for compound slope ceilings or to compensate off-axis aiming

Includes:

- Got Nail!™ bar hangers (Details Pg. 13)
- Pass-N-Thru™ bars (Details Pg. 13)
- Slide-N-Side™ junction box wire traps (Details Pg. 13)
- Quick Connect™ push wire nuts (Details Pg. 13)
- Air-Tite™ code compliant (Details Pg. 13)

LED Light Engines (Order Separately)

- Turn-to-lock base provides secure retention of the LED light engine to the aiming mechanism, and provides a low-voltage electrical quick-connector
- Proximity phosphors over chip on board LEDs provide a uniform source with high efficiency and no pixilation
- Correlated Color Temperature (CCT): 2700K, 3000K, 3500K, 4000K
- Color Rendering Index (CRI): 90 (R9 > 50)
- 745 - 1750 Nominal lumens, range dependent on CCT and trim**
- Lumen maintenance: L70 at 50,000 hours

Beam Forming Lenses (Interchangeable)

- HLM6 LED light engines are designed to accept HL6 series lens optics
- The 40-degree Flood (FL) lens is included with the LED light engine, and may be ordered separately as a replacement
- Alternate beam options are offered in 25° Narrow Flood (NFL) and 55° Wide Flood (WFL), ordered separately
- The interchangeable lenses feature beam distributions with refined visual shielding to control beam angle and lumen delivery in accommodating various ceiling heights

Compliance

- cULus Listed 1598 luminaire
- cULus Listed damp location
- cULus Listed for wet location, covered ceiling, with select trims

- cULus Listed for feed through
- cULus Listed for direct contact with insulation* and combustible material
- Energy Code compliant
 - ENERGY STAR® certified luminaire
 - Can be used for California Title 24 Compliance, Title 20 Certified for residential compliance
 - Can be used for International Energy Conservation Code (IECC) compliance
- EMI/RFI per FCC 47CFR Part 15 Class B consumer limits suitable for use in commercial and residential installations
- Air-Tite code compliant. Certified under ASTM E283; not exceeding 2.0 cfm (0.944 L/s) air leakage rate tested at a 1.57 psf (75 Pa) pressure differential.
- Junction box features a separate compartment for 0-10V DC low voltage dimming connections, to comply with NEC
- RoHs compliant

* Not to be used in direct contact with spray foam insulation (Refer to NEMA LSD57-2013)

Selection of Light Engine**

Model Number	Nominal CCT
HLM6927	2700
HLM6930	3000
HLM6935	3500
HLM6940	4000

**Trim type and color temperature determines the delivered lumen value. Refer to specification sheets and photometric files at www.cooperlighting.com.

HL612ICAT - HLM69 LED System

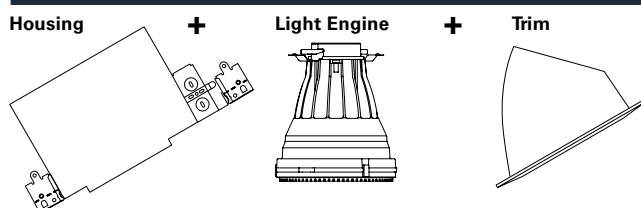

AllSlope LED Non-IC Housing

HL618TAT

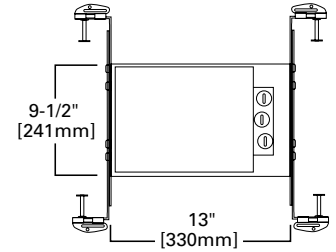
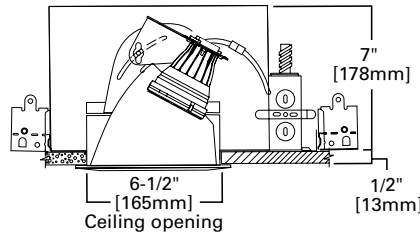

HL618TAT - HLM69xx
6" Non-IC, Air-Tite, New Construction,
LED Housing, 120V – 277V

HL618TCP - HLM69xx
6" Non-IC, Air-Tite, New Construction,
LED Housing, Chicago Plenum, 120V – 277V

Recessed 6" sloped ceiling LED Non-IC housing for non-insulated ceilings* from 2/12 to 12/12 pitch. The socket aiming mechanism tilts the lamp straight down regardless of ceiling pitch. Rotational collar allows trim alignment of up to 20 degree rotation. The HL618 system consists of 1) housing with integral LED driver, 2) high efficacy LED light engine with a section of beam-forming lenses, and 3) slope trim. Housing is suitable for residential or commercial installations in non-insulated ceilings* and features Air-Tite code compliant construction.



Special Features

- Got Nail!™ bar hangers
- Pass-N-Thru™ bars
- Slide-N-Side™ junction box
- Quick Connect™ push wire nuts
- Air-Tite™ code compliant

Compatible LED Light Engines & Trims

Light Engines	Trims
HLM6927	455
HLM6930	456
HLM6935	70
HLM6940	71
	73

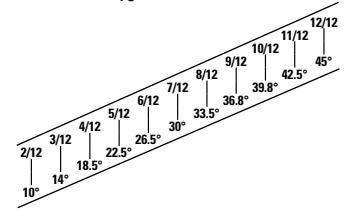
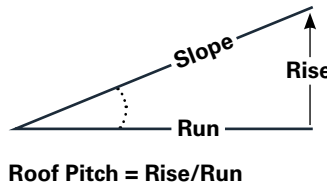

Features

Housing

- Single wall square aluminum housing construction
- Sealed and gasketed for Air-Tite ASTM E283 compliance
- Shipped with overspray protector installed
- Mechanism can be removed from the plaster frame to provide access to the junction box
- Chicago Plenum model is constructed and gasketed in accordance with City of Chicago CCEA requirements

Plaster Frame

- Galvanized steel frame. Housing adjusts in plaster frame to accommodate up to 1-3/8" ceiling thickness.
- Regressed locking screw for securing hanger bars
- Cutouts included for easily crimping hanger bars in position
- Bar hangers can be repositioned at 90°

Aiming Mechanism

- Exclusive socket aiming mechanism tilts and rotates to properly align the LED light engine
- LED light engine may be tilted and locked to accommodate 2/12 to 12/12 pitch
- LED light engine and trim may be rotated laterally up to 20 degrees for compound slope ceilings or to compensate off-axis aiming

Includes:

- Got Nail!™ bar hangers (Details Pg. 13)
- Pass-N-Thru™ bars (Details Pg. 13)
- Slide-N-Side™ junction box wire traps (Details Pg. 13)

- Quick Connect™ push wire nuts (Details Pg. 13)
- Air-Tite™ code compliant (Details Pg. 13)

LED Light Engines (Order Separately)

- Turn-to-lock base provides secure retention of the LED light engine to the aiming mechanism, and provides a low-voltage electrical quick-connector
- Proximity phosphors over chip on board LEDs provide a uniform source with high efficiency and no pixilation
- Correlated Color Temperature (CCT): 2700K, 3000K, 3500K, 4000K
- Color Rendering Index (CRI): 90 (R9 > 50)
- 970 - 2285 nominal lumens, range dependent on CCT and trim**
- Lumen maintenance: L70 at 50,000 hours

Beam Forming Lenses (Interchangeable)

- HLM6 LED light engines are designed to accept HL6 series lens optics
- The 40-degree Flood (FL) lens is included with the LED light engine, and may be ordered separately as a replacement
- Alternate beam options are offered in 25° Narrow Flood (NFL) and 55° Wide Flood (WFL), ordered separately
- The interchangeable lenses feature beam distributions with refined visual shielding to control beam angle and lumen delivery in accommodating various ceiling heights

Compliance

- cULus Listed 1598 luminaire
- cULus Listed damp location

- cULus Listed for wet location, covered ceiling, with select trims
- cULus Listed for feed through
- Energy Code compliant
 - ENERGY STAR® certified luminaire
 - Can be used to comply with California Title 24 non-residential lighting controls requirements as a LED luminaire
- EMI/RFI per FCC 47CFR Part 15 Class B consumer limits suitable for use in commercial and residential installations
- Chicago Plenum model (HL618TCP) is specially constructed and marked for Chicago Plenum applications (CCEA)
- Air-Tite code compliant. Certified under ASTM E283; not exceeding 2.0 cfm (0.944 L/s) air leakage rate tested at a 1.57 psf (75 Pa) pressure differential.
- Junction box features a separate compartment for 0-10V DC low voltage dimming connections, to comply with NEC
- RoHS compliant

* If insulation is present it must be kept 3" from all sides and top of housing. Not to be used in direct contact with spray foam insulation (Refer to NEMA LSD57-2013)

Selection of Light Engine**

Model Number	Nominal CCT
HLM6927	2700
HLM6930	3000
HLM6935	3500
HLM6940	4000

**Trim type and color temperature determines the delivered lumen value. Refer to specification sheets and photometric files at www.cooperlighting.com.

HL618TAT (TCP) - HLM69 LED System

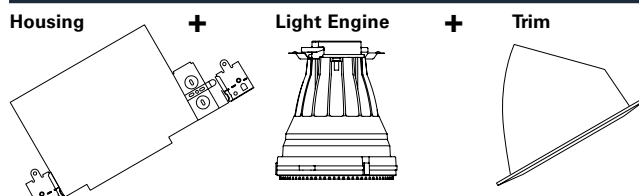

Specifications, compliances and dimensions subject to change without notice

AllSlope LED System

HL6 Series Ordering Information

1. Housing

HL612ICAT = 6" Slope ceiling, insulated ceiling rated, Air-Tite, recessed housing, UNV 120V-277V
HL618TAT = 6" Slope ceiling, non-insulated ceiling rated, Air-Tite, recessed housing, UNV 120V-277V
HL618TCP = 6" Slope ceiling recessed housing, non-insulated ceiling rated, CCEA marked for Chicago Plenum, UNV 120V-277V

2. LED Light Engines

HLM6927 = 90 CRI, 2700K 40° Flood lens
HLM6930 = 90 CRI, 3000K 40° Flood lens
HLM6935 = 90 CRI, 3500K 40° Flood lens
HLM6940 = 90 CRI, 4000K 40° Flood lens

2. Lens Optics Beam Forming (Order Separately)

HL6NFL = 25° Narrow flood
HL6FL = 40° Flood (1 included with LED light engine)
HL6WFL = 55° Wide flood
HL6LHRPK = Replacement lens holder ring

3. LED Trims

Reflector - OD: 7-1/4" [184mm]

455SC = Specular clear reflector, white metal trim ring
455H = Semi-specular haze reflector, white metal trim ring
455SN = Satin nickel reflector, satin nickel metal trim ring
455TBZ = Tuscan bronze reflector, tuscan bronze metal trim ring

Baffles - OD: 7-1/4" [184mm]

456W = White Coilex baffle, white metal trim ring
456P = Black Coilex baffle, white metal trim ring

Lenses and Diffusers "Dead-Front" - OD: 8" [203mm]

70P = Albalite glass lens, white polymer trim ring
70PS = Albalite glass lens, white polymer trim ring, wet location - Showerlight
70SN = Albalite glass lens, satin nickel polymer trim ring, wet location - Showerlight
71P = Drop opal glass lens, white polymer trim ring
71PS = Drop opal glass lens, white polymer trim ring, wet location - Showerlight
73P = Fresnel glass lens, white polymer trim ring
73PS = Fresnel glass lens, white polymer trim ring, wet location - Showerlight

Accessories (Order Separately)

Oversize Trim Rings

OT400P = Oversize flat white metal trim ring 6" ID x 9-1/4" OD (ring slips behind trim, in stepped configuration)
OT403P = Oversize white plastic trim ring 6" ID x 8" OD (ring slips behind trim, in stepped configuration)
TRM690WH = Oversize matte white metal trim ring. Designed to inset into oversize ring for an even (non-stepped) trim surface.



Designer Trim Rings

OD 7-1/4" 184mm; 6" Designer trim rings, for 455 and 456 trims
TRM6C = Chrome metal
TRM6MB = Black metal
TRM6P = White metal
TRM6SN = Satin nickel metal
TRM6TBZ = Tuscan bronze metal
TRM7MB = Black polymer



HL6 Energy Data

HL612ICAT (1200 Series)		HL618TAT & HL618TCP (1800 Series)	
Min. operating temperature	-30C/-22F	Min. operating temperature	-30C/-22F
Input Voltage	120V 277V	Input Voltage	120V 277V
Input Current (A)	0.16 0.07	Input Current (A)	0.23 0.10
Input Power (W)	19.1 20.0	Input Power (W)	27.6 27.0
Input Frequency	50/60Hz	Input Frequency	50/60Hz
FCC 47CFR Part 15 EMI/RFI	Consumer Limits (Residential & Commercial)	FCC 47CFR Part 15 EMI/RFI	Consumer Limits (Residential & Commercial)
THD	≤ 20%	THD	≤ 20%
Power Factor	≥ 0.9	Power Factor	≥ 0.9
Sound Rating	Class A	Sound Rating	Class A

For proper slope aiming install with junction box in upward position

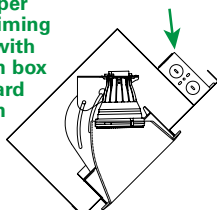

Improper Install



LED Driver

- Integral to the housing, 120V-277V 50/60 Hz universal voltage, constant current dimmable driver provides high efficiency operation
- Driver meets FCC 47CFR Part 15 EMI/RFI consumer limits for use in residential and commercial installations
- Driver features high power factor and low THD and has integral thermal protection in the event of over temperature or internal failure
- Driver is specifically designed for compatibility with HLM6 LED light engines
- If dimming is not required the fixture can be operated from a standard wall switch

Dimming

Phase Control

- Designed for continuous dimming capability to nominally 5% with many 120V Leading Edge (LE) and Trailing Edge (TE) phase control dimmers. (Dimmers with low end trim adjustment offer greater assurance of achieving 5% level)
- Consult dimmer manufacturer for compatibility and conditions of use. (Note, some dimmers require a neutral in the wallbox)

0-10V

- Dimmable to 10% in typical operation with compatible 0-10V DC low voltage dimmers
- 0-10V DC dimmers operate using two low voltage dimming wires (color coded violet and gray). The low voltage dimming wires are separate from the 120V AC or 277V AC power.
- Switching on/off is controlled via the line voltage (120V AC or 2 V AC) power, and dimming is controlled via the 2-wire 0-10V DC low voltage wiring

Color Specification & Quality Standards

- A tight chromaticity specification ensures LED color uniformity, sustainable Color Rendering Index (CRI) and Correlated Color Temperature (CCT) over the useful life of the LED
- High color performance with 90 CRI minimum, and R9 greater than 50
- LED color uniformity of 3 SDCM exceeds ENERGY STAR® color standards per ANSI C78.377-2008
- Halo LED serialized testing and measurement ensures color and lumen consistency on a per-unit basis, and validates long-term product consistency over time
- Lumen maintenance L70 at 50,000 hours



LED Direct & Surface Mount

Direct Mount

HLB Series	112
HLA Series	118
RL-DM Series	120
SMD-DM Series	124

Surface Mount

BLD Series	126
CLD Series	130
SMD Series	132
SLD Series	136
HLC Series	141

LED Direct Mount

Halo offers a series of Direct Mount (DM) products which can be installed directly into the ceiling with no additional junction box or housing required. This version of Halo downlights provides a quick installation and flush finish with the ceiling.

Direct Mounts with a remote driver / junction box

The MicroEdge HLB, MicroEdge HLA and RL-DM LED modules work with a remote driver / junction box that is ideal for new construction and renovation work. Simplified installation in drywall or suspended ceilings eliminates recessed cans saving time and money.



HLB3R



HLB3S



HLB4R



HLB4S



HLA4R



HLA4S



HLB6R



HLB6S

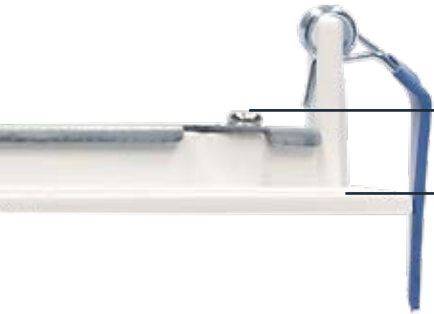

1/2"

The HLB can install from below the ceiling in as little as a 1-1/2" plenum height.



RL4-DM



RL6-DM

Easy Installation*

*Images show installation of the round HLB6. Templates are provided with the product to help with cutting the hole.



1. Cut a hole in drywall using a hole saw or with the provided template.



2. Wire to the remote junction box.



3. Fold both of the spring clips upward.



4. Push the fixture up into place.





Direct Mounts with an on board driver / junction box

The SMD-DM modules work with an integral driver and junction box pre-installed on the back of the fixture. It is ideal for new construction and renovation work. Simplified installation in drywall or suspended ceilings eliminates recessed cans saving time and money.



SMD4R-DM



SMD4S-DM



SMD6R-DM



SMD6S-DM

Easy Installation*

*Images show installation of the square SMD-DM. Follow the same steps for the round products.



1. Cut a hole in drywall with the provided template.



2. Wire to the integrated fixture junction box.



3. Fold both of the spring clips upward.



4. Push the fixture up into place.

LED Direct Mount

HLB3 & HLB3S Series



HLB3

3" Ultra-thin LED Lens Round or Square Downlight

The HLB3 is a 3-inch ultra-thin round or square LED lens downlight with remote driver / junction box suitable for new construction and remodel applications. Simplified installation in drywall or suspended ceilings eliminates recessed cans saving time and money. Installs from below the ceiling in as little as 3-1/2" plenum height, can be used in direct contact with insulation and is airtight. Use for general area lighting in low to medium height ceilings where energy savings, long life and economy are required.



Features

Housing

- Die cast aluminum mounting frame with integral flange provides passive thermal cooling achieving L70 at 50,000 hours in IC and non-IC applications
- High impact diffuse lens provides shielding to the light guide minimizing pixilation

Gasket

- Closed cell gasket achieves restrictive airflow and wet location listing without additional gaskets or caulking
- Optional Mounting Frame
- Pre-galvanized steel mounting frame locates fixture fittings during electrical rough in and provides cutout guidance for drywall contractor
- Provides tool-less attachment of remote driver / junction box

Optics

- Precision acrylic light guide organizes source flux into wide distribution with 1.4 spacing criteria, useful for general area illumination

LED Array

- Plurality of mid power LED's provides a uniform source with high efficiency and long life
- Available in 90 CRI minimum, R9 greater than 50 provides high color rendering
- Fixed 2700, 3000, 3500 and 4000 K CCT color temperatures, color accuracy within 3 SDCM
- Meets Energy Star color angular uniformity requirements, deviation is less than 0.004 u' v'

Remote Driver / Junction Box

- Pre-galvanized steel driver / junction box with captive hinged junction box cover
- Listed for (6) #12 AWG 90° C splice conductors, 2-in, 2-out plus (2) ground
- (2) 1/2" conduit pry-outs
- (2) Slide-N-Side™ non-metallic (NM) wire traps allows wiring outside the box
- Accepts 14-2, 14-3, 12-2, 12-3 U.S. and 14-2, 14-3, 12-2 Canadian NM cable
- (3) 4-port push wire nuts with clear caps for quick and reliable mains voltage connections
- Integral mounting slots facilitate direct mounting to building structure or mounting frame

Driver

- 120V 60 Hz constant current driver provides noise free operation
- Continuous, flicker-free dimming from 100% to 5% with select leading or trailing edge 120V phase cut dimmers
- Plenum rated inline electrical quick connect provides low voltage connection to fixture fitting

Installation

- Can be installed in 1/2" to 1-1/4" thick ceilings
- Cutout template provided
- Heat treated springs hold fixture fitting securely in the ceiling eliminating light leaks
- Can be removed from below the ceiling for service or replacement

Compliance

- cULus certified type IC suitable for direct contact with air permeable insulation
- Not recommended for use in direct contact with spray foam insulation, reference NEMA LSD57-2013
- Wet location listed and IP44 ingress protection
- Airtight per ASTM-E283-04
- Suitable for use in clothes closets when installed in accordance with the NEC 410.16 spacing requirements
- EMI/RFI emissions per FCC 47CFR Part 15 consumer limits
- Contains no mercury or lead and RoHS compliant
- Photometric testing in accordance with IES LM-79-08
- Lumen maintenance projections in accordance with IES LM-80-08 and TM-21-11
- Can be used for State of California Title 24 high efficacy LED compliance under JA8, reference Modernized Appliance Efficiency Database System (MAEDBS) for 2016 JA8 High Efficacy Lighting
- ENERGY STAR certified, reference "Certified Light Fixtures" database



HLB3 Energy Data

	HLB3	HLB3S
Lumens	500 Series	500 Series
Input Voltage	120V	120V
Input Current	100 (mA)	100 (mA)
Input Power	9.0 (W)	9.0 (W)
Efficiency	60 (LPW)	60 (LPW)
Inrush (A)	2.2 A @ 42mS	2.2 A @ 42mS
THD	≤ 20%	≤ 20%
PF	≥ 0.90	≥ 0.90
T Ambient	-30° - +40°C	-30° - +40°C
Sound Rating	≤ 22 dba	≤ 22 dba

LED Direct Mount

HLB3 & HLB3S Series

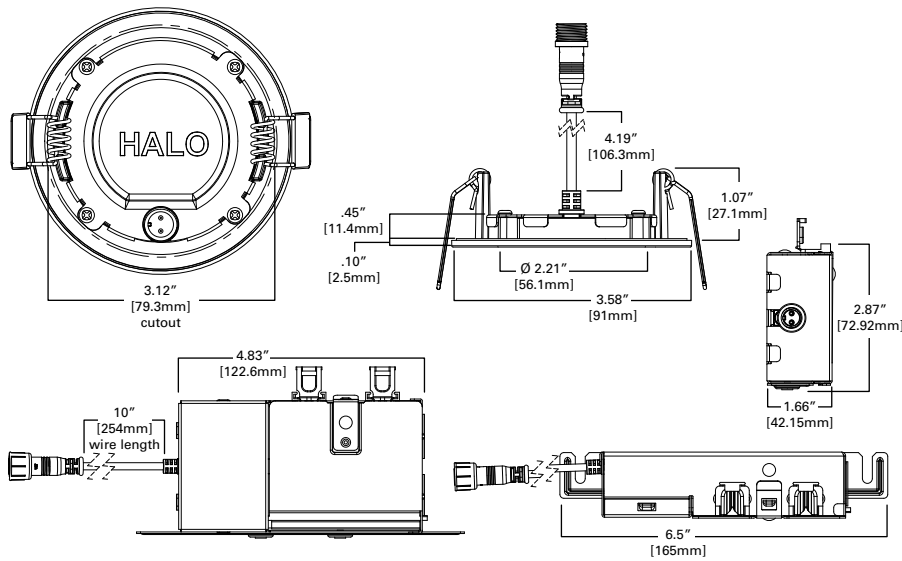

HLB3 Series Ordering Information

Models	Lumens	CRI / CCT (CRI)	Driver	Finish	Packaging	Accessories
HLB3 = 3-Inch LED lens downlight with remote driver / junction box	05=500 lumens (nominal)	927=90 CRI minimum, 2700K CCT 930=90 CRI minimum, 3000K CCT 935=90 CRI minimum, 3500K CCT 940=90 CRI minimum, 4000K CCT	1E= 120V 60Hz, LE & TE phase cut 5% dimming	MW= matte white flange	R= recyclable 4-color unit carton suitable for point of purchase merchandizing display	HL3RSMF = 3" round and square mounting frame HLB3ROTMMW = 3" round oversized trim, matte white HLB3TRMMW = 3" round decorative overlay, matte white HLB3TRMSN = 3" round decorative overlay, satin nickel HLB3TRMTBZ = 3" round decorative overlay, tuscan bronze

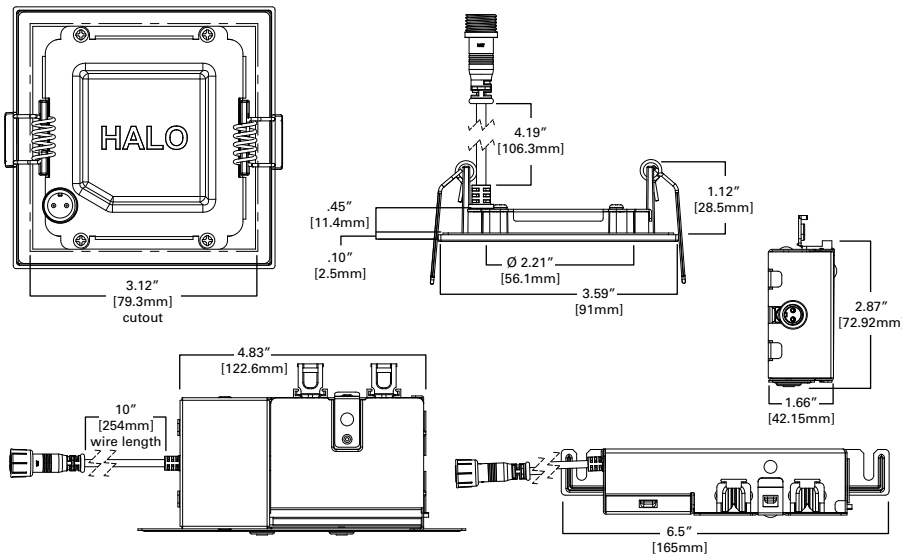

HLB3S Series Ordering Information

Models	Lumens	CRI / CCT (CRI)	Driver	Finish	Packaging	Accessories
HLB3S = 3-Inch LED square lens downlight with remote driver / junction box	05=500 lumens (nominal)	927=90 CRI minimum, 2700K CCT 930=90 CRI minimum, 3000K CCT 935=90 CRI minimum, 3500K CCT 940=90 CRI minimum, 4000K CCT	1E= 120V 60Hz, LE & TE phase cut 5% dimming	MW= matte white flange	R= recyclable 4-color unit carton suitable for point of purchase merchandizing display	HL3RSMF = 3" round and square mounting frame HLB3SOTMMW = 3" square oversized trim, matte white HLB3STRMMW = 3" square decorative overlay, matte white HLB3STRMSN = 3" square decorative overlay, satin nickel HLB3STRMTBZ = 3" square decorative overlay, tuscan bronze

LED Direct Mount

HLB4 & HLB4S Series



2700K • 3000K • 3500K
4000K • 5000K

HLB4

4" Ultra-thin LED Lens Round or Square Downlight

The HLB4 is a 4-inch ultra-thin round or square LED lens downlight with remote driver / junction box suitable for new construction and remodel applications. Field selectable color temperature and high color rendering provide excellent color performance. Simplified installation in drywall or suspended ceilings eliminates recessed cans saving time and money. Installs from below the ceiling in as little as 1-1/2" plenum height, can be used in direct contact with insulation and is airtight. Use for general area lighting in low to medium height ceilings where energy savings, long life and economy are required.



Features

Housing

- Die cast aluminum mounting frame with integral flange provides passive thermal cooling achieving L70 at 50,000 hours in IC and non-IC applications
- High impact diffuse lens provides shielding to the light guide minimizing pixilation.

Gasket

- Closed cell gasket achieves restrictive airflow and wet location listing without additional gaskets or caulking.

Optics

- Precision acrylic light guide organizes source flux into wide distribution with 1.4 spacing criteria, useful for general area illumination

LED Array

- Plurality of mid power LED's provides a uniform source with high efficiency and long life
- Available in 90 CRI minimum, R9 greater than 50 provides high color rendering
- Fixed 3000 and 4000 K CCT color temperatures, color accuracy within 3 SDCM
- Optional field selectable color temperature, select 2700, 3000, 3500, 4000 or 5000 K CCT, color accuracy within 4 SDCM
- Meets ENERGY STAR® color angular uniformity requirements, deviation is less than 0.006 u' v'

Remote Driver/Junction Box

- Pre-galvanized steel driver / junction box with captive hinged junction box cover
- Listed for (6) #12 AWG 90° C splice conductors, 2-in, 2-out plus (2) ground
- (2) 1/2" conduit pry-outs
- (2) Slide-N-Side™ non-metallic (NM) wire traps allows wiring outside the box
- Accepts 14-2, 14-3, 12-2, 12-3 U.S. and 14-2, 14-3, 12-2 Canadian NM cable
- (3) 4-port push wire nuts with clear caps for quick and reliable mains voltage connections
- Integral mounting holes facilitate direct mounting to building structure or mounting frame

Driver

- 120V 60 Hz constant current driver provides noise free operation
- Continuous, flicker-free dimming from 100% to 5% with select leading or trailing edge 120V phase cut dimmers
- Plenum rated inline electrical quick connect provides low voltage connection to fixture fitting

Installation

- Can be installed in 1/2" to 1-1/4" thick ceilings
- Cutout utilizes standard round hole saw sizes, cutout template provided
- Heat treated springs hold fixture fitting securely in the ceiling eliminating light leaks
- Housing is less than 1/2" thick and can span a 2" nominal framing member
- Can be removed from below the ceiling for service or replacement

Optical Mounting Frame

- Pre-galvanized steel mounting frame locates fixture fittings during electrical rough in and provides cutout guidance for drywall contractor
- Provides attachment of remote driver / junction box

Compliance

- cULus certified type IC suitable for direct contact with air permeable insulation
- Not recommended for use in direct contact with spray foam insulation, reference NEMA LSD57-2013
- Wet location listed and IP44 ingress protection
- Airtight per ASTM-E283-04
- Suitable for use in clothes closets when installed in accordance with the NEC 410.16 spacing requirements
- EMI/RFI emissions per FCC 47CFR Part 15 consumer limits
- Contains no mercury or lead and RoHS compliant
- Photometric testing in accordance with IES LM-79-08
- Lumen maintenance projections in accordance with IES LM-80-08 and TM-21-11
- Can be used for State of California Title 24 high efficacy LED compliance under JA8, reference Modernized Appliance Efficiency Database System (MAEDBS) for 2016 JA8 High Efficacy Lighting
- ENERGY STAR® certified, reference "Certified Light Fixtures" database



HLB4 Energy Data

	HLB4	HLB4S
Lumens	600	600
Input Voltage	120V	120V
Input Current	100 (mA)	90 (mA)
Input Power	12.0 (W)	10.5 (W)
Efficiency	60 (LPW)	60 (LPW)
Inrush (A)	2.2 A @42mS	2.2 A @54mS
THD	≤ 20%	≤ 20%
PF	≥ 0.90	≥ 0.90
T Ambient	-30 - +40°C	-30 - +40°C
Sound Rating	≤ 22 dba	≤ 22 dba

LED Direct Mount

HLB4 & HLB4S Series

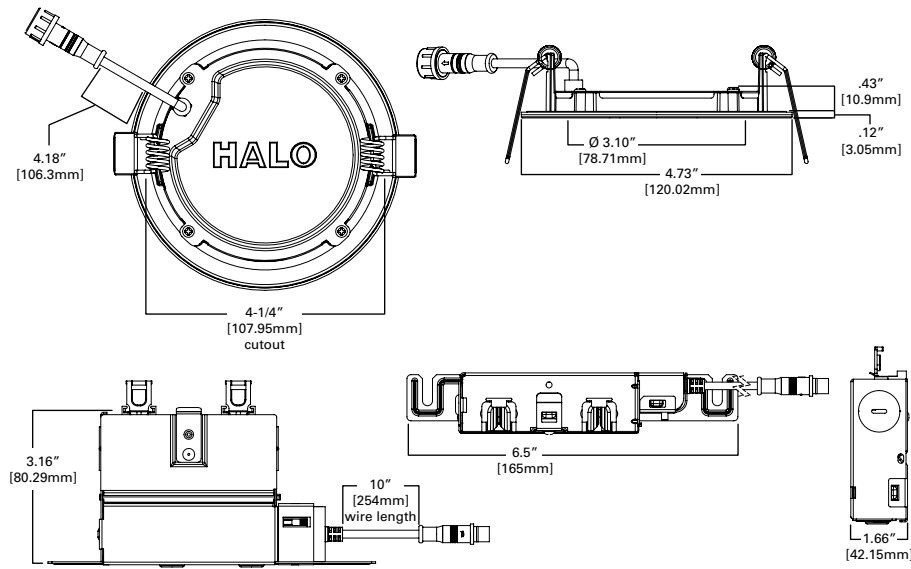

HL4RSMF
round & square mounting frame



Oversized Trim
HLB4ROTMMW
round, matte white



Designer Trims
HLB4RTRMMW
round, white (paintable)



HLB4RTRMSN
round, satin nickel



HLB4RTRMTBZ
round, tuscan bronze

HLB4 Series Ordering Information

Models	Lumens	CRI / CCT (CRI)	Driver	Finish	Packaging	Accessories
HLB4 = 4-Inch ultra-thin LED lens downlight with remote driver / junction box	06 = 600 lumen (nominal)	930 = 90 CRI minimum, 3000 K CCT 940 = 90 CRI minimum, 4000 K CCT 9FS = 90 CRI minimum, field selectable 2700, 3000, 3500, 4000 or 5000 K CCT	1E = 120V 60Hz, LE & TE phase cut 5% dimming	MW = matte white flange	R = recyclable 4-color unit carton suitable for point of purchase merchandizing display	HL4RSMF = 4" round and square mounting frame HLB4ROTMMW = 4" round oversized trim, matte white HLB4RTRMMW = 4" round decorative overlay, matte white HLB4RTRMSN = 4" round decorative overlay, satin nickel HLB4RTRMTBZ = 4" round decorative overlay, tuscan bronze

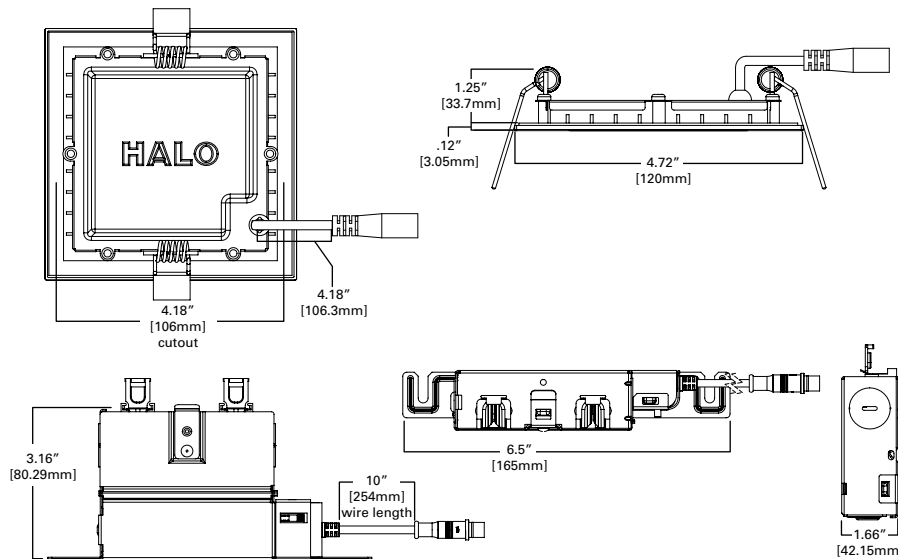

HL4RSMF
round & square mounting frame



Oversized Trim
HLB4SOTMW
square, matte white



Designer Trims
HLB4STRMMW
square, white (paintable)



HLB4STRMSN
square, satin nickel



HLB4STRMTBZ
square, tuscan bronze

HLB4S Series Ordering Information

Models	Lumens	CRI / CCT (CRI)	Driver	Finish	Packaging	Accessories
HLB4S = 4-Inch ultra-thin LED square lens downlight with remote driver / junction box	06 = 600 lumen (nominal)	930 = 90 CRI minimum, 3000 K CCT 940 = 90 CRI minimum, 4000 K CCT 9FS = 90 CRI minimum, field selectable 2700, 3000, 3500, 4000 or 5000 K CCT	1E = 120V 60Hz, LE & TE phase cut 5% dimming	MW = matte white flange	R = recyclable 4-color unit carton suitable for point of purchase merchandizing display	HL4RSMF = 4" round and square mounting frame HLB4SOTMW = 4" square oversized trim, matte white HLB4STRMMW = 4" square decorative overlay, matte white HLB4STRMSN = 4" square decorative overlay, satin nickel HLB4STRMTBZ = 4" square decorative overlay, tuscan bronze

LED Direct Mount

HLB6 & HLB6S Series

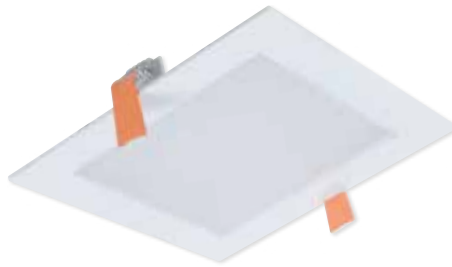

2700K • 3000K • 3500K
4000K • 5000K

HLB6

6" Ultra-thin LED Lens Round or Square Downlight

The HLB6 is a 6-inch ultra-thin round or square LED lens downlight with remote driver / junction box suitable for new construction and remodel applications. Field selectable color temperature and high color rendering provide excellent color performance. Simplified installation in drywall or suspended ceilings eliminates recessed cans saving time and money. Installs from below the ceiling in as little as 1-1/2" plenum height, can be used in direct contact with insulation and is airtight. Use for general area lighting in low to medium height ceilings where energy savings, long life and economy are required.



Features

Housing

- Die cast aluminum mounting frame with integral flange provides passive thermal cooling achieving L70 at 50,000 hours in IC and non-IC applications
- High impact diffuse lens provides shielding to the light guide minimizing pixilation

Gasket

- Closed cell gasket achieves restrictive airflow and wet location listing without additional gaskets or caulking

Optics

- Precision acrylic light guide organizes source flux into wide distribution with 1.4 spacing criteria, useful for general area illumination

LED Array

- Plurality of mid power LED's provides a uniform source with high efficiency and long life
- Available in 90 CRI minimum, R9 greater than 50 provides high color rendering
- Fixed 3000 and 4000 K CCT color temperatures, color accuracy within 3 SDCM
- Optional field selectable color temperature, select 2700, 3000, 3500, 4000 or 5000 K CCT, color accuracy within 4 SDCM
- Meets ENERGY STAR® color angular uniformity requirements, deviation is less than 0.006 u' v'

Remote Driver/Junction Box

- Die formed metal driver / junction box with captive hinged junction box cover
- Listed for (6) #12 AWG 90° C splice conductors, 2-in, 2-out plus (2) ground
- (2) 1/2" conduit pry-outs
- (2) Slide-N-Side™ non-metallic (NM) wire traps allows wiring outside the box
- Accepts 14-2, 14-3, 12-2, 12-3 U.S. and 14-2, 14-3, 12-2 Canadian NM cable
- (3) 4-port push wire nuts with clear caps for quick and reliable mains voltage connections
- Integral mounting holes facilitate direct mounting to building structure or mounting frame

Driver

- 120V 60 Hz constant current driver provides noise free operation
- Continuous, flicker-free dimming from 100% to 5% with select leading or trailing edge 120V phase cut dimmers
- Plenum rated inline electrical quick connect provides low voltage connection to fixture fitting

Installation

- Can be installed in 1/2" to 1-1/4" thick ceilings
- Cutout utilizes standard round hole saw sizes, cutout template provided
- Heat treated springs hold fixture fitting securely in the ceiling eliminating light leaks
- Housing is less than 1/2" thick and can span a 2" nominal framing member
- Can be removed from below the ceiling for service or replacement

Optional Mounting Frame

- Pre-galvanized steel mounting frame locates fixture fittings during electrical rough in and provides cutout guidance for drywall contractor
- Provides attachment of remote driver / junction box

Compliance

- cULus certified type IC suitable for direct contact with air permeable insulation
- Not recommended for use in direct contact with spray foam insulation, reference NEMA LSD57-2013
- Wet location listed and IP44 ingress protection
- Airtight per ASTM-E283-04
- Suitable for use in clothes closets when installed in accordance with the NEC 410.16 spacing requirements
- EMI/RFI emissions per FCC 47CFR Part 15 consumer limits
- Contains no mercury or lead and RoHS compliant
- Photometric testing in accordance with IES LM-79-08
- Lumen maintenance projections in accordance with IES LM-80-08 and TM-21-11
- Can be used for State of California Title 24 high efficacy LED compliance under JA8, reference Modernized Appliance Efficiency Database System (MAEDBS) for 2016 JA8 High Efficacy Lighting
- ENERGY STAR® certified, reference "Certified Light Fixtures" database



HLB6 Energy Data

	HLB6	HLB6S
Lumens	900	900
Input Voltage	120V	120V
Input Current	132 (mA)	120 (mA)
Input Power	16.0 (W)	14.0 (W)
Efficiency	66 (LPW)	66 (LPW)
Inrush (A)	2.1 A @14mS	2.2 A @45mS
THD	≤ 20%	≤ 20%
PF	≥ 0.90	≥ 0.90
T Ambient	-30 - +40°C	-30 - +40°C
Sound Rating	≤ 22 dba	≤ 22 dba

LED Direct Mount

HLB6 & HLB6S Series

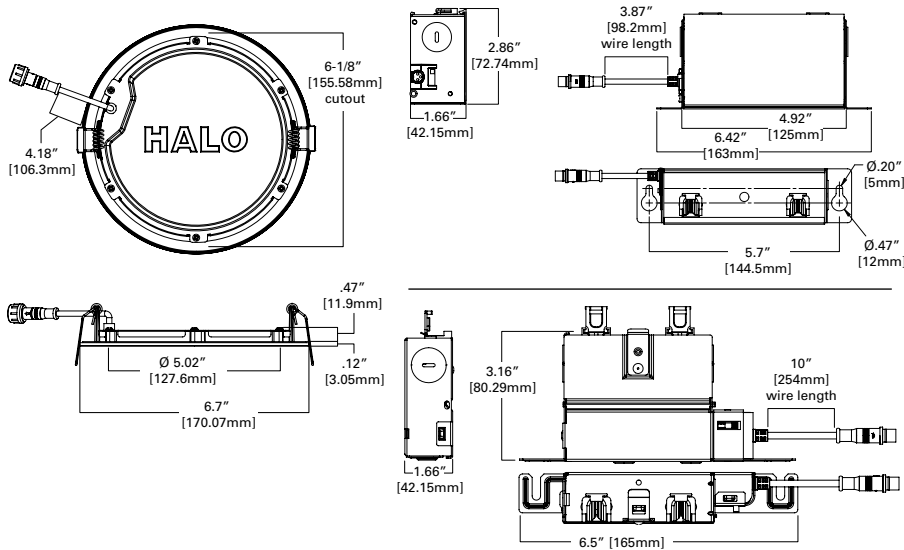

HLB6 Series Ordering Information

Models	Lumens	CRI / CCT (CRI)	Driver	Finish	Packaging	Accessories
HLB6 = 6-Inch ultra-thin LED lens downlight with remote driver / junction box	09 = 900 lumen (nominal)	930 = 90 CRI minimum, 3000 K CCT 940 = 90 CRI minimum, 4000 K CCT 9FS = 90 CRI minimum, field selectable 2700, 3000, 3500, 4000 or 5000 K CCT	1E = 120V 60Hz, LE & TE phase cut 5% dimming	MW = matte white flange	R = recyclable 4-color unit carton suitable for point of purchase merchandizing display	HLB6RSMF = 6" round and square mounting frame HLB6ROTMMW = 6" round oversized trim, matte white HLB6RTRMMW = 6" round decorative overlay, matte white HLB6RTRMSN = 6" round decorative overlay, satin nickel HLB6RTRMTBZ = 6" round decorative overlay, tuscan bronze

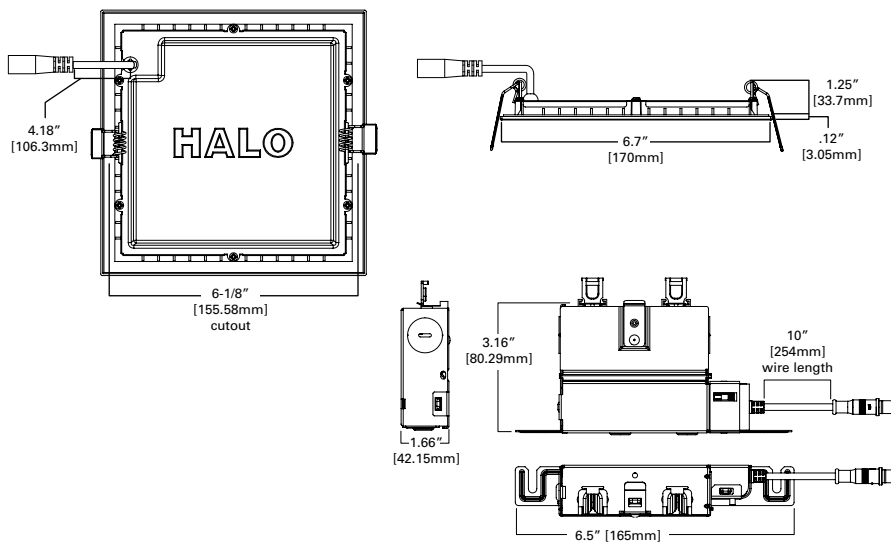

HLB6S Series Ordering Information

Models	Lumens	CRI / CCT (CRI)	Driver	Finish	Packaging	Accessories
HLB6S = 6-Inch ultra-thin LED square lens downlight with remote driver / junction box	09 = 900 lumen (nominal)	930 = 90 CRI minimum, 3000 K CCT 940 = 90 CRI minimum, 4000 K CCT 9FS = 90 CRI minimum, field selectable 2700, 3000, 3500, 4000 or 5000 K CCT	1E = 120V 60Hz, LE & TE phase cut 5% dimming	MW = matte white flange	R = recyclable 4-color unit carton suitable for point of purchase merchandizing display	HLB6RSMF = 6" round and square mounting frame HLB6SOTMMW = 6" square oversized trim, matte white HLB6STRMMW = 6" square decorative overlay, matte white HLB6STRMSN = 6" square decorative overlay, satin nickel HLB6STRMTBZ = 6" square decorative overlay, tuscan bronze

LED Direct Mount

HLA4 & HLA4S Series



2700K • 3000K • 3500K
4000K • 5000K

HLA4

4" Ultra-thin LED Lens Round or Square Directional Downlight

The HLA4 is a 4-inch ultra-thin round or square LED directional with remote driver / junction box suitable for new construction and remodel applications. Field selectable color temperature and high color rendering provide excellent color performance. Simplified installation in drywall or suspended ceilings eliminates recessed cans saving time and money. Installs from below the ceiling in as little as 1-1/2" plenum height, can be used in direct contact with insulation and is airtight. Use for accent or task lighting in low to medium height ceilings where energy savings, long life and economy are required.



Features

Housing

- Die cast aluminum mounting frame with round or square flange
- Gimbal rotates 360° and tilts ± 35° holding any aiming angle
- Aluminum heat sink provides passive thermal cooling achieving L70 at 50,000 hours in IC and non-IC applications

Gasket

- Closed cell gasket achieves restrictive airflow and wet location listing without additional gaskets or caulking

Optics

- Pre-galvanized steel mounting frame locates fixture fittings during electrical rough in and provides cutout guidance for drywall contractor
- Provides tool-less attachment of remote driver / junction box

LED Array

- Plurality of mid power LED's provides a uniform source with high efficiency and long life
- Available in 90 CRI minimum, R9 greater than 50 provides high color rendering
- Field selectable color temperature, select 2700, 3000, 3500, 4000 or 5000 K CCT, color accuracy within 4 SDCM
- Meets ENERGY STAR® color angular uniformity requirements, deviation is less than 0.006 u' v'

Remote Driver/Junction Box

- Pre-galvanized steel driver / junction box with captive hinged junction box cover
- Listed for (6) #12 AWG 90° C splice conductors, 2-in, 2-out plus (2) ground
- (2) 1/2" conduit pry-outs
- (2) Slide-N-Side™ non-metallic (NM) wire traps allows wiring outside the box
- Accepts 14-2, 14-3, 12-2, 12-3 U.S. and 14-2, 14-3, 12-2 Canadian NM cable
- (3) 4-port push wire nuts with clear caps for quick and reliable mains voltage connections
- Integral mounting slots facilitate direct mounting to building structure or mounting frame

Driver

- 120V 60 Hz constant current driver provides noise free operation
- Continuous, flicker-free dimming from 100% to 5% with select leading or trailing edge 120V phase cut dimmers
- Plenum rated inline electrical quick connect provides low voltage connection to fixture fitting

Installation

- Can be installed in 1/2" to 1-1/4" thick ceilings
- Cutout utilizes standard round hole saw sizes, cutout template provided
- Heat treated springs hold fixture fitting securely in the ceiling eliminating light leaks
- Can be removed from below the ceiling for service or replacement

Compliance

- cULus certified type IC suitable for direct contact with air permeable insulation
- Not recommended for use in direct contact with spray foam insulation, reference NEMA LSD57-2013
- Wet location listed and IP44 ingress protection
- Airtight per ASTM-E283-04
- Suitable for use in clothes closets when installed in accordance with the NEC 410.16 spacing requirements
- EMI/RFI emissions per FCC 47CFR Part 15 consumer limits
- Contains no mercury or lead and RoHS compliant
- Photometric testing in accordance with IES LM-79-08
- Lumen maintenance projections in accordance with IES LM-80-08 and TM-21-11
- Can be used for State of California Title 24 high efficacy LED compliance under JA8, reference Modernized Appliance Efficiency Database System (MAEDBS) for 2016 JA8 High Efficacy Lighting
- ENERGY STAR® certified, reference "Certified Light Fixtures" database



HLA4 Energy Data

	90 CRI
Lumens	600
Input Voltage	120V
Input Current	90 (mA)
Input Power	10.5 (W)
Efficiency	60 (LPW)
Inrush (A)	1.9 A @54mS
THD	≤ 20%
PF	≥ 0.90
T Ambient	-30 - +40°C
Sound Rating	≤ 22 dba

LED Direct Mount

HLA4 & HLA4S Series

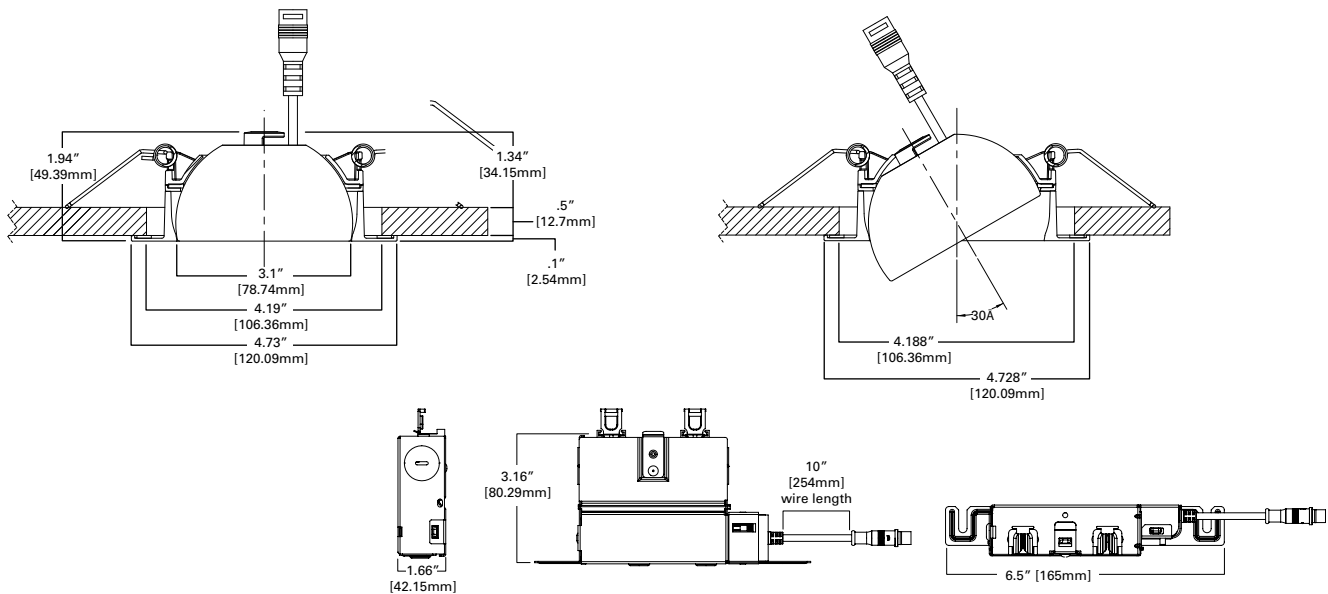

HLA4 Series Ordering Information

Models	Lumens	Distribution	CRI / CCT (CRI)	Driver	Finish	Packaging
HLA4 = 4-Inch LED round directional with remote driver / junction box	06 = 600 lumen (nominal)	VWFL = 80° very wide flood distribution	930 = 90 CRI minimum, 3000 K CCT 940 = 90 CRI minimum, 4000 K CCT 9FS = 90 CRI minimum, field selectable 2700, 3000, 3500, 4000 or 5000 K CCT	1E = 120V 60Hz, LE & TE phase cut 5% dimming	MW = matte white flange	R = recyclable 4-color unit carton suitable for point of purchase merchandizing display

Accessories

HL4RSMF = 4" round and square mounting frame	HLB06EC = 6' extension cable
HLB4R0TMW = 4" round oversized trim, matte white	HLB12EC = 12' extension cable
HLB4RTRMMW = 4" round decorative overlay, matte white	HLB20EC = 20' extension cable
HLB4RTRMSN = 4" round decorative overlay, satin nickel	
HLB4RTRMTBZ = 4" round decorative overlay, tuscan bronze	



HL4RSMF
round & square mounting frame

Oversized Trim



HLB4R0TMW
round, matte white

Designer Trims



HLB4RTRMMW
round, white (paintable)



HLB4RTRMSN
round, satin nickel



HLB4RTRMTBZ
round, tuscan bronze

HLA4S Series Ordering Information

Models	Lumens	Distribution	CRI / CCT (CRI)	Driver	Finish	Packaging
HLA4S = 4-Inch LED square directional with remote driver / junction box	06 = 600 lumen (nominal)	VWFL = 80° very wide flood distribution	930 = 90 CRI minimum, 3000 K CCT 940 = 90 CRI minimum, 4000 K CCT 9FS = 90 CRI minimum, field selectable 2700, 3000, 3500, 4000 or 5000 K CCT	1E = 120V 60Hz, LE & TE phase cut 5% dimming	MW = matte white flange	R = recyclable 4-color unit carton suitable for point of purchase merchandizing display

Accessories

HL4RSMF = 4" round and square mounting frame	HLB06EC = 6' extension cable
HLB4S0TMW = 4" square oversized trim, matte white	HLB12EC = 12' extension cable
HLB4STRMMW = 4" square decorative overlay, matte white	HLB20EC = 20' extension cable
HLB4STRMSN = 4" square decorative overlay, satin nickel	
HLB4STRMTBZ = 4" square decorative overlay, tuscan bronze	



HL4RSMF
round & square mounting frame

Oversized Trim



HLB4S0TMW
square, matte white

Designer Trims



HLB4RTRMMW
round, white (paintable)

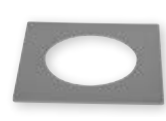

HLB4RTRMSN
round, satin nickel



HLB4RTRMTBZ
round, tuscan bronze

LED Direct Mount

RL4-DM Series



2700K • 3000K • 3500K
4000K • 5000K

RL4-DM

4" LED Direct Mount Retrofit Module with SeleCCTable switch

The Halo RL4 Direct Mount is a SeleCCTable complete LED Baffle-Trim Module for 4-inch aperture applications, all without the need for a recessed housing; suitable for new construction, remodel and retrofit installation. Using the CCT selectable switch users can chose between five different color temperatures. The RL family offers a regressed lens that provides uniform illumination and wet location listing. Precision construction makes this product AIR-TITE for added savings and code compliance.



Features

CCT Select System

- Use the switch to chose between 2700K, 3000K, 3500K, 4000K, and 5000K CCT

Module - Trim

- Module construction includes LED Array, heat sink, reflector, lens, baffle and trim ring.
- Regressed baffle
- Heat sink designed to conduct heat away from the LED Array

LED Array

- Mid power LED array provides a uniform source with high efficiency and no pixilation.
- 90 CRI minimum, R9 greater than 50
- Color accuracy within 3 SDCM at the CCT endpoints and 4 SDCM in between endpoints, provide color accuracy and uniformity.
- Color Temperature (CCT) has an selectable range from 2700K to 5000K (factory default 3000K)

Optical Assembly

- Regressed lens
- Impact-resistant polycarbonate
- Convex form and lamp-like appearance
- Diffuse for even illumination

Gaskets

- Closed cell gaskets achieve restrictive airflow requirements without additional caulking

Remote Driver/Junction Box

- Aluminum driver / junction box with captive hinged junction box cover
- Listed for (6) #12 AWG 90° C splice conductors, 2-in, 2-out plus (2) ground
- (2) ½" conduit pry-outs

- (2) Slide-N-Side™ non-metallic (NM) wire traps all
- Accepts 14-2, 14-3, 12-2, 12-3 U.S and 14-2, 14-3, 12-2 Canadian NM cable
- (3) 4-port push wire nuts with clear caps for quick and reliable mains voltage connections
- Integral keyhole mounting slots facilitate direct mounting to building structure or new construction mounting frame

Driver

- Integral 120V 60 Hz constant current driver provides noise free operation
- Continuous, flicker-free dimming from 100% to 5%.
- Plenum rated inline electrical quick connect provides low voltage connection to fixture fitting

Installation

- Can be installed in 1/2" to 1-1/4" thick ceilings
- Cutout can utilize standard round hole saw sizes, cutout template provided
- Heat treated springs hold fixture fitting securely in the ceiling eliminating light leaks
- Can be removed from below the ceiling for service or replacement

Mounting/Retention

- The RL-DM requires no housing or third party junction box
- The remote enclosure may be used in direct contact with insulation.
- Installer must cut template out of drywall and install into aperture with the clips compressed.
- When released, the spring clips will rest on to the back side of the drywall
- Not for installation in recessed cans

Compliance

- UL Certified for US and Canada
- Wet and Damp location listed
- Airtight certified per ASTM-E283
- Suitable for use in clothes closets when installed in accordance with the NEC 410.16 spacing requirements
- EMI/RFI emissions per FCC 47CFR Part 15 consumer limits
- Contains no mercury or lead and RoHS compliant
- Photometric testing in accordance with IES LM-79-08
- Lumen maintenance projections in accordance with IES LM-80-08 and TM-21-11
- Can be used for State of California Title 24 high efficacy luminaire compliance. Complies with Title 24 JA8-2016-E.
- Can be used International Energy Conservation Code (IECC) and Washington State Energy Code high efficiency luminaire compliance.
- ENERGY STAR® listed, reference database for current listings



RL4-DM Energy Data @ 3000K

	90 CRI
Lumens	600
Input Voltage	120V
Input Current	74 (mA)
Input Power	8.7 W
Efficiency	75 (LPW)
Inrush (A)	2.1 A
THD	≤ 20%
PF	≥ 0.90
T Ambient	-30 - +40°C
Sound Rating	≤ 20dba

LED Direct Mount

RL4-DM Series

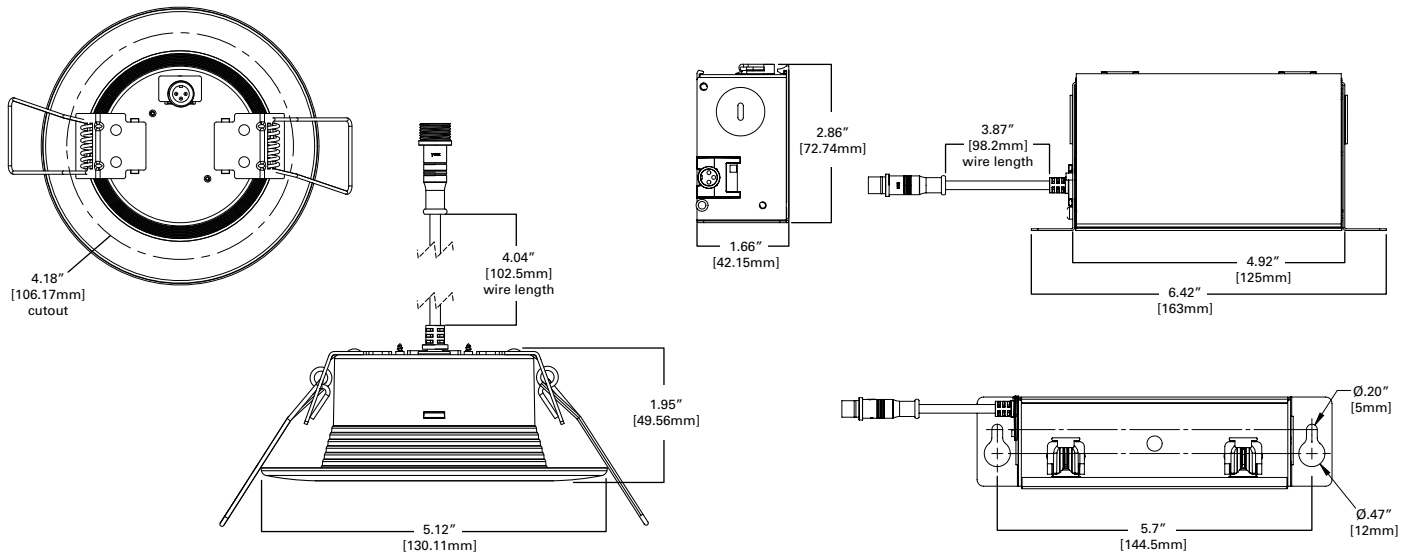

RL4-DM Series Ordering Information

Models	Lumens	CRI / CCT (CRI)	Driver	Finish	Mounting
RL4 = 4" all-purpose retrofit LED module	06 = 600 lumen (nominal)	9S = 90 CRI minimum, white tuning, selectable CCT 2700K-5000K	1E = 120V 60Hz leading or trailing edge phase cut 5% dimming	WH = matte white baffle	DM = Direct Mount

Accessories

HL4NCMF = 4" round new construction mounting frame
 HL4RSMF = 4" round and square mounting frame



HL4RSMF
round & square mounting frame



HL4NCMF
round new construction mounting frame

LED Direct Mount

RL6-DM Series



2700K • 3000K • 3500K
4000K • 5000K

RL6-DM

6" LED Direct Mount Retrofit Module with SeleCCTable switch

The Halo RL6 Direct Mount is a SeleCCTable complete LED Baffle-Trim Module for 6 inch aperture applications, all without the need for a recessed housing; suitable for new construction, remodel and retrofit installation. Using the CCT selectable switch users can chose between five different color temperatures. The RL family offers a regressed lens that provides uniform illumination and wet location listing. Precision construction makes this product AIR-TITE for added savings and code compliance.



Features

CCT Select System

- Use the switch to choose between 2700K, 3000K, 3500K, 4000K, and 5000K CCT

Module - Trim

- Module construction includes LED Array, heat sink, reflector, lens, baffle and trim ring.
- Regressed baffle
- Heat sink designed to conduct heat away from the LED Array

LED Array

- Mid power LED array provides a uniform source with high efficiency and no pixilation.
- 90 CRI minimum, R9 greater than 50
- Color accuracy within 3 SDCM at the CCT endpoints and 4 SDCM in between endpoints, provide color accuracy and uniformity.
- Color Temperature (CCT) has an selectable range from 2700K to 5000K (factory default 3000K)

Optical Assembly

- Regressed lens
- Impact-resistant polycarbonate
- Convex form and lamp-like appearance
- Diffuse for even illumination

Gaskets

- Closed cell gaskets achieve restrictive airflow requirements without additional caulking

Remote Driver/Junction Box

- Aluminum driver / junction box with captive hinged junction box cover
- Listed for (6) #12 AWG 90° C splice conductors, 2-in, 2-out plus (2) ground
- (2) ½" conduit pry-outs
- (2) Slide-N-Side™ non-metallic (NM) wire traps all
- Accepts 14-2, 14-3, 12-2, 12-3 U.S and 14-2, 14-3, 12-2 Canadian NM cable
- (3) 4-port push wire nuts with clear caps for quick and reliable mains voltage connections
- Integral keyhole mounting slots facilitate direct mounting to building structure or new construction mounting frame

Driver

- Integral 120V 60 Hz constant current driver provides noise free operation
- Continuous, flicker-free dimming from 100% to 5%.
- Plenum rated inline electrical quick connect provides low voltage connection to fixture fitting

Installation

- Can be installed in 1/2" to 1-1/4" thick ceilings
- Cutout can utilize standard round hole saw sizes, cutout template provided
- Heat treated springs hold fixture fitting securely in the ceiling eliminating light leaks
- Can be removed from below the ceiling for service or replacement

Mounting/Retention

- The RL-DM requires no housing or third party junction box
- The remote enclosure may be used in direct contact with insulation.
- Installer must cut template out of drywall and install into aperture with the clips compressed.
- When released, the spring clips will rest on to the back side of the drywall
- Not for installation in recessed cans

Compliance

- UL Certified for US and Canada
- Wet and Damp location listed
- Airtight certified per ASTM-E283
- Suitable for use in clothes closets when installed in accordance with the NEC 410.16 spacing requirements
- EMI/RFI emissions per FCC 47CFR Part 15 consumer limits
- Contains no mercury or lead and RoHS compliant
- Photometric testing in accordance with IES LM-79-08
- Lumen maintenance projections in accordance with IES LM-80-08 and TM-21-11
- Can be used for State of California Title 24 high efficacy luminaire compliance. Complies with Title 24 JA8-2016-E.
- Can be used International Energy Conservation Code (IECC) and Washington State Energy Code high efficiency luminaire compliance.
- ENERGY STAR® listed, reference database for current listings



RL6-DM Energy Data @ 3000K

	90 CRI
Lumens	600
Input Voltage	120V
Input Current	74 (mA)
Input Power	8.7 W
Efficiency	82.8 (LPW)
Inrush (A)	2.1 A @14mS
THD	≤ 20%
PF	≥ 0.90
T Ambient	-30 - +40°C
Sound Rating	≤ 20dba

LED Direct Mount

RL6-DM Series

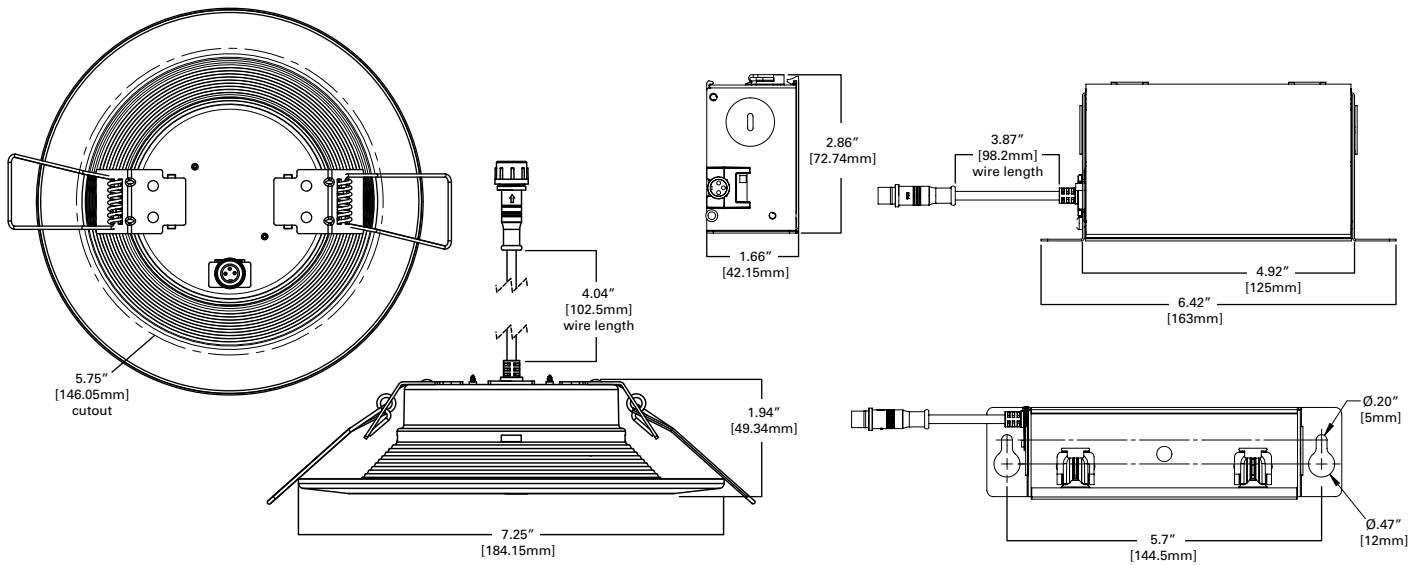

RL6-DM Series Ordering Information

Models	Lumens	CRI / CCT (CRI)	Driver	Finish	Mounting
RL6 = 6" all-purpose retrofit LED module	06 = 600 lumen (nominal)	9S = 90 CRI minimum, white tuning, selectable CCT 2700K-5000K	1E = 120V 60Hz leading or trailing edge phase cut 5% dimming	WH = matte white baffle	DM = Direct Mount

Accessories

HL6NCMF = 6" round new construction mounting frame
HL6RSMF = 6" round and square mounting frame



HL6RSMF
round & square mounting frame



HL6NCMF
round new construction mounting frame

LED Direct Mount

SMD4-DM Series

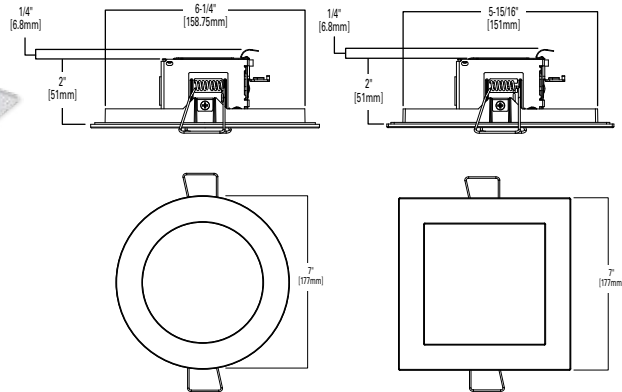

SMD4-DM

4" LED Round and Square Direct Mount

The Halo Surface Mount LED Downlight (SMD) is an ultra-low profile surface mounting luminaire with a modern look and high performance. SMD4-DM (4" with spring clips) is designed for new installation into drywall, without any additional housing or junction box needed. Suitable for residential or commercial installations. Ideal for general areas, closets, storage areas, attics and basements. Compliant with NFPA® 70, NEC® Section 410.16 (A)(3) and 410.16 (C)(5).



Features

Housing

- Non-electrically conductive polycarbonate frame.
- High impact diffuse polystyrene lens provides shielding to the light guide with no pixilation
- Stamped aluminum housing provides thermal cooling achieving L70 at 50,000 hours in IC and non-IC applications

Gaskets

- Closed cell gasket achieves restrictive airflow and wet location requirements without additional caulking

Optics

- Precision acrylic light guide organizes source flux into wide distribution with 1.2 – 1.4 spacing criteria useful for general area illumination

LED

- Mid power led array provide a uniform source with high efficiency and long life.
- Available in 90 CRI minimum, R9 greater than 50 and color accuracy within 3 SDCM provide color accuracy and uniformity

Driver

- Integral 120V 50/60Hz constant current driver provides noise free operation.
- Continuous, flicker-free dimming from 100% to 5% with select leading or trailing edge 120V phase cut dimmers.
- Dimming to 5% is best assured using dimmers with low end trim adjustment. Consult dimmer manufacturer for compatibility and conditions of use. (Note some dimmers require a neutral in the wallbox.)
- Inline electrical quick connect (provided) provides mains connections

Mounting/Retention

- The SMD-DM with Spring Clips requires no housing or junction box.
- The integral enclosure may be used in direct contact with insulation including spray foam insulation.
- Installer must cut template out of drywall, and install into the aperture with the clips compressed.
- When released, the spring clips will rest on to the back side of the drywall.
- Installer must ensure secure fit and wiring. This includes all applicable national and local electrical and building codes

Compliance

- cULus listed / certified for use with Halo housings, classified for use with other's housings, see instruction sheet for conditions of acceptability.
- Wet and Damp Location listed, airtight per ASTM-E283
- Suitable for use in closets, compliant with NFPA® 70, NEC® Section 410.16 (A)(3) and 410.16 (C)(5)
- EMI/RFI emissions per FCC 47CFR Part 15B
- Contains no mercury or lead and RoHS compliant.
- Photometric testing in accordance with IES LM-79-08
- Lumen maintenance projections in accordance with IES LM-80-08 and TM-21-11.
- Can be used for State of California Title 24 high efficacy luminaire compliance, reference the California Energy Commission Title 20 Appliance Efficiency Database for current listings.
- Can be used for International Energy Conservation Code (IECC) and Washington State Energy Code high efficiency luminaire compliance

SMD4-DM Energy Data @ 5000K

	Round	Square
Lumens	786	810
Input Voltage	120V	120V
Input Current	0.0811A	0.0829 A
Input Power	9.7 W	10 W
Efficiency	81 lm/W	81 lm/W
THD	13.3	13.2
Frequency	50/60 Hz	50/60 Hz
CRI	90 CRI	90 CRI
PF	0.99	0.99
T Ambient	-30 - +40°C	-30 - +40°C
Sound Rating	Class A	Class A

SMD4-DM Series Ordering Information

Models	Lumens	CRI / CCT	Finish	Mounting
SMD4R = 4" Round Surface Mount Downlight, 120V	6 = 600 lumen series	927 = 90CRI, 2700K 930 = 90CRI, 3000K 935 = 90CRI, 3500K	WH = white	DM = Direct Mount
SMD4S = 4" Square Surface Mount Downlight, 120V	6 = 600 lumen series			

LED Direct Mount

SMD6-DM Series

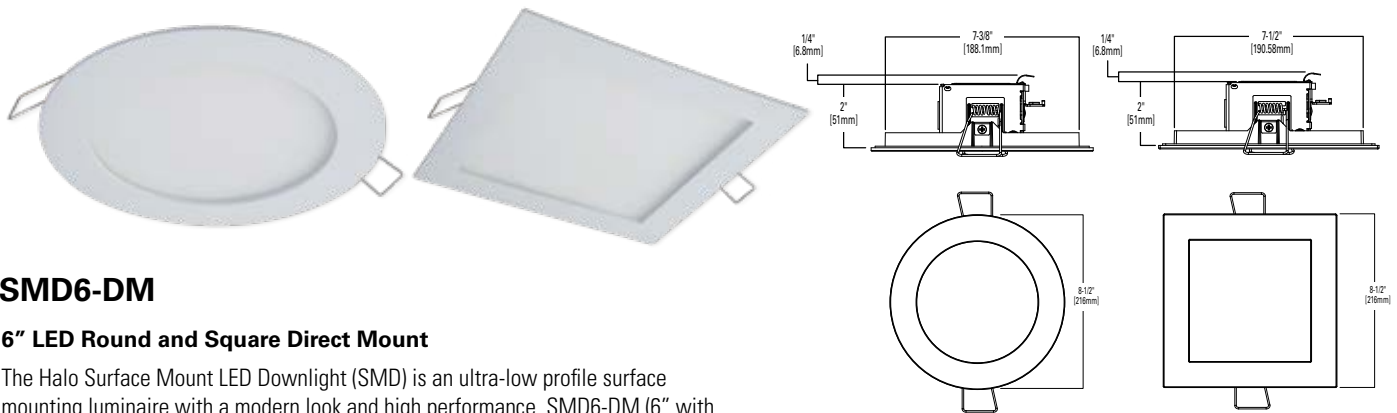

SMD6-DM

6" LED Round and Square Direct Mount

The Halo Surface Mount LED Downlight (SMD) is an ultra-low profile surface mounting luminaire with a modern look and high performance. SMD6-DM (6" with spring clips) is designed for new installation into drywall, without any additional housing or junction box needed. Suitable for residential or commercial installations. Ideal for general areas, closets, storage areas, attics and basements. Compliant with NFPA® 70, NEC® Section 410.16 (A)(3) and 410.16 (C)(5).



Features

Housing

- Non-electrically conductive polycarbonate frame.
- High impact diffuse polystyrene lens provides shielding to the light guide with no pixilation
- Stamped aluminum housing provides thermal cooling achieving L70 at 50,000 hours in IC and non-IC applications

Gaskets

- Closed cell gasket achieves restrictive airflow and wet location requirements without additional caulking

Optics

- Precision acrylic light guide organizes source flux into wide distribution with 1.2 – 1.4 spacing criteria useful for general area illumination

LED

- Mid power led array provide a uniform source with high efficiency and long life.
- Available in 90 CRI minimum, R9 greater than 50 and color accuracy within 3 SDCM provide color accuracy and uniformity

Driver

- Integral 120V 50/60Hz constant current driver provides noise free operation
- Continuous, flicker-free dimming from 100% to 5% with select leading or trailing edge 120V phase cut dimmers.
- Dimming to 5% is best assured using dimmers with low end trim adjustment. Consult dimmer manufacturer for compatibility and conditions of use. (Note some dimmers require a neutral in the wallbox.)
- Inline electrical quick connect (provided) provides mains connections

Mounting/Retention

- The SMD-DM with Spring Clips requires no housing or junction box
- The integral enclosure may be used in direct contact with insulation including spray foam insulation.
- Installer must cut template out of drywall, and install into the aperture with the clips compressed.
- When released, the spring clips will rest on to the back side of the drywall.
- Installer must ensure secure fit and wiring. This includes all applicable national and local electrical and building codes

Compliance

- cULus listed / certified for use with Halo housings, classified for use with other's housings, see instruction sheet for conditions of acceptability.
- Wet and Damp Location listed, airtight per ASTM-E283
- Suitable for use in closets,
- compliant with NFPA® 70, NEC® Section 410.16 (A)(3) and 410.16 (C)(5)
- EMI/RFI emissions per FCC 47CFR Part 15B
- Contains no mercury or lead and RoHS compliant.
- Photometric testing in accordance with IES LM-79-08
- Lumen maintenance projections in accordance with IES LM-80-08 and TM-21-11.
- Can be used for State of California Title 24 high efficacy luminaire compliance, reference the California Energy Commission Title 20 Appliance Efficiency Database for current listings.
- Can be used for International Energy Conservation Code (IECC) and Washington State Energy Code high efficiency luminaire compliance

SMD6-DM Energy Data @ 5000K

	Round	Square
Lumens	788	815
Input Voltage	120V	120V
Input Current	0.0811A	0.085 A
Input Power	9.7 W	10 W
Efficiency	82 lm/W	82 lm/W
THD	13.9	14.7
Frequency	50/60 Hz	50/60 Hz
CRI	90 CRI	90 CRI
PF	0.99	0.99
T Ambient	-30 - +40°C	-30 - +40°C
Sound Rating	Class A	Class A

SMD6-DM Series Ordering Information

Models	Lumens	CRI / CCT	Finish	Mounting
SMD6R = 6" Round Surface Mount Downlight, 120V	6 = 600 lumen series	927 = 90CRI, 2700K 930 = 90CRI, 3000K 935 = 90CRI, 3500K	940 = 90CRI, 4000K 950 = 90CRI, 5000K	WH = white DM = Direct Mount
SMD6S = 6" Square Surface Mount Downlight, 120V	6 = 600 lumen series			

LED Surface Mount

BLD4 Series

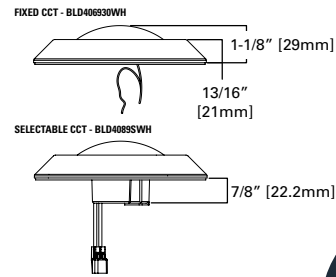
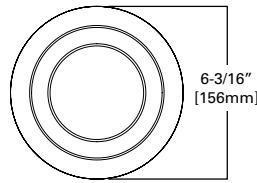

BLD4

4" Backlit LED Downlight

The Halo Backlit LED Downlight (BLD) incorporates state of the art lighting technology to create an ultra-low profile surface mounting luminaire with the performance and look of a traditional downlight. BLD4 is designed for installation in many 3-1/2" and 4" round or octagon junction boxes including pancake boxes. It can also retrofit in 4" aperture IC and Non-IC recessed housings. Suitable for residential or commercial installations.



Features

Construction

Stamped aluminum housing and frame

Optics

- Precision engineered optic provides uniform luminance from a low profile convex lens

LED

- Backlit LED technology
- Color Temperature options include: standard 3000K dedicated or SeleCCTable configuration including 2700K, 3000K, 3500K, 4000K and 5000K options.
- 90 CRI is standard
- L70 at 50,000 hours projected in accordance with TM-21

Driver

- Integral 120V 60Hz constant current driver provides virtually noise free operation.
- Continuous, flicker-free dimming from 100% to 5% with select leading or trailing edge 120V phase cut dimmers. See dimming guide.
- Dimming to 5% is best assured using dimmers with low end trim adjustment. Consult dimmer manufacturer for compatibility and conditions of use. (Note some dimmers require a neutral in the wallbox.)
- Inline electrical quick connect and E26 adapter (provided) provides mains connections.

Electrical Junction Box Mounting

- BLD may be used in compatible electrical junction boxes in direct contact with insulation including spray foam insulation
- Suitable for installation in many 3-1/2" and 4" octagon and round electrical junction boxes.
- Dedicated CCT SKUs are compatible with compact (pancake) junction boxes
- Selectable CCT configuration, driver consumes 3 cubic inches of junction box, selectable CCT configuration is not compatible with pancake junction boxes
- Installer must ensure compatibility of fit, wiring and proper mounting in the electrical junction box. This includes all applicable national and local electrical and building coded Recessed Housing Mounting
- Can be installed in industry standard 4-inch recessed housings using friction mounting springs and (E26) medium base adapter provided.
- Not for use in recessed housings in direct contact with spray foam insulation refer to NEMA LSD 57-2013

Warranty

- Five year limited warranty, consult website for details. www.cooperlighting.com/legal

Compliance

- cULus certified for use with Halo housings and other's housings, see instruction sheet for conditions of acceptability.
- Wet and Damp Location listed, airtight per ASTM-E283 (protected ceiling only)
- Suitable for use in clothes closets when installed in accordance with the NEC 410.16 spacing requirements.
- EMI/RFI emissions per FCC 47CFR Part 15B
- Contains no mercury or lead and RoHS compliant.
- Photometric testing in accordance with IES LM-79-08
- Lumen maintenance projections in accordance with IES LM-80-08 and TM-21-11.
- Can be used for State of California Title 24 high efficacy luminaire compliance, reference the California Energy Commission Title 20 Appliance Efficiency Database for current listings.
- Can be used for International Energy Conservation Code (IECC) and Washington State Energy Code high efficiency luminaire Compliance
- ENERGY STAR® Certified luminaire - consult ENERGY STAR® Certified Product List

BLD4 Energy Data

	3000K Dedicated	SeleCCTable 2700K-5000K
Lumens	690	802
Wattage	8.2W	10.3W
Input Current	0.07	0.087
Efficacy	84.1 LPW	77.9 LPW
THD	15.1%	11.9%
Frequency	60 Hz	60 Hz
T Ambient	-30 - +40°C	-30 - +40°C
Voltage	120V	120V
Sound Rating	Class A	Class A
Power Factor	0.99	0.99

LED Surface Mount

BLD4 Series

BLD4 Series Ordering Information

Models	Lumens	Color Rendering Index (CRI)	Finish	Voltage
BLD4 = 4" Surface LED downlight, 120V (Includes hardware kits for junction box and recessed housing mounting)	06 = 600 lumen series	930 = 90CRI, 3000K	WH = Matte white	Blank = 120V
	06 = 900 lumen series	9S = 90 CRI, SeleCCTable 2700K, 3000K, 3500K, 4000K & 5000K	WH = Matte white	Blank = 120V

Housing Compatibility

Models	Recessed Can Size	Catalog Number
HALO LED Compatible Halo LED Housings with LED luminaire connector (high-efficacy compliant)	4"	H995ICAT, H995RICAT, H245ICAT, H245RICAT
HALO Compatible Halo Incandescent E26 Screwbase Housings	4"	H99ICAT, H99TAT, H99RTAT, E4ICATSB, E4TATSB, E4RTATSB

Compatible with Eaton's Crouse-Hinds Junction Box (Order Separately)

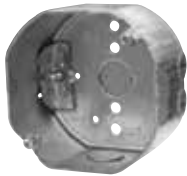

TP316
For non-metallic (NM) cable 4" x 4" x 2-1/8"
[102mm x 102mm x 54mm]

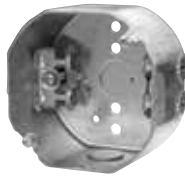

TP317
For metal clad cable 4" x 4" x 2-1/8"
[102mm x 102mm x 54mm]

- **TP316** - for non-metallic (NM) cable
- **TP317** - for metal clad cable
- UL Listed
- Refer to www.crouse-hinds.com

Compatible with many other Junction Boxes*



4" octagon light fixture/fan steel box
4" x 4" x 2-1/8"
(102mm x 102mm x 54mm)



4" octagon steel box
4" x 4" x 1-1/2"
(102mm x 102mm x 38mm)



4" round new work non-metallic box with hanger bar assembly
4" diameter x 2-3/16" (102mm x 56mm)



4" round new work non-metallic light fixture/fan box
4" diameter x 2-3/16"
(102mm x 56mm)



3-1/2" round new work non-metallic ceiling box
3-1/2" diameter x 2-3/4"
(89mm x 70mm)



3-1/2" round old work non-metallic box
4-1/4" O.D. flange, 3-1/2" I.D. x 2-5/8"
(108mm O.D., 89mm I.D. x 67mm)



4" round surface mount box
4" diameter x 1-1/2"
(102mm x 38mm)



Round ceiling pan
4" diameter x 13/16"
(102mm x 21mm)
Note: only compatible with fixed CCT BLD406930

*This is a representative list of compatible junction boxes only. Information contained in this literature about other manufacturers' products is from published information made available by the manufacturer and is deemed to be reliable, but has not been verified. Cooper Lighting Solutions makes no specific recommendation on product selection and there are no warranties of performance or compatibility implied. Installer must determine that site conditions are suitable to allow proper installation of the mounting bracket in the box.

LED Surface Mount

BLD6 Series

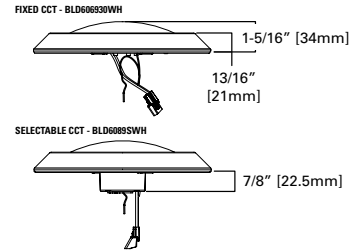
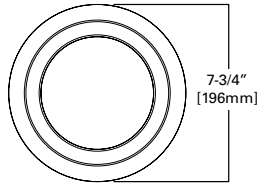

BLD6

6" Backlit LED Downlight

The Halo Backlit LED Downlight (BLD) incorporates state of the art lighting technology to create an ultra-low profile surface mounting luminaire with the performance and look of a traditional downlight. BLD6 is designed for installation in many 3-1/2" and 4" round or octagon junction boxes including pancake boxes. It can also retrofit in 5" or 6" aperture IC and Non-IC recessed housings. Suitable for residential or commercial installations.



Features

Construction

Stamped aluminum housing and frame

Optics

- Precision engineered optic provides uniform luminance from a low profile convex lens

LED

- Backlit LED technology
- Color Temperature options include: standard 3000K dedicated or SeleCCTable configuration including 2700K, 3000K, 3500K, 4000K and 5000K options.
- 90 CRI is standard
- L70 at 50,000 hours projected in accordance with TM-21

Driver

- Integral 120V 60Hz constant current driver provides virtually noise free operation.
- Continuous, flicker-free dimming from 100% to 5% with select leading or trailing edge 120V phase cut dimmers. See dimming guide.
- Dimming to 5% is best assured using dimmers with low end trim adjustment. Consult dimmer manufacturer for compatibility and conditions of use. (Note some dimmers require a neutral in the wallbox.)
- Inline electrical quick connect and E26 adapter (provided) provides mains connections.

Electrical Junction Box Mounting

- BLD may be used in compatible electrical junction boxes in direct contact with insulation including spray foam insulation
- Suitable for installation in many 3-1/2" and 4" octagon and round electrical junction boxes.
- Dedicated CCT SKUs are compatible with compact (pancake) junction boxes
- Selectable CCT configuration, driver consumes 3 cubic inches of junction box, selectable CCT configuration is not compatible with pancake junction boxes
- Installer must ensure compatibility of fit, wiring and proper mounting in the electrical junction box. This includes all applicable national and local electrical and building coded Recessed Housing Mounting Torsion Spring 5" & 6"
- Precision formed torsion spring bracket kit included
- The torsion springs adjust on the mounting plate to fit 5" or 6" compatible housings
- Not for use in recessed housings in direct contact with spray foam insulation refer to NEMA LSD 57-2013

Warranty

- Five year limited warranty, consult website for details. www.cooperlighting.com/legal

Compliance

- cULus certified for use with Halo housings and other's housings, see instruction sheet for conditions of acceptability.
- Wet and Damp Location listed, airtight per ASTM-E283 (protected ceiling only)
- Suitable for use in clothes closets when installed in accordance with the NEC 410.16 spacing requirements.
- EMI/RFI emissions per FCC 47CFR Part 15B
- Contains no mercury or lead and RoHS compliant.
- Photometric testing in accordance with IES LM-79-08
- Lumen maintenance projections in accordance with IES LM-80-08 and TM-21-11.
- Can be used for State of California Title 24 high efficacy luminaire compliance, reference the California Energy Commission Title 20 Appliance Efficiency Database for current listings.
- Can be used for International Energy Conservation Code (IECC) and Washington State Energy Code high efficiency luminaire Compliance
- ENERGY STAR® Certified luminaire - consult ENERGY STAR® Certified Product List

BLD6 Energy Data

	3000K Dedicated	SeleCCTable 2700K-5000K
Lumens	700	812
Wattage	8.2W	10.3W
Input Current	0.07	0.088
Efficacy	85.4 LPW	78.8 LPW
THD	14.3%	11.8%
Frequency	60 Hz	60 Hz
T Ambient	-30 - +40°C	-30 - +40°C
Voltage	120V	120V
Sound Rating	Class A	Class A
Power Factor	0.99	0.99

LED Surface Mount

BLD6 Series

BLD4 Series Ordering Information

Models	Lumens	Color Rendering Index (CRI)	Finish	Voltage
BLD6 = 6" Backlit LED downlight	06 = 600 lumen series	930 = 90CRI, 3000K	WH = Matte white	Blank = 120V
	08 = 800 lumen series	9S = 90 CRI, SeleCCTable 2700K, 3000K, 3500K, 4000K & 5000K	WH = Matte white	Blank = 120V

Housing Compatibility

Models	Recessed Can Size	Catalog Number
HALO LED Compatible Halo LED Housings with LED luminaire connector (high-efficacy compliant)	5"	H550ICAT, H550RICAT, E550ICAT, E550RICAT
	6"	H750ICAT, H750RICAT, H750T, H750RINTD010, H750TCP, H2750ICAT, H2750RICAT, E750ICAT, E750RICAT
HALO Halo LED Retrofit Enclosures	6"	ML7BXRFK, ML7E26RFK
HALO Compatible Halo Incandescent E26 Screwbase Housings	5"	H5ICAT, H5RICAT, H5ICATNB, H5T, H5RT, H25ICAT, H25ICATNB, E5TAT, E5RTAT, H5TNB, E5TATNB, E5ICAT, E5RICAT, E5ICATNB
	6"	H7ICAT, H7RICAT, H7ICT, H7RICT, H7ICATNB, H7ICTNB, H7T, H7RT, H7TNB, H7TCP, H7UICAT, H7UICATNB, H27ICAT, H27RICAT, H27T, H27RT, E7ICAT, E7RICAT, E27ICAT, E27RICAT, E7ICATNB, E7TAT, E7RTAT, E7TATNB, E27TAT, E27RTAT

Compatible with Eaton's Crouse-Hinds Junction Box (Order Separately)

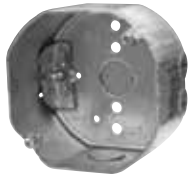

TP316
For non-metallic (NM) cable 4" x 4" x 2-1/8"
(102mm x 102mm x 54mm)

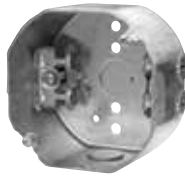

TP317
For metal clad cable 4" x 4" x 2-1/8"
(102mm x 102mm x 54mm)

- **TP316** - for non-metallic (NM) cable
- **TP317** - for metal clad cable
- UL Listed
- Refer to www.crouse-hinds.com

Compatible with many other Junction Boxes*



4" octagon light fixture/fan steel box
4" x 4" x 2-1/8"
(102mm x 102mm x 54mm)



4" octagon steel box
4" x 4" x 1-1/2"
(102mm x 102mm x 38mm)

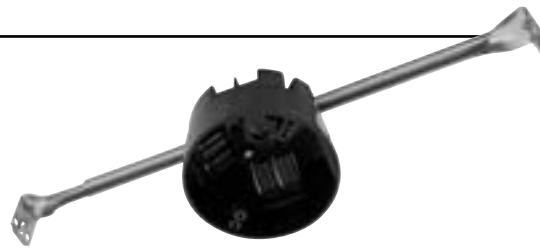

4" round new work non-metallic box with hanger bar assembly
4" diameter x 2-3/16" (102mm x 56mm)



4" round new work non-metallic light fixture/fan box
4" diameter x 2-3/16"
(102mm x 56mm)



3-1/2" round new work non-metallic ceiling box
3-1/2" diameter x 2-3/4"
(89mm x 70mm)



3-1/2" round old work non-metallic box
4-1/4" O.D. flange, 3-1/2" I.D. x 2-5/8"
(108mm O.D., 89mm I.D. x 67mm)



4" round surface mount box
4" diameter x 1-1/2"
(102mm x 38mm)



Round ceiling pan
4" diameter x 13/16"
(102mm x 21mm)
Note: only compatible with fixed CCT BLD406930



4" square deep steel box
4" x 4" x 2-1/8"
(102mm x 102mm x 54mm)



4" square standard steel box
4" x 4" x 1-1/2"
(102mm x 102mm x 38mm)

*This is a representative list of compatible junction boxes only. Information contained in this literature about other manufacturers' products is from published information made available by the manufacturer and is deemed to be reliable, but has not been verified. Cooper Lighting Solutions makes no specific recommendation on product selection and there are no warranties of performance or compatibility implied. Installer must determine that site conditions are suitable to allow proper installation of the mounting bracket in the box.

LED Surface Mount

CLD7 Series

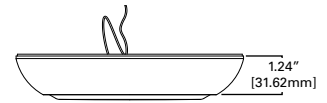
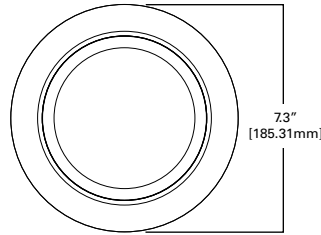

CLD7

7" Low-Profile LED Downlight

The Halo CLD is a low profile, high performance surface mount luminaire that offers the added flexibility of 3 selectable color temperatures at time of installation. CLD7 (7") is designed for installation in many 3-1/2" and 4" square, octagon, or round junction boxes. Supply wire adapter with LED quick wiring connector included.



3000K • 4000K • 5000K



Features

Construction

Stamped aluminum housing and frame

Optics

- Precision engineered optic provides uniform luminance from a low profile convex lens
- Removable lens for easy install from below installation

LED

- Backlit LED technology
- Color Temperature options include: SeleCCTable configuration 3000K, 4000K or 5000K via switch
- 90 CRI is standard
- L70 at 50,000 hours projected in accordance with TM-21

Driver

- Integral 120V 60Hz constant current driver provides virtually noise free operation.
- Continuous, flicker-free dimming from 100% to 5% with select leading or trailing edge 120V phase cut dimmers. See dimming guide.
- Dimming to 5% is best assured using dimmers with low end trim adjustment. Consult dimmer manufacturer for compatibility and conditions of use. (Note some dimmers require a neutral in the wallbox.)

Electrical Junction Box Mounting

- CLD may be used in compatible electrical junction boxes in direct contact with insulation including spray foam insulation
 - Install from below design
 - Suitable for installation in many 3-1/2" and 4" octagon and round electrical junction boxes.
 - Compatible with compact (pancake) junction boxes
- Note:** Fire-rating is per the rating of the ceiling and applicable junction box, not the CLD.
- Installer must ensure compatibility of fit, wiring and proper mounting in the electrical junction box. This includes all applicable national and local electrical and building coded NEMA LSD 57-2013

Warranty

- Five year limited warranty, consult website for details. www.cooperlighting.com/legal

Compliance

- UL certified for US and Canada
- Wet and Damp Location listed, airtight per ASTM-E283 (protected ceiling only)
- Suitable for use in clothes closets when installed in accordance with the NEC 410.16 spacing requirements.
- EMI/RFI emissions per FCC 47CFR Part 15B
- Contains no mercury or lead and RoHS compliant.

- Photometric testing in accordance with IES LM-79-08
- Lumen maintenance projections in accordance with IES LM-80-08 and TM-21-11.
- Can be used for State of
- California Title 24 high efficacy luminaire compliance, reference the California Energy Commission Title 20 Appliance Efficiency Database for current listings.
- Can be used for International Energy Conservation Code (IECC) and Washington State Energy Code high efficiency luminaire compliance
- ENERGY STAR® Certified luminaire - consult ENERGY STAR® Certified Product List

CLD Energy Data

	90 CRI
Lumens	800
Input Voltage	120V
Input Current	x (mA)
Input Power	11.2 (W)
Inrush (A)	x
THD	≤ 20%
PF	≥ 0.90
T Ambient	-30 - +40°C
Sound Rating	≤ 20dba

LED Surface Mount

CLD7 Series

CLD7 Series Ordering Information

Models	Lumens	Color Rendering Index (CRI)	Finish	Accessories
CLD7 = 7" LED surface light	08 = 800 lumen series	9S = 90 CRI, SeleCCTable 2700K, 3000K, 3500K, 4000K & 5000K	WH = Matte white	R = recyclable unit carton suitable for merchandising display

Compatible with Eaton's Crouse-Hinds Junction Box (Order Separately)

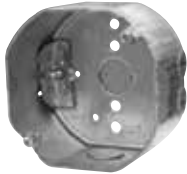

TP316
For non-metallic (NM) cable 4" x 4" x 2-1/8"
[102mm x 102mm x 54mm]

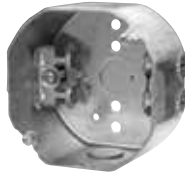

TP317
For metal clad cable 4" x 4" x 2-1/8"
[102mm x 102mm x 54mm]

- **TP316** - for non-metallic (NM) cable
- **TP317** - for metal clad cable
- UL Listed
- Refer to www.crouse-hinds.com

Compatible with many other Junction Boxes*



4" octagon light fixture/fan steel box
4" x 4" x 2-1/8"
(102mm x 102mm x 54mm)



4" octagon steel box
4" x 4" x 1-1/2"
(102mm x 102mm x 38mm)



4" round new work non-metallic box with hanger bar assembly
4" diameter x 2-3/16" (102mm x 56mm)



4" round new work non-metallic light fixture/fan box
4" diameter x 2-3/16"
(102mm x 56mm)



3-1/2" round new work non-metallic ceiling box
3-1/2" diameter x 2-3/4"
(89mm x 70mm)



3-1/2" round old work non-metallic box
4-1/4" O.D. flange, 3-1/2" I.D. x 2-5/8"
(108mm O.D., 89mm I.D. x 67mm)



4" round surface mount box
4" diameter x 1-1/2"
(102mm x 38mm)



Round ceiling pan
4" diameter x 13/16"
(102mm x 21mm)
Note: only compatible with fixed CCT BLD406930

*This is a representative list of compatible junction boxes only. Information contained in this literature about other manufacturers' products is from published information made available by the manufacturer and is deemed to be reliable, but has not been verified. Cooper Lighting Solutions makes no specific recommendation on product selection and there are no warranties of performance or compatibility implied. Installer must determine that site conditions are suitable to allow proper installation of the mounting bracket in the box.

LED Surface Mount

SMD4 Series

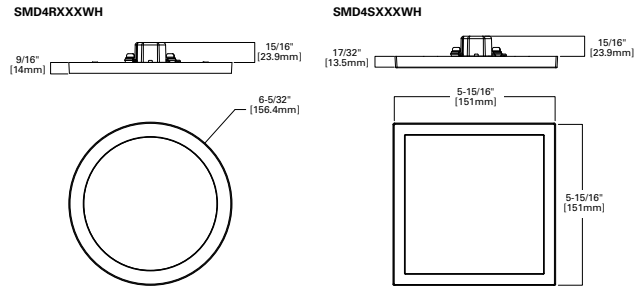

SMD4

4" LED Round and Square Surface Mount

The Halo Surface Mount LED Downlight (SMD) is a low profile surface mounting luminaire with a modern look and high performance. SMD4 (4") is designed for installation in many 3-1/2" and 4" square, octagon, or round junction boxes. Supply wire adapter with LED quick wiring connector included. The SMD4 may also retrofit in 4" aperture IC and Non-IC recessed housings. Compliant with NFPA® 70, NEC® Section 410.16 (A)(3) and 410.16 (C)(5).



Features

Housing

- Non-electrically conductive polycarbonate frame.
- High impact diffuse polystyrene lens provides shielding to the light guide with no pixilation
- Stamped aluminum housing provides thermal cooling achieving L70 at 50,000 hours in IC and non-IC applications

Gaskets

- Closed cell gasket achieves restrictive airflow and wet location requirements without additional caulking

Optics

- Precision acrylic light guide organizes source flux into wide distribution with 1.2 – 1.4 spacing criteria useful for general area illumination

LED

- Mid power led array provide a uniform source with high efficiency and long life.
- Available in 90 CRI minimum, R9 greater than 50 and color accuracy within 3 SDCM provide color accuracy and uniformity

Driver

- Integral 120V 50/60Hz constant current driver provides noise free operation.
- Continuous, flicker-free dimming from 100% to 5% with select leading or trailing edge 120V phase cut dimmers.
- Dimming to 5% is best assured using dimmers with low end trim adjustment. Consult dimmer manufacturer for compatibility and conditions of use. (Note some dimmers require a neutral in the wallbox.)
- Inline electrical quick connect and E26 adapter (provided) provides mains connections.

Mounting/Retention

- Adjustable spider plate allows for quick installation into both junction boxes and recessed housings.
- Friction blades included

Electrical Junction Box Mounting

- The SMD may be used in compatible electrical junction boxes in direct contact with insulation including spray foam insulation.
- Suitable for installation in many 3-1/2" and 4" square, octagon, and round electrical junction boxes.
- Installer must ensure compatibility of fit, wiring and proper mounting in the electrical junction box. This includes all applicable national and local electrical and building code

Recessed Housing Mounting

- May be installed in IC recessed housings in direct contact with insulation
- Note: Not for use in recessed housing in direct contact with spray foam insulation. Refer to NEMA LSD 57-2013.
- May be installed in IC recessed housings in direct contact with insulation
- Note: Not for use in recessed housing in direct contact with spray foam insulation. Refer to NEMA LSD 57-2013

Friction Blade 4"

- Precision formed friction blades included
- For retrofit in 4" nominal housings
- Friction blade design allows the SMD to be installed in any position within the housing aperture (360 degrees)

Designer Skins (Sold Separately)

- SMD skins are accessory rings in both round and square. These skins attach to the SMD for a permanent finish. Refer to the SMD accessories specification sheet for details.
- Matte White (Paintable)
- Satin Nickel
- Tuscan Bronze

Warranty

- Five year limited warranty, consult website for details. www.cooperlighting.com/legal

Compliance

- cULus listed / certified for use with Halo housings, classified for use with other's housings, see instruction sheet for conditions of acceptability.
- Wet and Damp Location listed, airtight per ASTM-E283
- Suitable for use in closets, compliant with NFPA® 70, NEC® Section 410.16 (A)(3) and 410.16 (C)(5)
- EMI/RFI emissions per FCC 47CFR Part 15B
- Contains no mercury or lead and RoHS compliant.
- Photometric testing in accordance with IES LM-80-08
- Lumen maintenance projections in accordance with IES LM-80-08 and TM-21-11.
- Can be used for State of California Title 24 high efficacy luminaire compliance, reference the California Energy Commission Title 20 Appliance Efficiency Database for current listings.
- Can be used for International Energy Conservation Code (IECC) and Washington State Energy Code high efficiency luminaire compliance

LED Surface Mount

SMD6 - 600 & 1200 Series

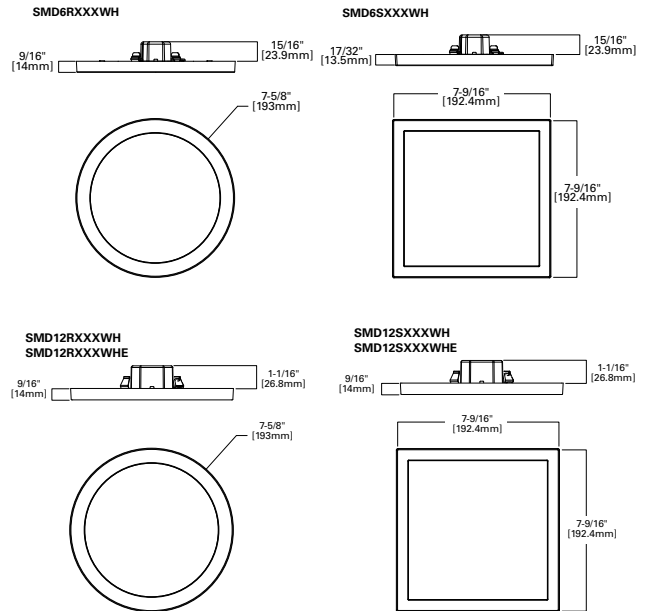

SMD6

6" LED Round and Square Surface Mount

The Halo Surface Mount LED Downlight (SMD) is a low profile surface mounting luminaire with a modern look and high performance. SMD6 (6") is designed for installation in many 3-1/2" and 4" square, octagon, or round junction boxes. Supply wire adapter with LED quick wiring connector included. The SMD6 may also retrofit in 5" and 6" aperture IC and Non-IC recessed housings.



Features

Housing

- Non-electrically conductive polycarbonate frame.
- High impact diffuse polystyrene lens provides shielding to the light guide with no pixilation
- Stamped aluminum housing provides thermal cooling achieving L70 at 50,000 hours in IC and non-IC applications

Gaskets

- Closed cell gasket achieves restrictive airflow and wet location requirements without additional caulking

Optics

- Precision acrylic light guide organizes source flux into wide distribution with 1.2 – 1.4 spacing criteria useful for general area illumination

LED

- Mid power LED array provide a uniform source with high efficiency and long life.
- Available in 90 CRI minimum, R9 greater than 50 and color accuracy within 3 SDCM provide color accuracy and uniformity

Driver

SMD 120-277V

- Integral 120V 50/60Hz constant current driver provides noise free operation.
- Continuous, flicker-free dimming from 100% to 5% with select leading or trailing edge 120V phase cut dimmers.
- Dimming to 5% is best assured using dimmers with low end trim adjustment. Consult dimmer manufacturer for compatibility and conditions of use. (Note some dimmers require a neutral in the wallbox.)
- Inline electrical quick connect and E26 adapter (provided) provides mains connections.

SMD 120-277V

- Integrated 120-277V 60Hz constant current driver provides noise free operation.
- SMD Universal Voltage (120-277V) configurations are recommended for use with compatible 0-10V DC low voltage dimmers only.

Mounting/Retention

- Adjustable spider plate allows for quick installation into both junction boxes and recessed housings.
- Torsion springs and friction blades included

Electrical Junction Box Mounting

- The SMD may be used in compatible electrical junction boxes in direct contact with insulation including spray foam insulation.
- Suitable for installation in many 3-1/2" and 4" square, octagon, and round electrical junction boxes.
- Note: SMD120-277V UNV is only compatible with junction boxes that provide minimum depth of 2-1/8".
- Installer must ensure compatibility of fit, wiring and proper mounting in the electrical junction box. This includes all applicable national and local electrical and building coded

Recessed Housing Mounting

- May be installed in IC recessed housings in direct contact with insulation
- Note: Not for use in recessed housing in direct contact with spray foam insulation. Refer to NEMA LSD 57-2013.
- **Torsion Spring 5" & 6"**
- Precision formed torsion spring bracket kit included
- The torsion springs adjust on the mounting plate to fit 5" or 6" compatible housings
- **Friction Blade 5" & 6"**
- Precision formed friction blades included
- For retrofit in 5" and 6" housings without torsion springs mounting tabs.
- Friction blade design allows the SMD to be installed in any position within the housing aperture (360 degrees)

Designer Skins (Sold Separately)

- SMD skins are accessory rings in both round and square. These skins attach to the SMD for a permanent finish. Refer to the SMD accessories specification sheet for details.
- Matte White (Paintable)
- Satin Nickel
- Tuscan Bronze

Warranty

- Five year limited warranty, consult website for details. www.cooperlighting.com/legal

Compliance

- cULus Certified for use with Halo housings and for use with other's housings, see instruction sheet for conditions of acceptability.
- Wet and Damp Location listed, airtight per ASTM-E283
- Suitable for use in closets, compliant with NFPA® 70, NEC® Section 410.16 (A)(3) and 410.16 (C)(5)
- EMI/RFI emissions per FCC 47CFR Part 15B
- Contains no mercury or lead and RoHS compliant.
- Photometric testing in accordance with IES LM-79-08
- Lumen maintenance projections in accordance with IES LM-80-08 and TM-21-11.
- Can be used for State of California Title 24 high efficacy luminaire compliance, reference the California Energy Commission Title 20 Appliance Efficiency Database for current listings.
- Can be used for International Energy Conservation Code (IECC) and high efficiency luminaire compliance
- ENERGY STAR® listed, reference database for current listings

LED Surface Mount

SMD4 & SMD6 - 600 & 1200 Series

SMD 4" & 5/6" Series Ordering Information

Models	Lumens	CRI / CCT	Finish	Voltage
SMD4R = 4" Round Surface Mount Downlight, 120V SMD4S = 4" Square Surface Mount Downlight, 120V	6 = 600 lumen series	927 = 90CRI, 2700K 930 = 90CRI, 3000K 935 = 90CRI, 3500K	940 = 90CRI, 4000K 950 = 90CRI, 5000K	WH = Matte white
SMD6R = 6" Round Surface Mount Downlight SMD6S = 6" Square Surface Mount Downlight	6 = 600 lumen series 12 = 1200 lumen series	927 = 90CRI, 2700K 930 = 90CRI, 3000K 935 = 90CRI, 3500K	940 = 90CRI, 4000K 950 = 90CRI, 5000K	WH = Matte white Blank = 120V standard E = UNV Universal 120-277V*

Accessories (Order Separately)

Designer Trims

SMD4RTRMSN = 4" Round SMD Satin Nickel
SMD4RTRMTBZ = 4" Round SMD Tuscan Bronze
SMD4RTRMWH = 4" Round SMD White (paintable)
SMD4STRMSN = 4" Square SMD Satin Nickel
SMD4STRMTBZ = 4" Square SMD Tuscan Bronze
SMD4STRMWH = 4" Square SMD White (paintable)

SMD6RTRMSN = 6" Round SMD Satin Nickel
SMD6RTRMTBZ = 6" Round SMD Tuscan Bronze
SMD6RTRMWH = 6" Round SMD White (paintable)
SMD6STRMSN = 6" Square SMD Satin Nickel
SMD6STRMTBZ = 6" Square SMD Tuscan Bronze
SMD6STRMWH = 6" Square SMD White (paintable)

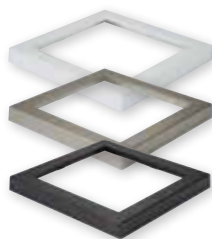

SMD-STRMWH
square, white (paintable)

SMD-STRMSN
square, satin nickel

SMD-STRMTBZ
square, tuscan bronze



SMD-RTRMWH
round, white (paintable)

SMD-RTRMSN
round, satin nickel

SMD-RTRMTBZ
round, tuscan bronze



T24HWKIT



HE26LED

E26 Screw base adapter for retrofit (included)

T24HWKIT = Title 24 Cable harness kit used to convert incandescent and low voltage housings to LED
HE26LED = E26 Screw base adapter for retrofit (included)

Energy Data

SMD4

	Round	Square
Lumens (5000K)	786	810
Input Power	9.7 W	10 W
Input Current	0.0811A	0.0829 A
Efficiency	81 lm/W	81 lm/W
THD	13.3	13.2
Input Voltage	120V	120V
Frequency	50/60 Hz	50/60 Hz
CRI	90 CRI	90 CRI
PF	0.99	0.99
T Ambient	-30 - +40°C	-30 - +40°C
Sound Rating	Class A	Class A

SMD6R6 / SMD6S6

	Round	Square
Lumens (5000K)	788	815
Input Power	9.6 W	9.9 W
Input Current	0.0811A	0.085 A
Efficiency	82 lm/W	82 lm/W
THD	13.9	14.7
Input Voltage	120V	120V
Frequency	50/60 Hz	50/60 Hz
CRI	90 CRI	90 CRI
PF	0.99	0.99
T Ambient	-30 - +40°C	-30 - +40°C
Sound Rating	Class A	Class A

SMD6R12 / SMD6S12

	Round	Square
Lumens (5000K)	1252	1235
Input Power	15.3 W	15.7 W
Input Current	0.133 A	0.132 A
Efficiency	82 lm/W	79 lm/W
THD	15.3	15.7
Input Voltage	120V	120V
Frequency	50/60 Hz	50/60 Hz
CRI	90 CRI	90 CRI
PF	0.98	0.98
T Ambient	-30 - +40°C	-30 - +40°C
Sound Rating	Class A	Class A

SMD6R12-E / SMD6S12-E

	Round	Square
Lumens (5000K)	1200	1180
Input Power	15.3 W	16 W
Input Current	0.133 A - (120V) 0.061 A - (277V)	0.132 A - (120V) 0.061 A - (277V)
Efficiency	81 lm/W	81 lm/W
THD	13.3	13.2
Input Voltage	120 - 277V	120 - 277V
Frequency	60 Hz	60 Hz
CRI	92 CRI	92 CRI
PF	0.99	0.99
T Ambient	-30 - +40°C	-30 - +40°C
Sound Rating	Class A	Class A

LED Surface Mount

SMD4 & SMD6 - 600 & 1200 Series

Housing Compatibility

Models	Recessed Can Size	Catalog Number
HALO LED Compatible Halo LED Housings with LED luminaire connector (high-efficacy compliant)	4"	H9951CAT, H995RICAT, H2451CAT, H245RICAT
	5"	H5501CAT, H550RICAT, E5501CAT, E550RICAT
	6"	H7501CAT, H750RICAT, H750T, H750RINTD010, H750TCP, H27501CAT, H2750RICAT, E7501CAT, E750RICAT
HALO Halo LED Retrofit Enclosures	6"	ML7BXRFK, ML7E26RFK
HALO Compatible Halo Incandescent E26 Screwbase Housings	4"	H991CAT, H99TAT, H99RTAT, E41CATSB, E4TATSB, E4RTATSB
	5"	H51CAT, H5RICAT, H51CATNB, H5T, H5RT, H251CAT, H251CATNB, E5TAT, E5RTAT, H5TNB, E5TATNB, E51CAT, E5RICAT, E51CATNB
	6"	H71CAT, H7RICAT, H71CT, H7RICT, H71CATNB, H71CTNB, H7T, H7RT, H7TNB, H7TCP, H7U1CT, H7U1CAT, H271CAT, H27RICAT, H27T, H27RT, E71CAT, E7RICAT, E271CAT, E27RICAT, E71CATNB, E7TAT, E7RTAT, E7TATNB, E27TAT, E27RTAT

Compatible with Eaton's Crouse-Hinds Junction Box (Order Separately)

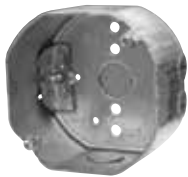

TP316
For non-metallic (NM) cable 4" x 4" x 2-1/8"
[102mm x 102mm x 54mm]

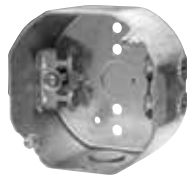

TP317
For metal clad cable 4" x 4" x 2-1/8"
[102mm x 102mm x 54mm]

- **TP316** - for non-metallic (NM) cable
- **TP317** - for metal clad cable
- UL Listed
- Refer to www.crouse-hinds.com

Compatible with many other Junction Boxes*



4" octagon light fixture/fan steel box
4" x 4" x 2-1/8"
(102mm x 102mm x 54mm)



4" octagon steel box
4" x 4" x 1-1/2"
(102mm x 102mm x 38mm)



4" round new work non-metallic box with hanger bar assembly
4" diameter x 2-3/16" (102mm x 56mm)



4" round new work non-metallic light fixture/fan box
4" diameter x 2-3/16"
(102mm x 56mm)



3-1/2" round new work non-metallic ceiling box
3-1/2" diameter x 2-3/4"
(89mm x 70mm)



3-1/2" round old work non-metallic box
4-1/4" O.D. flange, 3-1/2" I.D. x 2-5/8"
(108mm O.D., 89mm I.D. x 67mm)



4" round surface mount box
4" diameter x 1-1/2"
(102mm x 38mm)



4" square deep steel box
4" x 4" x 2-1/8"
(102mm x 102mm x 54mm)



4" square standard steel box
4" x 4" x 1-1/2"
(102mm x 102mm x 38mm)

*This is a representative list of compatible junction boxes only. Information contained in this literature about other manufacturers' products is from published information made available by the manufacturer and is deemed to be reliable, but has not been verified. Cooper Lighting Solutions makes no specific recommendation on product selection and there are no warranties of performance or compatibility implied. Installer must determine that site conditions are suitable to allow proper installation of the mounting bracket in the box.

LED Surface Mount

SLD4 Series

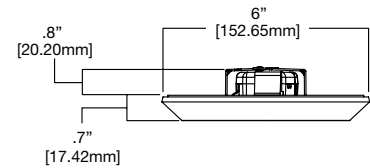
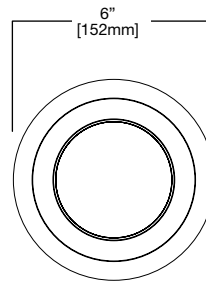

SLD4

4" LED Retrofit Module, SLD4 Model

The Halo Surface LED Downlight (SLD) incorporates WaveStream™ technology to create an ultra-low profile surface mounting luminaire with the performance and look of a traditional downlight. SLD4 is designed for installation in many 3-1/2" and 4" round or octagon junction boxes. May also retrofit in 4" aperture IC and Non-IC recessed housings*. Suitable for residential or commercial installations. Ideal for closets, storage areas, attics and basements.

90 CRI



Features

Mechanical

Die cast aluminum trim ring, and die formed aluminum frame

Optics

- WaveStream™ technology provides uniform luminance from a low profile flat lens
- AccuAim™ optics provide directional control for the "cone-of-light" beam distribution of a traditional downlight
- Precision molded lens features high transmission polymer with UV stabilized protecting film

Designer Trims (Sold Separately)

SLD designer trims are accessories

- White (paintable)
- Satin nickel
- Tuscan bronze

Electrical Junction Box Mounting**

- Suitable for installation in many 3-1/2" and 4" octagon and round electrical junction boxes in direct contact with insulation including spray foam insulation

Note: Driver consumes 3 cubic inches of junction box

- Surface mounting in a fire-rated ceiling using an appropriate electrical box offers a cost-effective alternative to fire-rated recessed housings

Note: Fire-rating is per the rating of the ceiling and applicable junction box, not the SLD

- Proprietary Slot-N-Lock quick installation system for junction box installation
- T-bracket with Slot-N-Lock mounting tabs included

Recessed Housing Mounting

Friction Blade

- Pre-installed friction blades included

LED

- Correlated Color Temperature (CCT): 2700K, 3000K, 3500K, 4000K
- Color Rendering Index (CRI) options: 90
- Lumen maintenance L70 at 50,000 hours
- 700 nominal lumens, range dependent on CCT and CRI

Electrical Connections

Junction Box**

- Compatible with 3-1/2" x 2" and 4" x 1-1/2" round and octagon boxes (2-1/8" deep boxes recommended)
- Supply wire adapter with LED quick connector included

Recessed Housings

- LED connector is non-screw base luminaire disconnect for tool-less installation in Halo 4" H995 series LED housings
- LED connector meets California Title 24 high efficacy luminaire standard as a non-screw base
- E26 Edison screw base adapter included

LED Driver

- Driver is a 120V dimmable electronic power supply providing DC power to the LED arrays
- Driver features high power factor, low THD, and has integral thermal protection

Dimming

Designed for continuous dimming to nominally 5% with many 120V Leading Edge (LE) and Trailing Edge (TE) phase control dimmers. Dimming to 5% is best assured using dimmers with low end trim adjustment. Consult dimmer manufacturer for compatibility and conditions of use. (Note, some dimmers require a neutral in the wallbox)

Compliance

- cULus Listed ceiling and wall
- cULus Listed damp location, ceiling and wall
- cULus Listed wet location, covered ceiling only (shower rated)
- Suitable for use in closets, compliant with NFPA® 70, NEC® Section 410.16 (A)(3) and 410.16 (C)(5)
- UL Classified when used in retrofit with listed housings (See housing compatibility)
- EMI/RFI: meets FCC 47CFR Part 15 Class B limits, and is suitable for use in residential and commercial
- 90 CRI (R9 > 50) can be used to comply with California Title 24 high efficacy requirements. Title 20 Certified for residential compliance.
- Air-Tite certified per ASTM E283 not exceeding 2.0 CFM under 1.57psf (75 Pascals) pressure difference
- ENERGY STAR® certified downlight surface retrofit
- Contains no mercury or lead and RoHS compliant
- EMI/RFI per FCC 47CFR Part 15 Class B consumer limits, suitable for use in residential and commercial
- Contains no mercury or lead and RoHS compliant
- Photometric testing in accordance with IES LM-79
- Lumen maintenance projections in accordance with IES LM-80 and TM-21

*Note: Not for use in recessed housings in direct contact with spray foam insulation refer to NEMA LSD 57-2013

** Models with "JB" suffix include hardware kit for junction box mounting only

SLD4 Energy Data

	90 CRI
Lumens (4000K models)	710
Input Voltage	120V
Frequency	50/60 Hz
Input Current	0.10 A
Input Power	12 W
Efficiency (4000K models)	59 lm/W
THD	≤ 20%
Power Factor	≥ 0.90
T Ambient	-30 - +40°C
Sound Rating	Class A

LED Surface Mount

SLD4 Series

SLD4 Series Ordering Information

Models	Color Rendering Index (CRI)	Color Temperature (CCT)	Finish	JB (Optional)
Standard SLD405 = 4" Surface LED downlight, 120V (Includes hardware kits for junction box and recessed housing mounting)	9 = 90 CRI	27 = 2700K 30 = 3000K 35 = 3500K 40 = 4000K	WH = Matte white	
"JB" Models SLD405 = 4" Surface LED downlight, 120V (Includes hardware kit for junction box mounting ONLY)	9 = 90 CRI	27 = 2700K 30 = 3000K 35 = 3500K 40 = 4000K	WH = Matte white	JB = ONLY junction box hardware kit

Accessories (Order Separately)

Designer Trims

Fit over the SLD for a designer finish

SLD4TRMWH = 4" SLD white (paintable)

SLD4TRMSN = 4" SLD satin nickel

SLD4TRMTBZ = 4" SLD tuscan bronze

*SLD accessory trims attach with permanent adhesion and are not interchangeable after installation



Junction Box Spacer Extension Ring

Adds 15/16" depth when the SLD driver cannot fit into a junction box.



SLD4EXT = 4" Surface LED j-box extender, 7.75" O.D.



Dimensions

A: 7-3/4" [197mm]

B: 7/8" [24mm]

C: 3-7/8" [99mm]

D: 6.25" [159mm]

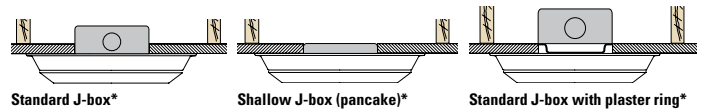

Replacement Parts Kit



SLD4ACCKIT

SLD4 Retrofit Kit - SLD4 screw base adapter, friction blades, ground wire, mounting screws, wire nuts



SLD4BRKT

SLD4 junction box mounting bracket and screws

Compatible Junction Boxes



Octagon - Steel
4" x 4" x 2-1/8"
4" x 4" x 1-1/2"



Round - Plastic
4" diameter x 2-3/16"

Fire Rated Install*

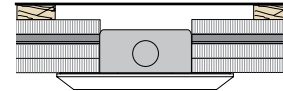

*For illustration only – not for construction

Surface Box Adapter

The surface box adapter fits the SLD into a 4-inch round or octagon junction box that is mounted flat on a ceiling or beam surface (not recessed in the ceiling)



SLD4RAD

4" SLD round surface j-box adapter.
For 4" round and octagon junction boxes.

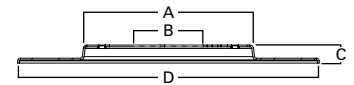

Dimensions

A: 4-1/2" [114mm]

B: 3-1/4" [84mm]

C: 1/2" [13mm]

D: 6-1/8" [156mm]

Compatible with Eaton's Crouse-Hinds Junction Box (Order Separately)

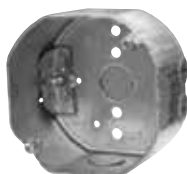

TP316

For non-metallic (NM) cable 4" x 4" x 2-1/8"
[102mm x 102mm x 54mm]

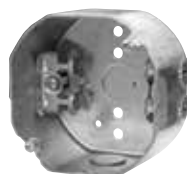

TP317

For metal clad cable 4" x 4" x 2-1/8"
[102mm x 102mm x 54mm]

- TP316 - for non-metallic (NM) cable
- TP317 - for metal clad cable
- UL Listed
- Refer to www.crouse-hinds.com

LED Surface Mount

SLD6 - 600 & 1200 Series

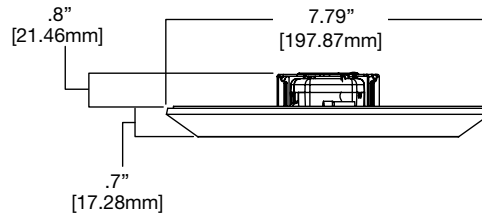

SLD606 - 600 Series, 120V SLD612 - 1200 Series, 120V

5" / 6" Surface LED Retrofit Module – 6 Inch Application

The Halo Surface LED Downlight (SLD) incorporates WaveStream™ technology to create an ultra-low profile surface mounting luminaire with the performance and look of a traditional downlight. SLD6 is designed for installation in many 3-1/2" and 4" square, octagon or round junction boxes. And may also retrofit in 5" and 6" IC and Non-IC recessed housings.* Suitable for residential or commercial installations. Ideal for closets, storage areas, attics and basements. Compliant with NFPA® 70, NEC® Section 410.16 (A)(3) and 410.16 (C)(5).



Features

Mechanical

Die cast aluminum trim ring, and die formed aluminum frame

Optics

- WaveStream™ technology provides uniform luminance from a low profile flat lens
- AccuAim™ optics provide directional control for the "cone-of-light" beam distribution of a traditional downlight
- Precision molded lens features high transmission polymer with UV stabilized protecting film

Electrical Junction Box Mounting

- SLD may be used in compatible electrical junction boxes in direct contact with insulation including spray foam insulation
- Suitable for installation in many 3-1/2" and 4" square, octagon, and round electrical junction boxes

Note: Driver consumes 3 cubic inches of junction box

- Surface mounting in a fire-rated ceiling using an appropriate electrical box offers a cost-effective alternative to fire-rated recessed housings

Note: Fire-rating is per the rating of the ceiling and applicable junction box, not the SLD

- Installer must ensure compatibility of fit, wiring and proper mounting in the electrical junction box. This includes all applicable national and local electrical and building codes.
- Proprietary Slot-N-Lock quick installation system for junction box installation
- T-bracket with Slot-N-Lock mounting tabs included

Recessed Housing Mounting

- May be installed in IC recessed housings in direct contact with insulation

***Note:** Not for use in recessed housings in direct contact with spray foam insulation (Refer to NEMA LSD 57-2013)

Torsion Spring 5" & 6" Kit (Included)

- The torsion springs adjust on the frame to fit 5" or 6" compatible housings

Friction Blade 5" & 6" Kit (Included)

- For retrofit in 5" and 6" housings without torsion spring mounting tabs
- Friction blade design allows the SLD to be installed in any position within the housing aperture (360 degrees)

LED

- Linear LED arrays are integrated in trim perimeter
- Correlated Color Temperature (CCT): 2700K, 3000K, 3500K, 4000K
- Color Rendering Index (CRI): 90
- Lumens – see Energy Data
- Lumen maintenance L70 at 50,000 hours

Electrical Connections

Junction Box

- Compatible with 3-1/2" x 2" and 4" x 1-1/2" deep round, square and octagon boxes (2-1/8" deep boxes recommended)
- Supply wire adapter with LED quick connector included
- JB models for use in junction boxes. May be used in recessed housings with accessory SLD6ACCKIT.

Recessed Housings

- LED connector is a non-screw base luminaire disconnect compatible with Halo 5" H550 series and 6" H750/H2750 series LED housings
- LED connector meets California Title 24 high efficacy luminaire standard as a non-screw base
- E26 Edison screw base included

LED Driver

- Driver is a 120V input, high efficiency, dimmable electronic power supply providing DC power to the LED arrays
- Driver features high power factor, low THD, and has integral thermal protection in the event of over temperature or internal failure
- If dimming is not required the fixture can be operated from a standard wall switch

Dimming

Designed for continuous dimming capability to nominally 5% with many 120V Leading Edge (LE) and Trailing Edge (TE) phase control dimmers. Dimming to 5% is best assured using dimmers with low end trim adjustment. Consult dimmer manufacturer for compatibility and conditions of use. (Note, some dimmers require a neutral in the wallbox)

Compliance

- cULus Listed ceiling and wall
- cULus Listed damp location, ceiling and wall
- cULus Listed wet location, covered ceiling only (shower rated)
- Suitable for use in closets, compliant with NFPA® 70, NEC® Section 410.16 (A)(3) and 410.16 (C)(5)
- May be used in compatible electrical junction boxes in direct contact with insulation including spray foam insulation
- May be installed in IC recessed housings in direct contact with insulation. Not for use in recessed housings in direct contact with spray foam insulation. (Refer to NEMA LSD 57-2013)
- UL Classified when used in retrofit with listed housings (See housing compatibility)
- EMI/RFI: meets FCC 47CFR Part 15 Class B limits, and is suitable for use in residential and commercial
- Air-Tite code compliant. Certified under ASTM E283; not exceeding 2.0 cfm (0.944 L/s) air leakage rate tested at a 1.57 psf (75 Pa) pressure differential.
- 90 CRI (R9 > 50) can be used to comply with California Title 24 high efficacy requirements. Title 20 Certified for residential compliance.
- 80 CRI can be used to comply with California Title 24 non-residential lighting controls requirements as a LED luminaire
- Can be used for International Energy Conservation Code (IECC) high efficacy luminaire compliance
- ENERGY STAR® certified downlight surface retrofit
- Contains no mercury or lead and RoHS compliant
- Photometric testing in accordance with IES LM-79
- Lumen maintenance projections in accordance with IES LM-80 and TM-21

LED Surface Mount

SLD6 - Universal Voltage Series

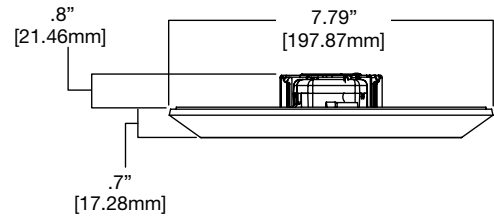

SLD612 - 1200 Series UNV, 120V-277V

5" / 6" Surface LED Retrofit Module

The Halo Surface LED Downlight (SLD) incorporates WaveStream™ technology to create an ultra-low profile surface mounting luminaire with the performance and look of a traditional downlight. SLD6-1200 UNV series is designed for installation in many 4" x 2-1/8" deep square junction boxes. Accessory mounting kit allows retrofit in 5" and 6" IC and Non-IC recessed housings.* Suitable for residential or commercial installations. Ideal for closets, storage areas, attics and basements. Compliant with NFPA® 70, NEC® Section 410.16 (A)(3) and 410.16 (C)(5).



Features

Mechanical

Die cast aluminum trim ring, and die formed aluminum frame

Optics

- WaveStream™ technology provides uniform luminance from a low profile flat lens
- AccuAim™ optics provide directional control for the "cone-of-light" beam distribution of a traditional downlight
- Precision molded lens features high transmission polymer with UV stabilized protecting film

Electrical Junction Box Mounting

- SLD may be used in compatible electrical junction boxes in direct contact with insulation including spray foam insulation
- Suitable for installation in many 4" x 2-1/8" deep square electrical junction boxes
- Compatible with other junction boxes with accessory SLD6EXT extension spacer ring

Note: Driver consumes 3 cubic inches of junction box

- Surface mounting in a fire-rated ceiling using an appropriate electrical box offers a cost-effective alternative to fire-rated recessed housings

Note: Fire-rating is per the rating of the ceiling and applicable junction box, not the SLD

- Installer must ensure compatibility of fit, wiring and proper mounting in the electrical junction box. This includes all applicable national and local electrical and building codes.
- Proprietary Slot-N-Lock quick installation system for junction box installation
- T-bracket with Slot-N-Lock mounting tabs included

Recessed Housing Mounting

- Accessory SLD6ACCKIT required for mounting in 5" and 6" enclosed recessed housings
- May be installed in IC recessed housings in direct contact with insulation

Note: Not for use in recessed housings in direct contact with spray foam insulation (Refer to NEMA LSD 57-2013)

- The SLD6 may be used with any 5 or 6 inch diameter recessed housing constructed of steel or aluminum with an internal volume that exceeds 107.9 in³

LED

- Linear LED arrays are integrated in trim perimeter
- Correlated Color Temperature (CCT): 2700K, 3000K, 3500K, 4000K
- Color Rendering Index (CRI): 90
- Lumens – see Energy Data
- Lumen maintenance L70 at 50,000 hours

Electrical Connections

Junction Box

- Compatible with 4" x 2-1/8" deep square boxes
- Supply wire adapter with LED quick connector included
- LED connector is a non-screw base luminaire disconnect

Recessed Housings

- Accessory SLD6ACCKIT required
- LED connector is compatible with Halo 5" H550 series and 6" H750, H2750 series LED housings
- LED Connector meets California Title 24 high efficacy luminaire standard as a non-screw base

LED Driver

- Driver is a 120V-277V universal voltage input, high efficiency, dimmable electronic power supply providing DC power to the LED arrays
- Driver features high power factor, low THD, and has integral thermal protection in the event of over temperature or internal failure
- Driver is replaceable if it should be required
- If dimming is not required the fixture can be operated from a standard wall switch

Dimming - Phase Control

- Designed for continuous dimming capability to nominally 5% with many 120V Leading Edge (LE) and Trailing Edge (TE) phase control dimmers. Dimmers with low end trim adjustment offer greater assurance of achieving 5% level.
- Consult dimmer manufacturer for compatibility and conditions of use. (Note some dimmers require a neutral in the wallbox)

Dimming - 0-10V

- Dimmable to 10% in typical operation with compatible 0-10V DC low voltage dimmers
- 0-10V DC dimmers operate using two low voltage dimming wires (color coded violet and gray). The low voltage dimming wires are separate from the 120V AC or 277V AC power.
- Switching on/off is via the line voltage (120V AC or 277V AC) power, and dimming is controlled via the 2-wire 0-10V DC wiring

Compliance

- cULus Listed ceiling and wall
- cULus Listed damp location, ceiling and wall
- cULus Listed wet location, covered ceiling only (shower rated)
- Suitable for use in closets, compliant with NFPA® 70, NEC® Section 410.16 (A)(3) and 410.16 (C)(5)
- SLD may be used in compatible electrical junction boxes in direct contact with insulation including spray foam insulation
- May be installed in IC recessed housings in direct contact with insulation. Not for use in recessed housings in direct contact with spray foam insulation. (Refer to NEMA LSD 57-2013)
- EMI/RFI: meets FCC 47CFR Part 15 Class B limits, and is suitable for use in residential and commercial installations
- Air-Tite code compliant. Certified under ASTM E283; not exceeding 2.0 cfm (0.944 L/s) air leakage rate tested at a 1.57 psf (75 Pa) pressure differential
- 90 CRI (R9 > 50) can be used to comply with California Title 24 high efficacy requirements. Title 20 Certified for residential compliance.
- 80 CRI can be used to comply with California Title 24 non-residential lighting controls requirements as a LED luminaire
- Can be used for International Energy Conservation Code (IECC) high efficacy luminaire compliance
- ENERGY STAR® certified downlight surface retrofit
- Contains no mercury or lead and RoHS compliant
- Photometric testing in accordance with IES LM-79
- Lumen maintenance projections in accordance with IES LM-80 and TM-21

LED Surface Mount

SLD6 - Universal Voltage Series

SLD6 600 & 1200 Series Ordering Information

Models	Color Rendering Index (CRI)	Color Temperature (CCT)	Finish	Voltage	JB Only	
Standard (Includes hardware kits for junction box and recessed housing mounting)	SLD606 = 6" Surface LED downlight, 120V, 600 series SLD612 = 6" Surface LED downlight, 120V, 1200 series	9 = 90 CRI	27 = 2700K 30 = 3000K 35 = 3500K 40 = 4000K	WH = White	120V	
"JB" Models (Includes hardware kit for junction box mounting ONLY)	SLD606 = 6" Surface LED downlight, 120V, 600 series SLD612 = 6" Surface LED downlight, 120V, 1200 series	9 = 90 CRI	27 = 2700K 30 = 3000K 35 = 3500K 40 = 4000K	WH = White	120V	JB = ONLY junction box hardware kit
"UNV" Models (120V-277V)	SLD612 = 6" Surface LED downlight, 120V-277V 1200 series	9 = 90 CRI	27 = 2700K 30 = 3000K 35 = 3500K 40 = 4000K	WH = White	UNV = Universal voltage 120V-277V (1200 series only)	JB = ONLY junction box hardware kit

Accessories (Order Separately)

Designer Trims

Fit over the SLD for a designer finish
SLD6TRMWH = 6" SLD white (paintable)
SLD6TRMSN = 6" SLD satin nickel
SLD6TRMTBZ = 6" SLD tuscan bronze
 *SLD accessory trims attach with permanent adhesion and are not interchangeable after installation



Replacement Parts Kit



SLD6ACCKIT
 SLD6 Retrofit Kit - SLD6 screw base adapter, friction blades, torsion springs, ground wire, mounting screws, wire nuts



SLD6BRKT
 SLD6 junction box mounting bracket and screws

Compatible Junction Boxes



Octagon - Steel
 4" x 4" x 2-1/8"
 4" x 4" x 1-1/2"

Round - Plastic
 4" diameter x 2-3/16"

Square - Steel**
 4" x 4" x 2-1/8"
 4" x 4" x 1-1/2"

**Universal Voltage (UNV) SLD6-1200 for use in 4" square junction boxes only

SLD6 Energy Data

600 Series	90 CRI	1200 Series	90 CRI	1200 Series	90 CRI
Nominal Lumens (4000K)	780	Nominal Lumens (4000K)	1000	Universal Voltage	90 CRI
Input Voltage	120V	Input Voltage	120V	Nominal Lumens (4000K)	1000
Frequency	50/60 Hz	Frequency	50/60 Hz	Input Voltage	120V-277V
Input Current	0.11 A	Input Current	0.12 A	Frequency	50/60 Hz
Input Power	13.2 W	Input Power	14.8 W	Input Current	0.12 A
Efficiency (4000K models)	59 lm/W	Efficiency (4000K models)	68 lm/W	Input Power	14.8 W
THD	≤ 20%	THD	≤ 20%	Efficiency (4000K models)	68 lm/W
Power Factor	≥ 0.90	Power Factor	≥ 0.90	THD	≤ 20%
T Ambient	-30 – +40°C	T Ambient	-30 – +40°C	Power Factor	≥ 0.90
Sound Rating	Class A	Sound Rating	Class A	T Ambient	-30 – +40°C
				Sound Rating	Class A

Junction Box Space Extension Ring

Adds 15/16" depth when the SLD driver cannot fit into a junction box



SLD6EXT = 6" Surface LED j-box extender, 9.5" OD

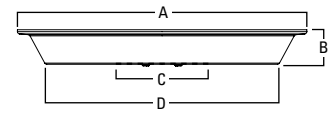

Dimensions

A: 9-1/2" [241mm]
 B: 7/8" [23.5mm]
 C: 3-7/8" [99mm]
 D: 8" [203mm]

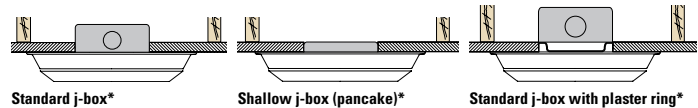

Fire Rated Install*

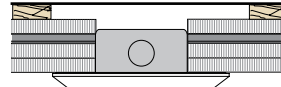

*For illustration ONLY – not for construction

Surface Box Adapter

Fits the SLD into a 4-inch round or octagon junction box mounted flat on a ceiling or beam surface (not recessed in the ceiling).
 For 4-inch square junction boxes use SLD6RAD with the SLD6SADPLT square adapter plate.

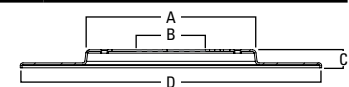

Dimensions

A: 4-1/2" [114mm]
 B: 3-3/4" [95mm]
 C: 1/2" [13mm]
 D: 7-7/8" [201mm]



SLD6SADPLT
 6" SLD square surface j-box adapter plate (use with SLD6RAD)

SLD6RAD
 6" SLD round surface j-box adapter (use SLD6SADPLT for square j-box)

LED Surface Mount

HLC4 Series

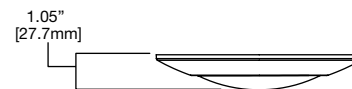
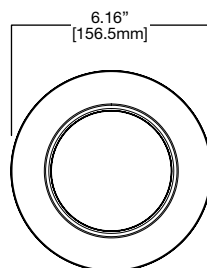

HLC4

4" Low-Profile LED Surface Mount

The Halo HLC4 is a low profile, surface mount luminaire that offers easy below the ceiling installation to save time and money. The HLC4 (4") is designed for installation in most 3-1/2" and 4" square, octagon, or round junction boxes. Supply wire adapter with LED quick wiring connector included.



Features

Construction

Stamped aluminum housing and frame

Optics

- Precision engineered optic provides uniform luminance from a low profile convex lens
- Removable lens for easy install from below installation

LED

- Backlit LED technology
- Color Temperature options include: 3000K, or 4000K
- 90 CRI is standard
- L70 at 50,000 hours projected in accordance with TM-21

Driver

- Integral 120V 60Hz constant current driver provides virtually noise free operation.
- Continuous, flicker-free dimming from 100% to 10% with select leading or trailing edge 120V phase cut dimmers. See dimming guide.
- Dimming to 10% is best assured using dimmers with low end trim adjustment. Consult dimmer manufacturer for compatibility and conditions of use. (Note some dimmers require a neutral in the wallbox.)
- Inline electrical quick connect (provided) provides mains connections

Electrical Junction Box Mounting

- HLC may be used in compatible electrical junction boxes in direct contact with insulation including spray foam insulation
- Install from below design
- Suitable for installation in many 3-1/2" and 4" octagon and round electrical junction boxes.
- Compatible with compact (pancake) junction boxes
- Installer must ensure compatibility of fit, wiring and proper mounting in the electrical junction box. This includes all applicable national and local electrical and building coded NEMA LSD 57-2013

Compliance

- UL certified for US and Canada
- Damp Location listed
- Suitable for use in clothes closets when installed in accordance with the NEC 410.16 spacing requirements.
- EMI/RFI emissions per FCC 47CFR Part 15B
- Contains no mercury or lead and RoHS compliant.
- Photometric testing in accordance with IES LM-79-08
- Lumen maintenance projections in accordance with IES LM-80-08 and TM-21-11.
- Can be used for State of California Title 24 high efficacy luminaire compliance, reference the California Energy Commission Title 20 Appliance Efficiency Database for current listings.
- Can be used for International Energy Conservation Code (IECC) and Washington State Energy Code high efficiency luminaire Compliance
- ENERGY STAR® Certified luminaire - consult ENERGY STAR® Certified Product List

HLC4 Energy Data

	90 CRI
Lumens	700
Input Voltage	120V
Input Current	0.106 A
Input Power	12.6 W
Efficiency	60 (LPW)
THD	≤ 20%
Power Factor	≥ 0.90
T Ambient	-40 - +40°C
Sound Rating	≤ 20 dba

HLC4 Series Ordering Information

Models	Lumens	Color Rendering Index (CRI)	Voltage	Finish	Packaging
HLC4 = 4" LED surface light	07 = 700 lumen series	930 = 90 CRI minimum, 3000K CCT 940 = 90 CRI minimum, 4000K CCT	1E = 120V 60Hz, LE & TE phase cut dimming	WH = Matte white baffle	-6BP = 6 bulk pack (not for individual resale) -12BP = 12 bulk pack (not for individual resale)

LED Surface Mount

HLC6 Series

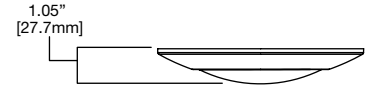
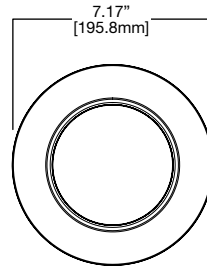

HLC6

6" Low-Profile LED Surface Mount

The Halo HLC6 is a low profile, surface mount luminaire that offers easy below the ceiling installation to save time and money. The HLC6 (6") is designed for installation in most 3-1/2" and 4" square, octagon, or round junction boxes. Supply wire adapter with LED quick wiring connector included.



Features

Construction

Stamped aluminum housing and frame

Optics

- Precision engineered optic provides uniform luminance from a low profile convex lens
- Removable lens for easy install from below installation

LED

- Backlit LED technology
- Color Temperature options include: 3000K, or 4000K
- 90 CRI is standard
- L70 at 50,000 hours projected in accordance with TM-21

Driver

- Integral 120V 60Hz constant current driver provides virtually noise free operation.
- Continuous, flicker-free dimming from 100% to 10% with select leading or trailing edge 120V phase cut dimmers. See dimming guide.
- Dimming to 10% is best assured using dimmers with low end trim adjustment. Consult dimmer manufacturer for compatibility and conditions of use. (Note some dimmers require a neutral in the wallbox.)
- Inline electrical quick connect (provided) provides mains connections

Electrical Junction Box Mounting

- HLC may be used in compatible electrical junction boxes in direct contact with insulation including spray foam insulation
- Install from below design
- Suitable for installation in many 3-1/2" and 4" octagon and round electrical junction boxes.
- Compatible with compact (pancake) junction boxes
- Installer must ensure compatibility of fit, wiring and proper mounting in the electrical junction box. This includes all applicable national and local electrical and building coded NEMA LSD 57-2013

Compliance

- UL certified for US and Canada
- Damp Location listed
- Suitable for use in clothes closets when installed in accordance with the NEC 410.16 spacing requirements.
- EMI/RFI emissions per FCC 47CFR Part 15B
- Contains no mercury or lead and RoHS compliant.
- Photometric testing in accordance with IES LM-79-08
- Lumen maintenance projections in accordance with IES LM-80-08 and TM-21-11.
- Can be used for State of California Title 24 high efficacy luminaire compliance, reference the California Energy Commission Title 20 Appliance Efficiency Database for current listings.
- Can be used for International Energy Conservation Code (IECC) and Washington State Energy Code high efficiency luminaire Compliance
- ENERGY STAR® Certified luminaire - consult ENERGY STAR® Certified Product List

HLC6 Energy Data

	90 CRI
Lumens	900
Input Voltage	120V
Input Current	0.133 A
Input Power	15.7 W
Efficiency	58.8 (LPW)
THD	≤ 20%
Power Factor	≥ 0.90
T Ambient	-40 - +40°C
Sound Rating	≤ 20 dba

HLC6 Series Ordering Information

Models	Lumens	Color Rendering Index (CRI)	Voltage	Finish	Packaging
HLC6 = 6" LED surface light	09 = 900 lumen series	930 = 90 CRI minimum, 3000K CCT 940 = 90 CRI minimum, 4000K CCT	1E = 120V 60Hz, LE & TE phase cut dimming	WH = Matte white baffle	-6BP = 6 bulk pack (not for individual resale) -12BP = 12 bulk pack (not for individual resale)



3 INCH

H3 Series

IC Housings	144
IC Trims	148
Non-IC Housings	152
Non-IC Trims	159

IC = Insulated Ceiling Non-IC = Non-Insulated Ceiling

3
INCH

H3 Series – GU10 IC Housing

H36ICAT



H36ICAT

3" IC, Air-Tite, Shallow New Construction, 120V

H36ICAT is a shallow IC, Air-Tite™ housing for use with H3 3" series trims. Housing is Air-Tite to restrict airflow between conditioned spaces and unconditioned areas. For use with 120V GU10 lamps. H36ICAT is IC rated and may be used in insulated ceilings and may be covered with insulation*.

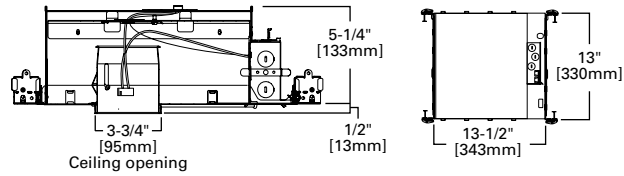

Special Features

- Air-Tite™ code compliant
- Got Nail™ bar hangers
- Slide-N-Side™ junction box
- Pass-N-Thru™ bars
- Quick Connect™ push wire nuts

Compatible Trims

3001	3004	3008	3011	3017
3002	3006	3009	3012	3020
3003	3007	3010	3013	

Features

Housing

Double wall aluminum construction, shallow height

Plaster Frame

Housing adjusts in plaster frame to accommodate up to 1-1/2" ceiling thickness. Galvanized steel construction. Plaster frame features include:

- Regressed locking screw for securing hanger bars
- Cutouts for easily crimping hanger bars in position
- HALO name embossed on plaster frame
- The housing may be removed from plaster frame to provide access to the junction box
- Pre-installed Air-Tite gasket

Includes:

- Air-Tite™ code compliant (Details Pg. 11)
- Got Nail™ bar hangers (Details Pg. 11)
- Slide-N-Side™ junction box wire traps (Details Pg. 11)
- Pass-N-Thru™ bars (Details Pg. 11)
- Quick Connect™ push wire nuts (Details Pg. 11)

Socket

GU10 socket for 120V GU10 lamps

Accessory

Z28 Lamp: 120V, GU10, reflector lamp

Compliances

- cULus Listed 1598 luminaire
- cULus Listed damp location
- cULus Listed for wet location, covered ceiling, with select trims
- cULus Listed for direct contact with insulation and combustible material*
- Air-Tite code compliant. Certified under ASTM E283; not exceeding 2.0 cfm (0.944 L/s) air leakage rate tested at a 1.57 psf (75 Pa) pressure differential
- RoHS compliant

*Not to be used in direct contact with spray foam insulation (Consult NEMA LSD57-2013)

H3 Series – GU10 IC Housing

H38ICAT

3
INCH



H38ICAT

3" IC, Air-Tite, New Construction, 120V

H38ICAT is an IC, Air-Tite™ housing for use with H3 3" series trims. Housing is Air-Tite to restrict airflow between conditioned spaces and unconditioned areas. For use with 120V GU10 lamps. H38ICAT is IC rated and may be used in insulated ceilings and may be covered with insulation*.

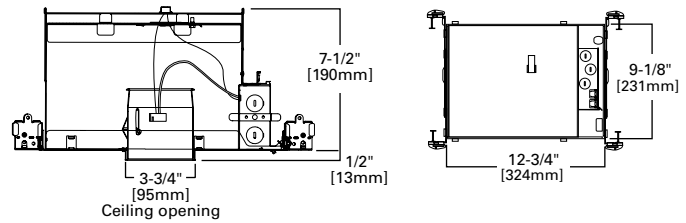

Special Features

Air-Tite™ code compliant
 Got Nail!™ bar hangers
 Slide-N-Side™ junction box
 Pass-N-Thru™ bars
 Quick Connect™ push wire nuts

Compatible Trims

3001	3005	3009	3013	3018
3002	3006	3010	3014	3019
3003	3007	3011	3016	3020
3004	3008	3012	3017	

Features

Housing

Double wall aluminum construction

Plaster Frame

Housing adjusts in plaster frame to accommodate up to 1-1/2" ceiling thickness. Galvanized steel construction. Plaster frame features include:

- Regressed locking screw for securing hanger bars
- Cutouts for easily crimping hanger bars in position
- HALO name embossed on plaster frame
- The housing may be removed from plaster frame to provide access to the junction box
- Pre-installed Air-Tite gasket

Includes:

- Air-Tite™ code compliant (Details Pg. 11)
- Got Nail!™ bar hangers (Details Pg. 11)
- Slide-N-Side™ junction box wire traps (Details Pg. 11)
- Pass-N-Thru™ bars (Details Pg. 11)
- Quick Connect™ push wire nuts (Details Pg. 11)

Socket

GU10 socket for 120V GU10 lamps

Accessory

Z28 Lamp: 120V, GU10, reflector lamp

Compliances

- cULus Listed 1598 luminaire
- cULus Listed damp location
- cULus Listed for wet location, covered ceiling, with select trims
- cULus Listed for direct contact with insulation and combustible material*
- Air-Tite code compliant. Certified under ASTM E283; not exceeding 2.0 cfm (0.944 L/s) air leakage rate tested at a 1.57 psf (75 Pa) pressure differential
- RoHS compliant

*Not to be used in direct contact with spray foam insulation (Consult NEMA LSD57-2013)

3
INCH

H3 Series – Low Voltage MR16 IC Housing

H36LVICAT

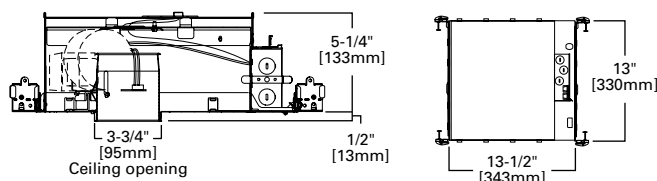

H36LVICAT



3" IC, Air-Tite, Shallow New Construction, 120V – 12V Low Voltage, MR16

H36LVICAT is a shallow IC, Air-Tite™ housing for use with H3 3" series trims. Housing is Air-Tite to restrict airflow between conditioned spaces and unconditioned areas. For use with 12V MR16 lamps. H36LVICAT is IC rated and may be used in insulated ceilings and may be covered with insulation*.

Special Features

- Air-Tite™ code compliant
- Got Nail!™ bar hangers
- Slide-N-Side™ junction box
- Pass-N-Thru™ bars
- Quick Connect™ push wire nuts

Compatible Trims

3001	3004	3008	3011	3017
3002	3006	3009	3012	3020
3003	3007	3010	3013	

Features

Housing

IC and Air-Tite™ rated double wall aluminum construction shallow height

Plaster Frame

Housing adjusts in plaster frame to accommodate up to 1-1/2" ceiling thickness. Galvanized steel construction. Plaster frame features include:

- Regressed locking screw for securing hanger bars
- Cutouts for easily crimping hanger bars in position
- HALO name embossed on plaster frame
- The housing may be removed from plaster frame to provide access to the junction box
- Pre-installed Air-Tite gasket

Includes:

- Air-Tite™ code compliant (Details Pg. 11)
- Got Nail!™ bar hangers (Details Pg. 11)
- Slide-N-Side™ junction box wire traps (Details Pg. 11)
- Pass-N-Thru™ bars (Details Pg. 11)
- Quick Connect™ push wire nuts (Details Pg. 11)

Transformer

Integral magnetic transformer steps 120V line voltage down to 12V lamp operating voltage. Rated for MR16 lamps, 50W max.

Socket

GU 5.3 socket for 12V MR16 lamps

Compliances

- cULus Listed 1598 luminaire
- cULus Listed damp location
- cULus Listed for wet location, covered ceiling, with select trims
- cULus Listed for direct contact with insulation and combustible material*
- Air-Tite code compliant. Certified under ASTM E283; not exceeding 2.0 cfm (0.944 L/s) air leakage rate tested at a 1.57 psf (75 Pa) pressure differential
- RoHS compliant

*Not to be used in direct contact with spray foam insulation (Consult NEMA LSD57-2013)

H3 Series – Low Voltage MR16 IC Housing

H38LVICAT

3
INCH

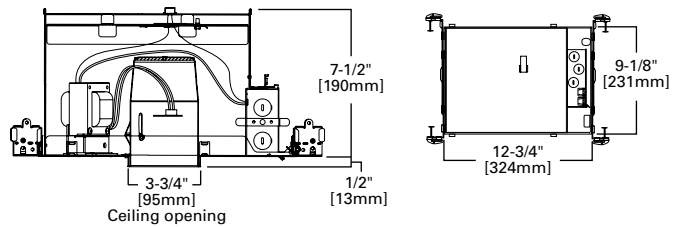

H38LVICAT

3" IC, Air-Tite, New Construction, 120V – 12V Low Voltage, MR16

H38LVICAT is an IC, Air-Tite™ housing for use with H3 3" series trims. Housing is Air-Tite to restrict airflow between conditioned spaces and unconditioned areas. For use with 12V MR16 lamps. H38LVICAT is IC rated and may be used in insulated ceilings and may be covered with insulation*.



Special Features

Air-Tite™ code compliant
 Got Nail!™ bar hangers
 Slide-N-Side™ junction box
 Pass-N-Thru™ bars
 Quick Connect™ push wire nuts

Compatible Trims

3001	3004	3008	3011	3017
3002	3006	3009	3012	3020
3003	3007	3010	3013	

Features

Housing

IC and Air-Tite™ rated double wall aluminum construction shallow height

Plaster Frame

Housing adjusts in plaster frame to accommodate up to 1-1/2" ceiling thickness. Galvanized steel construction. Plaster frame features include:

- Regressed locking screw for securing hanger bars
- Cutouts for easily crimping hanger bars in position
- HALO name embossed on plaster frame
- The housing may be removed from plaster frame to provide access to the junction box
- Pre-installed Air-Tite gasket

Includes:

- Air-Tite™ code compliant (Details Pg. 11)
- Got Nail!™ bar hangers (Details Pg. 11)
- Slide-N-Side™ junction box wire traps (Details Pg. 11)
- Pass-N-Thru™ bars (Details Pg. 11)
- Quick Connect™ push wire nuts (Details Pg. 11)

Transformer

Integral magnetic transformer steps 120V line voltage down to 12V lamp operating voltage. Rated for MR16 lamps, 50W max.

Socket

GU 5.3 socket for 12V MR16 lamps

Compliances

- cULus Listed 1598 luminaire
- cULus Listed damp location
- cULus Listed for wet location, covered ceiling, with select trims
- cULus Listed for direct contact with insulation and combustible material*
- Air-Tite code compliant. Certified under ASTM E283; not exceeding 2.0 cfm (0.944 L/s) air leakage rate tested at a 1.57 psf (75 Pa) pressure differential
- RoHS compliant

*Not to be used in direct contact with spray foam insulation (Consult NEMA LSD57-2013)

Reflectors

3004 Adjustable Reflector

- Die cast trim ring with reflector
- For general illumination
- 35° tilt, 360° orientation within housing

Lamp	120V GU10 50W	12V MR16 50W
Housing	H36ICAT H38ICAT	H36LVICAT H38LVICAT



3004WHW
White Reflector, White Trim



3004WHC
Clear Reflector, White Trim



3004WHH
Haze Reflector, White Trim



3004SN
Satin Nickel Reflector,
Satin Nickel Trim



3004TBZ
Tuscan Bronze Reflector,
Tuscan Bronze Trim

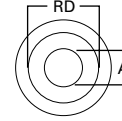
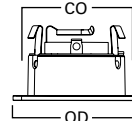

Dimensions**
A: 2" [51mm]
RD: 3" [75mm]
CO: 3-3/4" [95mm]
OD: 4-1/4" [108mm]

Baffles

3003 Adjustable Coilex® Baffle

- Die cast trim ring with machined metal Coilex baffle
- For general illumination
- 35° tilt, 360° orientation within housing

Lamp	120V GU10 50W	12V MR16 50W
Housing	H36ICAT H38ICAT	H36LVICAT H38LVICAT



3003WHWB
White Coilex Baffle, White Trim



3003WHBB
Black Coilex Baffle, White Trim



3003BKBB
Black Coilex Baffle, Black Trim



3003SNB
Satin Nickel Coilex Baffle,
Satin Nickel Trim



3003TBZB
Tuscan Bronze Coilex Baffle,
Tuscan Bronze Trim

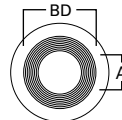
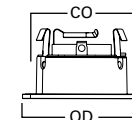

Dimensions**
A: 2" [51mm]
BD: 3" [75mm]
CO: 3-3/4" [95mm]
OD: 4-1/4" [108mm]

3011 Square Adjustable Baffle

- Die cast trim ring with metal baffle
- For general illumination
- 15° tilt, 350° integral lamp holder rotation with locking thumbscrew

Lamp	120V GU10 50W	12V MR16 50W
Housing	H36ICAT H38ICAT	H36LVICAT



3011WHWB
White Baffle, White Trim



3011WHBB
Black Baffle, White Trim



3011BKBB
Black Baffle, Black Trim



3011SNBB
Black Baffle, Satin Nickel Trim



3011TBZBB
Black Baffle, Tuscan Bronze Trim

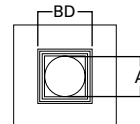
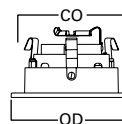

Dimensions**
A: 1-7/8" [48mm]
BD: 2-1/4" [57mm]
CO (Round): 3-3/4" [95mm]
OD: 4-1/4" [108mm]

**Key: A: Luminous Aperture, RD/BD: Reflector/Baffle Diameter, CO: Ceiling Opening, OD: Trim Outside Diameter

H3 Series Trims

IC Housings: H36ICAT • H38ICAT • H36LVICAT • H38LVICAT

3
INCH

Adjustable – Eyeballs & Gimbals

3009 Adjustable Gimbal - 35° Tilt

- Die cast trim ring with die cast gimbal
- For directional accent lighting
- 35° tilt, 15° negative tilt, 360° gimbal orientation and trim within housing

Lamp	120V GU10 50W	12V MR16 50W
Housing	H36ICAT H38ICAT	H36LVICAT H38LVICAT



3009WHWB
White Baffle, White Gimbal



3009WHBB
Black Baffle, White Gimbal



3009BKBB
Black Baffle, Black Gimbal



3009SNBB
Black Baffle, Satin Nickel Gimbal



3009TBZBB
Black Baffle, Tuscan Bronze Gimbal

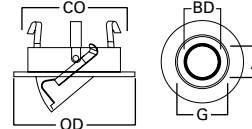

Dimensions**
 A: 1-3/4" [45mm]
 BD: 2" [51mm]
 G: 2-3/4" [70mm]
 CO: 3-3/4" [95mm]
 OD: 4-1/4" [108mm]

3010 Super Adjustable - 0-75° Adjustment

- Die cast trim ring and adjustable lamp sleeve
- For directional accent lighting
- Integral nylon ball bearings and silicone guides protect finish
- 0-75° tilt, 360° orientation within housing
- Front-loading, turn-lock lamp access

Lamp	120V GU10 50W	12V MR16 50W
Housing	H36ICAT H38ICAT	H36LVICAT



3010WH
White Baffle, White Trim



3010SN
Satin Nickel Baffle,
Satin Nickel Trim

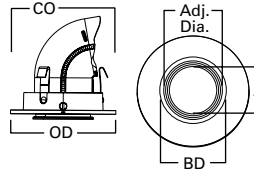

Dimensions**
 A: 1-3/4" [45mm]
 Adj. Dia.: 2-3/8" [60mm]
 BD: 2-1/2" [64mm]
 CO: 3-3/4" [95mm]
 OD: 4-1/4" [108mm]

Pull Down / Adjustment



3013 Square Adjustable Gimbal

- Die cast trim ring with die cast gimbal
- For accent and task lighting
- 35° positive tilt, 15° negative tilt, 360° orientation within housing
- Front-loading, snap-in lamp access face plate

Lamp	120V GU10 50W	12V MR16 50W
Housing	H36ICAT H38ICAT	H36LVICAT



3013WH
White



3013SN
Satin Nickel



3013TBZ
Tuscan Bronze



3013BK
Black

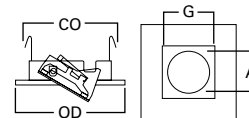

Dimensions**
 A: 1-3/4" [45mm]
 G: 2-1/4" [57mm]
 CO (Round): 3-3/4" [95mm]
 OD (Square): 4-1/4" [108mm]

**Key: A: Luminous Aperture, RD/BD: Reflector/Baffle Diameter, CO: Ceiling Opening, OD: Trim Outside Diameter, G: Gimbal Outside Diameter

Lenses & Wet Location Showerlights

3007 Regressed Lens Adjustable Reflector



- Die cast trim ring: TBZ models
- Non-conductive & non-corrosive polymer trim ring: WHC, PCC, SN models
- Regressed clear lens
- For general illumination
- Wet location listed for showers
- 15° tilt, 360° orientation within housing



3007WHC
Specular Clear Reflector,
White Trim



3007PCC
Specular Clear Reflector,
Polished Chrome Trim



3007SN
Satin Nickel Reflector,
Satin Nickel Trim



3007TBZ
Tuscan Bronze Reflector,
Tuscan Bronze Trim

Lamp 120V GU10 50W 12V MR16 50W

Housing H36ICAT H36LVICAT
H38ICAT

Lamp 12V MR16 37W

Housing H38LVICAT

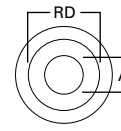
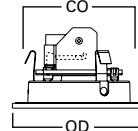

Dimensions**

A: 2" [51mm]
RD: 3" [75mm]
CO: 3-3/4" [95mm]
OD: 4-1/4" [108mm]

3008 Frosted Glass Perimeter Lens



- Non-conductive & non-corrosive polymer trim ring
- Glass lens with frosted perimeter
- Clear specular upper reflector
- Wet location listed for showers, "Dead-Front"
- 360° orientation within housing



3008FG
Frosted Glass Perimeter Lens,
White Trim

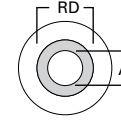
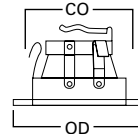

Dimensions**

A: 1-7/8" [48mm]
RD: 2-9/16" [65mm]
CO: 3-3/4" [95mm]
OD: 4-1/4" [108mm]

Lamp 120V GU10 50W 12V MR16 50W

Housing H36ICAT H36LVICAT
H38ICAT

Lamp 12V MR16 37W

Housing H38LVICAT

3012 Square Regressed Lens Adjustable Baffle



- Die cast trim ring with metal baffle
- For general illumination
- 15° tilt, 360° integral lamp holder rotation with locking thumbscrew
- Wet location listed for showers



3012WHWB
White Baffle, White Trim



3012WHBB
Black Baffle, White Trim



3012BKBB
Black Baffle, Black Trim



3012SNBB
Black Baffle, Satin Nickel Trim

Lamp 120V GU10 50W 12V MR16 50W

Housing H36ICAT H36LVICAT
H38ICAT

Lamp 12V MR16 37W

Housing H38LVICAT



3012TBZBB
Black Baffle, Tuscan Bronze Trim

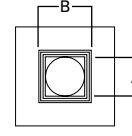
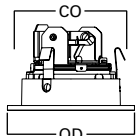

Dimensions**

A: 1-7/8" [48mm]
BD: 2-1/4" [57mm]
CO (Round): 3-3/4" [95mm]
OD: 4-1/4" [108mm]

3017 Decorative Low-Profile Glass Curve



- Die cast construction and decorative glass element
- Frost glass perimeter with clear glass center
- Wet location listed for showers



3017FGS
Frost Glass Curve

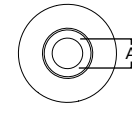
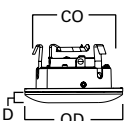

Dimensions**

A: 1-1/2" [39mm]
D: 1/2" [13mm]
CO: 3-3/4" [95mm]
OD: 4-1/4" [108mm]

Lamp 120V GU10 50W 12V MR16 50W

Housing H36ICAT H36LVICAT
H38ICAT

Lamp 12V MR16 37W

Housing H38LVICAT

**Key: A: Luminous Aperture, RD/BD: Reflector/Baffle Diameter, CO: Ceiling Opening, OD: Trim Outside Diameter, D: Depth Profile

H3 Series Trims

IC Housings: H36ICAT • H38ICAT • H36LVICAT • H38LVICAT

3
INCH

Pinhole, Slot & Wall Wash

3001 Adjustable Pinhole Baffle

- Die cast trim ring with black oculus and machined metal baffle
- For concentrated accent lighting
- 15° tilt, 360° orientation within housing

Lamp	120V GU10 50W	12V MR16 50W
Housing	H36ICAT H38ICAT	H36LVICAT



3001WHWB
White Baffle, White Trim



3001WHBB
Black Baffle, White Trim



3001SNBB
Black Baffle, Satin Nickel Trim



3001BKBB
Black Baffle, Black Trim

Lamp	12V MR16 37W
Housing	H38LVICAT



3001TBZBB
Black Baffle, Tuscan Bronze Trim

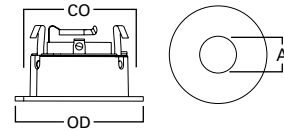

Dimensions**
A: 1-5/8" [41mm],
CO: 3-3/4" [95mm],
OD: 4-1/4" [108mm]

3002 Adjustable Pinhole Reflector

- Die cast trim ring with black oculus and clear specular reflector
- For concentrated accent lighting
- 15° tilt, 360° orientation within housing

Lamp	120V GU10 50W	12V MR16 50W
Housing	H36ICAT H38ICAT	H36LVICAT



3002WHC
Clear Reflector, White Trim

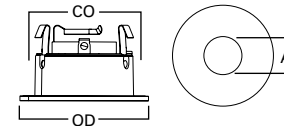

Dimensions**
A: 1-5/8" [41mm],
CO: 3-3/4" [95mm],
OD: 4-1/4" [108mm]

Lamp	12V MR16 37W
Housing	H38LVICAT

3006 Adjustable Slot Aperture

- Die cast trim ring with metal black baffle
- For directional illumination
- 35° tilt, 360° orientation within housing

Lamp	120V GU10 50W	12V MR16 50W
Housing	H36ICAT H38ICAT	H36LVICAT



3006WHBB
Black Baffle, White Trim



3006SNBB
Black Baffle, Satin Nickel Trim



3006BKBB
Black Baffle, Black Trim



3006TBZBB
Black Baffle, Tuscan Bronze Trim

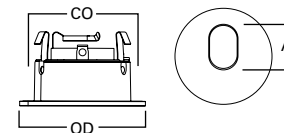

Dimensions**
A: 1-5/8" [41mm]
CO: 3-3/4" [95mm]
OD: 4-1/4" [108mm]

Lamp	12V MR16 37W
Housing	H38LVICAT

3020 Wall Wash Downlight

- Die cast trim ring
- Integral wall wash reflector
- 360° orientation within housing
- For a subtle grazing light effect on cabinet faces along with a direct downlight on counter tops or similar applications

Lamp	120V GU10 50W	12V MR16 50W
Housing	H36ICAT H38ICAT	H36LVICAT



3020WW
Wall Wash Downlight with White Trim Ring

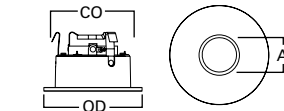

Dimensions**
A: 1-9/16" [40mm]
CO: 3-3/4" [95mm]
OD: 4-1/4" [108mm]

Lamp	12V MR16 37W
Housing	H38LVICAT

**Key: A: Luminous Aperture, CO: Ceiling Opening, OD: Trim Outside Diameter

Specifications, compliances and dimensions subject to change without notice

3
INCH

H3 Series – GU10 Non-IC Housing

H36TAT

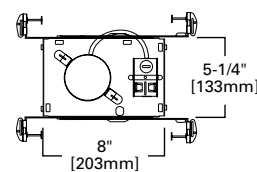
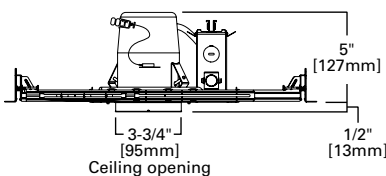

H36TAT

3" Non-IC, Air-Tite, Shallow New Construction, 120V

H36TAT is a Non-IC, Air-Tite™ housing for use with H3 3" series trims. Housing is Air-Tite to restrict airflow between conditioned spaces and unconditioned areas. For use with 120V GU10 lamps. Non-IC housing is Air-Tite™ but insulation must be kept 3 inches away from all sides of housing.



Special Features

- Air-Tite™ code compliant
- Got Nail!™ bar hangers
- Slide-N-Side™ junction box
- Pass-N-Thru™ bars
- Quick Connect™ push wire nuts

Compatible Trims

3001	3004	3008	3011	3017
3002	3006	3009	3012	3020
3003	3007	3010	3013	

Features

Housing

Formed of CRS with white powder coat finish

Plaster Frame

Housing adjusts in plaster frame to accommodate up to 1-1/2" ceiling thickness. Galvanized steel construction.

Plaster frame features include:

- Regressed locking screw for securing hanger bars
- Cutouts for easily crimping hanger bars in position
- HALO name embossed on plaster frame
- The housing may be removed from plaster frame to provide access to the junction box
- Pre-installed Air-Tite gasket

Includes:

- Air-Tite™ code compliant (Details Pg. 11)
- Got Nail!™ bar hangers (Details Pg. 11)
- Slide-N-Side™ junction box wire traps (Details Pg. 11)
- Pass-N-Thru™ bars (Details Pg. 11)
- Quick Connect™ push wire nuts (Details Pg. 11)

Socket

GU10 socket for 120V GU10 lamps

Accessory

Z28 Lamp: 120V, GU10, reflector lamp

Compliances

- cULus Listed 1598 luminaire
- cULus Listed damp location
- cULus Listed for wet location, covered ceiling, with select trims
- Air-Tite code compliant. Certified under ASTM E283; not exceeding 2.0 cfm (0.944 L/s) air leakage rate tested at a 1.57 psf (75 Pa) pressure differential
- RoHS compliant

H3 Series – GU10 Non-IC Housing

H36RTAT

3
INCH



H36RTAT

3" Non-IC, Air-Tite, Shallow Remodel, 120V

H36RTAT is a Non-IC, Air-Tite™ remodel housing for use with H3 3" series trims. For installation from below the ceiling. Housing is Air-Tite to restrict airflow between conditioned spaces and unconditioned areas. For use with 120V GU10 lamps. Non-IC housing is Air-Tite™ but insulation must be kept 3 inches away from all sides of housing.

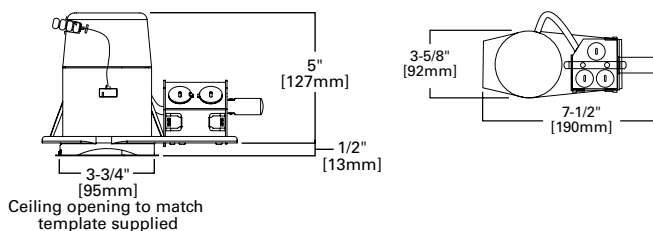

Special Features

- Air-Tite™ code compliant
- Quick Connect™ push wire nuts

Compatible Trims

3001	3004	3008	3011	3017
3002	3006	3009	3012	3020
3003	3007	3010	3013	

Features

Housing

Formed of CRS with white powder coat finish

Remodel Plaster Frame

"Easy clip" provided to secure plaster frame in ceiling while installation is being completed. Adjustable cam-locks provide positive lock of housing to plaster frame to complete housing installation.

Includes:

- Air-Tite™ code compliant (Details Pg. 11)
- Quick Connect™ push wire nuts (Details Pg. 11)

Socket

GU10 socket for 120V GU10 lamps

Accessory

Z28 Lamp: 120V, GU10, reflector lamp

Compliances

- cULus Listed 1598 luminaire
- cULus Listed damp location
- cULus Listed for wet location, covered ceiling, with select trims
- Air-Tite code compliant. Certified under ASTM E283; not exceeding 2.0 cfm (0.944 L/s) air leakage rate tested at a 1.57 psf (75 Pa) pressure differential
- RoHS compliant

Remodel Housing Installation



Cut hole in ceiling using template supplied



Bring power to fixture using non metallic sheathed cable or flexible metal cable (per local code)



The Slide-N-Side™ wire trap lets you make all wiring connections outside the junction box



Slide cable into Slide-N-Side™ wire trap and close junction box cover



Insert plaster frame into ceiling opening



Support clip keeps plaster frame in place during rest of installation



Insert housing into position and align slots in housing wall with indicator label on inside of plaster frame opening (bottom of cam lock spring blades should be positioned on flat area of the plaster frame). Then secure in position with cam locks.



Install lamp and insert trim to complete installation

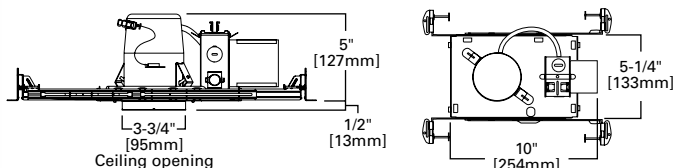

H36LVTAT

3" Non-IC, Air-Tite, Shallow New Construction, 120V – 12V Low Voltage, MR16

H36LVTAT is a Non-IC, Air-Tite™ housing for use with H3 3" series trims. Housing is Air-Tite to restrict airflow between conditioned spaces and unconditioned areas. For use with 12V MR16 lamps. Non-IC housing is Air-Tite™ but insulation must be kept 3 inches away from all sides of housing.



Special Features

- Air-Tite™ code compliant
- Got Nail™ bar hangers
- Slide-N-Side™ junction box
- Pass-N-Thru™ bars
- Quick Connect™ push wire nuts

Compatible Trims

3001	3004	3008	3011	3017
3002	3006	3009	3012	3020
3003	3007	3010	3013	

Features

Housing

Formed of CRS with white powder coat finish

Plaster Frame

Housing adjusts in plaster frame to accommodate up to 1-1/2" ceiling thickness. Galvanized steel construction. Plaster frame features include:

- Regressed locking screw for securing hanger bars
- Cutouts for easily crimping hanger bars in position
- HALO name embossed on plaster frame
- The housing may be removed from plaster frame to provide access to the junction box
- Pre-installed Air-Tite gasket

Includes:

- Air-Tite™ code compliant (Details Pg. 11)
- Got Nail™ bar hangers (Details Pg. 11)
- Slide-N-Side™ junction box wire traps (Details Pg. 11)
- Pass-N-Thru™ bars (Details Pg. 11)
- Quick Connect™ push wire nuts (Details Pg. 11)

Transformer

Integral magnetic transformer steps 120V line voltage down to 12V lamp operating voltage. Rated for MR16 lamps, 50W max.

Socket

GU5.3 socket for 12V MR16 lamps

Compliances

- cULus Listed 1598 luminaire
- cULus Listed damp location
- cULus Listed for wet location, covered ceiling, with select trims
- Air-Tite code compliant. Certified under ASTM E283; not exceeding 2.0 cfm (0.944 L/s) air leakage rate tested at a 1.57 psf (75 Pa) pressure differential
- RoHS compliant

H3 Series – Low Voltage MR16 Non-IC Housing

H36LVTATCP

3
INCH

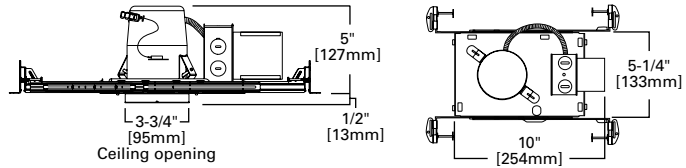

H36LVTATCP

3" Non-IC, Air-Tite, Shallow New Construction, Chicago Plenum, 120V – 12V Low Voltage, MR16

H36LVTATCP is a Non-IC, Air-Tite, housing designed for non-insulated Chicago Plenum ceilings. For use with 12V MR16 lamps. Non-IC housing requires insulation must be kept 3 inches away from all sides of housing.



Special Features

- Air-Tite™ code compliant
- Got Nail!™ bar hangers
- Pass-N-Thru™ bars
- Quick Connect™ push wire nuts
- Chicago Plenum

Compatible Trims

3001	3004	3008	3011	3017
3002	3006	3009	3012	3020
3003	3007	3010	3013	

Features

Housing

Formed of CRS with white powder coat finish

Plaster Frame

Housing adjusts in plaster frame to accommodate up to 1-1/2" ceiling thickness. Galvanized steel construction. Plaster frame features include:

- Regressed locking screw for securing hanger bars
- Cutouts for easily crimping hanger bars in position
- HALO name embossed on plaster frame
- The housing may be removed from plaster frame to provide access to the junction box
- Pre-installed Air-Tite gasket

Includes:

- Air-Tite™ code compliant (Details Pg. 11)
- Got Nail!™ bar hangers (Details Pg. 11)
- Pass-N-Thru™ bars (Details Pg. 11)
- Quick Connect™ push wire nuts (Details Pg. 11)
- Chicago Plenum

Transformer

Integral magnetic transformer steps 120V line voltage down to 12V lamp operating voltage. Rated for MR16 lamps, 50W max.

Socket

GU5.3 socket for 12V MR16 lamps

Compliances

- cULus Listed 1598 luminaire
- cULus Listed damp location
- cULus Listed for wet location, covered ceiling, with select trims
- Air-Tite code compliant. Certified under ASTM E283; not exceeding 2.0 cfm (0.944 L/s) air leakage rate tested at a 1.57 psf (75 Pa) pressure differential
- RoHS compliant
- City of Chicago Plenum

3 INCH

H3 Series – Low Voltage MR16 Non-IC Housing

H36LVRTAT

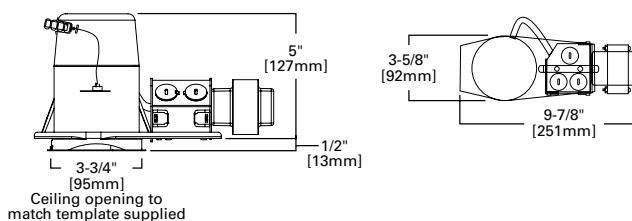

H36LVRTAT

3" Non-IC, Air-Tite, Shallow Remodel, 120V – 12V Low Voltage, MR16

H36LVRTAT is a Non-IC, Air-Tite™ remodel housing for use with H3 3" series trims. For installation from below the ceiling. Housing is Air-Tite to restrict airflow between conditioned spaces and unconditioned areas. For use with 12V MR16 lamps. Non-IC housing is Air-Tite™ but insulation must be kept 3 inches away from all sides of housing.



Special Features

- Air-Tite™ code compliant
- Quick Connect™ push wire nuts

Compatible Trims

3001	3004	3008	3011	3017
3002	3006	3009	3012	3020
3003	3007	3010	3013	

Features

Housing

Formed of CRS with white powder coat finish

Remodel Plaster Frame

"Easy clip" provided to secure plaster frame in ceiling while installation is being completed. Adjustable cam-locks provide positive lock of housing to plaster frame to complete housing installation.

Includes:

- Air-Tite™ code compliant (Details Pg. 11)
- Quick Connect™ push wire nuts (Details Pg. 11)

Transformer

Integral magnetic transformer steps 120V line voltage down to 12V lamp operating voltage. Rated for MR16 lamps, 50W max.

Socket

GU5.3 socket for 12V MR16 lamps

Compliances

- cULus Listed 1598 luminaire
- cULus Listed damp location
- cULus Listed for wet location, covered ceiling, with select trims
- Air-Tite code compliant. Certified under ASTM E283; not exceeding 2.0 cfm (0.944 L/s) air leakage rate tested at a 1.57 psf (75 Pa) pressure differential
- RoHS compliant

Remodel Housing Installation



Cut hole in ceiling using template supplied



Bring power to fixture using non metallic sheathed cable or flexible metal cable (per local code)



The Slide-N-Side™ wire trap lets you make all wiring connections outside the junction box



Slide cable into Slide-N-Side™ wire trap and close junction box cover



Insert plaster frame into ceiling opening



Support clip keeps plaster frame in place during rest of installation



Insert housing into position and align slots in housing wall with indicator label on inside of plaster frame opening (bottom of cam lock spring blades should be positioned on flat area of the plaster frame). Then secure in position with cam locks.



Install lamp and insert trim to complete installation

H3 Series – Low Voltage MR16 Non-IC Housing

H36LVTAT277

3
INCH

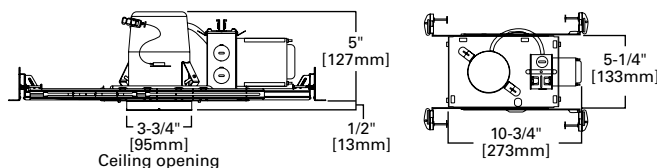

H36LVTAT277

3" Non-IC, Air-Tite, Shallow New Construction, 120/277V – 12V Low Voltage, MR16

H36LVTAT277 is a Non-IC, Air-Tite™ housing for use with H3 3" series trims. Housing is Air-Tite to restrict airflow between conditioned spaces and unconditioned areas. For use with 12V MR16 lamps. H36LVTAT277 features integral 120/277 dual-tap transformer. For use with 12V MR16 lamps. Designed for installation in 120 or 277V electrical systems.

Non-IC housing is Air-Tite™ but insulation must be kept 3 inches away from all sides of housing.



Special Features

Air-Tite™ code compliant
 Got Nail!™ bar hangers
 Slide-N-Side™ junction box
 Pass-N-Thru™ bars
 Quick Connect™ push wire nuts

Compatible Trims

3001	3004	3008	3011	3017
3002	3006	3009	3012	3020
3003	3007	3010	3013	

Features

Housing

Formed of 20 gauge CRS with white powder coat finish

Plaster Frame

Housing adjusts in plaster frame to accommodate up to 1-1/2" ceiling thickness. Galvanized steel construction. Plaster frame features include:

- Regressed locking screw for securing hanger bars
- Cutouts for easily crimping hanger bars in position
- HALO name embossed on plaster frame
- The housing may be removed from plaster frame to provide access to the junction box
- Pre-installed Air-Tite gasket

Includes:

- Air-Tite™ code compliant (Details Pg. 11)
- Got Nail!™ bar hangers (Details Pg. 11)
- Slide-N-Side™ junction box wire traps (Details Pg. 11)
- Pass-N-Thru™ bars (Details Pg. 11)
- Quick Connect™ push wire nuts (Details Pg. 11)

Transformer

Integral 120/277V dual-tap magnetic transformer steps line voltage down to 12V nominal MR16 lamp operating voltage. Rated for 50W max. Housing ships as 277V model with 120V transformer wire lead capped. For use in 120V systems, simply cap the 277V wire lead and use 120V lead (refer to instructions supplied with housing).

Socket

GU5.3 socket for 12V MR16 lamps

Compliances

- cULus Listed 1598 luminaire
- cULus Listed damp location
- cULus Listed for wet location, covered ceiling, with select trims
- Air-Tite code compliant. Certified under ASTM E283; not exceeding 2.0 cfm (0.944 L/s) air leakage rate tested at a 1.57 psf (75 Pa) pressure differential
- RoHS compliant

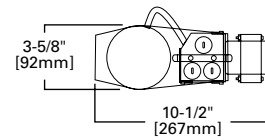
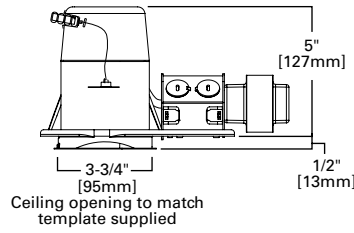

H36LVRTAT277

3" Non-IC, Air-Tite, Shallow Remodel, 120/277V – 12V Low Voltage, MR16

H36LVRTAT277 is a Non-IC, Air-Tite™ housing for use with H3 3" series trims. For installation from below the ceiling. Housing is Air-Tite to restrict airflow between conditioned spaces and unconditioned areas. H36LVRTAT277 features integral 120/277 dualtap transformer. For use with 12V MR16 lamps. Designed for installation in 120 or 277V electrical systems. Non-IC housing is Air-Tite™ but insulation must be kept 3 inches away from all sides of housing.



Special Features

- Air-Tite™ code compliant
- Quick Connect™ push wire nuts

Compatible Trims

3001	3004	3008	3011	3017
3002	3006	3009	3012	3020
3003	3007	3010	3013	

Features

Housing

Formed of CRS with white powder coat finish

Remodel Plaster Frame

"Easy clip" provided to secure plaster frame in ceiling while installation is being completed. Adjustable cam-locks provide positive lock of housing to plaster frame to complete housing installation.

Includes:

- Air-Tite™ code compliant (Details Pg. 11)
- Quick Connect™ push wire nuts (Details Pg. 11)

Transformer

Integral 120/277V dual-tap magnetic transformer steps line voltage down to 12V nominal MR16 lamp operating voltage. Rated for 50W max. Housing ships as 277V model with 120V transformer wire lead capped. For use in 120V systems, simply cap the 277V wire lead and use 120V lead (refer to instructions supplied with housing).

Socket

GU5.3 socket for 12V MR16 lamps

Compliances

- cULus Listed 1598 luminaire
- cULus Listed damp location
- cULus Listed for wet location, covered ceiling, with select trims
- Air-Tite code compliant. Certified under ASTM E283; not exceeding 2.0 cfm (0.944 L/s) air leakage rate tested at a 1.57 psf (75 Pa) pressure differential
- RoHS compliant

Remodel Housing Installation



Cut hole in ceiling using template supplied



Bring power to fixture using non metallic sheathed cable or flexible metal cable (per local code)



The Slide-N-Side™ wire trap lets you make all wiring connections outside the junction box



Slide cable into Slide-N-Side™ wire trap and close junction box cover



Insert plaster frame into ceiling opening



Support clip keeps plaster frame in place during rest of installation



Insert housing into position and align slots in housing wall with indicator label on inside of plaster frame opening (bottom of cam lock spring blades should be positioned on flat area of the plaster frame). Then secure in position with cam locks.



Install lamp and insert trim to complete installation

H3 Series Trims

Non-IC Housings: H36TAT • H36RTAT • H36LVTAT • H36LVTATCP • H36LVRTAT • H36LVTAT277 • H36LVRTAT277

3
INCH

Reflectors

3004 Adjustable Reflector

- Die cast trim ring with reflector
- For general illumination
- 35° tilt, 360° orientation within housing

Lamp	120V GU10 50W	12V MR16 50W
Housing	H36RTAT H36TAT	H36LVRTAT H36LVRTAT277 H36LVTAT H36LVTAT277 H36LVTATCP



3004WHW
White Reflector, White Trim



3004WHC
Clear Reflector, White Trim



3004WHH
Haze Reflector, White Trim



3004SN
Satin Nickel Reflector,
Satin Nickel Trim



3004TBZ
Tuscan Bronze Reflector,
Tuscan Bronze Trim

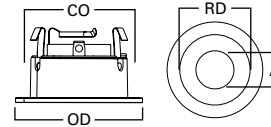

Dimensions**
A: 2" [51mm]
RD: 3" [75mm]
CO: 3-3/4" [95mm]
OD: 4-1/4" [108mm]

Baffles

3003 Adjustable Coilex® Baffle

- Die cast trim ring with machined metal Coilex baffle
- For general illumination
- 35° tilt, 360° orientation within housing

Lamp	120V GU10 50W	12V MR16 50W
Housing	H36RTAT H36TAT	H36LVRTAT H36LVRTAT277 H36LVTAT H36LVTAT277 H36LVTATCP



3003WHWB
White Coilex Baffle, White Trim



3003WHBB
Black Coilex Baffle, White Trim



3003BKBB
Black Coilex Baffle, Black Trim



3003SNB
Satin Nickel Coilex Baffle,
Satin Nickel Trim



3003TBZB
Tuscan Bronze Coilex Baffle,
Tuscan Bronze Trim

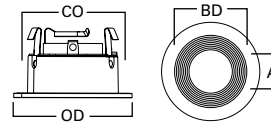

Dimensions**
A: 2" [51mm]
BD: 3" [75mm]
CO: 3-3/4" [95mm]
OD: 4-1/4" [108mm]

3011 Square Adjustable Baffle

- Die cast trim ring with metal baffle
- For general illumination
- 15° tilt, 350° integral lamp holder rotation with locking thumbscrew

Lamp	120V GU10 50W	12V MR16 50W
Housing	H36RTAT H36TAT	H36LVRTAT H36LVRTAT277 H36LVTAT H36LVTAT277 H36LVTATCP



3011WHWB
White Baffle, White Trim



3011WHBB
Black Baffle, White Trim



3011BKBB
Black Baffle, Black Trim



3011SNBB
Black Baffle, Satin Nickel Trim



3011TBZBB
Black Baffle, Tuscan Bronze Trim

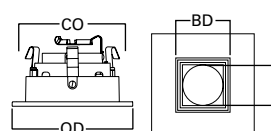

Dimensions**
A: 1-7/8" [48mm]
BD: 2-1/4" [57mm]
CO (Round): 3-3/4" [95mm]
OD: 4-1/4" [108mm]

**Key: A: Luminous Aperture, RD/BD: Reflector/Baffle Diameter, CO: Ceiling Opening, OD: Trim Outside Diameter

Specifications, compliances and dimensions subject to change without notice

Adjustable – Eyeballs & Gimbals

3009 Adjustable Gimbal - 35° Tilt

- Die cast trim ring with die cast gimbal
- For directional accent lighting
- 35° tilt, 15° negative tilt, 360° gimbal orientation and trim within housing

Lamp	120V GU10 50W	12V MR16 50W
Housing	H36RTAT H36TAT	H36LVRTAT H36LVRTAT277 H36LVTAT H36LVTAT277 H36LVTATCP



3009WHWB
White Baffle, White Gimbal



3009WHBB
Black Baffle, White Gimbal



3009BKBB
Black Baffle, Black Gimbal



3009SNBB
Black Baffle, Satin Nickel Gimbal



3009TBZBB
Black Baffle, Tuscan Bronze Gimbal

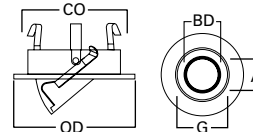

Dimensions**
 A: 1-3/4" [45mm]
 BD: 2" [51mm]
 G: 2-3/4" [70mm]
 CO: 3-3/4" [95mm]
 OD: 4-1/4" [108mm]

3010 Super Adjustable - 0-75° Adjustment

- Die cast trim ring and adjustable lamp sleeve
- For directional accent lighting
- Integral nylon ball bearings and silicone guides protect finish
- 0-75° tilt, 360° orientation within housing
- Front-loading, turn-lock lamp access

Lamp	120V GU10 50W	12V MR16 50W
Housing	H36RTAT H36TAT	H36LVRTAT H36LVRTAT277 H36LVTAT H36LVTAT277 H36LVTATCP



3010WH
White Baffle, White Trim



3010SN
Satin Nickel Baffle,
Satin Nickel Trim

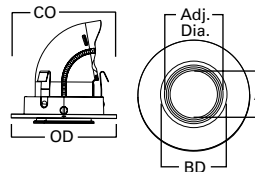

Dimensions**
 A: 1-3/4" [45mm]
 Adj. Dia.: 2-3/8" [60mm]
 BD: 2-1/2" [64mm]
 CO: 3-3/4" [95mm]
 OD: 4-1/4" [108mm]

Pull Down / Adjustment



3013 Square Adjustable Gimbal

- Die cast trim ring with die cast gimbal
- For accent and task lighting
- 35° positive tilt, 15° negative tilt, 360° orientation within housing
- Front-loading, snap-in lamp access face plate

Lamp	120V GU10 50W	12V MR16 50W
Housing	H36RTAT H36TAT	H36LVRTAT H36LVRTAT277 H36LVTAT H36LVTAT277 H36LVTATCP



3013WH
White



3013SN
Satin Nickel



3013TBZ
Tuscan Bronze



3013BK
Black

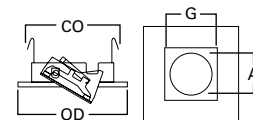

Dimensions**
 A: 1-3/4" [45mm]
 G: 2-1/4" [57mm]
 CO (Round): 3-3/4" [95mm]
 OD (Square): 4-1/4" [108mm]

**Key: A: Luminous Aperture, RD/BD: Reflector/Baffle Diameter, CO: Ceiling Opening, OD: Trim Outside Diameter, G: Gimbal Outside Diameter

H3 Series Trims

Non-IC Housings: H36TAT • H36RTAT • H36LVTAT • H36LVTATCP • H36LVRTAT • H36LVTAT277 • H36LVRTAT277

3
INCH

Lenses & Wet Location Showerlights



3007 Regressed Lens Adjustable Reflector

- Die cast trim ring: TBZ models
- Non-conductive & non-corrosive polymer trim ring: WHC, PCC, SN models
- Regressed clear lens
- For general illumination
- Wet location listed for showers
- 15° tilt, 360° orientation within housing



3007WHC
Specular Clear Reflector,
White Trim



3007PCC
Specular Clear Reflector,
Polished Chrome Trim



3007SN
Satin Nickel Reflector,
Satin Nickel Trim



3007TBZ
Tuscan Bronze Reflector,
Tuscan Bronze Trim

Lamp	120V GU10 50W	12V MR16 50W
Housing	H36RTAT H36TAT	H36LVRTAT H36LVRTAT277 H36LVTAT H36LVTAT277 H36LVTATCP

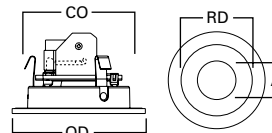

Dimensions**
A: 2" [51mm]
RD: 3" [75mm]
CO: 3-3/4" [95mm]
OD: 4-1/4" [108mm]

3008 Frosted Glass Perimeter Lens

- Non-conductive & non-corrosive polymer trim ring
- Glass lens with frosted perimeter
- Clear specular upper reflector
- Wet location listed for showers, "Dead-Front"
- 360° orientation within housing



3008FG
White with Frosted Glass
Perimeter Lens

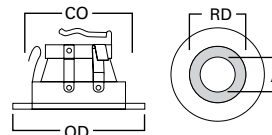

Dimensions**
A: 1-7/8" [48mm]
RD: 2-9/16" [65mm]
CO: 3-3/4" [95mm]
OD: 4-1/4" [108mm]

Lamp	120V GU10 50W	12V MR16 50W
Housing	H36RTAT H36TAT	H36LVRTAT H36LVRTAT277 H36LVTAT H36LVTAT277 H36LVTATCP

3017 Decorative Low-Profile Glass Curve

- Die cast construction and decorative glass element
- Frost glass perimeter with clear glass center
- Wet location listed for showers



3017FGS
Frost Glass Curve

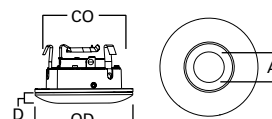

Dimensions**
A: 1-1/2" [39mm]
D: 1/2" [13mm]
CO: 3-3/4" [95mm]
OD: 4-1/4" [108mm]

Lamp	120V GU10 50W	12V MR16 50W
Housing	H36RTAT H36TAT	H36LVRTAT H36LVRTAT277 H36LVTAT H36LVTAT277 H36LVTATCP

3012 Square Regressed Lens Adjustable Baffle

- Die cast trim ring with metal baffle
- For general illumination
- 15° tilt, 360° integral lamp holder rotation with locking thumbscrew
- Wet location listed for showers



3012WHWB
White Baffle, White Trim



3012WHBB
Black Baffle, White Trim



3012BKBB
Black Baffle, Black Trim



3012SNBB
Black Baffle, Satin Nickel Trim



3012TBZBB
Black Baffle, Tuscan Bronze Trim

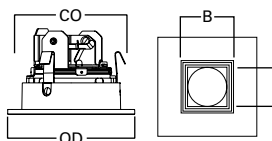

Dimensions**
A: 1-7/8" [48mm]
BD: 2-1/4" [57mm]
CO (Round): 3-3/4" [95mm]
OD: 4-1/4" [108mm]

Lamp	120V GU10 50W	12V MR16 50W
Housing	H36RTAT H36TAT	H36LVRTAT H36LVRTAT277 H36LVTAT H36LVTAT277 H36LVTATCP

**Key: A: Luminous Aperture, RD/BD: Reflector/Baffle Diameter, CO: Ceiling Opening, OD: Trim Outside Diameter, D: Depth Profile

Specifications, compliances and dimensions subject to change without notice

Pinhole, Slot & Wall Wash

3001 Adjustable Pinhole Baffle

- Die cast trim ring with black oculus and machined metal baffle
- For concentrated accent lighting
- 15° tilt, 360° orientation within housing

Lamp	120V GU10 50W	12V MR16 50W
Housing	H36RTAT H36TAT	H36LVRTAT H36LVRTAT277 H36LVTAT H36LVTAT277 H36LVTATCP



3001WHWB
White Baffle, White Trim

3001WHBB
Black Baffle, White Trim

3001SNBB
Black Baffle, Satin Nickel Trim

3001BKBB
Black Baffle, Black Trim



3001TBZBB
Black Baffle, Tuscan Bronze Trim

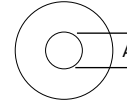
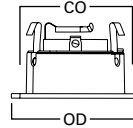

Dimensions**
A: 1-5/8" [41mm]
CO: 3-3/4" [95mm]
OD: 4-1/4" [108mm]

3002 Adjustable Pinhole Reflector

- Die cast trim ring with black oculus and clear specular reflector
- For concentrated accent lighting
- 15° tilt, 360° orientation within housing

Lamp	120V GU10 50W	12V MR16 50W
Housing	H36RTAT H36TAT	H36LVRTAT H36LVRTAT277 H36LVTAT H36LVTAT277 H36LVTATCP



3002WHC
Clear Reflector, White Trim

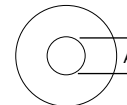
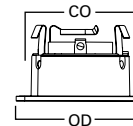

Dimensions**
A: 1-5/8" [41mm]
CO: 3-3/4" [95mm]
OD: 4-1/4" [108mm]

3006 Adjustable Slot Aperture

- Die cast trim ring with metal black baffle
- For directional illumination
- 35° tilt, 360° orientation within housing

Lamp	120V GU10 50W	12V MR16 50W
Housing	H36RTAT H36TAT	H36LVRTAT H36LVRTAT277 H36LVTAT H36LVTAT277 H36LVTATCP



3006WHBB
Black Baffle, White Trim

3006SNBB
Black Baffle, Satin Nickel Trim

3006BKBB
Black Baffle, Black Trim

3006TBZBB
Black Baffle, Tuscan Bronze Trim

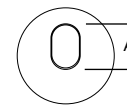
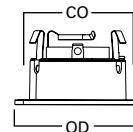

Dimensions**
A: 1-5/8" [41mm]
CO: 3-3/4" [95mm]
OD: 4-1/4" [108mm]

3020 Wall Wash Downlight

- Die cast trim ring
- Integral wall wash reflector
- 360° orientation within housing
- For a subtle grazing light effect on cabinet faces along with a direct downlight on counter tops or similar applications



3020WW
Wall Wash Downlight, White Trim

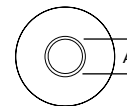
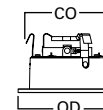

Dimensions**
A: 1-9/16" [40mm]
CO: 3-3/4" [95mm]
OD: 4-1/4" [108mm]

Lamp	120V GU10 50W	12V MR16 50W
Housing	H36RTAT H36TAT	H36LVRTAT H36LVRTAT277 H36LVTAT H36LVTAT277 H36LVTATCP

**Key: A: Luminous Aperture, CO: Ceiling Opening, OD: Trim Outside Diameter



4 INCH

4" E44 LED Lamp

Low Voltage Housings	166
Line Voltage Housings	168
Wafer Thin Trims	170
Full Overlap Trims	174

4" E26 Screw Base

IC Housings & Trims	180
Non-IC Housings & Trims	185

4" Low Voltage

IC Housings	193
Non-IC Housings	194
Trims	197

IC = Insulated Ceiling Non-IC = Non-Insulated Ceiling



E44 Series

4-inch Pin Base Housings & Trims

A family of 4-inch housings and trims optimized for use with LED lamps delivering longer life and energy savings. The ultra-shallow housings are available in new construction and remodel types suitable for 2x4 framing or shallow plenum installation. The compact plaster frame with repositionable junction box fits in tight spacing.

The line voltage housings with GU10 base are available in 10 or 20 watt ratings and can be used with LED or halogen lamp types. The low voltage housings with Gx5.3 base and integral 120/277V step down transformer is rated at 10 watts maximum, ideal for use with LED MR16 lamps.

Trims are also optimized for use with LED lamps and are available in round and square apertures in a range of finishes to match many decors. The E44 round and square pinhole trims match the appearance of the ML4 series allowing lamp and light engine based solutions to be combined while maintaining a consistent look.



Housing Features

1. Got-Nail™ bar hangers

- Q-channel interlocking bars for secure adjustment
- Pass-N-Thru feature allows bars to pass through each other for adjustment and tool-less shortening without removal
- Housing can be positioned at any point within 24" joist span

2. Compact plaster frame

- (2) Locking screws maintain positioning
- Housing can be positioned anywhere along bar hanger and tight to joists

3. Perforation pattern

- Accepts wall board screws anchoring the housing to the ceiling
- Eliminates housing 'bounce' and trim gap to ceiling

4. AIR-TITE gasket

- Pre-installed compression gasket with a special can design that limits airflow and seals the can, frame & ceiling
- No additional gaskets or caulk required - saving installation time and money
- Tested to ASTM-E283-04 standard

5. Slide-N-Side junction box

- Hinged captive cover, box repositionable on the frame to clear obstructions
- Slide-N-Side wire traps and quick connects allow non-metallic sheathed cable to be installed outside the box, without tools and without removing knockouts.
- Accommodates standard non-metallic sheathed cable:
 - U.S.: #14/2, #14/3, #12/2, #12/3
 - Canada: #14/2, #14/3, #12/2

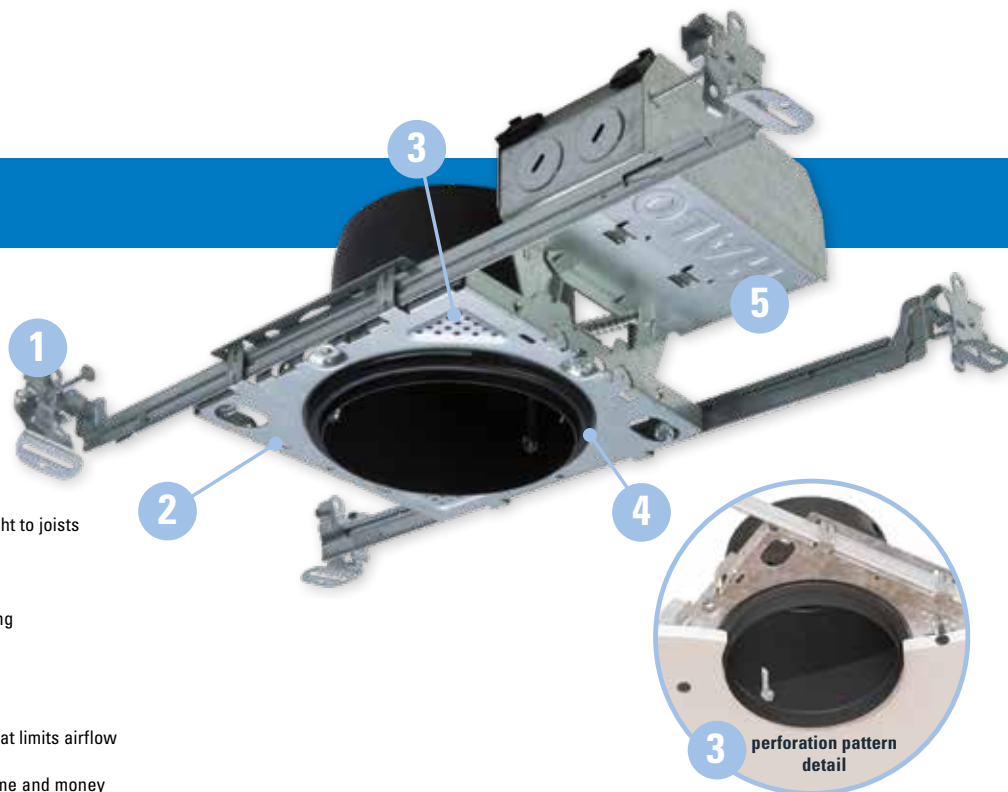

New construction housings feature a toroidal wound, magnetic step-down transformer with 120/277V input and 12V 10W nominal output that is highly efficient and low noise. The remodeler housing uses the same transformer with 120V input only. The transformer is integral to the junction box and can be serviced from below the ceiling through the aperture.



Trim Features

Wafer thin trims

The E44 wafer thin trims are used with the new construction housings. The 1.0 mm thin profile provides minimal ceiling presence.

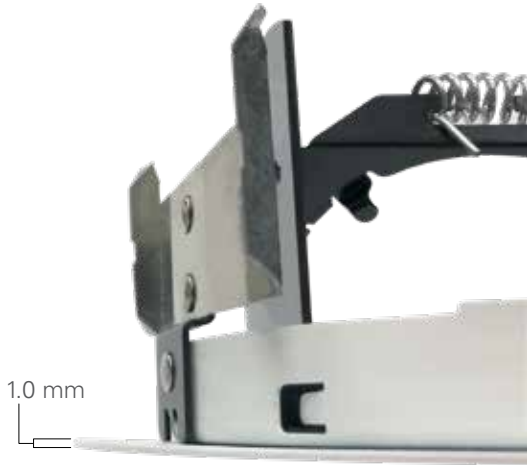

Full overlap trims

The E44 full overlap trims are used with both new construction and remodeler housings. The full overlap flange style trims match the ML4 trim series.

The full overlap flange style trims are supplied with E26 to GU10 adapters for use with Halo H99 or compatible housings.



Lamp Installation and adjustment

1. Coil spring holds lamp securely in position.
2. Friction blades hold trim securely to housing.
3. Accepts (1) lens or louver.
4. Rotates 360°.
5. Four prongs align the lamp and lens to aperture. Accommodates various lamp constructions.
6. Tilts up to 35°. Lever arm locks in at 2.5° increments.

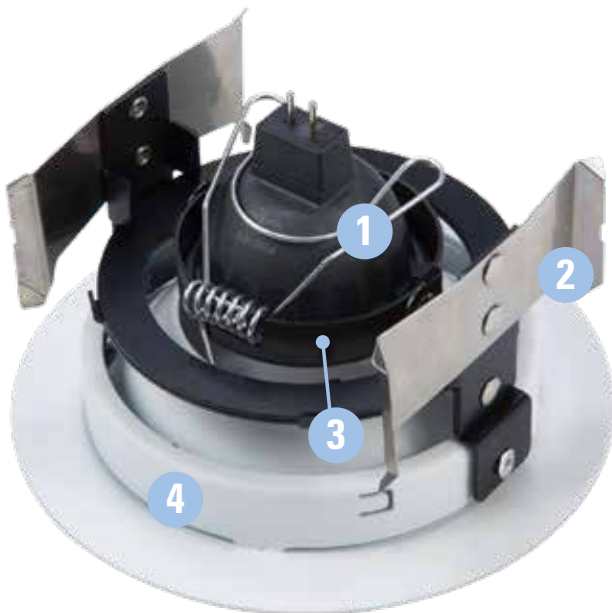

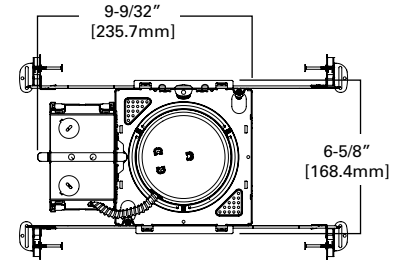
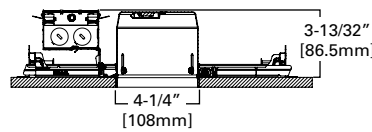

E44MR16ICAT

4" Ultra-Shallow Recessed Low Voltage New Construction Housing

Recessed 4" aperture ultra-shallow new construction housing with integral step down transformer optimized for low voltage LED MR16 lamps. Suitable for 2x4 residential framing or shallow plenum commercial construction, meets restrictive airflow requirements and can be used in direct contact with insulation. Use with compatible Halo™ trims and LED MR16 lamps (by others) providing a broad range of trim styles and optical distributions.



Special Features

- Got-Nail!™ bar hangers
- Pass-N-Thru™ bar hangers
- Quick Connect™ push wire nuts
- Air-Tite™ code compliant
- Slide-N-Side™ junction box

Compatible Trims

1430	1465	1466	1484	1487
1431	1433	1440	1485	1489
1434	1437	1441	1443	1442
1435	1432	1444	1447	1446
1464	1436	1445	1449	1486

Features

Housing

- Single wall deep drawn aluminum housing painted matte black for a visually dark interior
- Adjusts vertically to accommodate 3/8" to 1-1/4" thick ceilings and locks in position with (3) setscrews
- Integral gasket achieves airtight compliance without additional caulk or gaskets
- Shipped with overspray protector installed
- Housing can be removed from below the ceiling for service or splice inspection

Plaster Frame

- Notches facilitate use of guide strings or laser lines for precise positioning
- Regressed screws provide positive horizontal bar hanger locking from below the ceiling
- Perforations accept drywall screws from below securing housing to ceiling structure

Bar Hangers

- Captive preinstalled Got-Nail!™ bar hangers supports housing any point along span and tight to framing
- Pass-N-Thru™ feature allows adjust from 6" to 24" wide without removal
- Captive nail penetrates standard and engineered lumber
- Leveling flange aligns plaster frame with structure
- Integral clip attaches directly to tee-bar

Universal Mounting Bracket Accessory

- Accepts 1/2" EMT, C channel and bar hangers
- Adjusts 3" vertically from above the ceiling
- Installed to plaster frame with (2) screws (provided)

Junction Box

- Compact galvanized steel junction box with 16in³ internal volume
- Listed for (10) #12 AWG 90° C splice conductors
- Repositionable 90° on plaster frame to avoid obstructions
- Hinged door is retained and provides easy access to field wiring
- (6) 1/2" conduit pry-outs positioned to allow straight conduit runs
- (3) Slide-N-Side™ non-metallic (NM) wire traps allows wiring outside the box
- Accepts 14-2, 14-3, 12-2, 12-3 U.S. and 14-2, 14-3, 12-2 Canadian NM cable
- (3) 4-port push wire nuts with clear caps for quick and reliable mains voltage connections

Step Down Transformer

- Low noise toroidal wound magnetic step down transformer
- Thermally protected
- 120/277V 60Hz input provides 12V nominal at 10W output

Socket

- Gx5.3 socket for bi-pin 12V LED MR16 lamps

Trims

- Compatible with a broad range of trim styles and optical distributions
- Friction blades hold trim tight to ceiling surface, gasket minimizes light leaks
- Use with wafer thin, full overlap or die cast flange styles

Compliances

- Type IC suitable for direct contact to air permeable insulation and cULus listed for damp locations
- Not for use in direct contact with spray foam insulation, consult NEMA LSD57-2013
- Wet location listed in covered ceilings and IP44 certified with select lens trims
- Airtight per ASTM-E283
- Can be used for State of California Title 24 high efficacy luminaire compliance with designated trims and CA JAB-2016-E labeled lamps
- Suitable for use in clothes closets when installed in accordance with the NEC 410.16 spacing requirements
- Contains no mercury or lead and RoHS compliant

Energy Data

Input Voltage	120V	277V
Input Current	0.099 (mA)	(mA)
Input Power	11.89 (W)	(W)
Inrush (A)	2 (A)	(A)
THD	≤ 20%	
PF	≥ 0.90	
T Ambient	-40 - +40°C	
Sound Rating	≤ 20dba	

E44 Series - Pin Base Housing

E44MR16RICAT

4
INCH

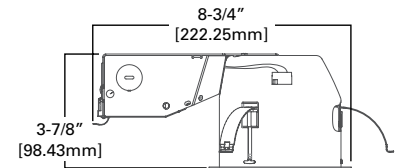
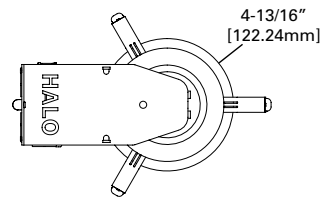

E44MR16RICAT

4" Ultra-Shallow Recessed Low Voltage Remodeler Housing

Recessed 4" aperture ultra-shallow install from below remodeler type housing with integral step down transformer optimized for low voltage LED MR16 lamps. Suitable for 2x4 residential framing or shallow plenum commercial construction, meets restrictive airflow requirements and can be used in direct contact with insulation. Use with compatible Halo™ trims and LED MR16 lamps (by others) providing a broad range of trim styles and optical distributions.



Special Features

- Quick Connect™ push wire nuts
- Air-Tite™ code compliant

Compatible Trims

1440	1445	1443	1487	1446
1441	1484	1447	1489	1486
1444	1485	1449	1442	

Features

Housing

- Single wall deep drawn aluminum housing painted matte black for a visually dark interior
- Accommodates ceilings from 3/8" to 1-1/4" thick
- Shipped with overspray protector installed

Mounting Springs

- Captive preinstalled mounting springs retain housing securely in ceiling.
- Housing can be removed from below the ceiling for service or splice inspection

Gasket

- Closed cell gaskets achieve restrictive airflow requirements without additional gaskets or caulking

Junction Box

- Compact galvanized steel junction box with 10in³ internal volume
- Listed for (6) #12 AWG 90° C splice conductors
- Hinged door is retained and provides easy access to field wiring
- (3) 1/2" conduit pry-outs

- (3) Slide-N-Side™ non-metallic (NM) wire traps allows wiring outside the box
- Accepts 14-2, 14-3, 12-2, 12-3 U.S. and 14-2, 14-3, 12-2 Canadian NM cable
- Quick Connect™ remodel wiring tray holds (3) 4-port push wire nuts facilitating mains voltage connections

Step Down Transformer

- Low noise toroidal wound magnetic step down transformer
- Thermally protected
- 120V 60Hz input provides 12V at 10W output

Socket

- Gx5.3 socket for bi-pin 12V LED MR16 lamps

Trims

- Compatible with a broad range of trim styles and optical distributions
- Friction blades hold trim tight to ceiling surface, gasket minimizes light leaks
- Use with full overlap or die cast flange styles

Compliances

- Type IC suitable for direct contact to air permeable insulation and cULus listed for damp locations
- Not for use in direct contact with spray foam insulation, consult NEMA LSD57-2013
- Wet location listed in covered ceilings and IP44 certified with select lens trims
- Airtight per ASTM-E283
- Can be used for State of California Title 24 high efficacy luminaire compliance with designated trims and CA JAB-2016-E labeled lamps
- Suitable for use in clothes closets when installed in accordance with the NEC 410.16 spacing requirements
- Contains no mercury or lead and RoHS compliant

Energy Data

Input Voltage	120V
Input Current	(mA)
Input Power	(W)
Inrush (A)	(A)
THD	≤ 20%
PF	≥ 0.90
T Ambient	-40 - +40°C
Sound Rating	≤ 20dba

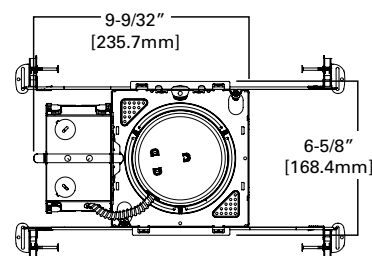
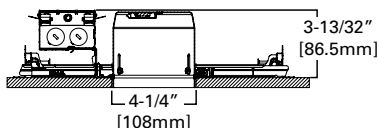

E44PAR16ICAT

4" Ultra-Shallow Recessed Line Voltage New Construction Housing

Recessed 4" aperture ultra-shallow new construction housing optimized for line voltage LED or halogen PAR16 lamps. Suitable for 2x4 residential framing or shallow plenum commercial construction, meets restrictive airflow requirements and can be used in direct contact with insulation. Use with compatible Halo™ trims and PAR16 lamps (by others) providing a broad range of trim styles and optical distributions.



Special Features

- Got-Nail!™ bar hangers
- Pass-N-Thru™ bar hangers
- Quick Connect™ push wire nuts
- Air-Tite™ code compliant
- Slide-N-Side™ junction box

Compatible Trims

1430	1465	1466	1484	1487
1431	1433	1440	1485	1489
1434	1437	1441	1443	1442
1435	1432	1444	1447	1446
1464	1436	1445	1449	1486

Features

Housing

- Single wall deep drawn aluminum housing painted matte black for a visually dark interior
- Adjusts vertically to accommodate 3/8" to 1-1/4" thick ceilings and locks in position with (3) setscrews
- Integral gasket achieves airtight compliance without additional caulk or gaskets
- Shipped with overspray protector installed
- Housing can be removed from below the ceiling for service or splice inspection

Plaster Frame

- Compact galvanized steel plaster frame with integral bar hanger receivers
- Notches facilitate use of guide strings or laser lines for precise positioning
- Regressed screws provide positive horizontal bar hanger locking from below the ceiling
- Perforations accept drywall screws from below securing housing to ceiling structure

Bar Hangers

- Captive preinstalled Got-Nail™ bar hangers supports housing any point along span and tight to framing
- Pass-N-Thru™ feature allows adjust from 6" to 24" wide without removal
- Captive nail penetrates standard and engineered lumber
- Leveling flange aligns plaster frame with structure
- Integral clip attaches directly to tee-bar

Universal Mounting Bracket Accessory

- Accepts 1/2" EMT, C channel and bar hangers
- Adjusts 3" vertically from above the ceiling
- Installed to plaster frame with (2) screws (provided)

Junction Box

- Compact galvanized steel junction box with 16in³ internal volume
- Listed for (10) #12 AWG 90° C splice conductors
- Repositionable 90° on plaster frame to avoid obstructions
- Hinged door is retained and provides easy access to field wiring
- (6) 1/2" conduit pry-outs positioned to allow straight conduit runs
- (3) Slide-N-Side™ non-metallic (NM) wire traps allows wiring outside the box
- Accepts 14-2, 14-3, 12-2, 12-3 U.S. and 14-2, 14-3, 12-2 Canadian NM cable
- (3) 4-port push wire nuts with clear caps for quick and reliable mains voltage connections

Socket

- GU10 socket for 120V LED PAR16 lamps

Trims

- Compatible with a broad range of trim styles and optical distributions
- Friction blades hold trim tight to ceiling surface, gasket minimizes light leaks
- Use with wafer thin, full overlap or die cast flange styles

Compliances

- Type IC thermally protected, suitable for direct contact to air permeable insulation and cULus listed for damp locations
- Not for use in direct contact with spray foam insulation, consult NEMA LSD57-2013
- Wet location listed in covered ceilings and IP44 certified with select lens trims
- Airtight per ASTM-E283
- Can be used for State of California Title 24 high efficacy luminaire compliance with designated trims and CA T24-2016-E labeled lamps
- Suitable for use in clothes closets when installed in accordance with the NEC 410.16 spacing requirements
- Contains no mercury or lead and RoHS compliant

Energy Data

Input Voltage	120V
Input Current	0.099 (mA)
Input Power	11.89 (W)
Inrush (A)	2 (A)
THD	≤ 20%
PF	≥ 0.90
T Ambient	-40 - +40°C
Sound Rating	≤ 20dba

E44 Series - Pin Base Housing

E44PAR16RICAT

4
INCH

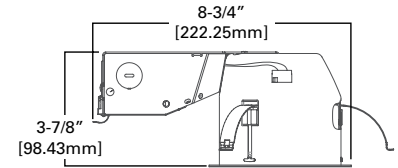
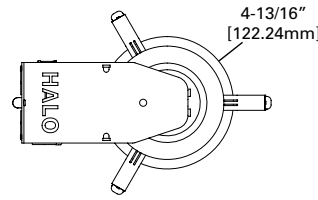

E44PAR16RICAT

4" Ultra-Shallow Recessed Line Voltage Remodeler Housing

Recessed 4" aperture ultra-shallow install from below remodeler type housing for line voltage LED or halogen PAR16 lamps. Suitable for 2x4 residential framing or shallow plenum commercial construction, meets restrictive airflow requirements and can be used in direct contact with insulation. Use with compatible Halo™ trims and PAR16 lamps (by others) providing a broad range of trim styles and optical distributions.



Special Features

- Quick Connect™ push wire nuts
- Air-Tite™ code compliant

Compatible Trims

1440	1445	1443	1487	1446
1441	1484	1447	1489	1486
1444	1485	1449	1442	

Features

Housing

- Single wall deep drawn aluminum housing painted matte black for a visually dark interior
- Accommodates ceilings from 3/8" to 1-1/4" thick
- Shipped with overspray protector installed

Mounting Springs

- Captive preinstalled mounting springs retain housing securely in ceiling.
- Housing can be removed from below the ceiling for service or splice inspection

Gasket

- Closed cell gaskets achieve restrictive airflow requirements without additional gaskets or caulking

Junction Box

- Compact galvanized steel junction box with 10in³ internal volume
- Listed for (6) #12 AWG 90° C splice conductors

- Hinged door is retained and provides easy access to field wiring
- (3) 1/2" conduit pry-outs
- (3) Slide-N-Side™ non-metallic (NM) wire traps allows wiring outside the box
- Accepts 14-2, 14-3, 12-2, 12-3 U.S. and 14-2, 14-3, 12-2 Canadian NM cable
- Quick Connect™ remodel wiring tray holds (3) 4-port push wire nuts facilitating mains voltage connections

Socket

- GU10 socket for 120V LED or halogen PAR16 lamps

Trims

- Compatible with a broad range of trim styles and optical distributions
- Friction blades hold trim tight to ceiling surface, gasket minimizes light leaks
- Use with full overlap or die cast flange styles

Compliances

- Type IC thermally protected, suitable for direct contact to air permeable insulation and cULus listed for damp locations
- Not for use in direct contact with spray foam insulation, consult NEMA LSD57-2013
- Wet location listed in covered ceilings and IP44 certified with select lens trims
- Airtight per ASTM-E283
- Can be used for State of California Title 24 high efficacy luminaire compliance with designated trims and CA T24-2016-E labeled lamps
- Suitable for use in clothes closets when installed in accordance with the NEC 410.16 spacing requirements
- Contains no mercury or lead and RoHS compliant

Energy Data

Input Voltage	120V
Input Current	(mA)
Input Power	(W)
Inrush (A)	(A)
THD	≤ 20%
PF	≥ 0.90
T Ambient	-40 - +40°C
Sound Rating	≤ 20dba

Directional Open

1430 Conical Reflector

- Use in new construction housings
- For general illumination
- 1.0 mm thin profile provides minimal ceiling presence
- 35° tilt, 360° orientation within housing

Lamp Gx5.3 12V MR16 120V GU10 PAR16
Housing E44MR16ICAT E44PAR16ICAT



1430MWWF
Matte White, White Flange



1430H
Haze



1430HWF
Haze, White Flange



1430BN
Brushed Nickel, German Bronze



1430GB
German Bronze

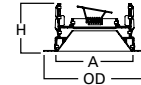

Dimensions**
 A: 3.63" [92mm]
 H: 2.31" [59mm]
 OD: 5" [127mm]

1431 Conical Baffle

- Use in new construction housings
- For general illumination
- 1.0 mm thin profile provides minimal ceiling presence
- 35° tilt, 360° orientation within housing

Lamp Gx5.3 12V MR16 120V GU10 PAR16
Housing E44MR16ICAT E44PAR16ICAT



1431WBWF
White Baffle, White Flange



1431BBWF
Black Baffle, White Flange



1431BN
Brushed Nickel



1431GB
German Bronze



Dimensions**
 A: 3.63" [92mm]
 H: 2.34" [59mm]
 OD: 5" [127mm]

1434 Round Pinhole

- Use in new construction housings
- For general illumination
- 1.0 mm thin profile provides minimal ceiling presence
- 35° tilt, 360° orientation within housing

Lamp Gx5.3 12V MR16 120V GU10 PAR16
Housing E44MR16ICAT E44PAR16ICAT



1434MW
Matte White



1434MB
Matte Black



1434BN
Brushed Nickel



1434GB
German Bronze

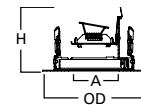

Dimensions**
 A: 2.5" [63mm]
 H: 3.1" [79mm]
 OD: 5" [127mm]

E44 Series - Wafer Thin Trims

Directional Open: 1435 • 1464 • 1465

4
INCH

Directional Open

1435 Round Pinhole with Oculus

- Use in new construction housings
- For general illumination
- 1.0 mm thin profile provides minimal ceiling presence
- 35° tilt, 360° orientation within housing



1435MWWB
Matte White, White Baffle



1435MWBB
Matte White, Black Baffle



1435BNBB
Brushed Nickel, Black Baffle



1435GBBB
German Bronze, Black Baffle

Lamp	Gx5.3 12V MR16	120V GU10 PAR16
Housing	E44MR16ICAT	E44PAR16ICAT

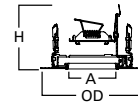

Dimensions**
A: 2.3" [59mm]
H: 3.1" [79mm]
OD: 5" [127mm]

1464 Square Pinhole

- Use in new construction housings
- For general illumination
- 1.0 mm thin profile provides minimal ceiling presence
- 35° tilt, 360° orientation within housing



1464MW
Matte White



1464MB
Matte Black



1464BN
Brushed Nickel



1464GB
German Bronze

Lamp	Gx5.3 12V MR16	120V GU10 PAR16
Housing	E44MR16ICAT	E44PAR16ICAT

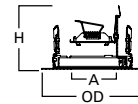

Dimensions**
A: 2.2" [55mm]
H: 3.1" [79mm]
OD: 5" [127mm]

1465 Square Pinhole with Oculus

- Use in new construction housings
- For general illumination
- 1.0 mm thin profile provides minimal ceiling presence
- 35° tilt, 360° orientation within housing



1465MWWB
Matte White, White Baffle



1465MWBB
Matte White, Black Baffle



1465BNBB
Brushed Nickel, Black Baffle



1465GBBB
German Bronze, Black Baffle

Lamp	Gx5.3 12V MR16	120V GU10 PAR16
Housing	E44MR16ICAT	E44PAR16ICAT

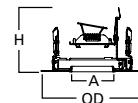

Dimensions**
A: 2" [52mm]
H: 3.1" [79mm]
OD: 5" [127mm]

Directional Lens

1433 Conical Reflector, Diffuse Lens

- Use in new construction housings
- For general illumination
- 1.0 mm thin profile provides minimal ceiling presence
- 35° tilt, 360° orientation within housing

Lamp Gx5.3 12V MR16 120V GU10 PAR16

Housing E44MR16ICAT E44PAR16ICAT



1433MWWF
Matte White, White Flange



1433H
Haze



1433HWF
Haze, White Flange



1433BN
Brushed Nickel



1433GB
German Bronze

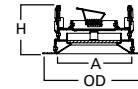

Dimensions**

A: 3.63" [92mm]

H: 2.33" [59mm]

OD: 5" [127mm]

1437 Round Pinhole, Diffuse Lens

- Use in new construction housings
- For general illumination
- 1.0 mm thin profile provides minimal ceiling presence
- 35° tilt, 360° orientation within housing

Lamp Gx5.3 12V MR16 120V GU10 PAR16

Housing E44MR16ICAT E44PAR16ICAT



1437MWWB
Matte White, White Baffle



1437MWBB
Matte White, Black Baffle



1437BNBB
Brushed Nickel, Black Baffle



1437GBBB
German Bronze, Black Baffle

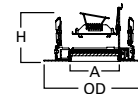

Dimensions**

A: 2.33" [59mm]

H: 3.13" [79mm]

OD: 5" [127mm]

1467 Square Pinhole, Diffuse Lens

- Use in new construction housings
- For general illumination
- 1.0 mm thin profile provides minimal ceiling presence
- 35° tilt, 360° orientation within housing

Lamp Gx5.3 12V MR16 120V GU10 PAR16

Housing E44MR16ICAT E44PAR16ICAT



1467MWWB
Matte White, White Baffle



1467MWBB
Matte White, Black Baffle



1467BNBB
Brushed Nickel, Black Baffle



1467GBBB
German Bronze, Black Baffle

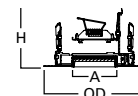

Dimensions**

A: 2.03" [52mm]

H: 3.13" [79mm]

OD: 5" [127mm]

E44 Series - Wafer Thin Trims

Lens Wall Wash: 1432 • 1436 • 1466

4
INCH

Lens Wall Wash

1432 Angle Cut Conical Reflector, Lens Wall Wash

- Use in new construction housings
- For general illumination
- 1.0 mm thin profile provides minimal ceiling presence
- 35° tilt, 360° orientation within housing



1432MWWF
Matte White, White Flange



1432H
Haze



1432HWF
Haze, White Flange

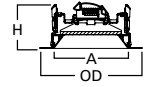

Dimensions**
A: 3.63" [92mm]
H: 2.26" [58mm]
OD: 5" [127mm]

Lamp	Gx5.3 12V MR16	120V GU10 PAR16
Housing	E44MR16ICAT	E44PAR16ICAT

1436 Round Pinhole, Lens Wall Wash

- Use in new construction housings
- For general illumination
- 1.0 mm thin profile provides minimal ceiling presence
- 35° tilt, 360° orientation within housing



1436MWWB
Matte White, White Baffle



1436MWBB
Matte White, Black Baffle

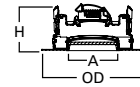

Dimensions**
A: 2.34" [59mm]
H: 2.29" [58mm]
OD: 5" [127mm]

Lamp	Gx5.3 12V MR16	120V GU10 PAR16
Housing	E44MR16ICAT	E44PAR16ICAT

1466 Square Pinhole, Lens Wall Wash

- Use in new construction housings
- For general illumination
- 1.0 mm thin profile provides minimal ceiling presence
- 35° tilt, 360° orientation within housing



1466MWWB
Matte White, White Baffle



1466MWBB
Matte White, Black Baffle

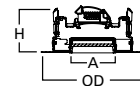

Dimensions**
A: 2.03" [52mm]
H: 2.29" [58mm]
OD: 5" [127mm]

Lamp	Gx5.3 12V MR16	120V GU10 PAR16
Housing	E44MR16ICAT	E44PAR16ICAT

Directional Open

1440 Conical Reflector

- Use in new construction and remodeler housings
- For general illumination
- Full overlap flange style trims match the ML4 trim series
- 35° tilt, 360° orientation within housing

Lamp	Gx5.3 12V MR16	120V GU10 PAR16
Housing	E44MR16ICAT E44MR16RICAT	E44PAR16ICAT E44PAR16RICAT

- The full overlap flange style trims are supplied with E26 to GU10 adapters for use with Halo H99 or compatible housings.



1440MWWF
Matte White, White Flange



1440H
Haze



1440HWF
Haze, White Flange



1440BN
Brushed Nickel



1440GB
German Bronze

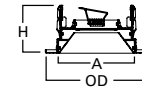

Dimensions**

A: 3.63" [92mm]

H: 2.34" [59mm]

OD: 5" [127mm]

1441 Conical Baffle

- Use in new construction and remodeler housings
- For general illumination
- Full overlap flange style trims match the ML4 trim series
- 35° tilt, 360° orientation within housing

Lamp	Gx5.3 12V MR16	120V GU10 PAR16
Housing	E44MR16ICAT E44MR16RICAT	E44PAR16ICAT E44PAR16RICAT

- The full overlap flange style trims are supplied with E26 to GU10 adapters for use with Halo H99 or compatible housings.



1441WBWF
White Baffle, White Flange



1440BBWF
Black Baffle, White Flange



1441BN
Brushed Nickel



1441GB
German Bronze

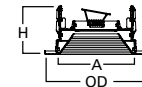

Dimensions**

A: 3.63" [92mm]

H: 2.34" [59mm]

OD: 5" [127mm]

1444 Round Pinhole

- Use in new construction and remodeler housings
- For general illumination
- Full overlap flange style trims match the ML4 trim series
- 35° tilt, 360° orientation within housing

Lamp	Gx5.3 12V MR16	120V GU10 PAR16
Housing	E44MR16ICAT E44MR16RICAT	E44PAR16ICAT E44PAR16RICAT

- The full overlap flange style trims are supplied with E26 to GU10 adapters for use with Halo H99 or compatible housings.



1444MW
Matte White



1444MB
Matte Black



1444BN
Brushed Nickel



1444GB
German Bronze

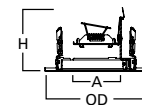

Dimensions**

A: 2.47" [63mm]

H: 3.11" [79mm]

OD: 5" [127mm]

E44 Series - Full Overlap Trims

Directional Open: 1445 • 1484 • 1485

4
INCH

Directional Open

1445 Round Pinhole with Oculus

- Use in new construction and remodeler housings
- For general illumination
- Full overlap flange style trims match the ML4 trim series
- 35° tilt, 360° orientation within housing

Lamp Gx5.3 12V MR16 120V GU10 PAR16

Housing E44MR16ICAT E44PAR16ICAT
E44MR16RICAT E44PAR16RICAT

- The full overlap flange style trims are supplied with E26 to GU10 adapters for use with Halo H99 or compatible housings.



1445MWWB
Matte White, White Baffle



1445MWBB
Matte White, Black Baffle



1445BNBB
Brushed Nickel, Black Baffle



1445GBBB
German Bronze, Black Baffle

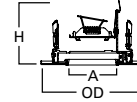

Dimensions**
A: 2.34" [59mm]
H: 3.13" [79mm]
OD: 5" [127mm]

1484 Square Pinhole

- Use in new construction and remodeler housings
- For general illumination
- Full overlap flange style trims match the ML4 trim series
- 35° tilt, 360° orientation within housing

Lamp Gx5.3 12V MR16 120V GU10 PAR16

Housing E44MR16ICAT E44PAR16ICAT
E44MR16RICAT E44PAR16RICAT

- The full overlap flange style trims are supplied with E26 to GU10 adapters for use with Halo H99 or compatible housings.



1484MW
Matte White



1484MB
Matte Black



1484BN
Brushed Nickel



1484GB
German Bronze

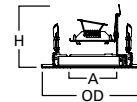

Dimensions**
A: 2.17" [55mm]
H: 3.11" [79mm]
OD: 5" [127mm]

1485 Square Pinhole with Oculus

- Use in new construction and remodeler housings
- For general illumination
- Full overlap flange style trims match the ML4 trim series
- 35° tilt, 360° orientation within housing

Lamp Gx5.3 12V MR16 120V GU10 PAR16

Housing E44MR16ICAT E44PAR16ICAT
E44MR16RICAT E44PAR16RICAT

- The full overlap flange style trims are supplied with E26 to GU10 adapters for use with Halo H99 or compatible housings.



1485MWWB
Matte White, White Baffle



1485MWBB
Matte White, Black Baffle



1485BNBB
Brushed Nickel, Black Baffle



1485GBBB
German Bronze, Black Baffle

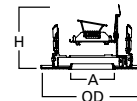

Dimensions**
A: 2.03" [52mm]
H: 3.13" [79mm]
OD: 5" [127mm]

Directional Lens

1443 Conical Reflector, Diffuse Lens

- Use in new construction and remodeler housings
- For general illumination
- Full overlap flange style trims match the ML4 trim series
- 35° tilt, 360° orientation within housing

Lamp	Gx5.3 12V MR16	120V GU10 PAR16
Housing	E44MR16ICAT E44MR16RICAT	E44PAR16ICAT E44PAR16RICAT

- The full overlap flange style trims are supplied with E26 to GU10 adapters for use with Halo H99 or compatible housings.



1443MWWF
Matte White, White Flange



1443H
Haze



1443HWF
Haze, White Flange



1443BN
Brushed Nickel



1443GB
German Bronze

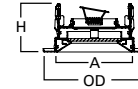

Dimensions**

A: 3.63" [92mm]
H: 2.34" [59mm]
OD: 5" [127mm]

1447 Round Pinhole, Diffuse Lens

- Use in new construction and remodeler housings
- For general illumination
- Full overlap flange style trims match the ML4 trim series
- 35° tilt, 360° orientation within housing

Lamp	Gx5.3 12V MR16	120V GU10 PAR16
Housing	E44MR16ICAT E44MR16RICAT	E44PAR16ICAT E44PAR16RICAT

- The full overlap flange style trims are supplied with E26 to GU10 adapters for use with Halo H99 or compatible housings.



1447MWWB
Matte White, White Baffle



1447MWBB
Matte White, Black Baffle



1447BNBB
Brushed Nickel, Black Baffle



1447GBBB
German Bronze, Black Baffle

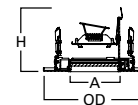

Dimensions**

A: 2.34" [59mm]
H: 3.13" [79mm]
OD: 5" [127mm]

1449 Round "All Acrylic-Glass", Diffuse Lens

- Use in new construction and remodeler housings
- For general illumination
- Full overlap flange style trims match the ML4 trim series
- 35° tilt, 360° orientation within housing

Lamp	Gx5.3 12V MR16	120V GU10 PAR16
Housing	E44MR16ICAT E44MR16RICAT	E44PAR16ICAT E44PAR16RICAT

- The full overlap flange style trims are supplied with E26 to GU10 adapters for use with Halo H99 or compatible housings.



1449AAG
Round, All Acrylic Glass

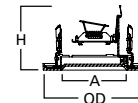

Dimensions**

A: 3.27" [83mm]
H: 3.21" [81mm]
OD: 5.13" [130mm]

E44 Series - Full Overlap Trims

Directional Lens: 1487 • 1489

4
INCH

Directional Lens

1487 Square Pinhole, Diffuse Lens

- Use in new construction and remodeler housings
- For general illumination
- Full overlap flange style trims match the ML4 trim series
- 35° tilt, 360° orientation within housing



1487MWWB
Matte White, White Baffle



1487MWBB
Matte White, Black Baffle



1487BNBB
Brushed Nickel, Black Baffle



1487GBBB
German Bronze, Black Baffle

Lamp	Gx5.3 12V MR16	120V GU10 PAR16
Housing	E44MR16ICAT E44MR16RICAT	E44PAR16ICAT E44PAR16RICAT

- The full overlap flange style trims are supplied with E26 to GU10 adapters for use with Halo H99 or compatible housings.

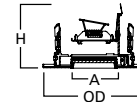

Dimensions**

A: 2.03" [52mm]
H: 3.13" [79mm]
OD: 5" [127mm]

1489 Square "All Acrylic-Glass", Diffuse Lens

- Use in new construction and remodeler housings
- For general illumination
- Full overlap flange style trims match the ML4 trim series
- 35° tilt, 360° orientation within housing



1489AAG
Square, All Acrylic Glass

Lamp	Gx5.3 12V MR16	120V GU10 PAR16
Housing	E44MR16ICAT E44MR16RICAT	E44PAR16ICAT E44PAR16RICAT

- The full overlap flange style trims are supplied with E26 to GU10 adapters for use with Halo H99 or compatible housings.

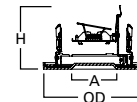

Dimensions**

A: 2.29" [58mm]
H: 3.21" [81mm]
OD: 5.13" [130mm]

Lens Wall Wash

1442 Single Cut Conical Reflector, Lens Wall Wash

- Use in new construction and remodeler housings
- For general illumination
- Full overlap flange style trims match the ML4 trim series
- 35° tilt, 360° orientation within housing



1442MWWF
Matte White, White Flange



1442H
Haze



1442HWF
Haze, White Flange

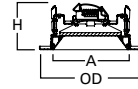

Dimensions**
A: 3.62" [92mm]
H: 2.27" [58mm]
OD: 5" [127mm]

Lamp	Gx5.3 12V MR16	120V GU10 PAR16
Housing	E44MR16ICAT E44MR16RICAT	E44PAR16ICAT E44PAR16RICAT

- The full overlap flange style trims are supplied with E26 to GU10 adapters for use with Halo H99 or compatible housings.



1446 Round Pinhole, Lens Wall Wash

- Use in new construction and remodeler housings
- For general illumination
- Full overlap flange style trims match the ML4 trim series
- 35° tilt, 360° orientation within housing



1446MWWB
Matte White, White Baffle



1446MWBB
Matte White, Black Baffle

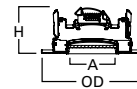

Dimensions**
A: 2.34" [59mm]
H: 2.28" [58mm]
OD: 5" [127mm]

Lamp	Gx5.3 12V MR16	120V GU10 PAR16
Housing	E44MR16ICAT E44MR16RICAT	E44PAR16ICAT E44PAR16RICAT

- The full overlap flange style trims are supplied with E26 to GU10 adapters for use with Halo H99 or compatible housings.



1486 Square Pinhole, Lens Wall Wash

- Use in new construction and remodeler housings
- For general illumination
- Full overlap flange style trims match the ML4 trim series
- 35° tilt, 360° orientation within housing

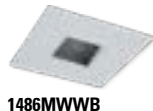

1486MWWB
Matte White, White Baffle



1486MWBB
Matte White, Black Baffle

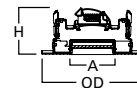

Dimensions**
A: 2.03" [52mm]
H: 2.28" [58mm]
OD: 5" [127mm]

Lamp	Gx5.3 12V MR16	120V GU10 PAR16
Housing	E44MR16ICAT E44MR16RICAT	E44PAR16ICAT E44PAR16RICAT

- The full overlap flange style trims are supplied with E26 to GU10 adapters for use with Halo H99 or compatible housings.





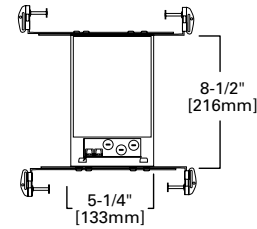
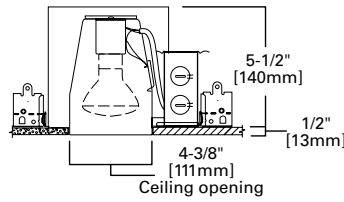

H99ICAT

4" IC, Air-Tite, Shallow New Construction Housing, 120V

The H99ICAT is an IC Air-Tite™ housing for accent, task, and general lighting. It is designed for use in insulated ceilings where it will be in direct contact with insulation*. Air-Tite™ housing designed to restrict air flow between conditioned spaces and unconditioned areas. May be retrofit with compatible Halo LED lighting systems.



Special Features

- Got Nail!™ bar hangers
- Pass-N-Thru™ bars
- Slide-N-Side™ junction box
- Quick Connect™ push wire nuts
- Air-Tite™ code compliant

Compatible Trims

945	953	998	4002	4013
951	993	999	4003	4055
952	996	4001	4010	

Features

Housing

- Outer Housing: aluminum construction helps dissipate heat
- Inner Housing: double wall aluminum construction helps dissipate heat
- The inner housing can be removed from plaster frame to provide access to the junction box
- For insulated ceilings in direct contact with insulation* (May also be installed in non-insulated ceilings)
- Inner housing adjusts for ceilings up to 1" thick

Plaster Frame

- Galvanized steel die-formed construction
- Plaster frame features include:
 - Patented regressed locking screw positioned for securing hanger bars from below the ceiling
 - Cutouts for easily crimping hanger bars in position
 - Air-Tite aperture gasket is pre-installed
 - Halo identity embossed on plaster frame

Includes:

- Got Nail!™ bar hangers (Details Pg. 11)
- Pass-N-Thru™ bars (Details Pg. 11)
- Slide-N-Side™ junction box wire traps (Details Pg. 11)
- Quick Connect™ push wire nuts (Details Pg. 11)
- Air-Tite™ code compliant (Details Pg. 11)

Socket

Fixed position porcelain socket with nickel plated brass screw shell provides consistent lamp positioning

Thermal Protector

Self resetting thermal protector deactivates fixture if overheating occurs due to improper lamping or misapplied insulation

Trims

Halo Fit-All concept offers multiple trim options in a variety of design styles, and functional beam distributions to control beam angle and lumen delivery in accommodating various lamp types

Compliance

- cULus Listed 1598 luminaire
- cULus Listed damp location
- cULus Listed for wet location, covered ceiling, with select trims
- cULus Listed for feed through
- cULus Listed for direct contact with insulation and combustible material*
- RoHS compliant
- Air-Tite code compliant. Certified under ASTM E283; not exceeding 2.0 cfm (0.944 L/s) air leakage rate tested at a 1.57 psf (75 Pa) pressure differential

*Not to be used in direct contact with spray foam insulation (consult NEMA LSD57-2013)

E26 Screw Base IC Housing

E4ICATSB

4
INCH

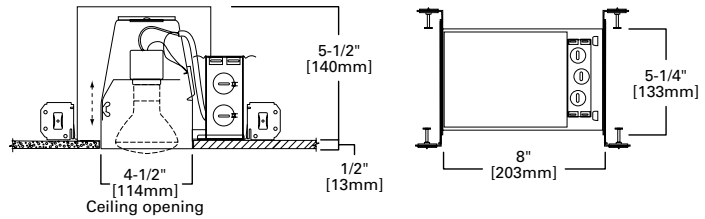

E4ICATSB

4" IC, Air-Tite, Shallow New Construction Housing, 120V

The E4ICATSB is an IC Air-Tite™ housing optimized and listed for EISA compliant tungsten-halogen lamps, CFL and LED lamps as well as incandescent. Housing features an adjustable socket bracket, and is suitable for residential or commercial applications. Installation in insulated ceilings* and non-insulated ceilings with Air-Tite code compliant construction. May be retrofit with compatible Halo LED lighting systems.



Special Features

- All-Nail!™ bar hangers
- Quick Connect™ push wire nuts
- Air-Tite™ code compliant

Compatible Trims

945	953	996	999	4002	4010
952	993	998	4001	4003	4055

Features

Housing

- Outer Housing: aluminum construction
- Inner Housing: double wall aluminum construction helps dissipate heat
- The inner housing can be removed from the plaster frame to provide access to the junction box
- For insulated ceilings in direct contact with insulation* (May also be installed in non-insulated ceilings)
- Inner housing adjusts for ceilings up to 1" thick

Plaster Frame

- Plaster frame includes locking screw for hanger bars and cutouts for crimping hanger bars in position
- Air-Tite gasket is pre-installed

Junction Box

- Positioned to accommodate straight conduit runs
- Seven conduit knockouts are uniform 1/2" size with true pry-out slots
- Four pry-outs with integral strain relief simplify non-metallic (NM) sheathed cable installation
- Three quick connect wire connectors included

Includes:

- All-Nail!™ bar hangers (Details Pg. 15)
- Quick Connect™ push wire nuts (Details Pg. 11)
- Air-Tite™ code compliant (Details Pg. 11)

Socket

Adjustable position bracket with porcelain socket and nickel plated brass screw shell provides flexibility in lamp positioning

Thermal Protector

Self resetting thermal protector deactivates fixture if overheating occurs due to improper lamping or misapplied insulation

Trims

Halo Fit-All concept offers multiple trim options in a variety of design styles, and functional beam distributions to control beam angle and lumen delivery in accommodating various lamp types

Compliance

- cULus Listed 1598 luminaire
- cULus Listed damp location
- cULus Listed for wet location, covered ceiling, with select trims
- cULus Listed for direct contact with insulation and combustible material*
- RoHS compliant
- Air-Tite code compliant. Certified under ASTM E283; not exceeding 2.0 cfm (0.944 L/s) air leakage rate tested at a 1.57 psf (75 Pa) pressure differential

*Not to be used in direct contact with spray foam insulation (consult NEMA LSD57-2013)

Reflectors

999 Precision Metal Reflector

- Precision die cast metal trim ring with metal reflector
- For general down lighting
- Friction clip retention

Housings	Max Lamp Compatibility
H99ICAT	40W A19, 50W PAR20, 40W R16, 50W R20
E4ICATSB	40W A19, 50W PAR20, 40W R16, 30 R20

Compatible with Halogen, Incandescent, LED* or CFL* lamps



999MB
Specular Black Reflector,
White Trim



999RG
Residential Gold Reflector,
White Trim



999P
Specular Clear Reflector,
White Trim



999W
White Reflector, White Trim



999H
Haze Reflector, White Trim



999SN
Satin Nickel Reflector,
Satin Nickel Trim



999TBZ
Tuscan Bronze Reflector,
Tuscan Bronze Trim

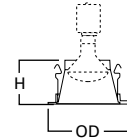

Dimensions**
H: 2-5/8" [67mm]
OD: 5" [129mm]

4003 Reflector

- Specular clear reflector
- Formed metal trim ring
- Friction clip retention

Housings	Max Lamp Compatibility
H99ICAT	40W A19, 35W PAR20, 50W PAR20, 40W R16, 50W R20
E4ICATSB	40W A19, 35W PAR20, 30W R20, 40W R16

Compatible with Halogen, Incandescent, LED* or CFL* lamps



4003
Specular Reflector, White Trim

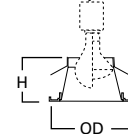

Dimensions**
H: 2-1/2" [63mm]
OD: 5" [129mm]

Baffles

953 Precision Metal Baffle

- Precision die cast metal trim ring with metal baffle
- For general down lighting
- Friction clip retention

Housings	Max Lamp Compatibility
H99ICAT	35W PAR20, 30W R20, (50W PAR20 with H1999 Socket Extender)
E4ICATSB	50W PAR20

Compatible with Halogen, Incandescent, LED* or CFL* lamps



953W
White Baffle, White Trim



953P
Black Baffle, White Trim



953SN
Satin Nickel Baffle,
Satin Nickel Trim



953TBZ
Tuscan Bronze Baffle,
Tuscan Bronze Trim

Accessory - H1999 (H99ICAT Only)



Socket Extender

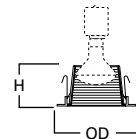

Dimensions**
H: 2-1/2" [63mm]
OD: 5" [129mm]

993 Coilex® Baffle

- Coilex® phenolic baffle
- Precision die cast metal trim ring
- For general down lighting
- Friction clip retention

Housings	Max Lamp Compatibility
H99ICAT	35W PAR20, 30W R20, (50W PAR20, 50W R20 with H1999 Socket Extender)
E4ICATSB	35W PAR20, 30W R20

Compatible with Halogen, Incandescent, LED* or CFL* lamps



993W
White Baffle, White Trim



993P
Black Baffle, White Trim



993SN
Black Baffle, Satin Nickel Trim



993TBZ
Black Baffle, Tuscan Bronze Trim

Accessory - H1999 (H99ICAT Only)



Socket Extender

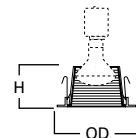

Dimensions**
H: 2-1/2" [63mm]
OD: 5" [129mm]

*UL1993 listed LED & CFL equivalent lamps permitted. Consult lamp manufacturer for conditions of use. Eaton does not warranty the lamp.

**Key: A: Luminous Aperture, H: Height, OD: Trim Outside Diameter

E26 Screw Base Trims

IC Housings: H99ICAT • E4ICATSB

4001 Plastic Baffle

- Step plastic baffle
- Formed metal trim ring
- Friction clip retention

Housings	Max Lamp Compatibility
H99ICAT	35W PAR20, 50W R20, (50W PAR20, 50W R20 with H1999 Socket Extender)
E4ICATSB	35W PAR20, 30W R20

Compatible with Halogen, Incandescent, LED* or CFL* lamps



4001WB White Baffle, White Trim **4001BB** Black Baffle, White Trim

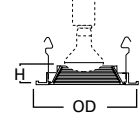

Dimensions**
H: 1-1/8" [28mm]
OD: 5" [129mm]

Accessory - H1999 (H99ICAT Only)



4010 Metal Baffle

- Metal baffle
- Formed metal trim ring
- Friction clip retention

Housings	Max Lamp Compatibility
H99ICAT	35W PAR20, 30W R20, (50W PAR20 with H1999 Socket Extender)
E4ICATSB	50W PAR20, 30W R20, 35W PAR20

Compatible with Halogen, Incandescent, LED* or CFL* lamps



4010WB White Baffle, White Trim **4010BB** Black Baffle, White Trim

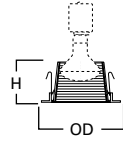

Dimensions**
H: 2-5/8" [67mm]
OD: 5" [129mm]

4013 Full Cone Metal Baffle, Self-flange

- Self-flange metal baffle
- Friction clip retention
- For use with H99 series housings only

Housings	Max Lamp Compatibility
H99ICAT	4013WB: 40W A19, 50W R20, 50W PAR20 4013BB: 45W R20, 50W PAR20

Compatible with Halogen, Incandescent, LED* or CFL* lamps



4013WB White Baffle, White Trim **4013BB** Black Baffle, White Trim

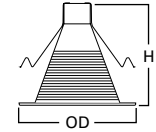

Dimensions**
H: 4-1/2" [114mm]
OD: 5" [129mm]

Adjustable – Eyeballs & Gimbals

996 Adjustable Eyeball – 15° Tilt

- Adjustable eyeball for use with PAR20 lamps only
- 15° tilt, 360° rotation
- Precision die metal cast trim ring
- Friction clip retention

Housings	Max Lamp Compatibility
H99ICAT	50W PAR20
E4ICATSB	

Compatible with Halogen, Incandescent, LED* or CFL* lamps



996P White Eyeball, White Trim **996SN** Satin Nickel Eyeball, Satin Nickel Trim **996TBZ** Tuscan Bronze Eyeball, Tuscan Bronze Trim

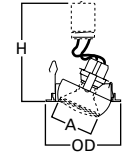

Dimensions**
A: 3-3/4" [94mm]
H: 3-1/2" [88mm]
OD: 5" [129mm]

998 Adjustable Eyeball – 30° Tilt

- Adjustable eyeball for PAR16 and R16 lamps only
- 30° tilt, 360° rotation
- Precision die metal cast trim ring
- Friction clip retention

Housings	Max Lamp Compatibility
H99ICAT	40W R16
E4ICATSB	40W R16, 45W PAR16

Compatible with Halogen, Incandescent, LED* or CFL* lamps



998P White Eyeball, White Trim **998SN** Satin Nickel Eyeball, Satin Nickel Trim **998TBZ** Tuscan Bronze Eyeball, Tuscan Bronze Trim

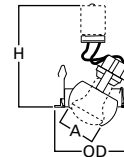

Dimensions**
A: 2-1/4" [56mm]
H: 3-1/4" [83mm]
OD: 5" [129mm]

*UL1993 listed LED & CFL equivalent lamps permitted. Consult lamp manufacturer for conditions of use. Eaton does not warranty the lamp.

**Key: A: Luminous Aperture, H: Height, OD: Trim Outside Diameter

4002 White Eyeball – 30° Tilt

- Adjustable eyeball for R16 and PAR16 lamps only
- Formed metal trim ring
- Friction clip retention



4002
White Eyeball, White Trim

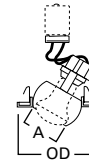

Dimensions**
A: 2-1/8" [54mm]
OD: 5" [129mm]

Housings	Max Lamp Compatibility
H99ICAT	40W R16
E4ICATSB	40W R16, 45W PAR16

Compatible with Halogen, Incandescent, LED* or CFL* lamps

Lenses & Wet Location Showerlights

951 Prismatic Glass Lens with Full Cone Reflector

- Wet location listed for use as Showerlight
- Non-conductive, non-corrosive polymer trim
- Prismatic glass lens
- Full reflector for greatest light distribution
- Friction clip retention
- For use with H99 series housings only
- Shower trim front is non-electrically conductive "dead-front"



951PS
Full Reflector and Glass Lens,
White Trim



951SNS
Full Reflector and Glass Lens,
Satin Nickel Trim



951TBZS
Full Reflector and Glass Lens,
Tuscan Bronze Trim

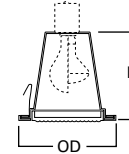

Dimensions**
H: 4-1/2" [114mm]
OD: 5" [129mm]

Housings	Max Lamp Compatibility
H99ICAT	35W PAR20, 30W R20, (50W PAR20 with H1999 Socket Extender)

Compatible with Halogen, Incandescent, LED* or CFL* lamps



Socket Extender

952 Frosted Dome Lens with Cut-Cone Reflector

- Wet location listed for use as Showerlight
- Frosted glass dome shower light
- Non conductive, non corrosive polymer trim ring
- High wall coverage in showers and baths from dome lens
- Friction clip retention
- Shower trim front is non-electrically conductive "dead-front"



952PS
Dome Lens, White Trim

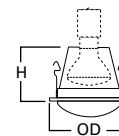

Dimensions**
H: 2-5/8" [66mm]
OD: 5" [129mm]

Housings	Max Lamp Compatibility
H99ICAT	35W PAR20, 30W R20, (50W PAR20 with H1999 Socket Extender)
E4ICATSB	35W PAR20, 30W R20

Compatible with Halogen, Incandescent, LED* or CFL* lamps



Socket Extender

4055 Prismatic Glass Lens with Cut-Cone Reflector

- Wet location listed for use as Showerlight
- Prismatic glass lens
- Friction clip retention
- Non conductive, non corrosive polymer trim ring
- Shower trim front is non-electrically conductive "dead-front"



4055
Flat Glass Lens, White Trim

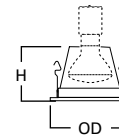

Dimensions**
H: 2-5/8" [67mm]
OD: 5" [129mm]

Housings	Max Lamp Compatibility
H99ICAT	30W R20, 35W PAR20
E4ICATSB	

Compatible with Halogen, Incandescent, LED* or CFL* lamps

945 Metropolitan Ice Light

- Frosted glass trim in natural or blue
- For general down lighting
- Friction clip retention



945
Frosted Glass



945B
Frosted Blue Glass

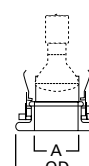

Dimensions**
H: 2-1/8" [54mm]
OD: 5" [129mm]

Housings	Max Lamp Compatibility
H99ICAT	30W R20
E4ICATSB	35W PAR20, 30W R20

Compatible with Halogen, Incandescent, LED* or CFL* lamps

*UL1993 listed LED & CFL equivalent lamps permitted. Consult lamp manufacturer for conditions of use. Eaton does not warranty the lamp.

**Key: A: Luminous Aperture, H: Height, OD: Trim Outside Diameter

E26 Screw Base Non-IC Housing

H99TAT

4
INCH

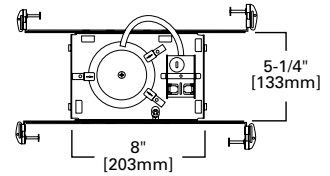
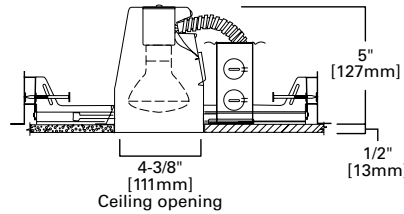

H99TAT

4" Non-IC, Air-Tite, Shallow New Construction Housing, 120V

The H99TAT is a Non-IC Air-Tite™ housing for providing accent, task, and general lighting. The H99T is designed for use in non-insulated ceiling but if insulation is present it MUST be kept 3" from all sides of the housing. Non-IC housing is Air-Tite™ code compliant. May be retrofit with compatible Halo LED lighting systems.



Special Features

- Got Nail!™ bar hangers
- Pass-N-Thru™ bars
- Slide-N-Side™ junction box
- Quick Connect™ push wire nuts
- Air-Tite™ code compliant

Compatible Trims

945	990	996	999	4002	4013
951	992	998	4001	4003	4055
953	993				

Features

Housing

- Formed of CRS with white powder coat finish.
- Housing adjusts for ceilings up to 1" thick

Plaster Frame

Galvanized steel construction. The housing can be removed from plaster frame to provide access to the junction box. Plaster frame features include:

- Patented regressed locking screw positioned for securing hanger bars from below the ceiling
- Cutouts for easily crimping hanger bars in position
- Halo name embossed on plaster frame

Includes:

- Got Nail!™ bar hangers (Details Pg. 11)
- Pass-N-Thru™ bars (Details Pg. 11)
- Slide-N-Side™ junction box wire traps (Details Pg. 11)
- Quick Connect™ push wire nuts (Details Pg. 11)
- Air-Tite™ code compliant (Details Pg. 11)

Socket

Fixed position porcelain socket with nickel plated brass screw shell provides consistent lamp positioning

Thermal Protector

Self resetting thermal protector deactivates fixture if overheating occurs due to improper lamping or misapplied insulation

Trims

Halo Fit-All concept offers multiple trim options in a variety of design styles, and functional beam distributions to control beam angle and lumen delivery in accommodating various lamp types including Halogen, CFL and LED

Compliance

- cULus Listed 1598 luminaire
- cULus Listed damp location
- cULus Listed for wet location, covered ceiling, with select trims
- cULus Listed for feed through
- RoHS compliant
- Air-Tite code compliant. Certified under ASTM E283; not exceeding 2.0 cfm (0.944 L/s) air leakage rate tested at a 1.57 psf (75 Pa) pressure differential
- IP rated (Improper Lamp)

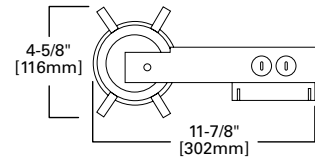
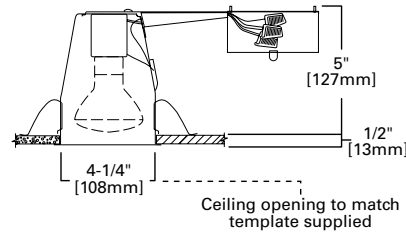

H99RTAT

4" Non-IC, Shallow Remodel Housing, 120V

The H99RTAT is a Non-IC Air-Tite™ housing for providing accent, task, and general lighting. The H99RTAT is designed for use in non-insulated existing ceilings. Non-IC housing is Air-Tite™ code compliant. If insulation is present it must be kept 3 inches away from all sides of housing. For installation from below the ceiling. May be retrofit with compatible Halo LED lighting systems.



Special Features

Quick Connect™ push wire nuts
Air-Tite™ code compliant

Compatible Trims

945	953	993	4001	4013
951	990	998	4002	4055
952	992	999	4003	

Features

Housing

- Formed of CRS with white powder coat finish
- For installation from below the finished ceiling

Remodel Clips

Four remodel clips secure housing and accommodates 1/2" and 5/8" ceiling materials

Junction Box

- Seven 1/2" trade size conduit knockouts with true pry-out slots
- Four pry-outs with integral strain relief for non-metallic (NM) sheathed cable

Includes:

- Quick Connect™ push wire nuts (Details Pg. 11)
- Air-Tite™ code compliant (Details Pg. 11)

Socket

Fixed position porcelain socket with nickel plated brass screw shell provides consistent lamp positioning

Thermal Protector

Self resetting thermal protector deactivates fixture if overheating occurs due to improper lamping or misapplied insulation

Trims

Halo Fit-All concept offers multiple trim options in a variety of design styles, and functional beam distributions to control beam angle and lumen delivery in accommodating various lamp types including Halogen, CFL and LED

Compliance

- cULus Listed 1598 luminaire
- cULus Listed damp location
- cULus Listed for wet location, covered ceiling, with select trims
- Air-Tite code compliant. Certified under ASTM E283; not exceeding 2.0 cfm (0.944 L/s) air leakage rate tested at a 1.57 psf (75 Pa) pressure differential
- RoHS compliant
- IP rated (Improper Lamp)

E26 Screw Base Non-IC Housing

E4TATSB

4
INCH

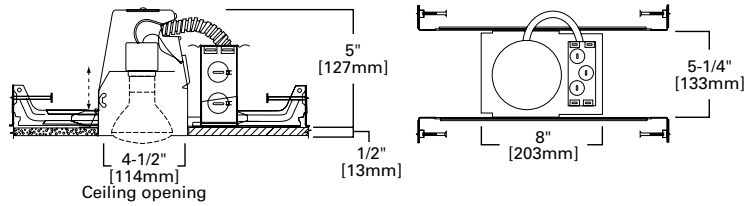

E4TATSB

4" Non-IC, Air-Tite, Shallow New Construction Housing, 120V

The E4TATSB is a Non-IC Air-Tite™ housing optimized and listed for EISA compliant tungsten-halogen lamps, CFL and LED lamps, as well as incandescent. Housing features an adjustable socket bracket, and is suitable for residential or commercial applications. Installation in non-insulated ceilings with Air-Tite code compliant construction. If insulation is present it must be kept 3" from all sides of the housing. May be retrofit with compatible Halo LED lighting systems.



Special Features

- All-Nail!™ bar hangers
- Quick Connect™ push wire nuts
- Air-Tite™ code compliant

Compatible Trims

945	992	996	999	4002	4010
953	993	998	4001	4003	4055
990					

Features

Housing

- Die-formed CRS with gray powder coat finish

Junction Box

- Seven conduit knockouts are uniform 1/2" size with true pry-out slots
- Four pry-outs with integral strain relief simplify non-metallic (NM) sheathed cable installation
- Three quick connect wire connectors included

Plaster Frame

- Housing is secured in plaster frame with spring barbs
- The housing can be removed from the plaster frame to provide access to the junction box

Includes:

- All-Nail!™ bar hangers (Details Pg. 15)
- Quick Connect™ push wire nuts (Details Pg. 11)
- Air-Tite™ code compliant (Details Pg. 11)

Socket

Adjustable position bracket with porcelain socket and nickel plated brass screw shell provides flexibility in lamp positioning

Thermal Protector

Self resetting thermal protector deactivates fixture if overheating occurs due to improper lamping or misapplied insulation

Trims

Halo Fit-All concept offers multiple trim options in a variety of design styles, and functional beam distributions to control beam angle and lumen delivery in accommodating various lamp types

Compliance

- cULus Listed 1598 luminaire
- cULus Listed damp location
- cULus Listed for wet location, covered ceiling, with select trims
- RoHS compliant
- Air-Tite code compliant. Certified under ASTM E283; not exceeding 2.0 cfm (0.944 L/s) air leakage rate tested at a 1.57 psf (75 Pa) pressure differential

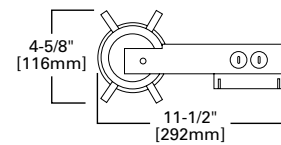
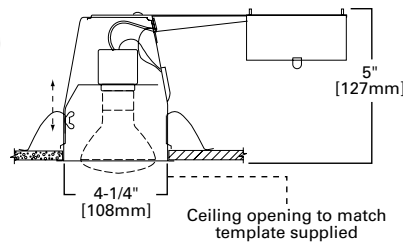

E4RTATSB

4" Non-IC, Air-Tite, Shallow Remodel Housing, 120V

The E4RTATSB is a remodel Non-IC Air-Tite™ housing optimized and listed for EISA compliant tungsten-halogen lamps, CFL and LED lamps as well as incandescent. Housing features an adjustable socket bracket, and is suitable for residential or commercial applications. Installation in non-insulated ceilings with Air-Tite code compliant construction. If insulation is present it must be kept 3" from all sides of the housing. May be retrofit with compatible Halo LED lighting systems.



Special Features

- Quick Connect™ push wire nuts
- Air-Tite™ code compliant

Compatible Trims

945	990	998	4002	4010
952	992	999	4003	4055
953	993	4001		

Features

Housing

- Die-formed CRS with gray powder coat finish
- For installation from below the finished ceiling

Remodel Clips

Four remodel clips secure housing and accommodates 1/2" and 5/8" ceiling materials

Junction Box

- Seven conduit knockouts are uniform 1/2" size with true pry-out slots
- Four pry-outs with integral strain relief simplify non-metallic (NM) sheathed cable installation
- Three quick connect wire connectors included

Includes:

- Quick Connect™ push wire nuts (Details Pg. 11)
- Air-Tite™ code compliant (Details Pg. 11)

Socket

Adjustable position porcelain socket with nickel plated brass screw shell provides flexibility in lamp positioning

Thermal Protector

Self resetting thermal protector deactivates fixture if overheating occurs due to improper lamping or misapplied insulation

Trims

Halo Fit-All concept offers multiple trim options in a variety of design styles, and functional beam distributions to control beam angle and lumen delivery in accommodating various lamp types

Compliance

- cULus Listed 1598 luminaire
- cULus Listed for damp location
- cULus Listed for wet location, with select trims
- RoHS compliant
- Air-Tite code compliant. Certified under ASTM E283; not exceeding 2.0 cfm (0.944 L/s) air leakage rate tested at a 1.57 psf (75 Pa) pressure differential

E26 Screw Base Trims

Non-IC Housings: H99TAT • H99RTAT • E4TATSB • E4RTATSB

4
INCH

Reflectors

999 Precision Metal Reflector

- Precision die cast metal trim ring with metal reflector
- For general down lighting
- Friction clip retention

Housings	Max Lamp Compatibility
H99TAT	40W R16, 50W R20, 50W PAR20
H99RTAT	
E4TATSB	40W R16, 50W R20
E4RTATSB	40W R16, 50W R20, 50W PAR20

Compatible with Halogen, Incandescent, LED* or CFL* lamps



999MB
Specular Black Reflector,
White Trim



999RG
Residential Gold Reflector,
White Trim



999P
Specular Clear Reflector,
White Trim



999W
White Reflector, White Trim



999H
Haze Reflector, White Trim



999SN
Satin Nickel Reflector,
Satin Nickel Trim



999TBZ
Tuscan Bronze Reflector,
Tuscan Bronze Trim

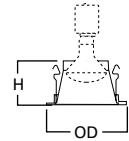

Dimensions**
H: 2-5/8" [67mm]
OD: 5" [129mm]

4003 Reflector

- Specular clear reflector
- Formed metal trim ring
- Friction clip retention

Housings	Max Lamp Compatibility
H99TAT	40W A19, 50W PAR20,
H99RTAT	40W R16, 50W R20
E4TATSB	40W A19, 40W R16, 50W R20
E4RTATSB	40W A19, 50W PAR20, 40W R16, 50W R20

Compatible with Halogen, Incandescent, LED* or CFL* lamps



4003
Specular Reflector, White Trim

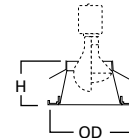

Dimensions**
H: 2-1/2" [63mm]
OD: 5" [127mm]

Baffles

953 Precision Metal Baffle

- Precision die cast metal trim ring with metal baffle
- For general down lighting
- Friction clip retention

Housings	Max Lamp Compatibility
H99TAT	50W PAR20, 40W R16, 50W R20
H99RTAT	
E4TATSB	40W R16, 50W R20
E4RTATSB	50W PAR20, 40W R16, 50W R20

Compatible with Halogen, Incandescent, LED* or CFL* lamps



953W
White Baffle, White Trim



953P
Black Baffle, White Trim



953SN
Satin Nickel Baffle,
Satin Nickel Trim



953TBZ
Tuscan Bronze Baffle,
Tuscan Bronze Trim

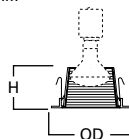

Dimensions**
H: 2-1/2" [63mm]
OD: 5" [129mm]

990 Pinhole Trim

- Precision die cast metal trim ring
- Pinhole aperture for accent lighting
- Friction clip retention

Housings	Max Lamp Compatibility
H99TAT	40W A19, 50W PAR20,
H99RTAT	40W R16, 50W R20
E4TATSB	40W A19, 50W PAR20, 50W R20
E4RTATSB	40W A19, 50W PAR20

Compatible with Halogen, Incandescent, LED* or CFL* lamps



990P
White Pinhole Trim



990SN
Satin Nickel Pinhole Trim



990TBZ
Tuscan Bronze Pinhole Trim

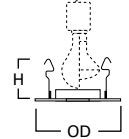

Dimensions**
H: 1-3/4" [44mm]
OD: 5" [129mm]

*UL1993 listed LED & CFL equivalent lamps permitted. Consult lamp manufacturer for conditions of use. Eaton does not warranty the lamp.

**Key: A: Luminous Aperture, H: Height, OD: Trim Outside Diameter

Specifications, compliances and dimensions subject to change without notice

4 INCH

E26 Screw Base Trims

Non-IC Housings: H99TAT • H99RTAT • E4TATSB • E4RTATSB

992 Wall Wash with Coilex® Baffle

- Eyelid wall wash
- Coilex® phenolic baffle
- Precision die metal cast trim ring
- 360° rotation in housing allows trim to be aimed at wall
- Friction clip retention



992W
White Eyelid and Baffle,
White Trim



992P
White Eyelid, Black Baffle,
White Trim



992SN
Satin Nickel Eyelid, Black
Baffle, Satin Nickel Trim



992TBZ
Tuscan Bronze Eyelid, Black
Baffle, Tuscan Bronze Trim

Housings Max Lamp Compatibility

H99TAT	40W A19, 40W R16, 50W R20
H99RTAT	40W A19, 50W PAR20, 40W R16, 50W R20
E4TATSB	40W A19, 50W PAR20
E4RTATSB	50W PAR20

Compatible with Halogen, Incandescent, LED* or CFL* lamps

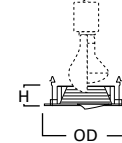

Dimensions**

H: 1-1/4" [32mm]
OD: 5" [129mm]

993 Coilex® Baffle

- Precision die cast metal trim ring with Coilex® phenolic baffle
- For general down lighting
- Friction clip retention



993W
White Baffle, White Trim



993P
Black Baffle, White Trim



993SN
Black Baffle, Satin Nickel Trim



993TBZ
Black Baffle, Tuscan Bronze Trim

Housings Max Lamp Compatibility

H99TAT	
H99RTAT	50W PAR20, 40W R16, 50W R20
E4TATSB	
E4RTATSB	

Compatible with Halogen, Incandescent, LED* or CFL* lamps

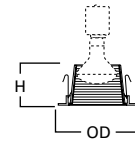

Dimensions**

H: 2-1/2" [63mm]
OD: 5" [129mm]

4001 Plastic Baffle

- Step plastic baffle
- Formed metal trim ring
- Friction clip retention



4001WB
White Baffle, White Trim



4001BB
Black Baffle, White Trim

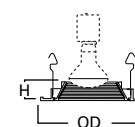

Dimensions**

H: 1-1/8" [28mm]
OD: 5" [129mm]

Housings Max Lamp Compatibility

H99TAT	50W PAR20, 50W R20
H99RTAT	
E4TATSB	50W PAR20, 40W R16, 50W R20
E4RTATSB	

Compatible with Halogen, Incandescent, LED* or CFL* lamps

4010 Metal Baffle

- Metal baffle
- Friction clip retention
- Formed metal trim ring



4010WB
White Baffle, White Trim



4010BB
Black Baffle, White Trim

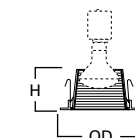

Dimensions**

H: 2-5/8" [67mm]
OD: 5" [129mm]

Housings Max Lamp Compatibility

E4TATSB	50W PAR20, 40W R16, 50W R20
E4RTATSB	

Compatible with Halogen, Incandescent, LED* or CFL* lamps

*UL1993 listed LED & CFL equivalent lamps permitted. Consult lamp manufacturer for conditions of use. Eaton does not warranty the lamp.

**Key: A: Luminous Aperture, H: Height, OD: Trim Outside Diameter

E26 Screw Base Trims

Non-IC Housings: H99TAT • H99RTAT • E4TATSB • E4RTATSB

4013 Full Cone Metal Baffle, Self-flange

- Self-flange metal baffle
- Friction clip retention
- For use with H99 series housings only

Housings	Max Lamp Compatibility
H99TAT	4013WB: 40W A19, 50W PAR20, 50W R20
H99RTAT	4013BB: 50W PAR20, 45W R20

Compatible with Halogen, Incandescent, LED* or CFL* lamps



4013WB
White Baffle, White Trim



4013BB
Black Baffle, White Trim

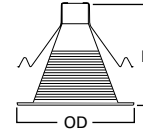

Dimensions**
H: 4-1/2" [114mm]
OD: 5" [129mm]

Adjustable – Eyeballs & Gimbals

996 Adjustable Eyeball – 15° Tilt

- Adjustable eyeball for use with PAR20 lamps only
- 15° tilt, 360° rotation
- Precision die metal cast trim ring
- Friction clip retention

Housings	Max Lamp Compatibility
H99TAT	50W PAR20
E4TATSB	

Compatible with Halogen, Incandescent, LED* or CFL* lamps



996P
White Eyeball, White Trim



996SN
Satin Nickel Eyeball,
Satin Nickel Trim



996TBZ
Tuscan Bronze Eyeball,
Tuscan Bronze Trim

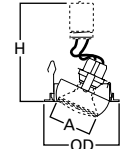

Dimensions**
A: 3-3/4" [94mm]
H: 3-1/2" [88mm]
OD: 5" [129mm]

998 Adjustable Eyeball – 30° Tilt

- Adjustable eyeball for PAR16 and R16 lamps only
- 30° tilt, 360° rotation
- Precision die metal cast trim ring
- Friction clip retention

Housings	Max Lamp Compatibility
H99TAT	40W R16, 60W PAR16
H99RTAT	
E4TATSB	
E4RTATSB	

Compatible with Halogen, Incandescent, LED* or CFL* lamps



998P
White Eyeball, White Trim



998SN
Satin Nickel Eyeball,
Satin Nickel Trim



998TBZ
Tuscan Bronze Eyeball,
Tuscan Bronze Trim

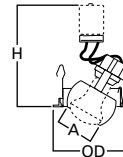

Dimensions**
A: 2-1/4" [56mm]
H: 3-1/4" [83mm]
OD: 5" [129mm]

4002 White Eyeball – 30° Tilt

- Formed metal trim ring
- Adjustable eyeball trim for R16 and PAR16 lamps only
- Friction clip retention

Housings	Max Lamp Compatibility
H99TAT	45W PAR16, 40W R16
H99RTAT	
E4TATSB	
E4RTATSB	

Compatible with Halogen, Incandescent, LED* or CFL* lamps



4002
White Eyeball, White Trim



Dimensions**
A: 2-1/8" [54mm]
OD: 5" [127mm]

*UL1993 listed LED & CFL equivalent lamps permitted. Consult lamp manufacturer for conditions of use. Eaton does not warranty the lamp.

**Key: A: Luminous Aperture, H: Height, OD: Trim Outside Diameter

Lenses & Wet Location Showerlights

951 Prismatic Glass Lens with Full Cone Reflector



- Wet location listed for use as Showerlight
- Non-conductive, non-corrosive polymer trim
- Prismatic glass lens
- Full reflector for greatest light distribution
- Friction clip retention
- For use with H99 series housings only
- Shower trim front is non-electrically conductive "dead-front"



951PS
Full Reflector and Glass
Lens, White Trim



951SNS
Full Reflector and Glass
Lens, Satin Nickel Trim



951TBZS
Full Reflector and Glass Lens,
Tuscan Bronze Trim

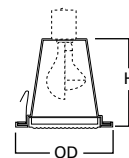

Dimensions**
H: 4-1/2" [114mm]
OD: 5" [129mm]

Housings Max Lamp Compatibility

H99TAT _____
H99RTAT _____ 40W A19, 50W R20, 50W PAR20

Compatible with Halogen, Incandescent, LED* or CFL* lamps

952 Frosted Dome Lens with Cut-Cone Reflector



- Frosted glass dome Showerlight
- Wet location listed
- Non conductive, non corrosive polymer trim ring
- High wall coverage in showers and baths from dome lens
- Friction clip retention
- Shower trim front is non-electrically conductive "dead-front"



952PS
Dome Lens, White Trim

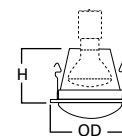

Dimensions**
H: 2-5/8" [66mm]
OD: 5" [129mm]

Housings Max Lamp Compatibility

H99TAT _____
H99RTAT _____ 40W A19, 50W R20, 50W PAR20

E4TATSB _____

E4RTATSB _____

Compatible with Halogen, Incandescent, LED* or CFL* lamps

4055 Prismatic Glass Lens with Cut-Cone Reflector



- Lens wet location trim
- Friction clip retention
- Shower trim front is non-electrically conductive "dead-front"



4055
Flat Glass Lens, White Trim

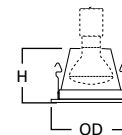

Dimensions**
H: 2-5/8" [67mm]
OD: 5" [129mm]

Housings Max Lamp Compatibility

H99TAT _____
H99RTAT _____ 40W A19, 50W PAR20, 50W R20

E4TATSB _____

E4RTATSB _____

Compatible with Halogen, Incandescent, LED* or CFL* lamps

945 Metropolitan Ice Light

- Frosted glass trim in natural or blue
- For general down lighting
- Friction clip retention



945
Frosted Glass



945B
Frosted Blue Glass

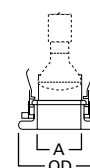

Dimensions**
H: 2-1/8" [54mm]
OD: 5" [129mm]

Housings Max Lamp Compatibility

H99TAT _____
H99RTAT _____ 50W PAR20, 50W R20

E4TATSB _____

E4RTATSB _____ 50W PAR20

Compatible with Halogen, Incandescent, LED* or CFL* lamps

*UL1993 listed LED & CFL equivalent lamps permitted. Consult lamp manufacturer for conditions of use. Eaton does not warranty the lamp.

**Key: A: Luminous Aperture, H: Height, OD: Trim Outside Diameter

Low Voltage MR16 IC Housing

H1499ICAT

4
INCH

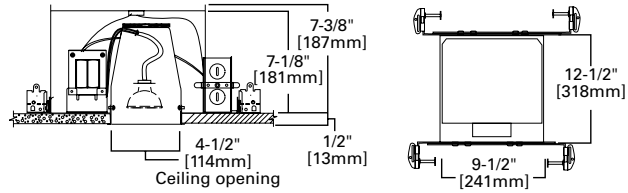

H1499ICAT

4" IC, Air-Tite, New Construction, 120V – 12V Low Voltage, MR16

H1499ICAT housing features an integral low voltage magnetic transformer that supplies 12 volts to MR16 lamps. The H1499ICAT is for installations where the housing will be in direct contact with insulation*. Air-Tite™ housing designed to restrict air flow between conditioned spaces and unconditioned areas.



Special Features

- Got Nail!™ bar hangers
- Pass-N-Thru™ bars
- Slide-N-Side™ junction box
- Quick Connect™ push wire nuts
- Air-Tite™ code compliant

Compatible Trims

1419	1421	1493	1496	1498	1946
1420	1453	1495	1497	1945	1951

Features

Housing

- Double wall aluminum construction for greater heat dissipation
- Designed for insulated ceilings in direct contact with insulation* (May also be installed in non-insulated ceilings)

Plaster Frame

- Galvanized steel die-formed construction
- The inner housing can be removed from plaster frame to provide access to the junction box
- Plaster frame features include:
 - Regressed locking screw positioned for securing hanger bars from below the ceiling
 - Cutouts for easily crimping hanger bars in position
 - Air-Tite aperture gasket is pre-installed
 - Halo identity embossed on plaster frame

Includes:

- Got Nail!™ bar hangers (Details Pg. 11)
- Pass-N-Thru™ bars (Details Pg. 11)
- Slide-N-Side™ junction box wire traps (Details Pg. 11)
- Quick Connect™ push wire nuts (Details Pg. 11)
- Air-Tite™ code compliant (Details Pg. 11)

Socket

GU5.3 socket with reflector plate for bi-pin 12V MR16 lamps

Thermal Protector

Self resetting thermal protector deactivates fixture if overheating occurs due to improper lamping

Transformer

Integral 120V magnetic transformer steps line voltage down to 12V lamp operating voltage. For MR16 lamps up to 50W.

Compliance

- cULus Listed 1598 luminaire
- cULus Listed damp location
- cULus Listed for wet location, covered ceiling, with select trims
- cULus Listed for feed through
- cULus Listed for direct contact with insulation* and combustible material
- Air-Tite code compliant. Certified under ASTM E283; not exceeding 2.0 cfm (0.944 L/s) air leakage rate tested at a 1.57 psf (75 Pa) pressure differential

*Not to be used in direct contact with spray foam insulation (consult NEMA LSD57-2013)

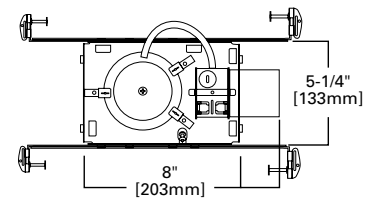
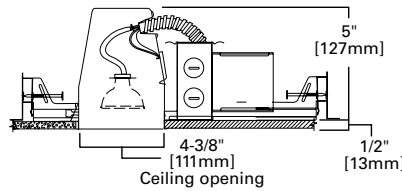

H1499TAT

4" Non-IC, Air-Tite, Shallow New Construction, 120 – 12V Low Voltage, MR16

H1499TAT is a Non-IC Air-Tite™ housing with an integral low voltage magnetic transformer that supplies 12 volts to MR16 lamps. The H1499TAT is designed for use in non-insulated ceilings. If insulation is present it must be kept 3 inches away from all sides of housing. Non-IC housing is Air-Tite™ to meet restricted airflow code requirements.



Special Features

- Got Nail!™ bar hangers
- Pass-N-Thru™ bars
- Slide-N-Side™ junction box
- Quick Connect™ push wire nuts
- Air-Tite™ code compliant

Compatible Trims

1419	1421	1493	1496	1498	1946
1420	1453	1495	1497	1945	1951

Features

Housing

Formed of CRS with white powder coat finish

Plaster Frame

- Galvanized steel die-formed construction
- The housing can be removed from plaster frame to provide access to the junction box
- Plaster frame features include:
 - Regressed locking screw positioned for securing hanger bars from below the ceiling
 - Cutouts for easily crimping hanger bars in position
 - Halo identity embossed on plaster frame

Includes:

- Got Nail!™ bar hangers (Details Pg. 11)
- Pass-N-Thru™ bars (Details Pg. 11)
- Slide-N-Side™ junction box wire traps (Details Pg. 11)
- Quick Connect™ push wire nuts (Details Pg. 11)
- Air-Tite™ code compliant (Details Pg. 11)

Socket

GU5.3 socket with reflector plate for bi-pin 12V MR16 lamps

Transformer

Integral 120V magnetic transformer steps line voltage down to 12V lamp operating voltage. For MR16 lamps up to 50W.

Thermal Protector

Self resetting thermal protector deactivates fixture if overheating occurs due to improper lamping or misapplied insulation

Compliance

- cULus Listed 1598 luminaire
- cULus Listed damp location
- cULus Listed for wet location, covered ceiling, with select trims
- cULus Listed for feed through
- Air-Tite code compliant. Certified under ASTM E283; not exceeding 2.0 cfm (0.944 L/s) air leakage rate tested at a 1.57 psf (75 Pa) pressure differential
- IP rated (Improper Lamp)

Low Voltage MR16 Non-IC Housing

H1499TCP

4
INCH

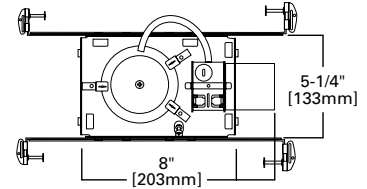
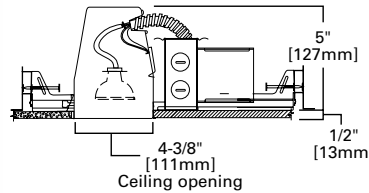

H1499TCP

4" Non-IC, New Construction, 120V/277V – 12V Low Voltage, MR16, Chicago Plenum

H1499TCP is a Non-IC housing designed for non-insulated Chicago Plenum rated ceilings. H1499TCP features an integral low voltage dual-tap 120V/277V transformer that supplies 12 volts to MR16 lamps. H1499TCP is for non-insulated ceilings. If installed in insulated ceilings, insulation must be kept 3 inches away from all sides of housing.



Special Features

- Got Nail!™ bar hangers
- Pass-N-Thru™ bars
- Quick Connect™ push wire nuts

Compatible Trims

1419	1421	1493	1496	1498	1946
1420	1453	1495	1497	1945	1951

Features

Housing

Formed of CRS with white powder coat finish

Plaster Frame

- Galvanized steel die-formed construction
- The housing can be removed from plaster frame to provide access to the junction box
- Plaster frame features include:
 - Regressed locking screw positioned for securing hanger bars from below the ceiling
 - Cutouts for easily crimping hanger bars in position
 - Halo identity embossed on plaster frame

Junction Box:

- Positioned to accommodate straight conduit runs
- Six 1/2" trade size conduit knockouts
- Gasketed junction box per Chicago Plenum standards

Includes:

- Got Nail!™ bar hangers (Details Pg. 11)
- Pass-N-Thru™ bars (Details Pg. 11)
- Quick Connect™ push wire nuts (Details Pg. 11)
- Chicago Plenum

Transformer

Integral 120/277V dual-tap magnetic transformer steps line voltage down to 12V nominal lamp operating voltage. Rated for 50W max. Housing ships as 277V model with 120V transformer wire lead capped. For use in 120V systems, simply cap the 277V wire lead and use 120V lead (refer to wiring diagram).

Socket

GU5.3 socket with reflector plate for bi-pin 12V MR16 lamps

Thermal Protector

Self resetting thermal protector deactivates fixture if overheating occurs due to improper lamping

Compliance

- cULus Listed damp location
- cULus Listed for wet location, covered ceiling, with select trims
- cULus Listed for feed through
- City of Chicago Plenum

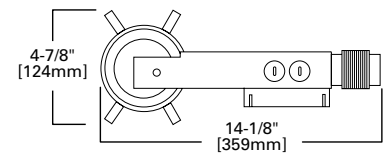
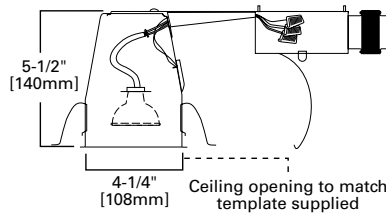

H1499RTAT

4" Non-IC, Shallow Remodel 120V – 12V Low Voltage, MR16

H1499RTAT is a Non-IC Air-Tite™ remodel housing with an integral low voltage magnetic transformer that supplies 12 volts to MR16 lamps. The H1499RTAT is designed for use in non-insulated existing ceilings. If insulation is present it must be kept 3 inches away from all sides of housing. For installation from below the ceiling. Non-IC housing is Air-Tite™ to meet restricted air flow requirements.



Special Features

Quick Connect™ push wire nuts
Air-Tite™ code compliant

Compatible Trims

1419	1421	1493	1496	1498	1946
1420	1453	1495	1497	1945	1951

Features

Housing

Formed of CRS with white powder coat finish

Remodel Clips

Four remodel clips secure housing and accommodates 1/2" and 5/8" ceiling materials

Junction Box

- Seven 1/2" trade size conduit knockouts with true pry-out slots
- Four pry-outs with integral strain relief for non-metallic (NM) sheathed cable

Includes:

- Quick Connect™ push wire nuts (Details Pg. 11)
- Air-Tite™ code compliant (Details Pg. 11)

Socket

GU5.3 socket with reflector plate for bi-pin 12V MR16 lamps

Transformer

Integral 120V magnetic transformer steps line voltage down to 12V nominal lamp operating voltage. For MR16 lamps up to 50W.

Support Spring

Support spring helps support weight of junction box and transformer. Automatically adjusts for different ceiling materials.

Thermal Protector

Self resetting thermal protector deactivates fixture if overheating occurs due to improper lamping or misapplied insulation

Compliance

- cULus Listed 1598 luminaire
- cULus Listed damp location
- cULus Listed for wet location, covered ceiling, with select trims
- Air-Tite code compliant. Certified under ASTM E283; not exceeding 2.0 cfm (0.944 L/s) air leakage rate tested at a 1.57 psf (75 Pa) pressure differential

Low Voltage MR16 Non-IC Housing

H1499T75

4
INCH

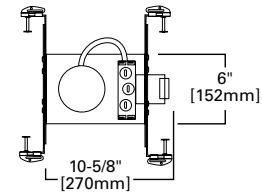
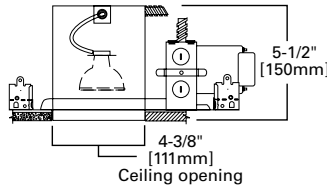

H1499T75

4" Non-IC, New Construction, 120V/277V – 12V Low Voltage, MR16

H1499T75 is a low voltage housing for providing accent, task, and general lighting with up to 75W 12V MR16 lamps. The H1499T75 features a dual-tap transformer for 120V or 277V input. H1499T75 is for non-insulated ceilings. If installed in insulated ceilings, insulation must be kept 3 inches away from all sides of housing.



Special Features

- Got Nail!™ bar hangers
- Slide-N-Side™ junction box
- Quick Connect™ push wire nuts

Compatible Trims

1419	1421	1493	1496	1498	1946
1420	1453	1495	1497	1945	

Features

Housing

Formed of CRS with white powder coat finish

Plaster Frame

- Galvanized steel construction
- The housing can be removed from plaster frame to provide access to the junction box
- Plaster frame features include:
 - Regressed locking screw positioned for securing hanger bars from below the ceiling
 - Cutouts for easily crimping hanger bars in position
 - Halo name embossed on plaster frame

Includes:

- Got Nail!™ bar hangers (Details Pg. 11)
- Pass-N-Thru™ bars (Details Pg. 11)
- Slide-N-Side™ junction box wire traps (Details Pg. 11)
- Quick Connect™ push wire nuts (Details Pg. 11)

Transformer

Integral 120/277V dual-tap magnetic transformer steps line voltage down to 12V nominal lamp operating voltage. Rated for 50W max. Housing ships as 277V model with 120V transformer wire lead capped. For use in 120V systems, simply cap the 277V wire lead and use 120V lead (refer to wiring diagram).

Socket

GU5.3 socket with reflector plate for bi-pin 12V MR16 lamps

Thermal Protector

Self resetting thermal protector deactivates fixture if overheating occurs due to improper lamping

Compliance

- cULus Listed 1598 luminaire
- cULus Listed for damp location
- cULus Listed for wet location, covered ceiling, with select trims
- cULus Listed for feed through
- IP Rated (Improper Lamp)

Reflectors

1421 Precision Reflector – 35° Tilt

- Precision die cast metal trim ring with spun reflector cone
- Provides general illumination
- 35° Tilt
- Friction clip "cat paw" retention
- Clear cover glass included with each trim, for use with non-cover glass MR16 lamps



1421MB
Black Specular Reflector,
White Trim



1421W
White Reflector, White Trim



1421H
Haze Reflector, White Trim



1421C
Clear Specular Reflector,
White Trim



1421RG
Residential Gold Reflector,
White Trim



1421CG
Champagne Gold Reflector,
White Trim



1421SN
Satin Nickel Reflector,
Satin Nickel Trim



1421TBZ
Tuscan Bronze Reflector,
Tuscan Bronze Trim

Housings

Max Lamp Compatibility

H1499TAT	H1499RTAT	50W 12V MR16
H1499ICAT	H1499TCP	
H1499T75		75W 12V MR16

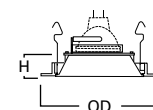

Dimensions**
H: 1-3/8" [33mm]
OD: 5" [129mm]

**Key: H: Height, OD: Trim Outside Diameter

Specifications, compliances and dimensions subject to change without notice

Baffles

1493 Coilex® Baffle – 35° Tilt

- Precision die cast metal trim ring
- Coilex® phenolic baffle
- Provides general illumination
- 35° tilt
- Friction clip "cat paw" retention
- Clear cover glass included with each trim, for use with non-cover glass MR16 lamps



1493W
White Coilex Baffle,
White Trim



1493P
Black Coilex Baffle,
White Trim



1493BC
Black Coilex Baffle,
Black Chrome Trim



1493TBZ
Black Coilex Baffle, Tuscan
Bronze Trim

Housings	Max Lamp Compatibility
H1499TAT H1499RTAT	50W 12V MR16
H1499ICAT H1499TCP	
H1499T75	75W 12V MR16

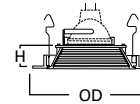

Dimensions**
H: 1-3/8" [33mm]
OD: 5" [129mm]

1453 Precision Metal Baffle – 35° Tilt

- Precision die cast metal trim ring with matching finish metal baffle
- Provides general illumination
- 35° tilt
- Friction clip "cat paw" retention
- Clear cover glass included with each trim, for use with non-cover glass MR16 lamps



1453SN
Satin Nickel Baffle,
Satin Nickel Trim



1453TBZ
Tuscan Bronze Baffle,
Tuscan Bronze Trim

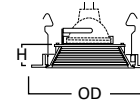

Dimensions**
H: 1-1/4" [30mm]
OD: 5" [129mm]

Housings	Max Lamp Compatibility
H1499TAT H1499RTAT	50W 12V MR16
H1499ICAT H1499TCP	
H1499T75	75W 12V MR16

1419 Pinhole Baffle

- 1-7/8" pinhole opening
- Precision die cast metal trim ring with metal baffle
- For concentrated accent lighting
- Friction clip "cat paw" retention
- Clear cover glass included with each trim, for use with non-cover glass MR16 lamps



1419W
White Baffle, White Trim



1419P
Black Baffle, White Trim



1419SN
Black Baffle, Satin Nickel Trim



1419TBZ
Black Baffle, Tuscan
Bronze Trim

Housings	Max Lamp Compatibility
H1499TAT H1499RTAT	50W 12V MR16
H1499ICAT H1499TCP	
H1499T75	75W 12V MR16

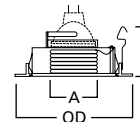

Dimensions**
A: 1-7/8" [46mm]
H: 1-3/8" [33mm]
OD: 5" [129mm]

**Key: A: Luminous Aperture, H: Height, OD: Trim Outside Diameter

H4 Low Voltage Trims

Low Voltage Housings: H1499ICAT • H1499TAT • H1499TCP • H1499RTAT • H1499T75

4
INCH

Adjustable – Eyeballs & Gimbals

1420 Adjustable Slot Aperture – 35° Tilt

- Precision die cast metal trim ring with slot aperture
- For directional accent lighting
- 35° tilt, 360° rotation
- Friction clip "cat paw" retention
- Clear cover glass included with each trim, for use with non-cover glass MR16 lamps



1420P
Slot Aperture, White Trim



1420SN
Slot Aperture, Satin Nickel Trim



1420TBZ
Slot Aperture, Tuscan Bronze Trim

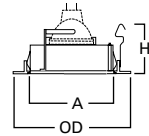

Dimensions**
A: 2-1/8" x 1-3/8"
[53mm x 35mm]
H: 1-1/4" [32mm]
OD: 5" [129mm]

Housings Max Lamp Compatibility

H1499TAT	H1499RTAT	50W 12V MR16
H1499ICAT	H1499TCP	
H1499T75		75W 12V MR16

1495 Adjustable Gimbal – 30° Tilt

- Precision die cast metal trim ring and gimbal
- For directional accent lighting
- 30° tilt, 360° rotation
- Friction clip "cat paw" retention
- Clear cover glass included with each trim, for use with non-cover glass MR16 lamps



1495
White Gimbal, White Trim



1495SN
Satin Nickel Gimbal,
Satin Nickel Trim



1495TBZ
Tuscan Bronze Gimbal,
Tuscan Bronze Trim

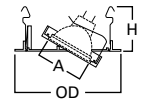

Dimensions**
A: 1-3/4" [44mm]
H: 1-1/4" [30mm]
OD: 5" [129mm]

Housings Max Lamp Compatibility

H1499TAT	H1499RTAT	50W 12V MR16
H1499ICAT	H1499TCP	
H1499T75		75W 12V MR16

1496 Retractable Elbow – 60° Tilt

- Precision die cast metal trim ring with matching finish retractable elbow
- For directional accent lighting
- 60° tilt, 360° rotation
- Friction clip "cat paw" retention
- Clear cover glass included with each trim, for use with non-cover glass MR16 lamps



1496P
White Elbow, White Trim



1496SN
Satin Nickel Elbow,
Satin Nickel Trim



1496TBZ
Tuscan Bronze Elbow,
Tuscan Bronze Trim

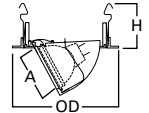

Dimensions**
A: 1-3/4" [44mm]
H: 1-1/8" [29mm]
OD: 5" [129mm]

Housings Max Lamp Compatibility

H1499TAT	H1499RTAT	50W 12V MR16
H1499ICAT	H1499TCP	
H1499T75		75W 12V MR16

1497 Adjustable Mirror Trim – 90° Tilt

- Precision die cast metal trim ring with 90° adjustable scoop
- For directional accent lighting – ideal for wall wash applications
- 90° tilt, 360° rotation
- Friction clip "cat paw" retention
- Clear cover glass included with each trim, for use with non-cover glass MR16 lamps



1497P
White Scoop, White Trim

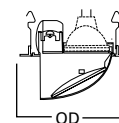

Dimensions**
OD: 5" [129mm]

Housings Max Lamp Compatibility

H1499TAT	H1499RTAT	50W 12V MR16
H1499ICAT	H1499TCP	
H1499T75		75W 12V MR16

**Key: A: Luminous Aperture, H: Height, OD: Trim Outside Diameter

1498 Adjustable Eyeball with Baffle – 30° Tilt

- Precision die cast metal trim with matching finish eyeball
- For directional accent lighting
- 30° tilt, 360° rotation
- Friction clip "cat paw" retention
- Clear cover glass included with each trim, for use with non-cover glass MR16 lamps



1498W
White Eyeball, White Baffle, White Trim



1498P
White Eyeball, Black Baffle, White Trim



1498BC
Black Chrome Eyeball, Black Baffle, Black Chrome Trim



1498SN
Satin Nickel Eyeball, Black Baffle, Satin Nickel Trim



1498TBZ
Tuscan Bronze Eyeball, Black Baffle, Tuscan Bronze Trim

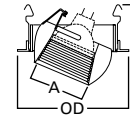

Dimensions**
A: 2" [51mm]
H: 2-5/8" [67mm]
OD: 5" [129mm]

Housings	Max Lamp Compatibility
H1499TAT H1499RTAT	50W 12V MR16
H1499ICAT H1499TCP	
H1499T75	75W 12V MR16

Lenses & Wet Location Showerlights

1945 Metropolitan Ice Light

- Frosted glass trim in clear or blue
- Provides general illumination
- Friction clip retention
- Clear cover glass included with each trim, for use with non-cover glass MR16 lamps



1945
Frosted Clear Glass



1945B
Frosted Blue Glass

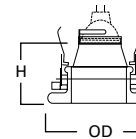

Dimensions**
H: 3-1/8" [79mm]
OD: 5-3/8" [135mm]

Housings	Max Lamp Compatibility
H1499TAT H1499RTAT	50W 12V MR16
H1499TCP	
H1499ICAT	42W 12V MR16
H1499T75	75W 12V MR16

1946 Metropolitan Deco

- Polished metallic accents with translucent rings
- Provides general illumination
- Friction clip retention
- Clear cover glass included with each trim, for use with non-cover glass MR16 lamps



1946BC
Black Chrome Accent, Translucent Ring

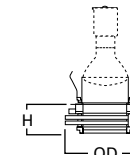

Dimensions**
H: 1-5/8" [41mm]
OD: 5-5/8" [143mm]

Housings	Max Lamp Compatibility
H1499TAT H1499RTAT	50W 12V MR16
H1499TCP	
H1499ICAT	42W 12V MR16
H1499T75	75W 12V MR16

1951 Regressed Clear Lens Showerlight

- Wet location listed for use in showers
- Non-conductive, non-corrosive polymer trim and fixed clear glass lens
- Clear specular splay reflector
- 15° tilt, 360° rotation
- Friction clip retention



1951PS
Clear Specular Splay Reflector, White Trim



1951SNS
Clear Specular Splay Reflector, Satin Nickel Trim



1951TBZS
Clear Specular Splay Reflector, Tuscan Bronze Trim

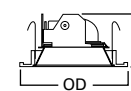

Dimensions**
H: 2-1/2" [63mm]
OD: 5" [129mm]

Housings	Max Lamp Compatibility
H1499TAT H1499ICAT	35W 12V MR16
H1499TCP	
H1499RTAT	50W 12V MR16



**Key: A: Luminous Aperture, H: Height, OD: Trim Outside Diameter



5 INCH

5" E26 Screw Base

IC Housings	203
IC Trims	208
IC Housings – No Socket Bracket	217
IC Trims – No Socket Bracket	220
Non-IC Housings	230
Non-IC Trims	234
Non-IC Housings – No Socket Bracket	242
Non-IC Trims – No Socket Bracket	244

IC = Insulated Ceiling Non-IC = Non-Insulated Ceiling

Trim #	Style	H5ICAT	H5RICAT	E5ICAT	E5RICAT	H25ICAT	H5ICATNB	E5ICATNB	H25ICATNB
5000	Splay	•	•	•	•	•	•	•	•
5001	Baffle	•	•	•	•	—	•	•	—
5010	Baffle	•	•	•	•	—	•	•	—
5014	Baffle	•	•	•	•	•	•	•	•
5016	Baffle	•	•	•	•	—	•	•	—
5020	Reflector	•	•	•	•	—	•	•	—
5021	Reflector	•	•	•	•	—	•	•	—
5051	Showerlight	•	•	•	•	—	•	•	—
5054	Showerlight	•	•	•	•	•	•	•	•
5060	Adjustable	•	•	•	•	•	•	•	•
5070	Adjustable	•	•	•	•	•	•	•	•
5071	Adjustable	•	•	•	•	•	•	•	•
5102	Baffle	•	•	•	•	•	—	—	—
5107	Reflector	•	•	•	•	•	—	—	—
5109	Baffle	•	•	•	•	•	—	—	—
5110	Baffle	•	•	•	•	•	—	—	—
5120	Reflector	•	•	•	•	—	•	•	—
5121	Reflector	•	•	•	•	•	•	•	•
5125	Baffle	•	•	•	•	—	•	•	—
5126	Baffle	•	•	•	•	•	•	•	•
5130	Adjustable	•	•	•	•	•	•	•	•
5135	Adjustable	•	•	•	•	•	•	•	•
5145	Open Showerlight	•	•	•	•	•	•	•	•
5146	Open Showerlight	•	•	•	•	—	•	•	—
5150	Showerlight	•	•	•	•	•	•	•	•
5162	Showerlight	•	•	•	•	•	•	•	•
5165	Adjustable	•	•	•	•	•	•	•	•
5175	Open	•	•	•	•	•	—	—	—
5176	Open	•	•	•	•	•	•	•	•
5185	Splay	•	•	•	•	•	—	—	—
5186	Splay	•	•	•	•	•	•	•	•
5222	Adjustable	•	•	•	•	—	•	•	—
5230	Showerlight	•	•	•	•	—	•	•	—
5255	Showerlight	•	•	•	•	—	•	•	—



E26 Screw Base IC Housing

H51CAT

5
INCH

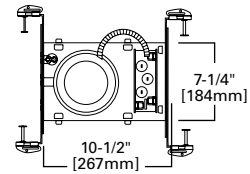
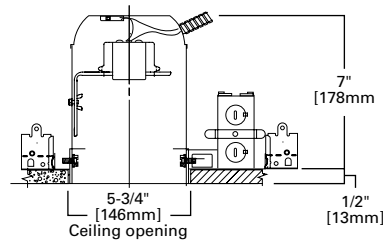

H51CAT

5" IC, Air-Tite, New Construction Housing, 120V

The H51CAT recessed housing is designed for residential and light commercial applications. H51CAT features full-frame robust construction, feed through listing, Got Nail! bar hangers, and may support the use of higher wattage lamps. The wide variety of trims available allows a number of different lighting effects to be created with one basic housing. The H51CAT is designed for use in insulated ceilings and may be in direct contact with insulation*. May be retrofit with compatible Halo LED lighting systems.



Special Features

- Got Nail!™ bar hangers
- q-Channel bars with Pass-N-Thru™
- Slide-N-Side™ junction box
- Quick Connect™ push wire nuts
- Air-Tite™ code compliant

Compatible Trims

5000	5021	5102	5125	5150	5185
5001	5051	5107	5126	5162	5186
5010	5054	5109	5130	5165	5222
5014	5060	5110	5135	5175	5230
5016	5070	5120	5145	5176	5255
5020	5071	5121	5146		



Trims for use in Halo listed housings



Select trims are classified for use in other housings, see www.cooperlighting.com/legal

Features

Housing

- Single wall aluminum housing
- Sealed and gasketed for Air-Tite™ ready installation
- Designed for insulated ceilings in direct contact with insulation* (May also be installed in non-insulated ceilings)
- Housing adjusts in plaster frame to accommodate up to 1-3/8" ceiling thickness

Socket Plate

- Rigid socket plate adjusts and locks without tools for various lamp sizes
- Socket plate and bracket may be removed when using socket supporting trims

Plaster Frame

- Galvanized steel construction
- The housing can be removed from plaster frame to provide access to the junction box
- Plaster frame features include:
 - Regressed locking screw positioned for securing hanger bars from below the ceiling
 - Cutouts for easily crimping hanger bars in position
 - Halo name embossed on plaster frame
 - Pre-installed Air-Tite ready ceiling contact gasket

Includes:

- Got Nail!™ bar hangers (Details Pg. 13)
- q-Channel bars with Pass-N-Thru™ (Details Pg. 13)
- Slide-N-Side™ junction box wire traps (Details Pg. 13)
- Quick Connect™ push wire nuts (Details Pg. 13)
- Air-Tite™ code compliant (Details Pg. 13)

Socket

- Porcelain socket with nickel plated brass screw shell
- Snap-in springs secure socket to socket plate, and may be detached when using socket supporting trims
- Overspray protector included

Thermal Protector

Self resetting thermal protector deactivates fixture if overheating occurs due to improper lamping or misapplied insulation

Trims

Halo Fit-All concept offers multiple trim options in a variety of design styles, and functional beam distributions to control beam angle and lumen delivery in accommodating various lamp types including Halogen, CFL and LED

Compliance

- cULus Listed 1598 luminaire
- cULus Listed damp location
- cULus Listed for wet location, covered ceiling, with select trims
- cULus Listed for feed through
- cULus Listed for direct contact with insulation and combustible material*
- Air-Tite code compliant. Certified under ASTM E283; not exceeding 2.0 cfm (0.944 L/s) air leakage rate tested at a 1.57 psf (75 Pa) pressure differential
- RoHS compliant

*Not to be used in direct contact with spray foam insulation (Consult NEMA LSD57-2013)

5
INCH

E26 Screw Base IC Housing

H5RICAT

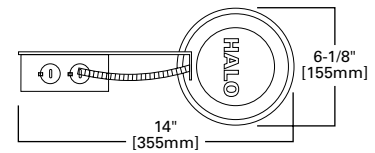
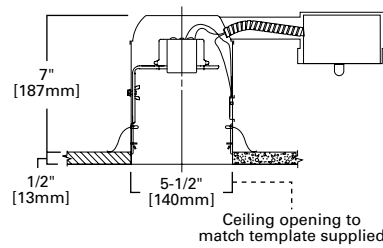

H5RICAT

5" IC, Air-Tite, Remodel Housing, 120V

The H5RICAT recessed housing is designed for residential and light commercial applications. H5RICAT remodel housing features robust construction and may support the use of higher wattage lamps. The wide variety of trims available allows a number of different lighting effects to be created with one basic housing. The H5RICAT is for use in insulated ceilings and may be in direct contact with insulation*. Remodel housing is designed for installation from below the finished ceiling. May be retrofit with compatible Halo LED lighting systems.



Special Features

- Slide-N-Side™ junction box
- Quick Connect™ push wire nuts
- Air-Tite™ code compliant

Compatible Trims

5000	5021	5102	5125	5150	5185
5001	5051	5107	5126	5162	5186
5010	5054	5109	5130	5165	5222
5014	5060	5110	5135	5175	5230
5016	5070	5120	5145	5176	5255
5020	5071	5121	5146		



Trims for use in Halo listed housings



Select trims are classified for use in other housings, see www.cooperlighting.com/legal

Features

Housing

- Gasketed die-stamped aluminum
- Pre-installed Air-Tite™ ready ceiling contact gasket on flange
- For installation from below the finished ceiling. Integral flange secures fixture against ceiling.
- Designed for insulated ceilings in direct contact with insulation* (May also be installed in non-insulated ceilings)

Socket Plate

- Rigid socket plate adjusts and locks without tools for various lamp sizes
- Socket plate and bracket may be removed when using socket supporting trims

Remodel Springs

Four remodel clips secure housing and accommodate 1/2" and 5/8" ceiling material

Junction Box

- Seven 1/2" trade size conduit knockouts with true pry-out slots
- Four type non-metallic (NM) cable pry-outs simplify installation

Includes:

- Slide-N-Side™ junction box wire traps (Details Pg. 13)
- Quick Connect™ push wire nuts (Details Pg. 13)
- Air-Tite™ code compliant (Details Pg. 13)

Socket

- Porcelain socket with nickel plated brass screw shell
- Snap-in springs secure socket to socket plate, and may be detached when using socket supporting trims
- Overspray protector included

Thermal Protector

Self resetting thermal protector deactivates fixture if overheating occurs due to improper lamping or misapplied insulation

Trims

Halo Fit-All concept offers multiple trim options in a variety of design styles, and functional beam distributions to control beam angle and lumen delivery in accommodating various lamp types including Halogen, CFL and LED

Compliance

- cULus Listed 1598 luminaire
- cULus Listed damp location
- cULus Listed for wet location, covered ceiling, with select trims
- cULus Listed for feed through
- cULus Listed for direct contact with insulation and combustible material*
- Air-Tite code compliant. Certified under ASTM E283; not exceeding 2.0 cfm (0.944 L/s) air leakage rate tested at a 1.57 psf (75 Pa) pressure differential
- RoHS compliant

*Not to be used in direct contact with spray foam insulation (Consult NEMA LSD57-2013)

E26 Screw Base IC Housing

E51CAT

5
INCH

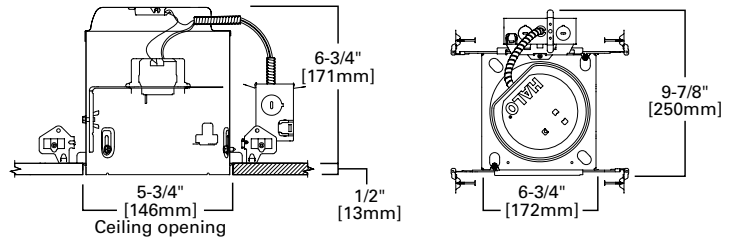

E51CAT

5" IC, Air-Tite, New Construction Housing, 120V

The E51CAT is a compact and efficient recessed housing optimized and listed for EISA compliant tungsten-halogen, CFL and LED lamps as well as incandescent. E51CAT housing is suitable for residential or light commercial applications. For installation in insulated ceilings* and non-insulated ceilings; with Air-Tite code compliant construction. Use with a variety of trims and finishes to create different lighting effects or to match any decor. May be retrofit with Halo LED lighting systems.



Special Features

- All-Nail™ bar hangers
- q-Channel bars with Pass-N-Thru™
- Hinged j-box with Slide-N-Side™
- Quick Connect™ push wire nuts
- Air-Tite™ code compliant

Compatible Trims

5000	5021	5102	5125	5150	5185
5001	5051	5107	5126	5162	5186
5010	5054	5109	5130	5165	5222
5014	5060	5110	5135	5175	5230
5016	5070	5120	5145	5176	5255
5020	5071	5121	5146		



Trims for use in Halo listed housings



Select trims are classified for use in other housings, see www.cooperlighting.com/legal

Features

Housing

- Single wall die-formed aluminum housing
- Housing features a precision rolled interlocking collar which maintains aperture geometry for greater assurance of installation results
- Exclusive Air-Tite gasket meets code where required, and seals between housing, frame and finished ceiling - without need for additional caulk
- May be removed from the plaster frame to provide access to junction box

Socket Plate

- Rigid socket plate adjusts and locks without tools for various lamp sizes
- Socket plate and bracket may be removed when using socket supporting trims

Plaster Frame

- Galvanized steel frame. Housing adjusts in plaster frame to accommodate up to 3/8" - 1" ceiling thickness.
- (2) Regressed locking screws for securing hanger bars

Includes:

- All-Nail™ bar hangers (Details Pg. 15)
- q-Channel bars with Pass-N-Thru™ (Details Pg. 15)
- Hinged junction box with Slide-N-Side™ (Details Pg. 15)
- Quick Connect™ push wire nuts (Details Pg. 15)
- Air-Tite™ code compliant (Details Pg. 15)

Socket

- Porcelain socket with nickel plated brass screw shell
- Snap-in springs secure socket to socket plate, and may be detached when using socket supporting trims
- Shipped with socket overspray protector installed

Thermal Protector

Self resetting thermal protector deactivates fixture if overheating occurs due to improper lamping or misapplied insulation

Trims

Halo Fit-All concept offers multiple trim options in a variety of design styles, and functional beam distributions to control beam angle and lumen delivery in accommodating various lamp types including Halogen, CFL and LED

Compliance

- cULus Listed 1598 luminaire
- cULus Listed damp location
- cULus Listed for wet location, covered ceiling, with select trims
- cULus Listed for direct contact with insulation and combustible material*
- Air-Tite code compliant. Certified under ASTM E283; not exceeding 2.0 cfm (0.944 L/s) air leakage rate tested at a 1.57 psf (75 Pa) pressure differential
- RoHS compliant

*Not to be used in direct contact with spray foam insulation (Consult NEMA LSD57-2013)

5
INCH

E26 Screw Base IC Housing

E5RICAT

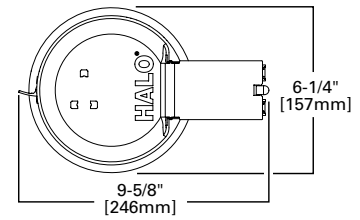
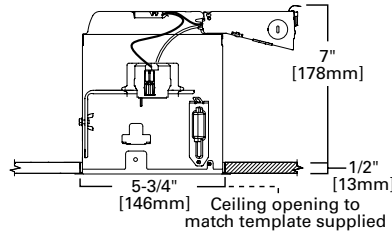

E5RICAT

5" IC, Air-Tite, Remodel Housing, 120V

The E5RICAT is a compact and efficient recessed housing optimized and listed for EISA compliant, tungsten-halogen, CFL and LED lamps as well as incandescent. E5RICAT remodel housing is suitable for residential or light commercial applications. For installation in insulated ceilings* and non-insulated ceilings; with Air-Tite code compliant construction. Remodel housing is designed for installation from below the finished ceiling. Use with a variety of trims and finishes to create different lighting effects or to match any decor. May be retrofit with Halo LED lighting systems.



Special Features

- Hinged j-box with Slide-N-Side™
- Quick Connect™ wiring tray
- Air-Tite™ code compliant

Compatible Trims

5000	5021	5102	5125	5150	5185
5001	5051	5107	5126	5162	5186
5010	5054	5109	5130	5165	5222
5014	5060	5110	5135	5175	5230
5016	5070	5120	5145	5176	5255
5020	5071	5121	5146		



Trims for use in Halo listed housings



Select trims are classified for use in other housings, see www.cooperlighting.com/legal

Features

Housing

- Single wall die-formed aluminum housing
- Die formed flange maintains aperture geometry for greater assurance of installation results
- Exclusive Air-Tite gasket meets code where required, and seals between housing, flange and finished ceiling - without need for additional caulk
- For installation from below the finished ceiling. Integral flange secures fixture against ceiling.

Remodel Retention System - Speed Clamps

- Exclusive two integral speed clamps securely lock housing to ceiling, accommodating 3/8" to 2" ceiling material

Socket Plate

- Rigid socket plate adjusts and locks without tools for various lamp sizes
- Socket plate and bracket may be removed when using socket supporting trims

Includes:

- Hinged junction box with Slide-N-Side™ (Details Pg. 15)
- Quick Connect™ wiring tray (Details Pg. 15)
- Air-Tite™ code compliant (Details Pg. 15)

Socket

- Porcelain socket with nickel plated brass screw shell
- Snap-in springs secure socket to socket plate, and may be detached when using socket supporting trims
- Shipped with socket overspray protector installed

Thermal Protector

Self resetting thermal protector deactivates fixture if overheating occurs due to improper lamping or misapplied insulation

Trims

Halo Fit-All concept offers multiple trim options in a variety of design styles, and functional beam distributions to control beam angle and lumen delivery in accommodating various lamp types including Halogen, CFL and LED

Quick Connect™ Wiring Tray

- (3) Color coded 4-port push-in wire nuts included
- Captive tray holds push-nuts in place for one-handed connections to line, neutral & ground
- Speeds installation and increases reliability
- No additional wire nuts required

Compliance

- cULus Listed 1598 luminaire
- cULus Listed damp location
- cULus Listed for wet location, covered ceiling, with select trims
- cULus Listed for direct contact with insulation and combustible material*
- Air-Tite code compliant. Certified under ASTM E283; not exceeding 2.0 cfm (0.944 L/s) air leakage rate tested at a 1.57 psf (75 Pa) pressure differential.
- RoHS compliant

*Not to be used in direct contact with spray foam insulation (Consult NEMA LSD57-2013)

E26 Screw Base IC Housing

H25ICAT

5
INCH

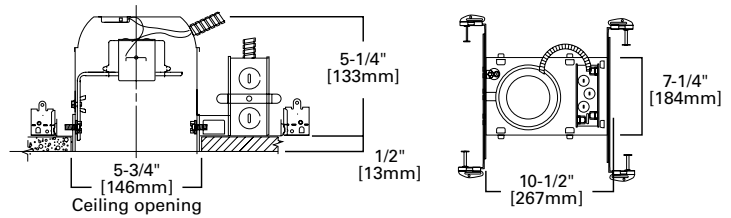

H25ICAT

5" IC, Air-Tite, Shallow New Construction Housing, 120V

The H25ICAT recessed housing is designed for residential and light commercial applications. The H25ICAT is designed for use in shallow ceilings and features full-frame robust construction, feed through listing, Got Nail! bar hangers; and may support the use of higher wattage lamps. The wide variety of trims available allows a number of different lighting effects to be created with one basic housing. The H25ICAT is designed for use in shallow insulated ceilings and may be in direct contact with insulation*. May be retrofit with compatible Halo LED lighting systems.



Special Features

- Got Nail!™ bar hangers
- q-Channel bars with Pass-N-Thru™
- Slide-N-Side™ junction box
- Quick Connect™ push wire nuts
- Air-Tite™ code compliant

Compatible Trims

5000	5070	5109	5130	5162	5176
5014	5071	5110	5135	5165	5185
5054	5102	5121	5145	5175	5186
5060	5107	5126	5150		

Trims for use in Halo listed housings

Select trims are classified for use in other housings, see www.cooperlighting.com/legal

Features

Housing

- Single wall aluminum housing
- Sealed and gasketed for Air-Tite™ ready installation
- Designed for insulated ceilings in direct contact with insulation* (May also be installed in non-insulated ceilings)
- Housing adjusts in plaster frame to accommodate up to 1-3/8" ceiling thickness

Socket Plate

- Rigid socket plate adjusts and locks without tools for various lamp sizes
- Socket plate and bracket may be removed when using socket supporting trims

Plaster Frame

- Galvanized steel construction
- The housing can be removed from plaster frame to provide access to the junction box
- Plaster frame features include:
 - Regressed locking screw positioned for securing hanger bars from below the ceiling
 - Cutouts for easily crimping hanger bars in position
 - Halo name embossed on plaster frame
 - Pre-installed Air-Tite ready ceiling contact gasket

Includes:

- Got Nail!™ bar hangers (Details Pg. 13)
- q-Channel bars with Pass-N-Thru™ (Details Pg. 13)
- Slide-N-Side™ junction box wire traps (Details Pg. 13)
- Quick Connect™ push wire nuts (Details Pg. 13)
- Air-Tite™ code compliant (Details Pg. 13)

Socket

- Porcelain socket with nickel plated brass screw shell
- Snaps into trim for consistent lamp positioning
- Overspray protector included

Thermal Protector

Self resetting thermal protector deactivates fixture if overheating occurs due to improper lamping or misapplied insulation

Trims

Halo Fit-All concept offers multiple trim options in a variety of design styles, and functional beam distributions to control beam angle and lumen delivery in accommodating various lamp types including Halogen, CFL and LED

Compliance

- cULus Listed 1598 luminaire
- cULus Listed damp location
- cULus Listed for wet location, covered ceiling, with select trims
- cULus Listed for feed through
- cULus Listed for direct contact with insulation and combustible material*
- Air-Tite code compliant. Certified under ASTM E283; not exceeding 2.0 cfm (0.944 L/s) air leakage rate tested at a 1.57 psf (75 Pa) pressure differential.
- RoHS compliant

*Not to be used in direct contact with spray foam insulation (Consult NEMA LSD57-2013)

Reflectors

5020 PAR Reflector

- Straight precision sided trim ring (fixed, not removable)
- Torsion spring retention
- Dual socket position for BR and PAR lamps
- Socket supporting

Housings Max Lamp Compatibility

H5ICAT	75W PAR30S, 60W R30, 60W BR30
H5RICAT	50W PAR30S, 50W PAR30L, 60W BR30
E5ICAT	5020P, 5020H, 5020SC, 5020BL: 60W PAR30S, 60W BR30
E5RICAT	5020SN, 5020TBZ: 60W PAR30S, 50W BR30

Compatible with Halogen, Incandescent, LED* or CFL* lamps



5020P
White Reflector, White Trim



5020H
Haze Reflector, White Trim



5020SC
Clear Specular Reflector,
White Trim



5020BL
Black Specular Reflector,
White Trim



5020SN
Satin Nickel Reflector,
Satin Nickel Trim



5020TBZ
Tuscan Bronze Reflector,
Tuscan Bronze Trim

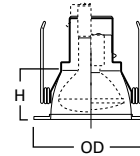

Dimensions**
H: 3-1/4" [82mm]
OD: 6-3/8" [162mm]

5021 Full Reflector

- Straight precision sided trim ring (fixed, not removable)
- Torsion spring retention
- For use with A-lamps
- Socket supporting

Housings Max Lamp Compatibility

H5ICAT	H5RICAT	40W A19
E5ICAT	E5RICAT	29W A19

Compatible with Halogen, Incandescent, LED* or CFL* lamps



5021H
Haze Reflector, White Trim



5021SC
Clear Specular Reflector,
White Trim



5021TBZ
Tuscan Bronze Reflector,
Tuscan Bronze Trim

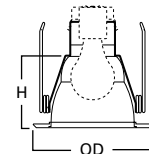

Dimensions**
H: 5" [127mm]
OD: 6-3/8" [162mm]

5107 Specular Reflector, Self-flange

- Self-flange reflector cone
- Contoured tapered sides of cone reflector for BR30 and PAR30 lamps
- Coil spring retention
- Self-flange trim ring sized to hide gaps caused by construction tolerances



5107SC
Specular Reflector,
White Self-flange

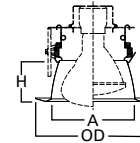

Dimensions**
A: 4-3/4" [121mm]
H: 2-3/8" [60mm]
OD: 6-5/8" [168mm]

Housings Max Lamp Compatibility

H5ICAT	H5RICAT	50W PAR30S, 75W PAR30L,
E5ICAT	E5RICAT	65W BR30

H25ICAT	50W PAR30S, 60W PAR30L, 60W BR30
---------	-------------------------------------

Compatible with Halogen, Incandescent, LED* or CFL* lamps

5120 Full Cone Reflector, Self-flange

- Full cone reflector
- Torsion spring retention
- Socket supporting
- Self-flange trim ring sized to hide gaps caused by construction tolerances



5120WH
White Reflector, White
Self-flange



5120SN
Satin Nickel Reflector,
Satin Nickel Self-flange



5120TBZ
Tuscan Bronze Reflector,
Tuscan Bronze Self-flange

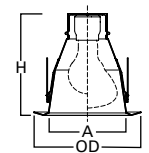

Dimensions**
A: 4-3/4" [121mm]
H: 6-1/4" [160mm]
OD: 6-5/8" [168mm]

Housings Max Lamp Compatibility

H5ICAT	H5RICAT	5120WH: 29W A19, 50W PAR30S, 60W PAR30L, 65W BR30
E5ICAT	E5RICAT	5120SN, 5120TBZ: 29W A19, 50W PAR30S, 60W PAR30L, 50W BR30

Compatible with Halogen, Incandescent, LED* or CFL* lamps

*UL1993 listed LED & CFL equivalent lamps permitted. Consult lamp manufacturer for conditions of use. Eaton does not warranty the lamp.

**Key: A: Luminous Aperture, D: Depth Profile, H: Height, LH: Lens Height, OD: Trim Outside Diameter

E26 Screw Base Trims

IC Housings: H5ICAT • H5RICAT • E5ICAT • E5RICAT • H25ICAT

5
INCH

5121 Shallow Full Cone Reflector, Self-flange

- Shallow full cone reflector
- Torsion spring retention
- Socket supporting
- Self-flange trim ring sized to hide gaps caused by construction tolerances



5121WH
White Reflector, White Oversize Self-flange

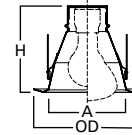

Dimensions**
A: 4-3/4" [121mm]
H: 5-1/3" [135mm]
OD: 6-5/8" [168mm]

Housings	Max Lamp Compatibility
H5ICAT H5RICAT E5ICAT E5RICAT	50W PAR30S, 75W PAR30L, 65W BR30
H25ICAT	50W PAR20, 50W PAR30S, 75W PAR30L, 65W BR30

Compatible with Halogen, Incandescent, LED* or CFL* lamps

Baffles

5001 PAR Metal Baffle Splay

- Straight precision sided trim ring (fixed, not removable)
- Torsion spring retention
- Dual socket position for BR and PAR lamps
- Socket supporting



5001P
White Baffle, White Trim



5001MB
Black Baffle, White Trim



5001SN
Satin Nickel Baffle,
Satin Nickel Trim



5001TBZ
Tuscan Bronze Baffle, Tuscan
Bronze Trim

Housings	Max Lamp Compatibility
H5ICAT	35W PAR20, 75W PAR30S, 65W BR30, 30W R20
H5RICAT	35W PAR20, 50W PAR30S, 50W PAR30L, 60W BR30, 30W R20
E5ICAT	5001P: 35W PAR20, 60W PAR30S, 60W PAR30L, 65W BR30
E5RICAT	5001MB, 5001SN, 5001TBZ: 35W PAR20, 60W PAR30S, 60W PAR30L, 60W BR30

Compatible with Halogen, Incandescent, LED* or CFL* lamps

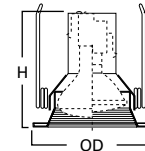

Dimensions**
H: 6-1/8" [152mm]
OD: 6-3/8" [156mm]

5010 PAR Metal Step Baffle

- Straight precision sided trim ring (fixed, not removable)
- Torsion spring retention
- Dual socket position for BR and PAR lamps
- Socket supporting



5010W
White Baffle, White Trim



5010
Black Baffle, White Trim

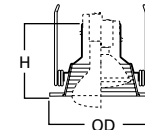

Dimensions**
H: 2" [52mm]
OD: 6-3/8" [156mm]

Housings	Max Lamp Compatibility
H5ICAT	75W PAR30S, 60W R30, 60W BR30
H5RICAT	50W PAR30S, 50W PAR30L, 60W BR30
E5ICAT	60W PAR30S, 60W PAR30L, 60W BR30
E5RICAT	50W PAR30S, 60W PAR30L, 60W BR30

Compatible with Halogen, Incandescent, LED* or CFL* lamps

5014 Shallow Metal Baffle, Self-flange

- For use in shallow housing
- Straight precision sided trim ring (fixed, not removable)
- Torsion spring retention
- Socket supporting



5014P
White Baffle, White Trim



5014MB
Black Baffle, White Trim

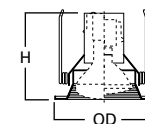

Dimensions**
A: 4-3/4" [121mm]
H: 2-3/8" [60mm]
OD: 6-5/8" [168mm]

Housings	Max Lamp Compatibility
H5ICAT H5RICAT E5ICAT E5RICAT	50W PAR30S, 75W PAR30L, 65W BR30

Compatible with Halogen, Incandescent, LED* or CFL* lamps

*UL1993 listed LED & CFL equivalent lamps permitted. Consult lamp manufacturer for conditions of use. Eaton does not warranty the lamp.

**Key: A: Luminous Aperture, D: Depth Profile, H: Height, LH: Lens Height, OD: Trim Outside Diameter

5016 Coilex® Baffle with Reflector

- Straight precision sided trim ring (fixed, not removable)
- Torsion spring retention
- Dual socket position for BR and PAR lamps
- Socket supporting



5016W
White Baffle, White Trim



5016P
Black Baffle, White Trim

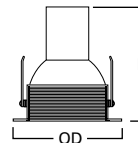

Dimensions**
H: 6-3/4" [171mm]
OD: 6-3/8" [162mm]

Housings Max Lamp Compatibility

H5ICAT	60W PAR30S, 60W PAR30L, 50W BR30
H5RICAT	
E5ICAT	60W PAR30S, 60W PAR30L, 50W BR30
E5RICAT	

Compatible with Halogen, Incandescent, LED* or CFL* lamps

5102 Tapered Metal Baffle, Self-flange

- Contoured tapered sides of metal baffle for BR30 and PAR30 lamps
- Coil spring retention
- Self-flange trim ring sized to hide gaps caused by construction tolerances



5102WB
White Baffle, White Self-flange



5102BB
Black Baffle, White Self-flange

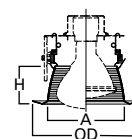

Dimensions**
A: 4-3/4" [121mm]
H: 2-3/8" [60mm]
OD: 6-5/8" [168mm]

Housings Max Lamp Compatibility

H5ICAT	H5RICAT	50W PAR30S, 75W PAR30L, 65W BR30
E5ICAT	E5RICAT	
H25ICAT		50W PAR30S, 60W PAR30L, 60W BR30

Compatible with Halogen, Incandescent, LED* or CFL* lamps

5109 Coilex® Tapered Baffle, Self-flange

- Contoured tapered sides of Coilex baffle for BR30 and PAR30 lamps
- Coil spring retention
- Self-flange trim ring sized to hide gaps caused by construction tolerances



5109WB
White Plastic Straight Coilex Baffle, White Self-flange



5109BB
Black Plastic Straight Coilex Baffle, White Self-flange



5109BKBB
Black Plastic Straight Coilex Baffle, Black Self-flange

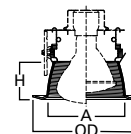

Dimensions**
A: 4-3/4" [121mm]
H: 2-3/8" [60mm]
OD: 6-5/8" [168mm]

Housings Max Lamp Compatibility

H5ICAT	H5RICAT	50W PAR30S, 60W PAR30L, 60W BR30
E5ICAT	E5RICAT	
H25ICAT		39W PAR30S, 60W PAR30L, 50W BR30

Compatible with Halogen, Incandescent, LED* or CFL* lamps

5110 Perftex™ Baffle, Self-flange

- Perforated pattern baffle contoured for BR30 and PAR30 lamps
- Coil spring retention
- Self-flange trim ring sized to hide gaps caused by construction tolerances



5110WB
White Perftex Baffle, White Self-flange



5110BB
Black Perftex Baffle, White Self-flange



5110BKBB
Black Perftex Baffle, Black Self-flange

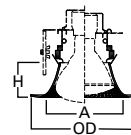

Dimensions**
A: 5-1/2" [141mm]
H: 2-1/8" [55mm]
OD: 6-5/8" [168mm]

Housings Max Lamp Compatibility

H5ICAT	H5RICAT	50W PAR30S, 60W PAR30L, 50W BR30
E5ICAT	E5RICAT	
H25ICAT		5110WB: 39W PAR30S, 60W PAR30L, 50W BR30 5110BB, 5110BKBB: 39W PAR30S, 60W PAR30L, 40W BR30

Compatible with Halogen, Incandescent, LED* or CFL* lamps

*UL1993 listed LED & CFL equivalent lamps permitted. Consult lamp manufacturer for conditions of use. Eaton does not warranty the lamp.

**Key: A: Luminous Aperture, D: Depth Profile, H: Height, LH: Lens Height, OD: Trim Outside Diameter

E26 Screw Base Trims

IC Housings: H5ICAT • H5RICAT • E5ICAT • E5RICAT • H25ICAT

5
INCH



5125 Full Cone Baffle, Self-flange

- Full cone baffle trim
- Torsion springs retention
- Socket supporting
- Self-flange trim ring sized to hide gaps caused by construction tolerances



5125WB White Baffle, White Self-flange **5125BB** White Baffle, Black Self-flange **5125BKBB** Black Baffle, Black Self-flange

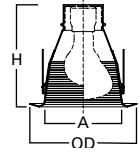

Dimensions**
A: 4-3/4" [121mm]
H: 6-1/4" [160mm]
OD: 6-5/8" [168mm]

Housings	Max Lamp Compatibility
H5ICAT H5RICAT	5125WB: 29W A19, 50W PAR30S, 60W PAR30L, 65W BR30
E5ICAT E5RICAT	5125BB & 5125BKBB: 29W A19, 50W PAR30S, 60W PAR30L, 50W BR30

Compatible with Halogen, Incandescent, LED* or CFL* lamps

5126 Shallow Full Cone Baffle, Self-flange

- Shallow full cone baffle
- Torsion springs retention
- Socket supporting
- Self-flange trim ring sized to hide gaps caused by construction tolerances



5126WB White Baffle, White Self-flange **5126BB** Black Baffle, White Self-flange

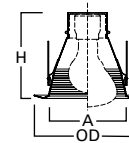

Dimensions**
A: 4-3/4" [121mm]
H: 5-1/3" [135mm]
OD: 6-5/8" [168mm]

Housings	Max Lamp Compatibility
H5ICAT H5RICAT	50W PAR30S, 75W PAR30L, 65W BR30
E5ICAT E5RICAT	50W PAR30S, 75W PAR30L, 65W BR30
H25ICAT	5126WB: 50W PAR20, 50W PAR30S, 75W PAR30L, 65W BR30 5126BB: 50W PAR20, 50W PAR30S, 60W PAR30L, 50W BR30

Compatible with Halogen, Incandescent, LED* or CFL* lamps

Adjustable – Eyeballs & Gimbals

5060 Adjustable Gimbal 20° Tilt, Self-flange

- Straight precision sided trim ring (fixed, not removable)
- For directional accent lighting
- Torsion springs retention
- 20° tilt - 360° rotation
- Socket supporting



5060P White Gimbal, White Trim

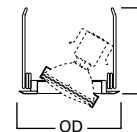

Dimensions**
H: 3-1/4" [82mm]
OD: 6-3/8" [162mm]

Housings	Max Lamp Compatibility
H5ICAT H5RICAT	50W PAR30S
E5ICAT E5RICAT	50W PAR30S, 50W R30

Compatible with Halogen, Incandescent, LED* or CFL* lamps

5070 Adjustable Eyeball 30° Tilt, Self-flange

- Straight precision sided trim ring (fixed, not removable)
- For directional accent lighting
- Torsion springs retention
- 30° tilt - 360° rotation
- Socket supporting



5070P White Eyeball, White Trim **5070SN** Satin Nickel Eyeball, Satin Nickel Trim **5070TBZ** Tuscan Bronze Eyeball, Tuscan Bronze Trim

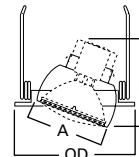

Dimensions**
A: 3-7/8" [98mm]
H: 3-3/8" [86mm]
OD: 6-3/8" [162mm]

Housings	Max Lamp Compatibility
H5ICAT H5RICAT	75W PAR30S
E5ICAT E5RICAT	75W PAR30S
H25ICAT	

Compatible with Halogen, Incandescent, LED* or CFL* lamps

*UL1993 listed LED & CFL equivalent lamps permitted. Consult lamp manufacturer for conditions of use. Eaton does not warranty the lamp.

**Key: A: Luminous Aperture, D: Depth Profile, H: Height, LH: Lens Height, OD: Trim Outside Diameter

5071 Adjustable Eyeball 30° Tilt, Self-flange

- Straight precision sided trim ring (fixed, not removable)
- For directional accent lighting
- Torsion springs retention
- 30° tilt - 360° rotation
- Socket supporting



5071P
White Eyeball, White Trim

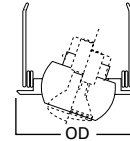

Dimensions**
OD: 6-1/2" [165mm]

Housings	Max Lamp Compatibility
H5ICAT H5RICAT	50W PAR20, 50W R20
E5ICAT E5RICAT	50W PAR20
H25ICAT	50W PAR20, 50W R20

Compatible with Halogen, Incandescent, LED* or CFL* lamps

5130 Eyeball 35° Tilt, Self-flange

- Adjustable 35° tilt, 360° rotation
- Design optimized for PAR30S (short-neck) lamp
- Torsion spring retention
- Socket supporting
- Self-flange trim ring sized to hide gaps caused by construction tolerances



5130WH
White Eyeball, White Trim

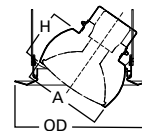

Dimensions**
A: 3-7/8" [98mm]
H: 2-1/4" [58mm]
OD: 6-5/8" [168mm]

Housings	Max Lamp Compatibility
H5ICAT H5RICAT	
E5ICAT E5RICAT	75W PAR30S
H25ICAT	

Compatible with Halogen, Incandescent, LED* or CFL* lamps

5135 Eyeball 35° Tilt, Self-flange

- Conical adjustable eyeball trim for PAR20 lamp
- Torsion spring retention
- Socket supporting
- 35° tilt, 360° rotation
- Self-flange trim ring sized to hide gaps caused by construction tolerances



5135WH
White Eyeball, White Trim, Self-flange

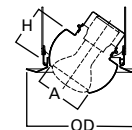

Dimensions**
A: 2-3/4" [70mm]
H: 2-1/4" [58mm]
OD: 6-5/8" [168mm]

Housings	Max Lamp Compatibility
H5ICAT H5RICAT	
E5ICAT E5RICAT	50W PAR20
H25ICAT	

Compatible with Halogen, Incandescent, LED* or CFL* lamps

5165 Gimbal 35° Tilt, Self-flange

- Adjustable gimbal trim for PAR30S (short-neck) lamp
- Torsion spring retention
- Socket supporting
- 35° tilt, 360° rotation
- Self-flange trim ring sized to hide gaps caused by construction tolerances



5165WH
White Gimbal, White Trim



5165BK
Black Gimbal, Black Trim



5165SN
Satin Nickel Gimbal, Satin Nickel Trim



5165TBZ
Tuscan Bronze Gimbal, Tuscan Bronze Trim

Housings	Max Lamp Compatibility
H5ICAT H5RICAT	
E5ICAT E5RICAT	50W PAR30S
H25ICAT	

Compatible with Halogen, Incandescent, LED* or CFL* lamps

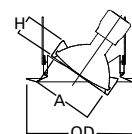

Dimensions**
A: 3-3/8" [85mm]
H: 1-1/8" [29mm]
OD: 6-5/8" [168mm]

*UL1993 listed LED & CFL equivalent lamps permitted. Consult lamp manufacturer for conditions of use. Eaton does not warranty the lamp.

**Key: A: Luminous Aperture, D: Depth Profile, H: Height, LH: Lens Height, OD: Trim Outside Diameter

E26 Screw Base Trims

IC Housings: H5ICAT • H5RICAT • E5ICAT • E5RICAT • H25ICAT

5
INCH

5222 Regressed Angle Cut Adjustable Gimbal, 30° Tilt, Self-flange

- Fully regressed gimbal
- Torsion spring retention
- 30° tilt, 360° rotation
- Socket supporting
- Angle cut - cone reflector and baffle options
- Accommodates tilt of gimbal in a full regressed cut cone
- Self-flange trim ring sized to hide gaps caused by construction tolerances



5222WB
White Baffle & Gimbal,
White Trim



5222BB
Black Baffle & Gimbal,
White Trim



5222SC
Specular Clear Reflector
& Gimbal, White Trim



5222H
Haze Reflector & Gimbal,
White Trim

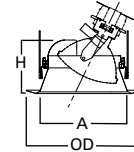

Dimensions**
A: 5" [127mm]
H: 3-1/8" [79mm]
OD: 6-5/8" [168mm]

Housings Max Lamp Compatibility

H5ICAT	H5RICAT	39W PAR30S, 60W PAR30L
E5ICAT	E5RICAT	

Compatible with Halogen, Incandescent, LED* or CFL* lamps

Lenses & Wet Location Showerlights

5051 Frosted Glass Lens

- Frosted glass lens
- Straight precision sided trim
- "Dead-Front" construction, wet location listed Showerlight
- Non-conductive, non-corrosive gasketed polymer trim ring
- Torsion spring retention



5051PS
Frosted Glass Lens, White Trim

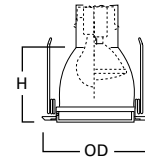

Dimensions**
H: 5-9/16" [141mm]
OD: 6-7/16" [164mm]



Housings Max Lamp Compatibility

H5ICAT	H5RICAT	35W PAR30L
E5ICAT	E5RICAT	

Compatible with Halogen, Incandescent, LED* or CFL* lamps

5054 Frosted Glass Dome Lens

- Frosted glass dome lens
- Straight precision sided trim ring
- "Dead-Front" construction, wet location listed Showerlight
- Non-conductive, non-corrosive gasketed polymer trim ring
- Torsion spring retention



5054PS
Frosted Glass Dome,
White Trim



5054SNS
Frosted Glass Dome,
Satin Nickel Trim



5054TBZS
Frosted Glass Dome,
Tuscan Bronze Trim

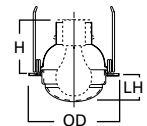

Dimensions**
LH: 1-3/4" [45mm]
H: 4-1/2" [114mm]
OD: 6-3/8" [162mm]



Housings Max Lamp Compatibility

H5ICAT	H5RICAT	40W A19, 50W PAR30S
E5ICAT	E5RICAT	
H25ICAT		

Compatible with Halogen, Incandescent, LED* or CFL* lamps

*UL1993 listed LED & CFL equivalent lamps permitted. Consult lamp manufacturer for conditions of use. Eaton does not warranty the lamp.

**Key: A: Luminous Aperture, D: Depth Profile, H: Height, LH: Lens Height, OD: Trim Outside Diameter



5150 Low Profile, Frosted Glass Dome Lens, Self-flange

- Low profile, frosted glass dome lens
- Wet location Showerlight
- Torsion spring retention
- Non-conductive "dead-front" polymer (plastic) trim and glass lens
- Socket supporting internal reflector
- Self-flange trim ring sized to hide gaps caused by construction tolerances



5150WH
Frosted Glass Dome Lens with Reflector, White Plastic Self-flange



5150SN
Frosted Glass Dome Lens with Reflector, Satin Nickel Plastic Self-flange



5150TBZ
Frosted Glass Dome Lens with Reflector, Tuscan Bronze Plastic Self-flange

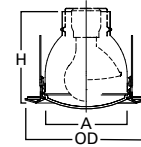

Dimensions**
A: 4-1/2" [114mm]
H: 5" [126mm]
OD: 6-5/8" [168mm]

Housings Max Lamp Compatibility

H5ICAT	H5RICAT	29W A19, 39W PAR30S
E5ICAT	E5RICAT	
H25ICAT		29W A19

Compatible with Halogen, Incandescent, LED* or CFL* lamps



5162 Drop Opal Plastic Lens, Self-flange

- Drop opal plastic lens
- Wet location Showerlight
- Non-conductive "dead-front" polymer (plastic) trim
- Torsion spring retention
- Socket supporting internal reflector
- Self-flange trim ring sized to hide gaps caused by construction tolerances



5162WH
Drop Opal Plastic Lens with Reflector, White Plastic Self-flange

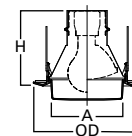

Dimensions**
A: 4-1/2" [114mm]
H: 5-5/8" [118mm]
OD: 6-5/8" [168mm]

Housings Max Lamp Compatibility

H5ICAT	H5RICAT	29W A19
E5ICAT	E5RICAT	
H25ICAT		

Compatible with Halogen, Incandescent, LED* or CFL* lamps



5230 Squircle Frost Glass Lens, Metal Trim, Self-flange

- Low profile frost glass lens
- Wet location Showerlight
- Torsion spring retention
- Self-flange low profile metal trim ring
- Socket supporting internal bracket
- Integral rotation adjustment up to +/- 25° for precise alignment with room



5230AH
Frost Glass Lens, Aluminum Haze Squircle Trim



5230PN
Frost Glass Lens, Polished Nickel Squircle Trim



5230SN
Frost Glass Lens, Satin Nickel Squircle Trim



5230TBZ
Frost Glass Lens, Tuscan Bronze Squircle Trim

Housings Max Lamp Compatibility

H5ICAT	H5RICAT	Consult website
E5ICAT	E5RICAT	www.cooperlighting.com

Compatible with Halogen, Incandescent, LED* or CFL* lamps



5255 Soft Square, Frost Curved Glass Lens, Self-flange

- Low profile cured frost glass lens
- Wet location Showerlight
- Torsion spring retention
- Non-conductive "dead-front" polymer (plastic) trim and glass lens
- Integral rotation adjustment up to +/- 25° for precise alignment with room
- Integrated Socket Supporting reflector for illumination across lens corner-to-corner



5255WH
Frost Curved Glass Lens with Reflector, White Plastic Self-flange



5255SN
Frost Curved Glass Lens with Reflector, Satin Nickel Plastic Self-flange



5255TBZ
Frost Curved Glass Lens with Reflector, Tuscan Bronze Plastic Self-flange

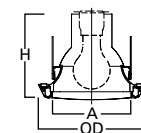

Dimensions**
A: 5-1/8" [130mm]
D: 1" [26mm]
H: 5-1/2" [140mm]
OD: 6-7/8" [174mm]

Housings Max Lamp Compatibility

H5ICAT	H5RICAT	29W A19
E5ICAT	E5RICAT	

Compatible with Halogen, Incandescent, LED* or CFL* lamps

*UL1993 listed LED & CFL equivalent lamps permitted. Consult lamp manufacturer for conditions of use. Eaton does not warranty the lamp.

**Key: A: Luminous Aperture, D: Depth Profile, H: Height, LH: Lens Height, OD: Trim Outside Diameter

E26 Screw Base Trims

IC Housings: H5ICAT • H5RICAT • E5ICAT • E5RICAT • H25ICAT

5
INCH



5145 Open Wet Location, Shallow Reflector, Self-flange

- Open wet location Showerlight for PAR30 outdoor rated lamps ONLY
- Torsion spring retention
- Socket supporting
- Self-flange trim ring sized to hide gaps caused by construction tolerances
- For use in standard and shallow housings



5145WH
White Self-flange



5145SN
Satin Nickel Self-flange



5145TBZ
Tuscan Bronze Self-flange

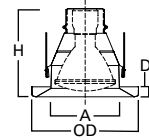

Dimensions**
A: 4-5/8" [117mm]
D: 5/8" [16mm]
H: 5-3/8" [138mm]
OD: 6-5/8" [168mm]

Housings	Max Lamp Compatibility
H5ICAT H5RICAT	5145WH: 75W PAR30S, 75W PAR30L
E5ICAT E5RICAT	5145SN, 5145TBZ: 60W PAR30S, 75W PAR30L

Compatible with Halogen, Incandescent, LED* or CFL* lamps



Lamp Gasket
(Included)

5146 Open Wet Location Full Reflector, Self-flange

- Open wet location Showerlight for PAR30S and PAR30L outdoor rated lamps ONLY
- Torsion spring retention
- Socket supporting
- Self-flange trim ring sized to hide gaps caused by construction tolerances



5146WH
White Self-flange



5146SN
Satin Nickel Self-flange



5146TBZ
Tuscan Bronze Self-flange

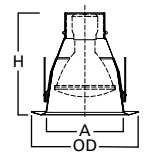

Dimensions**
A: 4-3/4" [121mm]
H: 6-1/4" [160mm]
OD: 6-5/8" [168mm]

Housings	Max Lamp Compatibility
H5ICAT H5RICAT	50W PAR30S, 60W PAR30L
E5ICAT E5RICAT	

Compatible with Halogen, Incandescent, LED* or CFL* lamps



Lamp Gasket
(Included)

Open, Splay & Wall Wash

5000 PAR Metal Splay, Self-flange

- Straight precision sided trim ring (fixed, not remodeled)
- Open metal splay trim
- Dual socket position socket for BR and PAR lamps
- Torsion spring retention
- Socket supporting



5000P
White Splay, White Trim



5000SN
Satin Nickel Splay,
Satin Nickel Trim



5000TBZ
Tuscan Bronze Splay,
Tuscan Bronze Trim

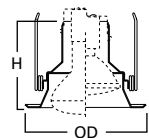

Dimensions**
H: 4-5/8" [118mm]
OD: 6-3/8" [162mm]

Housings	Max Lamp Compatibility
H5ICAT	75W PAR30S, 75W PAR30L, 65W BR30, 75W R30
H5RICAT	50W PAR30S, 75W PAR30L, 60W BR30
H25ICAT	50W PAR30S, 50W PAR30L, 60W BR30
E5ICAT	5000P: 50W PAR30S, 60W PAR30L, 60W BR30
E5RICAT	5000SN, 5000TBZ: 60W PAR30S, 60W PAR30L, 60W BR30

Compatible with Halogen, Incandescent, LED* or CFL* lamps

*UL1993 listed LED & CFL equivalent lamps permitted. Consult lamp manufacturer for conditions of use. Eaton does not warranty the lamp.

**Key: A: Luminous Aperture, D: Depth Profile, H: Height, LH: Lens Height, OD: Trim Outside Diameter

E26 Screw Base Trims

IC Housings: H5ICAT • H5RICAT • E5ICAT • E5RICAT • H25ICAT

5175 Open, Wide Self-flange

- Open trim for BR & PAR lamps
- Coil spring retention
- Self-flange trim ring sized to hide gaps caused by construction tolerances

Housings	Max Lamp Compatibility
H5ICAT H5RICAT	5175WH: 39W PAR30S, 75W PAR30L, 65W BR30
E5ICAT E5RICAT	5175SN, 5175TBZ: 39W PAR30S, 60W PAR30L, 50W BR30
H25ICAT	39W PAR30S, 60W PAR30L, 50W BR30

H5ICAT	H5RICAT	5175WH: 39W PAR30S, 75W PAR30L, 65W BR30
E5ICAT	E5RICAT	5175SN, 5175TBZ: 39W PAR30S, 60W PAR30L, 50W BR30
H25ICAT		39W PAR30S, 60W PAR30L, 50W BR30

Compatible with Halogen, Incandescent, LED* or CFL* lamps



5175WH
White Self-flange



5175SN
Satin Nickel Self-flange



5175TBZ
Tuscan Bronze Self-flange

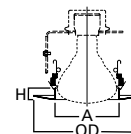

Dimensions**
A: 3-7/8" [99mm]
H: 3/4" [19mm]
OD: 6-5/8" [168mm]

5176 Open, Wide Self-flange

- Open trim for BR & PAR lamps
- Torsion spring retention
- Socket supporting integral bracket
- Self-flange trim ring sized to hide gaps caused by construction tolerances

Housings	Max Lamp Compatibility
H5ICAT H5RICAT	60W PAR30S, 60W PAR30L, 50W BR30
E5ICAT E5RICAT	50W BR30
H25ICAT	

H5ICAT	H5RICAT	60W PAR30S, 60W PAR30L, 50W BR30
E5ICAT	E5RICAT	50W BR30
H25ICAT		

Compatible with Halogen, Incandescent, LED* or CFL* lamps



5176WH
White Self-flange



5176SN
Satin Nickel Self-flange



5176TBZ
Tuscan Bronze Self-flange

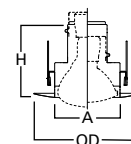

Dimensions**
A: 3-7/8" [99mm]
H: 4-3/4" [120mm]
OD: 6-5/8" [168mm]

5185 Open, Splay Self-flange

- Splay trim for BR & PAR lamps
- Coil spring retention
- Self-flange trim ring sized to hide gaps caused by construction tolerances

Housings	Max Lamp Compatibility
H5ICAT H5RICAT	5185WH: 39W PAR30S, 60W PAR30L, 65W BR30
E5ICAT E5RICAT	5185SN, 5185TBZ: 39W PAR30S, 60W PAR30L, 50W BR30
H25ICAT	39W PAR30S, 60W PAR30L, 50W BR30

H5ICAT	H5RICAT	5185WH: 39W PAR30S, 60W PAR30L, 65W BR30
E5ICAT	E5RICAT	5185SN, 5185TBZ: 39W PAR30S, 60W PAR30L, 50W BR30
H25ICAT		39W PAR30S, 60W PAR30L, 50W BR30

Compatible with Halogen, Incandescent, LED* or CFL* lamps



5185WH
White Self-flange



5185SN
Satin Nickel Self-flange



5185TBZ
Tuscan Bronze Self-flange

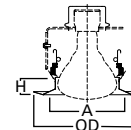

Dimensions**
A: 3-7/8" [99mm]
H: 1" [27mm]
OD: 6-5/8" [168mm]

5186 Splay, Self-flange

- Splay trim for BR & PAR lamps
- Torsion spring retention
- Socket supporting integral bracket
- Self-flange trim ring sized to hide gaps caused by construction tolerances

Housings	Max Lamp Compatibility
H5ICAT H5RICAT	60W PAR30S, 60W PAR30L, 50W BR30
E5ICAT E5RICAT	50W BR30
H25ICAT	

H5ICAT	H5RICAT	60W PAR30S, 60W PAR30L, 50W BR30
E5ICAT	E5RICAT	50W BR30
H25ICAT		

Compatible with Halogen, Incandescent, LED* or CFL* lamps



5186WH
White Self-flange



5186SN
Satin Nickel Self-flange



5186TBZ
Tuscan Bronze Self-flange

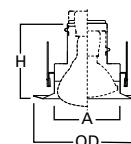

Dimensions**
A: 3-7/8" [99mm]
H: 4-7/8" [123mm]
OD: 6-5/8" [168mm]

*UL1993 listed LED & CFL equivalent lamps permitted. Consult lamp manufacturer for conditions of use. Eaton does not warranty the lamp.

**Key: A: Luminous Aperture, D: Depth Profile, H: Height, LH: Lens Height, OD: Trim Outside Diameter

E26 Screw Base IC Housing – No Socket Bracket

H51CATNB

5
INCH

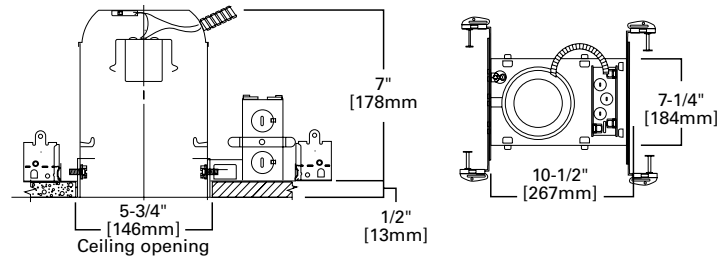

H51CATNB

5" IC, Air-Tite, New Construction Housing, No Socket Bracket, 120V

The H51CATNB recessed housing is designed for residential and light commercial applications. H51CATNB features full-frame robust construction, feed through listing, Got Nail! bar hangers, and may support the use of higher wattage lamps. The wide variety of trims available allows a number of different lighting effects to be created with one basic housing. The H51CATNB is designed for use in insulated ceilings and may be in direct contact with insulation*.

The H51CATNB can save installation time. It is designed without a socket plate, for use with socket supporting trims only. With these trims there is no need to spend time removing the socket plate, and the fixed lamp position of socket supporting trims saves on lamp adjustment time too. May be retrofitted with compatible Halo LED lighting systems.



Special Features

- Got Nail!™ bar hangers
- q-Channel bars with Pass-N-Thru™
- Slide-N-Side™ junction box
- Quick Connect™ push wire nuts
- Air-Tite™ code compliant

Compatible Trims

5000	5020	5070	5126	5150	5186
5001	5021	5071	5130	5162	5222
5010	5051	5120	5135	5165	5230
5014	5054	5121	5145	5176	5255
5016	5060	5125	5146		



Trims for use in Halo listed housings



Select trims are classified for use in other housings, see www.cooperlighting.com/legal

Features

Housing

- Die-stamped aluminum
- Sealed and gasketed for Air-Tite™ ready installation
- Designed for insulated ceilings in direct contact with insulation* (May also be installed in non-insulated ceilings)

Plaster Frame

- Galvanized steel construction
- The housing can be removed from plaster frame to provide access to the junction box
- Plaster frame features include:
 - Patented regressed locking screw positioned for securing hanger bars from below the ceiling
 - Cutouts for easily crimping hanger bars in position
 - Halo name embossed on plaster frame
 - Pre-installed Air-Tite ready ceiling contact gasket

Includes:

- Got Nail!™ bar hangers (Details Pg. 13)
- q-Channel bars with Pass-N-Thru™ (Details Pg. 13)
- Slide-N-Side™ junction box wire traps (Details Pg. 13)
- Quick Connect™ push wire nuts (Details Pg. 13)
- Air-Tite™ code compliant (Details Pg. 13)

Socket

- Porcelain socket with nickel plated brass screw shell
- Snap-in springs secure socket to socket plate, and may be detached when using socket supporting trims
- Overspray protector included

Thermal Protector

Self resetting thermal protector deactivates fixture if overheating occurs due to improper lamping or misapplied insulation

Trims

Halo Fit-All concept offers multiple trim options in a variety of design styles, and functional beam distributions to control beam angle and lumen delivery in accommodating various lamp types including Halogen, CFL and LED

Compliance

- cULus Listed 1598 luminaire
- cULus Listed damp location
- cULus Listed for wet location, covered ceiling, with select trims
- cULus Listed for feed through
- cULus Listed for direct contact with insulation and combustible material*
- Air-Tite code compliant. Certified under ASTM E283; not exceeding 2.0 cfm (0.944 L/s) air leakage rate tested at a 1.57 psf (75 Pa) pressure differential
- RoHS compliant

*Not to be used in direct contact with spray foam insulation (Consult NEMA LSD57-2013)

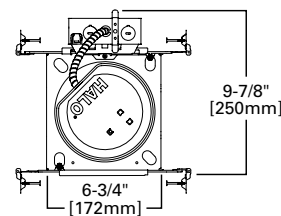
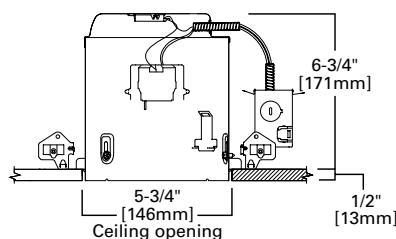

E51CATNB

5" IC, Air-Tite, New Construction Housing, No Socket Bracket, 120V

The E51CATNB is a compact and efficient recessed housing optimized and listed for EISA compliant, tungsten-halogen, CFL and LED lamps as well as incandescent. The Halo E5 housing is suitable for residential or light commercial applications. For installation in insulated ceilings* and non-insulated ceilings; with Air-Tite code compliant construction. Use with a variety of trims and finishes to create different lighting effects or to match any decor. The E51CATNB can save installation time. It is designed without a socket plate for use with socket supporting trims only. With these trims there is no need to spend time removing the socket plate and the fixed lamp position of socket supporting trims saves on lamp adjustment time too. May be retrofit with Halo LED lighting systems.





Special Features

- All-Nail!™ bar hangers
- q-Channel bars with Pass-N-Thru™
- Hinged j-box with Slide-N-Side™
- Quick Connect™ push wire nuts
- Air-Tite™ code compliant

Compatible Trims

5000	5020	5070	5126	5150	5186
5001	5021	5071	5130	5162	5222
5010	5051	5120	5135	5165	5230
5014	5054	5121	5145	5176	5255
5016	5060	5125	5146		

 Trims for use in Halo listed housings

 Select trims are classified for use in other housings, see www.cooperlighting.com/legal

Features

Housing

- Single wall die-formed aluminum housing
- Housing features a precision rolled interlocking collar which maintains aperture geometry for greater assurance of installation results
- Exclusive Air-Tite gasket meets code where required, and seals between housing, frame and finished ceiling - without need for additional caulk
- May be removed from the plaster frame to provide access to junction box

Plaster Frame

- Galvanized steel frame. Housing adjusts in plaster frame to accommodate up to 3/8" - 1" ceiling thickness
- (2) Regressed locking screws for securing hanger bars

Includes:

- All-Nail!™ bar hangers (Details Pg. 15)
- q-Channel bar hangers (Details Pg. 15)
- Hinged junction box with Slide-N-Side™ (Details Pg. 15)
- Quick Connect™ push wire nuts (Details Pg. 15)
- Air-Tite™ code compliant (Details Pg. 15)

Socket

- Porcelain socket with nickel plated brass screw shell
- Snap-in socket speeds installation and attaches directly to the trim for consistent lamp positioning
- Shipped with socket overspray protector installed

Thermal Protector

Self resetting thermal protector deactivates fixture if overheating occurs due to improper lamping or misapplied insulation

Trims

Halo Fit-All concept offers multiple trim options in a variety of design styles, and functional beam distributions to control beam angle and lumen delivery in accommodating various lamp types including Halogen, CFL and LED

Compliance

- cULus Listed 1598 luminaire
- cULus Listed damp location
- cULus Listed for wet location, covered ceiling, with select trims
- cULus Listed for direct contact with insulation and combustible material*
- Air-Tite code compliant. Certified under ASTM E283; not exceeding 2.0 cfm (0.944 L/s) air leakage rate tested at a 1.57 psf (75 Pa) pressure differential.
- RoHS compliant

*Not to be used in direct contact with spray foam insulation (Consult NEMA LSD57-2013).

E26 Screw Base IC Housing – No Socket Bracket

H25ICATNB

5
INCH

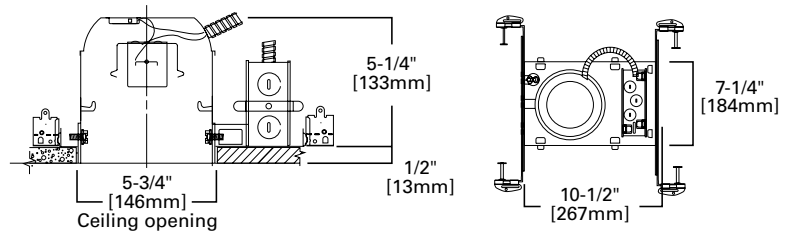

H25ICATNB

5" IC, Air-Tite, Shallow New Construction Housing, No Socket Bracket, 120V

H25ICATNB recessed housing is designed for residential and light commercial applications. The H25ICATNB is designed for use in shallow ceilings, and features full-frame robust construction, feed through listing, Got Nail! bar hangers; and may support the use of higher wattage lamps. The wide variety of trims available allows a number of different lighting effects to be created with one basic housing. The H25ICATNB is designed for use in shallow insulated ceilings and may be in direct contact with insulation*. The H25ICATNB can save installation time. It is designed without a socket plate for use with socket supporting trims only. With these trims there is no need to spend time removing the socket plate and the fixed lamp position of socket supporting trims saves on lamp adjustment time too. May be retrofit with compatible Halo LED lighting systems.



Special Features

- Got Nail!™ bar hangers
- q-Channel bars with Pass-N-Thru™
- Slide-N-Side™ junction box
- Quick Connect™ push wire nuts
- Air-Tite™ code compliant

Compatible Trims

5000	5060	5121	5135	5162	5176
5014	5070	5126	5145	5165	5186
5054	5071	5130	5150		

Trims for use in Halo listed housings

Select trims are classified for use in other housings, see www.cooperlighting.com/legal

Features

Housing

- Single wall aluminum housing
- Sealed and gasketed for Air-Tite™ ready installation
- Designed for insulated ceilings in direct contact with insulation* (May also be installed in non-insulated ceilings)
- Housing adjusts in plaster frame to accommodate up to 1-3/8" ceiling thickness

Plaster Frame

- Galvanized steel construction
- The housing can be removed from plaster frame to provide access to the junction box
- Plaster frame features include:
 - Patented regressed locking screw positioned for securing hanger bars from below the ceiling
 - Cutouts for easily crimping hanger bars in position
 - Halo name embossed on plaster frame
 - Pre-installed Air-Tite ready ceiling contact gasket

Includes:

- Got Nail!™ bar hangers (Details Pg. 13)
- q-Channel bars with Pass-N-Thru™ (Details Pg. 13)
- Slide-N-Side™ junction box wire traps (Details Pg. 13)
- Quick Connect™ push wire nuts (Details Pg. 13)
- Air-Tite™ code compliant (Details Pg. 13)

Socket

- Porcelain socket with nickel plated brass screw shell
- Snaps into trim for consistent lamp positioning
- Shipping insert protects socket from overspray

Thermal Protector

Self resetting thermal protector deactivates fixture if overheating occurs due to improper lamping or misapplied insulation

Trims

Halo Fit-All concept offers multiple trim options in a variety of design styles, and functional beam distributions to control beam angle and lumen delivery in accommodating various lamp types including Halogen, CFL and LED

Compliance

- cULus Listed 1598 luminaire
- cULus Listed damp location
- cULus Listed for wet location, covered ceiling, with select trims
- cULus Listed for feed through
- cULus Listed for direct contact with insulation and combustible material*
- Air-Tite code compliant. Certified under ASTM E283; not exceeding 2.0 cfm (0.944 L/s) air leakage rate tested at a 1.57 psf (75 Pa) pressure differential.
- RoHS compliant

*Not to be used in direct contact with spray foam insulation (Consult NEMA LSD57-2013)

Reflectors

5020 PAR Reflector

- Straight precision sided trim ring (fixed, not removable)
- Torsion spring retention
- Dual socket position for BR and PAR lamps
- Socket supporting integral bracket

Housings Max Lamp Compatibility

Housings	Max Lamp Compatibility
H5ICATNB	75W PAR30S, 60W BR30
E5ICATNB	5020P, 5020H, 5020SC, 5020BL: 60W PAR30S, 60W BR30 5020SN, 5020TBZ: 60W PAR30S, 50W BR30

Compatible with Halogen, Incandescent, LED* or CFL* lamps



5020P
White Reflector, White Trim



5020H
Haze Reflector, White Trim



5020SC
Specular Clear Reflector, White Trim



5020BL
Black Specular Reflector, White Trim



5020SN
Satin Nickel Reflector, Satin Nickel Trim



5020TBZ
Tuscan Bronze Reflector, Tuscan Bronze Trim

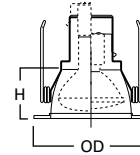

Dimensions**
H: 3-1/4" [82mm]
OD: 6-3/8" [162mm]

5021 Full Reflector

- Straight precision sided trim ring (fixed, not removable)
- Torsion spring retention
- For use with A-lamps
- Socket supporting reflector

Housings Max Lamp Compatibility

Housings	Max Lamp Compatibility
H5ICATNB	40W A19
E5ICATNB	29W A19

Compatible with Halogen, Incandescent, LED* or CFL* lamps



5021H
Haze Reflector, White Trim



5021SC
Specular Clear Reflector, White Trim



5021TBZ
Tuscan Bronze Reflector, Tuscan Bronze Trim

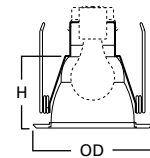

Dimensions**
H: 5" [127mm]
OD: 6-3/8" [162mm]

5120 Full Cone Reflector, Self-flange

- Full cone reflector
- Torsion spring retention
- Socket supporting
- Self-flange trim ring sized to hide gaps caused by construction tolerances

Housings Max Lamp Compatibility

Housings	Max Lamp Compatibility
H5ICATNB	5120WH: 29W A19, 50W PAR30S, 60W PAR30L, 65W BR30
E5ICATNB	5120SN, 5120TBZ: 29W A19, 50W PAR30S, 60W PAR30L, 50W BR30

Compatible with Halogen, Incandescent, LED* or CFL* lamps



5120WH
White Reflector, White Self-flange



5120SN
Satin Nickel Reflector, Satin Nickel Self-flange



5120TBZ
Tuscan Bronze Reflector, Tuscan Bronze Self-flange

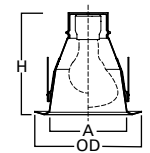

Dimensions**
A: 4-3/4" [121mm]
H: 6-1/4" [160mm]
OD: 6-5/8" [168mm]

*UL1993 listed LED & CFL equivalent lamps permitted. Consult lamp manufacturer for conditions of use. Eaton does not warranty the lamp.

**Key: A: Luminous Aperture, D: Depth Profile, H: Height, LH: Lens Height, OD: Trim Outside Diameter

E26 Screw Base Trims

IC "NB" Housings: H5ICATNB • E5ICATNB • H25ICATNB

5
INCH

5121 Shallow Full Cone Reflector, Self-flange

- Shallow full cone reflector
- Torsion spring retention
- Socket supporting
- Self-flange trim ring sized to hide gaps caused by construction tolerances



5121WH
White Reflector,
White Oversize Self-flange

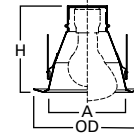

Dimensions**
A: 4-3/4" [121mm]
H: 5-1/3" [135mm]
OD: 6-5/8" [168mm]

Housings	Max Lamp Compatibility
H5ICATNB	50W PAR30S, 75W PAR30L, 65W BR30
E5ICATNB	50W PAR20, 50W PAR30S, 75W PAR30L, 65W BR30

Compatible with Halogen, Incandescent, LED* or CFL* lamps

Baffles

5001 PAR Metal Baffle Splay

- Straight precision sided trim ring (fixed, not removable)
- Torsion spring retention
- Dual socket position for BR and PAR lamps
- Socket supporting



5001P
White Baffle, White Trim



5001MB
Black Baffle, White Trim



5001SN
Satin Nickel Baffle,
Satin Nickel Trim



5001TBZ
Tuscan Bronze Baffle,
Tuscan Bronze Trim

Housings	Max Lamp Compatibility
H5ICATNB	35W PAR20, 75W PAR30S, 65W BR30, 30W R20
E5ICATNB	5001P: 35W PAR20, 60W PAR30S, 60W PAR30L, 65W BR30 5001MB, 5001SN, 5001TBZ: 35W PAR20, 60W PAR30S, 60W PAR30L, 60W BR30

Compatible with Halogen, Incandescent, LED* or CFL* lamps

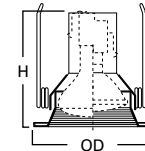

Dimensions**
H: 6-1/8" [152mm]
OD: 6-3/8" [156mm]

5010 PAR Metal Step Baffle

- Straight precision sided trim ring (fixed, not removable)
- Torsion spring retention
- Dual socket position for BR and PAR lamps
- Socket supporting



5010W
White Baffle, White Trim



5010
Black Baffle, White Trim

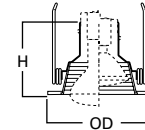

Dimensions**
H: 2" [52mm]
OD: 6-3/8" [156mm]

Housings	Max Lamp Compatibility
H5ICATNB	75W PAR30S, 60W R30, 60W BR30
E5ICATNB	60W PAR30S, 60W PAR30L, 60W BR30

Compatible with Halogen, Incandescent, LED* or CFL* lamps

5014 Shallow Metal Baffle, Self-flange

- For use in shallow housing
- Straight precision sided trim ring (fixed, not removable)
- Torsion spring retention
- Socket supporting



5014P
White Baffle, White Trim



5014MB
Black Baffle, White Trim

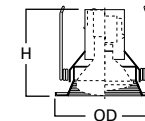

Dimensions**
A: 4-3/4" [121mm]
H: 2-3/8" [60mm]
OD: 6-3/8" [168mm]

Housings	Max Lamp Compatibility
H5ICATNB	
H25ICATNB	50W PAR30S, 75W PAR30L, 65W BR30
E5ICATNB	

Compatible with Halogen, Incandescent, LED* or CFL* lamps

*UL1993 listed LED & CFL equivalent lamps permitted. Consult lamp manufacturer for conditions of use. Eaton does not warranty the lamp.

**Key: A: Luminous Aperture, D: Depth Profile, H: Height, LH: Lens Height, OD: Trim Outside Diameter

5016 Coilex® Baffle with Reflector

- Straight precision sided trim ring (fixed, not removable)
- Torsion spring retention
- Dual socket position for BR and PAR lamps
- Socket supporting



5016W
White Baffle, White Trim



5016P
Black Baffle, White Trim

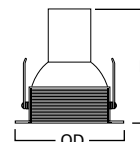

Dimensions**
H: 6-3/4" [171mm]
OD: 6-3/8" [162mm]

Housings Max Lamp Compatibility

H5ICATNB	60W PAR30S, 60W PAR30L,
E5ICATNB	50W BR30

Compatible with Halogen, Incandescent, LED* or CFL* lamps

5125 Full Cone Baffle, Self-flange

- Full cone baffle trim
- Torsion spring retention
- Socket supporting
- Self-flange trim ring sized to hide gaps caused by construction tolerances



5125WB
White Baffle, White Self-flange



5125BB
White Baffle, Black Self-flange



5125BKBB
Black Baffle, Black Self-flange

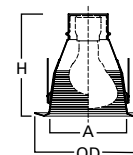

Dimensions:
A: 4-3/4" [121mm]
H: 6-1/4" [160mm]
OD: 6-5/8" [168mm]

Housings Max Lamp Compatibility

H5ICATNB	5125WB: 29W A19, 50W PAR30S, 60W PAR30L, 65W BR30
	5125BB & 5125BKBB:
E5ICATNB	29W A19, 50W PAR30S, 60W PAR30L, 50W BR30

Compatible with Halogen, Incandescent, LED* or CFL* lamps

5126 Shallow Full Cone Baffle, Self-flange

- Shallow full cone baffle
- Torsion spring retention
- Socket supporting
- Self-flange trim ring sized to hide gaps caused by construction tolerances



5126WB
White Baffle, White Self-flange



5126BB
Black Baffle, White Self-flange

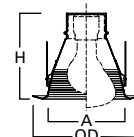

Dimensions**
A: 4-3/4" [121mm]
H: 5-1/3" [135mm]
OD: 6-5/8" [168mm]

Housings Max Lamp Compatibility

H5ICATNB	50W PAR30S, 75W PAR30L,
E5ICATNB	65W BR30
H25ICATNB	5126WB: 50W PAR20, 50W PAR30S, 75W PAR30L, 65W BR30
	5126BB: 50W PAR20, 50W PAR30S, 60W PAR30L, 50W BR30

Compatible with Halogen, Incandescent, LED* or CFL* lamps

Adjustable – Eyeballs & Gimbals

5060 Adjustable Gimbal 20° Tilt, Self-flange

- Straight precision sided trim ring (fixed, not removable)
- For directional accent lighting
- Torsion spring retention
- 20° tilt - 360° rotation
- Socket supporting



5060P
White Gimbal, White Trim

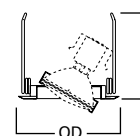

Dimensions**
H: 3-1/4" [82mm]
OD: 6-3/8" [162mm]

Housings Max Lamp Compatibility

H5ICATNB	
E5ICATNB	50W PAR30S
H25ICATNB	

Compatible with Halogen, Incandescent, LED* or CFL* lamps

*UL1993 listed LED & CFL equivalent lamps permitted. Consult lamp manufacturer for conditions of use. Eaton does not warranty the lamp.

**Key: A: Luminous Aperture, D: Depth Profile, H: Height, LH: Lens Height, OD: Trim Outside Diameter

E26 Screw Base Trims

IC "NB" Housings: H51CATNB • E51CATNB • H251CATNB

5
INCH

5070 Adjustable Eyeball 30° Tilt, Self-flange

- Straight precision sided trim ring (fixed, not removable)
- For directional accent lighting
- Torsion spring retention
- 30° tilt - 360° rotation
- Socket supporting



5070P
White Eyeball, White Trim



5070SN
Satin Nickel Eyeball,
Satin Nickel Trim



5070TBZ
Tuscan Bronze Eyeball,
Tuscan Bronze Trim

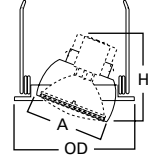

Dimensions**
A: 3-7/8" [98mm]
H: 3-3/8" [86mm]
OD: 6-3/8" [162mm]

Housings Max Lamp Compatibility

H51CATNB	
E51CATNB	75W PAR30S
H251CATNB	

Compatible with Halogen, Incandescent, LED* or CFL* lamps

5071 Adjustable Eyeball 30° Tilt, Self-flange

- Straight precision sided trim ring (fixed, not removable)
- For directional accent lighting
- Torsion spring retention
- 30° tilt - 360° rotation
- Socket supporting



5071P
White Eyeball, White Trim

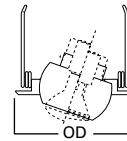

Dimensions**
OD: 6-1/2" [165mm]

Housings Max Lamp Compatibility

H51CATNB	
H251CATNB	50W PAR20, 50W R20
E51CATNB	50W PAR20

Compatible with Halogen, Incandescent, LED* or CFL* lamps

5130 Eyeball 35° Tilt, Self-flange

- Adjustable 35° tilt, 360° rotation
- Design optimized for PAR30S (short-neck) lamps
- Torsion spring retention
- Socket supporting eyeball
- Self-flange trim ring sized to hide gaps caused by construction tolerances



5130WH
White Eyeball, White Trim

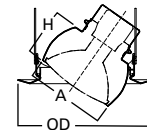

Dimensions**
A: 3-7/8" [98mm]
H: 2-1/4" [58mm]
OD: 6-5/8" [168mm]

Housings Max Lamp Compatibility

H51CATNB	
E51CATNB	75W PAR30S
H251CATNB	

Compatible with Halogen, Incandescent, LED* or CFL* lamps

*UL1993 listed LED & CFL equivalent lamps permitted. Consult lamp manufacturer for conditions of use. Eaton does not warranty the lamp.

**Key: A: Luminous Aperture, D: Depth Profile, H: Height, LH: Lens Height, OD: Trim Outside Diameter

5135 Eyeball 35° Tilt, Self-flange

- Conical adjustable eyeball trim for PAR20 lamps
- Torsion spring retention
- Socket supporting
- 35° tilt, 360° rotation
- Self-flange trim ring sized to hide gaps caused by construction tolerances



5135WH
White Eyeball, White Trim, Self-flange

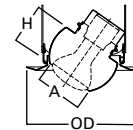

Dimensions**
A: 2-3/4" [70mm]
H: 2-1/4" [58mm]
OD: 6-5/8" [168mm]

Housings Max Lamp Compatibility

H5ICATNB

E5ICATNB 50W PAR20

H25ICATNB

Compatible with Halogen, Incandescent, LED* or CFL* lamps

5165 Gimbal 35° Tilt, Self-flange

- Adjustable gimbal trim for PAR30S (short-neck) lamps
- Torsion spring retention
- Socket supporting
- 35° tilt, 360° rotation
- Self-flange trim ring sized to hide gaps caused by construction tolerances



5165WH
White Gimbal, White Trim



5165BK
Black Gimbal, Black Trim



5165SN
Satin Nickel Gimbal, Satin Nickel Trim



5165TBZ
Tuscan Bronze Gimbal, Tuscan Bronze Trim

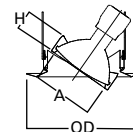

Dimensions**
A: 3-3/8" [85mm]
H: 1-1/8" [29mm]
OD: 6-5/8" [168mm]

Housings Max Lamp Compatibility

H5ICATNB

E5ICATNB 50W PAR30S

H25ICATNB

Compatible with Halogen, Incandescent, LED* or CFL* lamps

5222 Regressed Angle Cut Adjustable Gimbal, 30° Tilt, Self-flange

- Fully regressed gimbal
- Torsion spring retention
- 30° tilt, 360° rotation
- Socket supporting
- Angle cut - cone reflector and baffle options
- Accommodates tilt of gimbal in a full regressed cut cone
- Self-flange trim ring sized to hide gaps caused by construction tolerances



5222WB
White Baffle & Gimbal, White Trim



5222BB
Black Baffle & Gimbal, White Trim



5222SC
Specular Clear Reflector & Gimbal, White Trim



5222H
Haze Reflector & Gimbal, White Trim

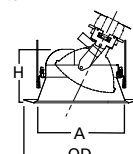

Dimensions**
A: 5" [127mm]
H: 3-1/8" [79mm]
OD: 6-5/8" [168mm]

Housings Max Lamp Compatibility

H5ICATNB

E5ICATNB 39W PAR30S, 60W PAR30L

H25ICATNB

Compatible with Halogen, Incandescent, LED* or CFL* lamps

*UL1993 listed LED & CFL equivalent lamps permitted. Consult lamp manufacturer for conditions of use. Eaton does not warranty the lamp.

**Key: A: Luminous Aperture, D: Depth Profile, H: Height, LH: Lens Height, OD: Trim Outside Diameter

E26 Screw Base Trims

IC "NB" Housings: H51CATNB • E51CATNB • H251CATNB

5
INCH

Lenses & Wet Location Showerlights



5051 Frosted Glass Lens

- Frosted glass lens
- Straight precision sided trim ring
- "Dead-Front" construction, wet location listed Showerlight
- Non-conductive, non-corrosive gasketed polymer trim ring
- Torsion spring retention



5051PS
Frosted Glass Lens, White Trim

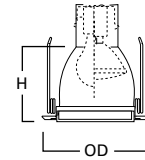

Dimensions**
H: 5-9/16" [141mm]
OD: 6-7/16" [164mm]

Housings Max Lamp Compatibility

H51CATNB	35W PAR30L
E51CATNB	

Compatible with Halogen, Incandescent, LED* or CFL* lamps

5054 Frosted Glass Dome Lens

- Frosted glass dome lens
- Straight precision sided trim ring
- "Dead-Front" construction, wet location listed Showerlight
- Non-conductive, non-corrosive gasketed polymer trim ring
- Torsion spring retention



5054PS
Frosted Glass Dome,
White Trim



5054SNS
Frosted Glass Dome,
Satin Nickel Trim



5054TBZS
Frosted Glass Dome,
Tuscan Bronze Trim

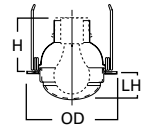

Dimensions**
LH: 1-3/4" [45mm]
H: 4-1/2" [114mm]
OD: 6-3/8" [162mm]

Housings Max Lamp Compatibility

H51CATNB	40W A19, 50W PAR30S
E51CATNB	
H251CATNB	

Compatible with Halogen, Incandescent, LED* or CFL* lamps

5150 Low Profile, Frosted Glass Dome Lens, Self-flange

- Low profile, frosted glass dome lens
- Wet location Showerlight
- Torsion spring retention
- Non-conductive "dead-front" polymer (plastic) trim ring and glass lens
- Socket supporting internal reflector
- Self-flange trim ring sized to hide gaps caused by construction tolerances



5150WH
Frosted Glass Dome Lens
with Reflector, White
Plastic Self-flange



5150SN
Frosted Glass Dome Lens
with Reflector, Satin Nickel
Plastic Self-flange



5150TBZ
Frosted Glass Dome Lens
with Reflector, Tuscan Bronze
Plastic Self-flange

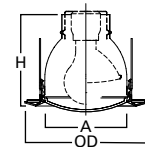

Dimensions**
A: 4-1/2" [114mm]
H: 5" [126mm]
OD: 6-5/8" [168mm]

Housings Max Lamp Compatibility

H51CATNB	29W A19, 39W PAR30S
E51CATNB	
H251CATNB	29W A19

Compatible with Halogen, Incandescent, LED* or CFL* lamps

*UL1993 listed LED & CFL equivalent lamps permitted. Consult lamp manufacturer for conditions of use. Eaton does not warranty the lamp.

**Key: A: Luminous Aperture, D: Depth Profile, H: Height, LH: Lens Height, OD: Trim Outside Diameter



5162 Drop Opal Plastic Lens, Self-flange

- Drop opal plastic lens
- Wet location Showerlight
- Non-conductive "dead-front" polymer (plastic) trim
- Torsion spring retention
- Socket supporting internal reflector
- Self-flange trim ring sized to hide gaps caused by construction tolerances



5162WH
Drop Opal Plastic Lens with Reflector, White Plastic Self-flange

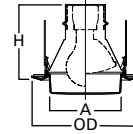

Dimensions**
A: 4-1/2" [114mm]
H: 5-5/8" [118mm]
OD: 6-5/8" [168mm]

Housings Max Lamp Compatibility

H51CATNB

E51CATNB 29W A19

H251CATNB

Compatible with Halogen, Incandescent, LED* or CFL* lamps

5230 Squirrel Frost Glass Lens, Metal Trim, Self-flange

- Low profile frost glass lens
- Wet location Showerlight
- Torsion spring retention
- Self-flange low profile metal trim ring
- Socket supporting internal bracket
- Integral rotation adjustment up to +/- 25° for precise alignment with room



5230AH
Frost Glass Lens, Aluminum Haze Squirrel Trim



5230PN
Frost Glass Lens, Polished Nickel Squirrel Trim



5230SN
Frost Glass Lens, Satin Nickel Squirrel Trim



5230TBZ
Frost Glass Lens, Tuscan Bronze Squirrel Trim

Housings Max Lamp Compatibility

H51CATNB Consult website

E51CATNB www.cooperlighting.com

Compatible with Halogen, Incandescent, LED* or CFL* lamps



5255 Soft Square, Frost Curved Glass Lens, Self-flange

- Low profile curved frost glass lens
- Wet location Showerlight
- Torsion spring retention
- Non-conductive "dead-front" polymer (plastic) trim and glass lens
- Integral rotation adjustment up to +/- 25° for precise alignment with room
- Integrated socket supporting reflector for illumination across lens corner-to-corner



5255WH
Frost Curved Glass Lens with Reflector, White Plastic Self-flange



5255SN
Frost Curved Glass Lens with Reflector, Satin Nickel Plastic Self-flange



5255TBZ
Frost Curved Glass Lens with Reflector, Tuscan Bronze Plastic Self-flange

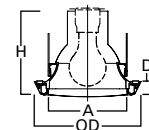

Dimensions**
A: 5-1/8" [130mm]
D: 1" [26mm]
H: 5-1/2" [140mm]
OD: 6-7/8" [174mm]

Housings Max Lamp Compatibility

H51CATNB 29W A19

E51CATNB

Compatible with Halogen, Incandescent, LED* or CFL* lamps



*UL1993 listed LED & CFL equivalent lamps permitted. Consult lamp manufacturer for conditions of use. Eaton does not warranty the lamp.

**Key: A: Luminous Aperture, D: Depth Profile, H: Height, LH: Lens Height, OD: Trim Outside Diameter

E26 Screw Base Trims

IC "NB" Housings: H51CATNB • E51CATNB • H251CATNB

5
INCH



5145 Open Wet Location, Shallow Reflector, Self-flange

- Open wet location Showerlight for PAR30S and PAR30L outdoor rated lamps ONLY
- Torsion spring retention
- Socket supporting
- Self-flange trim ring sized to hide gaps caused by construction tolerances
- For use in standard and shallow housings



5145WH
White Self-flange



5145SN
Satin Nickel Self-flange



5145TBZ
Tuscan Bronze Self-flange

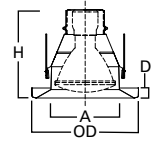

Dimensions**
A: 4-5/8" [117mm]
D: 5/8" [16mm]
H: 5-3/8" [138mm]
OD: 6-5/8" [168mm]

Housings Max Lamp Compatibility

H51CATNB	5145WH: 75W PAR30S, 75W PAR30L
E51CATNB	5145SN, 5145TBZ: 60W PAR30S,
H251CATNB	75W PAR30L

Compatible with Halogen, Incandescent, LED* or CFL* lamps



Lamp Gasket
(Included)

5146 Open Wet Location Full Reflector, Self-flange

- Open wet location Showerlight for PAR30S and PAR30L outdoor rated lamps ONLY
- Torsion spring retention
- Socket supporting
- Self-flange trim ring sized to hide gaps caused by construction tolerances



5146WH
White Self-flange



5146SN
Satin Nickel Self-flange



5146TBZ
Tuscan Bronze Self-flange

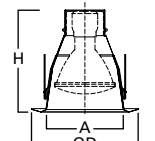

Dimensions**
A: 4-3/4" [121mm]
H: 6-1/4" [160mm]
OD: 6-5/8" [168mm]

Housings Max Lamp Compatibility

H51CATNB	50W PAR30S, 60W PAR30L
E51CATNB	

Compatible with Halogen, Incandescent, LED* or CFL* lamps



Lamp Gasket
(Included)

Open, Splay & Wall Wash

5000 PAR Metal Splay, Self-flange

- Straight precision sided trim ring (fixed, not remodeled)
- Open metal splay trim
- Dual socket position socket for BR and PAR lamps
- Torsion spring retention
- Socket supporting



5000P
White Splay, White Trim



5000SN
Satin Nickel Splay,
Satin Nickel Trim



5000TBZ
Tuscan Bronze Splay,
Tuscan Bronze Trim

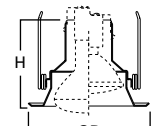

Dimensions**
H: 4-5/8" [118mm]
OD: 6-3/8" [162mm]

Housings Max Lamp Compatibility

H51CATNB	65W BR30, 75W R30, 75W PAR30, 75W PAR30L
E51CATNB	5000P: 60W PAR30S, 60W PAR30L, 65W BR30 5000SN, 5000TBZ: 60W PAR30S, 60W PAR30L, 60W BR30
H251CATNB	60W BR30, 50W PAR30, 50W PAR30L

Compatible with Halogen, Incandescent, LED* or CFL* lamps

*UL1993 listed LED & CFL equivalent lamps permitted. Consult lamp manufacturer for conditions of use. Eaton does not warranty the lamp.

**Key: A: Luminous Aperture, D: Depth Profile, H: Height, LH: Lens Height, OD: Trim Outside Diameter

E26 Screw Base Trims

IC "NB" Housings: H51CATNB • E51CATNB • H251CATNB

5176 Open, Wide Self-flange

- Open trim for BR30 & PAR30 lamps
- Torsion spring retention
- Socket supporting integral bracket
- Self-flange trim ring sized to hide gaps caused by construction tolerances

Housings Max Lamp Compatibility

H51CATNB	60W PAR30S, 60W PAR30L, 50W BR30
E51CATNB	
H251CATNB	

Compatible with Halogen, Incandescent, LED* or CFL* lamps



5176WH
White Self-flange



5176SN
Satin Nickel Self-flange



5176TBZ
Tuscan Bronze Self-flange

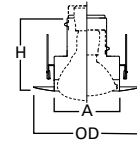

Dimensions**
A: 3-7/8" [99mm]
H: 4-3/4" [120mm]
OD: 6-5/8" [168mm]

5186 Splay, Self-flange

- Splay trim for BR30 & PAR30 lamps
- Torsion spring retention
- Socket supporting integral bracket
- Self-flange trim ring sized to hide gaps caused by construction tolerances

Housings Max Lamp Compatibility

H51CATNB	60W PAR30S, 60W PAR30L, 50W BR30
E51CATNB	
H251CATNB	

Compatible with Halogen, Incandescent, LED* or CFL* lamps



5186WH
White Self-flange



5186SN
Satin Nickel Self-flange



5186TBZ
Tuscan Bronze Self-flange

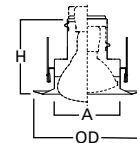

Dimensions**
A: 3-7/8" [99mm]
H: 4-7/8" [123mm]
OD: 6-5/8" [168mm]

*UL1993 listed LED & CFL equivalent lamps permitted. Consult lamp manufacturer for conditions of use. Eaton does not warranty the lamp.

**Key: A: Luminous Aperture, D: Depth Profile, H: Height, LH: Lens Height, OD: Trim Outside Diameter



E26 Screw Base Non-Insulated Ceiling housings & Trims

Quick Reference – Non-IC

5
INCH

Trim #	Style	H5T	H5RT	E5TAT	E5RTAT	H5TNB	E5TATNB
5000	Splay	•	•	•	•	•	•
5001	Baffle	•	•	•	•	•	•
5010	Baffle	•	•	•	•	•	•
5012	Baffle	•	•	•	•	•	•
5016	Baffle	•	•	•	•	•	•
5020	Reflector	•	•	•	•	•	•
5021	Reflector	•	•	•	•	•	•
5030	Wall Wash	•	•	•	•	•	•
5051	Showerlight	•	•	•	•	•	•
5054	Showerlight	•	•	•	•	•	•
5060	Adjustable	•	•	•	•	•	•
5070	Adjustable	•	•	•	•	•	•
5071	Adjustable	•	•	•	•	•	•
5102	Baffle	•	•	•	•	—	—
5107	Reflector	•	•	•	•	—	—
5109	Baffle	•	•	•	•	—	—
5110	Baffle	•	•	•	•	—	—
5120	Reflector	•	•	•	•	•	•
5125	Baffle	•	•	•	•	•	•
5130	Adjustable	•	•	•	•	•	•
5135	Adjustable	•	•	•	•	•	•
5145	Open Showerlight	•	•	•	•	•	•
5146	Open Showerlight	•	•	•	•	•	•
5150	Showerlight	•	•	•	•	•	•
5162	Showerlight	•	•	•	•	•	•
5165	Adjustable	•	•	•	•	•	•
5175	Open	•	•	•	•	—	—
5176	Open	•	•	•	•	•	•
5185	Splay	•	•	•	•	—	—
5186	Splay	•	•	•	•	•	•
5222	Adjustable	•	•	•	•	•	•
5230	Showerlight	•	•	•	•	•	•
5255	Showerlight	•	•	•	•	•	•



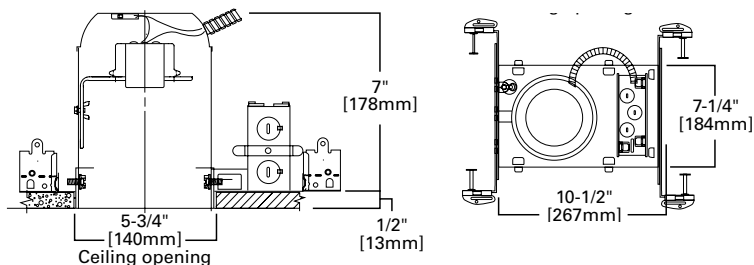

H5T

5" Non-IC, New Construction Housing, 120V

The H5T recessed housing is designed for residential and light commercial applications. H5T features full-frame robust construction, feed through listing, Got Nail! bar hangers, and may support the use of higher wattage lamps. The wide variety of trims available allows a number of different lighting effects to be created with one basic housing. The H5T is designed for use non-insulated ceilings. If insulation is present it must be kept 3" from all sides of the housing. May be retrofit with compatible Halo LED lighting systems.



Special Features

- Got Nail!™ bar hangers
- q-Channel bars with Pass-N-Thru™
- Slide-N-Side™ junction box
- Quick Connect™ push wire nuts

Compatible Trims

5000	5021	5071	5125	5150	5185
5001	5030	5102	5130	5162	5186
5010	5051	5107	5135	5165	5222
5012	5054	5109	5145	5175	5230
5016	5060	5110	5146	5176	5255
5020	5070	5120			



Trims for use in Halo listed housings



Select trims are classified for use in other housings, see www.cooperlighting.com/legal

Features

Housing

- Single wall die-stamped CRS with white powder coat finish
- Housing adjusts in plaster frame to accommodate up to 1-3/8" ceiling thickness

Plaster Frame

- Galvanized steel construction
- The housing can be removed from plaster frame to provide access to the junction box
- Plaster frame features include:
 - Patented regressed locking screw positioned for securing hanger bars from below the ceiling
 - Cutouts for easily crimping hanger bars in position
 - Halo name embossed on plaster frame

Socket Plate

- Rigid socket plate adjusts and locks without tools for various lamp sizes
- Socket plate and bracket may be removed when using socket supporting trims
- Overspray protector included

Includes:

- Got Nail!™ bar hangers (Details Pg. 13)
- q-Channel bars with Pass-N-Thru™ (Details Pg. 13)
- Slide-N-Side™ junction box wire traps (Details Pg. 13)
- Quick Connect™ push wire nuts (Details Pg. 13)

Socket

- Porcelain socket with nickel plated brass screw shell
- Snaps into trim for consistent lamp positioning
- Shipping insert protects socket from overspray

Thermal Protector

Self resetting thermal protector deactivates fixture if overheating occurs due to improper lamping or misapplied insulation

Trims

Halo Fit-All concept offers multiple trim options in a variety of design styles, and functional beam distributions to control beam angle and lumen delivery in accommodating various lamp types including Halogen, CFL and LED

Compliance

- cULus Listed 1598 luminaire
- cULus Listed damp location
- cULus Listed for wet location, covered ceiling, with select trims
- cULus Listed for feed through
- IP rated (Improper Lamp)
- RoHS compliant

E26 Screw Base Non-IC Housing

H5RT

5
INCH

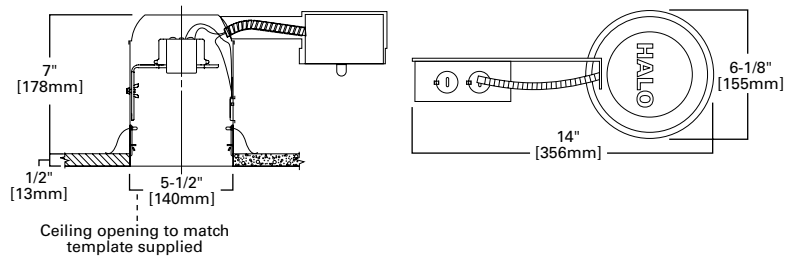

H5RT

5" Non-IC, Remodel Housing, 120V

The H5RT recessed housing is designed for residential and light commercial applications. H5RT remodel housing features robust construction and may support the use of higher wattage lamps. The wide variety of trims available allows a number of different lighting effects to be created with one basic housing. The H5RT is for use non-insulated ceilings. If insulation is present it must be kept 3" from all sides of the housing. Remodel housing is designed for installation from below the finished ceiling. May be retrofit with compatible Halo LED lighting systems.



Special Features

Quick Connect™ push wire nuts

Compatible Trims

5000	5021	5071	5125	5150	5185
5001	5030	5102	5130	5162	5186
5010	5051	5107	5135	5165	5222
5012	5054	5109	5145	5175	5230
5016	5060	5110	5146	5176	5255
5020	5070	5120			



Trims for use in Halo listed housings



Select trims are classified for use in other housings, see www.cooperlighting.com/legal

Features

Housing

- Single wall die-stamped CRS with white powder coat finish
- For installation from below finished ceiling
Integral flange secures fixture against ceiling

Remodel Springs

Four remodel clips secure housing and accommodate 1/2" and 5/8" ceiling material

Junction Box

- Seven 1/2" trade size conduit knockouts with true pry-out slots
- Four type non-metallic (NM) cable pry-outs simplify installation

Includes:

- Quick Connect™ push wire nuts (Details Pg. 13)

Socket

- Porcelain socket with nickel plated brass screw shell
- Snaps into trim for consistent lamp positioning
- Overspray protector included

Socket Plate

- Rigid socket plate adjusts and locks without tools for various lamp sizes
- Socket plate and bracket may be removed when using socket supporting trims

Thermal Protector

Self resetting thermal protector deactivates fixture if overheating occurs due to improper lamping or misapplied insulation

Trims

Halo Fit-All concept offers multiple trim options in a variety of design styles, and functional beam distributions to control beam angle and lumen delivery in accommodating various lamp types including Halogen, CFL and LED

Compliance

- cULus Listed 1598 luminaire
- cULus Listed for damp location
- cULus Listed for wet location, covered ceiling, with select trims
- cULus Listed for feed through
- IP rated (Improper Lamp)
- RoHS compliant

5
INCH

E26 Screw Base Non-IC Housing

E5TAT

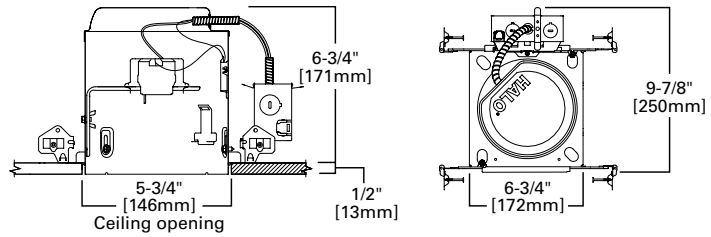

E5TAT

5" Non-IC, Air-Tite, New Construction Housing, 120V

The E5TAT is a compact and efficient recessed housing optimized and listed for EISA compliant, tungsten-halogen, CFL and LED lamps as well as incandescent. E5TAT housing is for use in non-insulated ceilings, suitable for residential or light commercial applications; with Air-Tite code compliant construction. Use with a variety of trims and finishes to create different lighting effects or to match any decor. E5TAT is designed for use in non-insulated ceilings, if insulation is present it must be kept 3" from all sides of the housing. May be retrofit with compatible Halo LED lighting systems.



Special Features

- All-Nail!™ bar hangers
- q-Channel bars with Pass-N-Thru™
- Hinged j-box with Slide-N-Side™
- Quick Connect™ push wire nuts
- Air-Tite™ code compliant

Compatible Trims

5000	5021	5071	5125	5150	5185
5001	5030	5102	5130	5162	5186
5010	5051	5107	5135	5165	5222
5012	5054	5109	5145	5175	5230
5016	5060	5110	5146	5176	5255
5020	5070	5120			

Trims for use in Halo listed housings

Select trims are classified for use in other housings, see www.cooperlighting.com/legal

Features

Housing

- Single wall die-formed housing
- Housing features a precision rolled interlocking collar which maintains aperture geometry for greater assurance of installation results
- Exclusive Air-Tite gasket meets code where required, and seals between housing, frame and finished ceiling - without need for additional caulk
- May be removed from the plaster frame to provide access to junction box

Socket Plate

- Rigid socket plate adjusts and locks without tools for various lamp sizes
- Socket plate and bracket may be removed when using socket supporting trims

Plaster Frame

- Galvanized steel frame. Housing adjusts in plaster frame to accommodate up to 3/8" - 1" ceiling thickness
- (2) Regressed locking screws for securing hanger bars

Includes:

- All-Nail!™ bar hangers (Details Pg. 15)
- q-Channel bar hangers (Details Pg. 15)
- Hinged junction box with Slide-N-Side™ (Details Pg. 15)
- Quick Connect™ push wire nuts (Details Pg. 15)
- Air-Tite™ code compliant (Details Pg. 15)

Socket

- Porcelain socket with nickel plated brass screw shell
- Snap-in springs secure socket to socket plate, and may be detached when using socket supporting trims
- Shipped with socket overspray protector installed

Thermal Protector

Self resetting thermal protector deactivates fixture if overheating occurs due to improper lamping or misapplied insulation

Trims

Halo Fit-All concept offers multiple trim options in a variety of design styles, and functional beam distributions to control beam angle and lumen delivery in accommodating various lamp types including Halogen, CFL and LED

Compliance

- cULus Listed 1598 luminaire
- cULus Listed damp location
- cULus Listed for wet location, covered ceiling, with select trims
- Air-Tite code compliant. Certified under ASTM E283; not exceeding 2.0 cfm (0.944 L/s) air leakage rate tested at a 1.57 psf (75 Pa) pressure differential
- RoHS compliant

E26 Screw Base Non-IC Housing

E5RTAT

5
INCH



E5RTAT

5" Non-IC, Air-Tite, Remodel Housing, 120V

The E5RTAT is a compact and efficient recessed housing optimized and listed for EISA compliant, tungsten-halogen, CFL and LED lamps as well as incandescent. E5RTAT remodel housing is for use in non-insulated ceilings, suitable for residential or light commercial applications; with Air-Tite code compliant construction. Use with a variety of trims and finishes to create different lighting effects or to match any decor. This remodel housing is designed for installation from below the finished ceiling. As E5RTAT is for use in non-insulated ceilings, if insulation is present it must be kept 3" from all sides of the housing. May be retrofit with Halo LED lighting systems.

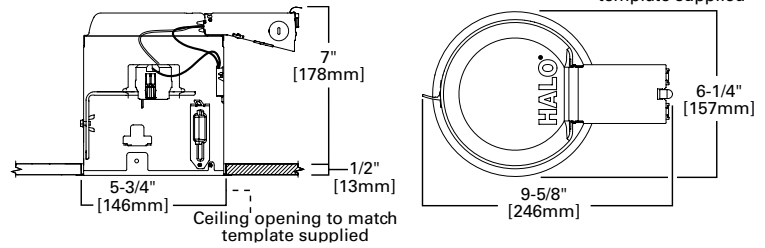

Special Features

- Hinged j-box with Slide-N-Side™
- Quick Connect™ wiring tray
- Air-Tite™ code compliant

Compatible Trims

5000	5021	5071	5125	5150	5185
5001	5030	5102	5130	5162	5186
5010	5051	5107	5135	5165	5222
5012	5054	5109	5145	5175	5230
5016	5060	5110	5146	5176	5255
5020	5070	5120			



Trims for use in Halo listed housings



Select trims are classified for use in other housings, see www.cooperlighting.com/legal

Features

Housing

- Single wall die-formed housing
- Die formed flange maintains aperture geometry for greater assurance of installation results
- Exclusive Air-Tite gasket meets code where required, and seals between housing, flange and finished ceiling - without need for additional caulk
- For installation from below the finished ceiling. Integral flange secures fixture against ceiling.

Remodel Retention System - Speed Clamps

- Exclusive two integral speed clamps securely lock housing to ceiling, accommodating 3/8" to 2" ceiling materials

Socket Plate

- Rigid socket plate adjusts and locks without tools for various lamp sizes
- Socket plate and bracket may be removed when using socket supporting trims

Includes:

- Hinged junction box with Slide-N-Side™ (Details Pg. 15)
- Quick Connect™ wiring tray (Details Pg. 15)
- Air-Tite™ code compliant (Details Pg. 15)

Socket

- Porcelain socket with nickel plated brass screw shell
- Socket snaps into socket plate for consistent lamp positioning
- Shipped with socket overspray protector installed

Thermal Protector

Self resetting thermal protector deactivates fixture if overheating occurs due to improper lamping or misapplied insulation

Trims

Halo Fit-All concept offers multiple trim options in a variety of design styles, and functional beam distributions to control beam angle and lumen delivery in accommodating various lamp types including Halogen, CFL and LED

Quick Connect™ Wiring Tray

- (3) Color coded 4-port push-in wire nuts included
- Captive tray holds push-nuts in place for one-handed connections to line, neutral & ground
- Speeds installation and increases reliability
- No additional wire nuts required

Compliance

- cULus Listed 1598 luminaire
- cULus Listed damp location
- cULus Listed for wet location, covered ceiling, with select trims
- Air-Tite code compliant. Certified under ASTM E283; not exceeding 2.0 cfm (0.944 L/s) air leakage rate tested at a 1.57 psf (75 Pa) pressure differential
- RoHS compliant

Reflectors

5020 PAR Reflector

- Straight precision sided trim ring (fixed, not removable)
- Torsion spring retention
- Dual socket position for BR and PAR lamps
- Socket supporting

Housings Max Lamp Compatibility

H5T	H5RT	75W PAR30S, 75W PAR30L, 65W BR30, 75W R30
E5TAT	E5RTAT	75W PAR30S, 75W PAR30L, 65W BR30

Compatible with Halogen, Incandescent, LED* or CFL* lamps



5020P
White Reflector, White Trim



5020H
Haze Reflector, White Trim



5020SC
Specular Clear Reflector, White Trim



5020BL
Black Specular Reflector, White Trim



5020SN
Satin Nickel Reflector, Satin Nickel Trim



5020TBZ
Tuscan Bronze Reflector, Tuscan Bronze Trim

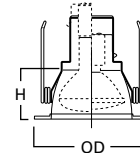

Dimensions**
H: 3-1/4" [82mm]
OD: 6-3/8" [162mm]

5021 Full Reflector

- Straight precision sided trim ring (fixed, not removable)
- Torsion spring retention
- For use with A-Lamps
- Socket supporting

Housings Max Lamp Compatibility

H5T	H5RT	60W A19
E5TAT	E5RTAT	

Compatible with Halogen, Incandescent, LED* or CFL* lamps



5021H
Haze Reflector, White Trim



5021SC
Specular Clear Reflector, White Trim



5021TBZ
Tuscan Bronze Reflector, Tuscan Bronze Trim

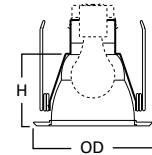

Dimensions**
H: 5" [127mm]
OD: 6-3/8" [162mm]

5107 Tapered Reflector, Self-flange

- Self-flange reflector cone
- Contoured tapered sides of cone reflector for BR30 and PAR30 lamps
- Coil spring retention
- Self-flange trim ring sized to hide gaps caused by construction tolerances

Housings Max Lamp Compatibility

H5T	H5RT	75W PAR30S, 75W PAR30L, 65W BR30
E5TAT	E5RTAT	

Compatible with Halogen, Incandescent, LED* or CFL* lamps



5107SC
Specular Clear Reflector, White Self-flange

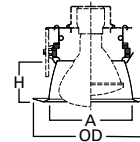

Dimensions**
A: 4-3/4" [121mm]
H: 2-3/8" [60mm]
OD: 6-5/8" [168mm]

5120 Full Cone Reflector, Self-flange

- Full cone reflector
- Torsion spring retention
- Socket supporting
- Self-flange trim ring sized to hide gaps caused by construction tolerances

Housings Max Lamp Compatibility

H5T	H5RT	60W A19, 75W PAR30S, 65W BR30
E5TAT	E5RTAT	

Compatible with Halogen, Incandescent, LED* or CFL* lamps



5120WH
White Reflector, White Self-flange



5120SN
Satin Nickel Reflector, Satin Nickel Self-flange



5120TBZ
Tuscan Bronze Reflector, Tuscan Bronze Self-flange

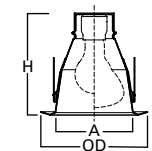

Dimension**
A: 4-3/4" [121mm]
H: 6-1/4" [160mm]
OD: 6-5/8" [168mm]

*UL1993 listed LED & CFL equivalent lamps permitted. Consult lamp manufacturer for conditions of use. Eaton does not warranty the lamp.

**Key: A: Luminous Aperture, D: Depth Profile, H: Height, LH: Lens Height, OD: Trim Outside Diameter

E26 Screw Base Trims

Non-IC Housings: H5T • H5RT • E5TAT • E5RTAT

5
INCH

Baffles

5001 PAR Metal Baffle Splay

- Straight precision sided trim ring (fixed, not removable)
- Torsion spring retention
- Dual socket position for BR and PAR lamps
- Socket supporting

Housings		Max Lamp Compatibility
H5T	H5RT	50W PAR20, 75W PAR30S, 75W PAR30L, 65W BR30, 50W R20, 75W R30
E5TAT	E5RTAT	50W PAR20, 75W PAR30S, 75W PAR30L, 65W BR30

Compatible with Halogen, Incandescent, LED* or CFL* lamps



5001P
White Baffle, White Trim



5001MB
Black Baffle, White Trim



5001SN
Satin Nickel Baffle,
Satin Nickel Trim



5001TBZ
Tuscan Bronze Baffle,
Tuscan Bronze Trim

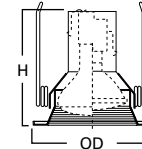

Dimensions**
H: 6-1/8" [152mm]
OD: 6-3/8" [156mm]

5010 PAR Metal Step Baffle

- Straight precision sided trim ring (fixed, not removable)
- Torsion spring retention
- Dual socket position for BR and PAR lamps
- Socket supporting

Housings		Max Lamp Compatibility
H5T	H5RT	75W PAR30S, 75W PAR30L, 65W BR30, 75W R30
E5TAT	E5RTAT	75W PAR30S, 75W PAR30L, 65W BR30

Compatible with Halogen, Incandescent, LED* or CFL* lamps



5010W
White Baffle, White Trim



5010
Black Baffle, White Trim

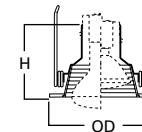

Dimensions**
H: 2" [52mm]
OD: 6-3/8" [156mm]

5012 High Coilex® Baffle

- Straight precision sided trim ring (fixed, not removable)
- Provides ultra deep lamp regression (not compatible with H5TM)
- Socket supporting
- Torsion spring retention

Housings		Max Lamp Compatibility
H5T	H5RT	75W PAR30S, 75W PAR30L, 65W BR30, 75W R30
E5TAT	E5RTAT	75W PAR30S, 75W PAR30L, 65W BR30

Compatible with Halogen, Incandescent, LED* or CFL* lamps



5012W
White Baffle, White Trim



5012P
Black Baffle, White Trim

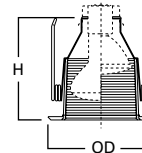

Dimensions**
H: 6" [152mm]
OD: 6-3/8" [156mm]

5016 Coilex® Baffle with Reflector

- Straight precision sided trim ring (fixed, not removable)
- Torsion spring retention
- Dual socket position for BR and PAR lamps
- Socket supporting

Housings		Max Lamp Compatibility
H5T	H5RT	60W A19, 75W PAR30S,
E5TAT	E5RTAT	75W PAR30L, 65W BR30

Compatible with Halogen, Incandescent, LED* or CFL* lamps



5016W
White Baffle, White Trim



5016P
Black Baffle, White Trim

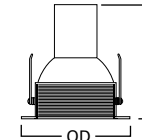

Dimensions**
H: 6-3/4" [171mm]
OD: 6-3/8" [162mm]

*UL1993 listed LED & CFL equivalent lamps permitted. Consult lamp manufacturer for conditions of use. Eaton does not warranty the lamp.

**Key: A: Luminous Aperture, D: Depth Profile, H: Height, LH: Lens Height, OD: Trim Outside Diameter

5102 Tapered Metal Baffle, Self-flange

- Contoured tapered sides of metal baffle for BR30 and PAR30 lamps
- Coil spring retention
- Self-flange trim ring sized to hide gaps caused by construction tolerances



5102WB White Baffle, White Self-flange
5102BB Black Baffle, White Self-flange

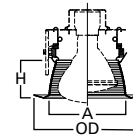

Dimensions**
A: 4-3/4" [121mm]
H: 2-3/8" [60mm]
OD: 6-5/8" [168mm]

Housings Max Lamp Compatibility

H5T	H5RT	Max Lamp Compatibility
E5TAT	E5RTAT	75W PAR30S, 75W PAR30L, 65W BR30

Compatible with Halogen, Incandescent, LED* or CFL* lamps

5109 Coilex® Tapered Baffle, Self-flange

- Contoured tapered sides of Coilex baffle for BR30 and PAR30 lamps
- Coil spring retention
- Self-flange trim ring sized to hide gaps caused by construction tolerances



5109WB White Plastic Straight Coilex Baffle, White Self-flange
5109BB Black Plastic Straight Coilex Baffle, White Self-flange
5109BKBB Black Plastic Straight Coilex Baffle, Black Self-flange

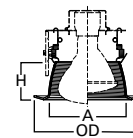

Dimensions**
A: 4-3/4" [121mm]
H: 2-3/8" [60mm]
OD: 6-5/8" [168mm]

Housings Max Lamp Compatibility

H5T	H5RT	Max Lamp Compatibility
E5TAT	E5RTAT	75W PAR30S, 75W PAR30L, 65W BR30

Compatible with Halogen, Incandescent, LED* or CFL* lamps

5110 Perfetex™ Baffle, Self-flange

- Perforated pattern baffle contoured for BR30 and PAR30L lamps
- Coil spring retention
- Self-flange trim ring sized to hide gaps caused by construction tolerances



5110WB White Perfetex Baffle, White Self-flange
5110BB Black Perfetex Baffle, White Self-flange
5110BKBB Black Perfetex Baffle, Black Self-flange

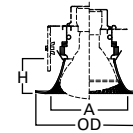

Dimensions**
A: 5-1/2" [141mm]
H: 2-1/8" [55mm]
OD: 6-5/8" [168mm]

Housings Max Lamp Compatibility

H5T	H5RT	Max Lamp Compatibility
E5TAT	E5RTAT	75W PAR30L, 65W BR30

Compatible with Halogen, Incandescent, LED* or CFL* lamps

5125 Full Cone Baffle, Self-flange

- Full cone baffle
- Torsion spring retention
- Socket supporting
- Self-flange trim ring sized to hide gaps caused by construction tolerances



5125WB White Baffle, White Self-flange
5125BB White Baffle, Black Self-flange
5125BKBB Black Baffle, Black Self-flange

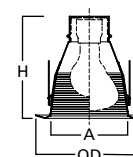

Dimensions**
A: 4-3/4" [121mm]
H: 6-1/4" [160mm]
OD: 6-5/8" [168mm]

Housings Max Lamp Compatibility

H5T	H5RT	Max Lamp Compatibility
E5TAT	E5RTAT	60W A19, 75W PAR30S, 75W PAR30L, 65W BR30

Compatible with Halogen, Incandescent, LED* or CFL* lamps

Adjustable – Eyeballs & Gimbals

5060 Adjustable Gimbal 20° Tilt, Self-flange

- Straight precision sided trim ring (fixed, not removable)
- For directional accent lighting
- Torsion springs retention
- 20° tilt - 360° rotation
- Socket supporting



5060P White Gimbal, White Trim

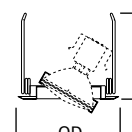

Dimensions**
H: 3-1/4" [82mm]
OD: 6-3/8" [162mm]

Housings Max Lamp Compatibility

H5T	H5RT	Max Lamp Compatibility
E5TAT	E5RTAT	75W PAR30S

Compatible with Halogen, Incandescent, LED* or CFL* lamps

*UL1993 listed LED & CFL equivalent lamps permitted. Consult lamp manufacturer for conditions of use. Eaton does not warranty the lamp.

**Key: A: Luminous Aperture, D: Depth Profile, H: Height, LH: Lens Height, OD: Trim Outside Diameter

E26 Screw Base Trims

Non-IC Housings: H5T • H5RT • E5TAT • E5RTAT

5
INCH

5070 Adjustable Eyeball 30° Tilt, Self-flange

- Straight precision sided trim ring (fixed, not removable)
- For directional accent lighting
- Torsion spring retention
- 30° tilt - 360° rotation
- Socket supporting



5070P
White Eyeball, White Trim



5070SN
Satin Nickel Eyeball,
Satin Nickel Trim



5070TBZ
Tuscan Bronze Eyeball,
Tuscan Bronze Trim

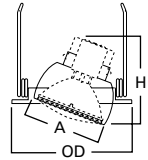

Dimensions**
A: 3-7/8" [98mm]
H: 3-3/8" [86mm]
OD: 6-3/8" [162mm]

Housings Max Lamp Compatibility

H5T	H5RT	75W PAR30S
E5TAT	E5RTAT	

Compatible with Halogen, Incandescent, LED* or CFL* lamps

5071 Adjustable Eyeball 30° Tilt, Self-flange

- Straight precision sided trim ring (fixed, not removable)
- For directional accent lighting
- Torsion springs retention
- 30° tilt - 360° rotation
- Socket supporting



5071P
White Eyeball, White Trim

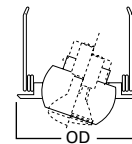

Dimensions**
OD: 6-1/2" [165mm]

Housings Max Lamp Compatibility

H5T	H5RT	50W PAR20 , 50W R20
E5TAT	E5RTAT	50W PAR20

Compatible with Halogen, Incandescent, LED* or CFL* lamps

5130 Eyeball 35° Tilt, Self-flange

- Adjustable 35° tilt, 360° rotation
- Design optimized for PAR30S (short-neck) lamps
- Torsion spring retention
- Socket supporting eyeball
- Self-flange trim ring sized to hide gaps caused by construction tolerances



5130WH
White Eyeball, White Trim

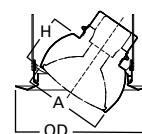

Dimensions**
A: 3-7/8" [98mm]
H: 2-1/4" [58mm]
OD: 6-5/8" [168mm]

Housings Max Lamp Compatibility

H5T	E5TAT	75W PAR30S
H5RT	E5RTAT	

Compatible with Halogen, Incandescent, LED* or CFL* lamps

5135 Eyeball 35° Tilt, Self-flange

- Conical adjustable eyeball trim for PAR20 lamps
- Torsion spring retention
- Socket supporting
- 35° tilt, 360° rotation
- Self-flange trim ring sized to hide gaps caused by construction tolerances



5135WH
White Eyeball, White Trim, Self-flange

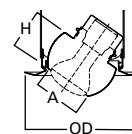

Dimensions**
A: 2-3/4" [70mm]
H: 2-1/4" [58mm]
OD: 6-5/8" [168mm]

Housings Max Lamp Compatibility

H5T	H5RT	50W PAR20
E5TAT	E5RTAT	

Compatible with Halogen, Incandescent, LED* or CFL* lamps

*UL1993 listed LED & CFL equivalent lamps permitted. Consult lamp manufacturer for conditions of use. Eaton does not warranty the lamp.

**Key: A: Luminous Aperture, D: Depth Profile, H: Height, LH: Lens Height, OD: Trim Outside Diameter

5165 Gimbal 35° Tilt, Self-flange

- Adjustable gimbal trim for PAR30S (short-neck) lamps
- Torsion spring retention
- Socket supporting bracket
- 35° tilt, 360° rotation
- Self-flange trim ring sized to hide gaps caused by construction tolerances



5165WH
White Gimbal, White Trim



5165BK
Black Gimbal, Black Trim



5165SN
Satin Nickel Gimbal,
Satin Nickel Trim



5165TBZ
Tuscan Bronze Gimbal,
Tuscan Bronze Trim

Housings Max Lamp Compatibility

H5T	H5RT	75W PAR30S
E5TAT	E5RTAT	

Compatible with Halogen, Incandescent, LED* or CFL* lamps

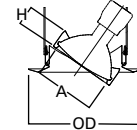

Dimensions**
A: 3-3/8" [85mm]
H: 1-1/8" [29mm]
OD: 6-5/8" [168mm]

5222 Regressed Angle Cut Adjustable Gimbal, 30° Tilt, Self-flange

- Fully regressed gimbal
- Torsion spring retention
- 30° tilt, 360° rotation
- Socket supporting
- Angle cut - cone reflector and baffle options
- Accommodates tilt of gimbal in a full regressed cut cone
- Self-flange trim ring sized to hide gaps caused by construction tolerances



5222WB
White Baffle & Gimbal,
White Trim



5222BB
Black Baffle & Gimbal,
White Trim



5222SC
Specular Clear Reflector
& Gimbal, White Trim



5222H
Haze Reflector & Gimbal,
White Trim

Housings Max Lamp Compatibility

H5T	H5RT	60W PAR16, 50W PAR20, 75W PAR30S, 75W PAR30L
E5TAT	E5RTAT	

Compatible with Halogen, Incandescent, LED* or CFL* lamps

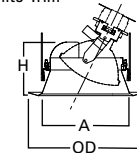

Dimensions**
A: 5" [127mm]
H: 3-1/8" [79mm]
OD: 6-5/8" [168mm]

Lenses & Wet Location Showerlights

5051 Frosted Glass Lens

- Frosted glass lens
- Straight precision sided trim
- "Dead-Front" construction, wet location listed Showerlight
- Non-conductive, non-corrosive gasketed polymer trim ring
- Torsion spring retention



5051PS
Frosted Glass Lens, White Trim

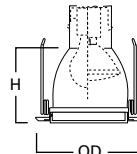

Dimensions**
H: 5-9/16" [141mm]
OD: 6-7/16" [164mm]

Housings Max Lamp Compatibility

H5T	H5RT	60W A19, 50W PAR30S, 50W PAR30L, 65W BR30
E5TAT	E5RTAT	

Compatible with Halogen, Incandescent, LED* or CFL* lamps



5054 Frosted Glass Dome Lens

- Frosted glass dome lens
- Precision straight sided trim ring
- "Dead-Front" construction, wet location listed Showerlight
- Non conductive, non corrosive gasketed polymer trim ring
- Torsion spring retention



5054PS
Frosted Glass Dome,
White Trim



5054SNS
Frosted Glass Dome,
Satin Nickel Trim



5054TBZS
Frosted Glass Dome,
Tuscan Bronze Trim

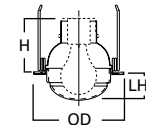

Dimensions**
LH: 1-3/4" [45mm]
H: 4-1/2" [114mm]
OD: 6-3/8" [162mm]

Housings Max Lamp Compatibility

H5T	H5RT	75W A19, 75W PAR30S
E5TAT	E5RTAT	

Compatible with Halogen, Incandescent, LED* or CFL* lamps



*UL1993 listed LED & CFL equivalent lamps permitted. Consult lamp manufacturer for conditions of use. Eaton does not warranty the lamp.

**Key: A: Luminous Aperture, D: Depth Profile, H: Height, LH: Lens Height, OD: Trim Outside Diameter

E26 Screw Base Trims

Non-IC Housings: H5T • H5RT • E5TAT • E5RTAT

5
INCH



5145 Open Wet Location, Shallow, Self-flange

- Open wet location Showerlight for PAR30S and PAR30L outdoor rated lamps ONLY
- Torsion spring retention
- Socket supporting
- Self-flange trim ring sized to hide gaps caused by construction tolerances
- For use only in standard and shallow housings

Housings Max Lamp Compatibility

H5T	H5RT	Max Lamp Compatibility
E5TAT	E5RTAT	75W PAR30S, 75W PAR30L

Compatible with Halogen, Incandescent, LED* or CFL* lamps



5145WH
White Self-flange



5145SN
Satin Nickel Self-flange



5145TBZ
Tuscan Bronze Self-flange



Lamp Gasket
(Included)

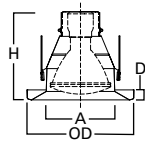

Dimensions**

A: 4-5/8" [117mm]
D: 5/8" [16mm]
H: 5-3/8" [138mm]
OD: 6-5/8" [168mm]

5146 Open Wet Location, Self-flange

- Open wet location Showerlight for PAR30S and PAR30L outdoor rated lamps ONLY
- Torsion spring retention
- Socket supporting
- Self-flange trim ring sized to hide gaps caused by construction tolerances

Housings Max Lamp Compatibility

H5T	H5RT	Max Lamp Compatibility
E5TAT	E5RTAT	75W PAR30S, 75W PAR30L

Compatible with Halogen, Incandescent, LED* or CFL* lamps



5146WH
White Self-flange



5146SN
Satin Nickel Self-flange



5146TBZ
Tuscan Bronze Self-flange



Lamp Gasket
(Included)

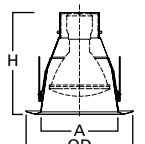

Dimensions**

A: 4-3/4" [121mm]
H: 6-1/4" [160mm]
OD: 6-5/8" [168mm]

5150 Low Profile, Frosted Glass Dome Lens, Self-flange

- Low profile, frosted glass dome lens
- Wet location Showerlight
- Torsion spring retention
- Non-conductive "dead-front" polymer (plastic) trim and glass lens
- Socket supporting internal reflector
- Self-flange trim ring sized to hide gaps caused by construction tolerances

Housings Max Lamp Compatibility

H5T	H5RT	Max Lamp Compatibility
E5TAT	E5RTAT	60W A19, 50W PAR30S

Compatible with Halogen, Incandescent, LED* or CFL* lamps



5150WH
Frosted Glass Dome Lens with Reflector, White Plastic Self-flange



5150SN
Frosted Glass Dome Lens with Reflector, Satin Nickel Plastic Self-flange



5150TBZ
Frosted Glass Dome Lens with Reflector, Tuscan Bronze Plastic Self-flange

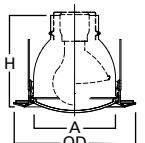

Dimensions**

A: 4-1/2" [114mm]
H: 5" [126mm]
OD: 6-5/8" [168mm]

5162 Drop Opal Plastic Lens, Self-flange

- Drop opal plastic lens
- Wet location Showerlight
- Non-conductive "dead-front" polymer (plastic) trim
- Torsion spring retention
- Socket supporting internal reflector
- Self-flange trim ring sized to hide gaps caused by construction tolerances

Housings Max Lamp Compatibility

H5T	H5RT	Max Lamp Compatibility
E5TAT	E5RTAT	43W A19

Compatible with Halogen, Incandescent, LED* or CFL* lamps



5162WH
Drop Opal Plastic Lens with Reflector, White Plastic Self-flange

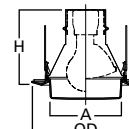

Dimensions**

A: 4-1/2" [114mm]
H: 5-5/8" [118mm]
OD: 6-5/8" [168mm]

*UL1993 listed LED & CFL equivalent lamps permitted. Consult lamp manufacturer for conditions of use. Eaton does not warranty the lamp.

**Key: A: Luminous Aperture, D: Depth Profile, H: Height, LH: Lens Height, OD: Trim Outside Diameter



5230 Squirle Frost Glass Lens, Metal Trim, Self-flange

- Low profile frost glass lens
- Wet location Showerlight
- Torsion spring retention
- Self-flange low profile metal trim ring
- Socket supporting internal bracket
- Integral rotation adjustment up to +/- 25° for precise alignment with room



5230AH
Frost Glass Lens, Aluminum Haze Squirle Trim



5230PN
Frost Glass Lens, Polished Nickel Squirle Trim



5230SN
Frost Glass Lens, Satin Nickel Squirle Trim



5230TBZ
Frost Glass Lens, Tuscan Bronze Squirle Trim

Housings Max Lamp Compatibility

H5T	H5RT	Consult website
E5TAT	E5RTAT	www.cooperlighting.com

Compatible with Halogen, Incandescent, LED* or CFL* lamps

5255 Soft Square, Frost Curved Glass Lens, Self-flange

- Low profile curved frost glass lens
- Wet location Showerlight
- Torsion spring retention
- Non-conductive "dead-front" polymer plastic trim and glass lens
- Integral rotation adjustment up to +/- 25° for precise alignment with room
- Integrated socket supporting reflector for illumination across lens corner-to-corner



5255WH
Frost Curved Glass Lens with Reflector, White Plastic Self-flange



5255SN
Frost Curved Glass Lens with Reflector, Satin Nickel Plastic Self-flange



5255TBZ
Frost Curved Glass Lens with Reflector, Tuscan Bronze Plastic Self-flange

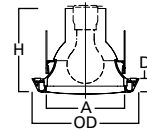

Dimensions**
A: 5-1/8" [130mm]
D: 1" [26mm]
H: 5-1/2" [140mm]
OD: 6-7/8" [174mm]

Housings Max Lamp Compatibility

H5T	H5RT	60W A19, 60W PAR30S
E5TAT	E5RTAT	

Compatible with Halogen, Incandescent, LED* or CFL* lamps

Open, Splay & Wall Wash

5000 PAR Metal Splay, Self-flange

- Straight precision sided trim ring (fixed, not remodeled)
- Open metal splay trim
- Dual socket position socket for BR and PAR lamps
- Torsion spring retention
- Socket supporting



5000P
White Splay, White Trim



5000SN
Satin Nickel Splay, Satin Nickel Trim



5000TBZ
Tuscan Bronze Splay, Tuscan Bronze Trim

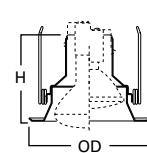

Dimensions**
H: 4-5/8" [118mm]
OD: 6-3/8" [162mm]

Housings Max Lamp Compatibility

H5T	H5RT	75W PAR30S, 75W PAR30L, 65W BR30, 75W R30
E5TAT	E5RTAT	75W PAR30S, 75W PAR30L, 65W BR30

Compatible with Halogen, Incandescent, LED* or CFL* lamps

5175 Open, Wide Self-flange

- Open trim for BR & PAR30 lamps
- Coil spring retention
- Self-flange trim ring sized to hide gaps caused by construction tolerances



5175WH
White Self-flange



5175SN
Satin Nickel Self-flange



5175TBZ
Tuscan Bronze Self-flange

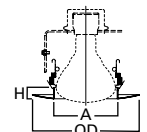

Dimensions**
A: 3-7/8" [99mm]
H: 3/4" [19mm]
OD: 6-5/8" [168mm]

Housings Max Lamp Compatibility

H5T	H5RT	75W PAR30S, 75W PAR30L, 65W BR30
E5TAT	E5RTAT	

Compatible with Halogen, Incandescent, LED* or CFL* lamps

*UL1993 listed LED & CFL equivalent lamps permitted. Consult lamp manufacturer for conditions of use. Eaton does not warranty the lamp.

**Key: A: Luminous Aperture, D: Depth Profile, H: Height, LH: Lens Height, OD: Trim Outside Diameter

E26 Screw Base Trims

Non-IC Housings: H5T • H5RT • E5TAT • E5RTAT

5
INCH

5176 Open, Wide Self-flange

- Open trim for BR & PAR lamps
- Torsion spring retention
- Socket supporting integral bracket
- Self-flange trim ring sized to hide gaps caused by construction tolerances

Housings		Max Lamp Compatibility
H5T	H5RT	75W PAR30S, 75W PAR30L,
E5TAT	E5RTAT	65W BR30

Compatible with Halogen, Incandescent, LED* or CFL* lamps



5176WH
White Self-flange



5176SN
Satin Nickel Self-flange



5176TBZ
Tuscan Bronze Self-flange

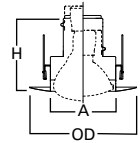

Dimensions**
A: 3-7/8" [99mm]
H: 4-3/4" [120mm]
OD: 6-5/8" [168mm]

5185 Open, Splay Self-flange

- Open splay trim for BR & PAR lamps
- Coil spring retention
- Self-flange trim ring sized to hide gaps caused by construction tolerances

Housings		Max Lamp Compatibility
H5T	H5RT	75W PAR30S, 75W PAR30L,
E5TAT	E5RTAT	65W BR30

Compatible with Halogen, Incandescent, LED* or CFL* lamps



5185WH
White Self-flange



5185SN
Satin Nickel Self-flange



5185TBZ
Tuscan Bronze Self-flange

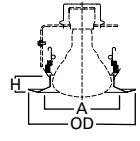

Dimensions**
A: 3-7/8" [99mm]
H: 1" [27mm]
OD: 6-5/8" [168mm]

5186 Splay, Self-flange

- Splay trim for BR & PAR lamps
- Torsion spring retention
- Socket supporting integral bracket
- Self-flange trim ring sized to hide gaps caused by construction tolerances

Housings		Max Lamp Compatibility
H5T	H5RT	75W PAR30S, 75W PAR30L,
E5TAT	E5RTAT	65W BR30

Compatible with Halogen, Incandescent, LED* or CFL* lamps



5186WH
White Self-flange



5186SN
Satin Nickel Self-flange



5186TBZ
Tuscan Bronze Self-flange

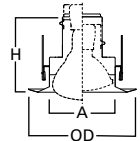

Dimensions**
A: 3-7/8" [99mm]
H: 4-7/8" [123mm]
OD: 6-5/8" [168mm]

5030 Wall Wash with Baffle

- Straight precision sided trim ring
- Designed to spread light closer to the ceiling to eliminate the "cave effect"
- Provides a wash of light
- 360° rotation
- Torsion spring retention
- Socket supporting

Housings		Max Lamp Compatibility
H5T	H5RT	50W TB19, 60W A19,
E5TAT	E5RTAT	60W BT15, 60W MB19

Compatible with Halogen, Incandescent, LED* or CFL* lamps



5030W
White Eyelid with White
Baffle, White Trim



5030P
White Eyelid with Black Baffle,
White Trim

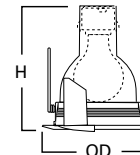

Dimensions**
H: 6-7/8" [173mm]
OD: 6-1/4" [159mm]

*UL1993 listed LED & CFL equivalent lamps permitted. Consult lamp manufacturer for conditions of use. Eaton does not warranty the lamp.

**Key: A: Luminous Aperture, D: Depth Profile, H: Height, LH: Lens Height, OD: Trim Outside Diameter

Specifications, compliances and dimensions subject to change without notice

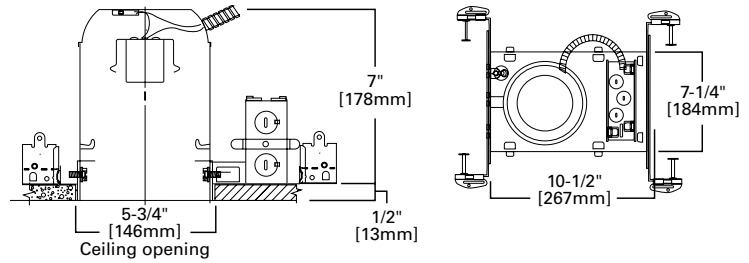

H5TNB

5" Non-IC, New Construction Housing, No Socket Bracket, 120V

The H5TNB recessed housing is designed for residential and light commercial applications. H5TNB features full-frame robust construction, feed through listing, Got Nail! bar hangers; and may support the use of higher wattage lamps. The wide variety of trims available allows a number of different lighting effects to be created with one basic housing. The H5TNB is for use non-insulated ceilings. If insulation is present it must be kept 3" from all sides of the housing. The H5TNB can save installation time. It is designed without a socket plate for use with socket supporting trims only. With these trims there is no need to spend time removing the socket plate and the fixed lamp position of socket supporting trims saves on lamp adjustment time too. May be retrofit with compatible Halo LED lighting systems.



Special Features

- Got Nail!™ bar hangers
- q-Channel bars with Pass-N-Thru™
- Slide-N-Side™ junction box
- Quick Connect™ push wire nuts

Compatible Trims

5000	5020	5060	5130	5150	5186
5001	5021	5070	5135	5162	5222
5010	5030	5071	5145	5165	5230
5012	5051	5120	5146	5176	5255
5016	5054	5125			

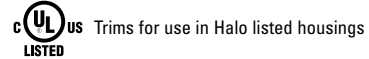

Features

Housing

- Single wall die-stamped CRS with white powder coat finish
- Housing adjusts in plaster frame to accommodate up to 1-3/8" ceiling thickness

Plaster Frame

- Galvanized steel construction
- The housing can be removed from plaster frame to provide access to the junction box
- Plaster frame features include:
 - Patented regressed locking screw positioned for securing hanger bars from below the ceiling
 - Cutouts for easily crimping hanger bars in position
 - Halo name embossed on plaster frame

Includes:

- Got Nail!™ bar hangers (Details Pg. 13)
- q-Channel bars with Pass-N-Thru™ (Details Pg. 13)
- Slide-N-Side™ junction box wire traps (Details Pg. 13)
- Quick Connect™ push wire nuts (Details Pg. 13)

Socket

- Porcelain socket with nickel plated brass screw shell
- Snaps into trim for consistent lamp positioning
- Overspray protector included

Thermal Protector

Self resetting thermal protector deactivates fixture if overheating occurs due to improper lamping or misapplied insulation

Trims

Halo Fit-All concept offers multiple trim options in a variety of design styles, and functional beam distributions to control beam angle and lumen delivery in accommodating various lamp types including Halogen, CFL and LED

Compliance

- cULus Listed 1598 luminaire
- cULus Listed damp location
- cULus Listed for wet location, covered ceiling, with select trims
- cULus Listed for feed through
- IP rated (Improper Lamp)
- RoHS compliant

E26 Screw Base Non-IC Housing – No Socket Bracket

5
INCH

E5TATNB

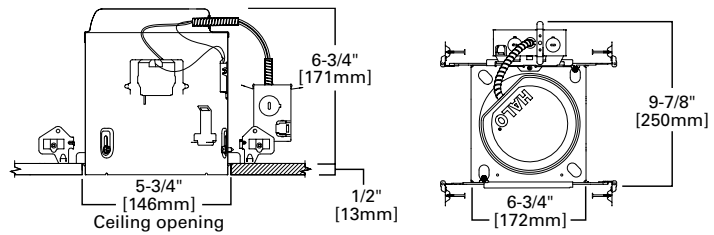

E5TATNB

5" Non-IC, Air-Tite, New Construction Housing, No Socket Bracket, 120V

The E5TATNB is a compact and efficient recessed housing optimized and listed for EISA compliant, tungsten-halogen, CFL and LED lamps as well as incandescent. The Halo E5TATNB housing is for use in non-insulated ceilings, suitable for residential or light commercial applications; with Air-Tite code compliant construction. Use with a variety of trims and finishes to create different lighting effects or to match any decor. E5TATNB is designed for use in non-insulated ceilings, if insulation is present it must be kept 3" from all sides of the housing. May be retrofit with compatible Halo LED lighting systems. The E5TATNB can save installation time. It is designed without a socket plate for use with socket supporting trims only. With these trims there is no need to spend time removing the socket plate and the fixed lamp position of socket supporting trims saves on lamp adjustment time too. May be retrofit with Halo LED lighting systems.



Special Features

- All-Nail!™ bar hangers
- q-Channel bars with Pass-N-Thru™
- Hinged j-box with Slide-N-Side™
- Quick Connect™ push wire nuts
- Air-Tite™ code compliant

Compatible Trims

5000	5020	5060	5130	5150	5186
5001	5021	5070	5135	5162	5222
5010	5030	5071	5145	5165	5230
5012	5051	5120	5146	5176	5255
5016	5054	5125			



Trims for use in Halo listed housings



Select trims are classified for use in other housings, see www.cooperlighting.com/legal

Features

Housing

- Single wall die-formed housing
- Housing features a precision rolled interlocking collar which maintains aperture geometry for greater assurance of installation results
- Exclusive Air-Tite gasket meets code where required, and seals between housing, frame and finished ceiling - without need for additional caulk
- May be removed from the plaster frame to provide access to junction box

Plaster Frame

- Galvanized steel frame. Housing adjusts in plaster frame to accommodate up to 3/8" - 1" ceiling thickness.
- (2) Regressed locking screws for securing hanger bars

Includes:

- All-Nail!™ bar hangers (Details Pg. 15)
- q-Channel bar hangers (Details Pg. 15)
- Hinged junction box with Slide-N-Side™ (Details Pg. 15)
- Quick Connect™ push wire nuts (Details Pg. 15)
- Air-Tite™ code compliant (Details Pg. 15)

Socket

- Porcelain socket with nickel plated brass screw shell
- Snap-in socket speeds installation and attaches directly to the trim for consistent lamp positioning
- Shipped with socket overspray protector installed

Thermal Protector

Self resetting thermal protector deactivates fixture if overheating occurs due to improper lamping or misapplied insulation

Trims

Halo Fit-All concept offers multiple trim options in a variety of design styles, and functional beam distributions to control beam angle and lumen delivery in accommodating various lamp types including Halogen, CFL and LED

Compliance

- cULus Listed 1598 luminaire
- cULus Listed damp location
- cULus Listed for wet location, covered ceiling, with select trims
- Air-Tite code compliant. Certified under ASTM E283; not exceeding 2.0 cfm (0.944 L/s) air leakage rate tested at a 1.57 psf (75 Pa) pressure differential
- RoHS compliant

Reflectors

5020 PAR Reflector

- Straight precision sided trim ring (fixed, not removable)
- Torsion spring retention
- Dual socket position for BR and PAR lamps
- Socket supporting integral bracket

Housings Max Lamp Compatibility

H5TNB 75W PAR30S, 75W PAR30L, 65W BR30, 75W R30

E5TATNB 75W PAR30S, 75W PAR30L, 65W BR30

Compatible with Halogen, Incandescent, LED* or CFL* lamps



5020P
White Reflector, White Trim



5020H
Haze Reflector, White Trim



5020SC
Specular Clear Reflector, White Trim



5020BL
Black Specular Reflector, White Trim



5020SN
Satin Nickel Reflector, Satin Nickel Trim



5020TBZ
Tuscan Bronze Reflector, Tuscan Bronze Trim

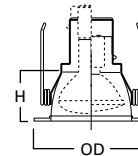

Dimensions**
H: 3-1/4" [82mm]
OD: 6-3/8" [162mm]

5021 Full Reflector

- Straight precision sided trim ring (fixed, not removable)
- Torsion spring retention
- For use with A-lamps
- Socket supporting integral bracket

Housings Max Lamp Compatibility

H5TNB 60W A19

E5TATNB

Compatible with Halogen, Incandescent, LED* or CFL* lamps



5021H
Haze Reflector, White Trim



5021SC
Specular Clear Reflector, White Trim



5021TBZ
Tuscan Bronze Reflector, Tuscan Bronze Trim

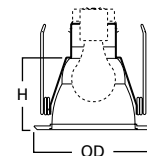

Dimensions**
H: 5" [127mm]
OD: 6-3/8" [162mm]

5120 Full Cone Reflector, Self-flange

- Full cone reflector
- Torsion spring retention
- Socket supporting
- Self-flange trim ring sized to hide gaps caused by construction tolerances

Housings Max Lamp Compatibility

H5TNB 60W A19, 75W PAR30S,

E5TATNB 75W PAR30L, 65W BR30

Compatible with Halogen, Incandescent, LED* or CFL* lamps



5120WH
White Reflector, White Self-flange



5120SN
Satin Nickel Reflector, Satin Nickel Self-flange



5120TBZ
Tuscan Bronze Reflector, Tuscan Bronze Self-flange

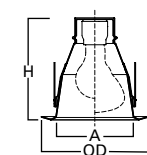

Dimensions**
A: 4-3/4" [121mm]
H: 6-1/4" [160mm]
OD: 6-5/8" [168mm]

*UL1993 listed LED & CFL equivalent lamps permitted. Consult lamp manufacturer for conditions of use. Eaton does not warranty the lamp.

**Key: A: Luminous Aperture, D: Depth Profile, H: Height, LH: Lens Height, OD: Trim Outside Diameter

E26 Screw Base Trims

Non-IC "NB" Housings: H5TNB • E5TATNB

5
INCH

Baffles

5001 PAR Metal Baffle Splay

- Straight precision sided trim ring (fixed, not removable)
- Torsion spring retention
- Dual socket position for BR and PAR lamps
- Socket supporting

Housings Max Lamp Compatibility

Housings	Max Lamp Compatibility
H5TNB	50W PAR20, 75W PAR30S, 75W PAR30L, 65W BR30, 50W R20, 75W R30
E5TATNB	50W PAR20, 75W PAR30S, 75W PAR30L, 65W BR30

Compatible with Halogen, Incandescent, LED* or CFL* lamps



5001P
White Baffle, White Trim



5001MB
Black Baffle, White Trim



5001SN
Satin Nickel Baffle,
Satin Nickel Trim



5001TBZ
Tuscan Bronze Baffle,
Tuscan Bronze Trim

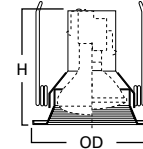

Dimensions**
H: 6-1/8" [152mm]
OD: 6-3/8" [156mm]

5012 High Coilex® Baffle

- Straight precision sided trim ring (fixed, not removable)
- Provides ultra deep lamp regression (not compatible with H5TM)
- Socket supporting
- Torsion spring retention

Housings Max Lamp Compatibility

Housings	Max Lamp Compatibility
H5TNB	75W PAR30S, 75W PAR30L, 65W BR30, 75W R30
E5TATNB	75W PAR30S, 75W PAR30L, 65W BR30

Compatible with Halogen, Incandescent, LED* or CFL* lamps



5012W
White Baffle, White Trim



5012P
Black Baffle, White Trim

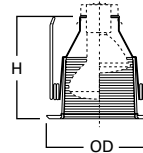

Dimensions**
H: 6" [152mm]
OD: 6-3/8" [156mm]

5016 Coilex® Baffle with Reflector

- Straight precision sided trim ring (fixed, not removable)
- Torsion spring retention
- Dual socket position for BR and PAR lamps
- Socket supporting

Housings Max Lamp Compatibility

Housings	Max Lamp Compatibility
H5TNB	60W A19, 75W PAR30S,
E5TATNB	75W PAR30L, 65W BR30

Compatible with Halogen, Incandescent, LED* or CFL* lamps



5016W
White Baffle, White Trim



5016P
Black Baffle, White Trim

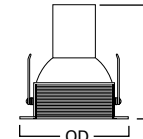

Dimensions**
H: 6-3/4" [171mm]
OD: 6-3/8" [162mm]

*UL1993 listed LED & CFL equivalent lamps permitted. Consult lamp manufacturer for conditions of use. Eaton does not warranty the lamp.

**Key: A: Luminous Aperture, D: Depth Profile, H: Height, LH: Lens Height, OD: Trim Outside Diameter

5125 Full Cone Baffle, Self-flange

- Full cone baffle trim
- Torsion spring retention
- Socket supporting
- Self-flange trim ring sized to hide gaps caused by construction tolerances



5125WB White Baffle, White Self-flange
5125BB White Baffle, Black Self-flange
5125BKBB Black Baffle, Black Self-flange

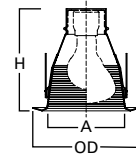

Dimensions**
 A: 4-3/4" [121mm]
 H: 6-1/4" [160mm]
 OD: 6-5/8" [168mm]

Housings Max Lamp Compatibility

H5TNB	60W A19, 75W PAR30S,
E5TATNB	75W PAR30L, 65W BR30

Compatible with Halogen, Incandescent, LED* or CFL* lamps

Adjustable – Eyeballs & Gimbals

5060 Adjustable Gimbal 20° Tilt, Self-flange

- Straight precision sided trim ring (fixed, not removable)
- For directional accent lighting
- Torsion spring retention
- 20° tilt - 360° rotation
- Socket supporting



5060P
 White Gimbal, White Trim

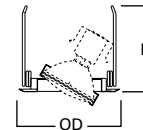

Dimensions**
 H: 3-1/4" [82mm]
 OD: 6-3/8" [162mm]

Housings Max Lamp Compatibility

H5TNB	75W PAR30S
E5TATNB	

Compatible with Halogen, Incandescent, LED* or CFL* lamps

5070 Adjustable Eyeball 30° Tilt, Self-flange

- Straight precision sided trim ring (fixed, not removable)
- For directional accent lighting
- Torsion spring retention
- 30° tilt - 360° rotation
- Socket supporting



5070P White Eyeball, White Trim
5070SN Satin Nickel Eyeball, Satin Nickel Trim
5070TBZ Tuscan Bronze Eyeball, Tuscan Bronze Trim

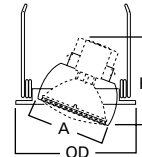

Dimensions**
 A: 3-7/8" [98mm]
 H: 3-3/8" [86mm]
 OD: 6-3/8" [162mm]

Housings Max Lamp Compatibility

H5TNB	75W PAR30S
E5TATNB	

Compatible with Halogen, Incandescent, LED* or CFL* lamps

5071 Adjustable Eyeball 30° Tilt, Self-flange

- Straight precision sided trim ring (fixed, not removable)
- For directional accent lighting
- Torsion spring retention
- 30° tilt - 360° rotation
- Socket supporting



5071P
 White Eyeball, White Trim

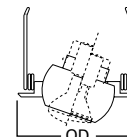

Dimensions**
 OD: 6-1/2" [165mm]

Housings Max Lamp Compatibility

H5TNB	50W PAR20, 50W R20
E5TATNB	50W PAR20

Compatible with Halogen, Incandescent, LED* or CFL* lamps

*UL1993 listed LED & CFL equivalent lamps permitted. Consult lamp manufacturer for conditions of use. Eaton does not warranty the lamp.

**Key: A: Luminous Aperture, D: Depth Profile, H: Height, LH: Lens Height, OD: Trim Outside Diameter

E26 Screw Base Trims

Non-IC "NB" Housings: H5TNB • E5TATNB

5
INCH

5130 Eyeball 35° Tilt, Self-flange

- Adjustable 35° tilt, 360° rotation
- Design optimized for PAR30S (short-neck) lamps
- Torsion spring retention
- Socket supporting
- Self-flange trim ring sized to hide gaps caused by construction tolerances



5130WH
White Eyeball, White Trim

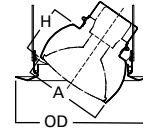

Dimensions**
A: 3-7/8" [98mm]
H: 2-1/4" [58mm]
OD: 6-5/8" [168mm]

Housings Max Lamp Compatibility

H5TNB — 75W PAR30S
E5TATNB

Compatible with Halogen, Incandescent, LED* or CFL* lamps

5135 Eyeball 35° Tilt, Self-flange

- Conical adjustable eyeball trim for PAR20 lamps
- Torsion spring retention
- Socket supporting
- 35° tilt, 360° rotation
- Self-flange trim ring sized to hide gaps caused by construction tolerances



5135WH
White Eyeball, White Trim, Self-flange

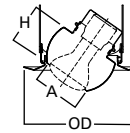

Dimensions**
A: 2-3/4" [70mm]
H: 2-1/4" [58mm]
OD: 6-5/8" [168mm]

Housings Max Lamp Compatibility

H5TNB — 50W PAR20
E5TATNB

Compatible with Halogen, Incandescent, LED* or CFL* lamps

5165 Gimbal 35° Tilt, Self-flange

- Adjustable gimbal trim for PAR30S (short-neck) lamps
- Torsion spring retention
- Socket supporting
- 35° tilt, 360° rotation
- Self-flange trim ring sized to hide gaps caused by construction tolerances



5165WH
White Gimbal, White Trim



5165BK
Black Gimbal, Black Trim



5165SN
Satin Nickel Gimbal,
Satin Nickel Trim



5165TBZ
Tuscan Bronze Gimbal,
Tuscan Bronze Trim

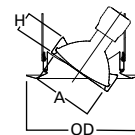

Dimensions**
A: 3-3/8" [85mm]
H: 1-1/8" [29mm]
OD: 6-5/8" [168mm]

Housings Max Lamp Compatibility

H5TNB — 75W PAR30S
E5TATNB

Compatible with Halogen, Incandescent, LED* or CFL* lamps

5222 Regressed Angle Cut Adjustable Gimbal, 30° Tilt, Self-flange

- Fully regressed gimbal
- Torsion spring retention
- 30° tilt, 360° rotation
- Socket supporting
- Angle cut - cone reflector and baffle options
- Accommodates tilt of gimbal in a full regressed cut cone
- Self-flange trim ring sized to hide gaps caused by construction tolerances



5222WB
White Baffle & Gimbal,
White Trim



5222BB
Black Baffle & Gimbal,
White Trim



5222SC
Specular Clear Reflector
& Gimbal, White Trim



5222H
Haze Reflector & Gimbal,
White Trim

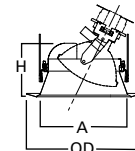

Dimensions**
A: 5" [127mm]
H: 3-1/8" [79mm]
OD: 6-5/8" [168mm]

Housings Max Lamp Compatibility

H5TNB — 75W PAR30S, 75W PAR30L,
E5TATNB — 60W PAR16, 50W PAR20

Compatible with Halogen, Incandescent, LED* or CFL* lamps

*UL1993 listed LED & CFL equivalent lamps permitted. Consult lamp manufacturer for conditions of use. Eaton does not warranty the lamp.

**Key: A: Luminous Aperture, D: Depth Profile, H: Height, LH: Lens Height, OD: Trim Outside Diameter

Lenses & Wet Location Showerlights

5051 Frosted Glass Lens - Showerlight



- Straight precision sided trim ring
- Frosted glass lens
- "Dead-Front" construction, wet location listed Showerlight
- Non-conductive, non-corrosive gasketed polymer trim ring
- Torsion spring retention



5051PS
Frosted Glass Lens, White Trim

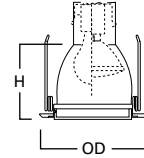

Dimensions**
H: 5-9/16" [141mm]
OD: 6-7/16" [164mm]

Housings Max Lamp Compatibility

H5TNB	60W A19, 50W PAR30S,
E5TATNB	50W PAR30L, 65W BR30

Compatible with Halogen, Incandescent, LED* or CFL* lamps

5054 Frosted Glass Dome Lens



- Frosted glass dome lens
- Straight precision sided trim ring
- "Dead-Front" construction, wet location listed Showerlight
- Non conductive, non corrosive gasketed polymer trim ring
- Torsion spring retention



5054PS
Frosted Glass Dome, White Trim



5054SNS
Frosted Glass Dome, Satin Nickel Trim



5054TBZS
Frosted Glass Dome, Tuscan Bronze Trim

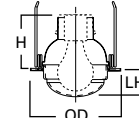

Dimensions**
LH: 1-3/4" [45mm]
H: 4-1/2" [114mm]
OD: 6-3/8" [162mm]

Housings Max Lamp Compatibility

H5TNB	75W A19, 75W PAR30S
E5TATNB	

Compatible with Halogen, Incandescent, LED* or CFL* lamps

5145 Open Wet Location, Shallow, Self-flange



- Open wet location Showerlight for PAR30S and PAR30L outdoor rated lamps ONLY
- Torsion spring retention
- Socket supporting
- Self-flange trim ring sized to hide gaps caused by construction tolerances



5145WH
White Self-flange



5145SN
Satin Nickel Self-flange



5145TBZ
Tuscan Bronze Self-flange

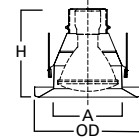

Dimensions**
A: 4-5/8" [117mm]
D: 5/8" [16mm]
H: 5-3/8" [138mm]
OD: 6-5/8" [168mm]

Housings Max Lamp Compatibility

H5TNB	75W PAR30S, 75W PAR30L
E5TATNB	

Compatible with Halogen, Incandescent, LED* or CFL* lamps



Lamp Gasket
(Included)

5146 Open Wet Location, Self-flange



- Open wet location Showerlight for PAR30S and PAR30L outdoor rated lamps ONLY
- Torsion spring retention
- Socket supporting
- Self-flange trim ring sized to hide gaps caused by construction tolerances



5146WH
White Self-flange



5146SN
Satin Nickel Self-flange



5146TBZ
Tuscan Bronze Self-flange

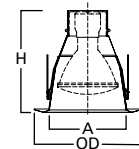

Dimensions**
A: 4-3/4" [121mm]
H: 6-1/4" [160mm]
OD: 6-5/8" [168mm]

Housings Max Lamp Compatibility

H5TNB	75W PAR30S, 75W PAR30L
E5TATNB	

Compatible with Halogen, Incandescent, LED* or CFL* lamps



Lamp Gasket
(Included)

*UL1993 listed LED & CFL equivalent lamps permitted. Consult lamp manufacturer for conditions of use. Eaton does not warranty the lamp.

**Key: A: Luminous Aperture, D: Depth Profile, H: Height, LH: Lens Height, OD: Trim Outside Diameter

E26 Screw Base Trims

Non-IC "NB" Housings: H5TNB • E5TATNB

5
INCH



5150 Low Profile, Frosted Glass Dome Lens, Self-flange

- Low profile, frosted glass dome lens
- Wet location Showerlight
- Torsion spring retention
- Non-conductive "dead-front" polymer (plastic) trim and glass lens
- Socket supporting internal reflector
- Self-flange trim ring sized to hide gaps caused by construction tolerances



5150WH
Frosted Glass Dome Lens with Reflector, White Plastic Self-flange



5150SN
Frosted Glass Dome Lens with Reflector, Satin Nickel Plastic Self-flange



5150TBZ
Frosted Glass Dome Lens with Reflector, Tuscan Bronze Plastic Self-flange

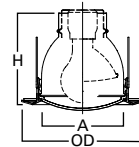

Dimensions**
A: 4-1/2" [114mm]
H: 5" [126mm]
OD: 6-5/8" [168mm]

Housings Max Lamp Compatibility

H5TNB _____ 60W A19, 50W PAR30S
E5TATNB _____

Compatible with Halogen, Incandescent, LED* or CFL* lamps



5162 Drop Opal Plastic Lens, Self-flange

- Drop opal plastic lens
- Wet location Showerlight
- Non-conductive "dead-front" polymer (plastic) trim
- Torsion spring retention
- Socket supporting internal reflector
- Self-flange trim ring sized to hide gaps caused by construction tolerances



5162WH
Drop Opal Plastic Lens with Reflector, White Plastic Self-flange

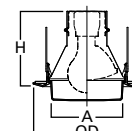

Dimensions**
A: 4-1/2" [114mm]
H: 5-5/8" [118mm]
OD: 6-5/8" [168mm]

Housings Max Lamp Compatibility

H5TNB _____ 43W A19
E5TATNB _____

Compatible with Halogen, Incandescent, LED* or CFL* lamps



5230 Squircle Frost Glass Lens, Metal Trim, Self-flange

- Low profile frost glass lens
- Wet location Showerlight
- Torsion spring retention
- Self-flange low profile metal trim ring
- Socket supporting internal bracket
- Integral rotation adjustment up to +/- 25° for precise alignment with room



5230AH
Frost Glass Lens, Aluminum Haze Squircle Trim



5230PN
Frost Glass Lens, Polished Nickel Squircle Trim



5230SN
Frost Glass Lens, Satin Nickel Squircle Trim



5230TBZ
Frost Glass Lens, Tuscan Bronze Squircle Trim

Housings Max Lamp Compatibility

H5TNB _____ Consult website
E5TATNB _____ www.cooperlighting.com

Compatible with Halogen, Incandescent, LED* or CFL* lamps



5255 Soft Square, Frost Curved Glass Lens, Self-flange

- Low profile curved frost glass lens
- Wet location Showerlight
- Torsion spring retention
- Non-conductive "dead-front" polymer plastic trim and glass lens
- Integral rotation adjustment up to +/- 25° for precise alignment with room
- Integrated socket supporting reflector for illumination across lens corner-to-corner



5255WH
Frost Curved Glass Lens with Reflector, White Plastic Self-flange



5255SN
Frost Curved Glass Lens with Reflector, Satin Nickel Plastic Self-flange



5255TBZ
Frost Curved Glass Lens with Reflector, Tuscan Bronze Plastic Self-flange

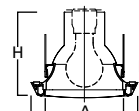

Dimensions**
A: 5-1/8" [130mm]
D: 1" [26mm]
H: 5-1/2" [140mm]
OD: 6-7/8" [174mm]

Housings Max Lamp Compatibility

H5TNB _____ 60W A19, 60W PAR30S
E5TATNB _____

Compatible with Halogen, Incandescent, LED* or CFL* lamps

*UL1993 listed LED & CFL equivalent lamps permitted. Consult lamp manufacturer for conditions of use. Eaton does not warranty the lamp.

**Key: A: Luminous Aperture, D: Depth Profile, H: Height, LH: Lens Height, OD: Trim Outside Diameter

Specifications, compliances and dimensions subject to change without notice

Open, Splay & Wall Wash

5000 PAR Metal Splay, Self-flange

- Straight precision sided trim ring (fixed, not remodeled)
- Open metal splay trim
- Dual socket position socket for BR and PAR lamps
- Torsion spring retention
- Socket supporting



5000P
White Splay, White Trim



5000SN
Satin Nickel Splay,
Satin Nickel Trim



5000TBZ
Tuscan Bronze Splay,
Tuscan Bronze Trim

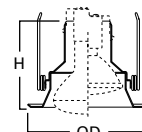

Dimensions**
H: 4-5/8" [118mm]
OD: 6-3/8" [162mm]

Housings Max Lamp Compatibility

H5TNB	75W PAR30S, 75W PAR30L, 65W BR30, 75W R30
-------	--

E5TATNB	75W PAR30S, 75W PAR30L, 65W BR30
---------	-------------------------------------

Compatible with Halogen, Incandescent, LED* or CFL* lamps

5030 Wall Wash with Baffle

- Straight precision sided trim ring
- Designed to spread light closer to the ceiling to eliminate the "cave effect"
- Provides a wash of light
- 360° rotation
- Torsion spring retention
- Socket supporting



5030W
White Eyelid with White
Baffle, White Trim



5030P
White Eyelid with Black Baffle,
White Trim

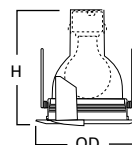

Dimensions**
H: 6-7/8" [173mm]
OD: 6-1/4" [159mm]

Housings Max Lamp Compatibility

H5TNB	60W A19, 50W TB19, 60W BT15, 60W MB19
-------	--

E5TATNB	60W A19
---------	---------

Compatible with Halogen, Incandescent, LED* or CFL* lamps

5176 Open, Wide Self-flange

- Open trim for BR & PAR lamps
- Torsion spring retention
- Socket supporting integral
- Self-flange trim ring sized to hide gaps caused by construction tolerances



5176WH
White Self-flange



5176SN
Satin Nickel Self-flange



5176TBZ
Tuscan Bronze Self-flange

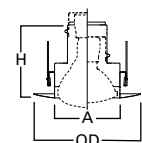

Dimensions**
A: 3-7/8" [99mm]
H: 4-3/4" [120mm]
OD: 6-5/8" [168mm]

Housings Max Lamp Compatibility

H5TNB	75W PAR30S, 75W PAR30L, E5TATNB 65W BR30
-------	---

Compatible with Halogen, Incandescent, LED* or CFL* lamps

5186 Splay, Self-flange

- Splay trim for BR & PAR lamps
- Torsion spring retention
- Socket supporting integral
- Self-flange trim ring sized to hide gaps caused by construction tolerances



5186WH
White Self-flange



5186SN
Satin Nickel Self-flange



5186TBZ
Tuscan Bronze Self-flange

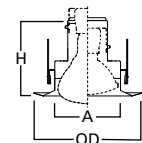

Dimensions**
A: 3-7/8" [99mm]
H: 4-7/8" [123mm]
OD: 6-5/8" [168mm]

Housings Max Lamp Compatibility

H5TNB	75W PAR30S, 75W PAR30L, E5TATNB 65W BR30
-------	---

Compatible with Halogen, Incandescent, LED* or CFL* lamps

*UL1993 listed LED & CFL equivalent lamps permitted. Consult lamp manufacturer for conditions of use. Eaton does not warranty the lamp.

**Key: A: Luminous Aperture, D: Depth Profile, H: Height, LH: Lens Height, OD: Trim Outside Diameter



6 INCH

6" E26 Screw Base

IC Housings	254
IC Trims	260
H7UICAT Housings & Trims	272
IC Housings – No Socket Bracket	285
IC Trims – No Socket Bracket	288
IC Shallow Housings	296
IC Shallow Trims	300
Non-IC Housings	310
Non-IC Trims	315
Non-IC Housings – No Socket Bracket	332
Non-IC Trims – No Socket Bracket	334
Non-IC Shallow Housings	342
Non-IC Shallow Trims	346
H47 Series Slope Housings & Trims	356
H645IC Slope Housings & Trims	360

IC = Insulated Ceiling Non-IC = Non-Insulated Ceiling

Trim Series #	Style	H7ICT	H7ICAT	H7RICT	H7RICAT	E7ICAT	E7RICAT	H7UICAT
30	Reflector & Baffle	•	•	•	•	•	•	•
70	Showerlight	—	—	—	—	—	—	•
71	Showerlight	—	—	—	—	—	—	•
73	Showerlight	—	—	—	—	—	—	•
74	Adjustable	•	•	•	•	•	•	•
76	Adjustable	•	•	•	•	•	•	•
78	Adjustable	•	•	•	•	•	•	•
79	Pinhole	—	—	—	—	—	—	•
170	Showerlight	•	•	•	•	•	•	•
171	Showerlight	•	•	•	•	•	•	•
172	Showerlight	•	•	•	•	•	•	•
173	Showerlight	•	•	•	•	•	•	•
300	Open	•	•	•	•	•	•	•
310	Baffle	•	•	•	•	•	•	•
327	Splay	•	•	•	•	•	•	—
328	Splay	•	•	•	•	•	•	•
353	Baffle	•	•	•	•	•	•	•
376	Adjustable	•	•	•	•	•	•	•
378	Adjustable	•	•	•	•	•	—	•
404	Reflector	•	•	•	•	•	—	•
419	Adjustable	—	—	—	—	—	—	•
420	Adjustable	•	•	•	•	•	•	•
424	Wall Wash	—	—	—	—	—	—	•
425	Wall Wash	—	—	—	—	—	—	•
426	Reflector	•	•	•	•	•	•	•
429	Reflector	•	•	•	•	•	•	•
430	Wall Wash	•	•	•	•	•	•	•
478	Adjustable	•	•	•	•	•	•	—
4041	Reflector	•	•	•	•	•	—	•
4261	Reflector	•	•	•	•	•	•	•
30SBAT	Reflector	•	•	•	•	•	•	•
6100	Baffle	•	•	•	•	•	•	•
6101	Baffle	•	•	•	•	•	•	•
6102	Baffle	•	•	•	•	•	•	•
6103	Baffle	•	•	•	•	•	•	•
6106	Reflector	•	•	•	•	•	•	•
6107	Reflector	•	•	•	•	•	•	•
6108	Baffle	•	•	•	•	•	•	•
6109	Baffle	•	•	•	•	•	•	•
6110	Baffle	•	•	•	•	•	•	—
6120	Reflector	•	•	•	•	•	•	•
6121	Reflector	•	•	•	•	•	•	•
6125	Baffle	•	•	•	•	•	•	•
6126	Baffle	•	•	•	•	•	•	•
6130	Adjustable	•	•	•	•	•	•	•
6145	Open Showerlight	•	•	•	•	•	•	•
6146	Open Showerlight	•	•	•	•	•	•	•
6150	Showerlight	•	•	•	•	•	•	•
6160	Showerlight	—	—	—	—	—	—	•
6162	Showerlight	•	•	•	•	•	•	•
6170	Adjustable	•	•	•	•	•	•	—
6215	Adjustable	•	•	•	•	•	•	•
6222	Adjustable	•	•	•	•	•	•	•
6230	Showerlight	•	•	•	•	•	•	•
6255	Showerlight	•	•	•	•	•	•	•

E26 Screw Base Insulated Ceiling housings & Trims

Quick Reference – IC

6
INCH

Trim Series #	Style	H71CTNB	H71CATNB	E71CATNB	H271CAT	H27RICAT	E271CAT	E27RICAT
30	Reflector & Baffle	•	•	•	—	—	—	—
74	Adjustable	•	•	•	•	•	•	•
76	Adjustable	•	•	•	—	—	—	—
78	Adjustable	•	•	•	•	•	•	•
170	Showerlight	•	•	•	•	•	•	•
171	Showerlight	•	•	•	•	•	•	•
172	Showerlight	•	•	•	•	•	•	•
173	Showerlight	•	•	•	•	—	•	—
300	Open	•	•	•	•	•	•	•
310	Baffle	—	—	—	•	•	•	•
327	Splay	•	•	•	—	—	—	—
328	Splay	—	—	—	•	•	•	•
353	Baffle	—	—	—	•	•	•	•
376	Adjustable	•	•	•	—	—	—	—
378	Adjustable	•	•	•	—	—	—	—
404	Reflector	•	•	•	—	—	—	—
420	Reflector	•	•	•	•	•	•	•
426	Reflector	—	—	—	•	•	•	•
429	Reflector	—	—	—	—	—	—	—
430	Wall Wash	•	•	•	—	—	—	—
478	Adjustable	•	•	•	—	—	—	—
4041	Reflector	•	•	•	—	—	—	—
4261	Reflector	—	—	—	—	—	—	—
30SBAT	Reflector	•	•	•	—	—	—	—
6100	Baffle	—	—	—	•	•	•	•
6101	Baffle	—	—	—	•	•	•	•
6102	Baffle	—	—	—	•	•	•	•
6103	Baffle	—	—	—	•	•	•	•
6106	Reflector	—	—	—	•	•	•	•
6107	Reflector	—	—	—	•	•	•	•
6108	Baffle	—	—	—	•	•	•	•
6109	Baffle	—	—	—	•	•	•	•
6110	Baffle	—	—	—	•	•	•	•
6120	Reflector	•	•	•	—	—	—	—
6121	Reflector	•	•	•	•	•	•	•
6125	Baffle	•	•	•	—	—	—	—
6126	Baffle	•	•	•	•	•	•	•
6130	Adjustable	•	•	•	•	•	•	•
6145	Open Showerlight	•	•	•	•	•	•	•
6146	Open Showerlight	•	•	•	—	—	—	—
6150	Showerlight	•	•	•	•	•	•	•
6162	Showerlight	•	•	•	•	•	•	•
6170	Adjustable	•	•	•	—	—	—	—
6215	Adjustable	•	•	•	•	•	•	•
6222	Adjustable	•	•	•	—	—	—	—
6230	Showerlight	•	•	•	•	•	•	•
6255	Showerlight	•	•	•	•	•	•	•

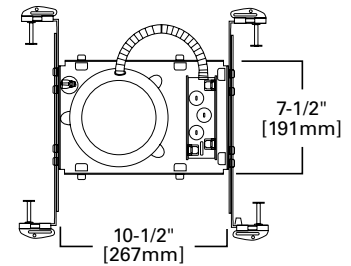
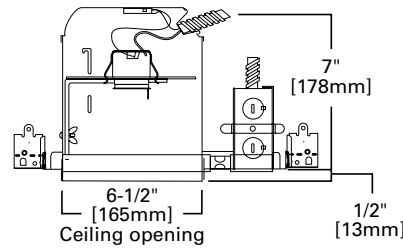

H7ICT

6" IC, New Construction, 120V

The H7 recessed housing is the standard in the industry for both light commercial and residential applications. H7 series features full-frame design, robust construction, feed-through listing, Got Nail! bar hangers; and may support use of higher wattage lamps. A wide variety of trims allows a number of different lighting effects to be created with one basic housing. H7ICT is for installations where the housing will be in direct contact with insulation*. H7ICT may be converted into Air-Tite installation when used with Air-Tite trims. May be retrofit with compatible Halo LED lighting systems.



Special Features

- Got Nail!™ bar hangers
- q-Channel bars with Pass-N-Thru™
- Slide-N-Side™ junction box
- Quick Connect™ push wire nuts

Compatible Trims

30°	300	404	6100	6110	6150
74	310	420	6101	6120°	6162
76	327	426	6102	6121	6170
78°	328	429	6103	6125°	6215
170°	353	430°	6106	6126	6222
171°	376	478	6107	6130	6230
172°	378	4041	6108	6145	6255
173°		4261	6109	6146	30SBAT°



Trims for use in Halo listed housings



Select trims are classified for use in other housings, see www.cooperlighting.com/legal

◊ Air-Tite trims can make the H7ICT installation ASTM E283 compliant

Features

Housing

- Single wall aluminum housing
- Aluminum construction for greater heat dissipation

Socket Plate

- Rigid socket plate adjusts and locks without tools for various lamp sizes
- Socket plate and bracket may be removed when using socket supporting trims

Plaster Frame

- Housing adjusts in plaster frame to accommodate up to 1" ceiling thickness
- Galvanized steel construction
- Plaster frame features include:
 - Regressed locking screw for securing hanger bars
 - Cutouts for easily crimping hanger bars in position
 - Halo name embossed on plaster frame
 - The housing may be removed from plaster frame to provide access to the junction box

Includes:

- Got Nail!™ bar hangers (Details Pg. 13)
- q-Channel bars with Pass-N-Thru™ (Details Pg. 13)
- Slide-N-Side™ junction box wire traps (Details Pg. 13)
- Quick Connect™ push wire nuts (Details Pg. 13)

Socket

- Porcelain socket with nickel plated brass screw shell
- Snap-in springs secure socket to socket plate, and may be detached when using socket supporting trims
- Overspray protector included

Thermal Protector

Self resetting thermal protector deactivates fixture if overheating occurs due to improper lamping or misapplied insulation

Trims

Halo Fit-All concept offers multiple trim options in a variety of design styles, and functional beam distributions to control beam angle and lumen delivery in accommodating various lamp types including Halogen, CFL and LED

Compliance

- cULus Listed 1598 luminaire
- cULus Listed damp location
- cULus Listed for wet location, covered ceiling, with select trims
- cULus Listed for feed through
- cULus Listed for direct contact with insulation and combustible material*
- RoHS compliant

*Not to be used in direct contact with spray foam insulation (Consult NEMA LSD57-2013)

E26 Screw Base IC Housing

H7ICAT

6
INCH

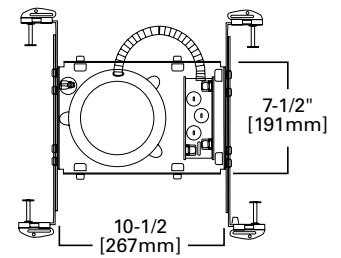
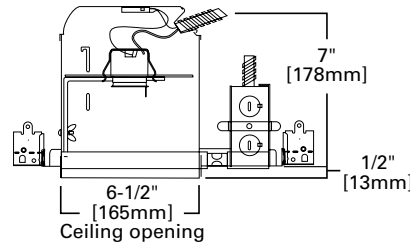

H7ICAT

6" IC, Air-Tite, New Construction, 120V

The H7 recessed housing is the standard in the industry for both light commercial and residential applications. H7 series features full-frame design, robust construction, feed-through listing, Got Nail! bar hangers; and may support use of higher wattage lamps. A wide variety of trims allows a number of different lighting effects to be created with one basic housing. H7ICAT is for installations where the housing will be in direct contact with insulation,* and its Air-Tite design will also meet restricted air flow code requirements. May be retrofit with compatible Halo LED lighting systems.



Special Features

- Got Nail!™ bar hangers
- q-Channel bars with Pass-N-Thru™
- Slide-N-Side™ junction box
- Quick Connect™ push wire nuts
- Air-Tite™ code compliant

Compatible Trims

30	300	404	6100	6110	6150
74	310	420	6101	6120	6162
76	327	426	6102	6121	6170
78	328	429	6103	6125	6215
170	353	430	6106	6126	6222
171	376	478	6107	6130	6230
172	378	4041	6108	6145	6255
173		4261	6109	6146	30SBAT



Trims for use in Halo listed housings



Select trims are classified for use in other housings, see www.cooperlighting.com/legal

Features

Housing

- Single wall aluminum housing
- Aluminum construction for greater heat dissipation
- Sealed and gasketed for Air-Tite™ ready installation
- Designed for insulated ceilings in direct contact with insulation* (May also be installed in non-insulated ceilings)

Socket Plate

- Rigid socket plate adjusts and locks without tools for various lamp sizes
- Socket plate and bracket may be removed when using socket supporting trims

Plaster Frame

- Housing adjusts in plaster frame to accommodate up to 1" ceiling thickness
- Galvanized steel construction
- Plaster frame features include:
 - Regressed locking screw for securing hanger bars
 - Cutouts for easily crimping hanger bars in position
 - Halo name embossed on plaster frame
 - The housing may be removed from plaster frame to provide access to the junction box
 - Pre-installed Air-Tite ready ceiling contact gasket

Includes:

- Got Nail!™ bar hangers (Details Pg. 13)
- q-Channel bars with Pass-N-Thru™ (Details Pg. 13)
- Slide-N-Side™ junction box wire traps (Details Pg. 13)
- Quick Connect™ push wire nuts (Details Pg. 13)
- Air-Tite™ code compliant (Details Pg. 13)

Socket

- Porcelain socket with nickel plated brass screw shell
- Snap-in springs secure socket to socket plate, and may be detached when using socket supporting trims
- Overspray protector included

Thermal Protector

Self resetting thermal protector deactivates fixture if overheating occurs due to improper lamping or misapplied insulation

Trims

Halo Fit-All concept offers multiple trim options in a variety of design styles, and functional beam distributions to control beam angle and lumen delivery in accommodating various lamp types including Halogen, CFL and LED

Compliance

- cULus Listed 1598 luminaire
- cULus Listed damp location
- cULus Listed for wet location, covered ceiling, with select trims
- cULus Listed for feed through
- cULus Listed for direct contact with insulation and combustible material*
- Air-Tite code compliant. Certified under ASTM E283; not exceeding 2.0 cfm (0.944 L/s) air leakage rate tested at a 1.57 psf (75 Pa) pressure differential.
- RoHS compliant

*Not to be used in direct contact with spray foam insulation (Consult NEMA LSD57-2013)

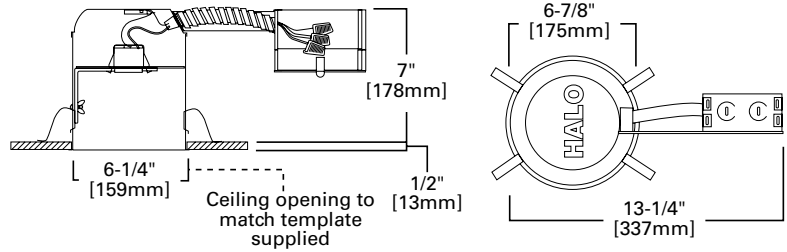

H7RICT

6" IC, Remodel, 120V

The H7 recessed remodel housing is the standard in the industry for both light commercial and residential applications. H7 series remodel housings feature robust construction, full-sized remodel junction box; and may support use of higher wattage lamps. Designed for use in existing ceilings, the remodel housing slips through opening in the finished ceiling. A wide variety of trims allows a number of different lighting effects to be created with one basic housing. The H7RICT is for installations where the housing will be in direct contact with insulation*. H7RICT may be converted into Air-Tite installation when used with Air-Tite trims. May be retrofit with compatible Halo LED lighting systems.



Special Features

Quick Connect™ push wire nuts

Compatible Trims

30°	300	404	6100	6110	6150
74°	310	420	6101	6120°	6162
76°	327	426	6102	6121°	6170
78°	328	429	6103	6125°	6215
170°	353	430°	6106	6126°	6222
171°	376	478	6107	6130	6230
172°	378	4041	6108	6145	6255
173°		4261	6109	6146	30SBAT°

Trims for use in Halo listed housings

Select trims are classified for use in other housings, see www.cooperlighting.com/legal

◊ Air-Tite trims can make the H7RICT installation ASTM E283 compliant

Features

Housing

- Single wall aluminum housing
- Aluminum construction for greater heat dissipation
- For installation from below the finished ceiling. Integral flange secures fixture against ceiling.

Socket Plate

- Rigid socket plate adjusts and locks without tools for various lamp sizes
- Socket plate and bracket may be removed when using socket supporting trims

Junction Box

- Seven 1/2" trade size conduit knockouts with true pry-out slots are positioned to accommodate straight conduit runs
- Four non-metallic (NM) cable pry-outs included

Includes:

- Quick Connect™ push wire nuts (Details Pg. 13)

Remodel Springs

Four remodel springs secure housing and accommodate 1/2" and 5/8" ceiling material

Socket

- Porcelain socket with nickel plated brass screw shell
- Snap-in springs secure socket to socket plate, and may be detached when using socket supporting trims
- Overspray protector included

Thermal Protector

Self resetting thermal protector deactivates fixture if overheating occurs due to improper lamping or misapplied insulation

Trims

Halo Fit-All concept offers multiple trim options in a variety of design styles, and functional beam distributions to control beam angle and lumen delivery in accommodating various lamp types including Halogen, CFL and LED

Compliance

- cULus Listed 1598 luminaire
- cULus Listed damp location
- cULus Listed for wet location, covered ceiling, with select trims
- cULus Listed for feed through
- cULus Listed for direct contact with insulation and combustible material*
- RoHS compliant

*Not to be used in direct contact with spray foam insulation (Consult NEMA LSD57-2013)

E26 Screw Base IC Housing

H7RICAT

6
INCH

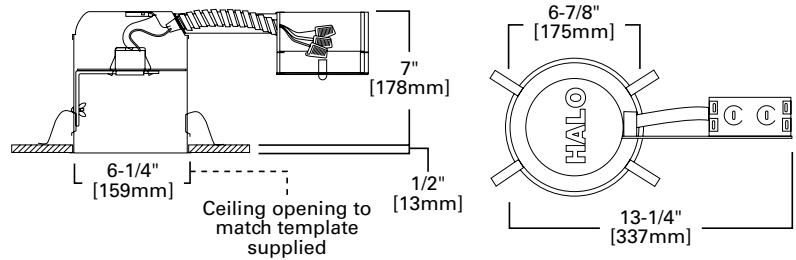

H7RICAT

6" ICAT, Air-Tite, Remodel, 120V

The H7 recessed remodel housing is the standard in the industry for both light commercial and residential applications. H7 series remodel housings feature robust construction, full-sized remodel junction box; and may support use of higher wattage lamps. Designed for use in existing ceilings, the remodel housing slips through opening in the finished ceiling. A wide variety of trims allows a number of different lighting effects to be created with one basic housing. The H7RICAT remodel housing is for installations where the housing will be in direct contact with insulation,* and its Air-Tite design will also meet restricted air flow code requirements. May be retrofit with compatible Halo LED lighting systems.



Special Features

Quick Connect™ push wire nuts
Air-Tite™ code compliant

Compatible Trims

30	300	404	6100	6110	6150
74	310	420	6101	6120	6162
76	327	426	6102	6121	6170
78	328	429	6103	6125	6215
170	353	430	6106	6126	6222
171	376	478	6107	6130	6230
172	378	4041	6108	6145	6255
173		4261	6109	6146	30SBAT



Trims for use in Halo listed housings



Select trims are classified for use in other housings, see www.cooperlighting.com/legal

Features

Housing

- Aluminum construction for greater heat dissipation
- For installation from below the finished ceiling. Integral flange secures fixture against ceiling.
- Pre-installed Air-Tite ready ceiling contact gasket on flange

Socket Plate

- Rigid socket plate adjusts and locks without tools for various lamp sizes
- Socket plate and bracket may be removed when using socket supporting trims

Junction Box

- Seven 1/2" trade size conduit knockouts with true pry-out slots are positioned to accommodate straight conduit runs
- Four non-metallic (NM) cable pry-outs included

Includes:

- Quick Connect™ push wire nuts (Details Pg. 13)
- Air-Tite™ code compliant (Details Pg. 13)

Remodel Springs

Four remodel springs secure housing and accommodate 1/2" and 5/8" ceiling material

Socket

- Porcelain socket with nickel plated brass screw shell
- Snap-in springs secure socket to socket plate, and may be detached when using socket supporting trims
- Overspray protector included

Thermal Protector

Self resetting thermal protector deactivates fixture if overheating occurs due to improper lamping or misapplied insulation

Trims

Halo Fit-All concept offers multiple trim options in a variety of design styles, and functional beam distributions to control beam angle and lumen delivery in accommodating various lamp types including Halogen, CFL and LED

Compliance

- cULus Listed 1598 luminaire
- cULus Listed damp location
- cULus Listed for wet location, covered ceiling, with select trims
- cULus Listed for feed through
- cULus Listed for direct contact with insulation and combustible material*
- Air-Tite code compliant. Certified under ASTM E283; not exceeding 2.0 cfm (0.944 L/s) air leakage rate tested at a 1.57 psf (75 Pa) pressure differential
- RoHS compliant

*Not to be used in direct contact with spray foam insulation (Consult NEMA LSD57-2013)

6
INCH

E26 Screw Base IC Housing

E7ICAT

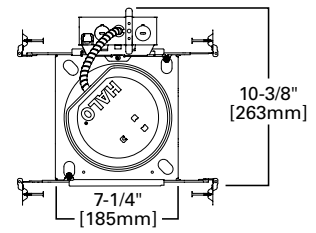
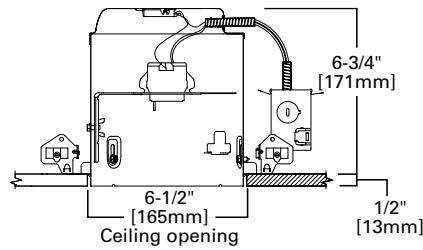

E7ICAT

6" IC, Air-Tite, New Construction Housing, 120V

The E7ICAT is a compact and efficient recessed housing optimized and listed for EISA compliant tungsten-halogen, CFL and LED lamps as well as incandescent. Housing is suitable for residential or light commercial applications. For installation in insulated ceilings* and non-insulated ceilings with Air-Tite code compliant construction. Use with a variety of trims and finishes to create different lighting effects or to match any decor. May be retrofitted with compatible Halo LED lighting systems.



Special Features

- All-Nail™ bar hangers
- q-Channel bars with Pass-N-Thru™
- Hinged j-box with Slide-N-Side™
- Quick Connect™ push wire nuts
- Air-Tite™ code compliant

Compatible Trims

30	300	404	6100	6110	6150
74	310	420	6101	6120	6162
76	327	426	6102	6121	6170
78	328	429	6103	6125	6215
170	353	430	6106	6126	6222
171	376	478	6107	6130	6230
172	378	4041	6108	6145	6255
173		4261	6109	6146	30SBAT

Trims for use in Halo listed housings

Select trims are classified for use in other housings, see www.cooperlighting.com/legal

Features

Housing

- Single wall die-formed aluminum housing
- Housing features a precision rolled interlocking collar which maintains aperture geometry for greater assurance of installation results
- Exclusive Air-Tite gasket meets code where required, and seals between housing, frame and finished ceiling - without need for additional caulk
- May be removed from the plaster frame to provide access to junction box

Socket Plate

- Rigid socket plate adjusts and locks without tools for various lamp sizes
- Socket plate and bracket may be removed when using socket supporting trims

Plaster Frame

- Galvanized steel frame. Housing adjusts in plaster frame to accommodate up to 3/8" – 1" ceiling thickness.
- (2) Regressed locking screws for securing hanger bars

Includes:

- All-Nail™ bar hangers (Details Pg. 15)
- q-Channel bars with Pass-N-Thru™ (Details Pg. 15)
- Hinged junction box with Slide-N-Side™ (Details Pg. 15)
- Quick Connect™ push wire nuts (Details Pg. 15)
- Air-Tite™ code compliant (Details Pg. 15)

Socket

- Porcelain socket with nickel plated brass screw shell
- Snap-in springs secure socket to socket plate, and may be detached when using socket supporting trims
- Shipped with socket overspray protector installed

Thermal Protector

Self resetting thermal protector deactivates fixture if overheating occurs due to improper lamping or misapplied insulation

Trims

Halo Fit-All concept offers multiple trim options in a variety of design styles, and functional beam distributions to control beam angle and lumen delivery in accommodating various lamp types including Halogen, CFL and LED

Compliance

- cULus Listed 1598 luminaire
- cULus Listed damp location
- cULus Listed for wet location, covered ceiling, with select trims
- cULus Listed for direct contact with insulation and combustible material*
- Air-Tite code compliant. Certified under ASTM E283; not exceeding 2.0 cfm (0.944 L/s) air leakage rate tested at a 1.57 psf (75 Pa) pressure differential.
- RoHS compliant

*Not to be used in direct contact with spray foam insulation (Consult NEMA LSD57-2013)

E26 Screw Base IC Housing

E7RICAT

6
INCH

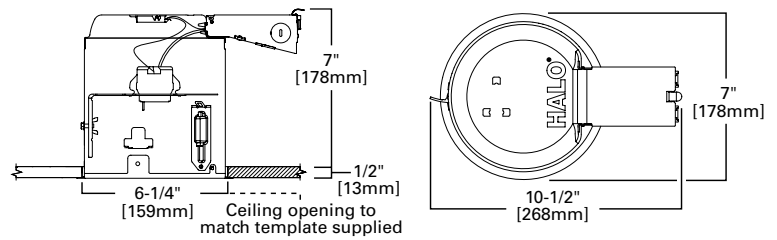

E7RICAT

6" IC, Air-Tite, Remodel Housing, 120V

The E7RICAT is a compact and efficient recessed remodel housing optimized and listed for EISA compliant tungsten-halogen, CFL and LED lamps as well as incandescent. Housing is suitable for residential or light commercial applications. For installation in insulated ceilings* and non-insulated ceilings with Air-Tite code compliant construction. Use with a variety of trims and finishes to create different lighting effects or to match any decor. May be retrofit with compatible Halo LED lighting systems.



Special Features

- Hinged j-box with Slide-N-Side™
- Quick Connect™ push wire nuts
- Air-Tite™ code compliant

Compatible Trims

30	300	426	6103	6121	6162
74	310	429	6106	6125	6170
76	327	430	6107	6126	6215
78	328	478	6108	6130	6222
170	353	4261	6109	6145	6230
171	376	6100	6110	6146	6255
172	420	6101	6120	6150	30SBAT
173		6102			



Trims for use in Halo listed housings



Select trims are classified for use in other housings, see www.cooperlighting.com/legal

Features

Housing

- Single wall die-formed aluminum housing
- Die formed flange maintains aperture geometry for greater assurance of installation results
- Exclusive Air-Tite gasket meets code where required, and seals between housing, flange and finished ceiling - without need for additional caulk
- For installation from below the finished ceiling. Integral flange secures fixture against ceiling.

Remodel Retention System - Speed Clamps

- Exclusive two integral speed clamps securely lock housing to ceiling, accommodating 3/8" to 2" ceiling materials

Socket Plate

- Rigid socket plate adjusts and locks without tools for various lamp sizes
- Socket plate and bracket may be removed when using socket supporting trims

Includes:

- Hinged junction box with Slide-N-Side™ (Details Pg. 15)
- Quick Connect™ push wire nuts (Details Pg. 15)
- Air-Tite™ code compliant (Details Pg. 15)

Socket

- Porcelain socket with nickel plated brass screw shell
- Snap-in springs secure socket to socket plate, and may be detached when using socket supporting trims
- Shipped with socket overspray protector installed

Thermal Protector

Self resetting thermal protector deactivates fixture if overheating occurs due to improper lamping or misapplied insulation

Trims

Halo Fit-All concept offers multiple trim options in a variety of design styles, and functional beam distributions to control beam angle and lumen delivery in accommodating various lamp types including Halogen, CFL and LED

Quick Connect™ Wiring Tray

- (3) Color coded 4-port push-in wire nuts included
- Captive tray holds push-nuts in place for one-handed connections to line, neutral & ground
- Speeds installation and increases reliability
- No additional wire nuts required

Compliance

- cULus Listed 1598 luminaire
- cULus Listed damp location
- cULus Listed for wet location, covered ceiling, with select trims
- cULus Listed for direct contact with insulation and combustible material*
- Air-Tite code compliant. Certified under ASTM E283; not exceeding 2.0 cfm (0.944 L/s) air leakage rate tested at a 1.57 psf (75 Pa) pressure differential
- RoHS compliant

*Not to be used in direct contact with spray foam insulation (Consult NEMA LSD57-2013)

Reflectors

30 Reflector, Self-flange

- Self-flange reflector with torsion spring retention
- Accepts a wide range of lamps
- Makes installation Air-Tite regardless of housing used
- Socket supporting reflector

Housings		Max Lamp Compatibility
H7ICT	H7RICT	60W A19, 75W PAR30S, 75W PAR30L, 65W PAR38,
H7ICAT	H7RICAT	65W BR30, 90W BR40, 75W R30
E7ICAT		53W A19, 75W PAR30S, 75W PAR30L, 65W PAR38,
E7RICAT		65W BR30, 90W BR40

Compatible with Halogen, Incandescent, LED* or CFL* lamps



30HAT
Haze Reflector, White Trim



30RGAT
Residential Gold Reflector, White Trim



30CAT
Clear Specular Reflector, White Trim

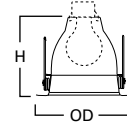

Dimensions**
H: 5" [127mm]
OD: 7-1/4" [184mm]



30SBAT Reflector, Self-flange

- Self-flange reflector with torsion spring retention
- Accepts a wide range of lamps
- Makes installation Air-Tite regardless of housing used
- Socket supporting reflector

Housings		Max Lamp Compatibility
H7ICT	H7ICAT	40W A19, 50W PAR30S, 75W PAR30L, 65W PAR38, 65W BR30, 75W R30, 65W BR40
H7RICT	H7RICAT	40W A19, 50W PAR30S, 75W PAR30L, 65W PAR38, 45W BR30, 65W BR40, 50W R30, 65W R40
E7ICAT		40W A19, 50W PAR30S, 75W PAR30L, 65W PAR38, 65W BR30, 65W BR40

Compatible with Halogen, Incandescent, LED* or CFL* lamps



30SBAT
Specular Black Reflector & Trim

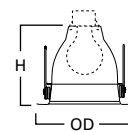

Dimensions**
H: 5" [127mm]
OD: 7-1/4" [184mm]



404 Specular Reflector

- Full reflector for use with A-lamps
- Friction clip retention on housing plaster ring
- Removable trim ring
- Accessories available: TRM6 designer trim rings, OT403 oversize trim ring
- Socket supporting reflector

Housings		Max Lamp Compatibility
H7ICT	H7RICT	60W A19
H7ICAT	H7RICAT	
E7ICAT		404C, 404H: 53W A19 404SN, 404TBZ: 43W A19

Compatible with Halogen, Incandescent, LED* or CFL* lamps



404C
Clear Specular Reflector, White Trim



404H
Haze Reflector, White Trim



404SN
Satin Nickel Reflector, Satin Nickel Trim



404TBZ
Tuscan Bronze Reflector, Tuscan Bronze Trim



Friction Clips install on housing plaster ring

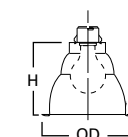

Dimensions**
H: 5" [127mm]
OD: 7-1/4" [184mm]

426 Reflector Cone

- Accepts a wide variety of lamps
- Coil spring retention
- Removable trim ring
- Accessories available: TRM6 designer trim rings, OT403 oversize trim ring

Housings		Max Lamp Compatibility
H7ICT	H7RICT	50W PAR30S, 75W PAR30L,
H7ICAT	H7RICAT	65W BR30, 75W R30, 85W BR40
E7ICAT		50W PAR30S, 75W PAR30L, 45W PAR38, 65W BR30, 85W BR40

Compatible with Halogen, Incandescent, LED* or CFL* lamps



426
Satin Specular Reflector Cone, White Trim



426MB
Black Specular Reflector Cone, White Trim



426H
Haze Reflector Cone, White Trim



426SN
Satin Nickel Reflector Cone, Satin Nickel Trim



426TBZ
Tuscan Bronze Reflector Cone, Tuscan Bronze Trim



H930 (H7 Housings ONLY) PAR lamp aiming accessory for 310 and 426 trims. Allows 30° tilt and 358° rotation. 50W PAR30.

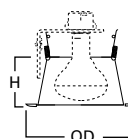

Dimensions**
H: 2-5/8" [67mm]
OD: 7-1/4" [184mm]

*UL1993 listed LED & CFL equivalent lamps permitted. Consult lamp manufacturer for conditions of use. Eaton does not warranty the lamp.

Key: **A: Luminous Aperture, **H:** Height, **OD:** Trim Outside Diameter

E26 Screw Base Trims

IC Housings: H7ICT • H7ICAT • H7RICT • H7RICAT • E7ICAT • E7RICAT

6
INCH

429 Dayform White Cone

- Contoured sides shield interior view of housing
- Removable trim ring
- Accessories available: TRM6 designer trim rings, OT403 oversize trim ring



429P
White Reflector, White Self-flange

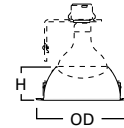

Dimensions**
H: 3" [76mm]
OD: 7-1/4" [184mm]

Housings		Max Lamp Compatibility
H7ICT	H7RICT	50W PAR30S, 75W PAR30L,
H7ICAT	H7RICAT	65W BR30, 75W R30
E7ICAT		E7RICAT
		50W PAR30S, 75W PAR30L,
		65W BR30

Compatible with Halogen, Incandescent, LED* or CFL* lamps

4041 White Reflector, Self-flange

- Self-flange full reflector for use with A-lamps
- Friction clip retention on housing plaster ring
- Accessories available: OT403 oversize trim ring
- Socket supporting reflector



4041P
White Reflector, White Self-flange

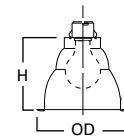

Dimensions**
H: 5-1/4" [133mm]
OD: 7-1/4" [184mm]

Housings		Max Lamp Compatibility
H7ICT	H7RICT	60W A19
H7ICAT	H7RICAT	
E7ICAT		53W A19

Compatible with Halogen, Incandescent, LED* or CFL* lamps

4261 White Reflector Cone, Self-flange

- Self-flange reflector cone for use with R and PAR lamps
- Coil spring retention



4261P
White Reflector, White Self-flange

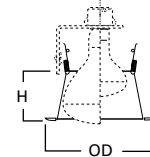

Dimensions**
H: 2-5/8" [67mm]
OD: 7-1/4" [184mm]

Housings		Max Lamp Compatibility
H7ICT	H7RICT	50W PAR30S, 75W PAR30L,
H7ICAT	H7RICAT	
		85W BR40
E7ICAT		E7RICAT
		50W PAR30S, 75W PAR30L,
		45W PAR38, 65W BR30,
		85W BR40

Compatible with Halogen, Incandescent, LED* or CFL* lamps

6106 Straight Reflector Cone, Self-flange

- Straight sides of cone reflector for large diameter BR40 and PAR38, as well as BR30 and PAR30 lamps
- Self-flange reflector cone
- Coil spring retention
- Self-flange trim ring sized to hide gaps caused by construction tolerances



6106SC
Specular Clear Reflector, White Self-flange

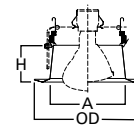

Dimensions**
A: 5-3/8" [137mm]
H: 2-5/8" [68mm]
OD: 7-3/4" [197mm]

Housings		Max Lamp Compatibility
H7ICT	H7RICT	50W PAR30S, 75W PAR30L,
H7ICAT	H7RICAT	
E7ICAT		E7RICAT
		40W BR40

Compatible with Halogen, Incandescent, LED* or CFL* lamps

6107 Tapered Reflector, Self-flange

- Self-flange reflector cone
- Contoured tapered sides of cone reflector for BR30 and PAR30 lamps
- Coil spring retention
- Self-flange trim ring sized to hide gaps caused by construction tolerances



6107SC
Specular Clear Reflector, White Self-flange

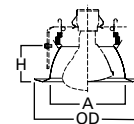

Dimensions**
A: 5-3/8" [137mm]
H: 2-5/8" [65mm]
OD: 7-3/4" [197mm]

Housings		Max Lamp Compatibility
H7ICT	H7RICT	50W PAR30S, 75W PAR30L,
H7ICAT	H7RICAT	
E7ICAT		E7RICAT

Compatible with Halogen, Incandescent, LED* or CFL* lamps

*UL1993 listed LED & CFL equivalent lamps permitted. Consult lamp manufacturer for conditions of use. Eaton does not warranty the lamp.

**Key: A: Luminous Aperture, H: Height, OD: Trim Outside Diameter

6120 Full Cone Reflector, Self-flange

- Full cone reflector
- Torsion spring retention
- Socket supporting reflector
- Self-flange trim ring sized to hide gaps caused by construction tolerances
- Makes installation Air-Tite regardless of housing used



6120WH
White Reflector, White Self-flange



6120SN
Satin Nickel Reflector, Satin Nickel Self-flange



6120TBZ
Tuscan Bronze Reflector, Tuscan Bronze Self-flange

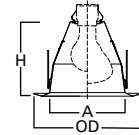

Dimensions**
A: 5-3/8" [137mm]
H: 5-3/8" [138mm]
OD: 7-3/4" [197mm]

Housings		Max Lamp Compatibility
H7ICT	H7RICT	6120WH: 43W A19, 75W PAR30S, 75W PAR30L, 65W PAR38, 65W BR30, 70W BR40
H7ICAT	H7RICAT	6120SN, 6120TBZ: 43W A19, 60W PAR30S, 75W PAR30L, 65W PAR38, 65W BR30, 70W BR40
E7ICAT	E7RICAT	

Compatible with Halogen, Incandescent, LED* or CFL* lamps

6121 Shallow Full Cone Reflector, Self-flange

- Shallow full cone reflector
- Torsion spring retention
- Self-flange trim ring sized to hide gaps caused by construction tolerances



6121WH
White Reflector, White Self-flange

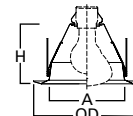

Dimensions**
A: 5-3/8" [137mm]
H: 4-3/8" [110mm]
OD: 7-3/4" [197mm]

Housings		Max Lamp Compatibility
H7ICT	H7RICT	43W A19, 75W PAR30S, 75W PAR30L, 65W BR30
H7ICAT	H7RICAT	
E7ICAT	E7RICAT	

Compatible with Halogen, Incandescent, LED* or CFL* lamps

Baffles

30 Baffle, Self-flange

- Self-flange metal baffle with upper reflector
- Socket supporting baffle
- Torsion spring retention
- Accepts a wide range of lamps
- Makes installation Air-Tite regardless of housing used



30WAT
White Baffle & Reflector, White Trim



30WATH
White Baffle & Clear Reflector, White Trim



30PAT
Black Baffle & Clear Reflector, White Trim



30SNAT
Satin Nickel Baffle & Reflector, Satin Nickel Trim



30TBZAT
Tuscan Bronze Baffle & Reflector, Tuscan Bronze Trim

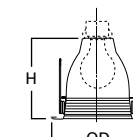

Dimensions**
H: 5" [127mm]
OD: 7-1/4" [184mm]

Housings		Max Lamp Compatibility
H7ICT	H7RICT	40W A19, 75W PAR30S, 75W PAR30L, 65W PAR38, 65W BR30, 90W BR40, 75W R30
H7ICAT	H7RICAT	
		30WAT, 30WATH, 30PAT: 40W A19, 75W PAR30S, 75W PAR30L, 65W PAR38, 65W BR30, 90W BR40
		30SNAT, 30TBZAT: 40W A19, 60W PAR30S, 75W PAR30L, 65W PAR38, 65W BR30, 90W BR40
E7ICAT	E7RICAT	

Compatible with Halogen, Incandescent, LED* or CFL* lamps

*UL1993 listed LED & CFL equivalent lamps permitted. Consult lamp manufacturer for conditions of use. Eaton does not warranty the lamp.

**Key: A: Luminous Aperture, H: Height, OD: Trim Outside Diameter

E26 Screw Base Trims

IC Housings: H7ICT • H7ICAT • H7RICT • H7RICAT • E7ICAT • E7RICAT

6
INCH

310 Coilex® Baffle

- Black or white phenolic Coilex baffle with white metal trim ring
- Removable trim ring
- Accessories available: TRM6 designer trim rings, OT403 oversize trim ring
- Coil spring retention



310W
White Coilex Baffle, White Trim



310P
Black Coilex Baffle, White Trim



310SN
Satin Nickel Coilex Baffle,
Satin Nickel Trim



310TBZ
Tuscan Bronze Coilex Baffle,
Tuscan Bronze Trim

Housings Max Lamp Compatibility

Housings	Max Lamp Compatibility
H7ICT H7RICT	50W PAR30S, 75W PAR30L, 45W PAR38, 65W BR30,
H7ICAT H7RICAT	75W R30, 85W BR40
H7ICAT E7RICAT	50W PAR30S, 75W PAR30L, 45W PAR38, 65W BR30, 85W BR40

Compatible with Halogen, Incandescent, LED* or CFL* lamps



H930 (H7 Housings ONLY) PAR lamp aiming accessory for 310 and 426 trims. Allows 30° tilt and 358° rotation. 50W PAR30.

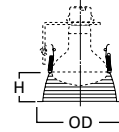

Dimensions**
H: 3-1/16" [78mm]
OD: 7-1/4" [184mm]

353 Metal Baffle

- Metallic finish trim rings and baffles
- Coil spring retention
- Removable trim ring



353SN
Satin Nickel Baffle,
Satin Nickel Trim



353TBZ
Tuscan Bronze Baffle,
Tuscan Bronze Trim

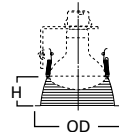

Dimensions**
H: 3" [76mm]
OD: 7-1/4" [184mm]

Housings Max Lamp Compatibility

Housings	Max Lamp Compatibility
H7ICT H7RICT	50W PAR30S, 75W PAR30L,
H7ICAT H7RICAT	65W BR30, 75W R30
E7ICAT E7RICAT	50W PAR30S, 75W PAR30L, 65W BR30

Compatible with Halogen, Incandescent, LED* or CFL* lamps

6100 Tapered Metal Baffle with (2) Trim Rings

- Contoured tapered sides of metal baffle
- Two plastic removable trim rings included narrow 7.25" OD and wide oversized 8.00" OD
- Coil spring retention



6100WB
White Baffle, Narrow & Wide
White Trims (Included)



6100BB
Black Baffle, Narrow & Wide
White Trims (Included)

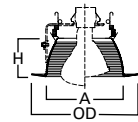

Dimensions**
A: 5-3/4" [148mm]
H: 2-7/8" [74mm]
OD: 7-1/4" [184mm] Narrow
OD: 8" [203mm] Wide

Housings Max Lamp Compatibility

Housings	Max Lamp Compatibility
H7ICT H7RICT	50W PAR30S, 75W PAR30L,
H7ICAT H7RICAT	65W BR30, 85W BR40
E7ICAT E7RICAT	

Compatible with Halogen, Incandescent, LED* or CFL* lamps

*UL1993 listed LED & CFL equivalent lamps permitted. Consult lamp manufacturer for conditions of use. Eaton does not warranty the lamp.

**Key: A: Luminous Aperture, H: Height, OD: Trim Outside Diameter

6101 Straight Metal Baffle with (2) Trim Rings

- Straight sides of metal baffle for large diameter lamps
- Two plastic removable trim rings included narrow 7.25" OD and wide 8.00" OD
- Coil spring retention

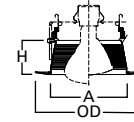

Dimensions**

A: 5-5/8" [144mm]
H: 2-5/8" [66mm]
OD: 7-1/4" [184mm] Narrow
OD: 8" [203mm] Wide

Housings **Max Lamp Compatibility**

Housing	Max Lamp Compatibility
H7ICT H7RICT	50W PAR30S, 75W PAR30L,
H7ICAT H7RICAT	45W PAR38, 65W BR30,
E7ICAT E7RICAT	40W BR40

Compatible with Halogen, Incandescent, LED* or CFL* lamps

6101WB
White Baffle, Narrow & Wide
White Trim (Included)

6101BB
Black Baffle, Narrow & Wide
White Trim (Included)

6102 Tapered Metal Baffle, Self-flange

- Contoured tapered sides of metal baffle
- Coil spring retention
- Self-flange trim ring sized to hide gaps caused by construction tolerances

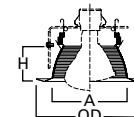

Dimensions**

A: 5-3/8" [137mm]
H: 2-5/8" [65mm]
OD: 7-3/4" [197mm]

Housings **Max Lamp Compatibility**

Housing	Max Lamp Compatibility
H7ICT H7RICT	50W PAR30S, 75W PAR30L,
H7ICAT H7RICAT	65W BR30, 85W BR40
E7ICAT E7RICAT	

Compatible with Halogen, Incandescent, LED* or CFL* lamps

6102WB
White Baffle, White Self-flange

6102BB
Black Baffle, White Self-flange

6103 Straight Metal Baffle, Self-flange

- Straight sides of metal baffle for large diameter lamps
- Coil spring retention
- Self-flange trim ring sized to hide gaps caused by construction tolerances

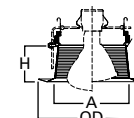

Dimensions**

A: 5-3/8" [137mm]
H: 2-5/8" [68mm]
OD: 7-3/4" [197mm]

Housings **Max Lamp Compatibility**

Housing	Max Lamp Compatibility
H7ICT H7RICT	50W PAR30S, 75W PAR30L,
H7ICAT H7RICAT	45W PAR38, 65W BR30,
E7ICAT E7RICAT	40W BR40

Compatible with Halogen, Incandescent, LED* or CFL* lamps

6103WB
White Baffle, White Self-flange

6103BB
Black Baffle, White Self-flange

6108 Coilex® Straight Plastic Baffle, Self-flange

- Straight sides of Coilex baffle for large diameter lamps
- Coil spring retention
- Self-flange trim ring sized to hide gaps caused by construction tolerances

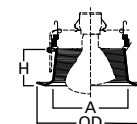

Dimensions**

A: 5-3/8" [137mm]
H: 2-5/8" [68mm]
OD: 7-3/4" [197mm]

Housings **Max Lamp Compatibility**

Housing	Max Lamp Compatibility
H7ICT H7RICT	39W PAR30S, 75W PAR30L,
H7ICAT H7RICAT	45W PAR38, 65W BR30,
E7ICAT E7RICAT	40W BR40

Compatible with Halogen, Incandescent, LED* or CFL* lamps

6108WB
White Plastic Straight Coilex
Baffle, White Self-flange

6108BB
Black Plastic Straight Coilex
Baffle, White Self-flange

6108BKBB
Black Plastic Straight Coilex
Baffle, Black Self-flange

6109 Coilex® Tapered Baffle, Self-flange

- Contoured tapered sides of Coilex baffle
- Coil spring retention
- Self-flange trim ring sized to hide gaps caused by construction tolerances

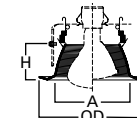

Dimensions**

A: 5-3/8" [137mm]
H: 2-5/8" [65mm]
OD: 7-3/4" [197mm]

Housings **Max Lamp Compatibility**

Housing	Max Lamp Compatibility
H7ICT H7RICT	50W PAR30S, 75W PAR30L,
H7ICAT H7RICAT	45W PAR38, 65W BR30,
E7ICAT E7RICAT	85W BR40

Compatible with Halogen, Incandescent, LED* or CFL* lamps

6109WB
White Plastic Tapered Coilex
Baffle, White Self-flange

6109BB
Black Plastic Tapered Coilex
Baffle, White Self-flange

6109BKBB
Black Plastic Tapered Coilex
Baffle, Black Self-flange

*UL1993 listed LED & CFL equivalent lamps permitted. Consult lamp manufacturer for conditions of use. Eaton does not warranty the lamp.

**Key: A: Luminous Aperture, H: Height, OD: Trim Outside Diameter

E26 Screw Base Trims

IC Housings: H7ICT • H7ICAT • H7RICT • H7RICAT • E7ICAT • E7RICAT

6
INCH

6110 Perfext™ Baffle, Self-flange

- Perforated pattern baffle contoured for BR30 and PAR30 lamps
- Coil spring retention
- Self-flange trim ring sized to hide gaps caused by construction tolerances

Housings		Max Lamp Compatibility
H7ICT	H7RICT	50W PAR30S, 60W PAR30L, 65W BR30
H7ICAT	H7RICAT	
E7ICAT	E7RICAT	

Compatible with Halogen, Incandescent, LED* or CFL* lamps



6110WB
White Perfext Baffle,
White Self-flange



6110BB
Black Perfext Baffle,
White Self-flange



6110BKBB
Black Perfext Baffle,
Black Self-flange

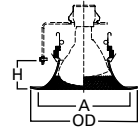

Dimensions**
A: 6-5/8" [169mm]
H: 2-1/8" [54mm]
OD: 7-3/4" [197mm]

6125 Full Cone Baffle, Self-flange

- Full cone baffle
- Torsion spring retention
- Socket supporting baffle
- Self-flange trim ring sized to hide gaps caused by construction tolerances

Housings		Max Lamp Compatibility
H7ICT	H7RICT	6125WB: 43W A19, 75W PAR30S, 75W PAR30L, 65W PAR38, 65W BR30, 90W BR40
H7ICAT	H7RICAT	
E7ICAT	E7RICAT	6125BB, 6125BKBB: 43W A19, 75W PAR30S, 75W PAR30L, 65W PAR38, 65W BR30, 85W BR40

Compatible with Halogen, Incandescent, LED* or CFL* lamps



6125WB
White Baffle, White Self-flange



6125BB
Black Baffle, White Self-flange



6125BKBB
Black Baffle, Black Self-flange

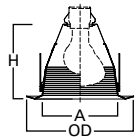

Dimensions**
A: 5-3/8" [137mm]
H: 5-3/8" [138mm]
OD: 7-3/4" [197mm]

6126 Shallow Full Cone Baffle, Self-flange

- Shallow full cone baffle
- Torsion spring retention
- Socket supporting baffle
- Self-flange trim ring sized to hide gaps caused by construction tolerances

Housings		Max Lamp Compatibility
H7ICT	H7RICT	43W A19, 75W PAR30S, 75W PAR30L, 65W BR30
H7ICAT	H7RICAT	
E7ICAT	E7RICAT	

Compatible with Halogen, Incandescent, LED* or CFL* lamps



6126WB
White Baffle, White Self-flange



6126BB
Black Baffle, White Self-flange

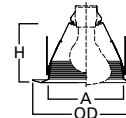

Dimensions**
A: 5-3/8" [137mm]
H: 4-3/8" [110mm]
OD: 7-3/4" [197mm]

Adjustable – Eyeballs & Gimbals

74 Eyeball 30° Tilt, Self-flange

- Provides optimum position for PAR30S lamps
- Torsion spring retention
- Socket supporting eyeball

Housings		Max Lamp Compatibility
H7ICT	H7RICT	75W PAR30S
H7ICAT	H7RICAT	
E7ICAT	E7RICAT	

Compatible with Halogen, Incandescent, LED* or CFL* lamps



74P
White Eyeball, White Trim

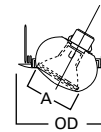

Dimensions**
A: 3-7/8" [98mm]
OD: 8" [203mm]

*UL1993 listed LED & CFL equivalent lamps permitted. Consult lamp manufacturer for conditions of use. Eaton does not warranty the lamp.

**Key: A: Luminous Aperture, H: Height, OD: Trim Outside Diameter

76 Gimbal 30° Tilt, Self-flange

- For use with PAR38 lamps
- 30° tilt
- Torsion spring retention



76P
White Gimbal, White Trim

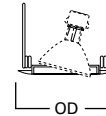

Dimensions**
OD: 8" [203mm]

Housings	Max Lamp Compatibility
H7ICT H7RICT	
H7ICAT H7RICAT	45W PAR38
E7ICAT E7RICAT	

Compatible with Halogen, Incandescent, LED* or CFL* lamps

78 Eyeball 30° Tilt, Self-flange

- 30° tilt, 360° rotation
- Torsion spring retention
- Wide choice of finishes for any decor
- Socket supporting eyeball
- 78PAT makes installation Air-Tite regardless of housing used



78P
White Eyeball, White Trim



78PAT
White Eyeball, White Trim
air-tite



78SN
Satin Nickel Eyeball,
Satin Nickel Trim



78TBZ
Tuscan Bronze Eyeball,
Tuscan Bronze Trim

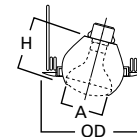

Dimensions**
A: 4" [100mm]
H: 4-1/8" [105mm]
OD: 8" [203mm]

Housings	Max Lamp Compatibility
H7ICT H7RICT	75W PAR30S, 75W PAR30L,
H7ICAT H7RICAT	65W BR30, 75W R30
E7ICAT E7RICAT	75W PAR30S, 75W PAR30L, 65W BR30

Compatible with Halogen, Incandescent, LED* or CFL* lamps

376 Regressed Gimbal 30° Tilt, Self-flange

- 30° tilt
- Regressed gimbal with baffle
- Torsion spring retention
- Socket supporting gimbal



376W
White Baffle, White Trim



376P
Black Baffle, White Trim

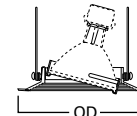

Dimensions**
OD: 7-1/4" [184mm]

Housings	Max Lamp Compatibility
H7ICT H7RICT	
H7ICAT H7RICAT	50W PAR30S, 50W PAR30L
E7ICAT E7RICAT	

Compatible with Halogen, Incandescent, LED* or CFL* lamps

378 Regressed Gimbal with Splay 25° Tilt, Self-flange

- 25° tilt
- Regressed gimbal with splay trim
- Removable trim ring
- Accessories available: TRM6 designer trim rings, OT403 oversize trim ring
- Friction clips on trim
- Socket supporting gimbal



378P
White Splay, White Trim



378
Clear Specular Splay, White Trim

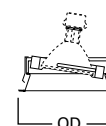

Dimensions**
OD: 7-1/4" [184mm]

Housings	Max Lamp Compatibility
H7ICT H7RICT	
H7ICAT H7RICAT	35W PAR30L
E7ICAT	

Compatible with Halogen, Incandescent, LED* or CFL* lamps



Friction Clips on Trim

420 Regressed Eyeball 30° Tilt, Self-flange

- Regressed eyeball with baffle splay
- Removable trim ring
- Accessories available: TRM6 designer trim rings, OT403 oversize trim ring
- Socket supporting eyeball



420W
White Eyeball & Baffle,
White Trim



420P
White Eyeball & Black Baffle,
White Trim

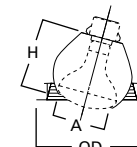

Dimensions**
A: 4" [100mm]
H: 4" [102mm]
OD: 7-1/4" [184mm]

Housings	Max Lamp Compatibility
H7ICT H7RICT	
H7ICAT H7RICAT	50W PAR30S, 50W PAR30L, 60W BR30
E7ICAT E7RICAT	

Compatible with Halogen, Incandescent, LED* or CFL* lamps

*UL1993 listed LED & CFL equivalent lamps permitted. Consult lamp manufacturer for conditions of use. Eaton does not warranty the lamp.

**Key: A: Luminous Aperture, H: Height, OD: Trim Outside Diameter

E26 Screw Base Trims

IC Housings: H7ICT • H7ICAT • H7RICT • H7RICAT • E7ICAT • E7RICAT

6
INCH

478 Adjustable Regressed Gimbal with Splay 25° Tilt, Self-flange

- 25° tilt
- Adjustable gimbal with splay trim for PAR38 lamps
- Removable trim ring
- Accessories available: TRM6 designer trim rings, OT403 oversize trim ring
- Friction clips on trim
- Socket supporting gimbal



478P
White Splay, White Trim

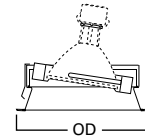

Dimensions**
OD: 7-1/4" [184mm]

Housings Max Lamp Compatibility

Housing	Max Lamp Compatibility
H7ICT H7RICT	
H7ICAT H7RICAT	45W PAR38
E7ICAT E7RICAT	

Compatible with Halogen, Incandescent, LED* or CFL* lamps

6130 Eyeball 35° Tilt, Self-flange

- 35° tilt, 360° rotation
- Adjustable eyeball trim for BR30 and PAR30 lamps
- Torsion spring retention
- Socket supporting eyeball
- Self-flange trim ring sized to hide gaps caused by construction tolerances



6130WH
White Eyeball, White Self-flange

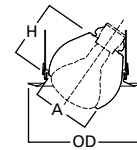

Dimensions**
A: 3-7/8" [100mm]
H: 3-7/8" [100mm]
OD: 7-3/4" [197mm]

Housings Max Lamp Compatibility

Housing	Max Lamp Compatibility
H7ICT H7RICT	
H7ICAT H7RICAT	50W PAR30S, 75W PAR30L, 65W BR30
E7ICAT E7RICAT	

Compatible with Halogen, Incandescent, LED* or CFL* lamps

6170 Gimbal 25° Tilt, Self-flange

- 25° tilt, 360° rotation
- Adjustable gimbal for PAR38 lamps
- Torsion spring retention
- Socket supporting gimbal
- Self-flange trim ring sized to hide gaps caused by construction tolerances



6170WH
White Gimbal, White Self-flange



6170BK
Black Gimbal, Black Self-flange



6170SN
Satin Nickel Gimbal, Satin Nickel Self-flange



6170TBZ
Tuscan Bronze Gimbal, Tuscan Bronze Self-flange

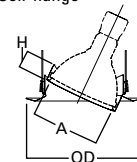

Dimensions**
A: 4-1/2" [113mm]
H: 1-1/8" [30mm]
OD: 7-3/4" [197mm]

Housings Max Lamp Compatibility

Housing	Max Lamp Compatibility
H7ICT H7RICT	
H7ICAT H7RICAT	45W PAR38
E7ICAT E7RICAT	

Compatible with Halogen, Incandescent, LED* or CFL* lamps

6215 Double Gimbal 30°-50° Tilt, Self-flange

- 30°-50° tilt, 360° rotation
- 50° tilt with double gimbal design using compound angles
- Double gimbal for PAR30 lamps
- Torsion spring retention
- Shallow housings are compatible with PAR30S (short-neck) lamps
- Socket supporting gimbal
- Self-flange trim ring sized to hide gaps caused by construction tolerances



6215WH
White Gimbal, White Self-flange



6215BK
Black Gimbal, Black Self-flange



6215SN
Satin Nickel Gimbal, Satin Nickel Self-flange



6215TBZ
Tuscan Bronze Gimbal, Tuscan Bronze Self-flange

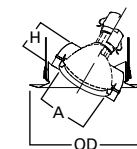

Dimensions**
A: 3-3/8" [84mm]
H: 2" [51mm]
OD: 7-3/4" [197mm]

Housings Max Lamp Compatibility

Housing	Max Lamp Compatibility
H7ICT H7RICT	
H7ICAT H7RICAT	60W PAR30S, 60W PAR30L
E7ICAT E7RICAT	

Compatible with Halogen, Incandescent, LED* or CFL* lamps

*UL1993 listed LED & CFL equivalent lamps permitted. Consult lamp manufacturer for conditions of use. Eaton does not warranty the lamp.

**Key: A: Luminous Aperture, H: Height, OD: Trim Outside Diameter

6222 Regressed Angle Cut Adjustable Gimbal, 45° Tilt, Self-flange

- 45° tilt, 360° rotation
- Fully regressed gimbal – self-flange ring
- Torsion spring retention
- Socket supporting gimbal
- Reflector and baffle options
- Accommodates tilt of gimbal in a full regressed cut cone
- Self-flange trim ring sized to hide gaps caused by construction tolerances



6222WB
White Baffle, White Trim



6222BB
Black Baffle, White Trim



6222SC
Specular Clear Reflector
White Trim



6222H
Haze Reflector, White Trim

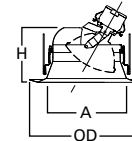

Dimensions**

A: 3-3/4" [95mm]
H: 5-3/8" [137mm]
OD: 7-3/4" [197mm]

Housings Max Lamp Compatibility

H7ICT	H7RICT	
H7ICAT	H7RICAT	39W PAR30S, 60W PAR30L
E7ICAT	E7RICAT	

Compatible with Halogen, Incandescent, LED* or CFL* lamps

Lenses & Wet Location Showerlights

170 Albalite Lens with Reflector

- White trim with Albalite glass lens
- PS version features non-conductive, non-corrosive gasketed polymer (plastic) trim ring
- PS version is "dead-front" construction and is wet location listed for use in showers
- Torsion spring retention
- PS version is Air-Tite; making any installation Air-Tite



170P
Albalite Lens, White Trim



170PS
Albalite Lens, Polymer White Trim

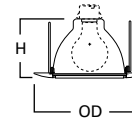
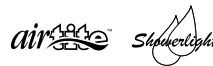

Dimensions**

H: 4" [102mm]
OD: 8" [203mm]

Housings Max Lamp Compatibility

H7ICT	H7ICAT	
H7RICT	H7RICAT	40W A19
E7ICAT	E7RICAT	29W A19

Compatible with Halogen, Incandescent, LED* or CFL* lamps

171 Drop Opal Glass Lens with Reflector

- White trim with drop opal glass lens
- PS version features non-conductive, non-corrosive gasketed polymer (plastic) trim ring
- PS version is "dead-front" construction and is wet location listed for use in showers
- Torsion spring retention
- PS version is Air-Tite; making any installation Air-Tite



171P
Drop Opal Lens, White Trim



171PS
Drop Opal Lens, White Polymer Trim

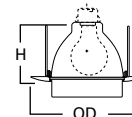
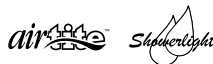

Dimensions**

H: 4" [102mm]
OD: 8" [203mm]

Housings Max Lamp Compatibility

H7ICT	H7ICAT	
H7RICT	H7RICAT	40W A19
E7ICAT	E7RICAT	29W A19

Compatible with Halogen, Incandescent, LED* or CFL* lamps

*UL1993 listed LED & CFL equivalent lamps permitted. Consult lamp manufacturer for conditions of use. Eaton does not warranty the lamp.

**Key: A: Luminous Aperture, H: Height, OD: Trim Outside Diameter

E26 Screw Base Trims

IC Housings: H7ICT • H7ICAT • H7RICT • H7RICAT • E7ICAT • E7RICAT

6
INCH

172 Dome Glass Lens with Reflector

- Frosted glass dome
- Features "dead-front" construction and is wet location listed for use in showers
- Non-conductive, non-corrosive gasketed polymer (plastic) trim ring
- Torsion spring retention
- Air-Tite trim makes any installation Air-Tite



172PS
Frosted Glass Dome,
White Polymer Trim



172TBZS
Frosted Glass Dome,
Tuscan Bronze Polymer Trim

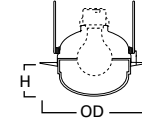

Dimensions**
H: 2-1/8" [54mm]
OD: 7-3/4" [197mm]

Housings Max Lamp Compatibility

H7ICT	H7ICAT	60W A19, 50W PAR30S
H7RICT	H7RICAT	

E7ICAT	E7RICAT	172PS: 53W A19, 50W PAR30S 172SNS, 172TBZS: 43W A19, 50W PAR30S
--------	---------	---

Compatible with Halogen, Incandescent, LED* or CFL* lamps

173 Fresnel Lens with Reflector

- White trim with glass Fresnel lens
- PS version features non-conductive, non-corrosive gasketed polymer (plastic) trim ring
- PS version is "dead-front" construction and is wet location listed for use in showers
- Torsion spring retention
- PS version is Air-Tite; making any installation Air-Tite



173P
Fresnel Lens, White Trim



173PS
Fresnel Lens, White Polymer Trim

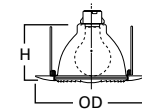

Dimensions**
H: 4" [102mm]
OD: 8" [203mm]

Housings Max Lamp Compatibility

H7ICT	H7ICAT	40W A19
H7RICT	H7RICAT	

E7ICAT	E7RICAT	29W A19
--------	---------	---------

Compatible with Halogen, Incandescent, LED* or CFL* lamps

6145 Open Wet Location, Shallow Reflector, Self-flange

- Open wet location shallow Showerlight for PAR30 and PAR38 outdoor rated lamps ONLY
- Torsion spring retention
- Socket supporting cone
- Self-flange trim ring sized to hide gaps caused by construction tolerances



6145WH
White Shallow Reflector,
White Self-flange



6145SN
Satin Nickel Shallow Reflector,
Satin Nickel Self-flange



6145TBZ
Tuscan Bronze Shallow Reflector,
Tuscan Bronze Self-flange

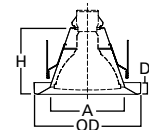

Dimensions**
A: 5-3/8" [136mm]
D: 7/8" [22mm]
H: 4-7/8" [123mm]
OD: 7-3/4" [197mm]

Housings Max Lamp Compatibility

H7ICT	H7ICAT	75W PAR30S, 75W PAR30L, 80W PAR38
H7RICT	H7RICAT	
E7ICAT	E7RICAT	

Compatible with Halogen, Incandescent, LED* or CFL* lamps

**Outdoor
Rated Lamp
ONLY**
(Purchase Separately)



Lamp Gasket
(Included)

6146 Open Wet Location, Full Reflector Self-flange

- Open wet location Showerlight for PAR30 and PAR38 outdoor rated lamps ONLY
- Torsion spring retention
- Socket supporting cone
- Self-flange trim ring sized to hide gaps caused by construction tolerances



6146WH
White Reflector,
White Self-flange



6146SN
Satin Nickel Reflector,
Satin Nickel Self-flange



6146TBZ
Tuscan Bronze Reflector,
Tuscan Bronze Self-flange

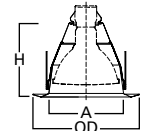

Dimensions**
A: 5-3/8" [137mm]
H: 5-3/8" [138mm]
OD: 7-3/4" [197mm]

Housings Max Lamp Compatibility

H7ICT	H7ICAT	6146WH: 75W PAR30S, 75W PAR30L, 65W PAR38 6146SN, 6146TBZ:
H7RICT	H7RICAT	

E7ICAT	E7RICAT	60W PAR30S, 75W PAR30L, 65W PAR38
--------	---------	--------------------------------------

Compatible with Halogen, Incandescent, LED* or CFL* lamps

**Outdoor
Rated Lamp
ONLY**
(Purchase Separately)



Lamp Gasket
(Included)

*UL1993 listed LED & CFL equivalent lamps permitted. Consult lamp manufacturer for conditions of use. Eaton does not warranty the lamp.

**Key: A: Luminous Aperture, H: Height, OD: Trim Outside Diameter



6150 Low Profile, Frosted Glass Dome Lens, Self-flange

- Low profile, frosted glass dome lens
- Wet location Showerlight
- Torsion spring retention
- Non-conductive "dead-front" polymer (plastic) trim ring and glass lens
- Socket supporting internal reflector
- Self-flange trim ring sized to hide gaps caused by construction tolerances



6150WH
Frosted Glass Dome Lens with Reflector, White Plastic Self-flange



6150SN
Frosted Glass Dome Lens with Reflector, Satin Nickel Plastic Self-flange



6150TBZ
Frosted Glass Dome Lens with Reflector, Tuscan Bronze Plastic Self-flange

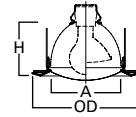

Dimensions**
A: 5-1/8" [130mm]
H: 4-1/5" [107mm]
OD: 7-3/4" [197mm]

Housings Max Lamp Compatibility

H7ICT	H7ICAT	
H7RICT	H7RICAT	29W A19, 39W PAR30S
E7ICAT	E7RICAT	

Compatible with Halogen, Incandescent, LED* or CFL* lamps

6162 Drop Opal Plastic Lens, Self-flange

- Wet location Showerlight
- Non-conductive "dead-front" polymer (plastic) trim and plastic lens
- Torsion spring retention
- Socket supporting internal reflector
- Self-flange trim ring sized to hide gaps caused by construction tolerances



6162WH
Drop Opal Plastic Lens with Reflector, Frosted Plastic Self-flange

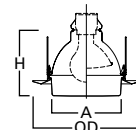

Dimensions**
A: 5-1/8" [130mm]
H: 4-3/4" [122mm]
OD: 7-3/4" [197mm]

Housings Max Lamp Compatibility

H7ICT	H7ICAT	
H7RICT	H7RICAT	29W A19
E7ICAT	E7RICAT	

Compatible with Halogen, Incandescent, LED* or CFL* lamps



6230 Squirrel Frost Glass Lens, Metal Trim, Self-flange

- Low profile frost glass lens
- Wet location Showerlight
- Torsion spring retention
- Self-flange low profile metal trim ring
- Socket supporting internal bracket
- Integral rotation adjustment up to +/- 25° for precise alignment with room



6230AH
Frost Glass Lens, Aluminum Haze Squirrel Trim



6230PN
Frost Glass Lens, Polished Nickel Squirrel Trim



6230SN
Frost Glass Lens, Satin Nickel Squirrel Trim

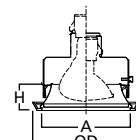

Dimensions**
A: 6" [152mm]
H: 4-1/4" [109mm]
D: 3/4" [20mm]
OD: 7-1/4" [185mm]

Housings Max Lamp Compatibility

H7ICT	H7ICAT	
H7RICT	H7RICAT	29W A19, 39W PAR30S
E7ICAT	E7RICAT	

Compatible with Halogen, Incandescent, LED* or CFL* lamps



6255 Soft Square, Frost Curved Glass Lens, Self-flange

- Low profile curved frost glass lens
- Wet location Showerlight
- Torsion spring retention
- Integral adjustment up to 90° for precise alignment to room
- Non-conductive "dead-front" polymer (plastic) trim ring and glass lens
- Integral rotation adjustment up to +/-25° for precise alignment with room
- Integrated socket supporting reflector for even illumination across lens corner-to-corner



6255WH
Frost Curved Glass Lens with Reflector, White Plastic Self-flange



6255SN
Frost Curved Glass Lens with Reflector, Satin Nickel Plastic Self-flange



6255TBZ
Frost Curved Glass Lens with Reflector, Tuscan Bronze Plastic Self-flange

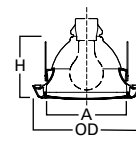

Dimensions**
A: 5-7/8" [149mm]
D: 1" [25mm]
H: 4-1/2" [114mm]
OD: 7-5/8" [194mm]

Housings Max Lamp Compatibility

H7ICT	H7ICAT	
H7RICT	H7RICAT	29W A19, 39W PAR30S
E7ICAT	E7RICAT	

Compatible with Halogen, Incandescent, LED* or CFL* lamps



*UL1993 listed LED & CFL equivalent lamps permitted. Consult lamp manufacturer for conditions of use. Eaton does not warranty the lamp.

**Key: A: Luminous Aperture, H: Height, OD: Trim Outside Diameter

E26 Screw Base Trims

IC Housings: H7ICT • H7ICAT • H7RICT • H7RICAT • E7ICAT • E7RICAT

6
INCH

Open, Splay & Wall Wash

300 Open Trim with Fixed Socket Bracket

- Open trim for BR30 and PAR30 lamps
- Torsion spring retention
- Socket supporting internal bracket

Housings		Max Lamp Compatibility
H7ICT	H7ICAT	75W PAR30S, 75W PAR30L
H7RICT	H7RICAT	65W BR30
E7ICAT		300P: 75W PAR30S, 75W PAR30L, 65W BR30
E7RICAT		300SN, 300TBZ: 60W PAR30S, 60W PAR30L, 50W BR30

Compatible with Halogen, Incandescent, LED* or CFL* lamps



300P
Socket Bracket with
White Open Trim



300SN
Socket Bracket with
Satin Nickel Open Trim



300TBZ
Socket Bracket with
Tuscan Bronze Open Trim

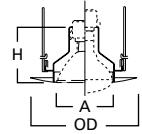

Dimensions**
A: 4-3/4" [122mm]
H: 4-3/4" [122mm]
OD: 7-1/4" [184mm]

327 White Splay Trim with Fixed Socket Bracket

- Splay trim for BR30 and PAR30 lamps
- Torsion spring retention
- Socket supporting internal bracket

Housings		Max Lamp Compatibility
H7ICT	H7ICAT	75W PAR30S, 75W PAR30L,
H7RICT	H7RICAT	65W BR30
E7ICAT	E7RICAT	

Compatible with Halogen, Incandescent, LED* or CFL* lamps



327P
White Splay Trim
with Socket Bracket

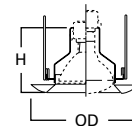

Dimensions**
H: 4-1/2" [114mm]
OD: 7-3/4" [197mm]

328 White Splay Trim

- Splay trim for BR30 and PAR30 lamps
- Coil spring retention

Housings		Max Lamp Compatibility
H7ICT	H7ICAT	50W PAR30S, 75W PAR30L
H7RICT	H7RICAT	65W BR30, 75W R30
E7ICAT	E7RICAT	50W PAR30S, 75W PAR30L, 65W BR30

Compatible with Halogen, Incandescent, LED* or CFL* lamps



328P
White Splay Trim

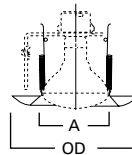

Dimensions**
H: 3-7/8" [98mm]
OD: 7-3/4" [197mm]

430 Wall Wash with Baffle & Full Reflector

- Black or white step baffle with full reflector
- Designed to spread light close to the ceiling to eliminate the "cave effect"
- Torsion spring retention
- Makes installation Air-Tite regardless of housing used

Housings		Max Lamp Compatibility
H7ICT	H7ICAT	40W A19
H7RICT	H7RICAT	
E7ICAT	E7RICAT	29W A19

Compatible with Halogen, Incandescent, LED* or CFL* lamps



430W
White Baffle, White Trim



430P
Black Baffle, White Trim

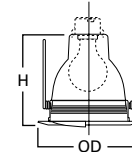

Dimensions**
H: 5" [127mm]
OD: 7-1/4" [184mm]



*UL1993 listed LED & CFL equivalent lamps permitted. Consult lamp manufacturer for conditions of use. Eaton does not warranty the lamp.

**Key: A: Luminous Aperture, H: Height, OD: Trim Outside Diameter

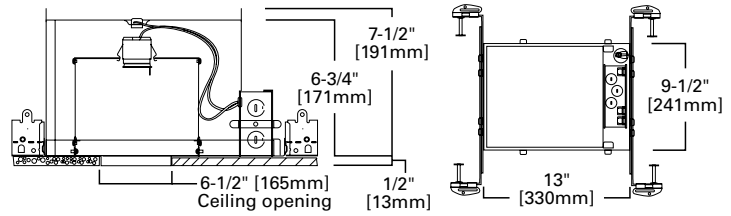

H7UICAT

6" IC, Air-Tite, New Construction Universal Housing, 120V

The H7UICAT universal housing is designed to support the use of higher wattage lamps than single wall housings (depending upon the trim). The H7 recessed housing is the standard in the industry for both light commercial and residential applications. H7 series features full-frame design, robust construction, feed-through listing, and Got Nail! bar hangers. A wide variety of trims allows a number of different lighting effects to be created with one basic housing. H7UICAT is for installations where the housing will be in direct contact with insulation,* and its Air-Tite design will also meet restricted air flow code requirements. May be retrofit with compatible Halo LED lighting systems.



Special Features

- Got Nail!™ bar hangers
- Pass-N-Thru™ bars
- Slide-N-Side™ junction box
- Quick Connect™ push wire nuts
- Air-Tite™ code compliant

Compatible Trims

30	171	378	4041	6109	6150
70	172	404	4261	6120	6160
71	173	419	6100	6121	6162
73	300	420	6101	6125	6215
74	310	424	6102	6126	6222
76	328	425	6103	6130	6230
78	353	426	6106	6145	6255
79	376	429	6107	6146	30SBAT
170		430	6108		

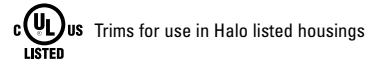

Features

Housing

- Double wall aluminum construction for greater heat dissipation, and support of higher wattage lamps
- The inner housing can be removed from plaster frame for junction box access
- Pre-installed Air-Tite ready ceiling contact gasket
- Designed for insulated ceilings in direct contact with insulation* (May also be installed in non-insulated ceilings)
- Sealed and gasketed for Air-Tite ready installation

Socket Plate

- Fixed socket position maintains consistent lamp position
- The socket can be detached from the inner housing for use with socket supporting trims

Plaster Frame

Housing adjusts in plaster frame 1-3/8" to accommodate different ceiling thicknesses. Galvanized steel construction. Plaster frame features include:

- Regressed locking screw for securing hanger bars
- Cutouts for easily crimping hanger bars in position
- Halo name embossed on plaster frame

Includes:

- Got Nail!™ bar hangers (Details Pg. 13)
- Pass-N-Thru™ bars (Details Pg. 7)
- Slide-N-Side™ junction box wire traps (Details Pg. 13)
- Quick Connect™ push wire nuts (Details Pg. 13)
- Air-Tite™ code compliant (Details Pg. 13)

Socket

- Porcelain socket with nickel plated brass screw shell
- Snap-in springs secure socket to socket plate, and may be detached when using socket supporting trims
- Overspray protector included

Thermal Protector

Self resetting thermal protector deactivates fixture if overheating occurs due to improper lamping or misapplied insulation

Trims

Halo Fit-All concept offers multiple trim options in a variety of design styles, and functional beam distributions to control beam angle and lumen delivery in accommodating various lamp types including Halogen, CFL and LED

Compliance

- cULus Listed 1598 luminaire
- cULus Listed damp location
- cULus Listed for wet location, covered ceiling, with select trims
- cULus Listed for feed through
- cULus Listed for direct contact with insulation and combustible material*
- Air-Tite code compliant. Certified under ASTM E283; not exceeding 2.0 cfm (0.944 L/s) air leakage rate tested at a 1.57 psf (75 Pa) pressure differential.
- RoHS compliant

*Not to be used in direct contact with spray foam insulation (Consult NEMA LSD57-2013)

E26 Screw Base Trims

IC Housing: H7UICAT

6
INCH

Reflectors



30 Reflector, Self-flange

- Self-flange reflector with torsion spring retention
- Accepts a wide range of lamps
- Makes installation Air-Tite regardless of housing used
- Socket supporting reflector

Housing	Max Lamp Compatibility
H7UICAT	100W A19, 75W PAR30S, 75W PAR30L, 100W PAR38, 85W BR30, 100W R30

Compatible with Halogen, Incandescent, LED* or CFL* lamps



30HAT
Haze Reflector, White Trim



30RGAT
Residential Gold Reflector,
White Trim



30CAT
Clear Specular Reflector,
White Trim

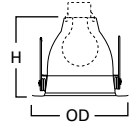

Dimensions**
H: 5" [127mm]
OD: 7-1/4" [184mm]

30SBAT Reflector, Self-flange

- Self-flange reflector with torsion spring retention
- Accepts a wide range of lamps
- Makes installation Air-Tite regardless of housing used
- Socket supporting reflector

Housing	Max Lamp Compatibility
H7UICAT	60W A19, 75W PAR30S, 75W PAR30L, 75W PAR38, 85W BR30, 100W R30

Compatible with Halogen, Incandescent, LED* or CFL* lamps



30SBAT
Specular Black Reflector & Trim

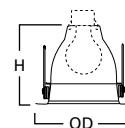

Dimensions**
H: 5" [127mm]
OD: 7-1/4" [184mm]

404 Specular Reflector

- Full reflector for use with A-lamps
- Friction clip retention on housing plaster ring
- Removable trim ring
- Accessories available: TRM6 designer trim rings, OT403 oversize trim ring
- Socket supporting reflector

Housing	Max Lamp Compatibility
H7UICAT	100W A19

Compatible with Halogen, Incandescent, LED* or CFL* lamps



404C
Clear Reflector, White Trim



404H
Haze Reflector, White Trim



404SN
Satin Nickel Reflector,
Satin Nickel Trim



404TBZ
Tuscan Bronze Reflector,
Tuscan Bronze Trim



Friction Clips install on housing plaster ring

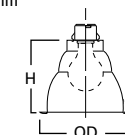

Dimensions**
H: 5" [127mm]
OD: 7-1/4" [184mm]

426 Reflector Cone

- Accepts a wide variety of lamps
- Coil spring retention
- Removable trim ring
- Accessories available: TRM6 designer trim rings, OT403 oversize trim ring

Housing	Max Lamp Compatibility
H7UICAT	75W PAR30S, 75W PAR30L, 100W PAR38, 85W BR30, 100W R30, 100W R40

Compatible with Halogen, Incandescent, LED* or CFL* lamps



426
Clear Specular Reflector
Cone, White Trim



426MB
Black Specular Reflector
Cone, White Trim



426H
Haze Reflector Cone,
White Trim



426SN
Satin Nickel Reflector
Cone, Satin Nickel Trim



426TBZ
Tuscan Bronze Reflector
Cone, Tuscan Bronze Trim

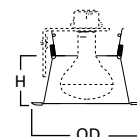

Dimensions**
H: 2-5/8" [67mm]
OD: 7-1/4" [184mm]

*UL1993 listed LED & CFL equivalent lamps permitted. Consult lamp manufacturer for conditions of use. Eaton does not warranty the lamp.

**Key: A: Luminous Aperture, H: Height, OD: Trim Outside Diameter

429 Dayform White Cone, Self-flange

- Contoured sides shield interior view of housing
- Removable trim ring
- Accessories available: TRM6 designer trim rings, OT403 oversize trim ring



429P
White Reflector, White Self-flange

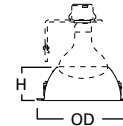

Dimensions**
H: 3" [76mm]
OD: 7-1/4" [184mm]

Housing Max Lamp Compatibility

H7UICAT	75W PAR30S, 75W PAR30L, 90W PAR38, 65W BR30, 90W BR40, 75W R30, 100W R40
---------	--

Compatible with Halogen, Incandescent, LED* or CFL* lamps

4041 White Reflector, Self-flange

- Self-flange reflector for use with A-lamps
- Friction clip retention on housing plaster ring
- Accessories available: OT403 oversize trim ring
- Socket supporting reflector



4041P
White Reflector, White Self-flange



Friction Clips install on housing plaster ring

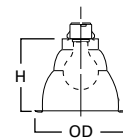

Dimensions**
H: 5-1/4" [133mm]
OD: 7-1/4" [184mm]

Housing Max Lamp Compatibility

H7UICAT	100W A19
---------	----------

Compatible with Halogen, Incandescent, LED* or CFL* lamps

4261 White Reflector Cone, Self-flange

- Self-flange reflector cone for use with R and PAR lamps
- Coil spring retention



4261P
White Reflector, White Self-flange

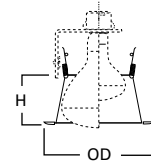

Dimensions**
H: 2-5/8" [67mm]
OD: 7-1/4" [184mm]

Housing Max Lamp Compatibility

H7UICAT	75W PAR30S, 75W PAR30L, 100W PAR38, 85W BR30, 90W BR40, 100W R30, 100W R40
---------	--

Compatible with Halogen, Incandescent, LED* or CFL* lamps

6106 Straight Reflector Cone, Self-flange

- Straight sides of cone reflector for large diameter BR40 and PAR38, as well as BR30 and PAR30 lamps
- Self-flange reflector cone
- Coil spring retention
- Slightly oversized ring expands coverage of ceiling gaps and cut-out errors



6106SC
Specular Clear Reflector,
White Self-flange

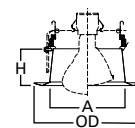

Dimensions**
A: 5-3/8" [137mm]
H: 2-5/8" [68mm]
OD: 7-3/4" [197mm]

Housing Max Lamp Compatibility

H7UICAT	75W PAR30S, 75W PAR30L, 90W PAR38, 65W BR30, 90W BR40
---------	--

Compatible with Halogen, Incandescent, LED* or CFL* lamps

6107 Tapered Reflector, Self-flange

- Self-flange reflector cone
- Contoured tapered sides of cone reflector for BR30 and PAR30 lamps
- Coil spring retention
- Self-flange trim ring sized to hide gaps caused by construction tolerances



6107SC
Specular Clear Reflector,
White Self-flange

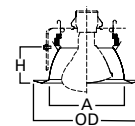

Dimensions**
A: 5-3/8" [137mm]
H: 2-5/8" [65mm]
OD: 7-3/4" [197mm]

Housing Max Lamp Compatibility

H7UICAT	75W PAR30S, 75W PAR30L, 65W BR30
---------	----------------------------------

Compatible with Halogen, Incandescent, LED* or CFL* lamps

*UL1993 listed LED & CFL equivalent lamps permitted. Consult lamp manufacturer for conditions of use. Eaton does not warranty the lamp.

**Key: A: Luminous Aperture, H: Height, OD: Trim Outside Diameter

E26 Screw Base Trims

IC Housing: H7UICAT

6
INCH



6120 Full Cone Reflector, Self-flange

- Full cone reflector
- Torsion spring retention
- Socket supporting reflector
- Self-flange trim ring sized to hide gaps caused by construction tolerances
- Makes installation Air-Tite regardless of housing used



6120WH
White Reflector, White Self-flange



6120SN
Satin Nickel Reflector, Satin Nickel Self-flange



6120TBZ
Tuscan Bronze Reflector, Tuscan Bronze Self-flange

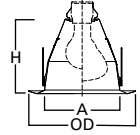

Dimensions**
A: 5-3/8" [137mm]
H: 5-3/8" [138mm]
OD: 7-3/4" [197mm]

Housing Max Lamp Compatibility

H7UICAT	72W A19, 75W PAR30S, 75W PAR30L, 85W BR30, 90W PAR38, 90W BR40
---------	--

Compatible with Halogen, Incandescent, LED* or CFL* lamps

6121 Shallow Full Cone Reflector, Self-flange

- Shallow full cone reflector
- Torsion spring retention
- Self-flange trim ring sized to hide gaps caused by construction tolerances



6121WH
White Reflector, White Self-flange

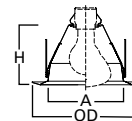

Dimensions**
A: 5-3/8" [137mm]
H: 4-3/8" [110mm]
OD: 7-3/4" [197mm]

Housing Max Lamp Compatibility

H7UICAT	72W A19, 75W PAR30S, 75W PAR30L, 85W BR30
---------	---

Compatible with Halogen, Incandescent, LED* or CFL* lamps

Baffles

30 Baffle, Self-flange

- Self-flange metal baffle, with upper reflector
- Socket supporting baffle
- Torsion spring retention
- Accepts a wide range of lamps
- Makes installation Air-Tite regardless of housing used



30WAT
White Baffle & Reflector, White Trim



30WATH
White Baffle & Clear Reflector, White Trim



30PAT
Black Baffle & Clear Reflector, White Trim



30SNAT
Satin Nickel Baffle & Reflector, Satin Nickel Trim



30TBZAT
Tuscan Bronze Baffle & Reflector, Tuscan Bronze Trim

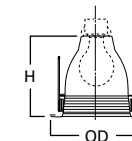

Dimensions**
H: 5" [127mm]
OD: 7-1/4" [184mm]

Housing Max Lamp Compatibility

H7UICAT	75W A19, 75W PAR30S, 75W PAR30L, 100W PAR38, 85W BR30, 100W R30
---------	---

Compatible with Halogen, Incandescent, LED* or CFL* lamps

310 Coilex® Baffle

- Black or white phenolic Coilex baffle with white metal trim ring
- Removable trim ring
- Accessories available: TRM6 designer trim rings, OT403 oversize trim ring
- Coil spring retention



310W
White Coilex Baffle, White Trim



310P
Black Coilex Baffle, White Trim



310SN
Satin Nickel Coilex Baffle, Satin Nickel Trim



310TBZ
Tuscan Bronze Coilex Baffle, Tuscan Bronze Trim

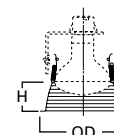

Dimensions**
H: 3-1/16" [78mm]
OD: 7-1/4" [184mm]

Housing Max Lamp Compatibility

H7UICAT	75W PAR30S, 75W PAR30L, 90W PAR38, 65W BR30, 90W BR40, 75W R30, 100W R40
---------	--

Compatible with Halogen, Incandescent, LED* or CFL* lamps

*UL1993 listed LED & CFL equivalent lamps permitted. Consult lamp manufacturer for conditions of use. Eaton does not warranty the lamp.

**Key: A: Luminous Aperture, H: Height, OD: Trim Outside Diameter

353 Metal Baffle

- Metallic finish trim rings and baffles
- Coil spring retention
- Removable trim ring

Housing Max Lamp Compatibility

H7UICAT	75W PAR30S, 75W PAR30L, 90W PAR38, 65W BR30, 90W BR40, 75W R30, 100W R40
---------	--

Compatible with Halogen, Incandescent, LED* or CFL* lamps



353SN
Satin Nickel Baffle,
Satin Nickel Trim

353TBZ
Tuscan Bronze Baffle,
Tuscan Bronze Trim

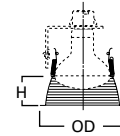

Dimensions**
H: 3" [76mm]
OD: 7-1/4" [184mm]

6100 Tapered Metal Baffle with (2) Trim Rings

- Contoured tapered sides of metal baffle for BR30 and PAR30 lamps
- Two plastic removable trim rings included narrow 7.25" OD and wide oversized 8.00" OD
- Coil spring retention

Housing Max Lamp Compatibility

H7UICAT	75W PAR30S, 75W PAR30L, 65W BR30, 90W BR40
---------	---

Compatible with Halogen, Incandescent, LED* or CFL* lamps



6100WB
White Baffle, Narrow & Wide
White Trims (Included)

6100BB
Black Baffle, Narrow & Wide
White Trims (Included)

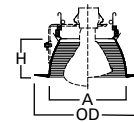

Dimensions**
A: 5-3/4" [148mm]
H: 2-7/8" [74mm]
OD: 7-1/4" [184mm] Narrow
OD: 8" [203mm] Wide

6101 Straight Metal Baffle with (2) Trim Rings

- Straight sides of metal baffle for large diameter lamps
- Two plastic removable trim rings included narrow 7.25" OD and wide 8.00" OD
- Coil spring retention

Housing Max Lamp Compatibility

H7UICAT	75W PAR30S, 75W PAR30L, 90W PAR38, 65W BR30, 90W BR40
---------	--

Compatible with Halogen, Incandescent, LED* or CFL* lamps



6101WB
White Baffle, Narrow & Wide
White Trim (Included)

6101BB
Black Baffle, Narrow & Wide
White Trim (Included)

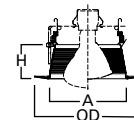

Dimensions**
A: 5-5/8" [144mm]
H: 2-5/8" [66mm]
OD: 7-1/8" [184mm] Narrow
OD: 8" [203mm] Wide

6102 Tapered Metal Baffle, Self-flange

- Contoured tapered sides of metal baffle
- Coil spring retention
- Self-flange trim ring sized to hide gaps caused by construction tolerances

Housing Max Lamp Compatibility

H7UICAT	75W PAR30S, 75W PAR30L, 65W BR30, 90W BR40
---------	---

Compatible with Halogen, Incandescent, LED* or CFL* lamps



6102WB
White Baffle, White Self-flange

6102BB
Black Baffle, White Self-flange

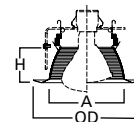

Dimensions**
A: 5-3/8" [137mm]
H: 2-5/8" [65mm]
OD: 7-3/4" [197mm]

*UL1993 listed LED & CFL equivalent lamps permitted. Consult lamp manufacturer for conditions of use. Eaton does not warranty the lamp.

**Key: A: Luminous Aperture, H: Height, OD: Trim Outside Diameter

E26 Screw Base Trims

IC Housing: H7UICAT

6
INCH

6103 Straight Metal Baffle, Self-flange

- Straight sides of metal baffle for large diameter lamps
- Coil spring retention
- Self-flange trim ring sized to hide gaps caused by construction tolerances



6103WB White Baffle, White Self-flange
6103BB Black Baffle, White Self-flange

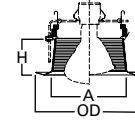

Dimensions**
A: 5-3/8" [137mm]
H: 2-5/8" [68mm]
OD: 7-3/4" [197mm]

Housing Max Lamp Compatibility

H7UICAT 75W PAR30S, 75W PAR30L,
90W PAR38, 65W BR30, 90W BR40

Compatible with Halogen, Incandescent, LED* or CFL* lamps

6108 Coilex® Straight Plastic Baffle, Self-flange

- Straight sides of Coilex baffle for large diameter BR30 and PAR30 lamps
- Coil spring retention
- Self-flange trim ring sized to hide gaps caused by construction tolerances



6108WB White Plastic Straight Coilex Baffle, White Self-flange
6108BB Black Plastic Straight Coilex Baffle, White Self-flange
6108BKBB Black Plastic Straight Coilex Baffle, Black Self-flange

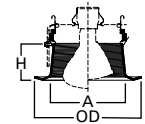

Dimensions**
A: 5-3/8" [137mm]
H: 2-5/8" [68mm]
OD: 7-3/4" [197mm]

Housing Max Lamp Compatibility

H7UICAT 60W PAR30S, 75W PAR30L,
90W PAR38, 65W BR30, 70W BR40

Compatible with Halogen, Incandescent, LED* or CFL* lamps

6109 Coilex® Tapered Baffle, Self-flange

- Contoured tapered sides of Coilex baffle for BR30 and PAR30 lamps
- Coil spring retention
- Self-flange trim ring sized to hide gaps caused by construction tolerances



6109WB White Plastic Tapered Coilex Baffle, White Self-flange
6109BB Black Plastic Tapered Coilex Baffle, White Self-flange
6109BKBB Black Plastic Tapered Coilex Baffle, Black Self-flange

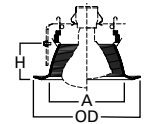

Dimensions**
A: 5-3/8" [137mm]
H: 2-5/8" [65mm]
OD: 7-3/4" [197mm]

Housing Max Lamp Compatibility

H7UICAT 50W PAR30S, 75W PAR30L,
45W PAR38, 65W BR30, 85W BR40

Compatible with Halogen, Incandescent, LED* or CFL* lamps

6125 Full Cone Baffle, Self-flange

- Full cone baffle
- Torsion spring retention
- Socket supporting baffle
- Self-flange trim ring sized to hide gaps caused by construction tolerances



6125WB White Baffle, White Self-flange
6125BB Black Baffle, White Self-flange
6125BKBB Black Baffle, Black Self-flange

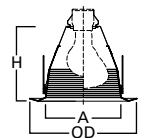

Dimensions**
A: 5-3/8" [137mm]
H: 5-3/8" [138mm]
OD: 7-3/4" [197mm]

Housing Max Lamp Compatibility

H7UICAT 72W A19, 75W PAR30S, 75W PAR30L,
85W BR30, 90W PAR38, 90W BR40

Compatible with Halogen, Incandescent, LED* or CFL* lamps

*UL1993 listed LED & CFL equivalent lamps permitted. Consult lamp manufacturer for conditions of use. Eaton does not warranty the lamp.

**Key: A: Luminous Aperture, H: Height, OD: Trim Outside Diameter



6126 Shallow Full Cone Baffle, Self-flange

- Shallow full cone baffle for A19 and PAR30 lamps
- Torsion spring retention
- Socket supporting baffle
- Self-flange trim ring sized to hide gaps caused by construction tolerances



6126WB White Baffle, White Self-flange
6126BB Black Baffle, White Self-flange

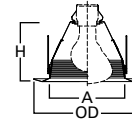

Dimensions**
A: 5-3/8" [137mm]
H: 4-3/8" [110mm]
OD: 7-3/4" [197mm]

Housing Max Lamp Compatibility

H7UICAT 72W A19, 75W PAR30S,
75W PAR30L, 85W BR30

Compatible with Halogen, Incandescent, LED* or CFL* lamps

Adjustable – Eyeballs & Gimbals

74 Eyeball 30° Tilt, Self-flange

- Provides optimum position for PAR30S lamps
- Torsion spring retention
- Socket supporting eyeball



74P
White Eyeball, White Trim

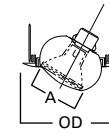

Dimensions**
A: 3-7/8" [98mm]
OD: 8" [203mm]

Housing Max Lamp Compatibility

H7UICAT 75W PAR30

Compatible with Halogen, Incandescent, LED* or CFL* lamps

76 Gimbal 30° Tilt, Self-flange

- For use with PAR38 lamps
- 30° tilt
- Torsion spring retention



76P
White Gimbal, White Trim

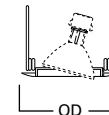

Dimensions**
OD: 8" [203mm]

Housing Max Lamp Compatibility

H7UICAT 45W PAR38
(Side prong lamp recommended)

Compatible with Halogen, Incandescent, LED* or CFL* lamps

78 Eyeball 30° Tilt, Self-flange

- 30° tilt, 360° rotation
- Torsion spring retention
- Wide choice of finishes for any decor
- Socket supporting eyeball
- 78PAT makes installation Air-Tite regardless of housing used



78P
White Eyeball, White Trim



78PAT
White Eyeball, White Trim



78SN
Satin Nickel Eyeball,
Satin Nickel Trim



78TBZ
Tuscan Bronze Eyeball,
Tuscan Bronze Trim

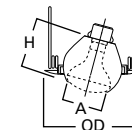

Dimensions**
A: 4" [100mm]
H: 4-1/8" [105mm]
OD: 8" [203mm]

Housing Max Lamp Compatibility

H7UICAT 75W PAR30S, 75W PAR30L,
85W BR30, 100W R30

Compatible with Halogen, Incandescent, LED* or CFL* lamps

376 Regressed Gimbal 30° Tilt, Self-flange

- 30° tilt
- Regressed gimbal with baffle
- Torsion spring retention
- Socket supporting gimbal



376W
White Baffle, White Trim



376P
Black Baffle, White Trim

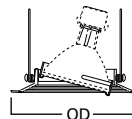

Dimensions**
OD: 7-1/4" [184mm]

Housing Max Lamp Compatibility

H7UICAT 75W PAR30

Compatible with Halogen, Incandescent, LED* or CFL* lamps

*UL1993 listed LED & CFL equivalent lamps permitted. Consult lamp manufacturer for conditions of use. Eaton does not warranty the lamp.

**Key: A: Luminous Aperture, H: Height, OD: Trim Outside Diameter

E26 Screw Base Trims

IC Housing: H7UICAT

6
INCH

378 Regressed Gimbal with Splay 25° Tilt, Self-flange

- 25° tilt
- Regressed gimbal with splay trim
- Removable trim ring
- Accessories available: TRM6 designer trim rings, OT403 oversize trim ring
- Friction clips on trim
- Socket supporting gimbal



378P
White Splay, White Trim



378
Specular Clear Splay, White Trim

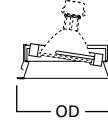

Dimensions**
OD: 7-1/4" [184mm]



Friction Clips on Trim

Housing Max Lamp Compatibility

H7UICAT 75W PAR30

Compatible with Halogen, Incandescent, LED* or CFL* lamps

419 Regressed Eyeball with Splay 25° Tilt

- Regressed eyeball for use with splay
- 25° Tilt, 358° rotation
- Accessories available: TRM6 designer trim rings, OT403 oversize trim ring
- Removable trim ring
- Socket supporting trim



419P
White Eyeball & Splay, White Trim

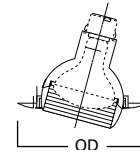

Dimensions**
OD: 7-1/4" [184mm]

Housing Max Lamp Compatibility

H7UICAT 75W PAR30

Compatible with Halogen, Incandescent, LED* or CFL* lamps

420 Regressed Eyeball 30° Tilt, Self-flange

- Regressed eyeball with baffle
- Removable trim ring
- Accessories available: TRM6 designer trim rings, OT403 oversize trim ring
- Socket supporting eyeball



420W
White Eyeball & Baffle,
White Trim



420P
White Eyeball & Black Baffle,
White Trim

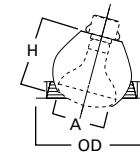

Dimensions**
A: 4" [100mm]
H: 4" [102mm]
OD: 7-1/4" [184mm]

Housing Max Lamp Compatibility

H7UICAT 75W PAR30S, 75W PAR30L, 65W BR30

Compatible with Halogen, Incandescent, LED* or CFL* lamps

6130 Eyeball 35° Tilt, Self-flange

- 35° tilt, 360° rotation
- Adjustable eyeball trim for BR30 and PAR30 lamps
- Torsion spring retention
- Socket supporting eyeball
- Self-flange trim ring sized to hide gaps caused by construction tolerances



6130WH
White Eyeball, White Self-flange

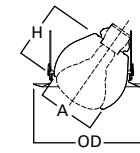

Dimensions**
A: 3-3/8" [100mm]
H: 3-7/8" [100mm]
OD: 7-3/4" [197mm]

Housing Max Lamp Compatibility

H7UICAT 75W PAR30S, 75W PAR30L, 65W BR30

Compatible with Halogen, Incandescent, LED* or CFL* lamps

6215 Double Gimbal 30°-50° Tilt, Self-flange

- 30°-50° tilt, 360° rotation
- 50° tilt with double gimbal design using compound angles
- Double gimbal for PAR30 lamps
- Torsion spring retention
- Shallow housings are compatible with PAR30 short-neck lamps
- Socket supporting gimbal
- Self-flange trim ring sized to hide gaps caused by construction tolerances



6215WH
White Gimbal,
White Self-flange



6215BK
Black Gimbal,
Black Self-flange



6215SN
Satin Nickel Gimbal,
Satin Nickel Self-flange



6215TBZ
Tuscan Bronze Gimbal,
Tuscan Bronze Self-flange

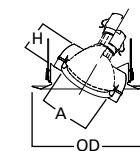

Dimensions**
A: 3-3/8" [84mm]
H: 2" [51mm]
OD: 7-3/4" [197mm]

Housing Max Lamp Compatibility

H7UICAT 75W PAR30S, 75W PAR30L

Compatible with Halogen, Incandescent, LED* or CFL* lamps

*UL1993 listed LED & CFL equivalent lamps permitted. Consult lamp manufacturer for conditions of use. Eaton does not warranty the lamp.

**Key: A: Luminous Aperture, H: Height, OD: Trim Outside Diameter

Specifications, compliances and dimensions subject to change without notice

6222 Regressed Angle Cut Adjustable Gimbal, 45° Tilt, Self-flange

- 45° tilt, 360° rotation
- Fully regressed gimbal – self-flange ring
- Torsion spring retention
- Socket supporting gimbal
- Reflector and baffle options
- Accommodates tilt of gimbal in a full regressed cut cone
- Self-flange trim ring sized to hide gaps caused by construction tolerances



6222WB
White Baffle,
White Trim



6222BB
Black Baffle,
White Trim



6222SC
Specular Clear Reflector
White Trim



6222H
Haze Reflector,
White Trim

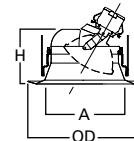

Dimensions**
A: 3-3/4" [95mm]
H: 5-3/8" [137mm]
OD: 7-3/4" [197mm]

Housing Max Lamp Compatibility

H7UICAT 60W PAR30S, 75W PAR30L

Compatible with Halogen, Incandescent, LED* or CFL* lamps

Lenses & Wet Location Showerlights

70 Albalite Glass Lens

- White trim, glass Albalite lens
- PS version features "dead-front" construction and is wet location listed for use in showers
- PS version features non-conductive, non-corrosive polymer (plastic) trim ring
- Torsion spring retention



70P
Albalite Glass Lens,
White Trim



70PS
Albalite Glass Lens,
White Polymer Trim,
Wet Location

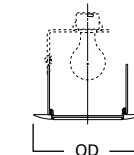

Dimensions**
OD: 8" [203mm]

Housing Max Lamp Compatibility

H7UICAT 40W A19

Compatible with Halogen, Incandescent, LED* or CFL* lamps

71 Drop Opal Glass Lens

- White trim, drop opal glass lens
- PS version features "dead-front" construction and is wet location listed for use in showers
- PS version features non-conductive, non-corrosive polymer (plastic) trim ring
- Torsion spring retention



71P
Drop Opal Glass Lens,
White Trim



71PS
Drop Opal Glass Lens,
White Polymer Trim,
Wet Location

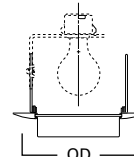

Dimensions**
OD: 8" [203mm]

Housing Max Lamp Compatibility

H7UICAT 40W A19

Compatible with Halogen, Incandescent, LED* or CFL* lamps

73 Fresnel Glass Lens

- White trim with glass Fresnel lens
- PS version features "dead-front" construction and is wet location listed for use in showers
- PS version features non-conductive, non-corrosive polymer (plastic) trim ring
- Torsion spring retention



73P
Fresnel Glass Lens,
White Trim



73PS
Fresnel Glass Lens,
White Polymer Trim,
Wet Location

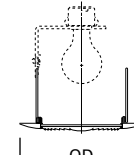

Dimensions**
OD: 8" [203mm]

Housing Max Lamp Compatibility

H7UICAT 40W A19

Compatible with Halogen, Incandescent, LED* or CFL* lamps

*UL1993 listed LED & CFL equivalent lamps permitted. Consult lamp manufacturer for conditions of use. Eaton does not warranty the lamp.

**Key: A: Luminous Aperture, H: Height, OD: Trim Outside Diameter

E26 Screw Base Trims

IC Housing: H7UICAT

6
INCH

170 Albalite Lens with Reflector

- White trim with Albalite glass lens
- PS version features non-conductive, non-corrosive gasketed polymer (plastic) trim ring
- PS version is "dead-front" construction and is wet location listed for use in showers
- Torsion spring retention
- PS version is Air-Tite; making any installation Air-Tite



170P
Albalite Lens, White Trim



170PS
Albalite Lens, Polymer White Trim

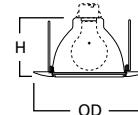

Dimensions**
H: 4" [102mm]
OD: 8" [203mm]

Housing Max Lamp Compatibility

H7UICAT 40W A19

Compatible with Halogen, Incandescent, LED* or CFL* lamps

171 Drop Opal Glass Lens with Reflector

- White trim with drop opal glass lens
- PS version features non-conductive, non-corrosive gasketed polymer (plastic) trim ring
- PS version is "dead-front" construction and is wet location listed for use in showers
- Torsion spring retention
- PS version is Air-Tite; making any installation Air-Tite



171P
Drop Opal Lens, White Trim



171PS
Drop Opal Lens, White Polymer Trim

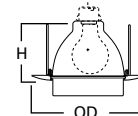
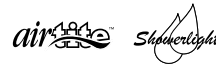

Dimensions**
H: 4" [102mm]
OD: 8" [203mm]

Housing Max Lamp Compatibility

H7UICAT 60W A19

Compatible with Halogen, Incandescent, LED* or CFL* lamps

172 Dome Glass Lens with Reflector

- Frosted glass dome
- Wet location listed for use in showers
- Non-conductive, non-corrosive gasketed polymer (plastic) trim ring
- Torsion spring retention
- Air-Tite trim makes any installation Air-Tite



172PS
Frosted Glass Dome,
White Polymer Trim



172TBZS
Frosted Glass Dome,
Tuscan Bronze Polymer Trim

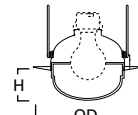

Dimensions**
H: 2-1/8" [54mm]
OD: 7-3/4" [197mm]

Housing Max Lamp Compatibility

H7UICAT 75W A19, 75W PAR30

Compatible with Halogen, Incandescent, LED* or CFL* lamps



173 Fresnel Lens with Reflector

- White trim with glass Fresnel lens
- PS version features non-conductive, non-corrosive gasketed polymer (plastic) trim ring
- PS version is "dead-front" construction and is wet location listed for use in showers
- Torsion spring retention
- PS version is Air-Tite; making any installation Air-Tite



173P
Fresnel Lens, White Trim



173PS
Fresnel Lens, White Polymer Trim

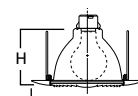

Dimensions**
H: 4" [102mm]
OD: 8" [203mm]

Housing Max Lamp Compatibility

H7UICAT 60W A19

Compatible with Halogen, Incandescent, LED* or CFL* lamps

*UL1993 listed LED & CFL equivalent lamps permitted. Consult lamp manufacturer for conditions of use. Eaton does not warranty the lamp.

**Key: A: Luminous Aperture, H: Height, OD: Trim Outside Diameter



6145 Open Wet Location, Shallow Reflector, Self-flange

- Open wet location shallow Showerlight for PAR30 and PAR38 outdoor rated lamps ONLY
- Torsion spring retention
- Socket supporting cone
- Self-flange trim ring sized to hide gaps caused by construction tolerances

Housing Max Lamp Compatibility

H7UICAT 75W PAR30S, 75W PAR30L, 90W PAR38

Compatible with Halogen, Incandescent, LED* or CFL* lamps



6145WH
White Shallow Reflector,
White Self-flange



6145SN
Satin Nickel Shallow Reflector,
Satin Nickel Self-flange



6145TBZ
Tuscan Bronze Shallow Reflector,
Tuscan Bronze Self-flange

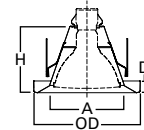

Dimensions**

A: 5-3/8" [136mm]
D: 7/8" [22mm]
H: 4-7/8" [123mm]
OD: 7-3/4" [197mm]



Lamp Gasket
(Included)

6146 Open Wet Location, Full Reflector Self-flange

- Open wet location Showerlight for PAR30 and PAR38 outdoor rated lamps ONLY
- Torsion spring retention
- Socket supporting cone
- Self-flange trim ring sized to hide gaps caused by construction tolerances

Housing Max Lamp Compatibility

H7UICAT 75W PAR30S, 75W PAR30L, 90W PAR38

Compatible with Halogen, Incandescent, LED* or CFL* lamps



6146WH
White Reflector,
White Self-flange



6146SN
Satin Nickel Reflector,
Satin Nickel Self-flange



6146TBZ
Tuscan Bronze Reflector,
Tuscan Bronze Self-flange

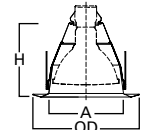

Dimensions**

A: 5-3/8" [137mm]
H: 5-3/8" [138mm]
OD: 7-3/4" [197mm]



Lamp Gasket
(Included)



6150 Low Profile, Frosted Glass Dome Lens, Self-flange

- Low profile, frosted glass dome lens
- Wet location Showerlight
- Torsion spring retention
- Non-conductive "dead-front" polymer (plastic) trim ring and glass lens
- Socket supporting internal reflector
- Self-flange trim ring sized to hide gaps caused by construction tolerances

Housing Max Lamp Compatibility

H7UICAT 43W A19, 50W PAR30S

Compatible with Halogen, Incandescent, LED* or CFL* lamps



6150WH
Frosted Glass Dome Lens
with Reflector, White
Plastic Self-flange



6150SN
Frosted Glass Dome Lens
with Reflector, Satin Nickel
Plastic Self-flange



6150TBZ
Frosted Glass Dome Lens
with Reflector, Tuscan Bronze
Plastic Self-flange

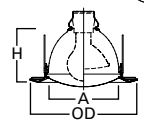

Dimensions**

A: 5-1/8" [130mm]
H: 4-1/5" [107mm]
OD: 7-3/4" [197mm]



6160 Drop White Plastic Lens, Self-flange

- Wet location Showerlight
- Non-conductive "dead-front" polymer (plastic) trim and lens
- Torsion spring retention

Housing Max Lamp Compatibility

H7UICAT 29W A19, 39W PAR30S

Compatible with Halogen, Incandescent, LED* or CFL* lamps



6160WH
Drop White Plastic Lens,
White Plastic Self-flange

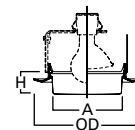

Dimensions**

A: 5-1/8" [130mm]
H: 1-5/8" [41mm]
OD: 7-3/4" [197mm]



*UL1993 listed LED & CFL equivalent lamps permitted. Consult lamp manufacturer for conditions of use. Eaton does not warranty the lamp.

**Key: A: Luminous Aperture, H: Height, OD: Trim Outside Diameter

E26 Screw Base Trims

IC Housing: H7UICAT

6
INCH



6162 Drop Opal Plastic Lens, Self-flange

- Wet location Showerlight
- Non-conductive "dead-front" polymer (plastic) trim and lens
- Torsion spring retention
- Socket supporting internal reflector
- Self-flange trim ring sized to hide gaps caused by construction tolerances



6162WH
Drop Opal Plastic Lens with Reflector, Frosted Plastic Self-flange

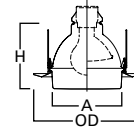

Dimensions**
A: 5-1/8" [130mm]
H: 4-3/4" [122mm]
OD: 7-3/4" [197mm]

Housing Max Lamp Compatibility

H7UICAT 29W A19

Compatible with Halogen, Incandescent, LED* or CFL* lamps

6230 Squirele Frost Glass Lens, Metal Trim, Self-flange

- Low profile frost glass lens
- Wet location Showerlight
- Torsion spring retention
- Self-flange low profile metal trim ring
- Socket supporting internal bracket
- Integral rotation adjustment up to +/- 25° for precise alignment with room



6230AH
Frost Glass Lens, Aluminum Haze Squirele Trim



6230PN
Frost Glass Lens, Polished Nickel Squirele Trim



6230SN
Frost Glass Lens, Satin Nickel Squirele Trim

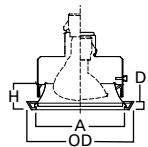

Dimensions**
A: 6" [152mm]
H: 4-1/4" [109mm]
D: 3/4" [20mm]
OD: 7-1/4" [185mm]

Housing Max Lamp Compatibility

H7UICAT 43W A19, 39W PAR30S

Compatible with Halogen, Incandescent, LED* or CFL* lamps

6255 Soft Square, Frost Curved Glass Lens, Self-flange

- Low profile curved frost glass lens
- Wet location Showerlight for A19 lamps
- Torsion spring retention
- Integral adjustment up to 90° for precise alignment to room
- Non-conductive "dead-front" polymer (plastic) trim ring and glass lens
- Integral rotation adjustment up to +/-25° for precise alignment with room
- Integrated socket supporting reflector for even illumination across lens corner-to-corner



6255WH
Frost Curved Glass Lens with Reflector, White Plastic Self-flange



6255SN
Frost Curved Glass Lens with Reflector, Satin Nickel Plastic Self-flange



6255TBZ
Frost Curved Glass Lens with Reflector, Tuscan Bronze Plastic Self-flange

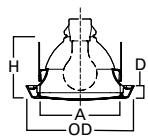

Dimensions**
A: 5-7/8" [149mm]
D: 1" [25mm]
H: 4-1/2" [114mm]
OD: 7-5/8" [194mm]

Housing Max Lamp Compatibility

H7UICAT 43W A19, 39W PAR30S

Compatible with Halogen, Incandescent, LED* or CFL* lamps

Open, Splay & Wall Wash

79 Pinhole Trim

- 1-7/8" open pinhole for R20 lamp
- Torsion spring retention



79
Pinhole Trim

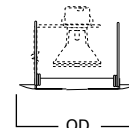

Dimensions**
OD: 8" [203mm]

Housing Max Lamp Compatibility

H7UICAT 50W PAR30

Compatible with Halogen, Incandescent, LED* or CFL* lamps

*UL1993 listed LED & CFL equivalent lamps permitted. Consult lamp manufacturer for conditions of use. Eaton does not warranty the lamp.

**Key: A: Luminous Aperture, H: Height, OD: Trim Outside Diameter

300 Open Trim with Fixed Socket Bracket

- Open trim for BR30 and PAR30 lamps
- Torsion spring retention
- Socket supporting internal bracket

Housing **Max Lamp Compatibility**

H7UICAT 75W PAR30S, 75W PAR30L,
85W BR30, 100W R30

Compatible with Halogen, Incandescent, LED* or CFL* lamps



300P
Socket Bracket with
White Open Trim



300SN
Socket Bracket with
Satin Nickel Open Trim



300TBZ
Socket Bracket with
Tuscan Bronze Open Trim

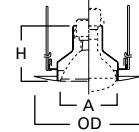

Dimensions**
A: 4-3/4" [122mm]
H: 4-3/4" [122mm]
OD: 7-1/4" [184mm]

328 White Splay Trim

- Splay trim for BR30 and PAR30 lamps
- Coil spring retention

Housing **Max Lamp Compatibility**

H7UICAT 75W PAR30S, 75W PAR30L,
65W BR30, 75W R30

Compatible with Halogen, Incandescent, LED* or CFL* lamps



328P
White Splay Trim

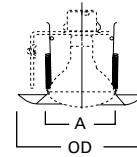

Dimensions**
A: 3-7/8" [98mm]
OD: 7-3/4" [197mm]

424 Open Wall Wash / Reflector Downlight

- Designed to spread light on cabinets or wall close to ceiling and provide downlighting on counters

Housing **Max Lamp Compatibility**

H7UICAT 60W A19

Compatible with Halogen, Incandescent, LED* or CFL* lamps



424P
Open Wall Wash and Downlight,
White Trim

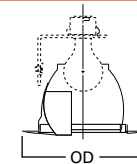

Dimensions**
OD: 7-1/4" [184mm]

425 Wall Wash with Coilex® Baffle and Scoop Reflector

- Black or white Phenolic Coilex® baffle with scoop reflector
- Designated to spread light close to ceiling
- Coil spring retention

Housing **Max Lamp Compatibility**

H7UICAT 50W R30

Compatible with Halogen, Incandescent, LED* or CFL* lamps



425W
White Baffle, White Trim



425P
Black Baffle, White Trim

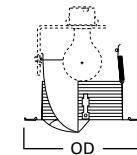

Dimensions**
OD: 7-1/4" [184mm]

430 Wall Wash with Baffle & Full Reflector

- Black or white step baffle with full reflector
- Designed to spread light close to the ceiling to eliminate the "cave effect"
- Torsion spring retention
- Makes installation Air-Tite regardless of housing used

Housing **Max Lamp Compatibility**

H7UICAT 60W A19, 50W TB19,
60W BT15, 60W MB19

Compatible with Halogen, Incandescent, LED* or CFL* lamps



430W
White Baffle, White Trim



430P
Black Baffle, White Trim

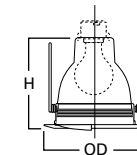

Dimensions**
H: 5" [127mm]
OD: 7-1/4" [184mm]



E26 Screw Base IC Housing - No Socket Bracket

H7ICTNB

6
INCH

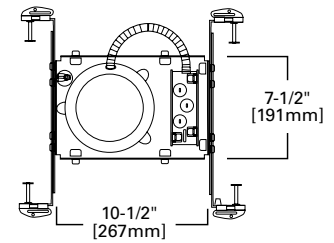
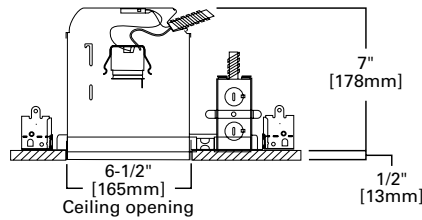

H7ICTNB

6" IC, New Construction Housing, No Socket Bracket, 120V

The H7 recessed housing is the standard in the industry for both light commercial and residential applications. H7 series features full-frame design, robust construction, feed-through listing, Got Nail!™ bar hangers; and may support use of higher wattage lamps. A wide variety of trims allows a number of different lighting effects to be created with one basic housing. H7ICTNB is for installations where the housing will be in direct contact with insulation*. May be retrofit with compatible Halo LED lighting systems.

The H7ICTNB can save installation time. It is designed without a socket plate for use with socket supporting trims only. With these trims there is no need to spend time removing the socket plate and the fixed lamp position of socket supporting trims saves on lamp adjustment time too. H7ICTNB may be converted into Air-Tite installation when used with Air-Tite trims.



Special Features

- Got Nail!™ bar hangers
- q-Channel bars with Pass-N-Thru™
- Slide-N-Side™ junction box
- Quick Connect™ push wire nuts

Compatible Socket Supporting Trims

30°	172°	404	6120	6145	6215
74	173°	420	6121	6146	6222
76	300	430°	6125	6150	6230
78°	327	478	6126	6162	6255
170°	376	4041	6130	6170	30SBAT°
171°	378				



Trims for use in Halo listed housings



Select trims are classified for use in other housings, see www.cooperlighting.com/legal

◊ Air-Tite trims can make the H7ICTNB installation ASTM E283 compliant

Features

Housing

- Single wall aluminum housing
- Aluminum construction for greater heat dissipation
- Housing can be removed from the plaster frame for junction box access
- Designed for insulated ceilings in direct contact with insulation* (May also be installed in non-insulated ceilings)

Plaster Frame

- Housing adjusts in plaster frame to accommodate up to 1" ceiling thickness
- Galvanized steel construction
- Plaster frame features include:
 - Regressed locking screw for securing hanger bars
 - Cutouts for easily crimping hanger bars in position
 - Halo name embossed on plaster frame
 - The housing may be removed from plaster frame to provide access to the junction box

Includes:

- Got Nail!™ bar hangers (Details Pg. 13)
- q-Channel bars with Pass-N-Thru™ (Details Pg. 13)
- Slide-N-Side™ junction box wire traps (Details Pg. 13)
- Quick Connect™ push wire nuts (Details Pg. 13)

Socket

- Porcelain socket with nickel plated brass screw shell
- Snap-in springs secure socket to socket plate, and may be detached when using socket supporting trims
- Overspray protector included

Thermal Protector

Self resetting thermal protector deactivates fixture if overheating occurs due to improper lamping or misapplied insulation

Trims

Halo Fit-All concept offers multiple trim options in a variety of design styles, and functional beam distributions to control beam angle and lumen delivery in accommodating various lamp types including Halogen, CFL and LED

Compliance

- cULus Listed 1598 luminaire
- cULus Listed damp location
- cULus Listed for wet location, covered ceiling, with select trims
- cULus Listed for feed through
- cULus Listed for direct contact with insulation and combustible material*
- RoHS compliant

*Not to be used in direct contact with spray foam insulation (Consult NEMA LSD57-2013)

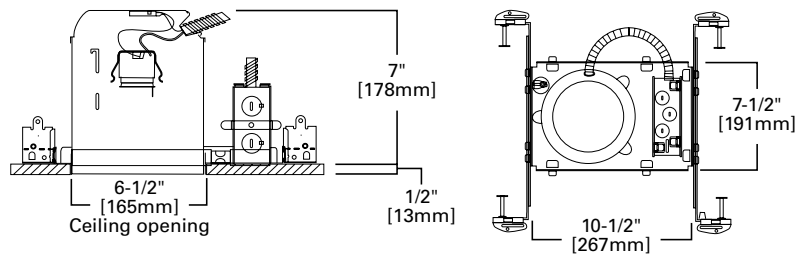

H7ICATNB

6" IC, Air-Tite, New Construction Housing, No Socket Bracket, 120V

The H7 recessed housing is the standard in the industry for both light commercial and residential applications. H7 series features full-frame design, robust construction, feed-through listing, Got Nail! bar hangers; and may support use of higher wattage lamps. A wide variety of trims allows a number of different lighting effects to be created with one basic housing. H7ICATNB is for installations where the housing will be in direct contact with insulation*, and its Air-Tite design will also meet restricted air flow code requirements. May be retrofit with compatible Halo LED lighting systems.

The H7ICATNB can save installation time. It is designed without a socket plate for use with socket supporting trims only. With these trims there is no need to spend time removing the socket plate and the fixed lamp position of socket supporting trims saves on lamp adjustment time too.



Special Features

Got Nail!™ bar hangers					
q-Channel bars with Pass-N-Thru™					
Slide-N-Side™ junction box					
Quick Connect™ push wire nuts					
Air-Tite™ code compliant					

Compatible Socket Supporting Trims

30	172	404	6120	6145	6215
74	173	420	6121	6146	6222
76	300	430	6125	6150	6230
78	327	478	6126	6162	6255
170	376	4041	6130	6170	30SBAT
171	378				



Trims for use in Halo listed housings



Select trims are classified for use in other housings, see www.cooperlighting.com/legal

Features

Housing

- Single wall aluminum housing
- Aluminum construction for greater heat dissipation
- Sealed and gasketed for Air-Tite™ ready installation
- Designed for insulated ceilings in direct contact with insulation* (May also be installed in non-insulated ceilings)

Plaster Frame

- Housing adjusts in plaster frame to accommodate up to 1" ceiling thickness
- Galvanized steel construction
- Plaster frame features include:
 - Regressed locking screw for securing hanger bars
 - Cutouts for easily crimping hanger bars in position
 - Halo name embossed on plaster frame
 - The housing may be removed from plaster frame to provide access to the junction box
 - Pre-installed Air-Tite ready ceiling contact gasket

Includes:

- Got Nail!™ bar hangers (Details Pg. 13)
- q-Channel bars with Pass-N-Thru™ (Details Pg. 13)
- Slide-N-Side™ junction box wire traps (Details Pg. 13)
- Quick Connect™ push wire nuts (Details Pg. 13)
- Air-Tite™ code compliant (Details Pg. 13)

Socket

- Porcelain socket with nickel plated brass screw shell
- Snap-in springs secure socket to socket plate, and may be detached when using socket supporting trims
- Overspray protector included

Thermal Protector

Self resetting thermal protector deactivates fixture if overheating occurs due to improper lamping or misapplied insulation

Trims

Halo Fit-All concept offers multiple trim options in a variety of design styles, and functional beam distributions to control beam angle and lumen delivery in accommodating various lamp types including Halogen, CFL and LED

Compliance

- cULus Listed 1598 luminaire
- cULus Listed damp location
- cULus Listed for wet location, covered ceiling, with select trims
- cULus Listed for feed through
- cULus Listed for direct contact with insulation and combustible material*
- Air-Tite code compliant. Certified under ASTM E283; not exceeding 2.0 cfm (0.944 L/s) air leakage rate tested at a 1.57 psf (75 Pa) pressure differential.
- RoHS compliant

*Not to be used in direct contact with spray foam insulation (Consult NEMA LSD57-2013)

E26 Screw Base IC Housing - No Socket Bracket

E71CATNB

6
INCH

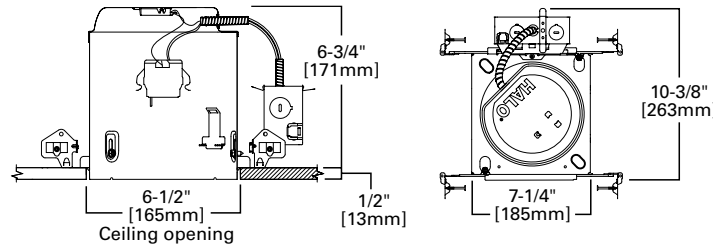

E71CATNB

6" IC, Air-Tite, New Construction Housing, No Socket Bracket, 120V

The E71CATNB is a compact and efficient recessed housing optimized and listed for EISA compliant tungsten-halogen lamps, CFL and LED lamps as well as incandescent. Housing is suitable for residential or light commercial applications. For installation in insulated ceilings* and non-insulated ceilings with Air-Tite code compliant construction. Use with a variety of trims and finishes to create different lighting effects or to match any decor. May be retrofitted with compatible Halo LED lighting systems. The E71CATNB can save installation time. It is designed without a socket plate for use with socket supporting trims only. With these trims there is no need to spend time removing the socket plate and the fixed lamp position of socket supporting trims saves on lamp adjustment time too.



Special Features

- All-Nail!™ bar hangers
- q-Channel bars with Pass-N-Thru™
- Hinged j-box with Slide-N-Side™
- Quick Connect™ push wire nuts
- Air-Tite™ code compliant

Compatible Socket Supporting Trims

30	172	404	6120	6145	6215
74	173	420	6121	6146	6222
76	300	430	6125	6150	6230
78	327	478	6126	6162	6255
170	376	4041	6130	6170	30SBAT
171	378				

Trims for use in Halo listed housings

Select trims are classified for use in other housings, see www.cooperlighting.com/legal

Features

Housing

- Single wall die-formed aluminum housing
- Housing features a precision rolled interlocking collar which maintains aperture geometry for greater assurance of installation results
- Integral gasket for code-required gasket between fixture and finished ceiling – seals aperture without need for additional caulk
- May be removed from the plaster frame to provide access to junction box

Plaster Frame

- Galvanized steel frame. Housing adjusts in plaster frame to accommodate up to 3/8" – 1" ceiling thickness.
- (2) Regressed locking screws for securing hanger bars

Includes:

- All-Nail!™ bar hangers (Details Pg. 15)
- q-Channel bars with Pass-N-Thru™ (Details Pg. 15)
- Hinged junction box with Slide-N-Side™ (Details Pg. 15)
- Quick Connect™ push wire nuts (Details Pg. 15)
- Air-Tite™ code compliant (Details Pg. 15)

Socket

- Porcelain socket with nickel plated brass screw shell
- Snap-in socket speeds installation and attaches directly to the trim for consistent lamp positioning
- Shipped with socket overspray protector installed

Thermal Protector

Self resetting thermal protector deactivates fixture if overheating occurs due to improper lamping or misapplied insulation

Trims

Halo Fit-All concept offers multiple trim options in a variety of design styles, and functional beam distributions to control beam angle and lumen delivery in accommodating various lamp types including Halogen, CFL and LED

Compliance

- cULus Listed 1598 luminaire
- cULus Listed damp location
- cULus Listed for wet location, covered ceiling, with select trims
- cULus Listed for direct contact with insulation and combustible material*
- Air-Tite code compliant. Certified under ASTM E283; not exceeding 2.0 cfm (0.944 L/s) air leakage rate tested at a 1.57 psf (75 Pa) pressure differential.
- RoHS compliant

*Not to be used in direct contact with spray foam insulation (Consult NEMA LSD57-2013)

*UL1993 listed LED & CFL equivalent lamps permitted. Consult lamp manufacturer for conditions of use. Eaton does not warranty the lamp.

**Key: A: Luminous Aperture, H: Height, OD: Trim Outside Diameter

Reflectors

30 Reflector, Self-flange

- Self-flange reflector with torsion spring retention
- Accepts a wide range of lamps
- Makes installation Air-Tite regardless of housing used
- Socket supporting reflector

Housings Max Lamp Compatibility

H7ICTNB	60W A19, 75W PAR30S, 75W PAR30L, 65W PAR38, 65W BR30, 90W BR40,
H7ICATNB	75W R30
E7ICATNB	53W A19, 75W PAR30S, 75W PAR30L, 65W PAR38, 65W BR30, 90W BR40

Compatible with Halogen, Incandescent, LED* or CFL* lamps



30HAT
Haze Reflector, White Trim



30RGAT
Residential Gold Reflector, White Trim



30CAT
Clear Specular Reflector, White Trim

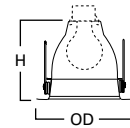

Dimensions**
H: 5" [127mm]
OD: 7-1/4" [184mm]



30SBAT Reflector, Self-flange

- Self-flange reflector with torsion spring retention
- Accepts a wide range of lamps
- Makes installation Air-Tite regardless of housing used
- Socket supporting reflector

Housings Max Lamp Compatibility

H7ICTNB	40W A19, 50W PAR30S, 75W PAR30L, 65W PAR38, 65W BR30, 75W R30,
H7ICATNB	65W BR40
E7ICATNB	40W A19, 50W PAR30S, 75W PAR30L, 65W PAR38, 65W BR30, 65W BR40

Compatible with Halogen, Incandescent, LED* or CFL* lamps



30SBAT
Specular Black Reflector & Trim

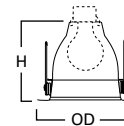

Dimensions**
H: 5" [127mm]
OD: 7-1/4" [184mm]



404 Specular Reflector

- Full reflector for use with A-lamps
- Friction clip retention on housing plaster ring
- Removable trim ring
- Accessories available: TRM6 designer trim rings, OT403 oversize trim ring
- Socket supporting reflector

Housings Max Lamp Compatibility

H7ICTNB	40W A19
H7ICATNB	404C, 404H: 53W A19
E7ICATNB	404SN, 404TBZ: 43W A19

Compatible with Halogen, Incandescent, LED* or CFL* lamps



404C
Clear Specular Reflector, White Trim



404H
Haze Reflector, White Trim



404SN
Satin Nickel Reflector, Satin Nickel Trim



404TBZ
Tuscan Bronze Reflector, Tuscan Bronze Trim



Friction Clips install on housing plaster ring

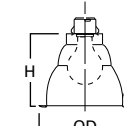

Dimensions**
H: 5" [127mm]
OD: 7-1/4" [184mm]

4041 White Reflector, Self-flange

- Self-flange reflector for use with A-lamps
- Friction clip retention on housing plaster ring
- Accessories available: OT403 oversize trim ring
- Socket supporting reflector

Housings Max Lamp Compatibility

H7ICTNB	60W A19
H7ICATNB	60W A19
E7ICATNB	53W A19

Compatible with Halogen, Incandescent, LED* or CFL* lamps



4041P
White Reflector, White Self-flange



Friction Clips install on housing plaster ring

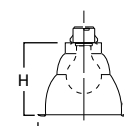

Dimensions**
H: 5-1/4" [133mm]
OD: 7-1/4" [184mm]

*UL1993 listed LED & CFL equivalent lamps permitted. Consult lamp manufacturer for conditions of use. Eaton does not warranty the lamp.

Key: **A: Luminous Aperture, **H:** Height, **OD:** Trim Outside Diameter

E26 Screw Base Trims

IC "NB" Housings: H7ICTNB • H7ICATNB • E7ICATNB

6
INCH



6120 Full Cone Reflector, Self-flange

- Full cone reflector for BR30, BR40, A19 and PAR30 and PAR38 lamps
- Torsion spring retention
- Socket supporting reflector
- Self-flange trim ring sized to hide gaps caused by construction tolerances
- Makes installation Air-Tite regardless of housing used



6120WH
White Reflector,
White Self-flange



6120SN
Satin Nickel Reflector,
Satin Nickel Self-flange



6120TBZ
Tuscan Bronze Reflector,
Tuscan Bronze Self-flange

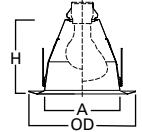

Dimensions**
A: 5-3/8" [137mm]
H: 5-3/8" [138mm]
OD: 7-3/4" [197mm]

Housings Max Lamp Compatibility

H7ICTNB	6120WH: 43W A19, 75W PAR30S, 75W PAR30L, 65W PAR38,
H7ICATNB	65W BR30, 90W BR40
E7ICATNB	6120SN, 6120TBZ: 43W A19, 60W PAR30S, 75W PAR30L, 65W PAR38, 65W BR30, 90W BR40

Compatible with Halogen, Incandescent, LED* or CFL* lamps

6121 Shallow Full Cone Reflector, Self-flange

- Shallow full cone reflector for A19, PAR30, and BR30 lamps
- Torsion spring retention
- Self-flange trim ring sized to hide gaps caused by construction tolerances
- Makes installation Air-Tite regardless of housing used



6121WH
White Reflector, White Self-flange

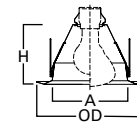

Dimensions**
A: 5-3/8" [137mm]
H: 4-3/8" [110mm]
OD: 7-3/4" [197mm]

Housings Max Lamp Compatibility

H7ICTNB	43W A19, 75W PAR30S,
H7ICATNB	75W PAR30L, 65W BR30
E7ICATNB	

Compatible with Halogen, Incandescent, LED* or CFL* lamps

Baffles

30 Baffle, Self-flange

- Self-flange metal baffle
- Socket supporting baffle
- Torsion spring retention
- Accepts a wide range of lamps
- Makes installation Air-Tite regardless of housing used



30WAT
White Baffle & Reflector,
White Trim



30WATH
White Baffle & Clear Reflector,
White Trim



30PAT
Black Baffle & Clear Reflector,
White Trim



30SNAT
Satin Nickel Baffle & Reflector,
Satin Nickel Trim



30TBZAT
Tuscan Bronze Baffle &
Reflector, Tuscan Bronze Trim

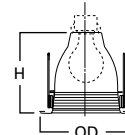

Dimensions**
H: 5" [127mm]
OD: 7-1/4" [184mm]

Housings Max Lamp Compatibility

H7ICTNB	40W A19, 75W PAR30S, 75W PAR30L,
H7ICATNB	65W PAR38, 65W BR30, 90W BR40, 75W R30
E7ICATNB	30WAT, 30WATH, 30PAT: 40W A19, 75W PAR30S, 75W PAR30L, 65W PAR38, 65W BR30, 90W BR40 30TBZAT, 30SNAT: 40W A19, 60W PAR30S, 75W PAR30L, 65W PAR38, 65W BR30, 90W BR40

Compatible with Halogen, Incandescent, LED* or CFL* lamps

6125 Full Cone Baffle, Self-flange

- Full cone baffle
- Torsion spring retention
- Socket supporting baffle
- Self-flange trim ring sized to hide gaps caused by construction tolerances



6125WB
White Baffle, White Self-flange



6125BB
Black Baffle, White Self-flange



6125BKBB
Black Baffle, Black Self-flange

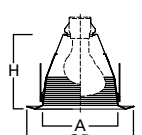

Dimensions**
A: 5-3/8" [137mm]
H: 5-3/8" [138mm]
OD: 7-3/4" [197mm]

Housings Max Lamp Compatibility

H7ICTNB	6125WB: 43W A19, 75W PAR30S, 75W PAR30L, 65W PAR38,
H7ICATNB	65W BR30, 90W BR40
E7ICATNB	6125BB, 6125BKBB: 43W A19, 75W PAR30S, 75W PAR30L, 65W PAR38, 65W BR30, 85W BR40

Compatible with Halogen, Incandescent, LED* or CFL* lamps

*UL1993 listed LED & CFL equivalent lamps permitted. Consult lamp manufacturer for conditions of use. Eaton does not warranty the lamp.

**Key: A: Luminous Aperture, H: Height, OD: Trim Outside Diameter

Specifications, compliances and dimensions subject to change without notice



6126 Shallow Full Cone Baffle, Self-flange

- Shallow full cone baffle for A19 and PAR30 lamps
- Torsion spring retention
- Socket supporting baffle
- Self-flange trim ring sized to hide gaps caused by construction tolerances
- Makes installation Air-Tite regardless of housing used

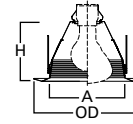

Dimensions**
 A: 5-3/8" [137mm]
 H: 4-3/8" [110mm]
 OD: 7-3/4" [197mm]

Housings Max Lamp Compatibility

H7ICTNB	43W A19, 75W PAR30S,
H7ICATNB	75W PAR30L, 65W BR30
E7ICATNB	

Compatible with Halogen, Incandescent, LED* or CFL* lamps

Adjustable – Eyeballs & Gimbals

74 Eyeball 30° Tilt, Self-flange

- Provides optimum position for PAR30S lamps
- Torsion spring retention
- Socket supporting eyeball

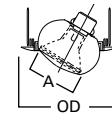

Dimensions**
 A: 3-7/8" [98mm]
 OD: 8" [203mm]

Housings Max Lamp Compatibility

H7ICTNB	
H7ICATNB	75W PAR30S
E7ICATNB	

Compatible with Halogen, Incandescent, LED* or CFL* lamps

76 Gimbal 30° Tilt, Self-flange

- For use with PAR38 lamps
- 30° tilt
- Torsion spring retention

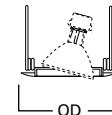

Dimensions**
 OD: 8" [203mm]

Housings Max Lamp Compatibility

H7ICTNB	
H7ICATNB	45W PAR38
E7ICATNB	

Compatible with Halogen, Incandescent, LED* or CFL* lamps

78 Eyeball 30° Tilt, Self-flange

- 30° tilt, 360° rotation
- Torsion spring retention
- Wide choice of finishes for any decor
- Socket supporting eyeball
- 78PAT makes installation Air-Tite regardless of housing used

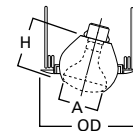

Dimensions**
 A: 4" [100mm]
 H: 4-1/8" [105mm]
 OD: 8" [203mm]

Housings Max Lamp Compatibility

H7ICTNB	
H7ICATNB	75W PAR30L, 65W BR30, 75W R30
E7ICATNB	75W PAR30S, 75W PAR30L, 65W BR30

Compatible with Halogen, Incandescent, LED* or CFL* lamps

376 Regressed Gimbal 30° Tilt, Self-flange

- 30° tilt
- Regressed gimbal with baffle
- Torsion spring retention
- Socket supporting gimbal



Dimensions**
 OD: 7-1/4" [184mm]

Housings Max Lamp Compatibility

H7ICTNB	
H7ICATNB	50W PAR30S, 50W PAR30L
E7ICATNB	

Compatible with Halogen, Incandescent, LED* or CFL* lamps

*UL1993 listed LED & CFL equivalent lamps permitted. Consult lamp manufacturer for conditions of use. Eaton does not warranty the lamp.

**Key: A: Luminous Aperture, H: Height, OD: Trim Outside Diameter

E26 Screw Base Trims

IC "NB" Housings: H7ICTNB • H7ICATNB • E7ICATNB

6
INCH

378 Regressed Gimbal with Splay 25° Tilt, Self-flange

- 25° tilt
- Regressed gimbal with splay trim
- Removable trim ring
- Accessories available: TRM6 designer trim rings, OT403 oversize trim ring
- Friction clips on trim
- Socket supporting gimbal



378P
White Splay, White Trim



378
Clear Specular Splay, White Trim

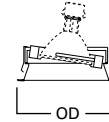

Dimensions**
OD: 7-1/4" [184mm]

Housings Max Lamp Compatibility

H7ICTNB	
H7ICATNB	35W PAR30L
E7ICATNB	

Compatible with Halogen, Incandescent, LED* or CFL* lamps



Friction Clips on Trim

420 Regressed Eyeball 30° Tilt, Self-flange

- Regressed eyeball with baffle splay
- Removable trim ring
- Accessories available: TRM6 designer trim rings, OT403 oversize trim ring
- Socket supporting eyeball



420W
White Eyeball & Baffle,
White Trim



420P
White Eyeball & Black Baffle,
White Trim

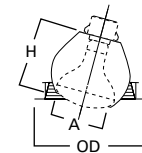

Dimensions**
A: 4" [100mm]
H: 4" [102mm]
OD: 7-1/4" [184mm]

Housings Max Lamp Compatibility

H7ICTNB	
H7ICATNB	50W PAR30S, 50W PAR30L, 60W BR30
E7ICATNB	

Compatible with Halogen, Incandescent, LED* or CFL* lamps

478 Adjustable Regressed Gimbal with Splay 25° Tilt, Self-flange

- 25° tilt
- Adjustable gimbal with splay trim for PAR38 lamps
- Removable trim ring
- Accessories available: TRM6 designer trim rings, OT403 oversize trim ring
- Friction clip on trim
- Socket supporting gimbal



478P
White Splay, White Trim



Friction Clips on Trim

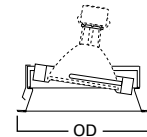

Dimensions**
OD: 7-3/4" [197mm]

Housings Max Lamp Compatibility

H7ICTNB	
H7ICATNB	45W PAR38
E7ICATNB	

Compatible with Halogen, Incandescent, LED* or CFL* lamps

6130 Eyeball 35° Tilt, Self-flange

- 35° tilt, 360° rotation
- Adjustable eyeball trim for BR30 and PAR30 lamps
- Torsion spring retention
- Socket supporting eyeball
- Self-flange trim ring sized to hide gaps caused by construction tolerances



6130WH
White Eyeball, White Self-flange

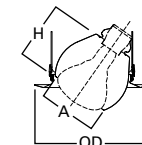

Dimensions**
A: 3-7/8" [100mm]
H: 3-7/8" [100mm]
OD: 7-3/4" [197mm]

Housings Max Lamp Compatibility

H7ICTNB	
H7ICATNB	50W PAR30S, 75W PAR30L, 65W BR30
E7ICATNB	

Compatible with Halogen, Incandescent, LED* or CFL* lamps

*UL1993 listed LED & CFL equivalent lamps permitted. Consult lamp manufacturer for conditions of use. Eaton does not warranty the lamp.

**Key: A: Luminous Aperture, H: Height, OD: Trim Outside Diameter

6170 Gimbal 25° Tilt, Self-flange

- 25° tilt, 360° rotation
- Adjustable gimbal for PAR38 lamps
- Torsion spring retention
- Socket supporting gimbal
- Self-flange trim ring sized to hide gaps caused by construction tolerances

Housings Max Lamp Compatibility

H7ICTNB	
H7ICATNB	45W PAR38L
E7ICATNB	

Compatible with Halogen, Incandescent, LED* or CFL* lamps



6170WH
White Gimbal,
White Self-flange



6170BK
Black Gimbal,
Black Self-flange



6170SN
Satin Nickel Gimbal,
Satin Nickel Self-flange



6170TBZ
Tuscan Bronze Gimbal,
Tuscan Bronze Self-flange

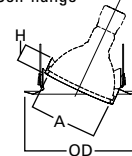

Dimensions**
A: 4-1/2" [113mm]
H: 1-1/15" [30mm]
OD: 7-3/4" [197mm]

6215 Double Gimbal 30°-50° Tilt, Self-flange

- 30°-50° tilt, 360° rotation
- 50° tilt with double gimbal design using compound angles
- Double gimbal for PAR30 lamps
- Torsion spring retention
- Shallow housings are compatible with PAR30S (short-neck) lamps
- Socket supporting gimbal
- Self-flange trim ring sized to hide gaps caused by construction tolerances

Housings Max Lamp Compatibility

H7ICTNB	
H7ICATNB	60W PAR30S, 60W PAR30L
E7ICATNB	

Compatible with Halogen, Incandescent, LED* or CFL* lamps



6215WH
White Gimbal,
White Self-flange



6215BK
Black Gimbal,
Black Self-flange



6215SN
Satin Nickel Gimbal,
Satin Nickel Self-flange



6215TBZ
Tuscan Bronze Gimbal,
Tuscan Bronze Self-flange

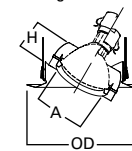

Dimensions**
A: 3-3/8" [84mm]
H: 2" [51mm]
OD: 7-3/4" [197mm]

6222 Regressed Angle Cut Adjustable Gimbal, 45° Tilt, Self-flange

- 45° tilt, 360° rotation
- Fully regressed gimbal - self-flange ring
- Torsion spring retention
- Socket supporting gimbal
- Reflector and baffle options
- Accommodates tilt of gimbal in a full regressed cut cone
- Self-flange trim ring sized to hide gaps caused by construction tolerances

Housings Max Lamp Compatibility

H7ICTNB	
H7ICATNB	39W PAR30S, 60W PAR30L
E7ICATNB	

Compatible with Halogen, Incandescent, LED* or CFL* lamps



6222WB
White Baffle, White Trim



6222BB
Black Baffle, White Trim



6222SC
Specular Clear Reflector
White Trim



6222H
Haze Reflector,
White Trim

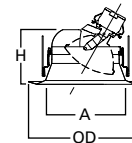

Dimensions**
A: 3-3/4" [95mm]
H: 5-3/8" [137mm]
OD: 7-3/4" [197mm]

Lenses & Wet Location Showerlights

170 Albalite Lens with Reflector

- White trim with Albalite glass lens
- PS version features non-conductive, non-corrosive gasketed polymer (plastic) trim ring
- PS version is "dead-front" construction and is wet location listed for use in showers
- Torsion spring retention
- PS version is Air-Tite; making any installation Air-Tite

Housings Max Lamp Compatibility

H7ICTNB	40W A19
H7ICATNB	
E7ICATNB	29W A19

Compatible with Halogen, Incandescent, LED* or CFL* lamps



170P
Albalite Lens, White Trim



170PS
Albalite Lens, Polymer White Trim

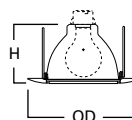

Dimensions**
H: 4" [102mm]
OD: 8" [203mm]

*UL1993 listed LED & CFL equivalent lamps permitted. Consult lamp manufacturer for conditions of use. Eaton does not warranty the lamp.

**Key: A: Luminous Aperture, H: Height, OD: Trim Outside Diameter

E26 Screw Base Trims

IC "NB" Housings: H7ICTNB • H7ICATNB • E7ICATNB

6
INCH

171 Drop Opal Glass Lens with Reflector

- White trim with drop opal glass lens
- PS version features non-conductive, non-corrosive gasketed polymer (plastic) trim ring
- PS version is "dead-front" construction and is wet location listed for use in showers
- Torsion spring retention
- PS version is Air-Tite; making any installation Air-Tite



171P
Drop Opal Lens, White Trim



171PS
Drop Opal Lens, White Polymer Trim

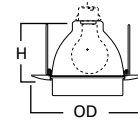

Dimensions**
H: 4" [102mm]
OD: 8" [203mm]

Housings Max Lamp Compatibility

H7ICTNB — 40W A19
H7ICATNB —

E7ICATNB — 29W A19

Compatible with Halogen, Incandescent, LED* or CFL* lamps



172 Dome Glass Lens with Reflector

- Frosted glass dome
- Wet location listed for use in showers
- Non-conductive, non-corrosive gasketed polymer (plastic) trim ring
- Features "dead-front" construction and is wet location listed for use in showers
- Torsion spring retention



172PS
Frosted Glass Dome,
White Polymer Trim



172SNS
Frosted Glass Dome,
Satin Nickel Polymer Trim



172TBZS
Frosted Glass Dome,
Tuscan Bronze Polymer Trim

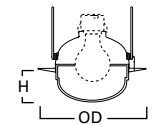

Dimensions**
H: 2-1/8" [54mm]
OD: 7-3/4" [197mm]

Housings Max Lamp Compatibility

H7ICTNB — 60W A19
H7ICATNB —

E7ICATNB — **172PS:** 53W A19, 50W PAR30S

172SNS, 172TBZS:
43W A19, 50W PAR30S

Compatible with Halogen, Incandescent, LED* or CFL* lamps



173 Fresnel Lens with Reflector

- White trim with glass Fresnel lens
- PS version features non-conductive, non-corrosive gasketed polymer (plastic) trim ring
- PS version is "dead-front" construction and is wet location listed for use in showers
- Torsion spring retention
- PS version is Air-Tite; making any installation Air-Tite



173P
Fresnel Lens, White Trim



173PS
Fresnel Lens, White Polymer Trim

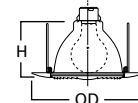

Dimensions**
H: 4" [102mm]
OD: 8" [203mm]

Housings Max Lamp Compatibility

H7ICTNB — 40W A19
H7ICATNB —

E7ICATNB — 29W A19

Compatible with Halogen, Incandescent, LED* or CFL* lamps

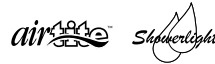

6145 Open Wet Location, Shallow Reflector, Self-flange

- Open wet location shallow Showerlight for PAR30 and PAR38 outdoor rated lamps ONLY
- Torsion spring retention
- Socket supporting cone
- Self-flange trim ring sized to hide gaps caused by construction tolerances



6145WH
White Shallow Reflector,
White Self-flange



6145SN
Satin Nickel Shallow Reflector,
Satin Nickel Self-flange



6145TBZ
Tuscan Bronze Shallow Reflector,
Tuscan Bronze Self-flange

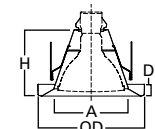

Dimensions**
A: 5-3/8" [136mm]
D: 7/8" [22mm]
H: 4-7/8" [123mm]
OD: 7-3/4" [197mm]

Housings Max Lamp Compatibility

H7ICTNB — 75W PAR30S, 75W PAR30L,
H7ICATNB — 80W PAR38
E7ICATNB —

Compatible with Halogen, Incandescent, LED* or CFL* lamps

**Outdoor
Rated Lamp
ONLY**
(Purchase
Separately)



Lamp Gasket
(Included)



*UL1993 listed LED & CFL equivalent lamps permitted. Consult lamp manufacturer for conditions of use. Eaton does not warranty the lamp.

**Key: A: Luminous Aperture, H: Height, OD: Trim Outside Diameter

Specifications, compliances and dimensions subject to change without notice

6146 Open Wet Location, Full Reflector Self-flange

- Open wet location Showerlight for PAR30 and PAR38 outdoor rated lamps ONLY
- Torsion spring retention
- Socket supporting cone
- Self-flange trim ring sized to hide gaps caused by construction tolerances

Housings Max Lamp Compatibility

H7ICTNB	6146WH: 75W PAR30S,
H7ICATNB	75W PAR30L, 65W PAR38
E7ICATNB	6146SN, 6146TBZ: 60W PAR30S,
	75W PAR30L, 65W PAR38

Compatible with Halogen, Incandescent, LED* or CFL* lamps



6146WH
White Reflector,
White Self-flange



6146SN
Satin Nickel Reflector,
Satin Nickel Self-flange



6146TBZ
Tuscan Bronze Reflector,
Tuscan Bronze Self-flange



Lamp Gasket
(Included)

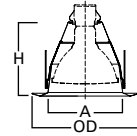

Dimensions**
A: 5-3/8" [137mm]
H: 5-3/8" [138mm]
OD: 7-3/4" [197mm]



6150 Low Profile, Frosted Glass Dome Lens, Self-flange

- Low profile, frosted glass dome lens
- Wet location Showerlight
- Torsion spring retention
- Non-conductive "dead-front" polymer (plastic) trim ring and glass lens
- Socket supporting internal reflector
- Self-flange trim ring sized to hide gaps caused by construction tolerances

Housings Max Lamp Compatibility

H7ICTNB	
H7ICATNB	29W A19, 39W PAR30S
E7ICATNB	

Compatible with Halogen, Incandescent, LED* or CFL* lamps



6150WH
Frosted Glass Dome Lens
with Reflector, White
Plastic Self-flange



6150SN
Frosted Glass Dome Lens
with Reflector, Satin Nickel
Plastic Self-flange



6150TBZ
Frosted Glass Dome Lens
with Reflector, Tuscan Bronze
Plastic Self-flange

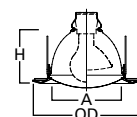

Dimensions**
A: 5-1/8" [130mm]
H: 4-1/5" [107mm]
OD: 7-3/4" [197mm]



6162 Drop Opal Plastic Lens, Self-flange

- Wet location Showerlight
- Non-conductive "dead-front" polymer (plastic) trim and lens
- Torsion spring retention
- Socket supporting internal reflector
- Self-flange trim ring sized to hide gaps caused by construction tolerances

Housings Max Lamp Compatibility

H7ICTNB	
H7ICATNB	29W A19
E7ICATNB	

Compatible with Halogen, Incandescent, LED* or CFL* lamps



6162WH
Drop Opal Plastic Lens
with Reflector, Frosted
Plastic Self-flange

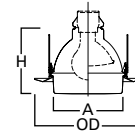

Dimensions**
A: 5-1/8" [130mm]
H: 4-3/4" [122mm]
OD: 7-3/4" [197mm]



6230 Squirrel Frost Glass Lens, Metal Trim, Self-flange

- Low profile frost glass lens
- Wet location Showerlight
- Torsion spring retention
- Self-flange low profile metal trim ring
- Socket supporting internal bracket
- Integral rotation adjustment up to +/- 25° for precise alignment with room

Housings Max Lamp Compatibility

H7ICTNB	
H7ICATNB	29W A19, 39W PAR30S
E7ICATNB	

Compatible with Halogen, Incandescent, LED* or CFL* lamps



6230AH
Frost Glass Lens, Aluminum
Haze Squirrel Trim



6230PN
Frost Glass Lens, Polished
Nickel Squirrel Trim



6230SN
Frost Glass Lens,
Satin Nickel Squirrel Trim

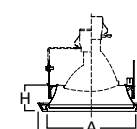

Dimensions**
A: 6" [152mm]
H: 4-1/4" [109mm]
D: 3/4" [20mm]
OD: 7-1/4" [185mm]



*UL1993 listed LED & CFL equivalent lamps permitted. Consult lamp manufacturer for conditions of use. Eaton does not warranty the lamp.

**Key: A: Luminous Aperture, H: Height, OD: Trim Outside Diameter

E26 Screw Base Trims

IC "NB" Housings: H7ICTNB • H7ICATNB • E7ICATNB

6
INCH



6255 Soft Square, Frost Curved Glass Lens, Self-flange

- Low profile curved frost glass lens
- Wet location Showerlight
- Torsion spring retention
- Non-conductive "dead-front" polymer (plastic) trim ring and glass lens
- Integral rotation adjustment up to +/- 25° for precise alignment with room
- Integrated socket supporting reflector for even illumination across lens corner-to-corner



6255WH
Frost Curved Glass Lens with Reflector, White Plastic Self-flange



6255SN
Frost Curved Glass Lens with Reflector, Satin Nickel Plastic Self-flange



6255TBZ
Frost Curved Glass Lens with Reflector, Tuscan Bronze Plastic Self-flange

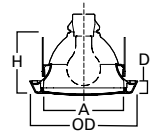

Dimensions**
A: 5-7/8" [149mm]
D: 1" [25mm]
H: 4-1/2" [114mm]
OD: 7-5/8" [194mm]

Housings Max Lamp Compatibility

H7ICTNB	
H7ICATNB	29W A19, 39W PAR30S
E7ICATNB	

Compatible with Halogen, Incandescent, LED* or CFL* lamps

Open, Splay & Wall Wash

300 Open Trim with Fixed Socket Bracket

- Open trim for BR30 and PAR30 lamps
- Torsion spring retention
- Socket supporting internal bracket



300P
Socket Bracket with White Open Trim



300SN
Socket Bracket with Satin Nickel Open Trim



300TBZ
Socket Bracket with Tuscan Bronze Open Trim

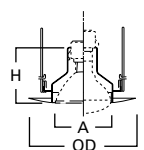

Dimensions**
A: 4-3/4" [122mm]
H: 4-3/4" [122mm]
OD: 7-1/4" [184mm]

Housings	Max Lamp Compatibility
H7ICTNB	75W PAR30S, 75W PAR30L, 65W BR30
H7ICATNB	
E7ICATNB	300P: 75W PAR30S, 75W PAR30L, 65W BR30 300SN, 300TBZ: 60W PAR30S, 60W PAR30L, 50W BR30

Compatible with Halogen, Incandescent, LED* or CFL* lamps

327 White Splay Trim with Fixed Socket Bracket

- Splay trim for BR30 and PAR30 lamps
- Torsion spring retention
- Socket supporting internal bracket



327P
White Splay Trim with Socket Bracket

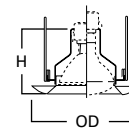

Dimensions**
H: 4-1/2" [114mm]
OD: 7-3/4" [197mm]

Housings	Max Lamp Compatibility
H7ICTNB	
H7ICATNB	75W PAR30S, 75W PAR30L, 65W BR30
E7ICATNB	

Compatible with Halogen, Incandescent, LED* or CFL* lamps

430 Wall Wash with Baffle & Full Reflector

- Black or white step baffle with full reflector
- Designed to spread light close to the ceiling to eliminate the "cave effect"
- Torsion spring retention
- Makes installation Air-Tite regardless of housing used



430W
White Baffle, White Trim



430P
Black Baffle, White Trim

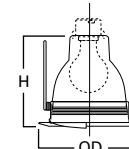

Dimensions**
H: 5" [127mm]
OD: 7-1/4" [184mm]

Housings	Max Lamp Compatibility
H7ICTNB	
H7ICATNB	40W A19
E7ICATNB	29W A19

Compatible with Halogen, Incandescent, LED* or CFL* lamps

*UL1993 listed LED & CFL equivalent lamps permitted. Consult lamp manufacturer for conditions of use. Eaton does not warranty the lamp.

**Key: A: Luminous Aperture, H: Height, OD: Trim Outside Diameter

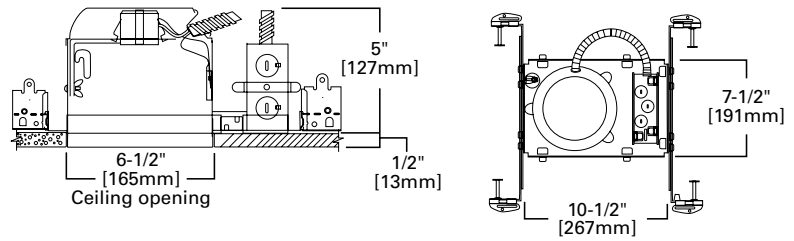

H27ICAT

6" IC, Air-Tite, Shallow New Construction Housing, 120V

The H27ICAT recessed housing is designed for shallow ceilings and is a standard in the industry for both light commercial and residential applications. H27 series features robust construction, feed-through listing, Got Nail! bar hangers; and may support use of higher wattage lamps. A wide variety of trims allows a number of different lighting effects to be created with one basic housing. The H27ICAT is for installations where the housing will be in direct contact with insulation,* and its Air-Tite design will also meet restricted air flow code requirements. May be retrofit with compatible Halo LED lighting systems.



Special Features

- Got Nail!™ bar hangers
- q-Channel bars with Pass-N-Thru™
- Slide-N-Side™ junction box
- Quick Connect™ push wire nuts
- Air-Tite™ code compliant

Compatible Trims

74	300	420	6103	6110	6150
78	310	426	6106	6121	6162
170	328	6100	6107	6126	6215
171	353	6101	6108	6130	6230
172		6102	6109	6145	6255
173					



Trims for use in Halo listed housings



Select trims are classified for use in other housings, see www.cooperlighting.com/legal

Features

Housing

- Single wall aluminum housing
- Aluminum housing for greater heat dissipation
- Sealed and gasketed for Air-Tite ready installation

Socket Plate

- Rigid socket plate adjusts and locks without tools for various lamp sizes
- Socket plate and bracket may be removed when using socket supporting trims

Plaster Frame

Housing adjusts in plaster frame 1" to accommodate different ceiling thicknesses. Galvanized steel construction. Plaster frame features include:

- Regressed locking screw for securing hanger bars
- Cutouts for easily crimping hanger bars in position
- The housing may be removed from plaster frame to provide access to the junction box
- Halo name embossed on plaster frame
- Pre-installed Air-Tite ready ceiling contact gasket

Includes:

- Got Nail!™ bar hangers (Details Pg. 13)
- q-Channel bars with Pass-N-Thru™ (Details Pg. 13)
- Slide-N-Side™ junction box wire traps (Details Pg. 13)
- Quick Connect™ push wire nuts (Details Pg. 13)
- Air-Tite™ code compliant (Details Pg. 13)

Socket

- Porcelain socket with nickel plated brass screw shell
- Snaps into socket plate (or into socket supporting trim for consistent lamp positioning)
- Overspray protector included

Thermal Protector

Self resetting thermal protector deactivates fixture if overheating occurs due to improper lamping or misapplied insulation

Trims

Halo Fit-All concept offers multiple trim options in a variety of design styles, and functional beam distributions to control beam angle and lumen delivery in accommodating various lamp types including Halogen, CFL and LED

Compliance

- cULus Listed 1598 luminaire
- cULus Listed damp location
- cULus Listed for wet location, covered ceiling
- cULus Listed for feed through
- cULus Listed for direct contact with insulation and combustible material*
- Air-Tite code compliant. Certified under ASTM E283; not exceeding 2.0 cfm (0.944 L/s) air leakage rate tested at a 1.57 psf (75 Pa) pressure differential.
- RoHS compliant

*Not to be used in direct contact with spray foam insulation (Consult NEMA LSD57-2013)

E26 Screw Base IC Shallow Housing

H27RICAT

6
INCH

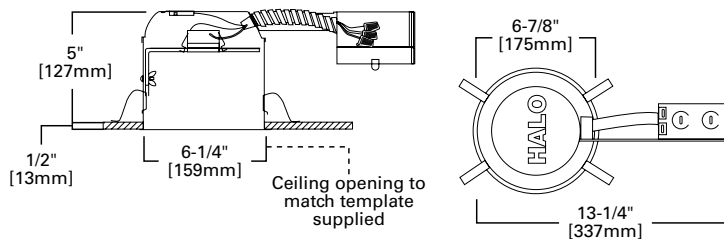

H27RICAT

6" IC, Air-Tite, Shallow Remodel Housing, 120V

The H27RICAT recessed remodel housing is designed for shallow ceilings and is a standard in the industry for both light commercial and residential applications. H27 series shallow remodel housings features robust construction, full-sized remodel junction box; and may support use of higher wattage lamps. Designed for use in existing ceilings, the remodel housing slips through opening in the finished ceiling. A wide variety of trims allows a number of different lighting effects to be created with one basic housing. H27RICAT is for installations where the housing will be in direct contact with insulation,* and its Air-Tite design will also meet restricted air flow code requirements. May be retrofit with compatible Halo LED lighting systems.



Special Features

- Quick Connect™ push wire nuts
- Air-Tite™ code compliant

Compatible Trims

74	300	420	6103	6110	6150
78	310	426	6106	6121	6162
170	328	6100	6107	6126	6215
171	353	6101	6108	6130	6230
172		6102	6109	6145	6255



Trims for use in Halo listed housings



Select trims are classified for use in other housings, see www.cooperlighting.com/legal

Features

Housing

- Single wall aluminum housing
- Aluminum construction for greater heat dissipation
- For installation from below the finished ceiling. Integral flange secures fixture against ceiling.
- Halo name embossed on housing
- Pre-installed Air-Tite ready ceiling contact gasket on flange

Socket Plate

- Rigid socket plate adjusts and locks without tools for various lamp sizes
- Socket plate and bracket may be removed when using socket supporting trims

Remodel Springs

Four remodel springs secure housing and accommodate 1/2" and 5/8" ceiling material

Includes:

- Quick Connect™ push wire nuts (Details Pg. 13)
- Air-Tite™ code compliant (Details Pg. 13)

Junction Box

- Seven 1/2" trade size conduit knockouts with true pry-out slots are positioned to accommodate straight conduit runs
- Four non-metallic (NM) cable pry-outs included

Socket

- Porcelain socket with nickel plated brass screw shell
- Snap-in springs secure socket to socket plate, and may be detached when using socket supporting trims
- Overspray protector included

Thermal Protector

Self resetting thermal protector deactivates fixture if overheating occurs due to improper lamping or misapplied insulation

Trims

Halo Fit-All concept offers multiple trim options in a variety of design styles, and functional beam distributions to control beam angle and lumen delivery in accommodating various lamp types including Halogen, CFL and LED

Compliance

- cULus Listed 1598 luminaire
- cULus Listed damp location
- cULus Listed for wet location, covered ceiling, with select trims
- cULus Listed for feed through
- cULus Listed for direct contact with insulation and combustible material*
- Air-Tite code compliant. Certified under ASTM E283; not exceeding 2.0 cfm (0.944 L/s) air leakage rate tested at a 1.57 psf (75 Pa) pressure differential.
- RoHS compliant

*Not to be used in direct contact with spray foam insulation (Consult NEMA LSD57-2013)

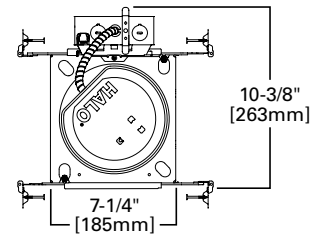
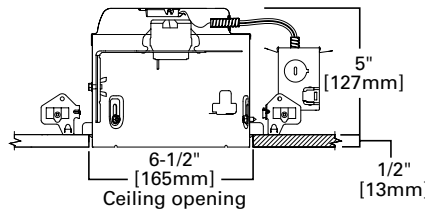

E27ICAT

6" IC, Air-Tite, Shallow New Construction Housing, 120V

The E27ICAT is a compact and efficient shallow recessed remodel housing optimized and listed for EISA compliant tungsten-halogen, CFL and LED lamps as well as incandescent. Housing is suitable for residential or light commercial shallow ceiling applications. For installation in insulated ceilings* and non-insulated ceilings with Air-Tite code compliant construction. Use with a variety of trims and finishes to create different lighting effects or to match any decor. May be retrofit with compatible Halo LED lighting systems.



Special Features

- All-Nail!™ bar hangers
- q-Channel bars with Pass-N-Thru™
- Hinged j-box with Slide-N-Side™
- Quick Connect™ push wire nuts
- Air-Tite™ code compliant

Compatible Trims

74	300	420	6103	6110	6150
78	310	426	6106	6121	6162
170	328	6100	6107	6126	6215
171	353	6101	6108	6130	6230
172		6102	6109	6145	6255
173					

Trims for use in Halo listed housings

Select trims are classified for use in other housings, see www.cooperlighting.com/legal

Features

Housing

- Single wall die-formed shallow aluminum housing
- Housing features a precision rolled interlocking collar which maintains aperture geometry for greater assurance of installation results
- Exclusive Air-Tite gasket meets code where required, and seals between housing, frame and finished ceiling - without need for additional caulk
- May be removed from the plaster frame to provide access to junction box

Socket Plate

- Rigid socket plate adjusts and locks without tools for various lamp sizes
- Socket plate and bracket may be removed when using socket supporting trims

Plaster Frame

- Galvanized steel frame. Housing adjusts in plaster frame to accommodate up to 3/8" – 1" ceiling thickness.
- (2) Regressed locking screw for securing hanger bars
- Integral Air-Tite gasket seals housing and meets code-required gasket between fixture and finished ceiling

Includes:

- All-Nail!™ bar hangers (Details Pg. 15)
- q-Channel bars with Pass-N-Thru™ (Details Pg. 15)
- Hinged junction box with Slide-N-Side™ (Details Pg. 15)
- Quick Connect™ push wire nuts (Details Pg. 15)
- Air-Tite™ code compliant (Details Pg. 15)

Socket

- Porcelain socket with nickel plated brass screw shell
- Snap-in springs secure socket to socket plate, and may be detached when using socket supporting trims
- Shipped with socket overspray protector installed

Thermal Protector

Self resetting thermal protector deactivates fixture if overheating occurs due to improper lamping or misapplied insulation

Trims

Halo Fit-All concept offers multiple trim options in a variety of design styles, and functional beam distributions to control beam angle and lumen delivery in accommodating various lamp types including Halogen, CFL and LED

Compliance

- cULus Listed 1598 luminaire
- cULus Listed damp location
- cULus Listed for wet location, covered ceiling, with select trims
- cULus Listed for direct contact with insulation and combustible material*
- Air-Tite code compliant. Certified under ASTM E283; not exceeding 2.0 cfm (0.944 L/s) air leakage rate tested at a 1.57 psf (75 Pa) pressure differential.
- RoHS compliant

*Not to be used in direct contact with spray foam insulation (Consult NEMA LSD57-2013)

E26 Screw Base IC Shallow Housing

E27RICAT

6
INCH

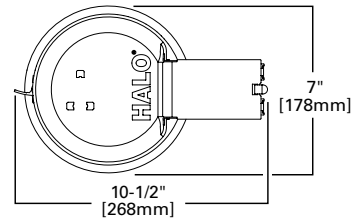
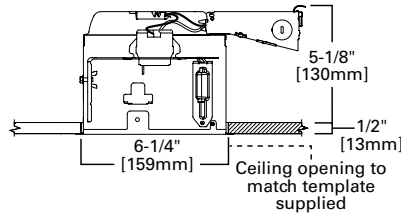

E27RICAT

6" IC, Air-Tite, Shallow Remodel Housing, 120V

The E27RICAT is a compact and efficient shallow recessed remodel housing optimized and listed for EISA compliant tungsten-halogen, CFL and LED lamps as well as incandescent. Housing is suitable for residential or light commercial shallow ceiling applications. For installation in insulated ceilings* and non-insulated ceilings with Air-Tite code compliant construction. Use with a variety of trims and finishes to create different lighting effects or to match any decor. May be retrofit with compatible Halo LED lighting systems.



Special Features

- Hinged j-box with Slide-N-Side™
- Quick Connect™ push wire nuts
- Air-Tite™ code compliant

Compatible Trims

74	300	420	6103	6110	6150
78	310	426	6106	6121	6162
170	328	6100	6107	6126	6215
171	353	6101	6108	6130	6230
172		6102	6109	6145	6255



Trims for use in Halo listed housings



Select trims are classified for use in other housings, see www.cooperlighting.com/legal

Features

Housing

- Single wall die-formed shallow aluminum housing
- Housing features a precision rolled interlocking collar which maintains aperture geometry for greater assurance of installation results
- Exclusive Air-Tite gasket meets code where required, and seals between housing, flange and finished ceiling - without need for additional caulk
- For installation from below the finished ceiling. Integral flange secures fixture against ceiling.

Remodel Retention System - Speed Clamps

- Exclusive two integral speed clamps securely lock housing to ceiling, accommodating 3/8" to 2" ceiling materials

Socket Plate

- Rigid socket plate adjusts and locks without tools for various lamp sizes
- Socket plate and bracket may be removed when using socket supporting trims

Includes:

- Hinged junction box with Slide-N-Side™ (Details Pg. 15)
- Quick Connect™ push wire nuts (Details Pg. 15)
- Air-Tite™ code compliant (Details Pg. 15)

Socket

- Porcelain socket with nickel plated brass screw shell
- Snap-in springs secure socket to socket plate, and may be detached when using socket supporting trims
- Shipped with socket overspray protector installed

Thermal Protector

Self resetting thermal protector deactivates fixture if overheating occurs due to improper lamping or misapplied insulation

Trims

Halo Fit-All concept offers multiple trim options in a variety of design styles, and functional beam distributions to control beam angle and lumen delivery in accommodating various lamp types including Halogen, CFL and LED

Quick Connect™ Wiring Tray

- (3) Color coded push-in wire nuts included
- Captive tray holds push-nuts in place for one-handed connections to line, neutral & ground
- Speeds installation and increases reliability
- No additional wire nuts required

Compliance

- cULus Listed 1598 luminaire
- cULus Listed damp location
- cULus Listed for wet location, covered ceiling, with select trims
- cULus Listed for direct contact with insulation and combustible material*
- Air-Tite code compliant. Certified under ASTM E283; not exceeding 2.0 cfm (0.944 L/s) air leakage rate tested at a 1.57 psf (75 Pa) pressure differential.
- RoHS compliant

*Not to be used in direct contact with spray foam insulation (Consult NEMA LSD57-2013)

Reflectors

426 Reflector Cone

- Accepts a wide variety of lamps
- Coil spring retention
- Removable trim ring
- Accessories available: TRM6 designer trim rings, OT403 oversize trim ring

Housings Max Lamp Compatibility

Housings	Max Lamp Compatibility
H27ICAT	50W PAR30S, 75W PAR30L,
H27RICAT	65W BR30, 75W R30
E27ICAT	50W PAR30S, 75W PAR30L,
E27RICAT	65W BR30

Compatible with Halogen, Incandescent, LED* or CFL* lamps



426
Clear Specular Reflector
Cone, White Trim



426MB
Black Specular Reflector
Cone, White Trim



426H
Haze Reflector Cone,
White Trim



426SN
Satin Nickel Reflector
Cone, Satin Nickel Trim



426TBZ
Tuscan Bronze Reflector
Cone, Tuscan Bronze Trim



H930 (H7 Housings ONLY) PAR lamp aiming accessory for 310 and 426 trims. Allows 30° tilt and 358° rotation. 50W PAR30.

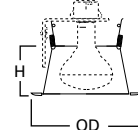

Dimensions**
H: 2-5/8" [67mm]
OD: 7-1/4" [184mm]

6106 Straight Reflector Cone, Self-flange

- Straight sides of cone reflector for large diameter, as well as BR30 and PAR30 lamps
- Self-flange reflector cone
- Coil spring retention
- Self-flange trim ring sized to hide gaps caused by construction tolerances



6106SC
Specular Clear Reflector,
White Self-flange

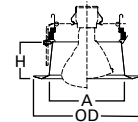

Dimensions**
A: 5-3/8" [137mm]
H: 2-5/8" [68mm]
OD: 7-3/4" [197mm]

Housings Max Lamp Compatibility

Housings	Max Lamp Compatibility
H27ICAT E27ICAT	50W PAR30S, 75W PAR30L,
H27RICAT E27RICAT	60W BR30

Compatible with Halogen, Incandescent, LED* or CFL* lamps

6107 Tapered Reflector, Self-flange

- Self-flange reflector cone
- Contoured tapered sides of cone reflector for BR30 and PAR30 lamps
- Coil spring retention
- Self-flange trim ring sized to hide gaps caused by construction tolerances



6107SC
Specular Clear Reflector,
White Self-flange

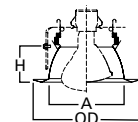

Dimensions**
A: 5-3/8" [137mm]
H: 2-5/8" [65mm]
OD: 7-3/4" [197mm]

Housings Max Lamp Compatibility

Housings	Max Lamp Compatibility
H27ICAT E27ICAT	50W PAR30S, 75W PAR30L,
H27RICAT E27RICAT	65W BR30

Compatible with Halogen, Incandescent, LED* or CFL* lamps

*UL1993 listed LED & CFL equivalent lamps permitted. Consult lamp manufacturer for conditions of use. Eaton does not warranty the lamp.

**Key: A: Luminous Aperture, H: Height, OD: Trim Outside Diameter

E26 Screw Base Trims

IC Shallow Housings: H27ICAT • H27RICAT • E27ICAT • E27RICAT

6
INCH



6121 Shallow Full Cone Reflector, Self-flange

- Shallow full cone reflector for A19, PAR30S and BR30 lamps
- Torsion spring retention
- Self-flange trim ring sized to hide gaps caused by construction tolerances



6121WH
White Reflector, White Self-flange

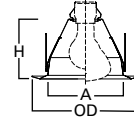

Dimensions**
A: 5-3/8" [137mm]
H: 4-3/8" [110mm]
OD: 7-3/4" [197mm]

Housings		Max Lamp Compatibility
H27ICAT	E27ICAT	40W A19, 60W PAR30S,
H27RICAT	E27RICAT	75W PAR30L, 65W BR30

Compatible with Halogen, Incandescent, LED* or CFL* lamps

Baffles

310 Coilex® Baffle

- Black or white phenolic Coilex baffle with white metal trim ring
- Removable trim ring
- Accessories available: TRM6 designer trim rings, OT403 oversize trim ring
- Coil spring retention



310W
White Coilex Baffle,
White Trim



310P
Black Coilex Baffle,
White Trim



310SN
Satin Nickel Coilex Baffle,
Satin Nickel Trim



310TBZ
Tuscan Bronze Coilex Baffle,
Tuscan Bronze Trim

Housings		Max Lamp Compatibility
H27ICAT		
H27RICAT		50W PAR30S, 75W PAR30L,
E27ICAT		65W BR30
E27RICAT		

Compatible with Halogen, Incandescent, LED* or CFL* lamps

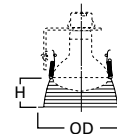

Dimensions**
H: 3-1/16" [78mm]
OD: 7-1/4" [184mm]

353 Metal Baffle

- Metallic finish trim rings and baffles
- Coil spring retention
- Removable trim ring



353SN
Satin Nickel Baffle,
Satin Nickel Trim



353TBZ
Tuscan Bronze Baffle,
Tuscan Bronze Trim

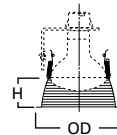

Dimensions**
H: 3" [76mm]
OD: 7-1/4" [184mm]

Housings		Max Lamp Compatibility
H27ICAT		
H27RICAT		50W PAR30S, 75W PAR30L,
E27ICAT		65W BR30
E27RICAT		

Compatible with Halogen, Incandescent, LED* or CFL* lamps

*UL1993 listed LED & CFL equivalent lamps permitted. Consult lamp manufacturer for conditions of use. Eaton does not warranty the lamp.

**Key: A: Luminous Aperture, H: Height, OD: Trim Outside Diameter

6100 Tapered Metal Baffle with (2) Trim Rings

- Contoured tapered sides of metal baffle for BR30 and PAR30 lamps
- Two plastic removable trim rings included narrow 7.25" OD and wide oversized 8.00" OD
- Coil spring retention

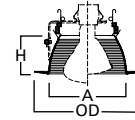

Dimensions**

A: 5-3/4" [148mm]
 H: 2-7/8" [74mm]
 OD: 7-1/4" [184mm] Narrow
 OD: 8" [203mm] Wide

Housings **Max Lamp Compatibility**

H27ICAT	E27ICAT	50W PAR30S, 75W PAR30L,
H27RICAT	E27RICAT	65W BR30

Compatible with Halogen, Incandescent, LED* or CFL* lamps

6100WB
 White Baffle, Narrow & Wide
 White Trims (Included)

6100BB
 Black Baffle, Narrow & Wide
 White Trims (Included)

6101 Straight Metal Baffle with (2) Trim Rings

- Straight sides of metal baffle for large diameter lamps
- Two plastic removable trim rings included narrow 7.25" OD and wide 8.00" OD
- Coil spring retention

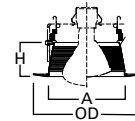

Dimensions**

A: 5-5/8" [144mm]
 H: 2-5/8" [66mm]
 OD: 7-1/4" [184mm] Narrow
 OD: 8" [203mm] Wide

Housings **Max Lamp Compatibility**

H27ICAT	E27ICAT	50W PAR30S, 75W PAR30L,
H27RICAT	E27RICAT	60W BR30

Compatible with Halogen, Incandescent, LED* or CFL* lamps

6101WB
 White Baffle, Narrow & Wide
 White Trim (Included)

6101BB
 Black Baffle, Narrow & Wide
 White Trim (Included)

6102 Tapered Metal Baffle, Self-flange

- Contoured tapered sides of metal baffle
- Coil spring retention
- Self-flange trim ring sized to hide gaps caused by construction tolerances

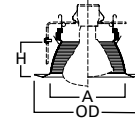

Dimensions**

A: 5-3/8" [137mm]
 H: 2-5/8" [65mm]
 OD: 7-3/4" [197mm]

Housings **Max Lamp Compatibility**

H27ICAT	E27ICAT	50W PAR30S, 75W PAR30L,
H27RICAT	E27RICAT	65W BR30

Compatible with Halogen, Incandescent, LED* or CFL* lamps

6102WB
 White Baffle, White Self-flange

6102BB
 Black Baffle, White Self-flange

6103 Straight Metal Baffle, Self-flange

- Straight sides of metal baffle for large diameter lamps
- Coil spring retention
- Self-flange trim ring sized to hide gaps caused by construction tolerances

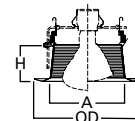

Dimensions**

A: 5-3/8" [137mm]
 H: 2-5/8" [68mm]
 OD: 7-3/4" [197mm]

Housings **Max Lamp Compatibility**

H27ICAT	E27ICAT	50W PAR30S, 75W PAR30L,
H27RICAT	E27RICAT	60W BR30

Compatible with Halogen, Incandescent, LED* or CFL* lamps

6103WB
 White Baffle, White Self-flange

6103BB
 Black Baffle, White Self-flange

*UL1993 listed LED & CFL equivalent lamps permitted. Consult lamp manufacturer for conditions of use. Eaton does not warranty the lamp.

Key: **A: Luminous Aperture, **H:** Height, **OD:** Trim Outside Diameter

E26 Screw Base Trims

IC Shallow Housings: H27ICAT • H27RICAT • E27ICAT • E27RICAT

6
INCH

6108 Coilex® Straight Plastic Baffle, Self-flange

- Straight sides of Coilex baffle for large diameter BR30 and PAR30 lamps
- Coil spring retention
- Self-flange trim ring sized to hide gaps caused by construction tolerances



6108WB
White Plastic Straight Coilex Baffle, White Self-flange



6108BB
Black Plastic Straight Coilex Baffle, White Self-flange



6108BKBB
Black Plastic Straight Coilex Baffle, Black Self-flange

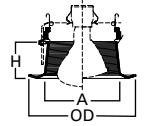

Dimensions**
A: 5-3/8" [137mm]
H: 2-5/8" [68mm]
OD: 7-3/4" [197mm]

Housings		Max Lamp Compatibility
H27ICAT	E27ICAT	39W PAR30S, 60W PAR30L,
H27RICAT	E27RICAT	50W BR30

Compatible with Halogen, Incandescent, LED* or CFL* lamps

6109 Coilex® Tapered Baffle, Self-flange

- Contoured tapered sides of Coilex baffle for BR30 and PAR30 lamps
- Coil spring retention
- Self-flange trim ring sized to hide gaps caused by construction tolerances



6109WB
White Plastic Tapered Coilex Baffle, White Self-flange



6109BB
Black Plastic Tapered Coilex Baffle, White Self-flange



6109BKBB
Black Plastic Tapered Coilex Baffle, Black Self-flange

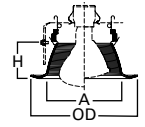

Dimensions**
A: 5-3/8" [137mm]
H: 2-5/8" [65mm]
OD: 7-3/4" [197mm]

Housings		Max Lamp Compatibility
H27ICAT	E27ICAT	50W PAR30S, 75W PAR30L,
H27RICAT	E27RICAT	65W BR30

Compatible with Halogen, Incandescent, LED* or CFL* lamps

6110 Perfetex™ Baffle, Self-flange

- Perforated pattern baffle contoured for BR30 and PAR30 lamps
- Coil spring retention
- Self-flange trim ring sized to hide gaps caused by construction tolerances



6110WB
White Perfetex Baffle, White Self-flange



6110BB
Black Perfetex Baffle, White Self-flange



6110BKBB
Black Perfetex Baffle, Black Self-flange

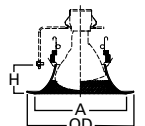

Dimensions**
A: 6-5/8" [169mm]
H: 2-1/8" [54mm]
OD: 7-3/4" [197mm]

Housings		Max Lamp Compatibility
H27ICAT	E27ICAT	50W PAR30S, 60W PAR30L,
H27RICAT	E27RICAT	50W BR30

Compatible with Halogen, Incandescent, LED* or CFL* lamps

6126 Shallow Full Cone Baffle, Self-flange

- Shallow full cone baffle for A19 and PAR30S lamps
- Torsion spring retention
- Socket supporting baffle
- Self-flange trim ring sized to hide gaps caused by construction tolerances



6126WB
White Baffle, White Self-flange



6126BB
Black Baffle, White Self-flange

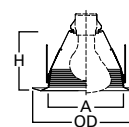

Dimensions**
A: 5-3/8" [137mm]
H: 4-3/8" [110mm]
OD: 7-3/4" [197mm]

Housings		Max Lamp Compatibility
H27ICAT	E27ICAT	40W A19, 60W PAR30S,
H27RICAT	E27RICAT	75W PAR30L, 65W BR30

Compatible with Halogen, Incandescent, LED* or CFL* lamps

airAGE
LED

*UL1993 listed LED & CFL equivalent lamps permitted. Consult lamp manufacturer for conditions of use. Eaton does not warranty the lamp.

**Key: A: Luminous Aperture, H: Height, OD: Trim Outside Diameter

Adjustable – Eyeballs & Gimbals

74 Eyeball 30° Tilt, Self-flange

- Provides optimum position for PAR30S lamps
- Torsion spring retention
- Socket supporting eyeball



74P
White Eyeball & Trim

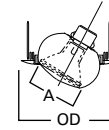

Dimensions**
A: 3-7/8" [98mm]
OD: 8" [203mm]

Housings	Max Lamp Compatibility
H27ICAT E27ICAT	75W PAR30S
H27RICAT E27RICAT	

Compatible with Halogen, Incandescent, LED* or CFL* lamps

78 Eyeball 30° Tilt, Self-flange

- 30° tilt, 360° rotation
- Torsion spring retention
- Wide choice of finishes for any decor
- Socket supporting eyeball
- 78PAT makes installation Air-Tite regardless of housing used



78P
White Eyeball, White Trim



78PAT
White Eyeball, White Trim



78SN
Satin Nickel Eyeball,
Satin Nickel Trim



78TBZ
Tuscan Bronze Eyeball,
Tuscan Bronze Trim

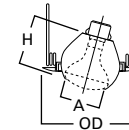

Dimensions**
A: 4" [100mm]
H: 4-1/8" [105mm]
OD: 8" [203mm]

Housings	Max Lamp Compatibility
H27ICAT	75W PAR30L, 65W BR30, 75W R30
H27RICAT	
E27ICAT	75W PAR30L, 65W BR30
E27RICAT	

Compatible with Halogen, Incandescent, LED* or CFL* lamps

420 Regressed Eyeball 30° Tilt, Self-flange

- Regressed eyeball with baffle splay
- Removable trim ring
- Accessories available: TRM6 designer trim rings, OT403 oversize trim ring
- Socket supporting eyeball



420W
White Eyeball & Baffle,
White Trim



420P
White Eyeball & Black Baffle,
White Trim

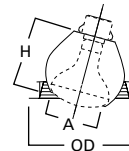

Dimensions**
A: 4" [100mm]
H: 4" [102mm]
OD: 7-1/4" [184mm]

Housings	Max Lamp Compatibility
H27ICAT	50W PAR30S, 50W PAR30L, 60W BR30
H27RICAT	
E27ICAT	
E27RICAT	

Compatible with Halogen, Incandescent, LED* or CFL* lamps

6130 Eyeball 35° Tilt, Self-flange

- 35° tilt, 360° rotation
- Adjustable eyeball trim for BR30 and PAR30 lamps
- Torsion spring retention
- Socket supporting eyeball
- Self-flange trim ring sized to hide gaps caused by construction tolerances



6130WH
White Eyeball, White Self-flange

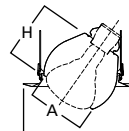

Dimensions**
A: 3-7/8" [100mm]
H: 3-7/8" [100mm]
OD: 7-3/4" [197mm]

Housings	Max Lamp Compatibility
H27ICAT E27ICAT	75W PAR30L, 65W BR30
H27RICAT E27RICAT	

Compatible with Halogen, Incandescent, LED* or CFL* lamps

*UL1993 listed LED & CFL equivalent lamps permitted. Consult lamp manufacturer for conditions of use. Eaton does not warranty the lamp.

**Key: A: Luminous Aperture, H: Height, OD: Trim Outside Diameter

E26 Screw Base Trims

IC Shallow Housings: H27ICAT • H27RICAT • E27ICAT • E27RICAT

6
INCH

6215 Double Gimbal 30°-50° Tilt, Self-flange

- 30°-50° tilt, 360° rotation
- 50° tilt with double gimbal design using compound angles
- Double gimbal for PAR30S lamps
- Torsion spring retention
- Shallow housings are compatible with PAR30S (short-neck) lamps
- Socket supporting gimbal
- Self-flange trim ring sized to hide gaps caused by construction tolerances



6215WH
White Gimbal,
White Self-flange



6215BK
Black Gimbal,
Black Self-flange



6215SN
Satin Nickel Gimbal,
Satin Nickel Self-flange



6215TBZ
Tuscan Bronze Gimbal,
Tuscan Bronze Self-flange

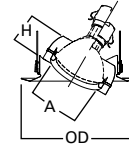

Dimensions**
A: 3-3/8" [84mm]
H: 2" [51mm]
OD: 7-3/4" [197mm]

Housings Max Lamp Compatibility

H27ICAT	E27ICAT	60W PAR30S
H27RICAT	E27RICAT	

Compatible with Halogen, Incandescent, LED* or CFL* lamps

Lenses & Wet Location Showerlights

170 Albalite Lens with Reflector

- White trim with Albalite glass lens
- PS version features non-conductive, non-corrosive gasketed polymer (plastic) trim ring
- PS version is "dead-front" construction and is wet location listed for use in showers
- Torsion spring retention
- PS version is Air-Tite; making any installation Air-Tite



170P
Albalite Lens, White Trim



170PS
Albalite Lens, Polymer White Trim

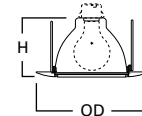

Dimensions**
H: 4" [102mm]
OD: 8" [203mm]

Housings Max Lamp Compatibility

H27ICAT	35W PAR30L
H27RICAT	40W A19
E27ICAT	29W A19
E27RICAT	

Compatible with Halogen, Incandescent, LED* or CFL* lamps

171 Drop Opal Glass Lens with Reflector

- White trim with drop opal glass lens
- PS version features non-conductive, non-corrosive gasketed polymer (plastic) trim ring
- PS version features "dead-front" construction and is wet location listed for use in showers
- Torsion spring retention
- PS version is Air-Tite; making any installation Air-Tite



171P
Drop Opal Lens, White Trim



171PS
Drop Opal Lens, White Polymer Trim

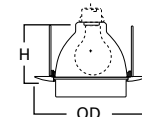

Dimensions**
H: 4" [102mm]
OD: 8" [203mm]

Housings Max Lamp Compatibility

H27ICAT	40W A19
H27RICAT	
E27ICAT	29W A19
E27RICAT	

Compatible with Halogen, Incandescent, LED* or CFL* lamps

172 Dome Glass Lens with Reflector

- Frosted glass dome
- Features "dead-front" construction and is wet location listed for use in showers
- Non-conductive, non-corrosive gasketed polymer (plastic) trim ring
- Torsion spring retention
- Air-Tite trim makes any installation Air-Tite



172PS
Frosted Glass Dome,
White Polymer Trim



172TBZ
Frosted Glass Dome,
Tuscan Bronze Polymer Trim

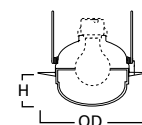

Dimensions**
H: 2-1/8" [54mm]
OD: 7-3/4" [197mm]



Housings Max Lamp Compatibility

H27ICAT	60W A19, 50W PAR30S
H27RICAT	
E27ICAT	43W A19
E27RICAT	

Compatible with Halogen, Incandescent, LED* or CFL* lamps

*UL1993 listed LED & CFL equivalent lamps permitted. Consult lamp manufacturer for conditions of use. Eaton does not warranty the lamp.

**Key: A: Luminous Aperture, H: Height, OD: Trim Outside Diameter

Specifications, compliances and dimensions subject to change without notice

173 Fresnel Lens with Reflector

- White trim with glass Fresnel lens
- PS version features non-conductive, non-corrosive gasketed polymer (plastic) trim ring
- PS version is "dead-front" construction and is wet location listed for use in showers
- Torsion spring retention
- PS version is Air-Tite; making any installation Air-Tite



173P
Fresnel Lens, White Trim



173PS
Fresnel Lens, White Polymer Trim

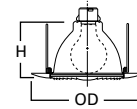

Dimensions**
H: 4" [102mm]
OD: 8" [203mm]



Housings Max Lamp Compatibility

H27ICAT	E27ICAT	40W A19, 35W PAR30L
E27ICAT		35W PAR30L

Compatible with Halogen, Incandescent, LED* or CFL* lamps

6145 Open Wet Location, Shallow Reflector, Self-flange

- Open wet location shallow Showerlight for PAR30S and PAR38 outdoor rated lamps ONLY
- Torsion spring retention
- Socket supporting cone
- Self-flange trim ring sized to hide gaps caused by construction tolerances



6145WH
White Shallow Reflector,
White Self-flange



6145SN
Satin Nickel Shallow Reflector,
Satin Nickel Self-flange



6145TBZ
Tuscan Bronze Shallow Reflector,
Tuscan Bronze Self-flange

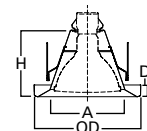

Dimensions**
A: 5-3/8" [136mm]
D: 7/8" [22mm]
H: 4-7/8" [123mm]
OD: 7-3/4" [197mm]

Housings Max Lamp Compatibility

H27ICAT	E27ICAT	75W PAR30S, 75W PAR30L,
H27RICAT	E27RICAT	80W PAR38

Compatible with Halogen, Incandescent, LED* or CFL* lamps



Lamp Gasket
(Included)



6150 Low Profile, Frosted Glass Dome Lens, Self-flange

- Low profile, frosted glass dome lens
- Wet location Showerlight
- Torsion spring retention
- Non-conductive "dead-front" polymer (plastic) trim ring and glass lens
- Socket supporting internal reflector
- Self-flange trim ring sized to hide gaps caused by construction tolerances



6150WH
Frosted Glass Dome Lens
with Reflector, White
Plastic Self-flange



6150SN
Frosted Glass Dome Lens
with Reflector, Satin Nickel
Plastic Self-flange



6150TBZ
Frosted Glass Dome Lens
with Reflector, Tuscan Bronze
Plastic Self-flange

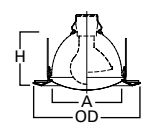

Dimensions**
A: 5-1/8" [130mm]
H: 4-1/5" [107mm]
OD: 7-3/4" [197mm]

Housings Max Lamp Compatibility

H27ICAT	E27ICAT	29W A19, 39W PAR30S
H27RICAT	E27RICAT	

Compatible with Halogen, Incandescent, LED* or CFL* lamps



6162 Drop Opal Plastic Lens, Self-flange

- Wet location Showerlight
- Non-conductive "dead-front" polymer (plastic) trim and lens
- Torsion spring retention
- Socket supporting internal reflector
- Self-flange trim ring sized to hide gaps caused by construction tolerances



6162WH
Drop Opal Plastic Lens
with Reflector, Frosted
Plastic Self-flange

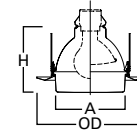

Dimensions**
A: 5-1/8" [130mm]
H: 3-7/8" [122mm]
OD: 7-3/4" [197mm]

Housings Max Lamp Compatibility

H27ICAT	E27ICAT	29W A19
H27RICAT	E27RICAT	

Compatible with Halogen, Incandescent, LED* or CFL* lamps



*UL1993 listed LED & CFL equivalent lamps permitted. Consult lamp manufacturer for conditions of use. Eaton does not warranty the lamp.

**Key: A: Luminous Aperture, H: Height, OD: Trim Outside Diameter

E26 Screw Base Trims

IC Shallow Housings: H27ICAT • H27RICAT • E27ICAT • E27RICAT

6
INCH



6230 Squirrel Frost Glass Lens, Metal Trim, Self-flange

- Low profile frost glass lens
- Wet location Showerlight
- Torsion spring retention
- Self-flange low profile metal trim ring
- Socket supporting internal bracket
- Integral rotation adjustment up to +/- 25° for precise alignment with room



6230AH
Frost Glass Lens, Aluminum Haze Squirrel Trim



6230PN
Frost Glass Lens, Polished Nickel Squirrel Trim



6230SN
Frost Glass Lens, Satin Nickel Squirrel Trim

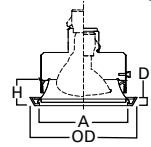

Dimensions**
A: 6" [152mm]
H: 4-1/4" [109mm]
D: 3/4" [20mm]
OD: 7-1/4" [185mm]

Housings Max Lamp Compatibility

H27ICAT	E27ICAT	29W A19
H27RICAT	E27RICAT	

Compatible with Halogen, Incandescent, LED* or CFL* lamps

6255 Soft Square, Frost Curved Glass Lens, Self-flange

- Low profile curved frost glass lens
- Wet location Showerlight
- Torsion spring retention
- Non-conductive "dead-front" polymer (plastic) trim ring and glass lens
- Integral rotation adjustment up to +/- 25° for precise alignment with room
- Integrated socket supporting reflector for even illumination across lens corner-to-corner



6255WH
Frost Curved Glass Lens with Reflector, White Plastic Self-flange



6255SN
Frost Curved Glass Lens with Reflector, Satin Nickel Plastic Self-flange



6255TBZ
Frost Curved Glass Lens with Reflector, Tuscan Bronze Plastic Self-flange

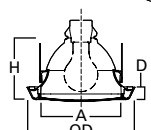

Dimensions**
A: 5-7/8" [149mm]
D: 1" [25mm]
H: 4-1/2" [114mm]
OD: 7-5/8" [194mm]

Housings Max Lamp Compatibility

H27ICAT	E27ICAT	29W A19
H27RICAT	E27RICAT	

Compatible with Halogen, Incandescent, LED* or CFL* lamps

Open, Splay & Wall Wash

300 Open Trim with Fixed Socket Bracket

- Open trim for BR30 and PAR30 lamps
- Torsion spring retention
- Socket supporting internal bracket



300P
Socket Bracket with White Open Trim



300SN
Socket Bracket with Satin Nickel Open Trim



300TBZ
Socket Bracket with Tuscan Bronze Open Trim

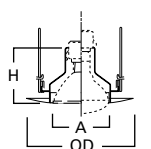

Dimensions**
A: 4-3/4" [122mm]
H: 4-3/4" [122mm]
OD: 7-1/4" [184mm]

Housings Max Lamp Compatibility

H27ICAT	75W PAR30S, 50W PAR30L, 60W BR30
H27RICAT	75W PAR30S, 60W BR30
E27ICAT	300P: 60W PAR30S, 60W PAR30L, 60W BR30
E27RICAT	300SN, 300TBZ: 60W PAR30S, 60W PAR30L, 50W BR30

Compatible with Halogen, Incandescent, LED* or CFL* lamps

328 White Splay Trim

- Splay trim for BR30 and PAR30 lamps
- Coil spring retention



328P
White Splay Trim

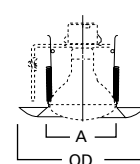

Dimensions**
H: 3-7/8" [98mm]
OD: 7-3/4" [197mm]

Housings Max Lamp Compatibility

H27ICAT	
H27RICAT	50W PAR30S, 75W PAR30L, 65W BR30
E27ICAT	
E27RICAT	

Compatible with Halogen, Incandescent, LED* or CFL* lamps

*UL1993 listed LED & CFL equivalent lamps permitted. Consult lamp manufacturer for conditions of use. Eaton does not warranty the lamp.

**Key: A: Luminous Aperture, H: Height, OD: Trim Outside Diameter

Trim Series #	Style	H7T	H7TCP	H7RT	E7TAT	E7RTAT	H7TNB	E7TATNB	H27T	H27RT	E27TAT	E27RTAT
30	Reflector & Baffle	•	•	•	•	•	•	•	—	—	—	—
70	Showerlight	•	•	•	•	•	—	—	•	—	•	—
71	Showerlight	•	•	•	•	•	—	—	•	—	•	—
73	Showerlight	•	•	•	•	•	—	—	•	—	•	—
74	Adjustable	•	—	•	•	•	•	•	•	•	•	•
76	Adjustable	•	•	•	•	•	•	•	—	—	—	—
78	Adjustable	•	•	•	•	•	•	•	•	•	•	•
79	Pinhole	•	•	—	•	—	—	—	•	•	•	•
170	Showerlight	•	—	•	•	•	•	•	•	•	•	•
171	Showerlight	•	—	•	•	•	•	•	•	•	•	•
172	Showerlight	•	—	•	•	•	•	•	•	•	•	•
173	Showerlight	•	—	•	•	•	•	•	•	•	•	•
300	Open	•	—	—	•	—	—	—	—	—	—	—
301	Open	•	•	•	•	•	—	—	•	•	•	•
303	Wall Wash	•	•	•	•	•	—	—	—	—	—	—
310	Baffle	•	•	•	•	•	—	—	•	•	•	•
328	Splay	•	•	•	•	•	—	—	•	•	•	•
353	Baffle	•	—	•	•	•	—	—	•	•	•	•
376	Adjustable	•	•	•	•	•	•	•	•	•	•	•
378	Adjustable	•	•	•	•	—	•	•	•	•	•	—
401	Open	•	•	•	•	•	—	—	—	—	—	—
405	Reflector	•	•	•	•	•	•	•	—	—	—	—
410	Baffle	•	•	•	•	•	—	—	—	—	—	—
419	Adjustable	•	•	•	•	•	•	•	•	•	•	•
420	Adjustable	•	—	•	•	•	•	•	•	•	•	•
424	Wall Wash	•	•	•	•	•	—	—	—	—	—	—
425	Wall Wash	•	•	•	•	•	—	—	—	—	—	—
426	Reflector	•	•	•	•	•	—	—	•	•	•	•
428	Splay	•	•	•	•	•	—	—	—	—	—	—
429	Reflector	•	•	•	•	•	—	—	—	—	—	—
430	Wall Wash	•	—	—	•	—	•	•	—	—	—	—
478	Adjustable	•	•	•	•	•	•	•	—	—	—	—
1412	Adjustable	•	—	•	•	—	—	—	—	—	—	—
1416	Reflector & Baffle	•	—	•	•	—	—	—	—	—	—	—
1417	Adjustable	•	•	•	•	—	—	—	—	—	—	—
1450	Slot	•	—	•	—	—	—	—	—	—	—	—
1475	Adjustable	•	—	•	•	•	—	—	—	—	—	—
1479	Pinhole	•	•	•	•	•	—	—	—	—	—	—
4051	Reflector	•	—	•	•	•	•	•	—	—	—	—
4261	Reflector	•	—	•	•	•	—	—	•	•	•	•
30SBAT	Reflector	•	—	•	•	•	•	•	—	—	—	—

E26 Screw Base Non-Insulated Ceiling housings & Trims

Quick Reference – Non-IC

6
INCH

Trim Series #	Style	H7T	H7TCP	H7RT	E7TAT	E7RTAT	H7TNB	E7TATNB	H27T	H27RT	E27TAT	E27RTAT
6100	Baffle	•	•	•	•	•	—	—	•	•	•	•
6101	Baffle	•	•	•	•	•	—	—	•	•	•	•
6102	Baffle	•	•	•	•	•	—	—	•	•	•	•
6103	Baffle	•	•	•	•	•	—	—	•	•	•	•
6106	Reflector	•	•	•	•	•	—	—	•	•	•	•
6107	Reflector	•	•	•	•	•	—	—	•	•	•	•
6108	Baffle	•	•	•	•	•	—	—	•	•	•	•
6109	Baffle	•	•	•	•	•	—	—	•	•	•	•
6110	Baffle	•	•	•	•	•	—	—	•	•	•	•
6120	Reflector	•	•	•	•	•	•	•	—	—	—	—
6121	Reflector	•	—	•	•	•	•	•	•	•	•	•
6125	Baffle	•	•	•	•	•	•	•	—	—	—	—
6126	Baffle	•	—	•	•	•	•	•	•	•	•	•
6130	Adjustable	•	•	•	•	•	•	•	•	•	•	•
6145	Open Showerlight	•	•	•	•	•	•	•	•	•	•	•
6146	Open Showerlight	•	•	•	•	•	•	•	—	—	—	—
6150	Showerlight	•	•	•	•	•	•	•	•	•	•	•
6160	Showerlight	•	•	•	•	•	—	—	•	—	•	—
6170	Adjustable	•	•	•	•	•	•	•	—	—	—	—
6215	Adjustable	•	•	•	•	•	•	•	•	•	•	•
6222	Adjustable	•	•	•	•	•	•	•	—	—	—	—
6230	Showerlight	•	•	•	•	•	•	•	•	•	•	•
6255	Showerlight	•	•	•	•	•	•	•	•	•	•	•



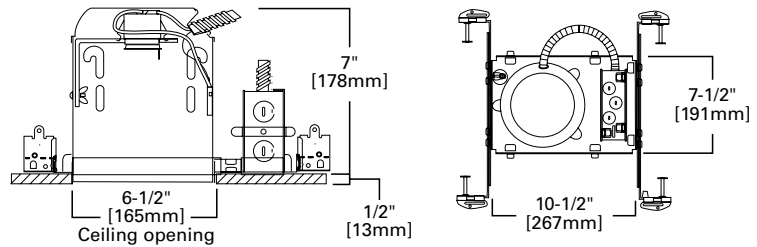

H7T

6" Non-IC, New Construction, 120V

The H7 recessed housing is the standard in the industry for both light commercial and residential applications. H7 series features full-frame design, robust construction, feed-through listing, Got Nail! bar hangers; and may support use of higher wattage lamps. A wide variety of trims allows a number of different lighting effects to be created with one basic housing. The H7T is for use in non-insulated ceilings. If ceiling insulation is present, it must be kept 3" from all sides of housing. May be retrofit with compatible Halo LED lighting systems.



Special Features

- Got Nail!™ bar hangers
- q-Channel bars with Pass-N-Thru™
- Slide-N-Side™ junction box
- Quick Connect™ push wire nuts

Compatible Trims

30°	172 ^ø	378	428	1479	6108	6146
70	173	401	429	4051	6109	6150
71	300	405	430 ^ø	4261	6110	6160
73	301	410	478	6100	6120 ^ø	6170
74	303	419	1412	6101	6121 ^ø	6215
76	310	420	1416	6102	6125 ^ø	6222
78 ^ø	328	424	1417	6103	6126 ^ø	6230
79	353	425	1450	6106	6130	6255
170	376	426	1475	6107	6145	30SBAT ^ø
171						



Trims for use in Halo listed housings



Select trims are classified for use in other housings, see www.cooperlighting.com/legal

◊ Air-Tite trims can make the H7T installation ASTM E283 compliant (in a non-insulated ceiling)

Features

Housing

- Single wall die-stamped CRS housing
- White housing paint finish

Socket Plate

- Rigid socket plate adjusts and locks without tools for various lamp sizes
- Socket plate and bracket may be removed when using socket supporting trims

Plaster Frame

- The housing can be removed from plaster frame to provide access to the junction box
- Galvanized steel construction
- Housing adjusts in plaster frame to accommodate ceilings up to 1" – 3/8" thick
- Plaster frame features include:
 - Patented regressed locking screw positioned for securing hanger bars from below the ceiling
 - Cutouts for easily crimping hanger bars in position
 - Halo name embossed on plaster frame

Includes:

- Got Nail!™ bar hangers (Details Pg. 13)
- q-Channel bars with Pass-N-Thru™ (Details Pg. 13)
- Slide-N-Side™ junction box wire traps (Details Pg. 13)
- Quick Connect™ push wire nuts (Details Pg. 13)

Socket

- Porcelain socket with nickel plated brass screw shell
- Snap-in springs secure socket to socket plate, and may be detached when using socket supporting trims
- Overspray protector included

Thermal Protector

Self resetting thermal protector deactivates fixture if overheating occurs due to improper lamping or misapplied insulation

Trims

Halo Fit-All concept offers multiple trim options in a variety of design styles, and functional beam distributions to control beam angle and lumen delivery in accommodating various lamp types including Halogen, CFL and LED

Compliance

- cULus Listed 1598 luminaire
- cULus Listed damp location
- cULus Listed for wet location, covered ceiling, with select trims
- cULus Listed for feed through
- RoHS compliant
- IP rated (Improper Lamp)

E26 Screw Base Non-IC Housing

H7TCP

6
INCH

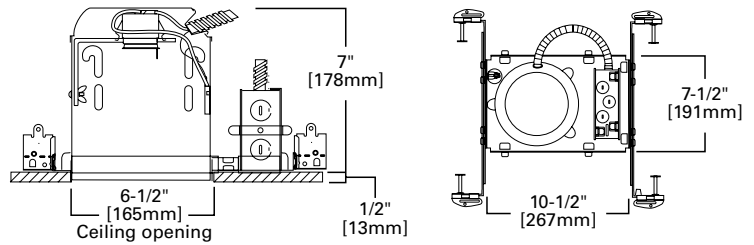

H7TCP

6" Non-IC, New Construction or Remodel, Chicago Plenum, 120V

The H7TCP recessed housing is designed for City of Chicago applications. The wide variety of trims available allows a number of different lighting effects to be created with one basic housing. The H7TCP is designed for non-insulated Chicago Plenum ceilings where insulation must be kept a minimum of 3" from all sides of housing. May be retrofit with compatible Halo LED lighting systems.



Special Features

Chicago Plenum

Compatible Trims

30	301	405	429	6103	6120	6160
70	303	410	478	6106	6125	6170
71	310	419	1417	6107	6130	6215
73	328	424	1479	6108	6145	6222
76	376	425	6100	6109	6146	6230
78	378	426	6101	6110	6150	6255
79	401	428	6102			



Trims for use in Halo listed housings



Select trims are classified for use in other housings, see www.cooperlighting.com/legal

Features

Housing

- Single wall CRS housing
- White housing paint finish
- Constructed and gasketed to meet Chicago CCEA requirements

Plaster Frame

- "Boat shaped" plaster frame design for new construction or remodel in existing ceilings
- Galvanized steel die-formed construction
- Housing adjusts in plaster frame to accommodate up to 1" ceiling thickness

Socket Plate

- Rigid socket plate adjusts and locks without tools for various lamp sizes
- Socket plate and bracket may be removed when using socket supporting trims

Socket

- Porcelain socket with nickel plated brass screw shell
- Snap-in socket speeds installation and attaches directly to the trim for consistent lamp positioning
- Overspray protector included

Thermal Protector

Self resetting thermal protector deactivates fixture if overheating occurs due to improper lamping or misapplied insulation

Trims

Halo Fit-All concept offers multiple trim options in a variety of design styles, and functional beam distributions to control beam angle and lumen delivery in accommodating various lamp types including Halogen, CFL and LED

Compliance

- cULus Listed 1598 luminaire
- cULus Listed damp location
- cULus Listed for wet location, covered ceiling, with select trims
- cULus Listed for feed through
- RoHS compliant
- IP rated (Improper Lamp)
- City of Chicago Environmental Air "Chicago Plenum" Compliant

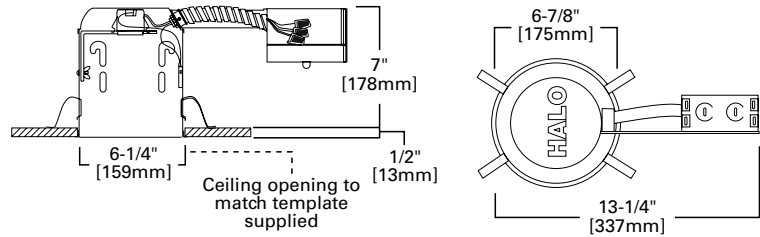

H7RT

6" Non-IC, Remodel, 120V

The H7 recessed remodel housing is the standard in the industry for both light commercial and residential applications. H7 series features full-frame design, robust construction, feed-through listing, Got Nail! bar hangers; and may support use of higher wattage lamps. A wide variety of trims allows a number of different lighting effects to be created with one basic housing. The H7RT is for use in non-insulated existing ceilings where the remodel housing slips through opening in finished ceiling. If ceiling insulation is present, it must be kept 3" from all sides of housing. May be retrofit with compatible Halo LED lighting systems.



Special Features

Quick Connect™ push wire nuts

Compatible Trims

30°	172	378	428	4051	6109	6150
70	173	401	429	4261	6110	6160
71	301	405	478	6100	6120°	6170
73	303	410	1412	6101	6121°	6215
74	310	419	1416	6102	6125°	6222
76	328	420	1417	6103	6126°	6230
78°	353	424	1450	6106	6130	6255
170	376	425	1475	6107	6145	30SBAT°
171		426	1479	6108	6146	



Trims for use in Halo listed housings



Select trims are classified for use in other housings, see www.cooperlighting.com/legal

◊ Air-Tite trims can make the H7RT installation ASTM E283 compliant (in a non-insulated ceiling)

Features

Housing

- Single wall die-stamped CRS shallow housing
- White housing paint finish
- For installation from below the finished ceiling. Integral flange secures fixture against ceiling.

Socket Plate

- Rigid socket plate adjusts and locks without tools for various lamp sizes
- Socket plate and bracket may be removed when using socket supporting trims

Remodel Springs

Four remodel springs secure housing and accommodate 1/2" and 5/8" ceiling material

Junction Box

- Seven 1/2" trade size conduit knockouts with true pry-out slots are positioned to accommodate straight conduit runs
- Four non-metallic (NM) cable pry-outs included

Includes:

- Quick Connect™ push wire nuts (Details Pg. 13)

Socket

- Porcelain socket with nickel plated brass screw shell
- Snap-in springs secure socket to socket plate, and may be detached when using socket supporting trims
- Overspray protector included

Thermal Protector

Self resetting thermal protector deactivates fixture if overheating occurs due to improper lamping or misapplied insulation

Trims

Halo Fit-All concept offers multiple trim options in a variety of design styles, and functional beam distributions to control beam angle and lumen delivery in accommodating various lamp types including Halogen, CFL and LED

Compliance

- cULus Listed 1598 luminaire
- cULus Listed damp location
- cULus Listed for wet location, covered ceiling, with select trims
- cULus Listed for feed through
- RoHS compliant
- IP rated (Improper Lamp)

E26 Screw Base Non-IC Housing

E7TAT

6
INCH

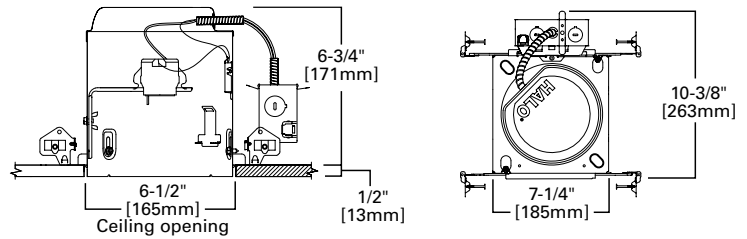

E7TAT

6" Non-IC, Air-Tite, New Construction Housing, 120V

The E7TAT is a compact and efficient recessed Non-IC housing optimized and listed for EISA compliant tungsten-halogen, CFL and LED lamps as well as incandescent. Housing is suitable for residential or light commercial applications. For installation in non-insulated ceilings; if ceiling insulation is present it must be kept 3" from all sides of housing. Housing features Air-Tite code compliant construction. Use with a variety of trims and finishes to create different lighting effects or to match any decor. May be retrofit with compatible Halo LED lighting systems.



Special Features

- All-Nail!™ bar hangers
- q-Channel bars with Pass-N-Thru™
- Hinged j-box with Slide-N-Side™
- Quick Connect™ push wire nuts
- Air-Tite™ code compliant

Compatible Trims

30	172	376	426	1479	6108	6146
70	173	378	428	4051	6109	6150
71	300	401	429	4261	6110	6160
73	301	405	430	6100	6120	6170
74	303	410	478	6101	6121	6215
76	310	419	1412	6102	6125	6222
78	328	420	1416	6103	6126	6230
79	353	424	1417	6106	6130	6255
170		425	1475	6107	6145	30SBAT
171						



Trims for use in Halo listed housings



Select trims are classified for use in other housings, see www.cooperlighting.com/legal

Features

Housing

- Single wall die-formed housing
- Housing features a precision rolled interlocking collar which maintains aperture geometry for greater assurance of installation results
- Exclusive Air-Tite gasket meets code where required, and seals between housing, frame and finished ceiling - without need for additional caulk
- May be removed from the plaster frame to provide access to junction box

Socket Plate

- Rigid socket plate adjusts and locks without tools for various lamp sizes
- Socket plate and bracket may be removed when using socket supporting trims

Plaster Frame

- Galvanized steel frame. Housing adjusts in plaster frame to accommodate up to 3/8" - 1" ceiling thickness.
- (2) Regressed locking screws for securing hanger bars

Includes:

- All-Nail!™ bar hangers (Details Pg. 15)
- q-Channel bars with Pass-N-Thru™ (Details Pg. 15)
- Hinged junction box with Slide-N-Side™ (Details Pg. 15)
- Quick Connect™ push wire nuts (Details Pg. 15)
- Air-Tite™ code compliant (Details Pg. 15)

Socket

- Porcelain socket with nickel plated brass screw shell
- Snap-in springs secure socket to socket plate, and may be detached when using socket supporting trims
- Shipped with socket overspray protector installed

Thermal Protector

Self resetting thermal protector deactivates fixture if overheating occurs due to improper lamping or misapplied insulation

Trims

Halo Fit-All concept offers multiple trim options in a variety of design styles, and functional beam distributions to control beam angle and lumen delivery in accommodating various lamp types including Halogen, CFL and LED

Compliance

- cULus Listed 1598 luminaire
- cULus Listed damp location
- cULus Listed for wet location, covered ceiling, with select trims
- Air-Tite code compliant. Certified under ASTM E283; not exceeding 2.0 cfm (0.944 L/s) air leakage rate tested at a 1.57 psf (75 Pa) pressure differential.
- RoHS compliant

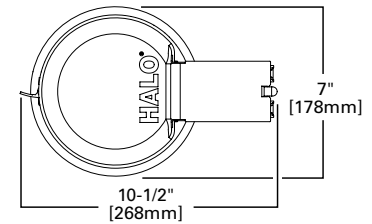
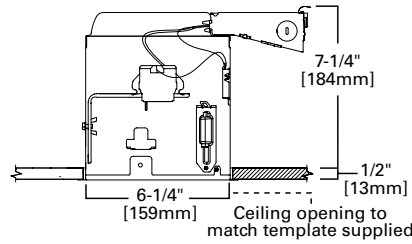

E7RTAT

6" Non-IC, Air-Tite, Remodel Housing, 120V

The E7RTAT is a compact and efficient recessed remodel Non-IC housing optimized and listed for EISA compliant, tungsten-halogen, CFL and LED lamps as well as incandescent. Housing is suitable for residential or light commercial applications. For installation in non-insulated ceilings, if ceiling insulation is present it must be kept 3" from all sides of housing. Housing features Air-Tite code compliant construction. Use with a variety of trims and finishes to create different lighting effects or to match any decor. May be retrofit with compatible Halo LED lighting systems.



Special Features

- Hinged j-box with Slide-N-Side™
- Quick Connect™ push wire nuts
- Air-Tite™ code compliant

Compatible Trims

30	172	376	426	6100	6110	6150
70	173	401	428	6101	6120	6160
71	301	405	429	6102	6121	6170
73	303	410	478	6103	6125	6215
74	310	419	1475	6106	6126	6222
76	328	420	1479	6107	6130	6230
78	353	424	4051	6108	6145	6255
170		425	4261	6109	6146	30SBAT
171						



Trims for use in Halo listed housings



Select trims are classified for use in other housings, see www.cooperlighting.com/legal

Features

Housing

- Single wall die-formed housing
- Die formed flange maintains aperture geometry for greater assurance of installation results
- Exclusive Air-Tite gasket meets code where required, and seals between housing, flange and finished ceiling - without need for additional caulk
- For installation from below the finished ceiling. Integral flange secures fixture against ceiling.

Remodel Retention System - Speed Clamps

- Exclusive two integral speed clamps securely lock housing to ceiling, accommodating 3/8" to 2" ceiling materials

Socket Plate

- Rigid socket plate adjusts and locks without tools for various lamp sizes
- Socket plate and bracket may be removed when using socket supporting trims

Includes:

- Hinged junction box with Slide-N-Side™ (Details Pg. 15)
- Quick Connect™ push wire nuts (Details Pg. 15)
- Air-Tite™ code compliant (Details Pg. 15)

Socket

- Porcelain socket with nickel plated brass screw shell
- Snap-in springs secure socket to socket plate, and may be detached when using socket supporting trims
- Shipped with socket overspray protector installed

Thermal Protector

Self resetting thermal protector deactivates fixture if overheating occurs due to improper lamping or misapplied insulation

Trims

Halo Fit-All concept offers multiple trim options in a variety of design styles, and functional beam distributions to control beam angle and lumen delivery in accommodating various lamp types including Halogen, CFL and LED

Quick Connect™ Wiring Tray

- (3) Color coded 4-port push-in wire nuts included
- Captive tray holds push-nuts in place for one-handed connections to line, neutral & ground
- Speeds installation and increases reliability
- No additional wire nuts required

Compliance

- cULus Listed 1598 luminaire
- cULus Listed damp location
- cULus Listed for wet location, covered ceiling, with select trims
- Air-Tite code compliant. Certified under ASTM E283; not exceeding 2.0 cfm (0.944 L/s) air leakage rate tested at a 1.57 psf (75 Pa) pressure differential.
- RoHS compliant

E26 Screw Base Trims

Non-IC Housings: H7T • H7TCP • H7RT • E7TAT • E7RTAT

6
INCH

Reflectors

30 Reflector, Self-flange

- Self-flange reflector with torsion spring retention
- Accepts a wide range of lamps
- Makes installation Air-Tite regardless of housing used
- Socket supporting reflector

Housings Max Lamp Compatibility

H7T	100W A19, 75W PAR30S, 75W PAR30L, 85W BR30, 100W R30, 150W PAR38
H7TCP	150W A21, 50W PAR30S, 75W PAR30L, 65W BR30, 75W R30, 150W PAR38
H7RT	100W A19, 150W A21, 75W PAR30S, 75W PAR30L, 150W PAR38, 65W BR30
E7TAT	100W A19, 150W A21, 50W PAR30S, 75W PAR30L, 150W PAR38, 65W BR30
E7RTAT	100W A19, 150W A21, 50W PAR30S, 75W PAR30L, 150W PAR38, 65W BR30

Compatible with Halogen, Incandescent, LED* or CFL* lamps



30HAT
Haze Reflector, White Trim



30RGAT
Residential Gold Reflector, White Trim



30CAT
Clear Specular Reflector, White Trim

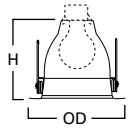

Dimensions**
H: 5" [127mm]
OD: 7-1/4" [184mm]



30SBAT Reflector, Self-flange

- Self-flange reflector with torsion spring retention
- Accepts a wide range of lamps
- Makes installation Air-Tite regardless of housing used
- Socket supporting reflector

Housings Max Lamp Compatibility

H7T	100W A19, 150W A21, 50W PAR30S, 75W PAR30L, 150W PAR38, 85W BR30, 100W R30
H7RT	150W A21, 50W PAR30S, 75W PAR30L, 65W BR30, 75W R30, 150W PAR38
E7TAT	100W A19, 150W A21, 75W PAR30S, 75W PAR30L, 150W PAR38, 65W BR30
E7RTAT	100W A19, 150W A21, 50W PAR30S, 75W PAR30L, 150W PAR38, 65W BR30

Compatible with Halogen, Incandescent, LED* or CFL* lamps



30SBAT
Specular Black Reflector & Trim

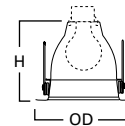

Dimensions**
H: 5" [127mm]
OD: 7-1/4" [184mm]



405 Specular Full Cone Reflector

- Full reflector for use with A-lamps
- Accessories available: TRM6 designer trim rings, OT403 oversize trim ring
- Friction clip retention on housing plaster ring
- Removable trim ring
- Socket supporting reflector

Housings Max Lamp Compatibility

H7T	
H7TCP	
H7RT	150W A21
E7TAT	
E7RTAT	

Compatible with Halogen, Incandescent, LED* or CFL* lamps



405SC
Specular Clear Reflector, White Trim



Friction Clips install on housing plaster ring

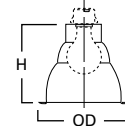

Dimensions**
H: 5" [127mm]
OD: 7-1/4" [184mm]

*UL1993 listed LED & CFL equivalent lamps permitted. Consult lamp manufacturer for conditions of use. Eaton does not warranty the lamp.

**Key: A: Luminous Aperture, H: Height, OD: Trim Outside Diameter

426 Reflector Cone

- Accepts a wide variety of lamps
- Coil spring retention
- Removable trim ring
- Accessories available: TRM6 designer trim rings, OT403 oversize trim ring

Housings	Max Lamp Compatibility
H7T	75W PAR30S, 150W PAR38, 65W BR30, 120W BR40,
H7TCP	75W R30, 150W R40
H7RT	75W PAR30S, 75W PAR30L, 65W BR30, 120W BR40, 75W R30, 150W R40
E7TAT	75W PAR30S, 150W PAR38, 65W BR30, 120W BR40
E7RTAT	75W PAR30S, 75W PAR30L, 65W BR30, 120W BR40

Compatible with Halogen, Incandescent, LED* or CFL* lamps



426
Clear Specular Reflector Cone, White Trim



426MB
Black Specular Reflector Cone, White Trim



426H
Haze Reflector Cone, White Trim



426SN
Satin Nickel Reflector Cone, Satin Nickel Trim



426TBZ
Tuscan Bronze Reflector Cone, Tuscan Bronze Trim



H930 (H7 Housings ONLY) PAR lamp aiming accessory for 310 and 426 trims. Allows 30° tilt and 358° rotation. 50W PAR30.

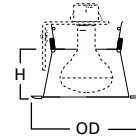

Dimensions**
H: 2-5/8" [67mm]
OD: 7-1/4" [184mm]

429 Dayform White Cone, Self-flange

- Contoured sides shield interior view of housing
- Removable trim ring
- Accessories available: TRM6 designer trim rings, OT403 oversize trim ring

Housings	Max Lamp Compatibility
H7T	75W PAR30S, 75W PAR30L,
H7TCP	65W BR30, 75W R30
H7RT	
E7TAT	75W PAR30S, 75W PAR30L,
E7RTAT	65W BR30

Compatible with Halogen, Incandescent, LED* or CFL* lamps



429P
White Reflector, White Self-flange

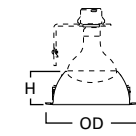

Dimensions**
H: 3" [76mm]
OD: 7-1/4" [184mm]

4051 White Full Cone Reflector, Self-flange

- Full reflector for use with A-lamps
- Friction clip retention on housing plaster ring
- Accessories available: TRM6 designer trim rings, OT403 oversize trim ring
- Socket supporting reflector

Housings	Max Lamp Compatibility
H7T	E7TAT
H7RT	E7RTAT

150W A21

Compatible with Halogen, Incandescent, LED* or CFL* lamps



4051P
White Reflector, White Self-flange



Friction Clips install on housing plaster ring

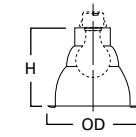

Dimensions**
H: 6" [152mm]
OD: 7-1/4" [184mm]

4261 White Reflector Cone, Self-flange

- Accepts R and PAR lamps
- Coil spring retention

Housings	Max Lamp Compatibility
H7T	75W PAR30S, 150W PAR38, 65W BR30, 120W BR40, 75W R30, 150W R40
H7RT	75W PAR30S, 75W PAR30L, 65W BR30, 120W BR40, 75W R30, 150W R40
E7TAT	75W PAR30S, 75W PAR30L, 150W PAR38, 65W BR30, 120W BR40
E7RTAT	75W PAR30S, 75W PAR30L, 65W BR30, 120W BR40

Compatible with Halogen, Incandescent, LED* or CFL* lamps



4261P
White Reflector, White Self-flange

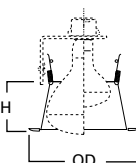

Dimensions**
H: 2-5/8" [67mm]
OD: 7-1/4" [184mm]

*UL1993 listed LED & CFL equivalent lamps permitted. Consult lamp manufacturer for conditions of use. Eaton does not warranty the lamp.

**Key: A: Luminous Aperture, H: Height, OD: Trim Outside Diameter

E26 Screw Base Trims

Non-IC Housings: H7T • H7TCP • H7RT • E7TAT • E7RTAT

6
INCH

6106 Straight Reflector Cone, Self-flange

- Straight sides of cone reflector
- Self-flange reflector cone
- Coil spring retention
- Self-flange trim ring sized to hide gaps caused by construction tolerances



6106SC
Specular Clear Reflector,
White Self-flange

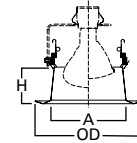

Dimensions**
A: 5-3/8" [137mm]
H: 2-5/8" [68mm]
OD: 7-3/4" [197mm]

Housings		Max Lamp Compatibility
H7T	E7TAT	75W PAR30S, 75W PAR30L,
H7RT	E7RTAT	120W PAR38, 65W BR30,
H7TCP		120W BR40

Compatible with Halogen, Incandescent, LED* or CFL* lamps

6107 Tapered Reflector, Self-flange

- Self-flange reflector cone
- Contoured tapered sides of cone reflector
- Coil spring retention
- Self-flange trim ring sized to hide gaps caused by construction tolerances



6107SC
Specular Clear Reflector,
White Self-flange

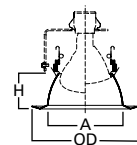

Dimensions**
A: 5-3/8" [137mm]
H: 2-5/8" [65mm]
OD: 7-3/4" [197mm]

Housings		Max Lamp Compatibility
H7T		75W PAR30S, 75W PAR30L,
H7TCP		65W BR30
H7RT	E7RTAT	

Compatible with Halogen, Incandescent, LED* or CFL* lamps

6120 Full Cone Reflector, Self-flange

- Full cone reflector
- Torsion spring retention
- Socket supporting reflector
- Self-flange trim ring sized to hide gaps caused by construction tolerances
- Makes installation Air-Tite regardless of housing used



6120WH
White Reflector,
White Self-flange



6120SN
Satin Nickel Reflector,
Satin Nickel Self-flange



6120TBZ
Tuscan Bronze Reflector,
Tuscan Bronze Self-flange

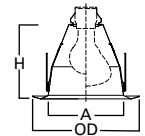

Dimensions**
A: 5-3/8" [137mm]
H: 5-3/8" [138mm]
OD: 7-3/4" [197mm]

Housings		Max Lamp Compatibility
H7T	E7TAT	100W A19, 150W A21, 75W PAR30S, 75W PAR30L, 150W PAR38, 85W BR30, 120W BR40
H7RT	E7RTAT	
H7TCP		6120WH: 100W A19, 75W PAR30S, 75W PAR30L, 120W PAR38, 65W BR30 6120SN, 6120TBZ: 75W A19, 100W PAR38

Compatible with Halogen, Incandescent, LED* or CFL* lamps

6121 Shallow Full Cone Reflector, Self-flange

- Shallow full cone reflector
- Torsion spring retention
- Self-flange trim ring sized to hide gaps caused by construction tolerances
- Makes installation Air-Tite regardless of housing used



6121WH
White Reflector, White Self-flange

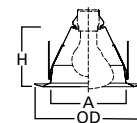

Dimensions**
A: 5-3/8" [137mm]
H: 4-3/8" [110mm]
OD: 7-3/4" [197mm]

Housings		Max Lamp Compatibility
H7T	E7TAT	40W A19, 75W PAR30S, 75W PAR30L, 65W BR30
H7RT	E7RTAT	40W A19, 75W PAR30S, 75W PAR30L, 65W BR30

Compatible with Halogen, Incandescent, LED* or CFL* lamps

*UL1993 listed LED & CFL equivalent lamps permitted. Consult lamp manufacturer for conditions of use. Eaton does not warranty the lamp.

**Key: A: Luminous Aperture, H: Height, OD: Trim Outside Diameter

Baffles



30 Baffle, Self-flange

- Self-flange metal baffle with upper reflector
- Socket supporting baffle
- Torsion spring retention
- Accepts a wide range of lamps
- Makes installation Air-Tite regardless of housing used



30WAT
White Baffle & Reflector,
White Trim



30WATH
White Baffle & Clear
Reflector, White Trim



30PAT
Black Baffle & Clear
Reflector, White Trim



30SNAT
Satin Nickel Baffle &
Reflector, Satin Nickel Trim



30TBZAT
Tuscan Bronze Baffle &
Reflector, Tuscan Bronze Trim

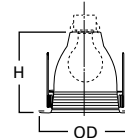

Dimensions**
H: 5" [127mm]
OD: 7-1/4" [184mm]

Housings	Max Lamp Compatibility
H7T	100W A19, 150W A21, 75W PAR30S, 75W PAR30L, 150W PAR38, 85W BR30, 100W R30
H7TCP	75W A19, 75W PAR30S, 75W PAR30L, 150W PAR38, 85W BR30, 100W R30
H7RT	100W A19, 150W A21, 50W PAR30S, 50W PAR30L, 150W PAR38, 85W BR30, 100W R30
E7TAT	100W A19, 150W A21, 75W PAR30S, 75W PAR30L, 150W PAR38, 65W BR30
E7RTAT	100W A19, 150W A21, 50W PAR30S, 75W PAR30L, 150W PAR38, 65W BR30

Compatible with Halogen, Incandescent, LED* or CFL* lamps

310 Coilex® Baffle

- Black or white phenolic Coilex baffle with white metal trim ring
- Removable trim ring
- Accessories available: TRM6 designer trim rings, OT403 oversize trim ring
- Coil spring retention



310W
White Coilex Baffle, White Trim



310P
Black Coilex Baffle, White Trim



310SN
Satin Nickel Coilex Baffle,
Satin Nickel Trim



310TBZ
Tuscan Bronze Coilex Baffle,
Tuscan Bronze Trim



H930 (H7 Housings ONLY) PAR lamp aiming accessory for 310 and 426 trims. Allows 30° tilt and 358° rotation. 50W PAR30.

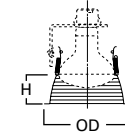

Dimensions**
H: 3-1/16" [78mm]
OD: 7-1/4" [184mm]

Housings	Max Lamp Compatibility
H7T	75W PAR30S, 75W PAR30L, 65W BR30, 75W R30
H7TCP	75W PAR30S, 65W BR30, 75W R30
H7RT	75W PAR30S, 75W PAR30L, 65W BR30, 75W R30
E7TAT	75W PAR30S, 75W PAR30L,
E7RTAT	65W BR30

Compatible with Halogen, Incandescent, LED* or CFL* lamps

353 Metal Baffle

- Metallic finish trim rings and baffles
- Coil spring retention
- Removable trim ring



353SN
Satin Nickel Baffle,
Satin Nickel Trim



353TBZ
Tuscan Bronze Baffle,
Tuscan Bronze Trim

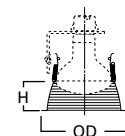

Dimensions**
H: 3" [76mm]
OD: 7-1/4" [184mm]

Housings	Max Lamp Compatibility
H7T	75W PAR30S, 75W PAR30L,
H7RT	65W BR30, 75W R30
E7TAT	75W PAR30S, 75W PAR30L,
E7RTAT	65W BR30

Compatible with Halogen, Incandescent, LED* or CFL* lamps

*UL1993 listed LED & CFL equivalent lamps permitted. Consult lamp manufacturer for conditions of use. Eaton does not warranty the lamp.

**Key: A: Luminous Aperture, H: Height, OD: Trim Outside Diameter

E26 Screw Base Trims

Non-IC Housings: H7T • H7TCP • H7RT • E7TAT • E7RTAT

6
INCH

410 Coilex® Straight Plastic Baffle

- Straight sides of baffle for large diameter lamps
- Black or white phenolic Coilex baffle with separate trim ring
- For PAR38 and R40 lamps
- Removable metal trim ring

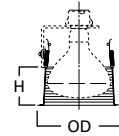

Dimensions**
H: 2-1/4" [57mm]
OD: 7-1/4" [184mm]

Housings	Max Lamp Compatibility
H7T	75W PAR30S, 150W PAR38,
H7TCP	120W BR40, 150W R40
H7RT	120W BR40, 150W R40
E7TAT	75W PAR30S, 75W PAR30L, 150W PAR38, 65W BR30, 120W BR40
E7RTAT	120W BR40

Compatible with Halogen, Incandescent, LED* or CFL* lamps

6100 Tapered Metal Baffle with (2) Trim Rings

- Contoured tapered sides of metal baffle for BR30 and PAR30 lamps
- Two plastic removable trim rings included narrow 7.25" OD and wide oversized 8.00" OD
- Coil spring retention

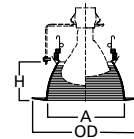

Dimensions**
A: 5-3/4" [148mm]
H: 2-7/8" [74mm]
OD: 7-1/4" [184mm] Narrow
OD: 8" [203mm] Wide

Housings	Max Lamp Compatibility
H7T	E7TAT
H7TCP	75W PAR30S, 75W PAR30L, 65W BR30
H7RT	E7RTAT

Compatible with Halogen, Incandescent, LED* or CFL* lamps

6101 Straight Metal Baffle with (2) Trim Rings

- Straight sides of metal baffle for large diameter lamps
- Two plastic removable trim rings included narrow 7.25" OD and wide 8.00" OD
- Coil spring retention

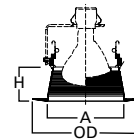

Dimensions**
A: 5-5/8" [144mm]
H: 2-5/8" [66mm]
OD: 7-1/4" [184mm] Narrow
OD: 8" [203mm] Wide

Housings	Max Lamp Compatibility
H7T	75W PAR30S, 75W PAR30L, 150W PAR38, 65W BR30,
H7RT	120W BR40,
H7TCP	75W PAR30S, 75W PAR30L, 120W PAR38, 65W BR30, 120W BR40
E7RTAT	

Compatible with Halogen, Incandescent, LED* or CFL* lamps

*UL1993 listed LED & CFL equivalent lamps permitted. Consult lamp manufacturer for conditions of use. Eaton does not warranty the lamp.

**Key: A: Luminous Aperture, H: Height, OD: Trim Outside Diameter

6102 Tapered Metal Baffle, Self-flange

- Contoured tapered sides of metal baffle
- Coil spring retention
- Self-flange trim ring sized to hide gaps caused by construction tolerances

Housings	Max Lamp Compatibility
H7T	75W PAR30S, 75W PAR30L, 65W BR30
H7TCP	
H7RT	E7RTAT

Compatible with Halogen, Incandescent, LED* or CFL* lamps

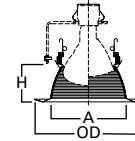

Dimensions**
 A: 5-3/8" [137mm]
 H: 2-5/8" [65mm]
 OD: 7-3/4" [197mm]

6103 Straight Metal Baffle, Self-flange

- Straight sides of metal baffle for large diameter lamps
- Coil spring retention
- Self-flange trim ring sized to hide gaps caused by construction tolerances

Housings	Max Lamp Compatibility
H7T	75W PAR30S, 75W PAR30L, 150W PAR38, 65W BR30, 120W BR40
H7RT	
H7TCP	E7RTAT

Compatible with Halogen, Incandescent, LED* or CFL* lamps

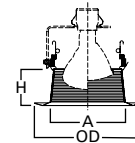

Dimensions**
 A: 5-3/8" [137mm]
 H: 2-5/8" [68mm]
 OD: 7-3/4" [197mm]

6108 Coilex® Straight Plastic Baffle, Self-flange

- Straight sides of Coilex baffle for large diameter BR30 and PAR30 lamps
- Coil spring retention
- Self-flange trim ring sized to hide gaps caused by construction tolerances

Housings	Max Lamp Compatibility
H7T	75W PAR30S, 75W PAR30L, 150W PAR38, 65W BR30, 120W BR40
H7RT	
H7TCP	E7RTAT

Compatible with Halogen, Incandescent, LED* or CFL* lamps

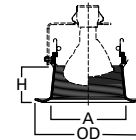

Dimensions**
 A: 5-3/8" [137mm]
 H: 2-5/8" [68mm]
 OD: 7-3/4" [197mm]

6109 Coilex® Tapered Baffle, Self-flange

- Contoured tapered sides of Coilex baffle for BR30 and PAR30 lamps
- Coil spring retention
- Self-flange trim ring sized to hide gaps caused by construction tolerances

Housings	Max Lamp Compatibility
H7T	75W PAR30S, 75W PAR30L, 65W BR30
H7TCP	
H7RT	E7RTAT

Compatible with Halogen, Incandescent, LED* or CFL* lamps

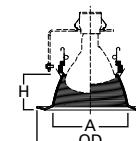

Dimensions**
 A: 5-3/8" [137mm]
 H: 2-5/8" [65mm]
 OD: 7-3/4" [197mm]

*UL1993 listed LED & CFL equivalent lamps permitted. Consult lamp manufacturer for conditions of use. Eaton does not warranty the lamp.

**Key: A: Luminous Aperture, H: Height, OD: Trim Outside Diameter

E26 Screw Base Trims

Non-IC Housings: H7T • H7TCP • H7RT • E7TAT • E7RTAT

6
INCH

6110 Perftex™ Baffle, Self-flange

- Perforated pattern baffle contoured for BR30 and PAR30 lamps
- Coil spring retention
- Self-flange trim ring sized to hide gaps caused by construction tolerances



6110WB
White Perftex Baffle,
White Self-flange



6110BB
Black Perftex Baffle,
White Self-flange



6110BKBB
Black Perftex Baffle,
Black Self-flange

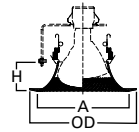

Dimensions**
A: 6-5/8" [169mm]
H: 2-1/8" [54mm]
OD: 7-3/4" [197mm]

Housings		Max Lamp Compatibility
H7T	E7TAT	75W PAR30S, 75W PAR30L,
H7RT	E7RTAT	65W BR30
H7TCP		

Compatible with Halogen, Incandescent, LED* or CFL* lamps

6125 Full Cone Baffle, Self-flange

- Full cone baffle
- Torsion spring retention
- Socket supporting baffle
- Self-flange trim ring sized to hide gaps caused by construction tolerances



6125WB
White Baffle, White Self-flange



6125BB
Black Baffle, White Self-flange



6125BKBB
Black Baffle, Black Self-flange

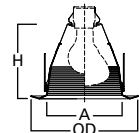

Dimensions**
A: 5-3/8" [137mm]
H: 5-3/8" [138mm]
OD: 7-3/4" [197mm]

Housings		Max Lamp Compatibility
H7T	E7TAT	100W A19, 150W A21, 75W PAR30S, 75W PAR30L, 150W PAR38, 85W BR30, 120W BR40
H7RT	E7RTAT	100W A19, 150W A21, 75W PAR30S, 75W PAR30L, 100W PAR38, 85W BR30, 120W BR40
H7TCP		6125WB: 100W A19, 150W A21, 75W PAR30S, 75W PAR30L, 120W PAR38, 65W BR30 6125BB, 6125BKBB: 75W A19, 150W A21, 75W PAR30S, 75W PAR30L, 100W PAR38, 65W BR30

Compatible with Halogen, Incandescent, LED* or CFL* lamps

6126 Shallow Full Cone Baffle, Self-flange

- Shallow full cone baffle for A19 and PAR30S lamps
- Torsion spring retention
- Socket supporting baffle
- Self-flange trim ring sized to hide gaps caused by construction tolerances



6126WB
White Baffle White Self-flange



6126BB
Black Baffle, White Self-flange

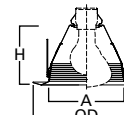

Dimensions**
A: 5-3/8" [137mm]
H: 4-3/8" [110mm]
OD: 7-3/4" [197mm]

Housings		Max Lamp Compatibility
H7T	E7TAT	40W A19, 75W PAR30S, 75W PAR30L, 65W BR30
H7RT	E7RTAT	40W A19, 75W PAR30S, 75W PAR30L, 65W BR30

Compatible with Halogen, Incandescent, LED* or CFL* lamps

Adjustable – Eyeballs & Gimbals

74 Eyeball 30° Tilt, Self-flange

- Provides optimum position for PAR30S lamps
- Torsion spring retention
- Socket supporting eyeball



74P
White Eyeball, White Trim

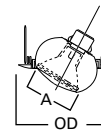

Dimensions**
A: 3-7/8" [98mm]
OD: 8" [203mm]

Housings		Max Lamp Compatibility
H7T	E7TAT	75W PAR30S
H7RT	E7RTAT	

Compatible with Halogen, Incandescent, LED* or CFL* lamps

*UL1993 listed LED & CFL equivalent lamps permitted. Consult lamp manufacturer for conditions of use. Eaton does not warranty the lamp.

**Key: A: Luminous Aperture, H: Height, OD: Trim Outside Diameter

76 Gimbal 30° Tilt, Self-flange

- For use with PAR38 lamps
- 30° tilt
- Torsion spring retention



76P
White Gimbal, White Trim

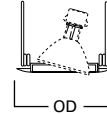

Dimensions**
OD: 8" [203mm]

Housings	Max Lamp Compatibility
----------	------------------------

H7T	E7TAT	150W PAR38
H7RT	E7RTAT	(Side prong lamp recommended)
H7TCP		

Compatible with Halogen, Incandescent, LED* or CFL* lamps

78 Eyeball 30° Tilt, Self-flange

- 30° tilt, 360° rotation
- Torsion spring retention
- Wide choice of finishes for any decor
- Socket supporting eyeball
- 78PAT makes installation Air-Tite regardless of housing used



78P
White Eyeball, White Trim



78PAT
White Eyeball, White Trim



78SN
Satin Nickel Eyeball,
Satin Nickel Trim



78TBZ
Tuscan Bronze Eyeball,
Tuscan Bronze Trim

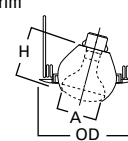

Dimensions**
A: 4" [100mm]
H: 4-1/8" [105mm]
OD: 8" [203mm]

Housings	Max Lamp Compatibility
----------	------------------------

H7T	75W PAR30S, 75W PAR30L,
H7RT	65W BR30, 75W R30
H7TCP	75W PAR30S, 75W R30, 65W BR30
E7TAT	75W PAR30S, 75W PAR30L, 65W BR30
E7RTAT	50W PAR30S, 75W PAR30L, 65W BR30

Compatible with Halogen, Incandescent, LED* or CFL* lamps

376 Regressed Gimbal 30° Tilt, Self-flange

- 30° tilt
- Regressed gimbal with baffle
- Torsion spring retention
- Socket supporting gimbal



376W
White Baffle, White Trim



376P
Black Baffle, White Trim

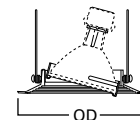

Dimensions**
OD: 7-1/4" [184mm]

Housings	Max Lamp Compatibility
----------	------------------------

H7T	E7TAT	75W PAR30S
H7TCP		
H7RT	E7RTAT	50W PAR30S

Compatible with Halogen, Incandescent, LED* or CFL* lamps

378 Regressed Gimbal with Splay 25° Tilt, Self-flange

- 25° tilt
- Regressed gimbal with splay trim
- Removable trim ring
- Accessories available: TRM6 designer trim rings, OT403 oversize trim ring
- Friction clips on trim
- Socket supporting gimbal



378P
White Splay, White Trim



378
Clear Specular Splay, White Trim

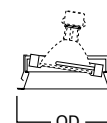

Dimensions**
OD: 7-1/4" [184mm]

Housings	Max Lamp Compatibility
----------	------------------------

H7T	E7TAT	
H7RT		75W PAR30S
H7TCP		

Compatible with Halogen, Incandescent, LED* or CFL* lamps



Friction Clips on Trim

*UL1993 listed LED & CFL equivalent lamps permitted. Consult lamp manufacturer for conditions of use. Eaton does not warranty the lamp.

**Key: A: Luminous Aperture, H: Height, OD: Trim Outside Diameter

E26 Screw Base Trims

Non-IC Housings: H7T • H7TCP • H7RT • E7TAT • E7RTAT

6
INCH

419 Regressed Eyeball with Splay 25° Tilt

- Regressed eyeball with splay
- 25° tilt, 358° rotation
- Accessories available: TRM6 designer trim rings, OT403 oversize trim ring
- Removable trim ring
- Socket supporting trim



419P
White Eyeball & Splay, White Trim

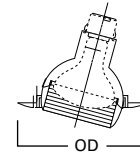

Dimensions**
OD: 7-1/4" [184mm]

Housings Max Lamp Compatibility

H7T	E7TAT	
H7RT	E7RTAT	75W PAR30S
H7TCP		

Compatible with Halogen, Incandescent, LED* or CFL* lamps

420 Regressed Eyeball 30° Tilt, Self-flange

- Regressed eyeball with baffle
- Removable trim ring
- Accessories available: TRM6 designer trim rings, OT403 oversize trim ring
- Socket supporting eyeball



420W
White Eyeball & Baffle,
White Trim



420P
White Eyeball & Black Baffle,
White Trim

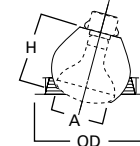

Dimensions**
A: 4" [100mm]
H: 4" [102mm]
OD: 7-1/4" [184mm]

Housings Max Lamp Compatibility

H7T	75W PAR30S, 75W PAR30L,
H7RT	75W BR30
E7TAT	75W PAR30S, 75W PAR30L
E7RTAT	

Compatible with Halogen, Incandescent, LED* or CFL* lamps

478 Adjustable Regressed Gimbal with Splay 25° Tilt, Self-flange

- 25° tilt
- Adjustable gimbal with splay trim for PAR38 lamps
- Removable trim ring
- Accessories available: TRM6 designer trim rings, OT403 oversize trim ring
- Friction clips on trim
- Socket supporting gimbal



478P
White Splay, White Trim



Friction Clips on Trim

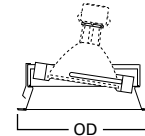

Dimensions**
OD: 7-1/4" [184mm]

Housings Max Lamp Compatibility

H7T	90W PAR38	
H7TCP		
E7TAT	90W PAR38	
H7RT	E7RTAT	90W PAR38

Compatible with Halogen, Incandescent, LED* or CFL* lamps

6130 Eyeball 35° Tilt, Self-flange

- 35° tilt, 360° rotation
- Adjustable eyeball trim for BR30 and PAR30 lamps
- Torsion spring retention
- Socket supporting eyeball
- Self-flange trim ring sized to hide gaps caused by construction tolerances



6130WH
White Eyeball, White Self-flange

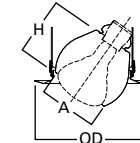

Dimensions**
A: 3-7/8" [100mm]
H: 3-7/8" [100mm]
OD: 7-3/4" [197mm]

Housings Max Lamp Compatibility

H7T	E7TAT	75W PAR30S, 75W PAR30L,
H7TCP		65W BR30
H7RT	E7RTAT	50W PAR30S, 75W PAR30L,
		65W BR30

Compatible with Halogen, Incandescent, LED* or CFL* lamps

*UL1993 listed LED & CFL equivalent lamps permitted. Consult lamp manufacturer for conditions of use. Eaton does not warranty the lamp.

**Key: A: Luminous Aperture, H: Height, OD: Trim Outside Diameter

6170 Gimbal 25° Tilt, Self-flange

- 25° tilt, 360° rotation
- Adjustable gimbal for PAR38 lamps
- Torsion spring retention
- Socket supporting gimbal
- Self-flange trim ring sized to hide gaps caused by construction tolerances

Housings Max Lamp Compatibility

H7T	E7TAT	90W PAR38
H7TCP		
H7RT	E7RTAT	

Compatible with Halogen, Incandescent, LED* or CFL* lamps



6170WH
White Gimbal,
White Self-flange



6170BK
Black Gimbal,
Black Self-flange



6170SN
Satin Nickel Gimbal,
Satin Nickel Self-flange



6170TBZ
Tuscan Bronze Gimbal,
Tuscan Bronze Self-flange

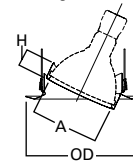

Dimensions**

A: 4-1/2" [113mm]
H: 1-1/5" [30mm]
OD: 7-3/4" [197mm]

6215 Double Gimbal 30°-50° Tilt, Self-flange

- 30°-50° tilt, 360° rotation
- 50° tilt with double gimbal design using compound angles
- Double gimbal for PAR30 lamps
- Torsion spring retention
- Shallow housings are compatible with PAR30S (short-neck) lamps
- Socket supporting gimbal
- Self-flange trim ring sized to hide gaps caused by construction tolerances

Housings Max Lamp Compatibility

H7T	E7TAT	75W PAR30S, 75W PAR30L
H7TCP		
H7RT	E7RTAT	

Compatible with Halogen, Incandescent, LED* or CFL* lamps



6215WH
White Gimbal,
White Self-flange



6215BK
Black Gimbal,
Black Self-flange



6215SN
Satin Nickel Gimbal,
Satin Nickel Self-flange



6215TBZ
Tuscan Bronze Gimbal,
Tuscan Bronze Self-flange

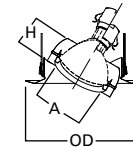

Dimensions**

A: 3-3/8" [84mm]
H: 2" [51mm]
OD: 7-3/4" [197mm]

6222 Regressed Angle Cut Adjustable Gimbal, 45° Tilt, Self-flange

- 45° tilt, 360° rotation
- Fully regressed gimbal – self-flange ring
- Torsion spring retention
- Socket supporting gimbal
- Reflector and baffle options
- Accommodates tilt of gimbal in a full regressed cut cone
- Self-flange trim ring sized to hide gaps caused by construction tolerances

Housings Max Lamp Compatibility

H7T	E7TAT	60W PAR16, 50W PAR20, 75W PAR30S, 75W PAR30L
H7TCP		
H7RT	E7RTAT	

Compatible with Halogen, Incandescent, LED* or CFL* lamps



6222WB
White Baffle, White Trim



6222BB
Black Baffle, White Trim



6222SC
Specular Clear Reflector,
White Trim



6222H
Haze Reflector, White Trim

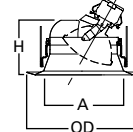

Dimensions**

A: 3-3/4" [95mm]
H: 5-3/8" [137mm]
OD: 7-3/4" [197mm]

Lenses & Wet Location Showerlights

70 Albalite Glass Lens

- White trim, glass Albalite lens
- PS version features "dead-front" construction and is wet location listed for use in showers
- Non-conductive, non-corrosive polymer (plastic) trim ring
- Torsion spring retention

Housings Max Lamp Compatibility

H7T	E7TAT	60W A19
H7TCP		
H7RT	E7RTAT	

Compatible with Halogen, Incandescent, LED* or CFL* lamps



70P
Albalite Glass Lens,
White Trim



70PS
Albalite Glass Lens,
White Trim, Wet Location
Showerlight

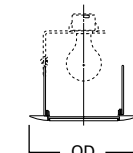

Dimensions**

OD: 8" [203mm]

*UL1993 listed LED & CFL equivalent lamps permitted. Consult lamp manufacturer for conditions of use. Eaton does not warranty the lamp.

**Key: A: Luminous Aperture, H: Height, OD: Trim Outside Diameter

E26 Screw Base Trims

Non-IC Housings: H7T • H7TCP • H7RT • E7TAT • E7RTAT

6
INCH

71 Drop Opal Glass Lens

- White trim, drop opal glass lens
- PS version features "dead-front" construction and is wet location listed for use in showers
- Non-conductive, non-corrosive polymer (plastic) trim ring
- Torsion spring retention



71P
Drop Opal Glass Lens,
White Trim



71PS
Drop Opal Glass Lens, White Polymer
Trim, Wet Location

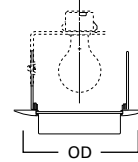

Dimensions**
OD: 8" [203mm]

Housings Max Lamp Compatibility

H7T	E7TAT	60W A19
H7TCP		
H7RT	E7RTAT	

Compatible with Halogen, Incandescent, LED* or CFL* lamps

73 Fresnel Glass Lens

- White trim with glass Fresnel lens
- PS version features "dead-front" construction and is wet location listed for use in showers
- Non-conductive, non-corrosive polymer (plastic) trim ring
- Torsion spring retention



73P
Fresnel Glass Lens,
White Trim



73PS
Fresnel Glass Lens, White Trim,
Wet Location

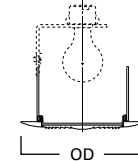

Dimensions**
OD: 8" [203mm]

Housings Max Lamp Compatibility

H7T	E7TAT	60W A19
H7TCP		
H7RT	E7RTAT	

Compatible with Halogen, Incandescent, LED* or CFL* lamps

170 Albalite Lens with Reflector

- White trim with Albalite glass lens
- PS version features non-conductive, non-corrosive gasketed polymer (plastic) trim ring
- PS version is "dead-front" construction and is wet location listed for use in showers
- Torsion spring retention
- PS version is Air-Tite; making any installation Air-Tite



170P
Albalite Lens, White Trim



170PS
Albalite Lens, Polymer White Trim

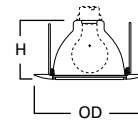

Dimensions**
H: 4" [102mm]
OD: 8" [203mm]

Housings Max Lamp Compatibility

H7T	E7TAT	60W A19
H7RT	E7RTAT	

Compatible with Halogen, Incandescent, LED* or CFL* lamps

171 Drop Opal Glass Lens with Reflector

- White trim with drop opal glass lens
- PS version features non-conductive, non-corrosive gasketed polymer (plastic) trim ring
- PS version is "dead-front" construction and is wet location listed for use in showers
- Torsion spring retention
- PS version is Air-Tite; making any installation Air-Tite



171P
Drop Opal Lens, White Trim



171PS
Drop Opal Lens, White Polymer Trim

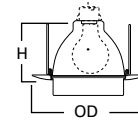

Dimensions**
H: 4" [102mm]
OD: 8" [203mm]

Housings Max Lamp Compatibility

H7T	E7TAT	60W A19
H7RT	E7RTAT	

Compatible with Halogen, Incandescent, LED* or CFL* lamps

*UL1993 listed LED & CFL equivalent lamps permitted. Consult lamp manufacturer for conditions of use. Eaton does not warranty the lamp.

**Key: A: Luminous Aperture, H: Height, OD: Trim Outside Diameter

172 Dome Glass Lens with Reflector

- Frosted glass dome
- Features "dead-front" construction and is wet location listed for use in showers
- Non-conductive, non-corrosive gasketed polymer (plastic) trim ring
- Torsion spring retention
- Air-Tite trim makes any installation Air-Tite



172PS
Frosted Glass Dome,
White Polymer Trim



172TBZS
Frosted Glass Dome,
Tuscan Bronze Polymer Trim

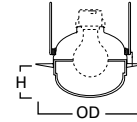

Dimensions**
H: 2-1/8" [54mm]
OD: 7-3/4" [197mm]

Housings		Max Lamp Compatibility
H7T	E7TAT	100W A19, 75W PAR30S
H7RT	E7RTAT	60W A19, 50W PAR30S

Compatible with Halogen, Incandescent, LED* or CFL* lamps

173 Fresnel Lens with Reflector

- White trim with glass Fresnel lens
- PS version is "dead-front" construction and is wet location listed for use in showers
- PS version features non-conductive, non-corrosive gasketed polymer (plastic) trim ring
- Torsion spring retention
- PS version is Air-Tite; making any installation Air-Tite



173P
Fresnel Lens, White Trim



173PS
Fresnel Lens, White Polymer Trim

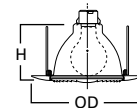

Dimensions**
H: 4" [102mm]
OD: 8" [203mm]

Housings		Max Lamp Compatibility
H7T	E7TAT	60W A19
H7RT	E7RTAT	

Compatible with Halogen, Incandescent, LED* or CFL* lamps

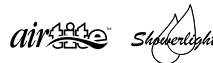

6145 Open Wet Location, Shallow Reflector, Self-flange

- Open wet location shallow Showerlight for PAR30S, PAR30L and PAR38 outdoor rated lamps ONLY
- Torsion spring retention
- Socket supporting cone
- Self-flange trim ring sized to hide gaps caused by construction tolerances



6145WH
White Shallow Reflector,
White Self-flange



6145SN
Satin Nickel Shallow Reflector,
Satin Nickel Self-flange



6145TBZ
Tuscan Bronze Shallow Reflector,
Tuscan Bronze Self-flange

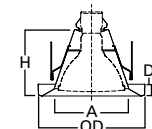

Dimensions**
A: 5-3/8" [136mm]
D: 7/8" [22mm]
H: 4-7/8" [123mm]
OD: 7-3/4" [197mm]

Housings		Max Lamp Compatibility
H7T	E7TAT	75W PAR30S, 75W PAR30L, 150W PAR38
H7TCP		
H7RT		

Compatible with Halogen, Incandescent, LED* or CFL* lamps

**Outdoor
Rated Lamp
ONLY**
(Purchase Separately)



**Lamp Gasket
(Included)**



6146 Open Wet Location, Full Reflector Self-flange

- Open wet location Showerlight for PAR30S and PAR30L outdoor rated lamps ONLY
- Torsion spring retention
- Socket supporting cone
- Self-flange trim ring sized to hide gaps caused by construction tolerances



6146WH
White Reflector,
White Self-flange



6146SN
Satin Nickel Reflector,
Satin Nickel Self-flange



6146TBZ
Tuscan Bronze Reflector,
Tuscan Bronze Self-flange

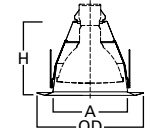

Dimensions**
A: 5-3/8" [137mm]
H: 5-3/8" [138mm]
OD: 7-3/4" [197mm]

Housings		Max Lamp Compatibility
H7T	E7TAT	75W PAR30S, 75W PAR30L, 150W PAR38
H7RT		
H7TCP		6146WH: 75W PAR30S, 75W PAR30L, 120W PAR38 6146SN, 6146TBZ: 75W PAR30S, 75W PAR30L, 100W PAR38

Compatible with Halogen, Incandescent, LED* or CFL* lamps

**Outdoor
Rated Lamp
ONLY**
(Purchase Separately)



**Lamp Gasket
(Included)**



*UL1993 listed LED & CFL equivalent lamps permitted. Consult lamp manufacturer for conditions of use. Eaton does not warranty the lamp.

**Key: A: Luminous Aperture, H: Height, OD: Trim Outside Diameter

E26 Screw Base Trims

Non-IC Housings: H7T • H7TCP • H7RT • E7TAT • E7RTAT

6
INCH



6150 Low Profile, Frosted Glass Dome Lens, Self-flange

- Low profile, frosted glass dome lens
- Wet location Showerlight
- Torsion spring retention
- Non-conductive "dead-front" polymer (plastic) trim ring and glass lens
- Socket supporting internal reflector
- Self-flange trim ring sized to hide gaps caused by construction tolerances



6150WH
Frosted Glass Dome Lens with Reflector, White Plastic Self-flange



6150SN
Frosted Glass Dome Lens with Reflector, Satin Nickel Plastic Self-flange



6150TBZ
Frosted Glass Dome Lens with Reflector, Tuscan Bronze Plastic Self-flange

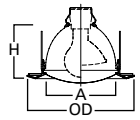

Dimensions**
A: 5-1/8" [130mm]
H: 4-1/2" [107mm]
OD: 7-3/4" [197mm]

Housings Max Lamp Compatibility

H7T	E7TAT	60W A19, 60W PAR30S
H7TCP		
H7RT	E7RTAT	

Compatible with Halogen, Incandescent, LED* or CFL* lamps

6160 Drop White Plastic Lens, Self-flange

- Wet location Showerlight
- Non-conductive "dead-front" polymer (plastic) trim and lens
- Torsion spring retention



6160WH
Drop White Plastic Lens, White Plastic Self-flange

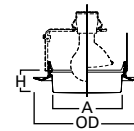

Dimensions**
A: 5-1/8" [130mm]
H: 2-1/4" [57mm]
OD: 7-3/4" [197mm]

Housings Max Lamp Compatibility

H7T	E7TAT	60W A19, 39W PAR30S
H7TCP		
H7RT	E7RTAT	

Compatible with Halogen, Incandescent, LED* or CFL* lamps



6230 Squirrel Frost Glass Lens, Metal Trim, Self-flange

- Low profile frost glass lens
- Wet location Showerlight
- Torsion spring retention
- Self-flange low profile metal trim ring
- Socket supporting internal bracket
- Integral rotation adjustment up to +/- 25° for precise alignment with room



6230AH
Frost Glass Lens, Aluminum Haze Squirrel Trim



6230PN
Frost Glass Lens, Polished Nickel Squirrel Trim



6230SN
Frost Glass Lens, Satin Nickel Squirrel Trim

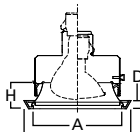

Dimensions**
A: 6" [152mm]
H: 4-1/4" [109mm]
D: 3/4" [20mm]
OD: 7-1/4" [185mm]

Housings Max Lamp Compatibility

H7T	E7TAT	72W A19, 75W PAR30S
H7RT	E7RTAT	
H7TCP		

Compatible with Halogen, Incandescent, LED* or CFL* lamps



6255 Soft Square, Frost Curved Glass Lens, Self-flange

- Low profile curved frost glass lens
- Wet location Showerlight
- Torsion spring retention
- Integral adjustment up to 90° for precise alignment to room
- Non-conductive "dead-front" polymer (plastic) trim ring and glass lens
- Integral rotation adjustment up to +/- 25° for precise alignment with room
- Integrated socket supporting reflector for even illumination across lens corner-to-corner



6255WH
Frost Curved Glass Lens with Reflector, White Plastic Self-flange



6255SN
Frost Curved Glass Lens with Reflector, Satin Nickel Plastic Self-flange



6255TBZ
Frost Curved Glass Lens with Reflector, Tuscan Bronze Plastic Self-flange

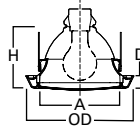

Dimensions**
A: 5-7/8" [149mm]
D: 1" [25mm]
H: 4-1/2" [114mm]
OD: 7-5/8" [194mm]

Housings Max Lamp Compatibility

H7T	E7TAT	72W A19, 75W PAR30S
H7RT	E7RTAT	
H7TCP		

Compatible with Halogen, Incandescent, LED* or CFL* lamps



*UL1993 listed LED & CFL equivalent lamps permitted. Consult lamp manufacturer for conditions of use. Eaton does not warranty the lamp.

**Key: A: Luminous Aperture, H: Height, OD: Trim Outside Diameter

Open, Splay & Wall Wash

79 Pinhole Trim

- 1-7/8" open pinhole for R20 lamp
- Torsion spring retention

Housings	Max Lamp Compatibility
H7T	50W PAR20, 50W PAR30S, 50W R20
H7TCP	60W A19
E7TAT	50W PAR20, 50W PAR30S

Compatible with Halogen, Incandescent, LED* or CFL* lamps



79
Pinhole Trim

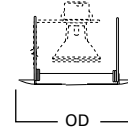

Dimensions**
OD: 8" [203mm]

300 Open Trim with Fixed Socket Bracket

- Open trim for BR30 and PAR30 lamps
- Torsion spring retention
- Socket supporting internal bracket

Housings	Max Lamp Compatibility
H7T	75W PAR30S, 75W PAR30L, 65W BR30, 75W R30
E7TAT	75W PAR30S, 75W PAR30L, 65W BR30

Compatible with Halogen, Incandescent, LED* or CFL* lamps



300P
Socket Bracket with
White Open Trim



300SN
Socket Bracket with
Satin Nickel Open Trim



300TBZ
Socket Bracket with
Tuscan Bronze Open Trim

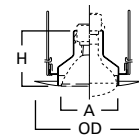

Dimensions**
A: 4-3/4" [122mm]
H: 4-3/4" [122mm]
OD: 7-1/4" [184mm]

301 Open Trim

- Open trim for BR30, R30, and PAR30 lamps
- Coil spring retention

Housings	Max Lamp Compatibility
H7T E7TAT	75W PAR30S, 75W R30, 65W BR30
H7TCP	
H7RT E7RTAT	75W PAR30S, 75W PAR30L, 65W BR30

Compatible with Halogen, Incandescent, LED* or CFL* lamps



301P
White Open Trim



301SN
Satin Nickel Open Trim



301TBZ
Tuscan Bronze Open Trim

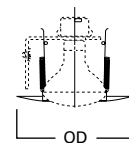

Dimensions**
OD: 7-1/4" [184mm]

328 White Splay Trim

- Splay trim for BR30 and PAR30 lamps
- Coil spring retention

Housings	Max Lamp Compatibility
H7T E7TAT	75W PAR30S, 75W R30, 65W BR30
H7TCP	
H7RT E7RTAT	75W PAR30S, 75W PAR30L, 65W BR30

Compatible with Halogen, Incandescent, LED* or CFL* lamps



328P
White Splay Trim

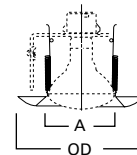

Dimensions**
A: 3-7/8" [98mm]
OD: 7-3/4" [197mm]

*UL1993 listed LED & CFL equivalent lamps permitted. Consult lamp manufacturer for conditions of use. Eaton does not warranty the lamp.

**Key: A: Luminous Aperture, H: Height, OD: Trim Outside Diameter

E26 Screw Base Trims

Non-IC Housings: H7T • H7TCP • H7RT • E7TAT • E7RTAT

6
INCH

401 Open Trim

- Open trim for BR40 and R40 lamps
- Coil spring retention

Housings		Max Lamp Compatibility
H7T	H7RT	120W BR40, 150W R40
H7TCP		
E7TAT	E7RTAT	120W BR40

Compatible with Halogen, Incandescent, LED* or CFL* lamps



401P
White Open Trim



401AL
Satin Aluminum Open Trim

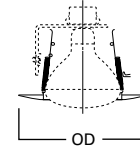

Dimensions**
OD: 8" [203mm]

428 White Splay Trim

- Splay trim for BR40 and R40 lamps
- Coil spring retention

Housings		Max Lamp Compatibility
H7T	H7RT	120W BR40, 150W R40
H7TCP		
E7TAT	E7RTAT	120W BR40

Compatible with Halogen, Incandescent, LED* or CFL* lamps



428P
White Splay Trim

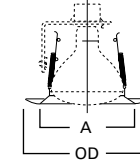

Dimensions**
OD: 7-3/4" [197mm]

303 Wall Wash with Scoop

- Designed to spread light close to ceiling
- Coil spring retention

Housings		Max Lamp Compatibility
H7T		
H7TCP	E7TAT	60W A19
H7RT	E7RTAT	

Compatible with Halogen, Incandescent, LED* or CFL* lamps



303P
Wall Wash, White Trim

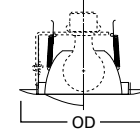

Dimensions**
OD: 8" [203mm]

424 Open Wall Wash / Reflector Downlight

- Designed to spread light on cabinets or wall close to ceiling and provide downlighting on counters

Housings		Max Lamp Compatibility
H7T		
H7TCP	E7TAT	100W A19
H7RT	E7RTAT	

Compatible with Halogen, Incandescent, LED* or CFL* lamps



424P
Open Wall Wash and Downlight,
White Trim

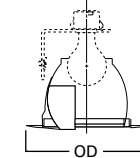

Dimensions**
OD: 7-1/4" [184mm]

425 Wall Wash with Coilex® Baffle and Scoop Reflector

- Black or white phenolic Coilex baffle with scoop reflector
- Designated to spread light close to ceiling
- Coil spring retention

Housings		Max Lamp Compatibility
H7T		
H7TCP	E7TAT	60W A19
H7RT	E7RTAT	

Compatible with Halogen, Incandescent, LED* or CFL* lamps



425W
White Baffle, White Trim



425P
Black Baffle, White Trim

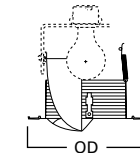

Dimensions**
OD: 7-1/4" [184mm]

*UL1993 listed LED & CFL equivalent lamps permitted. Consult lamp manufacturer for conditions of use. Eaton does not warranty the lamp.

**Key: A: Luminous Aperture, H: Height, OD: Trim Outside Diameter



430 Wall Wash with Baffle & Full Reflector

- Black or white step baffle with full reflector
- Designed to spread light close to the ceiling to eliminate the "cave effect"
- Torsion spring retention
- Makes installation Air-Tite regardless of housing used



430W
White Baffle, White Trim



430P
Black Baffle, White Trim

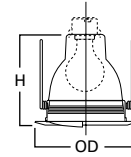

Dimensions**
H: 5" [127mm]
OD: 7-1/4" [184mm]

Housings	Max Lamp Compatibility
H7T	90W TB19, 100W A19, 100W BT15, 100W MB19
E7TAT	100W A19

Compatible with Halogen, Incandescent, LED* or CFL* lamps

Low Voltage

1412 Low Voltage Adjustable Spot 30° Tilt

- Low voltage trim
- Includes 120V transformer for retrofit to H7T and H7RT housings
- Torsion spring retention



1412W
White Lampholder & Baffle,
White Trim



1412P
Black Lampholder & Baffle,
White Trim

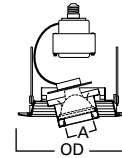

Dimensions**
A: 1-3/4" [44mm]
OD: 7-1/4" [184mm]

Housings	Max Lamp Compatibility
H7T E7TAT	50W 12V MR16
H7RT	

Compatible with Halogen, Incandescent, LED* or CFL* lamps

1416 Low Voltage Specular Reflector 30° Tilt

- Low voltage trim
- Includes 120V transformer for retrofit to H7T and H7RT housings
- Torsion spring retention



1416C
Clear Specular Reflector,
White Trim

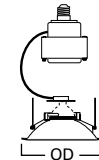

Dimensions**
OD: 7-1/4" [184mm]

Housings	Max Lamp Compatibility
H7T E7TAT	50W 12V MR16

Compatible with Halogen, Incandescent, LED* or CFL* lamps

1417 Low Voltage Eyeball with Baffle 30° Tilt

- Low voltage trim
- Includes 120V transformer for retrofit to H7T and H7RT housings
- Torsion spring retention



1417W
White Eyeball and White
Baffle, White Trim



1417BA
White Eyeball and Black
Baffle, White Trim

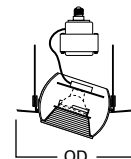

Dimensions**
OD: 7-1/4" [184mm]

Housings	Max Lamp Compatibility
H7T E7TAT	50W 12V MR16
H7RT H7TCP	

Compatible with Halogen, Incandescent, LED* or CFL* lamps

*UL1993 listed LED & CFL equivalent lamps permitted. Consult lamp manufacturer for conditions of use. Eaton does not warranty the lamp.

**Key: A: Luminous Aperture, H: Height, OD: Trim Outside Diameter

E26 Screw Base Trims

Non-IC Housings: H7T • H7TCP • H7RT • E7TAT • E7RTAT

6
INCH

1416 Low Voltage Baffle 30° Tilt

- Low voltage trim
- Includes 120V transformer for retrofit to H7T and H7RT housings
- Torsion spring retention

Housings	Max Lamp Compatibility
----------	------------------------

H7T	E7TAT
H7RT	
50W 12V MR16	

Compatible with Halogen, Incandescent, LED* or CFL* lamps



1416W
White Baffle, White Trim



1416BA
Black Baffle, White Trim

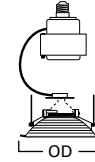

Dimensions**
OD: 7-1/4" [184mm]

1450 Low Voltage Slot Aperture 30° Tilt

- Low voltage trim
- Includes 120V transformer for retrofit to H7T and H7RT housings
- Torsion spring retention

Housings	Max Lamp Compatibility
----------	------------------------

H7T	
H7RT	
50W 12V MR16	

Compatible with Halogen, Incandescent, LED* or CFL* lamps



1450P
Clear Specular Reflector,
White Trim

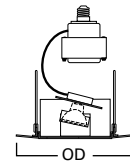

Dimensions**
OD: 7-1/4" [184mm]

1475 Low Voltage Adjustable Accent 30° Tilt

- Low voltage trim
- Includes 120V transformer for retrofit to H7T and H7RT housings
- Torsion spring retention

Housings	Max Lamp Compatibility
----------	------------------------

H7T	E7TAT
H7RT	E7RTAT
50W PAR36 low voltage	

Compatible with Halogen, Incandescent, LED* or CFL* lamps



1475W
White Baffle, White Trim



1475P
Black Baffle, White Trim

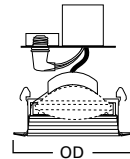

Dimensions**
OD: 7-1/4" [184mm]

1479 Low Voltage Pinhole Trim

- Low voltage trim
- Includes 120V transformer for retrofit to H7T and H7RT housings
- Torsion spring retention

Housings	Max Lamp Compatibility
----------	------------------------

H7T	H7RT
H7TCP	
E7TAT	E7RTAT
50W 12V MR16	

Compatible with Halogen, Incandescent, LED* or CFL* lamps



1479W
White Baffle, White Trim



1479P
Black Baffle, White Trim

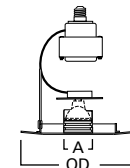

Dimensions**
A: 1-7/8" [48mm]
OD: 8" [203mm]

*UL1993 listed LED & CFL equivalent lamps permitted. Consult lamp manufacturer for conditions of use. Eaton does not warranty the lamp.

**Key: A: Luminous Aperture, H: Height, OD: Trim Outside Diameter

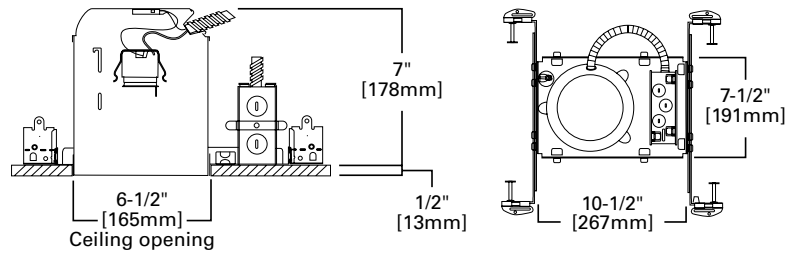

H7TNB

6" Non-IC, New Construction Housing, No Socket Bracket, 120V

The H7 recessed housing is the standard in the industry for both light commercial and residential applications. H7 series features full-frame design, robust construction, feed-through listing, Got Nail! bar hangers; and may support use of higher wattage lamps. A wide variety of trims allows a number of different lighting effects to be created with one basic housing. The H7TNB is for use in non-insulated ceilings. If ceiling insulation is present, it must be kept 3" from all sides of housing. May be retrofit with compatible Halo LED lighting systems.

The H7TNB can save installation time. It is designed without a socket plate for use with socket supporting trims only. With these trims there is no need to spend time removing the socket plate and the fixed lamp position of socket supporting trims saves on lamp adjustment time too.



Special Features

- Got Nail!™ bar hangers
- q-Channel bars with Pass-N-Thru™
- Slide-N-Side™ junction box
- Quick Connect™ push wire nuts

Compatible Socket Supporting Trims

30°	171°	405	4051	6130	6215
74	172°	419	6120°	6145	6222
76	173°	420	6121°	6146	6230
78°	376	430°	6125°	6150	6255
170°	378	478	6126°	6170	30SBAT°



Trims for use in Halo listed housings



Select trims are classified for use in other housings, see www.cooperlighting.com/legal

◊ Air-Tite trims can make the H7TNB installation ASTM E283 compliant (in an Non-Insulated ceiling)

Features

Housing

- Single wall die-stamped CRS housing
- White housing paint finish

Plaster Frame

- Galvanized steel construction
- The housing can be removed from plaster frame to provide access to the junction box
- Housing adjusts in plaster frame to accommodate ceilings up to 1-3/8" thick
- Plaster frame features include:
 - Patented regressed locking screw positioned for securing hanger bars from below the ceiling
 - Cutouts for easily crimping hanger bars in position
 - Halo name embossed on plaster frame

Includes:

- Got Nail!™ bar hangers (Details Pg. 13)
- q-Channel bars with Pass-N-Thru™ (Details Pg. 13)
- Slide-N-Side™ junction box wire traps (Details Pg. 13)
- Quick Connect™ push wire nuts (Details Pg. 13)

Socket

- Porcelain socket with nickel plated brass screw shell
- Snap-in socket speeds installation and attaches directly to the trim for consistent lamp positioning
- Overspray protector included

Thermal Protector

Self resetting thermal protector deactivates fixture if overheating occurs due to improper lamping or misapplied insulation

Trims

Halo Fit-All concept offers multiple trim options in a variety of design styles, and functional beam distributions to control beam angle and lumen delivery in accommodating various lamp types including Halogen, CFL and LED

Compliance

- cULus Listed 1598 luminaire
- cULus Listed damp location
- cULus Listed for wet location, covered ceiling, with select trims
- cULus Listed for feed through
- RoHS compliant
- IP rated (Improper Lamp)

E26 Screw Base Non-IC Housing - No Socket Bracket

E7TATNB

6
INCH

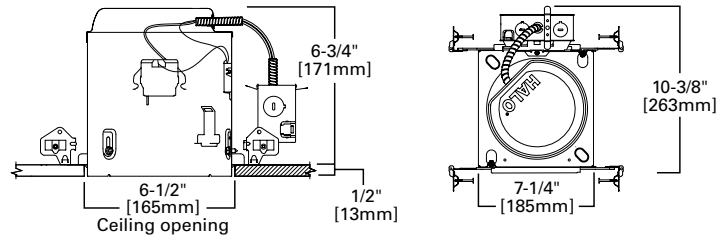

E7TATNB

6" Non-IC, Air-Tite, New Construction Housing, No Socket Bracket, 120V

The E7TATNB is a compact and efficient recessed Non-IC housing optimized and listed for EISA compliant tungsten-halogen, CFL and LED lamps as well as incandescent. Housing is suitable for residential or light commercial applications. For installation in non-insulated ceilings. If ceiling insulation is present, it must be kept 3" from all sides of housing. Housing features Air-Tite code compliant construction. Use with a variety of trims and finishes to create different lighting effects or to match any decor.

The E7TATNB can save installation time. It is designed without a socket plate for use with socket supporting trims only. With these trims there is no need to spend time removing the socket plate, and the fixed lamp position of the socket supporting trims saves on a lamp adjustment time too. May be retrofit with compatible Halo LED lighting systems.



Special Features

- All-Nail™ bar hangers
- q-Channel bars with Pass-N-Thru™
- Hinged j-box with Slide-N-Side™
- Quick Connect™ push wire nuts
- Air-Tite™ code compliant

Compatible Socket Supporting Trims

30	171	405	4051	6130	6215
74	172	419	6120	6145	6222
76	173	420	6121	6146	6230
78	376	430	6125	6150	6255
170	378	478	6126	6170	30SBAT



Trims for use in Halo listed housings



Select trims are classified for use in other housings, see www.cooperlighting.com/legal

Features

Housing

- Single wall die-formed housing
- Housing features a precision rolled interlocking collar which maintains aperture geometry for greater assurance of installation results
- Exclusive Air-Tite gasket meets code where required, and seals between housing, frame and finished ceiling - without need for additional caulk
- May be removed from the plaster frame to provide access to junction box

Socket Plate

- Rigid socket plate adjusts and locks without tools for various lamp sizes
- Socket plate and bracket may be removed when using socket supporting trims

Plaster Frame

- Galvanized steel frame. Housing adjusts in plaster frame to accommodate up to 3/8" - 1" ceiling thickness.
- (2) Regressed locking screws for securing hanger bars

Includes:

- All-Nail™ bar hangers (Details Pg. 15)
- q-Channel bars with Pass-N-Thru™ (Details Pg. 15)
- Hinged junction box with Slide-N-Side™ (Details Pg. 15)
- Quick Connect™ push wire nuts (Details Pg. 15)
- Air-Tite™ code compliant (Details Pg. 15)

Socket

- Porcelain socket with nickel plated brass screw shell
- Snap-in socket speeds installation and attaches directly to the trim for consistent lamp positioning
- Shipped with socket overspray protector installed

Thermal Protector

Self resetting thermal protector deactivates fixture if overheating occurs due to improper lamping or misapplied insulation

Trims

Halo Fit-All concept offers multiple trim options in a variety of design styles, and functional beam distributions to control beam angle and lumen delivery in accommodating various lamp types including Halogen, CFL and LED

Compliance

- cULus Listed 1598 luminaire
- cULus Listed damp location
- cULus Listed for wet location, covered ceiling, with select trims
- Air-Tite code compliant. Certified under ASTM E283; not exceeding 2.0 cfm (0.944 L/s) air leakage rate tested at a 1.57 psf (75 Pa) pressure differential.
- RoHS compliant

Reflectors

30 Reflector, Self-flange

- Self-flange reflector with torsion spring retention
- Accepts a wide range of lamps
- Makes installation Air-Tite regardless of housing used
- Socket supporting reflector

Housings Max Lamp Compatibility

Housings	Max Lamp Compatibility
H7TNB	100W A19, 150W A21, 75W PAR30S, 75W PAR30L, 85W BR30, 100W R30
E7TATNB	100W A19, 150W A21, 75W PAR30S, 75W PAR30L, 150W PAR38, 65W BR30

Compatible with Halogen, Incandescent, LED* or CFL* lamps



30HAT
Haze Reflector, White Trim



30RGAT
Residential Gold Reflector, White Trim



30CAT
Clear Specular Reflector, White Trim

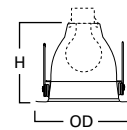

Dimensions**
H: 5" [127mm]
OD: 7-1/4" [184mm]

airTITE

30SBAT Reflector, Self-flange

- Self-flange reflector with torsion spring retention
- Accepts a wide range of lamps
- Makes installation Air-Tite regardless of housing used
- Socket supporting reflector

Housings Max Lamp Compatibility

Housings	Max Lamp Compatibility
H7TNB	100W A19, 150W A21, 75W PAR30S, 150W PAR38, 85W BR30, 100W R30
E7TATNB	100W A19, 150W A21, 75W PAR30S, 75W PAR30L, 150W PAR38, 65W BR30

Compatible with Halogen, Incandescent, LED* or CFL* lamps



30SBAT
Specular Black Reflector & Trim

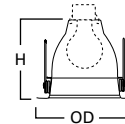

Dimensions**
H: 5" [127mm]
OD: 7-1/4" [184mm]

airTITE

405 Specular Full Cone Reflector

- Full reflector for use with A-lamps
- Accessories available: TRM6 designer trim rings, OT403 oversize trim ring
- Friction clip retention on housing plaster ring
- Removable trim ring
- Socket supporting reflector

Housings Max Lamp Compatibility

Housings	Max Lamp Compatibility
H7TNB	150W A21
E7TATNB	

Compatible with Halogen, Incandescent, LED* or CFL* lamps



405SC
Clear Specular Reflector, White Trim



Friction Clips install on housing plaster ring

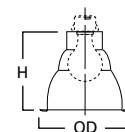

Dimensions**
H: 5" [127mm]
OD: 7-1/4" [184mm]

4051 White Full Cone Reflector, Self-flange

- Full reflector for use with A-lamps
- Friction clip retention on housing plaster ring
- Accessories available: TRM6 designer trim rings, OT403 oversize trim ring
- Socket supporting reflector

Housings Max Lamp Compatibility

Housings	Max Lamp Compatibility
H7TNB	150W A21
E7TATNB	

Compatible with Halogen, Incandescent, LED* or CFL* lamps



4051P
White Reflector, White Self-flange



Friction Clips install on housing plaster ring

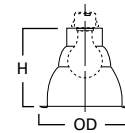

Dimensions**
H: 6" [152mm]
OD: 7-1/4" [184mm]

*UL1993 listed LED & CFL equivalent lamps permitted. Consult lamp manufacturer for conditions of use. Eaton does not warranty the lamp.

**Key: A: Luminous Aperture, H: Height, OD: Trim Outside Diameter

E26 Screw Base Trims

Non-IC "NB" Housings: H7TNB • E7TATNB

6
INCH



6120 Full Cone Reflector, Self-flange

- Full cone reflector
- Torsion spring retention
- Socket supporting reflector
- Self-flange trim ring sized to hide gaps caused by construction tolerances
- Makes installation Air-Tite regardless of housing used



6120WH
White Reflector,
White Self-flange



6120SN
Satin Nickel Reflector,
Satin Nickel Self-flange



6120TBZ
Tuscan Bronze Reflector,
Tuscan Bronze Self-flange

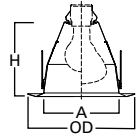

Dimensions**
A: 5-3/8" [137mm]
H: 5-3/8" [138mm]
OD: 7-3/4" [197mm]

Housings	Max Lamp Compatibility
H7TNB E7TATNB	100W A19, 150W A21, 75W PAR30S, 75W PAR30L, 150W PAR38, 85W BR30, 120W BR40

Compatible with Halogen, Incandescent, LED* or CFL* lamps

6121 Shallow Full Cone Reflector, Self-flange

- Shallow full cone reflector
- Torsion spring retention
- Self-flange trim ring sized to hide gaps caused by construction tolerances



6121WH
White Reflector, White
Self-flange

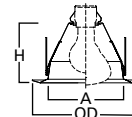

Dimensions**
A: 5-3/8" [137mm]
H: 4-3/8" [110mm]
OD: 7-3/4" [197mm]

Housings	Max Lamp Compatibility
H7TNB E7TATNB	40W A19, 75W PAR30S, 75W PAR30L, 65W BR30

Compatible with Halogen, Incandescent, LED* or CFL* lamps

Baffles

30 Baffle, Self-flange

- Self-flange metal baffle with upper reflector
- Socket supporting baffle
- Torsion spring retention
- Accepts a wide range of lamps
- Makes installation Air-Tite regardless of housing used



30WAT
White Baffle & Reflector,
White Trim



30WATH
White Baffle & Clear Reflector,
White Trim



30PAT
Black Baffle & Clear Reflector,
White Trim



30SNAT
Satin Nickel Baffle & Reflector,
Satin Nickel Trim



30TBZAT
Tuscan Bronze Baffle &
Reflector, Tuscan Bronze Trim

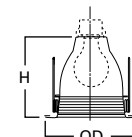

Dimensions**
H: 5" [127mm]
OD: 7-1/4" [184mm]

Housings	Max Lamp Compatibility
H7TNB	100W A19, 150W A21, 75W PAR30S, 75W PAR30L, 150W PAR38, 85W BR30, 100W R30
E7TATNB	100W A19, 150W A21, 75W PAR30S, 75W PAR30L, 150W PAR38, 65W BR30

Compatible with Halogen, Incandescent, LED* or CFL* lamps

6125 Full Cone Baffle, Self-flange

- Full cone baffle
- Torsion spring retention
- Socket supporting baffle
- Self-flange trim ring sized to hide gaps caused by construction tolerances



6125WB
White Baffle, White Self-flange



6125BB
Black Baffle, White Self-flange



6125BKBB
Black Baffle, Black Self-flange

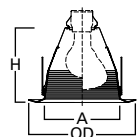

Dimensions**
A: 5-3/8" [137mm]
H: 5-3/8" [138mm]
OD: 7-3/4" [197mm]

Housings	Max Lamp Compatibility
H7TNB E7TATNB	100W A19, 150W A21, 75W PAR30S, 75W PAR30L, 150W PAR38, 85W BR30, 120W BR40

Compatible with Halogen, Incandescent, LED* or CFL* lamps

*UL1993 listed LED & CFL equivalent lamps permitted. Consult lamp manufacturer for conditions of use. Eaton does not warranty the lamp.

**Key: A: Luminous Aperture, H: Height, OD: Trim Outside Diameter



6126 Shallow Full Cone Baffle, Self-flange

- Shallow full cone baffle
- Torsion spring retention
- Socket supporting baffle
- Self-flange trim ring sized to hide gaps caused by construction tolerances



6126WB White Baffle, White Self-flange
6126BB Black Baffle, White Self-flange

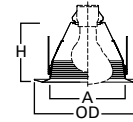

Dimensions**
A: 5-3/8" [137mm]
H: 4-3/8" [110mm]
OD: 7-3/4" [197mm]

Housings	Max Lamp Compatibility
----------	------------------------

H7TNB	E7TATNB	40W A19, 75W PAR30S, 75W PAR30L, 65W BR30
-------	---------	--

Compatible with Halogen, Incandescent, LED* or CFL* lamps

Adjustable – Eyeballs & Gimbals

74 Eyeball 30° Tilt, Self-flange

- Provides optimum position for PAR30S lamps
- Torsion spring retention
- Socket supporting eyeball



74P
White Eyeball, White Trim

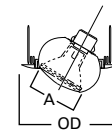

Dimensions**
A: 3-7/8" [98mm]
OD: 8" [203mm]

Housings	Max Lamp Compatibility
----------	------------------------

H7TNB	E7TATNB	75W PAR30S
-------	---------	------------

Compatible with Halogen, Incandescent, LED* or CFL* lamps

76 Gimbal 30° Tilt, Self-flange

- For use with PAR38 lamps
- 30° tilt
- Torsion spring retention



76P
White Gimbal, White Trim

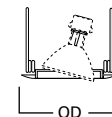

Dimensions**
OD: 8" [203mm]

Housings	Max Lamp Compatibility
----------	------------------------

H7TNB	E7TATNB	150W PAR38 (Side prong lamp recommended)
-------	---------	---

Compatible with Halogen, Incandescent, LED* or CFL* lamps

78 Eyeball 30° Tilt, Self-flange

- 30° tilt, 360° rotation
- Torsion spring retention
- Wide choice of finishes for any decor
- Socket supporting eyeball
- 78PAT makes installation Air-Tite regardless of housing used



78P
White Eyeball, White Trim



78PAT
White Eyeball, White Trim



78SN
Satin Nickel Eyeball,
Satin Nickel Trim



78TBZ
Tuscan Bronze Eyeball,
Tuscan Bronze Trim

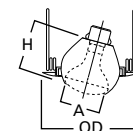

Dimensions**
A: 4" [100mm]
H: 4-1/8" [105mm]
OD: 8" [203mm]

Housings	Max Lamp Compatibility
----------	------------------------

H7TNB	E7TATNB	75W PAR30S, 75W PAR30L, 65W BR30, 75W R30
-------	---------	--

H7TNB	E7TATNB	75W PAR30S, 75W PAR30L, 65W BR30
-------	---------	-------------------------------------

Compatible with Halogen, Incandescent, LED* or CFL* lamps

376 Regressed Gimbal 30° Tilt, Self-flange

- 30° tilt
- Regressed gimbal with baffle
- Torsion spring retention
- Socket supporting gimbal



376W
White Baffle, White Trim



376P
Black Baffle, White Trim

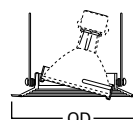

Dimensions**
OD: 7-1/4" [184mm]

Housings	Max Lamp Compatibility
----------	------------------------

H7TNB	E7TATNB	75W PAR30S
-------	---------	------------

Compatible with Halogen, Incandescent, LED* or CFL* lamps

*UL1993 listed LED & CFL equivalent lamps permitted. Consult lamp manufacturer for conditions of use. Eaton does not warranty the lamp.

**Key: A: Luminous Aperture, H: Height, OD: Trim Outside Diameter

E26 Screw Base Trims

Non-IC "NB" Housings: H7TNB • E7TATNB

6
INCH

378 Regressed Gimbal with Splay 25° Tilt, Self-flange

- 25° tilt
- Regressed gimbal with splay trim
- Removable trim ring
- Accessories available: TRM6 designer trim rings, OT403 oversize trim ring
- Friction clips on trim
- Socket supporting gimbal



378P
White Splay, White Trim



378
Clear Specular Splay, White Trim

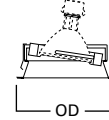

Dimensions**
OD: 7-1/4" [184mm]

Housings Max Lamp Compatibility

H7TNB — 75W PAR30S
E7TATNB

Compatible with Halogen, Incandescent, LED* or CFL* lamps



Friction Clips on Trim

419 Regressed Eyeball with Splay 25° Tilt

- Regressed eyeball with splay
- 25° tilt, 358° rotation
- Accessories available: TRM6 designer trim rings, OT403 oversize trim ring
- Removable trim ring
- Socket supporting trim



419P
White Eyeball & Splay, White Trim

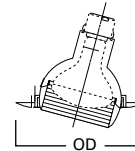

Dimensions**
OD: 7-1/4" [184mm]

Housings Max Lamp Compatibility

H7TNB — 75W PAR30S
E7TATNB

Compatible with Halogen, Incandescent, LED* or CFL* lamps

420 Regressed Eyeball 30° Tilt, Self-flange

- Regressed eyeball with baffle
- Removable trim ring
- Accessories available: TRM6 designer trim rings, OT403 oversize trim ring
- Socket supporting eyeball



420W
White Eyeball & Baffle,
White Trim



420P
White Eyeball & Black Baffle,
White Trim

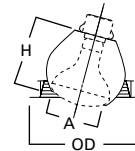

Dimensions**
A: 4" [100mm]
H: 4" [102mm]
OD: 7-1/4" [184mm]

Housings Max Lamp Compatibility

H7TNB 75W PAR30S, 75W PAR30L,
60W BR30
E7TATNB 75W PAR30S, 75W PAR30L

Compatible with Halogen, Incandescent, LED* or CFL* lamps

478 Adjustable Regressed Gimbal with Splay 25° Tilt, Self-flange

- 25° tilt
- Adjustable gimbal with splay trim for PAR38 lamps
- Removable trim ring
- Accessories available: TRM6 designer trim rings, OT403 oversize trim ring
- Friction clips on trim
- Socket supporting gimbal



478P
White Splay, White Trim



Friction Clips on Trim

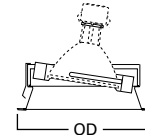

Dimensions**
OD: 7-1/4" [184mm]

Housings Max Lamp Compatibility

H7TNB — 100W PAR38
E7TATNB

Compatible with Halogen, Incandescent, LED* or CFL* lamps

*UL1993 listed LED & CFL equivalent lamps permitted. Consult lamp manufacturer for conditions of use. Eaton does not warranty the lamp.

**Key: A: Luminous Aperture, H: Height, OD: Trim Outside Diameter

6130 Eyeball 35° Tilt, Self-flange

- 35° tilt, 360° rotation
- Adjustable eyeball trim for BR30 and PAR30 lamps
- Torsion spring retention
- Socket supporting eyeball
- Self-flange trim ring sized to hide gaps caused by construction tolerances



6130WH
White Eyeball, White Self-flange

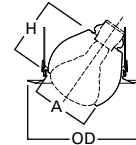

Dimensions**
A: 3-7/8" [100mm]
H: 3-7/8" [100mm]
OD: 7-3/4" [197mm]

Housings	Max Lamp Compatibility
H7TNB E7TATNB	75W PAR30S, 75W PAR30L, 65W BR30

Compatible with Halogen, Incandescent, LED* or CFL* lamps

6170 Gimbal 25° Tilt, Self-flange

- 25° tilt, 360° rotation
- Adjustable gimbal for PAR38 lamps
- Torsion spring retention
- Socket supporting gimbal
- Self-flange trim ring sized to hide gaps caused by construction tolerances



6170WH
White Gimbal, White Self-flange



6170BK
Black Gimbal, Black Self-flange



6170SN
Satin Nickel Gimbal, Satin Nickel Self-flange



6170TBZ
Tuscan Bronze Gimbal, Tuscan Bronze Self-flange

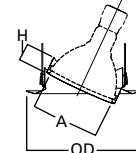

Dimensions**
A: 4-1/2" [113mm]
H: 1-1/5" [30 mm]
OD: 7-3/4" [197mm]

Housings	Max Lamp Compatibility
H7TNB E7TATNB	90W PAR38

Compatible with Halogen, Incandescent, LED* or CFL* lamps

6215 Double Gimbal 30°-50° Tilt, Self-flange

- 30°-50° tilt, 360° rotation
- 50° tilt with double gimbal design using compound angles
- Double gimbal for PAR30 lamps
- Torsion spring retention
- Shallow housings are compatible with PAR30S (short-neck) lamps
- Socket supporting gimbal
- Self-flange trim ring sized to hide gaps caused by construction tolerances



6215WH
White Gimbal, White Self-flange



6215BK
Black Gimbal, Black Self-flange



6215SN
Satin Nickel Gimbal, Satin Nickel Self-flange



6215TBZ
Tuscan Bronze Gimbal, Tuscan Bronze Self-flange

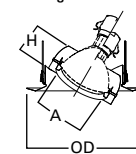

Dimensions**
A: 3-3/8" [84mm]
H: 2" [51mm]
OD: 7-3/4" [197mm]

Housings	Max Lamp Compatibility
H7TNB E7TATNB	75W PAR30S, 75W PAR30L

Compatible with Halogen, Incandescent, LED* or CFL* lamps

6222 Regressed Angle Cut Adjustable Gimbal, 45° Tilt, Self-flange

- 45° tilt, 360° rotation
- Fully regressed gimbal – self-flange ring
- Torsion spring retention
- Socket supporting gimbal
- Reflector and baffle options
- Accommodates tilt of gimbal in a full regressed cut cone
- Self-flange trim ring sized to hide gaps caused by construction tolerances



6222WB
White Baffle, White Trim



6222BB
Black Baffle, White Trim



6222SC
Specular Clear Regressed White Trim



6222H
Haze Reflector, White Trim

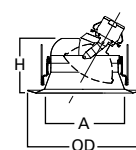

Dimensions**
A: 3-3/4" [95mm]
H: 5-3/8" [137mm]
OD: 7-3/4" [197mm]

Housings	Max Lamp Compatibility
H7TNB E7TATNB	60W PAR16, 50W PAR20, 75W PAR30S, 75W PAR30L

Compatible with Halogen, Incandescent, LED* or CFL* lamps

*UL1993 listed LED & CFL equivalent lamps permitted. Consult lamp manufacturer for conditions of use. Eaton does not warranty the lamp.

**Key: A: Luminous Aperture, H: Height, OD: Trim Outside Diameter

E26 Screw Base Trims

Non-IC "NB" Housings: H7TNB • E7TATNB

6
INCH

Lenses & Wet Location Showerlights

170 Albalite Lens with Reflector

- White trim with Albalite glass lens
- PS version features non-conductive, non-corrosive gasketed polymer (plastic) trim ring
- PS version is "dead-front" construction and is wet location listed for use in showers
- Torsion spring retention
- PS version is Air-Tite; making any installation Air-Tite

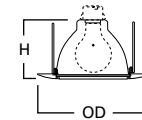

Dimensions**
H: 4" [102mm]
OD: 8" [203mm]

Housings Max Lamp Compatibility

H7TNB — 60W A19
E7TATNB

Compatible with Halogen, Incandescent, LED* or CFL* lamps

171 Drop Opal Glass Lens with Reflector

- White trim with drop opal glass lens
- PS version features non-conductive, non-corrosive gasketed polymer (plastic) trim ring
- PS version is "dead-front" construction and is wet location listed for use in showers
- Torsion spring retention
- PS version is Air-Tite; making any installation Air-Tite

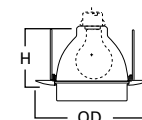

Dimensions**
H: 4" [102mm]
OD: 8" [203mm]

Housings Max Lamp Compatibility

H7TNB — 60W A19
E7TATNB

Compatible with Halogen, Incandescent, LED* or CFL* lamps

172 Dome Glass Lens with Reflector

- Frosted glass dome
- Features "dead-front" construction and is wet location listed for use in showers
- Non-conductive, non-corrosive gasketed polymer (plastic) trim ring
- Torsion spring retention
- Air-Tite trim makes any installation Air-Tite

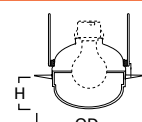

Dimensions**
H: 2-1/8" [54mm]
OD: 7-3/4" [197mm]

Housings Max Lamp Compatibility

H7TNB — 100W A19, 75W PAR30S
E7TATNB

Compatible with Halogen, Incandescent, LED* or CFL* lamps

173 Fresnel Lens with Reflector

- White trim with glass Fresnel lens
- PS version features non-conductive, non-corrosive gasketed polymer (plastic) trim ring
- PS version is "dead-front" construction and is wet location listed for use in showers
- Torsion spring retention
- PS version is Air-Tite; making any installation Air-Tite

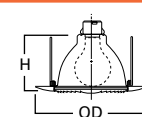

Dimensions**
H: 4" [102mm]
OD: 8" [203mm]

Housings Max Lamp Compatibility

H7TNB — 60W A19
E7TATNB

Compatible with Halogen, Incandescent, LED* or CFL* lamps

*UL1993 listed LED & CFL equivalent lamps permitted. Consult lamp manufacturer for conditions of use. Eaton does not warranty the lamp.

**Key: A: Luminous Aperture, H: Height, OD: Trim Outside Diameter



6145 Open Wet Location, Shallow Reflector, Self-flange

- Open wet location shallow Showerlight for PAR30S and PAR38 outdoor rated lamps ONLY
- Torsion spring retention
- Socket supporting cone
- Self-flange trim ring sized to hide gaps caused by construction tolerances

Housings Max Lamp Compatibility

H7TNB	E7TATNB	75W PAR30S, 75W PAR30L, 150W PAR38
-------	---------	------------------------------------

Compatible with Halogen, Incandescent, LED* or CFL* lamps



6145WH
White Shallow Reflector,
White Self-flange



6145SN
Satin Nickel Shallow Reflector,
Satin Nickel Self-flange



6145TBZ
Tuscan Bronze Shallow Reflector,
Tuscan Bronze Self-flange

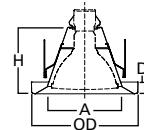

Dimensions**

A: 5-3/8" [136mm]
D: 7/8 [22mm]
H: 4-7/8" [123mm]
OD: 7-3/4" [197mm]

**Outdoor
Rated Lamp
ONLY**
(Purchase
Separately)



Lamp Gasket
(Included)

6146 Open Wet Location, Full Reflector Self-flange

- Open wet location Showerlight for PAR30S and PAR30L outdoor rated lamps ONLY
- Torsion spring retention
- Socket supporting cone
- Self-flange trim ring sized to hide gaps caused by construction tolerances

Housings Max Lamp Compatibility

H7TNB	E7TATNB	75W PAR30S, 75W PAR30L, 150W PAR38
-------	---------	------------------------------------

Compatible with Halogen, Incandescent, LED* or CFL* lamps



6146WH
White Reflector,
White Self-flange



6146SN
Satin Nickel Reflector,
Satin Nickel Self-flange



6146TBZ
Tuscan Bronze Reflector,
Tuscan Bronze Self-flange

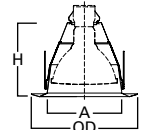

Dimensions**

A: 5-3/8" [137mm]
H: 5-3/8" [138mm]
OD: 7-3/4" [197mm]

**Outdoor
Rated Lamp
ONLY**
(Purchase
Separately)



Lamp Gasket
(Included)



6150 Low Profile, Frosted Glass Dome Lens, Self-flange

- Low profile, frosted glass dome lens
- Wet location Showerlight
- Torsion spring retention
- Non-conductive "dead-front" polymer (plastic) trim ring and glass lens
- Socket supporting internal reflector
- Self-flange trim ring sized to hide gaps caused by construction tolerances

Housings Max Lamp Compatibility

H7TNB	E7TATNB	60W A19, 60W PAR30S
-------	---------	---------------------

Compatible with Halogen, Incandescent, LED* or CFL* lamps



6150WH
Frosted Glass Dome Lens
with Reflector, White
Plastic Self-flange



6150SN
Frosted Glass Dome Lens
with Reflector, Satin Nickel
Plastic Self-flange



6150TBZ
Frosted Glass Dome Lens
with Reflector, Tuscan
Bronze Plastic Self-flange

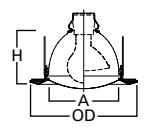

Dimensions**

A: 5-1/8" [130mm]
H: 4-1/5" [107mm]
OD: 7-3/4" [197mm]



*UL1993 listed LED & CFL equivalent lamps permitted. Consult lamp manufacturer for conditions of use. Eaton does not warranty the lamp.

**Key: A: Luminous Aperture, H: Height, OD: Trim Outside Diameter

E26 Screw Base Trims

Non-IC "NB" Housings: H7TNB • E7TATNB

6
INCH



6230 Squircle Frost Glass Lens, Metal Trim, Self-flange

- Low profile frost glass lens
- Wet location Showerlight
- Torsion spring retention
- Self-flange low profile metal trim ring
- Socket supporting internal bracket
- Integral rotation adjustment up to +/- 25° for precise alignment with room



6230AH
Frost Glass Lens, Aluminum Haze Squircle Trim

6230PN
Frost Glass Lens, Polished Nickel Squircle Trim

6230SN
Frost Glass Lens, Satin Nickel Squircle Trim

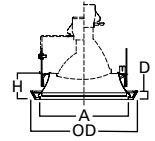

Dimensions**
A: 6" [152mm]
H: 4-1/4" [109mm]
D: 3/4" [20mm]
OD: 7-1/4" [185mm]

Housings		Max Lamp Compatibility
H7TNB	E7TATNB	72W A19, 75W PAR30S

Compatible with Halogen, Incandescent, LED* or CFL* lamps

6255 Soft Square, Frost Curved Glass Lens, Self-flange

- Low profile curved frost glass lens
- Wet location Showerlight
- Torsion spring retention
- Non-conductive "dead-front" polymer (plastic) trim ring and glass lens
- Integral rotation adjustment up to +/- 25° for precise alignment with room
- Integrated socket supporting reflector for even illumination across lens corner-to-corner



6255WH
Frost Curved Glass Lens with Reflector, White Plastic Self-flange

6255SN
Frost Curved Glass Lens with Reflector, Satin Nickel Plastic Self-flange

6255TBZ
Frost Curved Glass Lens with Reflector, Tuscan Bronze Plastic Self-flange

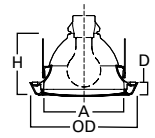

Dimensions**
A: 5-7/8" [149mm]
D: 1" [25mm]
H: 4-1/2" [114mm]
OD: 7-5/8" [194mm]

Housings		Max Lamp Compatibility
H7TNB	E7TATNB	72W A19, 75W PAR30S

Compatible with Halogen, Incandescent, LED* or CFL* lamps

Open, Splay & Wall Wash

430 Wall Wash with Baffle & Full Reflector

- Black or white step baffle with full reflector
- Designed to spread light close to the ceiling to eliminate the "cave effect"
- Torsion spring retention
- Makes installation Air-Tite regardless of housing used



430W
White Baffle, White Trim

430P
Black Baffle, White Trim

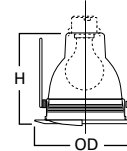

Dimensions**
H: 5" [127mm]
OD: 7-1/4" [184mm]

Housings		Max Lamp Compatibility
H7TNB		100W A19, 90W TB19,
		100W BT15, 100W MB19
E7TATNB		100W A19

Compatible with Halogen, Incandescent, LED* or CFL* lamps

*UL1993 listed LED & CFL equivalent lamps permitted. Consult lamp manufacturer for conditions of use. Eaton does not warranty the lamp.

**Key: A: Luminous Aperture, H: Height, OD: Trim Outside Diameter

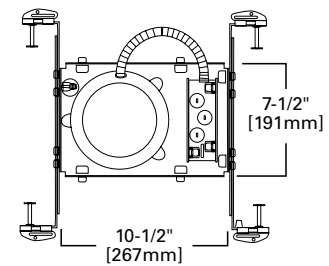
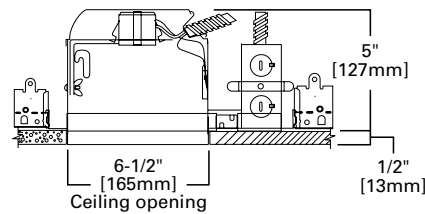

H27T

6" Non-IC, Shallow New Construction Housing, 120V

The H27T recessed housing is designed for shallow ceilings and is a standard in the industry for both light commercial and residential applications. H27 series features robust construction, feed-through listing, Got Nail! bar hangers; and may support use of higher wattage lamps. A wide variety of trims allows a number of different lighting effects to be created with one basic housing. The H27T is for use in non-insulated shallow ceilings. If ceiling insulation is present, it must be kept 3" from all sides of housing. May be retrofit with compatible Halo LED lighting systems.



Special Features

- Got Nail!™ bar hangers
- q-Channel bars with Pass-N-Thru™
- Slide-N-Side™ junction box
- Quick Connect™ push wire nuts

Compatible Trims

70	171	353	6100	6108	6145
71	172 ^o	376	6101	6109	6150
73	173	378	6102	6110	6160
74	301	419	6103	6121 ^o	6215
78 ^o	310	420	6106	6126 ^o	6230
79	328	426	6107	6130	6255
170		4261			



Trims for use in Halo listed housings



Select trims are classified for use in other housings, see www.cooperlighting.com/legal

◊ Air-Tite trims can make the H27T installation ASTM E283 compliant (in a non-insulated ceiling)

Features

Housing

- Single wall die-stamped CRS housing
- White housing paint finish

Plaster Frame

- Galvanized steel construction
- The housing can be removed from plaster frame to provide access to the junction box
- Housing adjusts in plaster frame to accommodate ceilings up to 1-3/8" thick
- Plaster frame features include:
 - Patented regressed locking screw positioned for securing hanger bars from below the ceiling
 - Cutouts for easily crimping hanger bars in position
 - Halo name embossed on plaster frame

Socket Plate

- Rigid socket plate adjusts and locks without tools for various lamp sizes
- Socket plate and bracket may be removed when using socket supporting trims

Includes:

- Got Nail!™ bar hangers (Details Pg. 13)
- q-Channel bars with Pass-N-Thru™ (Details Pg. 13)
- Slide-N-Side™ junction box wire traps (Details Pg. 13)
- Quick Connect™ push wire nuts (Details Pg. 13)

Socket

- Porcelain socket with nickel plated brass screw shell
- Snap-in springs secure socket to socket plate, and may be detached when using socket supporting trims
- Overspray protector included

Thermal Protector

Self resetting thermal protector deactivates fixture if overheating occurs due to improper lamping or misapplied insulation

Trims

Halo Fit-All concept offers multiple trim options in a variety of design styles, and functional beam distributions to control beam angle and lumen delivery in accommodating various lamp types including Halogen, CFL and LED

Compliance

- cULus Listed 1598 luminaire
- cULus Listed damp location
- cULus Listed for wet location, covered ceiling, with select trims
- cULus Listed for feed through
- RoHS compliant
- IP rated (Improper Lamp)

E26 Screw Base Non-IC Shallow Housing

H27RT

6
INCH

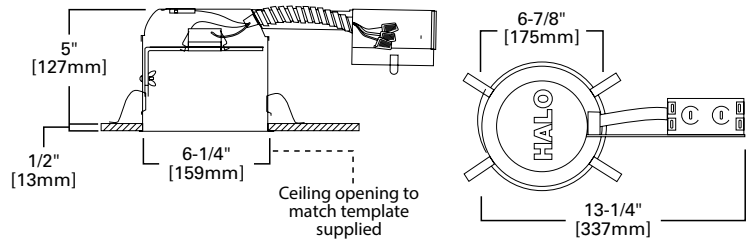

H27RT

6" Non-IC, Shallow Remodel Housing, 120V

The H27RT recessed remodel housing is designed for shallow ceilings and is a standard in the industry for both light commercial and residential applications. H27 series shallow remodel housing features robust construction, full-sized remodel junction box; and may support use of higher wattage lamps. Designed for use in existing ceilings, the remodel housing slips through opening in the finished ceiling. A wide variety of trims allows a number of different lighting effects to be created with one basic housing. The H27RT is for use in non-insulated shallow ceilings. If ceiling insulation is present, it must be kept 3" from all sides of housing. May be retrofit with compatible Halo LED lighting systems.



Special Features

Quick Connect™ push wire nuts

Compatible Trims

74	173 ^o	376	6100	6108	6145
78 ^o	301	378	6101	6109	6150
79	310	419	6102	6110	6215
170 ^o	328	420	6103	6121 ^o	6230
171 ^o	353	426	6106	6126 ^o	6255
172 ^o		4261	6107	6130	



Trims for use in Halo listed housings



Select trims are classified for use in other housings, see www.cooperlighting.com/legal

◊ Air-Tite trims can make the H27RT installation ASTM E283 compliant (in a non-insulated ceiling)

Features

Housing

- Single wall die-stamped CRS shallow housing
- White housing paint finish
- For installation from below the finished ceiling. Integral flange secures fixture against ceiling.

Socket Plate

- Rigid socket plate adjusts and locks without tools for various lamp sizes
- Socket plate and bracket may be removed when using socket supporting trims

Remodel Springs

Four remodel springs secure housing and accommodate 1/2" and 5/8" ceiling material

Includes:

- Quick Connect™ push wire nuts (Details Pg. 13)

Junction Box

- Seven 1/2" trade size conduit knockouts with true pry-out slots are positioned to accommodate straight conduit runs
- Four non-metallic (NM) cable pry-outs included

Socket

- Porcelain socket with nickel plated brass screw shell
- Snap-in springs secure socket to socket plate, and may be detached when using socket supporting trims
- Overspray protector included

Thermal Protector

Self resetting thermal protector deactivates fixture if overheating occurs due to improper lamping or misapplied insulation

Trims

Halo Fit-All concept offers multiple trim options in a variety of design styles, and functional beam distributions to control beam angle and lumen delivery in accommodating various lamp types including Halogen, CFL and LED

Compliance

- cULus Listed 1598 luminaire
- cULus Listed damp location
- cULus Listed for wet location, covered ceiling, with select trims
- cULus Listed for feed through
- RoHS compliant
- IP rated (Improper Lamp)

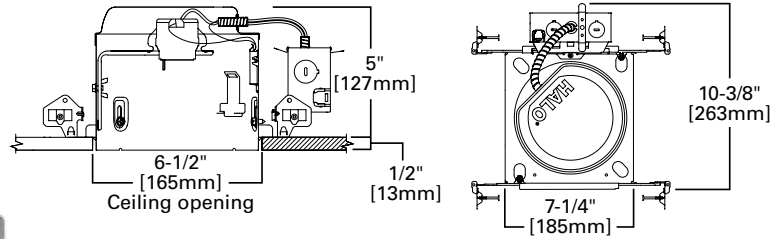

E27TAT

6" Non-IC, Air-Tite, Shallow New Construction Housing, 120V

The E27TAT is a compact and efficient shallow recessed Non-IC housing optimized and listed for EISA compliant tungsten-halogen, CFL and LED lamps as well as incandescent. Housing is suitable for residential or light commercial applications. For installation in non-insulated ceilings. If ceiling insulation is present, it must be kept 3" from all sides of housing. Housing features Air-Tite code compliant construction. Use with a variety of trims and finishes to create different lighting effects or to match any decor. May be retrofit with compatible Halo LED lighting systems.



Special Features

- All-Nail!™ bar hangers
- q-Channel bars with Pass-N-Thru™
- Hinged j-box with Slide-N-Side™
- Quick Connect™ push wire nuts
- Air-Tite™ code compliant

Compatible Trims

70	171	353	6100	6108	6145
71	172	376	6101	6109	6150
73	173	378	6102	6110	6160
74	301	419	6103	6121	6215
78	310	420	6106	6126	6230
79	328	426	6107	6130	6255
170		4261			

Trims for use in Halo listed housings

Select trims are classified for use in other housings, see www.cooperlighting.com/legal

Features

Housing

- Single wall die-formed shallow housing
- Housing features a precision rolled interlocking collar which maintains aperture geometry for greater assurance of installation results
- Integral Air-Tite gasket for code-required gasket between fixture and finished ceiling
- May be removed from the plaster frame to provide access to junction box

Socket Plate

- Rigid socket plate adjusts and locks without tools for various lamp sizes
- Socket plate and bracket may be removed when using socket supporting trims

Plaster Frame

- Galvanized steel frame. Housing adjusts in plaster frame to accommodate up to 3/8" – 1" ceiling thickness.
- (2) Regressed locking screws for securing hanger bars

Includes:

- All-Nail!™ bar hangers (Details Pg. 15)
- q-Channel bars with Pass-N-Thru™ (Details Pg. 15)
- Hinged junction box with Slide-N-Side™ (Details Pg. 15)
- Quick Connect™ push wire nuts (Details Pg. 15)
- Air-Tite™ code compliant (Details Pg. 15)

Socket

- Porcelain socket with nickel plated brass screw shell
- Snap-in springs secure socket to socket plate, and may be detached when using socket supporting trims
- Shipped with socket overspray protector installed

Thermal Protector

Self resetting thermal protector deactivates fixture if overheating occurs due to improper lamping or misapplied insulation

Trims

Halo Fit-All concept offers multiple trim options in a variety of design styles, and functional beam distributions to control beam angle and lumen delivery in accommodating various lamp types including Halogen, CFL and LED

Compliance

- cULus Listed 1598 luminaire
- cULus Listed damp location
- cULus Listed for wet location, covered ceiling, with select trims
- Air-Tite code compliant. Certified under ASTM E283; not exceeding 2.0 cfm (0.944 L/s) air leakage rate tested at a 1.57 psf (75 Pa) pressure differential.
- RoHS compliant

E26 Screw Base Non-IC Shallow Housing

E27RTAT

6
INCH

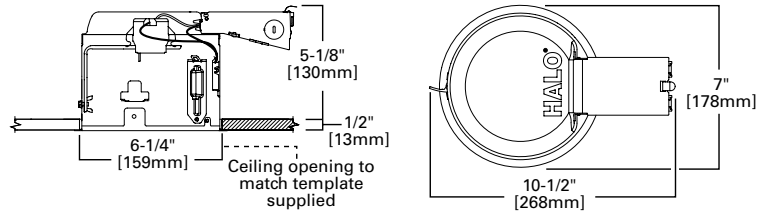

E27RTAT

6" Non-IC, Air-Tite, Shallow Remodel Housing, 120V

The E27RTAT is a compact and efficient shallow recessed remodel Non-IC shallow housing optimized and listed for EISA compliant tungsten-halogen, CFL and LED lamps as well as incandescent. Housing is suitable for residential or light commercial applications. Installation in non-insulated ceilings. If ceiling insulation is present, it must be kept 3" from all sides of housing. Housing features Air-Tite code compliant construction. Use with a variety of trims and finishes to create different lighting effects or to match any decor. May be retrofit with compatible Halo LED lighting systems.



Special Features

- Hinged j-box with Slide-N-Side™
- Quick Connect™ push wire nuts
- Air-Tite™ code compliant

Compatible Trims

74	173	376	6101	6109	6145
78	301	419	6102	6110	6150
79	310	420	6103	6121	6215
170	328	426	6106	6126	6230
171	353	4261	6107	6130	6255
172		6100	6108		



Trims for use in Halo listed housings



Select trims are classified for use in other housings, see www.cooperlighting.com/legal

Features

Housing

- Single wall die-formed housing
- Housing features a precision rolled interlocking collar which maintains aperture geometry for greater assurance of installation results
- Integral Air-Tite gasket for code-required gasket between fixture and finished ceiling
- May be removed from the plaster frame to provide access to junction box

Remodel Retention System - Speed Clamps

- Exclusive two integral speed clamps securely lock housing to ceiling, accommodating 3/8" to 2" ceiling materials

Socket Plate

- Rigid socket plate adjusts and locks without tools for various lamp sizes
- Socket plate and bracket may be removed when using socket supporting trims

Includes:

- Hinged junction box with Slide-N-Side™ (Details Pg. 15)
- Quick Connect™ push wire nuts (Details Pg. 15)
- Air-Tite™ code compliant (Details Pg. 15)

Socket

- Porcelain socket with nickel plated brass screw shell
- Snap-in springs secure socket to socket plate, and may be detached when using socket supporting trims
- Shipped with socket overspray protector installed

Thermal Protector

Self resetting thermal protector deactivates fixture if overheating occurs due to improper lamping or misapplied insulation

Trims

Halo Fit-All concept offers multiple trim options in a variety of design styles, and functional beam distributions to control beam angle and lumen delivery in accommodating various lamp types including Halogen, CFL and LED

Quick Connect™ Wiring Tray

- (3) Color coded 4-port push-in wire nuts included
- Captive tray holds push-nuts in place for one-handed connections to line, neutral & ground
- Speeds installation and increases reliability
- No additional wire nuts required

Compliance

- cULus Listed 1598 luminaire
- cULus Listed damp location
- cULus Listed for wet location, covered ceiling, with select trims
- Air-Tite code compliant. Certified under ASTM E283; not exceeding 2.0 cfm (0.944 L/s) air leakage rate tested at a 1.57 psf (75 Pa) pressure differential.
- RoHS compliant

Reflectors

426 Reflector Cone

- Accepts a wide variety of lamps
- Coil spring retention
- Removable trim ring
- Accessories available: TRM6 designer trim rings, OT403 oversize trim ring

Housings Max Lamp Compatibility

H27T	75W PAR30S, 75W PAR30L, 85W BR30, 100W R30
H27RT	75W PAR30S, 75W PAR30L, 65W BR30, 75W R30
E27TAT	75W PAR30S, 75W PAR30L, 65W BR30
E27RTAT	65W BR30

Compatible with Halogen, Incandescent, LED* or CFL* lamps



426
Clear Specular Reflector Cone, White Trim



426MB
Black Specular Reflector Cone, White Trim



426H
Haze Reflector Cone, White Trim



426SN
Satin Nickel Reflector Cone, Satin Nickel Trim



426TBZ
Tuscan Bronze Reflector Cone, Tuscan Bronze Trim

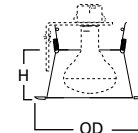

Dimensions**
H: 2-5/8" [67mm]
OD: 7-1/4" [184mm]

4261 White Reflector Cone, Self-flange

- Accepts R and PAR lamps
- Coil spring retention

Housings Max Lamp Compatibility

H27T	75W PAR30S, 75W PAR30L, 100W R30, 85W BR30
H27RT	75W PAR30S, 75W PAR30L, 75W R30, 65W BR30
E27TAT	75W PAR30, 75W PAR30L, 65W BR30
E27RTAT	75W PAR30, 75W PAR30L, 65W BR30

Compatible with Halogen, Incandescent, LED* or CFL* lamps



4261P
White Reflector, White Self-flange

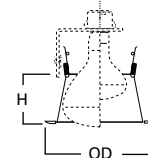

Dimensions**
H: 2-5/8" [67mm]
OD: 7-1/4" [184mm]

6106 Straight Reflector Cone, Self-flange

- Straight sides of cone reflector for large diameter BR40 and PAR38, as well as BR30 and PAR30 lamps
- Self-flange reflector cone
- Coil spring retention
- Self-flange trim ring sized to hide gaps caused by construction tolerances

Housings Max Lamp Compatibility

H27T	E27TAT	75W PAR30S, 75W PAR30L, 65W BR30
H27RT	E27RTAT	65W BR30

Compatible with Halogen, Incandescent, LED* or CFL* lamps



6106SC
Specular Clear Reflector, White Self-flange

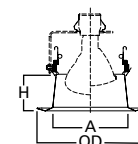

Dimensions**
A: 5-3/8" [137mm]
H: 2-5/8" [68mm]
OD: 7-3/4" [197mm]

6107 Tapered Reflector, Self-flange

- Self-flange reflector cone
- Contoured tapered sides of cone reflector for BR30 and PAR30 lamps
- Coil spring retention
- Self-flange trim ring sized to hide gaps caused by construction tolerances

Housings Max Lamp Compatibility

H27T	E27TAT	75W PAR30S, 75W PAR30L, 65W BR30
H27RT	E27RTAT	65W BR30

Compatible with Halogen, Incandescent, LED* or CFL* lamps



6107SC
Specular Clear Reflector, White Self-flange

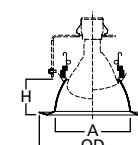

Dimensions**
A: 5-3/8" [137mm]
H: 2-5/8" [65mm]
OD: 7-3/4" [197mm]

*UL1993 listed LED & CFL equivalent lamps permitted. Consult lamp manufacturer for conditions of use. Eaton does not warranty the lamp.

**Key: A: Luminous Aperture, H: Height, OD: Trim Outside Diameter

E26 Screw Base Trims

Non-IC Shallow Housings: H27T • H27RT • E27TAT • E27RTAT

6
INCH



6121 Shallow Full Cone Reflector, Self-flange

- Shallow full cone reflector for A19, PAR30S and BR30 lamps
- Torsion spring retention
- Self-flange trim ring sized to hide gaps caused by construction tolerances



6121WH
White Reflector, White Self-flange

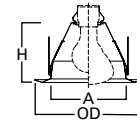

Dimensions**
A: 5-3/8" [137mm]
H: 4-3/8" [110mm]
OD: 7-3/4" [197mm]

Housings		Max Lamp Compatibility
H27T	E27TAT	40W A19, 75W PAR30S,
H27RT	E27RTAT	75W PAR30L, 65W BR30

Compatible with Halogen, Incandescent, LED* or CFL* lamps

Baffles

310 Coilex® Baffle

- Black or white phenolic Coilex baffle with white metal trim ring
- Removable trim ring
- Accessories available: TRM6 designer trim rings, OT403 oversize trim ring
- Coil spring retention



310W
White Coilex Baffle,
White Trim



310P
Black Coilex Baffle,
White Trim



310SN
Satin Nickel Coilex Baffle,
Satin Nickel Trim



310TBZ
Tuscan Bronze Coilex Baffle,
Tuscan Bronze Trim

Housings		Max Lamp Compatibility
H27T	H27RT	75W PAR30S, 75W PAR30L, 65W BR30, 75W R30
E27TAT	E27RTAT	75W PAR30S, 75W PAR30L, 65W BR30

Compatible with Halogen, Incandescent, LED* or CFL* lamps

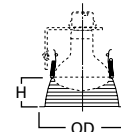

Dimensions**
H: 3-1/16" [78mm]
OD: 7-1/4" [184mm]

353 Metal Baffle

- Metallic finish trim rings and baffles
- Coil spring retention
- Removable trim ring



353SN
Satin Nickel Baffle,
Satin Nickel Trim



353TBZ
Tuscan Bronze Baffle,
Tuscan Bronze Trim

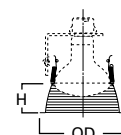

Dimensions**
H: 3" [76mm]
OD: 7-1/4" [184mm]

Housings		Max Lamp Compatibility
H27T	H27RT	75W PAR30S, 75W PAR30L, 65W BR30, 75W R30
E27TAT	E27RTAT	75W PAR30S, 75W PAR30L, 65W BR30

Compatible with Halogen, Incandescent, LED* or CFL* lamps

*UL1993 listed LED & CFL equivalent lamps permitted. Consult lamp manufacturer for conditions of use. Eaton does not warranty the lamp.

**Key: A: Luminous Aperture, H: Height, OD: Trim Outside Diameter

E26 Screw Base Trims

Non-IC Shallow Housings: H27T • H27RT • E27TAT • E27RTAT

6100 Tapered Metal Baffle with (2) Trim Rings

- Contoured tapered sides of metal baffle for BR30 and PAR30 lamps
- Two plastic removable trim rings included narrow 7.25"OD and wide oversized 8.00"OD
- Coil spring retention

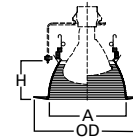

Dimensions**

A: 5-3/4" [148mm]
H: 2-7/8" [74mm]
OD: 7-1/4" [184mm] Narrow
OD: 8" [203mm] Wide

Housings Max Lamp Compatibility

H27T	E27TAT	75W PAR30S, 75W PAR30L, 65W BR30
H27RT	E27RTAT	65W BR30

Compatible with Halogen, Incandescent, LED* or CFL* lamps

6100WB

White Baffle, Narrow & Wide White Trims (Included)

6100BB

Black Baffle, Narrow & Wide White Trims (Included)

6101 Straight Metal Baffle with (2) Trim Rings

- Straight sides of metal baffle for large diameter lamps
- Two plastic removable trim rings included narrow 7.25"OD and wide 8.00"OD
- Coil spring retention

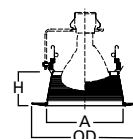

Dimensions**

A: 5-5/8" [144mm]
H: 2-5/8" [66mm]
OD: 7-1/4" [184mm] Narrow
OD: 8" [203mm] Wide

Housings Max Lamp Compatibility

H27T	E27TAT	75W PAR30S, 75W PAR30L, 65W BR30
H27RT	E27RTAT	65W BR30

Compatible with Halogen, Incandescent, LED* or CFL* lamps

6101WB

White Baffle, Narrow & Wide White Trim (Included)

6101BB

Black Baffle, Narrow & Wide White Trim (Included)

6102 Tapered Metal Baffle, Self-flange

- Contoured tapered sides of metal baffle
- Coil spring retention
- Self-flange trim ring sized to hide gaps caused by construction tolerances

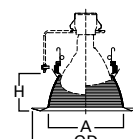

Dimensions**

A: 5-3/8" [137mm]
H: 2-5/8" [65mm]
OD: 7-3/4" [197mm]

Housings Max Lamp Compatibility

H27T	E27TAT	75W PAR30S, 75W PAR30L, 65W BR30
H27RT	E27RTAT	65W BR30

Compatible with Halogen, Incandescent, LED* or CFL* lamps

6102WB

White Baffle, White Self-flange

6102BB

Black Baffle, White Self-flange

6103 Straight Metal Baffle, Self-flange

- Straight sides of metal baffle for large diameter lamps
- Coil spring retention
- Self-flange trim ring sized to hide gaps caused by construction tolerances

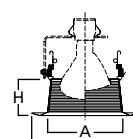

Dimensions**

A: 5-3/8" [137mm]
H: 2-5/8" [68mm]
OD: 7-3/4" [197mm]

Housings Max Lamp Compatibility

H27T	E27TAT	75W PAR30S, 75W PAR30L, 65W BR30
H27RT	E27RTAT	65W BR30

Compatible with Halogen, Incandescent, LED* or CFL* lamps

6103WB

White Baffle, White Self-flange

6103BB

Black Baffle, White Self-flange

6108 Coilex® Straight Plastic Baffle, Self-flange

- Straight sides of Coilex baffle for large diameter BR30 and PAR30 lamps
- Coil spring retention
- Self-flange trim ring sized to hide gaps caused by construction tolerances

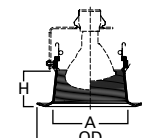

Dimensions**

A: 5-3/8" [137mm]
H: 2-5/8" [68mm]
OD: 7-3/4" [197mm]

Housings Max Lamp Compatibility

H27T	E27TAT	75W PAR30S, 75W PAR30L, 65W BR30
H27RT	E27RTAT	65W BR30

Compatible with Halogen, Incandescent, LED* or CFL* lamps

6108WB

White Plastic Straight Coilex Baffle, White Self-flange

6108BB

Black Plastic Straight Coilex Baffle, White Self-flange

6108KBB

Black Plastic Straight Coilex Baffle, Black Self-flange

*UL1993 listed LED & CFL equivalent lamps permitted. Consult lamp manufacturer for conditions of use. Eaton does not warranty the lamp.

**Key: A: Luminous Aperture, H: Height, OD: Trim Outside Diameter

E26 Screw Base Trims

Non-IC Shallow Housings: H27T • H27RT • E27TAT • E27RTAT

6
INCH

6109 Coilex® Tapered Baffle, Self-flange

- Contoured tapered sides of Coilex baffle for BR30 and PAR30 lamps
- Coil spring retention
- Self-flange trim ring sized to hide gaps caused by construction tolerances

Housings		Max Lamp Compatibility
H27T	E27TAT	75W PAR30S, 75W PAR30L,
H27RT	E27RTAT	65W BR30

Compatible with Halogen, Incandescent, LED* or CFL* lamps



6109WB
White Plastic Tapered Coilex Baffle, White Self-flange



6109BB
Black Plastic Tapered Coilex Baffle, White Self-flange



6109BKBB
Black Plastic Tapered Coilex Baffle, Black Self-flange

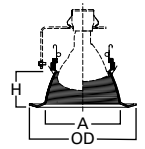

Dimensions**
A: 5-3/8" [137mm]
H: 2-5/8" [65mm]
OD: 7-3/4" [197mm]

6110 Perftex™ Baffle, Self-flange

- Perforated pattern baffle contoured for BR30 and PAR30 lamps
- Coil spring retention
- Self-flange trim ring sized to hide gaps caused by construction tolerances

Housings		Max Lamp Compatibility
H27T	E27TAT	75W PAR30S, 75W PAR30L,
H27RT	E27RTAT	65W BR30

Compatible with Halogen, Incandescent, LED* or CFL* lamps



6110WB
White Perftex Baffle, White Self-flange



6110BB
Black Perftex Baffle, White Self-flange



6110BKBB
Black Perftex Baffle, Black Self-flange

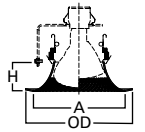

Dimensions**
A: 6-5/8" [169mm]
H: 2-1/8" [54mm]
OD: 7-3/4" [197mm]

6126 Shallow Full Cone Baffle, Self-flange

- Shallow full cone baffle for A19 and PAR30S lamps
- Torsion spring retention
- Socket supporting baffle
- Self-flange trim ring sized to hide gaps caused by construction tolerances

Housings		Max Lamp Compatibility
H27T	E27TAT	40W A19, 75W PAR30S,
H27RT	E27RTAT	75W PAR30L, 65W BR30

Compatible with Halogen, Incandescent, LED* or CFL* lamps



6126WB
White Baffle, White Self-flange



6126BB
Black Baffle, White Self-flange

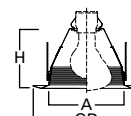

Dimensions**
A: 5-3/8" [137mm]
H: 4-3/8" [110mm]
OD: 7-3/4" [197mm]



Adjustable – Eyeballs & Gimbals

74 Eyeball 30° Tilt, Self-flange

- Provides optimum position for PAR30S lamps
- Torsion spring retention
- Socket supporting eyeball

Housings		Max Lamp Compatibility
H27T	E27TAT	75W PAR30S
H27RT	E27RTAT	

Compatible with Halogen, Incandescent, LED* or CFL* lamps



74P
White Eyeball & Trim

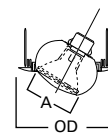

Dimensions**
A: 3-7/8" [98mm]
OD: 8" [203mm]

78 Eyeball 30° Tilt, Self-flange

- 30° tilt, 360° rotation
- Torsion spring retention
- Wide choice of finishes for any decor
- Socket supporting eyeball
- 78PAT makes installation Air-Tite regardless of housing used

Housings		Max Lamp Compatibility
H27T		75W PAR30S, 75W PAR30L,
H27RT		65W BR30, 75W R30
E27TAT		75W PAR30S, 75W PAR30L,
E27RTAT		65W BR30

Compatible with Halogen, Incandescent, LED* or CFL* lamps



78P
White Eyeball, White Trim



78PAT
White Eyeball, White Trim



78SN
Satin Nickel Eyeball,
Satin Nickel Trim



78TBZ
Tuscan Bronze Eyeball,
Tuscan Bronze Trim

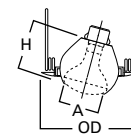

Dimensions**
A: 4" [100mm]
H: 4-1/8" [105mm]
OD: 8" [203mm]

*UL1993 listed LED & CFL equivalent lamps permitted. Consult lamp manufacturer for conditions of use. Eaton does not warranty the lamp.

**Key: A: Luminous Aperture, H: Height, OD: Trim Outside Diameter

Specifications, compliances and dimensions subject to change without notice

376 Regressed Gimbal 30° Tilt, Self-flange

- 30° tilt
- Regressed gimbal with baffle
- Torsion spring retention
- Socket supporting gimbal



376W
White Baffle, White Trim



376P
Black Baffle, White Trim

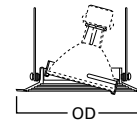

Dimensions**
OD: 7-1/4" [184mm]

Housings	Max Lamp Compatibility
H27T E27TAT	75W PAR30S
H27RT E27RTAT	

Compatible with Halogen, Incandescent, LED* or CFL* lamps

378 Regressed Gimbal with Splay 25° Tilt, Self-flange

- 25° tilt
- Regressed gimbal with splay trim
- Removable trim ring
- Accessories available: TRM6 designer trim rings, OT403 oversize trim ring
- Friction clips on trim
- Socket supporting gimbal



378P
White Splay, White Trim



378
Clear Specular Splay, White Trim

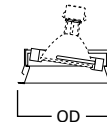

Dimensions**
OD: 7-1/4" [184mm]

Housings	Max Lamp Compatibility
H27T E27TAT	75W PAR30S
H27RT	

Compatible with Halogen, Incandescent, LED* or CFL* lamps



Friction Clips on Trim

419 Regressed Eyeball with Splay 25° Tilt

- Regressed eyeball with splay
- 25° tilt, 358° rotation
- Accessories available: TRM6 designer trim rings, OT403 oversize trim ring
- Removable trim ring
- Socket supporting trim



419P
White Eyeball & Splay,
White Trim

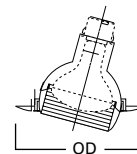

Dimensions**
OD: 7-1/4" [184mm]

Housings	Max Lamp Compatibility
H27T E27TAT	75W PAR30S
H27RT E27RTAT	

Compatible with Halogen, Incandescent, LED* or CFL* lamps

420 Regressed Eyeball 30° Tilt, Self-flange

- Regressed eyeball with baffle splay
- Removable trim ring
- Accessories available: TRM6 designer trim rings, OT403 oversize trim ring
- Socket supporting eyeball



420W
White Eyeball & Baffle,
White Trim



420P
White Eyeball & Black Baffle,
White Trim

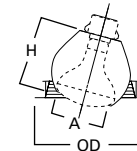

Dimensions**
A: 4" [100mm]
H: 4" [102mm]
OD: 7-1/4" [184mm]

Housings	Max Lamp Compatibility
H27T	75W PAR30S, 75W PAR30L, 75W BR30
H27RT	
E27TAT	75W PAR30S, 75W PAR30L, 65W BR30
E27RTAT	

Compatible with Halogen, Incandescent, LED* or CFL* lamps

6130 Eyeball 35° Tilt, Self-flange

- 35° tilt, 360° rotation
- Adjustable eyeball trim for BR30 and PAR30 lamps
- Torsion spring retention
- Socket supporting eyeball
- Self-flange trim ring sized to hide gaps caused by construction tolerances



6130WH
White Eyeball, White Self-flange

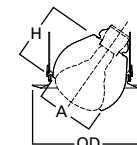

Dimensions**
A: 3-7/8" [100mm]
H: 3-7/8" [100mm]
OD: 7-3/4" [197mm]

Housings	Max Lamp Compatibility
H27T E27TAT	50W PAR30S, 75W PAR30L, 65W BR30
H27RT E27RTAT	

Compatible with Halogen, Incandescent, LED* or CFL* lamps

*UL1993 listed LED & CFL equivalent lamps permitted. Consult lamp manufacturer for conditions of use. Eaton does not warranty the lamp.

Key: **A: Luminous Aperture, **H**: Height, **OD**: Trim Outside Diameter

E26 Screw Base Trims

Non-IC Shallow Housings: H27T • H27RT • E27TAT • E27RTAT

6
INCH

6215 Double Gimbal 30°-50° Tilt, Self-flange

- 30°-50° tilt, 360° rotation
- 50° tilt with double gimbal design using compound angles
- Double gimbal for PAR30S lamps
- Torsion spring retention
- Shallow housings are compatible with PAR30S (short-neck) lamps
- Socket supporting gimbal
- Self-flange trim ring sized to hide gaps caused by construction tolerances



6215WH
White Gimbal,
White Self-flange



6215BK
Black Gimbal,
Black Self-flange



6215SN
Satin Nickel Gimbal,
Satin Nickel Self-flange



6215TBZ
Tuscan Bronze Gimbal,
Tuscan Bronze Self-flange

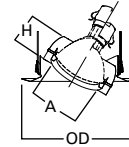

Dimensions**
A: 3-3/8" [84mm]
H: 2" [51mm]
OD: 7-3/4" [197mm]

Housings	Max Lamp Compatibility
H27T E27TAT	60W PAR30S
H27RT E27RTAT	

Compatible with Halogen, Incandescent, LED* or CFL* lamps

Lenses & Wet Location Showerlights

70 Albalite Glass Lens

- White trim, glass Albalite lens
- PS version features "dead-front" construction and is wet location listed for use in showers
- PS version features non-conductive, non-corrosive polymer (plastic) trim ring
- Torsion spring retention



70P
Albalite Glass Lens,
White Trim



70PS
Albalite Glass Lens,
White Trim, Wet Location

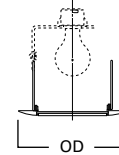

Dimensions**
OD: 8" [203mm]

Housings	Max Lamp Compatibility
H27T	60W A19
E27TAT	

Compatible with Halogen, Incandescent, LED* or CFL* lamps

71 Drop Opal Glass Lens

- White trim, drop opal glass lens
- PS version features "dead-front" construction and is wet location listed for use in showers
- Non-conductive, non-corrosive polymer (plastic) trim ring
- Torsion spring retention



71P
Drop Opal Glass Lens,
White Trim



71PS
Drop Opal Glass Lens,
White Polymer Trim, Wet Location

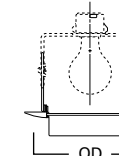

Dimensions**
OD: 8" [203mm]

Housings	Max Lamp Compatibility
H27T	60W A19
E27TAT	

Compatible with Halogen, Incandescent, LED* or CFL* lamps

73 Fresnel Glass Lens

- White trim with glass Fresnel lens
- PS version features "dead-front" construction and is wet location listed for use in showers
- Non-conductive, non-corrosive polymer (plastic) trim ring
- Torsion spring retention



73P
Fresnel Glass Lens,
White Trim



73PS
Fresnel Glass Lens, White Trim,
Wet Location

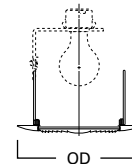

Dimensions**
OD: 8" [203mm]

Housings	Max Lamp Compatibility
H27T	60W A19
E27TAT	

Compatible with Halogen, Incandescent, LED* or CFL* lamps

*UL1993 listed LED & CFL equivalent lamps permitted. Consult lamp manufacturer for conditions of use. Eaton does not warranty the lamp.

**Key: A: Luminous Aperture, H: Height, OD: Trim Outside Diameter

170 Albalite Lens with Reflector

- White trim with Albalite glass lens
- PS version features non-conductive, non-corrosive gasketed polymer (plastic) trim ring
- PS version is "dead-front" construction and is wet location listed for use in showers
- Torsion spring retention
- PS version is Air-Tite; making any installation Air-Tite



170P
Albalite Lens, White Trim



170PS
Albalite Lens, Polymer White Trim

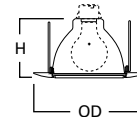

Dimensions**
H: 4" [102mm]
OD: 8" [203mm]

Housings		Max Lamp Compatibility
H27T	E27TAT	60W A19
H27RT	E27RTAT	

Compatible with Halogen, Incandescent, LED* or CFL* lamps

171 Drop Opal Glass Lens with Reflector

- White trim with drop opal glass lens
- PS version features non-conductive, non-corrosive gasketed polymer (plastic) trim ring
- PS version is "dead-front" construction and is wet location listed for use in showers
- Torsion spring retention
- PS version is Air-Tite; making any installation Air-Tite



171P
Drop Opal Lens, White Trim



171PS
Drop Opal Lens, White Polymer Trim

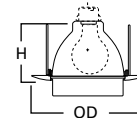

Dimensions**
H: 4" [102mm]
OD: 8" [203mm]

Housings		Max Lamp Compatibility
H27T	E27TAT	60W A19
H27RT	E27RTAT	

Compatible with Halogen, Incandescent, LED* or CFL* lamps

172 Dome Glass Lens with Reflector

- Frosted glass dome
- Features "dead-front" construction and is wet location listed for use in showers
- Non-conductive, non-corrosive gasketed polymer (plastic) trim ring
- Torsion spring retention
- Air-Tite trim makes any installation Air-Tite



172PS
Frosted Glass Dome,
White Polymer Trim



172TBZS
Frosted Glass Dome,
Tuscan Bronze Polymer Trim

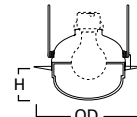

Dimensions**
H: 2-1/8" [54mm]
OD: 7-3/4" [197mm]

Housings		Max Lamp Compatibility
H27T	E27TAT	100W A19, 75W PAR30S
H27RT	E27RTAT	

Compatible with Halogen, Incandescent, LED* or CFL* lamps

173 Fresnel Lens with Reflector

- White trim with glass Fresnel lens
- PS version features non-conductive, non-corrosive gasketed polymer (plastic) trim ring
- PS version is "dead-front" construction and is wet location listed for use in showers
- Torsion spring retention
- PS version is Air-Tite; making any installation Air-Tite



173P
Fresnel Lens, White Trim



173PS
Fresnel Lens, White Polymer Trim

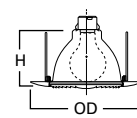

Dimensions**
H: 4" [102mm]
OD: 8" [203mm]

Housings		Max Lamp Compatibility
H27T	E27TAT	60W A19
H27RT	E27RTAT	

Compatible with Halogen, Incandescent, LED* or CFL* lamps

*UL1993 listed LED & CFL equivalent lamps permitted. Consult lamp manufacturer for conditions of use. Eaton does not warranty the lamp.

Key: **A: Luminous Aperture, **H**: Height, **OD**: Trim Outside Diameter

E26 Screw Base Trims

Non-IC Shallow Housings: H27T • H27RT • E27TAT • E27RTAT

6
INCH



6145 Open Wet Location, Shallow Reflector, Self-flange

- Open wet location shallow Showerlight for PAR30S and PAR38 outdoor rated lamps ONLY
- Torsion spring retention
- Socket supporting cone
- Self-flange trim ring sized to hide gaps caused by construction tolerances

Housings		Max Lamp Compatibility
H27T	E27TAT	75W PAR30S, 75W PAR30L, 150W PAR38
H27RT	E27RTAT	75W PAR30S, 75W PAR30L, 90W PAR38

Compatible with Halogen, Incandescent, LED* or CFL* lamps



6145WH
White Shallow Reflector,
White Self-flange



6145SN
Satin Nickel Shallow Reflector,
Satin Nickel Self-flange



6145TBZ
Tuscan Bronze Shallow Reflector,
Tuscan Bronze Self-flange

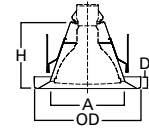

Dimensions**
A: 5-3/8" [136mm]
D: 7/8" [22mm]
H: 4-7/8" [123mm]
OD: 7-3/4" [197mm]



Lamp Gasket
(Included)

6150 Low Profile, Frosted Glass Dome Lens, Self-flange

- Low profile, frosted glass dome lens
- Wet location Showerlight
- Torsion spring retention
- Non-conductive "dead-front" polymer (plastic) trim ring and glass lens
- Socket supporting internal reflector
- Self-flange trim ring sized to hide gaps caused by construction tolerances

Housings		Max Lamp Compatibility
H27T	E27TAT	60W A19, 60W PAR30S
H27RT	E27RTAT	

Compatible with Halogen, Incandescent, LED* or CFL* lamps



6150WH
Frosted Glass Dome Lens
with Reflector, White
Plastic Self-flange



6150SN
Frosted Glass Dome Lens
with Reflector, Satin Nickel
Plastic Self-flange



6150TBZ
Frosted Glass Dome Lens
with Reflector, Tuscan Bronze
Plastic Self-flange

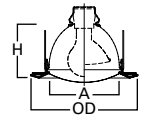

Dimensions**
A: 5-1/8" [130mm]
H: 4-1/5" [107mm]
OD: 7-3/4" [197mm]



6160 Drop White Plastic Lens, Self-flange

- Wet location Showerlight
- Non-conductive "dead-front" polymer (plastic) trim and lens
- Torsion spring retention

Housings		Max Lamp Compatibility
H27T	E27TAT	60W A19, 39W PAR30S

Compatible with Halogen, Incandescent, LED* or CFL* lamps



6160WH
Drop White Plastic Lens,
White Plastic Self-flange

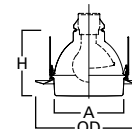

Dimensions**
A: 5-1/8" [130mm]
H: 2-1/4" [57mm]
OD: 7-3/4" [197mm]



6230 Squircle Frost Glass Lens, Metal Trim, Self-flange

- Low profile frost glass lens
- Wet location Showerlight
- Torsion spring retention
- Self-flange low profile metal trim ring
- Socket supporting internal bracket
- Integral rotation adjustment up to +/- 25° for precise alignment with room

Housings		Max Lamp Compatibility
H27T	E27TAT	60W A19, 60W PAR30S
H27RT	E27RTAT	

Compatible with Halogen, Incandescent, LED* or CFL* lamps



6230AH
Frost Glass Lens, Aluminum
Haze Squircle Trim



6230PN
Frost Glass Lens, Polished
Nickel Squircle Trim



6230SN
Frost Glass Lens,
Satin Nickel Squircle Trim

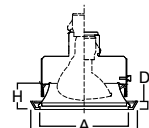

Dimensions**
A: 6" [152mm]
H: 4-1/4" [109mm]
D: 3/4" [20mm]
OD: 7-1/4" [185mm]



*UL1993 listed LED & CFL equivalent lamps permitted. Consult lamp manufacturer for conditions of use. Eaton does not warranty the lamp.

**Key: A: Luminous Aperture, H: Height, OD: Trim Outside Diameter

E26 Screw Base Trims

Non-IC Shallow Housings: H27T • H27RT • E27TAT • E27RTAT



6255 Soft Square, Frost Curved Glass Lens, Self-flange

- Low profile curved frost glass lens
- Wet location Showerlight
- Torsion spring retention
- Non-conductive "dead-front" polymer (plastic) trim ring and glass lens
- Integral rotation adjustment up to +/- 25° for precise alignment with room
- Integrated socket supporting reflector for even illumination across lens corner-to-corner



6255WH
Frost Curved Glass Lens with Reflector, White Plastic Self-flange



6255SN
Frost Curved Glass Lens with Reflector, Satin Nickel Plastic Self-flange



6255TBZ
Frost Curved Glass Lens with Reflector, Tuscan Bronze Plastic Self-flange

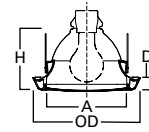

Dimensions**
A: 5-7/8" [149mm]
D: 1" [25mm]
H: 4-1/2" [114mm]
OD: 7-5/8" [194mm]

Housings Max Lamp Compatibility

H27T	E27TAT	60W A19, 60W PAR30S
H27RT	E27RTAT	

Compatible with Halogen, Incandescent, LED* or CFL* lamps

Open, Splay & Wall Wash

79 Pinhole Trim

- 1-7/8" open pinhole for R20 lamp
- Torsion spring retention

Housings Max Lamp Compatibility

H27T	75W PAR30S
H27RT	50W PAR30S
E27TAT	75W PAR30S
E27RTAT	50W PAR30S

Compatible with Halogen, Incandescent, LED* or CFL* lamps



79
Pinhole Trim

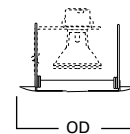

Dimensions**
OD: 8" [203mm]

301 Open Trim

- Open trim for BR30, R30, and PAR30 lamps
- Coil spring retention

Housings Max Lamp Compatibility

H27T	75W PAR30S, 75W PAR30L,
H27RT	65W BR30, 75W R30
E27TAT	75W PAR30S, 75W PAR30L,
E27RTAT	65W BR30

Compatible with Halogen, Incandescent, LED* or CFL* lamps



301P
White Open Trim



301SN
Satin Nickel Open Trim



301TBZ
Tuscan Bronze Open Trim

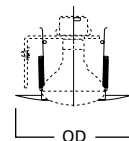

Dimensions**
OD: 7-1/4" [184mm]

328 White Splay Trim

- Splay trim for BR30 and PAR30 lamps
- Coil spring retention

Housings Max Lamp Compatibility

H27T	75W PAR30S, 75W PAR30L,
H27RT	85W BR30, 100W R30
E27TAT	75W PAR30S, 75W PAR30L,
E27RTAT	85W BR30

Compatible with Halogen, Incandescent, LED* or CFL* lamps



328P
White Splay Trim

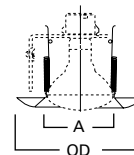

Dimensions**
A: 3-7/8" [98mm]
OD: 7-3/4" [197mm]

*UL1993 listed LED & CFL equivalent lamps permitted. Consult lamp manufacturer for conditions of use. Eaton does not warranty the lamp.

**Key: A: Luminous Aperture, H: Height, OD: Trim Outside Diameter



**E26 Screw Base
Slope Ceiling Solutions**

6
INCH

E26 Screw Base H47 Series IC Slope Housing

H47ICT

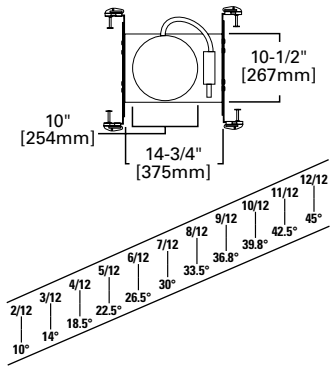
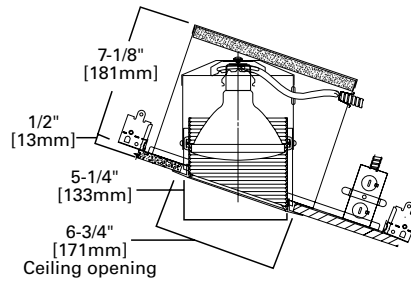

H47ICT

6" IC, New Construction Slope Housing, 120V

Designed for sloped ceiling installations for ceilings from 2/12 to 6/12 pitch. The socket aiming mechanism allows the lamp to be aimed straight down in accordance with ceiling pitch (2/12 to 6/12). H47ICT is designed for use in insulated ceilings where the housing will be in direct contact with insulation*.



Special Features

- Got Nail!™ bar hangers
- Pass-N-Thru™ bars
- Slide-N-Side™ junction box
- Quick Connect™ push wire nuts

Compatible Trims

78°	496	◊ Air-Tite trims can make the H47ICT installation ASTM E283 compliant
170°	498	
	1417	

Features

Housing

Aluminum double wall housing construction

Plaster Frame

Housing adjusts in plaster frame to accommodate up to 1" ceiling thickness. Galvanized steel construction. Plaster frame features include:

- Regressed locking screw for securing hanger bars
- Cutouts for easily crimping hanger bars in position
- Halo name embossed on plaster frame. The housing may be removed from plaster frame to provide access to the junction box.

Includes:

- Got Nail!™ bar hangers (Details Pg. 13)
- Slide-N-Side™ junction box wire traps (Details Pg. 13)
- Pass-N-Thru™ bars (Details Pg. 13)

Socket

- Porcelain socket with nickel plated brass screw shell, snaps into socket plate (or into socket supporting trim for consistent lamp positioning)
- Exclusive socket aiming mechanism swivels and rotates to properly align lamp. Slope indicator provides quick and consistent lamp settings (factory set for 3/12 slope). Shipping insert protects socket from overspray.

Compliance

- cULus Listed 1598 luminaire
- cULus Listed damp location
- cULus Listed for wet location, covered ceiling, with select trims
- cULus Listed for feed through
- cULus Listed for direct contact with insulation and combustible material*
- RoHS compliant

*Not to be used in direct contact with spray foam insulation (Consult NEMA LSD57-2013)

For proper slope aiming install with junction box in downward position

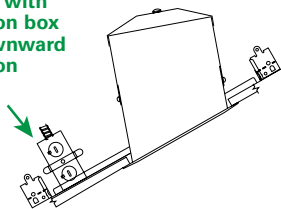

Improper install

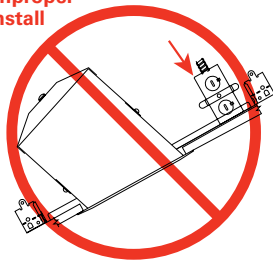

E26 Screw Base H47 Series IC Slope Housing

H47ICAT

6
INCH

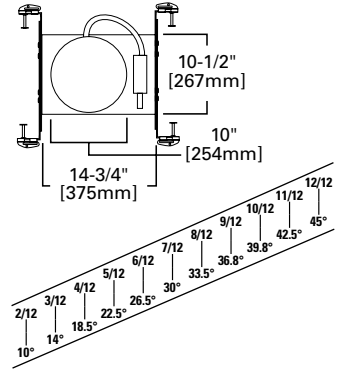
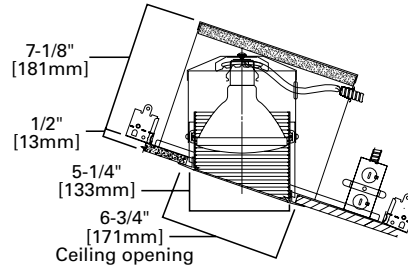

H47ICAT

6" IC, Air-Tite, New Construction Slope Housing, 120V

Designed for sloped ceiling installations for ceilings from 2/12 to 6/12 pitch. The socket aiming mechanism allows the lamp to be aimed straight down in accordance with ceiling pitch (2/12 to 6/12). H47ICAT is designed for use in insulated ceilings where the housing will be in direct contact with insulation*. H47ICAT is Air-Tite gasketed to limit airflow between conditioned spaces and unconditioned areas.



Special Features

- Got Nail!™ bar hangers
- Pass-N-Thru™ bars
- Slide-N-Side™ junction box
- Quick Connect™ push wire nuts
- Air-Tite™ code compliant

Compatible Trims

78	496
170	498
	1417

Features

Housing

Aluminum double wall housing construction

Plaster Frame

Housing adjusts in plaster frame to accommodate up to 1" ceiling thickness. Galvanized steel construction. Plaster frame features include:

- Regressed locking screw for securing hanger bars
- Cutouts for easily crimping hanger bars in position
- Halo name embossed on plaster frame. The housing may be removed from plaster frame to provide access to the junction box.
- Pre-installed Air-Tite™ ready ceiling contact gasket

Includes:

- Got Nail!™ bar hangers (Details Pg. 13)
- Slide-N-Side™ junction box wire traps (Details Pg. 13)
- Pass-N-Thru™ bars (Details Pg. 13)
- Air-Tite™ code compliant (Details Pg. 13)

Socket

- Porcelain socket with nickel plated brass screw shell, snaps into socket plate (or into socket supporting trim for consistent lamp positioning)
- Exclusive socket aiming mechanism swivels and rotates to properly align lamp. Slope indicator provides quick and consistent lamp settings (factory set for 3/12 slope). Shipping insert protects socket from overspray.

Compliance

- cULus Listed 1598 luminaire
- cULus Listed damp location
- cULus Listed for wet location, covered ceiling, with select trims
- cULus Listed for feed through
- cULus Listed for direct contact with insulation and combustible material*
- Air-Tite code compliant. Certified under ASTM E283; not exceeding 2.0 cfm (0.944 L/s) air leakage rate tested at a 1.57 psf (75 Pa) pressure differential.
- RoHS compliant

*Not to be used in direct contact with spray foam insulation (Consult NEMA LSD57-2013)

For proper slope aiming install with junction box in downward position

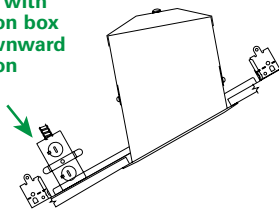

Improper install

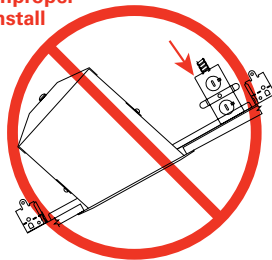

6
INCH

E26 Screw Base H47 Series Non-IC Slope Housing

H47T

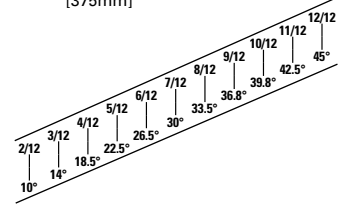
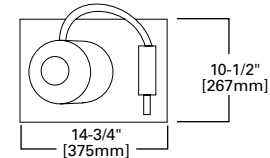
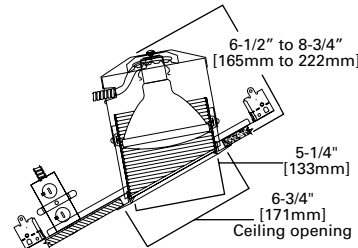

H47T

6" Non-IC, New Construction Slope Housing, 120V

Designed for sloped ceiling installations for ceilings from 2/12 to 6/12 pitch. The socket aiming mechanism allows the lamp to be aimed straight down in accordance with of ceiling pitch (2/12 to 6/12). For use in non-insulated ceilings. If ceiling insulation is present, it must be kept 3" from all sides of housing. Unique telescoping housing feature allows adjustment for lamp regression and joist height of 2" x 8" or higher.



Special Features

- Got Nail!™ bar hangers
- Pass-N-Thru™ bars
- Slide-N-Side™ junction box
- Quick Connect™ push wire nuts

Compatible Trims

78°	496	1417
170°	498	

∅ Air-Tite trims can make the H47T installation ASTM E283 compliant (in a non-insulated ceiling)

Features

Housing

- Telescoping housing for ceiling construction 2" x 8" or higher
- With deeper ceilings the housing provides deeper lamp regression with sharper cutoff

Junction Box

- Seven 1/2" trade size conduit knockouts with true pry-out slots are positioned to accommodate straight conduit runs
- Four non-metallic (NM) cable pry-outs included

Includes:

- Got Nail!™ bar hangers (Details Pg. 13)
- Slide-N-Side™ junction box wire traps (Details Pg. 13)
- Pass-N-Thru™ bars (Details Pg. 13)

Socket

- Porcelain socket with nickel plated brass screw shell
- Exclusive socket aiming mechanism swivels and rotates to properly align lamp
- Slope indicator provides quick and consistent lamp settings (factory set for 3/12 slope). Shipping insert protects socket from overspray.

Integral Thermal Protector

Thermal protector guards against misuse of insulation materials

Compliance

- cULus Listed 1598 luminaire
- cULus Listed damp location
- cULus Listed for wet location, covered ceiling, with select trims
- cULus Listed for feed through
- RoHS compliant
- IP rated (Improper Lamp)

For proper slope aiming install with junction box in downward position

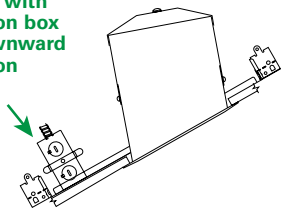

Improper install

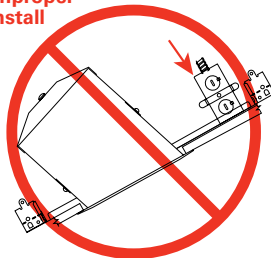

E26 Screw Base H47 Series Slope Trims

H47 Series Housings: H47ICT • H47ICAT • H47T

6
INCH

78 Eyeball 30° Tilt, Self-flange

- 30° tilt, 360° rotation
- Torsion spring retention
- Wide choice of finishes for any decor
- Socket supporting eyeball
- 78PAT makes installation Air-Tite regardless of housing used



78P
White Eyeball, White Trim



78PAT
White Eyeball, White Trim

air-tite



78SN
Satin Nickel Eyeball,
Satin Nickel Trim



78TBZ
Tuscan Bronze Eyeball,
Tuscan Bronze Trim

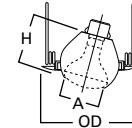

Dimensions**

A: 4" [100mm]
H: 4-1/8" [105mm]
OD: 8" [203mm]

Housings Max Lamp Compatibility

H47ICT	
H47ICAT	65W BR30, 75W R30
H47T	

1417 Low Voltage Eyeball with Baffle 30° Tilt

- Low voltage trim
- Includes 120V transformer for retrofit to H7T and H7RT housings
- Torsion spring retention



1417W
White Baffle, White Trim



1417P
Black Baffle, White Trim

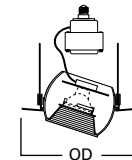

Dimensions**

OD: 7-1/4" [184mm]

Housings Max Lamp Compatibility

H47ICT	20W 12V MR16
H47ICAT	
H47T	50W 12V MR16

170 Albalite Glass Lens with Reflector

- White trim with Albalite glass lens
- PS version features non-conductive, non-corrosive gasketed polymer (plastic) trim ring
- PS version is "dead-front" construction and is wet location listed for use in showers
- Torsion spring retention
- PS version is Air-Tite; making any installation Air-Tite



170P
Albalite Lens, White Trim



170PS
Albalite Lens, Polymer White Trim

air-tite *SlideLight*

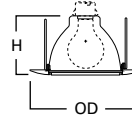

Dimensions**

H: 4" [102mm]
OD: 8" [203mm]

Housings Max Lamp Compatibility

H47ICT	
H47ICAT	60W A19
H47T	

**Key: A: Luminous Aperture, H: Height, OD: Trim Outside Diameter

Specifications, compliances and dimensions subject to change without notice

6
INCH

E26 Screw Base H6451C Slope Housing

H6451C

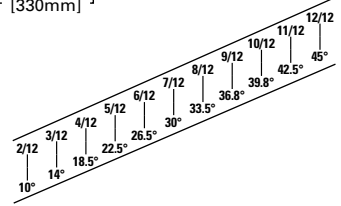
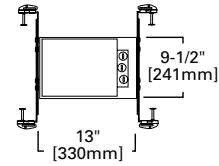
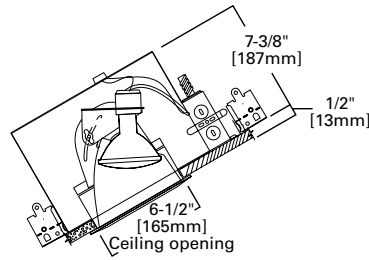

H6451C

6" IC, Air-Tite, New Construction Slope Housing, 120V

Designed for sloped ceiling installations for ceilings from 2/12 to 12/12 pitch. The socket aiming mechanism allows the lamp to be aimed straight down in accordance with of ceiling pitch (2/12 to 12/12). H6451C is designed for use in insulated ceilings where the housing will be in direct contact with insulation*. H6451C is Air-Tite gasketed to limit airflow between conditioned spaces and unconditioned areas.



Special Features

- Got Nail!™ bar hangers
- Pass-N-Thru™ bars
- Slide-N-Side™ junction box
- Quick Connect™ push wire nuts
- Air-Tite™ code compliant

Compatible Trims

78	455
170	456

Features

Housing

Aluminum double wall housing construction

Plaster Frame

Housing adjusts in plaster frame to accommodate up to 1" ceiling thickness. Galvanized steel construction.

Plaster frame features include:

- Regressed locking screw for securing hanger bars
- Cutouts for easily crimping hanger bars in position
- Halo name embossed on plaster frame. The housing may be removed from plaster frame to provide access to the junction box.
- Pre-installed Air-Tite™ ready ceiling contact gasket

Includes:

- Got Nail!™ bar hangers (Details Pg. 13)
- Slide-N-Side™ junction box wire traps (Details Pg. 13)
- Pass-N-Thru™ bars (Details Pg. 13)
- Air-Tite™ code compliant (Details Pg. 13)

Socket

Exclusive socket aiming mechanism swivels and rotates to properly align lamp. Lamp socket and trim can be adjusted 20° laterally for compound slope ceiling or to compensate for off axis aiming. Shipping insert protects socket from overspray.

Integral Thermal Protector

Integral thermal protector guards against improper lamping

Compliance

- cULus Listed 1598 luminaire
- cULus Listed damp location
- cULus Listed for wet location, covered ceiling, with select trims
- cULus Listed for feed through
- cULus Listed for direct contact with insulation and combustible material*
- Air-Tite code compliant. Certified under ASTM E283; not exceeding 2.0 cfm (0.944 L/s) air leakage rate tested at a 1.57 psf (75 Pa) pressure differential.
- Rated for 20W maximum
- Refer to specification sheets online for additional compliance information
- RoHS compliant

*Not to be used in direct contact with spray foam insulation (Consult NEMA LSD57-2013)

For proper slope aiming install with junction box in upward position

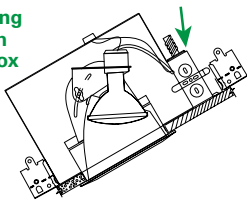

Improper Install

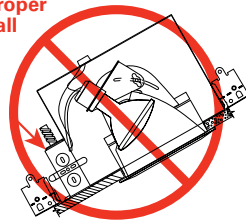

E26 Screw Base H645IC Slope Trims

IC Slope Housings: H645IC

6
INCH

455 Specular Reflector

- Clear, gold or haze reflector
- Removable trim ring
- Accessories available: TRM6 designer trim rings, OT403 oversize trim ring

Housing	Max Lamp Compatibility
H645IC	65W BR30, 75W R30, 75W PAR30L



455SC
Specular Clear Reflector,
White Trim



455H
Haze Reflector, White Trim



455CG
Champagne Gold Reflector,
White Trim

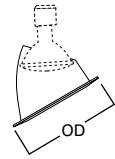

Dimensions**
OD: 7-1/4" [184mm]

456 Seamless Coilex® Baffle Trims

- One piece seamless baffle
- Accessories available: TRM6 designer trim rings, OT403 oversize trim ring

Housing	Max Lamp Compatibility
H645IC	456W: 50W PAR30L, 65W BR30 (75W PAR30L with H1999 Socket Extender)
	456P: 60W BR30, 50W PAR30L



456W
White Coilex Baffle,
White Metal Trim



456P
Black Coilex Baffle,
White Metal Trim

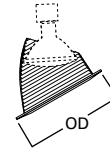

Dimensions**
OD: 7-1/4" [184mm]

Accessory - H1999



Socket Extender

78 Eyeball 30° Tilt, Self-flange

- 30° tilt, 360° rotation
- Torsion spring retention
- Wide choice of finishes for any decor
- Socket supporting eyeball
- 78PAT makes installation Air-Tite regardless of housing used

Housing	Max Lamp Compatibility
H645IC	65W BR30, 75W R30, 75W PAR30L



78P
White Eyeball, White Trim



78PAT
White Eyeball, White Trim



78SN
Satin Nickel Eyeball,
Satin Nickel Trim



78TBZ
Tuscan Bronze Eyeball,
Tuscan Bronze Trim

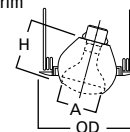

Dimensions**
A: 4" [100mm]
H: 4-1/8" [105mm]
OD: 8" [203mm]

170 Albalite Glass Lens with Reflector

- White trim with Albalite glass lens
- PS version features non-conductive, non-corrosive gasketed polymer (plastic) trim ring
- PS version is "dead-front" construction and is wet location listed for use in showers
- Torsion spring retention
- PS version is Air-Tite; making any installation Air-Tite

Housing	Max Lamp Compatibility
H645IC	60W A19



170P
Albalite Lens, White Trim



170PS
Albalite Lens, White Polymer Trim

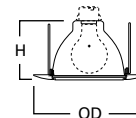

Dimensions**
H: 4" [102mm]
OD: 8" [203mm]

**Key: A: Luminous Aperture, H: Height, OD: Trim Outside Diameter

Specifications, compliances and dimensions subject to change without notice

Specialty Products

H37T - 401AL Heat Light, Non-IC



250W infra-red. For non-insulated ceilings. If insulation is present it must be kept 3" from the fixture on all sides.

Finish:	White (P)
Housing:	8" OD x 5-1/2" Height
Trim:	Brushed aluminum
Rating:	Improper Lamp (IP) Rated

H2932ICTW Lensed Wall / Step Light



cULus Listed for wall mounting in insulation. IC rated for direct contact with insulation* and combustible material, cULus listed for damp location; and feed through. White trim with albalite glass lens.

Housing:	11-1/2" L (enclosure and J-box) x 5-1/2" W x 3-1/2" D
Trim:	5-3/4" H x 9-3/8" L
Finish:	White (P)
Lamp:	25W, A19 max.

*Not to be used in direct contact with spray foam insulation (Consult NEMA LSD57-2013)

H2922ICT Step Light



Step light with white louver trim. Fixture is pre-wired to junction box. cULus listed junction box rated for feed through. 25W A19 lamp.

Finish:	White (P)
Housing:	11-5/8" L x 3-1/2" D x 5-1/2" H
Trim:	9-3/8" L x 5-3/4" H
Rating:	IC rated for direct contact with insulation* and combustible materials. Improper Lamp (IP) Rated

*Not to be used in direct contact with spray foam insulation (Consult NEMA LSD57-2013)

H2922-120PL Step Light



Step light with white louver trim. Fixture is pre-wired to junction box. cULus listed junction box rated for feed through. Integral 120V, 60Hz magnetic ballast. 5W / 7W / 9W Twin Tube 2-pin CFL.

Finish:	White (P)
Housing:	11-5/8" L x 3-1/2" D x 5-1/2" H
Trim:	9-3/8" L x 5-3/4" H
Rating:	IC rated for direct contact with insulation* and combustible materials

*Not to be used in direct contact with spray foam insulation (Consult NEMA LSD57-2013)

H2920ICT Step Light



Step light with white louver trim. Wiring connections are made in fixture. 25W A19 lamp.

Finish:	White (P)
Housing:	8" L x 3-1/2" D x 4-1/2" H
Trim:	9-3/8" L x 5-3/4" H
Rating:	IC rated for direct contact with insulation* and combustible materials. Improper Lamp (IP) Rated

*Not to be used in direct contact with spray foam insulation (Consult NEMA LSD57-2013)

H2900T Thru-Wall Light, Non-IC



Provides lighting on each side of wall. 100W A19 max. Albalite lens. For non-insulated walls. If insulation is present, it must be kept 3" from the fixture on all sides.

Finish:	White (P)
Housing:	13-1/2" L x 4" D x 8-1/4" H
Trim:	11-3/8" L x 7-3/4" H
Rating:	Non-IC, Improper Lamp (IP) Rated

H2932T Closet Light/Shallow Rectangle, Non-IC



60W A19 lamp. White trim with Albalite diffuser. Junction box rated for feed through branch applications. For non-insulated ceilings. If insulation is present, it must be kept 3" from the fixture on all sides.

Finish:	White (P)
Housing:	11-5/8" L x 3-1/2" D x 5-1/2" H
Trim:	9-3/8" L x 5-3/4" H
Rating:	cULus Listed

477 Power-Trac Adapter Trim



Allows (120V) trac lampholders (150W max) to be used with recessed installations. Use with H7T, H7ICT, H27T, H7RT, H7RICT and H27RT housings.

Finish:	White with Black Baffle (477P), White with White Baffle (477W)
OD:	7-1/4"

Specialty Products & Accessories

GA-ATHx-6PK



Optional accessory gasket covers the ceiling cut-out opening on a finished ceiling, for use with H5 & H7 Air-Tite IC housings.

GA-ATH5-6PK H5ICAT Air-Tite™ gaskets (6-Pack)

GA-ATH7-6PK H7ICAT Air-Tite™ gaskets (6-Pack)

Designer Finish Trim Rings



TRM6C Chrome

TRM6SN Satin Nickel

TRM6TBZ Tuscan Bronze

TRM6MB Black Metal

TRM7MB Black plastic

Metal 7 1/4" OD. Compatible with 310*, 376, 378, 400, 404, 405, 410, 416, 419, 420, 424, 425, 426*, 429*, 455CG, 455SC, 456P, 456W, 477, 478, 1412, 1416, 1475.

*Originally supplied with TRM6P white metal trim rings. All others are supplied with white plastic trim rings.

Oversized Trim Rings

For use when ceiling opening is cut too large.

Compatible with 6" trims: 310, 376, 378, 400, 404, 405, 410, 416, 419, 420, 424, 425, 426, 429, 477, 478, 1412, 1416, 1475.



OT400P

Size 6" ID x 9-1/4" OD

Details Oversized white metal trim ring for designated 6" trims.

OT403P

Size 6" ID x 8" OD

Details Oversized gloss white plastic trim ring for designated 6" trims.

Oversized Trim Ring

For use when ceiling opening is cut too large.

Compatible with 4" trims: 990, 992, 993, 994, 996, 998, 999, 1419, 1420, 1421, 1493 and 1498.



OT999P

Size 4" ID x 5-3/4" OD

Details Oversized white metal trim ring.

Oversized Trim Ring



OT460P

Size 7-1/2" ID x 11-1/4" OD

Details Oversized white metal trim ring

800PGR

Size 7-1/2" ID x 8-5/8" OD

Details Oversized trim ring

Dichroic Color Filters



For low voltage MR16 units

L114 UV Filter

L120 Red

L121 Amber

L122 Yellow

L123 Green

L124 Daylight

L125 Blue

L127 Cosmetic Color Filters

L130 Yellow

Transformer



H277

Details Steps 277V line voltage down to 120V fixture operating voltage. 300VA max. For use with Non-IC H7 housings.

H347

Details Same as above but steps 347V down to 120V, 75 VA max. For use with Non-IC H7 housings.

H347200

Details Same as above but steps 347V down to 120V, 200 VA max. For use with Non-IC H7 housings.

6" Retrofit Adapter Band (ML7RAB)



Provides torsion spring mounting capability for 6" housings that do not have torsion spring brackets. 4 pack includes: 4 - retrofit adapter bands, 16 - metal piercing screws, 8 - retrofit lever-action wire nuts

Optical Lenses

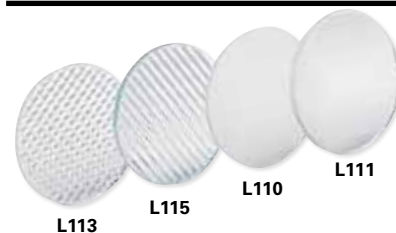

For low voltage MR16 units

L110 Diffuse sand blasted lens

L111 Soft focus textured lens

L113 Prismatic lens

L115 Linear spread lens

Oversized Trim Ring



OT500P

Size 6" ID x 7-1/4" OD

Details Oversized white polymer trim ring for use with 5", 5000 series straight sided trims ONLY. (Not for use with 5100, 5200 or 5300 series trims)

Accessories

H930 R/PAR Lamp Aiming Accessory



For H7T, H7RT, H7ICT, H7ICAT, H7RICT, H7RICAT housings with 310 and 426 trims. Allows lamp to be aimed up to 30° from vertical and rotated 358°. See housing-trim selection for lamp listings.

Socket Extender



H1999

Details For use with selected trims and housings. Extends lamp 1" (25mm).

Coil Springs (RS7H)



Set of 4 coil springs for use with coil spring compatible trims



SD2925 Screwdriver



Screwdriver for tamper resistant screws supplied with H2925 and H2926 brick lights

Oversized LED Retrofit Housing Adapter



OH470WH

Size 6" ID x 9-1/4" OD

Details Oversize housing adapter. For use with open frame retrofit enclosures ML7E26RFK and ML7BXRFK.

6" Open Frame LED Retrofit



ML7BXRFK

Details 6" Non-IC LED retrofit enclosure with hard-wired BX connection for retrofit of 6" open frame fixtures



ML7E26RFK

Details 6" Non-IC LED retrofit enclosure with E26 screw base for 6" open frame fixtures

Mounting Clips



TB7

Details T-Bar attachment clips. Can also be used with HB424 and HB224 hanger bars. Can be used with H7TCP and H750TCP housings hanger bars. Set of four. Order one set per fixture.

Bar Hangers

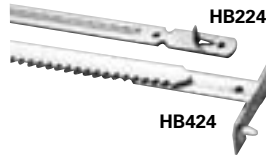

Hanger bars are compatible with the brick and step lighting

HB224

Details One piece hanger bar for 24" maximum joist spacing. Set of two.

HB424

Details Two piece hanger bar for 24" max. joist spacing. Set of four pieces. Order one HB424 per fixture.

GA-ATTRIM-6PK

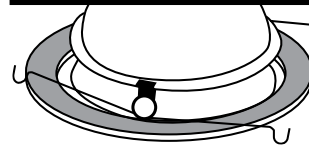

Accessory / spare trim gasket for use with 6" family trims

Incandescent Lamps



Z7 20W T 6-1/2" IF

Z9 40W R16 FL

Z10 100W BR25

Z28 120V GU10 base, line voltage MR16

Low Voltage Lamps



Z21 12V Q50W MR16 NSP

Z26 12V Q50W MR16 NFL

Z31 12V Q50W MR16 FL

Z40 12V Q75W MR16 NSP

Z45 12V Q75W MR16 FL

Z121 50W MR16/Q/10°/TL* (GE Turn-and-Lock base)

Z131 50W MR16/Q/20°/TL* (GE Turn-and-Lock base)

Z124 50W MR16/Q/40°/TL* (GE Turn-and-Lock base)

* Replacement service part ONLY

Index

79.....	283, 328, 354	1447BNBB.....	176	3007SN.....	150, 161
378.....	266, 279, 291, 322, 337, 350	1447GBBB.....	176	3007TBZ.....	150, 161
426.....	260, 273, 300, 316, 346	1447MWBB.....	176	3007WHC.....	150, 161
945.....	184, 192	1447MWWB.....	176	3008FG.....	150, 161
1495.....	199	1449AAG.....	176	3009BKBB.....	149, 160
1945.....	200	1450P.....	331	3009SNBB.....	149, 160
4002.....	184, 191	1453SN.....	198	3009TBZBB.....	149, 160
4003.....	182, 189	1453TBZ.....	198	3009WHBB.....	149, 160
4055.....	184, 192	1464BN.....	171	3009WHWB.....	149, 160
5010.....	209, 221, 235	1464GB.....	171	300P.....	271, 284, 295, 307, 328
120PL.....	362	1464MB.....	171	300SN.....	271, 284, 295, 307, 328
1412P.....	330, 359	1464MW.....	171	300TBZ.....	271, 284, 295, 307, 328
1412W.....	330, 359	1465BNBB.....	171	3010SN.....	149, 160
1416BA.....	331	1465GBBB.....	171	3010WH.....	149, 160
1416C.....	330	1465MWBB.....	171	3011SNBB.....	148
1416W.....	331	1465MWWB.....	171	3011BKBB.....	148, 159
1417BA.....	330	1466MWBB.....	173	3011SNBB.....	159
1417W.....	330	1466MWWB.....	173	3011TBZBB.....	148, 159
1419P.....	198	1467BNBB.....	172	3011WHBB.....	148, 159
1419SN.....	198	1467GBBB.....	172	3011WHWB.....	148, 159
1419TBZ.....	198	1467MWWB.....	172	3012BKBB.....	150, 161
1419W.....	198	1467MWWB.....	172	3012SNBB.....	150, 161
1420P.....	199	1475P.....	331	3012TBZBB.....	150, 161
1420SN.....	199	1475W.....	331	3012WHBB.....	150, 161
1420TBZ.....	199	1479P.....	331	3012WHWB.....	150, 161
1421C.....	197	1479W.....	331	3013BK.....	149, 160
1421CG.....	197	1484BN.....	175	3013SN.....	149, 160
1421H.....	197	1484GB.....	175	3013TBZ.....	149, 160
1421MB.....	197	1484MB.....	175	3013WH.....	149, 160
1421RG.....	197	1484MW.....	175	3017FGS.....	150, 161
1421SN.....	197	1485BNBB.....	175	301P.....	328, 354
1421TBZ.....	197	1485GBBB.....	175	301SN.....	328, 354
1421W.....	197	1485MWBB.....	175	301TBZ.....	328, 354
1430BN.....	170	1485MWWB.....	175	3020WW.....	151, 162
1430GB.....	170	1486MWBB.....	178	303P.....	329
1430H.....	170	1486MWWB.....	178	30CAT.....	260, 273, 288, 315, 334
1430HWF.....	170	1487BNBB.....	177	30HAT.....	260, 273, 288, 315, 334
1430MWWF.....	170	1487GBBB.....	177	30PAT.....	262, 275, 289, 318, 335
1431BBWF.....	170	1487MWWB.....	177	30RGAT.....	260, 273, 288, 315, 334
1431BN.....	170	1487MWWB.....	177	30SBAT.....	260, 273, 288, 315, 334
1431GB.....	170	1489AAG.....	177	30SNAT.....	262, 275, 289, 318, 335
1431VBWF.....	170	1493BC.....	198	30TBZAT.....	262, 275, 289, 318, 335
1432H.....	173	1493P.....	198	30WAT.....	262, 275, 289, 318, 335
1432HWF.....	173	1493TBZ.....	198	30WATH.....	262, 275, 289, 318, 335
1432MWWF.....	173	1493W.....	198	310P.....	263, 275, 301, 318, 347
1433BN.....	172	1495SN.....	199	310SN.....	263, 275, 301, 318, 347
1433GB.....	172	1495TBZ.....	199	310TBZ.....	263, 275, 301, 318, 347
1433H.....	172	1496P.....	199	310W.....	263, 275, 301, 318, 347
1433HWF.....	172	1496SN.....	199	327P.....	271, 295
1433MWWF.....	172	1496TBZ.....	199	328P.....	271, 284, 307, 328, 354
1434BN.....	170	1497P.....	199	353SN.....	263, 276, 301, 318, 347
1434GB.....	170	1498BC.....	200	353TBZ.....	263, 276, 301, 318, 347
1434MB.....	170	1498P.....	200	376P.....	266, 278, 290, 322, 336, 350
1434MW.....	170	1498SN.....	200	376W.....	266, 278, 290, 322, 336, 350
1435BNBB.....	171	1498TBZ.....	200	378P.....	266, 279, 291, 322, 337, 350
1435GBBB.....	171	1498W.....	200	4001BB.....	183, 190
1435MWBB.....	171	170P.....	268, 281, 292, 305, 325, 339, 352, 359, 361	4001WB.....	183, 190
1435MWWB.....	171	170PS.....	268, 281, 292, 305, 325, 339, 352, 359, 361	4010BB.....	183, 190
1436MWBB.....	173	171P.....	268, 281, 293, 305, 325, 339, 352	4010WB.....	183, 190
1436MWWB.....	173	171PS.....	268, 281, 293, 305, 325, 339, 352	4013BB.....	183, 191
1437BNBB.....	172	172PS.....	269, 281, 293, 305, 326, 339, 352	4013WB.....	183, 191
1437GBBB.....	172	172SNS.....	293	401AL.....	329, 362
1437MWBB.....	172	172TBZS.....	269, 281, 293, 305, 326, 339, 352	401P.....	329
1437MWWB.....	172	173P.....	269, 281, 293, 306, 326, 339, 352	4041P.....	261, 274, 288
1440BBWF.....	174	173PS.....	269, 281, 293, 306, 326, 339, 352	404C.....	260, 273, 288
1440BN.....	174	1945B.....	200	404H.....	260, 273, 288
1440GB.....	174	1946BC.....	200	404SN.....	260, 273, 288
1440H.....	174	1951PS.....	200	404TBZ.....	260, 273, 288
1440HWF.....	174	1951SNS.....	200	4051P.....	316, 334
1440MWWF.....	174	1951TBZS.....	200	405SC.....	315, 334
1441BN.....	174	3001BKBB.....	151, 162	410P.....	319
1441GB.....	174	3001SNBB.....	151, 162	410W.....	319
1441VBWF.....	174	3001TBZBB.....	151, 162	419P.....	279, 323, 337, 350
1442H.....	178	3001WHBB.....	151, 162	420P.....	266, 279, 291, 304, 323, 337, 350
1442HWF.....	178	3001WHWB.....	151, 162	420W.....	266, 279, 291, 304, 323, 337, 350
1442MWWF.....	178	3002WHC.....	151, 162	424P.....	284, 329
1443BN.....	176	3003BKBB.....	148, 159	425P.....	284, 329
1443GB.....	176	3003SNB.....	148, 159	425W.....	284, 329
1443H.....	176	3003TBZB.....	148, 159	4261P.....	261, 274, 316, 346
1443HWF.....	176	3003WHBB.....	148, 159	426H.....	260, 273, 300, 316, 346
1443MWWF.....	176	3003WHWB.....	148, 159	426MB.....	260, 273, 300, 316, 346
1444BN.....	174	3004SN.....	148, 159	426SN.....	260, 273, 300, 316, 346
1444GB.....	174	3004TBZ.....	148, 159	426TBZ.....	260, 273, 300, 316, 346
1444MB.....	174	3004WHC.....	148, 159	428P.....	329
1444MW.....	174	3004WHH.....	148, 159	429P.....	261, 274, 316
1445BNBB.....	175	3004WHW.....	148, 159	430P.....	271, 284, 295, 330, 341
1445GBBB.....	175	3006BKBB.....	151, 162	430W.....	271, 284, 295, 330, 341
1445MWBB.....	175	3006SNBB.....	151, 162	455CG.....	361
1445MWWB.....	175	3006TBZBB.....	151, 162	455H.....	361
1446MWBB.....	178	3006WHBB.....	151, 162	455SC.....	361
1446MWWB.....	178	3007PCC.....	150, 161	456P.....	361

Index

456W.....	361	5230TBZ.....	214, 226, 240, 249	951TBZS.....	184, 192
477P.....	362	5255SN.....	214, 226, 240, 249	952PS.....	184, 192
477W.....	362	5255TBZ.....	214, 226, 240, 249	953P.....	182, 189
478P.....	267, 291, 323, 337	5255WH.....	214, 226, 240, 249	953SN.....	182, 189
5000P.....	215, 227, 240, 250	6100BB.....	263, 276, 302, 319, 348	953TBZ.....	182, 189
5000SN.....	215, 227, 240, 250	6100WB.....	263, 276, 302, 319, 348	953W.....	182, 189
5000TBZ.....	215, 227, 240, 250	6101BB.....	264, 276, 302, 319, 348	990P.....	189
5001MB.....	209, 221, 235, 245	6101WB.....	264, 276, 302, 319, 348	990SN.....	189
5001P.....	209, 221, 235, 245	6102BB.....	264, 276, 302, 320, 348	990TBZ.....	189
5001SN.....	209, 221, 235, 245	6102WB.....	264, 276, 302, 320, 348	992P.....	190
5001TBZ.....	209, 221, 235, 245	6103BB.....	264, 277, 302, 320, 348	992SN.....	190
5010W.....	209, 221, 235	6103WB.....	264, 277, 302, 320, 348	992TBZ.....	190
5012P.....	235, 245	6106SC.....	261, 274, 300, 317, 346	992W.....	190
5012W.....	235, 245	6107SC.....	261, 274, 300, 317, 346	993P.....	182, 190
5014MB.....	209, 221	6108BB.....	264, 277, 303, 320, 348	993SN.....	182, 190
5014P.....	209, 221	6108KBB.....	264, 277, 303, 320, 348	993TBZ.....	182, 190
5016P.....	210, 222, 235, 245	6108WB.....	264, 277, 303, 320, 348	993W.....	182, 190
5016W.....	210, 222, 235, 245	6109BB.....	264, 277, 303, 320, 349	996P.....	183, 191
5020BL.....	208, 220, 234, 244	6109KBB.....	264, 277, 303, 320, 349	996SN.....	183, 191
5020H.....	208, 220, 234, 244	6109WB.....	264, 277, 303, 320, 349	996TBZ.....	183, 191
5020P.....	208, 220, 234, 244	6110BB.....	265, 303, 321, 349	998P.....	183, 191
5020SC.....	208, 220, 234, 244	6110KBB.....	265, 303, 321, 349	998SN.....	183, 191
5020SN.....	208, 220, 234, 244	6110WB.....	265, 303, 321, 349	998TBZ.....	183, 191
5020TBZ.....	208, 220, 234, 244	6120SN.....	262, 275, 289, 317, 335	999H.....	182, 189
5021H.....	208, 220, 234, 244	6120TBZ.....	262, 275, 289, 317, 335	999MB.....	182, 189
5021SC.....	208, 220, 234, 244	6120WH.....	262, 275, 289, 317, 335	999P.....	182, 189
5021TBZ.....	208, 220, 234, 244	6121WH.....	262, 275, 289, 301, 317, 335, 347	999RG.....	182, 189
5030P.....	241, 250	6125BB.....	265, 277, 289, 321, 335	999SN.....	182, 189
5030W.....	241, 250	6125KBB.....	265, 277, 289, 321, 335	999TBZ.....	182, 189
5051PS.....	213, 225, 238, 248	6125WB.....	265, 277, 289, 321, 335	999W.....	182, 189
5054PS.....	213, 225, 238, 248	6126BB.....	265, 278, 290, 303, 321, 336, 349	BFR56MH.....	80
5054SNS.....	213, 225, 238, 248	6126WB.....	265, 278, 290, 303, 321, 336, 349	BFR56NFL.....	80
5054TBZ.....	213, 225, 238, 248	6130WH.....	267, 279, 291, 304, 323, 338, 350	BLD4.....	126
5060P.....	211, 222, 236, 246	6145SN.....	269, 282, 293, 306, 326, 340, 353	BLD6.....	128
5070P.....	211, 223, 237, 246	6145TBZ.....	269, 282, 293, 306, 326, 340, 353	CLD7.....	130
5070SN.....	211, 223, 237, 246	6145WH.....	269, 282, 293, 306, 326, 340, 353	E27ICAT.....	298
5070TBZ.....	211, 223, 237, 246	6146SN.....	269, 282, 294, 326, 340	E27RICAT.....	299
5071P.....	212, 223, 237, 246	6146TBZ.....	269, 282, 294, 326, 340	E27RTAT.....	345
5102BB.....	210, 236	6146WH.....	269, 282, 294, 326, 340	E27TAT.....	344
5102WB.....	210, 236	6150SN.....	270, 282, 294, 306, 327, 340, 353	E44MR16ICAT.....	166
5107SC.....	208, 234	6150TBZ.....	270, 282, 294, 306, 327, 340, 353	E44MR16RICAT.....	167
5109BB.....	210, 236	6150WH.....	270, 282, 294, 306, 327, 340, 353	E44PAR16ICAT.....	168
5109KBB.....	210, 236	6160WH.....	282, 327, 353	E44PAR16RICAT.....	169
5109WB.....	210, 236	6162WH.....	270, 283, 294, 306	E4ICATSB.....	181
5110BB.....	210, 236	6170BK.....	267, 292, 324, 338	E4RTATSB.....	188
5110KBB.....	210, 236	6170SN.....	267, 292, 324, 338	E4TATSB.....	187
5110WB.....	210, 236	6170TBZ.....	267, 292, 324, 338	ESICAT.....	205
5120SN.....	208, 220, 234, 244	6170WH.....	267, 292, 324, 338	ESICATNB.....	218
5120TBZ.....	208, 220, 234, 244	6215BK.....	267, 279, 292, 305, 324, 338, 351	ESRICAT.....	206
5120WH.....	208, 220, 234, 244	6215SN.....	267, 279, 292, 305, 324, 338, 351	ESRTAT.....	233
5121WH.....	209, 221	6215TBZ.....	267, 279, 292, 305, 324, 338, 351	ESTAT.....	232
5125BB.....	211, 222, 236, 246	6215WH.....	267, 279, 292, 305, 324, 338, 351	E5TATNB.....	243
5125KBB.....	211, 222, 236, 246	6222BB.....	268, 280, 292, 324, 338	E750ICAT.....	52
5125WB.....	211, 222, 236, 246	6222H.....	268, 280, 292, 324, 338	E750RICAT.....	53
5126BB.....	211, 222	6222SC.....	268, 280, 292, 324, 338	E7ICAT.....	258
5126WB.....	211, 222	6222WB.....	268, 280, 292, 324, 338	E7ICATNB.....	287
5130WH.....	212, 223, 237, 247	6230AH.....	270, 283, 294, 307, 327, 341, 353	E7rICAT.....	259
5135WH.....	212, 224, 237, 247	6230PN.....	270, 283, 294, 307, 327, 341, 353	E7RTAT.....	314
5145SN.....	215, 227, 239, 248	6230SN.....	270, 283, 294, 307, 327, 341, 353	E7TAT.....	313
5145TBZ.....	215, 227, 239, 248	6255SN.....	270, 283, 295, 307, 327, 341, 354	E7TATNB.....	333
5145WH.....	215, 227, 239, 248	6255TBZ.....	270, 283, 295, 307, 327, 341, 354	EL4069.....	101
5146SN.....	215, 227, 239, 248	6255WH.....	270, 283, 295, 307, 327, 341, 354	EL4069xx.....	101
5146TBZ.....	215, 227, 239, 248	691WB.....	82	ELG4069.....	104
5146WH.....	215, 227, 239, 248	692H.....	82	ELG4069xx.....	104
5150SN.....	214, 225, 239, 249	692SC.....	82	ELSG4069.....	104
5150TBZ.....	214, 225, 239, 249	692W.....	82	ELSG4069xx.....	104
5150WH.....	214, 225, 239, 249	693BB.....	82	FTS20C Flood - Bluetooth.....	30
5162WH.....	214, 226, 239, 249	693NB.....	82	GA-ATH5-6PK.....	363
5165BK.....	212, 224, 238, 247	693TBZB.....	82	GA-ATH7-6PK.....	363
5165SN.....	212, 224, 238, 247	693WB.....	82	GA-ATTRIM-6PK.....	364
5165TBZ.....	212, 224, 238, 247	694SN.....	82	H1499ICAT.....	193
5165WH.....	212, 224, 238, 247	694TBZB.....	82	H1499RTAT.....	196
5175SN.....	216, 240	694WB.....	82	H1499T75.....	197
5175TBZ.....	216, 240	695WV.....	82	H1499TAT.....	194
5175WH.....	216, 240	696WB.....	82	H1499TCP.....	195
5176SN.....	216, 228, 241, 250	70P.....	280, 324, 351	H1999.....	182, 183, 184
5176TBZ.....	216, 228, 241, 250	70PS.....	280, 324, 351	H1999.....	364
5176WH.....	216, 228, 241, 250	71P.....	280, 325, 351	H245ICAT.....	42
5185SN.....	216, 241	71PS.....	280, 325, 351	H245RICAT.....	43
5185TBZ.....	216, 241	73P.....	280, 325, 351	H25ICAT.....	207
5185WH.....	216, 241	73PS.....	280, 325, 351	H25ICATNB.....	219
5186SN.....	216, 228, 241, 250	74P.....	265, 278, 290, 304, 321, 336, 349	H277.....	363
5186TBZ.....	216, 228, 241, 250	76P.....	266, 278, 290, 304, 322, 336, 349, 359, 361	H27ICAT.....	296
5186WH.....	216, 228, 241, 250	78P.....	266, 278, 290, 304, 322, 336, 349, 359, 361	H27RICAT.....	297
5222BB.....	213, 224, 238, 247	78PAT.....	266, 278, 290, 304, 322, 336, 349, 359, 361	H27RT.....	343
5222H.....	213, 224, 238, 247	78SN.....	266, 278, 290, 304, 322, 336, 349, 359, 361	H27T.....	342
5222SC.....	213, 224, 238, 247	78TBZ.....	266, 278, 290, 304, 322, 336, 349, 359, 361	H2900T.....	362
5222WB.....	213, 224, 238, 247	800PGR.....	363	H2920ICT.....	362
5230AH.....	214, 226, 240, 249	945B.....	184, 192	H2922.....	362
5230PN.....	214, 226, 240, 249	951PS.....	184, 192	H2922ICT.....	362
5230SN.....	214, 226, 240, 249	951SNS.....	184, 192	H2932ICTW.....	362

Index

H2932T.....	362	HLB4SOTMW.....	115, 119	RL56TRMSNB.....	63
H347.....	363	HLB4STRMMW.....	115	RL56TRMTBZ.....	63
H347200.....	363	HLB4STRMSN.....	115	RL56TRMTBZB.....	63
H36ICAT.....	144	HLB4STRMTBZ.....	115	RL56TRMWH.....	63
H36LVICAT.....	146	HLB6.....	116	RL56TRMWHB.....	63
H36LVRTAT.....	156	HLB6ROTMW.....	117	RL6-DM.....	122
H36LVRTAT277.....	158	HLB6RTRMMW.....	117	RLD4.....	60
H36LVTAT.....	154	HLB6RTRMSN.....	117	RLD6.....	64
H36LVTAT277.....	157	HLB6RTRMTBZ.....	117	RS7H.....	364
H36LVTATCP.....	155	HLB6S.....	116	RSQ4.....	70
H36RTAT.....	153	HLB6SOTMW.....	117	RSQ5.....	71
H36TAT.....	152	HLB6STRMMW.....	117	RSQ6.....	72
H37T.....	362	HLB6STRMSN.....	117	SD2925.....	364
H38ICAT.....	145	HLB6STRMTBZ.....	117	SLD4.....	136
H38LVICAT.....	147	HLC4.....	141	SLD4ACCKIT.....	137
H457ICAT1E.....	96	HLC6.....	142	SLD4BRKT.....	137
H457RICAT1E.....	97	HLM69.....	106, 107	SLD4EXT.....	137
H457RTATE010.....	99	HLM6927.....	108	SLD4RAD.....	137
H457TATE010.....	98	HLM6930.....	108	SLD4TRMSN.....	137
H457TCPE010.....	100	HLM6935.....	108	SLD4TRMTBZ.....	137
H45ICATD010.....	44	HLM6940.....	108	SLD4TRMWH.....	137
H45RICATD010.....	45	HS4R.....	78	SLD6 - Universal.....	139
H47ICAT.....	357	HS4S.....	78	SLD606.....	138
H47ICT.....	356	HWAD1BLE40AWH.....	38	SLD612.....	138
H47T.....	358	HWAS1BLE40AWH.....	35	SLD6ACCKIT.....	140
H550ICAT.....	46	HWB1BLE40AWH.....	36	SLD6BRKT.....	140
H55ORICAT.....	47	HWP1BLE40AWH.....	37	SLD6EXT.....	140
H5ICAT.....	203	L110.....	363	SLD6RAD.....	140
H5ICATNB.....	217	L111.....	363	SLD6SADPLT.....	140
H5RICAT.....	204	L113.....	363	SLD6TRMSN.....	140
H5RT.....	231	L114.....	363	SLD6TRMTBZ.....	140
H5T.....	230	L115.....	363	SLD6TRMWH.....	140
H5TNB.....	242	L120.....	363	SMD4.....	132
H645IC.....	360	L121.....	363	SMD4-DM.....	124
H750ICAT.....	48	L122.....	363	SMD6.....	133
H75ORICAT.....	49	L123.....	363	SMD6-DM.....	125
H750T.....	50	L124.....	363	SMD-RTRMSN.....	134
H750TCP.....	51	L125.....	363	SMD-RTRMTBZ.....	134
H7ICAT.....	255	L127.....	363	SMD-RTRMWH.....	134
H7ICATNB.....	286	L130.....	363	SMD-STRMSN.....	134
H7ICT.....	254	L345SF.....	80	SMD-STRMTBZ.....	134
H7ICTNB.....	285	LA4.....	56	SMD-STRMWH.....	134
H7RICAT.....	257	LA56.....	57	T24HWKIT.....	134
H7RICT.....	256	LT4.....	54, 56, 57	TB7.....	364
H7RT.....	312	LT560.....	55	TIR45FL40.....	77
H7T.....	310	ML4.....	73	TIR45MH12PK.....	77
H7TCP.....	311	ML4D.....	73	TIR45NFL25.....	77
H7TNB.....	332	ML56.....	79	TIR45SP15.....	77
H7UICAT.....	272	ML5606.....	79	TIR45WFL55.....	77
H930.....	260, 263, 364	ML5609.....	79	TIR50AWW25.....	77
H995ICAT.....	40	ML5609xxx.....	79	TL3BBWF.....	87
H995RICAT.....	41	ML5612.....	80	TL3LWW6GH.....	90
H99ICAT.....	180	ML56CLIP.....	81	TL3LWW6GHWF.....	90
H99RTAT.....	186	ML7BXRFK.....	364	TL3LWW6GMW.....	90
H99TAT.....	185	ML7E26RFK.....	364	TL3LWW6GMWRL.....	90
HB224.....	364	ML7RAB.....	81	TL3PIN2GBNBB.....	89
HB424.....	364	ML7RAB.....	363	TL3PIN2GMBBB.....	89
HIWAC1BLE40AWH.....	33	MST20C Motion Flood - Bluetooth.....	31	TL3PIN2GMWBB.....	89
HIWMA1BLE40AWH.....	32	OH470VWH.....	364	TL3PIN2GMWVBB.....	89
HIWSKB1BLE40AWH.....	34	OT400P.....	63, 69, 108	TL3PIN2GMWVBRLL.....	89
HL36A.....	86	OT400P.....	363	TL3PIN2G0RBBB.....	89
HL36SA.....	91	OT403P.....	63, 69, 108	TL3PINBNBB.....	87
HL4NCMF.....	121	OT403P.....	363	TL3PINBBB.....	87
HL4RSMF.....	115, 119, 121	OT460P.....	363	TL3PINMWB.....	87
HL612ICAT.....	106	OT500P.....	363	TL3PINMWBV.....	87
HL618TAT.....	107	OT999P.....	363	TL3PINMWBVBRLL.....	88
HL618TCP.....	107	RA4.....	66	TL3PINORBBB.....	87
HL6FL.....	108	RA4 (NFL).....	66	TL3PR2GMW.....	88
HL6LHRPK.....	108	RA4 (VWFL).....	66	TL3R2GBBWF.....	89
HL6NCMF.....	123	RA4 SeleCCTable.....	65	TL3R2GBN.....	88
HL6NFL.....	108	RA56.....	68	TL3R2GH.....	88
HL6RSMF.....	117, 123	RA56 SeleCCTable.....	67	TL3R2GHWF.....	88
HL6WFL.....	108	RA56069xxNFLWH.....	68	TL3R2GMB.....	88
HLA4.....	118	RA56069xxVWH.....	68	TL3R2GMW.....	88
HLA4S.....	118	RL4.....	58, 59, 60, 61, 64, 70, 71, 72	TL3R2GMWRL.....	88
HLB3.....	112	RL4 - Bluetooth.....	28	TL3R2GORB.....	88
HLB3ROTMW.....	113	RL4-DM.....	120	TL3R2GWBWF.....	89
HLB3RTRMMW.....	113	RL4TRMSN.....	59	TL3RBN.....	87
HLB3RTRMSN.....	113	RL4TRMSNB.....	59	TL3RH.....	87
HLB3RTRMTBZ.....	113	RL4TRMTBZB.....	59	TL3RHWF.....	87
HLB3S.....	112	RL4TRMWH.....	59	TL3RMB.....	87
HLB3SOTMW.....	113	RL4TRMWHB.....	59	TL3RMW.....	87
HLB3STRMMW.....	113	RL4TRTbz.....	59	TL3RMWRLMW.....	87
HLB3STRMSN.....	113	RL56.....	62	TL3RORB.....	87
HLB3STRMTBZ.....	113	RL56 - Bluetooth.....	29	TL3WBWF.....	87
HLB4.....	114	RL56 SeleCCTable.....	61	TL400PC.....	103
HLB4ROTMW.....	115, 119	RL560VH12.....	62	TL400SBK.....	103
HLB4RTRMMW.....	115, 119	RL560VH6.....	62	TL400SN.....	103
HLB4RTRMSN.....	115, 119	RL560VH9.....	62	TL400TBZ.....	103
HLB4RTRMTBZ.....	115, 119	RL56CLIP.....	69	TL400VWH.....	103
HLB4S.....	114	RL56TRMSN.....	63	TL402HS.....	87, 88, 92, 93, 102

Index

TL402SBKS.....	87, 88, 89, 92, 93, 94, 102	TL43R2GBNBB.....	76	TLS3R2GH.....	93
TL402SCS.....	87, 88, 89, 92, 93, 94, 102	TL43R2GGBBB.....	76	TLS3R2GHWF.....	93
TL402SNS.....	87, 88, 89, 92, 93, 94, 102	TL43R2GMBBB.....	76	TLS3R2GMB.....	93
TL402TBZS.....	87, 88, 92, 93, 102	TL43R2GMWBB.....	76	TLS3R2GMW.....	93
TL402WHS.....	87, 88, 89, 92, 93, 94, 102	TL43R2GMWVW.....	76	TLS3R2GMWRL.....	93
TL403BBS.....	102	TL43R2GORBBB.....	76	TLS3R2GORB.....	93
TL403WBS.....	102	TL44S.....	74	TLS3R2GWBBWF.....	94
TL408SNBB.....	102	TL44S2GBCuBB.....	76	TLS3RBN.....	92
TL408TBZBB.....	102	TL44S2GBNBB.....	76	TLS3RH.....	92
TL408WHBB.....	102	TL44S2GGBBB.....	76	TLS3RHWF.....	92
TL408WHWB.....	102	TL44S2GMBBB.....	76	TLS3RMB.....	92
TL409.....	102	TL44S2GMWBB.....	76	TLS3RMV.....	92
TL409WH.....	102	TL44S2GMWVW.....	76	TLS3RMWRL.....	92
TL409WHVWV.....	102	TL44S2GORBBB.....	76	TLS3RORB.....	92
TL409WV.....	102	TL45R.....	75	TLS3WBWF.....	92
TL410H.....	103	TL45R6GMWBB.....	77	TRM690VW.....	63, 69, 81, 108
TL410SBK.....	103	TL45R6GMWV.....	77	TRM6C.....	108
TL410SC.....	103	TL46S.....	75	TRM6C.....	363
TL410SN.....	103	TL46S6GMWBB.....	77	TRM6MB.....	108
TL410TBZ.....	103	TL46S6GMWV.....	77	TRM6MB.....	363
TL410WH.....	103	TLS3BBWF.....	92	TRM6P.....	108
TL411BB.....	103	TLS3LWV6GH.....	95	TRM6SN.....	108
TL411WB.....	103	TLS3LWV6GHWF.....	95	TRM6SN.....	363
TL41R.....	73	TLS3LWV6GMW.....	95	TRM6TBZ.....	108
TL41RBCu.....	76	TLS3LWV6GMWRL.....	95	TRM6TBZ.....	363
TL41RBN.....	76	TLS3PIN2GBNBB.....	94	TRM7MB.....	108
TL41RGB.....	76	TLS3PIN2GMBBB.....	94	TRM7MB.....	363
TL41RMB.....	76	TLS3PIN2GMWBB.....	94	VW695SC.....	81, 82
TL41RMW.....	76	TLS3PIN2GMWVW.....	94	Z10.....	364
TL41RORB.....	76	TLS3PIN2GMWVBR.....	94	Z121.....	364
TL422PS.....	103	TLS3PIN2GORBBB.....	94	Z124.....	364
TL42S.....	73	TLS3PINBNBB.....	92	Z131.....	364
TL42SBCu.....	76	TLS3PINMBBB.....	92	Z21.....	364
TL42SBN.....	76	TLS3PINMWBB.....	92	Z26.....	364
TL42SGB.....	76	TLS3PINMWB.....	92	Z28.....	364
TL42SMB.....	76	TLS3PINMWBR.....	93	Z31.....	364
TL42SMW.....	76	TLS3PINORBBB.....	92	Z40.....	364
TL42SORB.....	76	TLS3PR2GMW.....	93	Z45.....	364
TL43R.....	74	TLS3R2GBBWF.....	94	Z7.....	364
TL43R2GBCuBB.....	76	TLS3R2GBN.....	93	Z9.....	364



Photography: Jeffrey A. Davis Photography, Inc. © 2018

HALO[®]



SMART LIGHTING | RECESSED | TRACK | SURFACE

For over 60 years, **HALO[®]** has been the industry leader in recessed and track lighting providing innovative and contractor-friendly lighting products. **HALO** has been chosen as the Brand Leader by *Builder* magazine subscribers for the last twenty-three consecutive years, further reinforcing **HALO's** longstanding industry leadership, brand equity and user preferences.



Photography: Jeffrey A. Davis Photography, Inc. © 2018

Lighting Product Lines

- Ametrix
- AtLite
- Corelite
- Ephesus
- Fail-Safe
- HALO
- HALO Commercial
- Invue
- io
- IRiS
- Lumark
- Lumière
- McGraw-Edison
- Metalux
- MWS
- Neo-Ray
- Portfolio
- RSA
- Shaper
- Streetworks
- Sure-Lites

Controls Product Lines

- Greengate

Connected Lighting Systems

- Fifth Light (Canada Only)
- HALO Home
- WaveLinx

IoT Platform

- Trellix



Cooper Lighting Solutions
 1121 Highway 74 South
 Peachtree City, GA 30269
 P: 770-486-4800
www.cooperlighting.com

Canada Sales
 5925 McLaughlin Road
 Mississauga, Ontario L5R 1B8
 P: 905-501-3000
 F: 905-501-3172

© 2019 Cooper Lighting Solutions
 All Rights Reserved
 Printed in USA
 Publication No. CA518002EN
 March 31, 2021 6:55 PM

Cooper Lighting Solutions is a registered trademark.

All other trademarks are property of their respective owners.

Product availability, specifications, and compliances are subject to change without notice.