

# Channel nuts & hardware



## Channel Nuts

Channel nuts are one of the main components of our strut system. It is designed to provide essential gripping power and ease during installation. Channel nuts are press formed, machined and hardened from steel which meets the requirements of ASTM A108 or ASTM A36 for our larger sizes.

## Bolts, Screws, and Nuts

All bolts, screws and nuts meet the physical and chemical requirements of ASTM A307, SAE J429 or ASTM A563, and have unified inch screw threads (coarse, UNC). ISO metric threads are also available on special request.

## Recommended Torque

Bolt Size	1/4"-20	5/16"-18	3/8"-16	1/2"-13
Foot/Lbs.	6	11	19	50
Nm	8	15	26	68

Bolt Size	M6x1	M8 x1.25	M10 x 1.5	M12x1.75
Nm	12	17	36	62
Foot/Lbs.	9	13	27	46

## Materials & Finishes\*

\*Unless otherwise Noted. Refer to the product page for materials and finishes available by catalog number.

**Note:** Channel nuts are not available in HDG, Aluminum, or Stainless Steel Type 304

Finish Code	Finish	Specification
PLN	Plain	ASTM A108/A307 Gr. A, ASTM A563, SAE J429
ZN	Electro-Plated Zinc	ASTM B633 SC1 Type III
CZ	Chromium Zinc	ASTM F1136 Gr. 3
HDG	Hot-Dipped Galvanized	ASTM A153
SS6	Stainless Steel Type 316	MPIF 35/ASTM F593
AL	Aluminum	ASTM F468 S4

## Metric

Metric dimensions are shown in parentheses. Unless Noted, all metric dimensions are in millimeters.

**Note:** Channel nuts and hardware are sold in full box quantities.

## Standard Channel Nuts

Numbering Example:

**N 7 25 - (\*) WO**

Nut Type	Channel Type	Thread Size	Stud Length	Suffix
N = Standard Nut	7 = Tall Channels	21 = #8-32	* = Specify Length of stud below for Stud Nut or Twirl Stud Nuts	WO = Without Spring
TN = Twirl-Nut™	B11	22 = #10-24	$\frac{3}{4}$ = $\frac{3}{4}$ "	___ = Twirl-Nut or nuts with springs have blank suffix
SN = Stud Nut	B12	27 = #10-32	1 = 1"	
STN = Stud Twirl-Nut	2 = Medium Channels	24 = $\frac{1}{4}$ "-20	$1\frac{1}{4}$ = $1\frac{1}{4}$ "	
NW = Combo Nut Washer	B22	23 = $\frac{5}{16}$ "-18	$1\frac{1}{2}$ = $1\frac{1}{2}$ "	
	B24	28 = $\frac{3}{8}$ "-16		
	B32	26 = $\frac{7}{16}$ "-14		
	5 = Short Channels	25 = $\frac{1}{2}$ "-13		
	B42	55 = $\frac{5}{8}$ "-11		
	B52	75 = $\frac{3}{4}$ "-10		
	B54	78 = $\frac{7}{8}$ "-9		

## Metric Channel Nuts

Numbering Example:

**BMS - 6 M**

Nut Type	Metric Thread Size	Suffix
BMS = Spring Nut	3 = M3.5	S = Short Spring
BMS-D = Spring Nut ( $\frac{1}{2}$ " thick)	4 = M4	M = Medium Spring
BMT = Twirl-Nut	5 = M5	L = Long Spring
BMT-D = Twirl-Nut ( $\frac{1}{2}$ " thick)	6 = M6	___ = Twirl-Nut and nuts without springs have blank suffix
BMM = Spring Nut (Mini channel)	8 = M8	
	10 = M10	
	12 = M12	

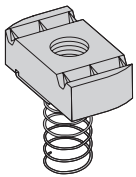

Spring Nut

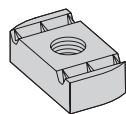

Nut without Spring

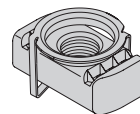

Twirl-Nut

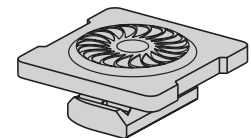

Combo Nut Washer

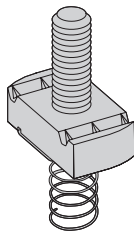

Stud Nut with Spring

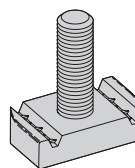

Stud Nut without Spring

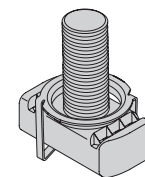

Twirl Stud Nut

Reference page 78 for general fitting and standard finish specifications.

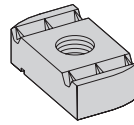

**Note:** See page 84 for resistance to slip & page 85 for pull-out strength. Channel nuts and hardware are sold in full box quantities.

## Nut Without Spring

Part No.	Thread Size	Fits Channel Sizes	Nut Thickness		Wt./C	
			In.	mm	Lbs.	kg
<b>N221WO</b>	#8-32	All sizes except B62 & B72	1/4"	(6.3)	7.0	(3.17)
<b>N227WO</b>	#10-32	All sizes except B62 & B72	1/4"	(6.3)	7.0	(3.17)
<b>N222WO</b>	#10-24	All sizes except B62 & B72	1/4"	(6.3)	7.0	(3.17)
<b>N224WO</b>	1/4-20	All sizes except B62 & B72	1/4"	(6.3)	6.7	(3.04)
<b>N223WO</b>	5/16-18	All sizes except B62 & B72	1/4"	(6.3)	6.7	(3.04)
<b>N228WO</b>	3/8-16	All sizes except B62 & B72	3/8"	(9.5)	9.3	(4.22)
<b>N226WO</b>	7/16-14	All sizes except B62 & B72	3/8"	(9.5)	8.8	(3.99)
<b>N225WO</b>	1/2-13	B11, B12, B22, B24, B32	1/2"	(12.7)	11.6	(5.26)
<b>N525WO</b>	1/2-13	B42, B52, B54	3/8"	(9.5)	8.8	(3.99)
<b>N255WO</b>	5/8-11	B11, B12, B22, B24, B32	1/2"	(12.7)	16.4	(7.44)
<b>N555WO</b>	5/8-11	B42, B52, B54	3/8"	(9.5)	10.2	(4.62)
<b>N275WO</b>	3/4-10	B11, B12, B22, B24, B32	1/2"	(12.7)	14.5	(6.58)
<b>N575WO</b>	3/4-10	B42, B52, B54	3/8"	(9.5)	8.8	(3.99)
<b>N278WO</b>	7/8-9	B11, B12, B22, B24, B32	1/2"	(12.7)	12.5	(5.67)

## Metric Threads

<b>BMS-6</b>	M6 x 1	All sizes except B62 & B72	1/4"	(6.3)	6.9	(3.13)
<b>BMS-8</b>	M8 x 1.25	All sizes except B62 & B72	1/4"	(6.3)	6.7	(3.04)
<b>BMS-10</b>	M10 x 1.5	All sizes except B62 & B72	3/8"	(9.5)	9.6	(4.35)
<b>BMS-12</b>	M12 x 1.75	All sizes except B62 & B72	3/8"	(9.5)	9.2	(4.17)
<b>BMS-D-12</b>	M12 x 1.75	B11, B12, B22, B24, B32	1/2"	(12.7)	12.2	(5.53)

**Note:** For mini channel nut information see page 245.

Note: See page 84 for resistance to slip & page 85 for pull-out strength.  
Channel nuts and hardware are sold in full box quantities.

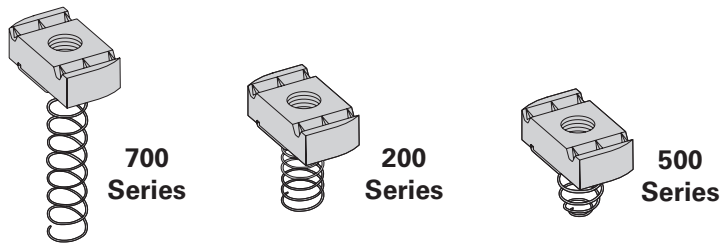

## Spring Nut

Part No.	Thread Size	Fits Channel Sizes	Nut Thickness		Wt./C	
			In.	mm	Lbs.	kg
N721	#8-32	B11 & B12	1/4"	(6.3)	7.0	(3.17)
N221	#8-32	B22, B24, B32	1/4"	(6.3)	7.0	(3.17)
N521	#8-32	B42, B52, B54	1/4"	(6.3)	7.0	(3.17)
N727	#10-32	B11 & B12	1/4"	(6.3)	7.0	(3.17)
N227	#10-32	B22, B24, B32	1/4"	(6.3)	7.0	(3.17)
N527	#10-32	B42, B52, B54	1/4"	(6.3)	7.0	(3.17)
N722	#10-24	B11 & B12	1/4"	(6.3)	7.0	(3.17)
N222	#10-24	B22, B24, B32	1/4"	(6.3)	7.0	(3.17)
N522	#10-24	B42, B52, B54	1/4"	(6.3)	7.0	(3.17)
N724	1/4-20	B11 & B12	1/4"	(6.3)	6.7	(3.04)
N224	1/4-20	B22, B24, B32	1/4"	(6.3)	6.7	(3.04)
N524	1/4-20	B42, B52, B54	1/4"	(6.3)	6.7	(3.04)
N723	5/16-18	B11 & B12	1/4"	(6.3)	6.7	(3.04)
N223	5/16-18	B22, B24, B32	1/4"	(6.3)	6.7	(3.04)
N523	5/16-18	B42, B52, B54	1/4"	(6.3)	6.7	(3.04)
N728	3/8-16	B11 & B12	3/8"	(9.5)	9.3	(4.22)
N228	3/8-16	B22, B24, B32	3/8"	(9.5)	9.3	(4.22)
N528	3/8-16	B42, B52, B54	3/8"	(9.5)	9.3	(4.22)
N726	7/16-14	B11 & B12	3/8"	(9.5)	8.8	(3.99)
N226	7/16-14	B22, B24, B32	3/8"	(9.5)	8.8	(3.99)
N526	7/16-14	B42, B52, B54	3/8"	(9.5)	8.8	(3.99)
N725	1/2-13	B11 & B12	1/2"	(12.7)	11.6	(5.26)
N225	1/2-13	B22, B24, B32	1/2"	(12.7)	11.6	(5.26)
N525	1/2-13	B42, B52, B54	3/8"	(9.5)	8.8	(3.99)
N755	5/8-11	B11 & B12	1/2"	(12.7)	16.4	(7.44)
N255	5/8-11	B22, B24, B32	1/2"	(12.7)	16.4	(7.44)
N555	5/8-11	B42, B52, B54	3/8"	(9.5)	10.2	(4.62)
N775	3/4-10	B11 & B12	1/2"	(12.7)	14.5	(6.58)
N275	3/4-10	B22, B24, B32	1/2"	(12.7)	14.5	(6.58)
N575	3/4-10	B42, B52, B54	3/8"	(9.5)	8.8	(3.99)
N778	7/8-9	B11 & B12	1/2"	(12.7)	12.5	(5.67)
N278	7/8-9	B22, B24, B32	1/2"	(12.7)	12.5	(5.67)

## Metric Threads

BMS-6L	M6 x 1	B11 & B12	1/4"	(6.3)	6.9	(3.13)
BMS-6M	M6 x 1	B22, B24, B32	1/4"	(6.3)	6.9	(3.13)
BMS-6S	M6 x 1	B42, B52, B54	1/4"	(6.3)	6.9	(3.13)
BMS-8L	M8 x 1.25	B11 & B12	1/4"	(6.3)	6.7	(3.04)
BMS-8M	M8 x 1.25	B22, B24, B32	1/4"	(6.3)	6.7	(3.04)
BMS-8S	M8 x 1.25	B42, B52, B54	1/4"	(6.3)	6.7	(3.04)
BMS-10L	M10 x 1.5	B11 & B12	3/8"	(9.5)	9.6	(4.35)
BMS-10M	M10 x 1.5	B22, B24, B32	3/8"	(9.5)	9.6	(4.35)
BMS-10S	M10 x 1.5	B42, B52, B54	3/8"	(9.5)	9.6	(4.35)
BMS-12M	M12 x 1.75	B22, B24, B32	3/8"	(9.5)	9.2	(4.17)
BMS-12S	M12 x 1.75	B42, B52, B54	3/8"	(9.5)	9.2	(4.17)
BMS-D-12M	M12 x 1.75	B22, B24, B32	1/2"	(12.7)	12.2	(5.53)

Note: For mini channel nut information see page 245.

Reference page 78 for general fitting and standard finish specifications.

# Channel nuts

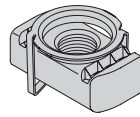

**Note:** See page 84 for resistance to slip & page 85 for pull-out strength. Channel nuts and hardware are sold in full box quantities.

## Twirl-Nut

Part No.	Thread Size	Fits Channel Sizes	Nut Thickness		Wt./C		
			In.	mm	Lbs.	kg	
<b>TN221</b>	#8-32	All sizes except B62 & B72	1/4"	(6.3)	7.0	(3.17)	
<b>TN227</b>	#10-32	All sizes except B62 & B72	1/4"	(6.3)	7.0	(3.17)	
<b>TN222</b>	#10-24	All sizes except B62 & B72	1/4"	(6.3)	7.0	(3.17)	
<b>TN224</b>	1/4-20	All sizes except B62 & B72	1/4"	(6.3)	6.7	(3.04)	
<b>TN223</b>	5/16-18	All sizes except B62 & B72	1/4"	(6.3)	6.7	(3.04)	
<b>TN228</b>	3/8-16	All sizes except B62 & B72	3/8"	(9.5)	9.3	(4.22)	
<b>TN226</b>	7/16-14	All sizes except B62 & B72	3/8"	(9.5)	8.8	(3.99)	
<b>TN225</b>	1/2-13	B11, B12, B22, B24, B32	1/2"	(12.7)	11.6	(5.26)	
<b>TN525</b>	1/2-13	B42, B52, B54	3/8"	(9.5)	8.8	(3.99)	
<b>TN255</b>	5/8-11	B11, B12, B22, B24, B32	1/2"	(12.7)	11.0	(4.99)	
<b>Metric Threads</b>	<b>BMT-6</b>	M6 x 1	All sizes except B62 & B72	1/4"	(6.3)	6.9	(3.13)
	<b>BMT-8</b>	M8 x 1.25	All sizes except B62 & B72	1/4"	(6.3)	6.7	(3.04)
	<b>BMT-10</b>	M10 x 1.5	All sizes except B62 & B72	3/8"	(9.5)	9.6	(4.35)
	<b>BMT-12</b>	M12 x 1.75	All sizes except B62 & B72	3/8"	(9.5)	9.2	(4.17)
	<b>BMT-D-12</b>	M12 x 1.75	B11, B12, B22, B24, B32	1/2"	(12.7)	12.2	(5.53)

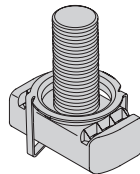

**Note:** See page 84 for resistance to slip & page 85 for pull-out strength. Channel nuts and hardware are sold in full box quantities.

## Twirl Stud Nut

Part No.	Thread Size	Fits Channel Sizes	Nut Thickness		Wt./C	
			In.	mm	Lbs.	kg
<b>STN224-*</b>	1/4-20	All sizes except B62 & B72	1/4"	(6.3)	8.1	(3.66)
<b>STN228-*</b>	3/8-16	All sizes except B62 & B72	3/8"	(9.5)	12.9	(5.85)
<b>STN225-*</b>	1/2-13	B11, B12, B22, B24, B32	1/2"	(12.7)	18.2	(8.23)
<b>STN525-*</b>	1/2-13	B42, B52, B54	3/8"	(9.5)	15.4	(6.96)

\*Note: Add stud length in inches (3/4, 1, 1 1/4, 1 1/2)

Note: See page 84 for resistance to slip & page 85 for pull-out strength. Channel nuts and hardware are sold in full box quantities.

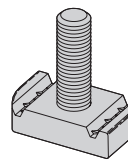

## Stud Nut Without Spring

Part No.	Thread Size	Fits Channel Sizes	Nut Thickness		Wt./C	
			In.	mm	Lbs.	kg
<b>SN224-*WO</b>	1/4-20	All sizes except B62 & B72	1/4"	(6.3)	8.1	(3.66)
<b>SN228-*WO</b>	3/8-16	All sizes except B62 & B72	3/8"	(9.5)	12.9	(5.85)
<b>SN225-*WO</b>	1/2-13	B11, B12, B22, B24, B32	1/2"	(12.7)	18.2	(8.23)
<b>SN525-*WO</b>	1/2-13	B42, B52, B54	3/8"	(9.5)	15.4	(6.96)

\*Note: Add stud length in inches (3/4, 1, 1 1/4, 1 1/2)

Reference page 78 for general fitting and standard finish specifications.

Note: See page 84 for resistance to slip & page 85 for pull-out strength. Channel nuts and hardware are sold in full box quantities.

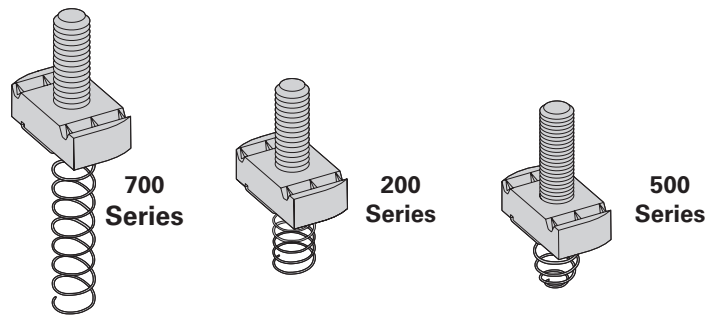

## Stud Nut With Spring

Part No.	Thread Size	Fits Channel Sizes	Nut Thickness		Wt./C	
			In.	mm	Lbs.	kg
<b>SN724-*</b>	1/4-20	B11 & B12	1/4"	(6.3)	8.1	(3.66)
<b>SN224-*</b>	1/4-20	B22, B24, B32	1/4"	(6.3)	8.1	(3.66)
<b>SN524-*</b>	1/4-20	B42, B52, B54	1/4"	(6.3)	8.1	(3.66)
<b>SN728-*</b>	3/8-16	B11 & B12	3/8"	(9.5)	12.9	(5.85)
<b>SN228-*</b>	3/8-16	B22, B24, B32	3/8"	(9.5)	12.9	(5.85)
<b>SN528-*</b>	3/8-16	B42, B52, B54	3/8"	(9.5)	12.9	(5.85)
<b>SN725-*</b>	1/2-13	B11 & B12	1/2"	(12.7)	18.2	(8.23)
<b>SN225-*</b>	1/2-13	B22, B24, B32	1/2"	(12.7)	18.2	(8.23)
<b>SN525-*</b>	1/2-13	B42, B52, B54	3/8"	(9.5)	15.4	(6.96)

\*Note: Add stud length in inches (3/4, 1, 1 1/4, 1 1/2)

- Finish: Electrodeposited zinc ASTM B633 SC1
- Available in 316 stainless steel - add SS6 to part number
- To lock combo nut washer in place a hex nut (sold separately) is required

Note: See page 84 for resistance to slip & page 85 for pull-out strength. Channel nuts and hardware are sold in full box quantities.

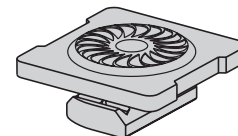

Patent Number  
7,604,444

## Combo Nut Washer

Part No.	Thread Size	Fits Channel Sizes	Nut Thickness		Wt./C	
			In.	mm	Lbs.	kg
<b>NW524</b>	1/4-20	All Channel Sizes	1/4"	(6.3)	11.9	(5.40)
<b>NW528</b>	3/8-16	All Channel Sizes	3/8"	(9.5)	13.8	(6.26)
<b>NW525</b>	1/2-13	All Channel Sizes	3/8"	(9.5)	13.1	(5.94)
<b>NWM6</b>	M6	All Channel Sizes	1/4"	(6.3)	16.6	(7.50)
<b>NWM8</b>	M8	All Channel Sizes	1/4"	(6.3)	15.4	(7.00)
<b>NWM10</b>	M10	All Channel Sizes	3/8"	(9.5)	18.9	(8.57)
<b>NWM12</b>	M12	All Channel Sizes	3/8"	(9.5)	17.7	(8.00)

Reference page 78 for general fitting and standard finish specifications.

# Channel nuts

## Resistance To Slip

- With Safety Factor of 3

Thread Size	Nut Part Numbers	Resistance to Slip			
		12 ga. Channel		14 ga. Channel	
		Lbs.	N	Lbs.	N
#8-32	N221, N221WO, N521, N721, TN221	50	220	50	220
#10-24	N222, N222WO, N522, N722, TN222	100	440	100	440
#10-32	N227, N227WO, N527, N727, TN227	100	440	100	440
1/4"-20	NW524*, N224, N224WO, N524, N724, TN224, STN224, SN224WO, SN224, SN524, SN724	300	1330	300	1330
5/16"-18	N223, N223WO, N523, N723, TN223	450	2000	450	2000
3/8"-16	NW528*, N228, N228WO, N528, N728, TN228, STN228, SN228WO, SN228, SN528, SN728	800	3560	600	2670
7/16"-14	N226, N226WO, N526, N726, TN226	1000	4450	800	3560
	N225, N225WO, N725, TN225, STN225, SN225WO, SN225, SN725	1500	6670	1000	4450
1/2"-13	NW525*, N525, N525WO, TN525, STN525, SN525WO, SN525	1500	6670	1000	4450
5/8"-11	N255, N255WO, N755, TN255	1500	6670	1000	4450
	N555, N555WO	1500	6670	1000	4450
3/4"-10	N275, N275WO, N775	1500	6670	1000	4450
	N575, N575WO	1500	6670	1000	4450
7/8"-9	N278, N278WO, N778	1500	6670	1000	4450
M6 x 1	BMS-6, BMS-6L, BMS-6M, BMS-6S, BMT-6	300	1330	300	1330
M8 x 1.25	BMS-8, BMS-8L, BMS-8M, BMS-8S, BMT-8	450	2000	450	2000
M10 x 1.50	BMS-10, BMS-10L, BMS-10M, BMS-10S, BMT-10	800	3560	600	2760
M12 x 1.75	BMS-D-12, BMS-D-12M, BMT-D-12	1500	6670	1000	4450
	BMS-12, BMS-12M, BMS-12S, BMT-12	1500	6670	1000	4450

Metric Threads

\* Combo Nut Washer (see page 83)

**Note:**

Using stainless steel channel nuts in stainless steel channel, reduce slip loads by 50% due to hardness of material. Using stainless steel channel nuts in aluminum channel, reduce slip loads by 70% due to hardness of material.

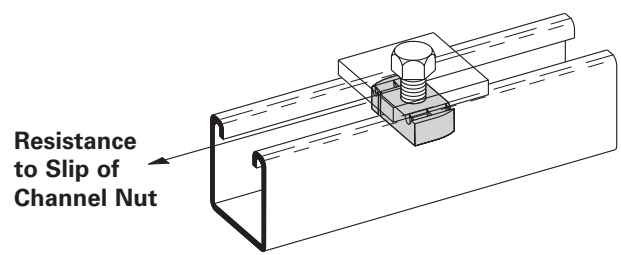

**Note:** For mini channel nut information see page 245.

Reference page 78 for general fitting and standard finish specifications.

## Pull-Out Strength

- With Safety Factor of 3
- Maximum pullout strength for B11 & B12 channels is limited to 1500 lbs. (6670 N).

Thread Size	Nut Part Numbers	Pull-Out Strength			
		12 ga. Channel		14 ga. Channel	
		Lbs.	N	Lbs.	N
#8-32	N221, N221WO, N521, N721, TN221	200	890	200	890
#10-24	N222, N222WO, N522, N722, TN222	250	1110	250	1110
#10-32	N227, N227WO, N527, N727, TN227	250	1110	250	1110
1/4"-20	NW524*, N224, N224WO, N524, N724, TN224, STN224, SN224WO, SN224, SN524, SN724	450	2000	450	2000
5/16"-18	N223, N223WO, N523, N723, TN223	750	3330	750	3330
3/8"-16	NW528*, N228, N228WO, N528, N728, TN228, STN228, SN228WO, SN228, SN528, SN728	1100	4890	1000	4450
7/16"-14	N226, N226WO, N526, N726, TN226	1500	6670	1200	5340
1/2"-13	N225, N225WO, N725, TN225, STN225, SN225WO, SN225, SN725	2000	8900	1400	6230
	NW525*, N525, N525WO, TN525, STN525, SN525WO, SN525	1500	6670	1400	6230
5/8"-11	N255, N255WO, N755, TN255	2000	8900	1400	6230
	N555, N555WO	1500	6670	1400	6230
3/4"-10	N275, N275WO, N775	2000	8900	1400	6230
	N575, N575WO	1500	6670	1400	6230
7/8"-9	N278, N278WO, N778	1500	6670	1400	6230
M6 x 1	BMS-6, BMS-6L, BMS-6M, BMS-6S, BMT-6	450	2000	450	2000
M8 x 1.25	BMS-8, BMS-8L, BMS-8M, BMS-8S, BMT-8	750	3330	750	3330
M10 x 1.50	BMS-10, BMS-10L, BMS-10M, BMS-10S, BMT-10	1100	4890	1000	4450
M12 x 1.75	BMS-D-12, BMS-D-12M, BMT-D-12	2000	8900	1400	6230
	BMS-12, BMS-12M, BMS-12S, BMT-12	1500	6670	1400	6230

Metric Threads

\* Combo Nut Washer (see page 83)

### Note:

Using stainless steel channel nuts in stainless steel channel, use pull-out loads as shown above.  
Using stainless steel channel nuts in aluminum channel, reduce pull-out loads by 70% due to hardness of material.

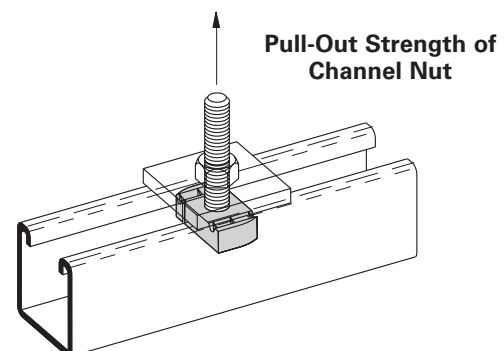

**Note:** For mini channel nut information see page 245.

Reference page 78 for general fitting and standard finish specifications.



## DCN 3/8 Double Conveyor Nut

- Recommended torque - 19 ft./Lbs.
- Allowable slip loading - 700 Lbs.(3.11kN)
- Safety Factor of 3
- Material: ASTM 1011SS Gr. 33
- Finish: Electrodeposited zinc ASTM B633 SC1
- Strut ordered separately

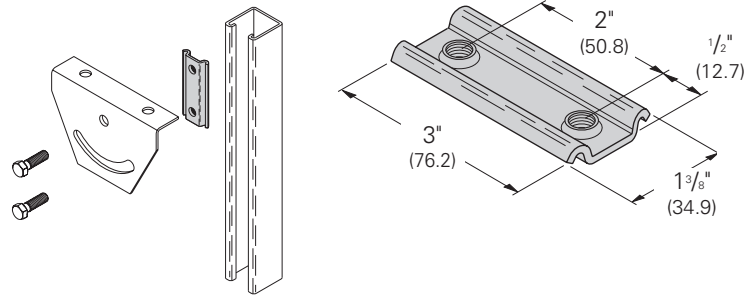

## B501 Series U-Bolt

- Designed for use with Rigid Conduit or Iron Pipe
- Dimension "C" is dependent on the type of pipe or conduit supported and is a reference only

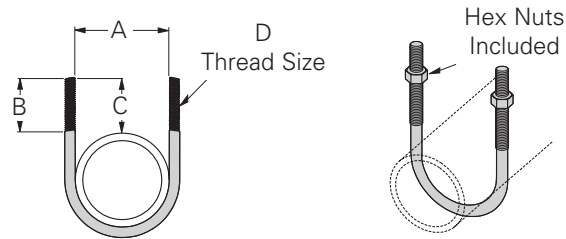

Part No.	A		B		C		D	Design Load		Wt./C	
	In.	mm	In.	mm	In.	mm		Lbs.	kN	Lbs.	kg
B501-1/2	15/16"	(23.8)	1 3/4"	(44.4)	1 1/2"	(38.1)	5/16"-18	600	(2.67)	12	(5.4)
B501-3/4	1 1/8"	(28.6)	1 3/4"	(44.4)	1 5/8"	(41.3)	5/16"-18	600	(2.67)	13	(5.9)
B501-1	1 3/8"	(29.9)	1 7/8"	(47.6)	1 5/8"	(41.3)	5/16"-18	900	(4.00)	14	(6.3)
B501-1 1/4	1 23/32"	(43.6)	1 3/4"	(44.4)	1 15/32"	(37.3)	5/16"-18	900	(4.00)	15	(6.8)
B501-1 1/2	2"	(50.8)	1 3/4"	(44.4)	1 7/16"	(36.5)	5/16"-18	900	(4.00)	16	(7.2)
B501-2	2 7/16"	(61.9)	2 1/16"	(52.4)	1 7/8"	(47.6)	3/8"-16	1200	(5.34)	27	(12.2)
B501-2 1/2	2 15/16"	(74.6)	2 1/16"	(52.4)	1 13/16"	(46.0)	3/8"-16	1200	(5.34)	32	(14.5)
B501-3	3 9/16"	(90.5)	2"	(50.8)	1 3/4"	(44.4)	3/8"-16	1800	(8.00)	36	(16.3)
B501-3 1/2	4 3/32"	(94.6)	2"	(50.8)	1 23/32"	(43.6)	3/8"-16	1800	(8.00)	38	(17.2)
B501-4	4 19/32"	(116.7)	2 1/4"	(57.1)	1 21/32"	(50.0)	3/8"-16	1800	(8.00)	42	(19.0)
B501-5	5 21/32"	(143.6)	2 1/4"	(57.1)	2"	(50.8)	1/2"-13	2400	(10.70)	92	(41.7)
B501-6	6 3/4"	(171.4)	2 5/8"	(66.7)	2 3/8"	(60.3)	5/8"-11	2400	(10.70)	176	(79.8)
B501-8	8 3/4"	(222.2)	2 5/8"	(66.7)	2 3/8"	(60.3)	5/8"-11	2400	(10.70)	191	(86.6)

## B500 Series Square U-Bolt

- Includes:
  - 1 pc. U-Bolt only
  - 2 pcs. 3/8"-16 Hex Nuts
- Additional sizes available
- Standard finish: ZN, SS4

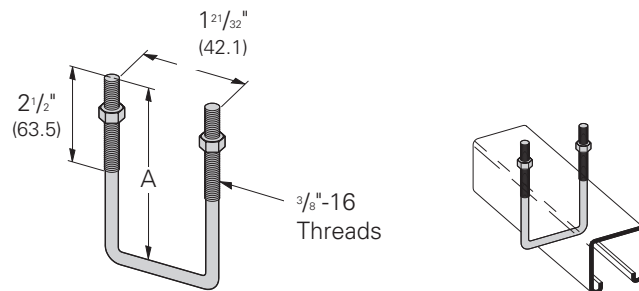

Part No.	A		Channel Size	Wt./C	
	Lbs.	kg		Lbs.	kg
B500-3-3/8	3 3/8"	(85.7)	1 5/8" x 1 5/8"	25	(11.3)
B500-5	5"	(127.0)	3 1/4" x 1 5/8"	33	(14.9)

Reference page 78 for general fitting and standard finish specifications.

## HHCS Hex Head Cap Screws

- Standard finish: Zinc-Plated, Stainless Steel
- Channel nuts and hardware are sold in full box quantities

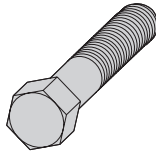

Part No.	Wt./C	
	Lbs.	kg
1/4" x 1/2" HHCS	1.3	(.59)
1/4" x 3/4" HHCS	1.4	(.63)
1/4" x 1" HHCS	1.7	(.77)
1/4" x 1 1/4" HHCS	2.1	(.95)
1/4" x 1 1/2" HHCS	2.4	(1.09)
5/16" x 1" HHCS	2.8	(1.27)
5/16" x 1 1/4" HHCS	3.2	(1.45)
5/16" x 1 1/2" HHCS	3.8	(1.72)
3/8" x 3/4" HHCS	3.4	(1.54)
3/8" x 1" HHCS	4.1	(1.86)
3/8" x 1 1/4" HHCS	4.7	(2.13)
3/8" x 1 1/2" HHCS	5.2	(2.36)
3/8" x 1 3/4" HHCS	5.9	(2.67)
3/8" x 2" HHCS	7.0	(3.17)
3/8" x 2 1/4" HHCS	7.8	(3.54)
3/8" x 2 1/2" HHCS	8.5	(3.85)
1/2" x 7/8" HHCS	8.0	(3.63)
1/2" x 1" HHCS	8.4	(3.81)
1/2" x 1 1/4" HHCS	9.2	(4.17)
1/2" x 1 1/2" HHCS	10.1	(4.58)
1/2" x 1 3/4" HHCS	12.0	(5.44)
1/2" x 2" HHCS	13.2	(5.99)
1/2" x 2 1/2" HHCS	16.0	(7.26)

## SRHMS Slotted Round Head Machine Screws

- Standard finish: Zinc-Plated
- Channel nuts and hardware are sold in full box quantities.

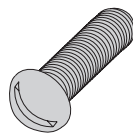

Part No.	Wt./C	
	Lbs.	kg
1/4" x 1/2" SRHMS	.9	(.41)
1/4" x 3/4" SRHMS	1.2	(.54)
1/4" x 1" SRHMS	1.5	(.68)
1/4" x 1 1/4" SRHMS	1.7	(.77)
1/4" x 1 1/2" SRHMS	1.9	(.86)
5/16" x 1" SRHMS	2.5	(1.13)
5/16" x 1 1/4" SRHMS	2.9	(1.31)
5/16" x 1 1/2" SRHMS	3.3	(1.49)
3/8" x 1" SRHMS	4.0	(1.81)
3/8" x 1 1/4" SRHMS	4.5	(2.04)
3/8" x 1 1/2" SRHMS	5.1	(2.31)
3/8" x 2" SRHMS	6.3	(2.86)
3/8" x 2 1/4" SRHMS	7.1	(3.22)
3/8" x 2 1/2" SRHMS	7.7	(3.49)

## SFHMS Slotted Flat Head Machine Screws

- Standard finish: Zinc-Plated
- Channel nuts and hardware are sold in full box quantities

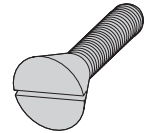

Part No.	Wt./C	
	Lbs.	kg
1/4" x 1/2" SFHMS	1.1	(.50)
1/4" x 5/8" SFHMS	1.2	(.54)
1/4" x 3/4" SFHMS	1.4	(.63)
5/16" x 1" SFHMS	2.8	(1.27)
3/8" x 1 1/2" SFHMS	5.6	(2.54)
3/8" x 2" SFHMS	6.7	(3.04)
3/8" x 2 1/4" SFHMS	7.3	(3.31)
3/8" x 2 1/2" SFHMS	7.9	(3.58)
1/2" x 1" SFHMS	5.9	(2.67)
1/2" x 1 1/4" SFHMS	7.0	(3.17)
1/2" x 1 1/2" SFHMS	8.3	(3.76)
1/2" x 2 1/2" SFHMS	13.8	(6.26)

## SHHMS Slotted (Combination Recess) Hex Head Machine Screws

- Standard finish: Zinc-Plated, Stainless Steel
- Channel nuts and hardware are sold in full box quantities

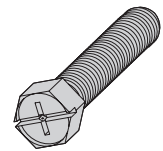

Part No.	Wt./C	
	Lbs.	kg
1/4" x 3/4" SHHMS	1.2	(.54)
1/4" x 1" SHHMS	1.5	(.68)
1/4" x 1 1/4" SHHMS	1.8	(.80)
1/4" x 1 1/2" SHHMS	2.0	(.91)
5/16" x 1" SHHMS	2.6	(1.18)
5/16" x 1 1/4" SHHMS	3.1	(1.40)
5/16" x 1 1/2" SHHMS	3.4	(1.54)
3/8" x 1 1/4" SHHMS	4.6	(2.08)
3/8" x 1 1/2" SHHMS	5.3	(2.40)

## CNPSS Square Head Cone Point Set Screw

- Standard finish: ZN
- Channel nuts and hardware are sold in full box quantities.

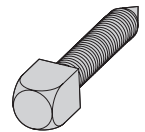

Part No.	Wt./C	
	Lbs.	kg
3/8" x 1 1/2" CNPSS	4.7	(2.13)
3/8" x 2" CNPSS	6.0	(2.72)
1/2" x 1 1/2" CNPSS	9.2	(4.17)
1/2" x 2" CNPSS	11.4	(5.17)
1/2" x 2 1/2" CNPSS	13.7	(6.21)
5/8" x 2" CNPSS	19.0	(8.62)
5/8" x 2 1/2" CNPSS	22.6	(10.25)

Reference page 78 for general fitting and standard finish specifications.

## B446A Swivel Hanger (Female Only)

- Design Load:  
(<sup>3</sup>/<sub>8</sub>)-610 Lbs. (2.71 kN)  
(<sup>1</sup>/<sub>2</sub>)-1130 Lbs. (5.02 kN)
- Safety Factor of 3
- Standard finish: ZN

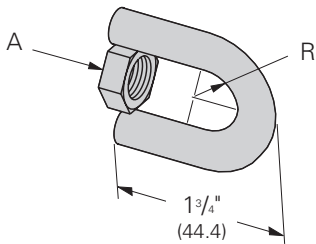

Part No.	A	R		Wt./C	
		In.	mm	Lbs.	kg
B446A- <sup>3</sup> / <sub>8</sub>	<sup>3</sup> / <sub>8</sub> "-16 HN	<sup>9</sup> / <sub>32</sub> "	(7.1)	13	(5.9)
B446A- <sup>1</sup> / <sub>2</sub>	<sup>1</sup> / <sub>2</sub> "-13 HN	<sup>3</sup> / <sub>8</sub> "	(9.5)	15	(6.8)

## B446B Swivel Hanger (Male Only)

- Design Load:  
(<sup>3</sup>/<sub>8</sub>)-610 Lbs. (2.71 kN)  
(<sup>1</sup>/<sub>2</sub>)-1130 Lbs. (5.02 kN)
- Safety Factor of 3
- Standard finish: ZN

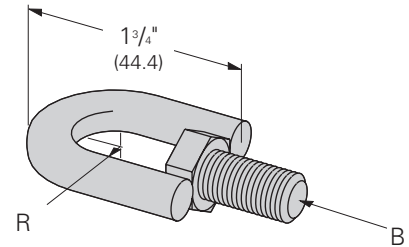

Part No.	A	R		Wt./C	
		In.	mm	Lbs.	kg
B446B- <sup>3</sup> / <sub>8</sub>	<sup>3</sup> / <sub>8</sub> "-16 HN	<sup>9</sup> / <sub>32</sub> "	(7.1)	16	(7.2)
B446B- <sup>1</sup> / <sub>2</sub>	<sup>1</sup> / <sub>2</sub> "-13 HN	<sup>3</sup> / <sub>8</sub> "	(9.5)	20	(9.1)

## B446C Swivel Hanger (Female-Female)

- Design Load:  
(<sup>3</sup>/<sub>8</sub>)-610 Lbs. (2.71 kN)  
(<sup>1</sup>/<sub>2</sub>)-1130 Lbs. (5.02 kN)
- Safety Factor of 3
- Standard finish: ZN

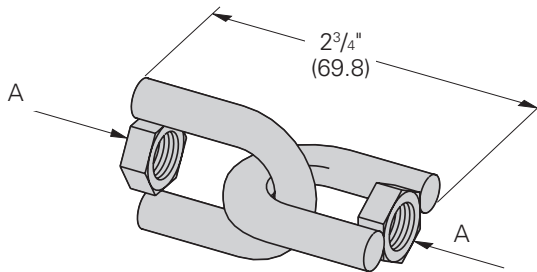

Part No.	A	Wt./C	
		Lbs.	kg
B446C- <sup>3</sup> / <sub>8</sub>	<sup>3</sup> / <sub>8</sub> "-16 HN	26	(11.8)
B446C- <sup>1</sup> / <sub>2</sub>	<sup>1</sup> / <sub>2</sub> "-13 HN	31	(14.0)

## B446 Swivel Hanger (Female-Male)

- Design Load:  
(<sup>3</sup>/<sub>8</sub>)-610 Lbs. (2.71 kN)  
(<sup>1</sup>/<sub>2</sub>)-1130 Lbs. (5.02 kN)
- Safety Factor of 3
- Standard finish: ZN

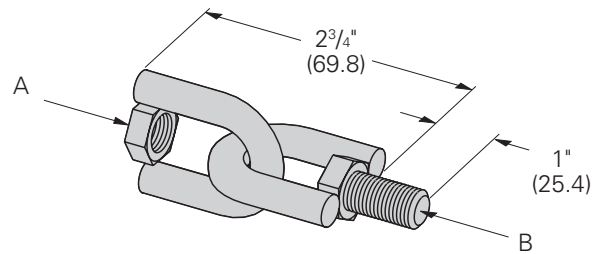

Part No.	A	B	Wt./C	
			Lbs.	kg
B446- <sup>3</sup> / <sub>8</sub>	<sup>3</sup> / <sub>8</sub> "-16 HN	<sup>3</sup> / <sub>8</sub> "-16 HHCS	28	(12.7)
B446- <sup>1</sup> / <sub>2</sub>	<sup>1</sup> / <sub>2</sub> "-13 HN	<sup>1</sup> / <sub>2</sub> "-13 HHCS	36	(16.3)

**B617  
Shoulder Bolt**

- Standard finish: ZN
- Wt./C 6 Lbs. (2.7 kg)

<sup>3</sup>/<sub>8</sub>"-16 Thread Size

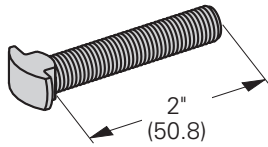

**Fig. 75  
Swivel Attachment**

- Standard finish: ZN
- Sized for <sup>3</sup>/<sub>8</sub>"-16 threaded rods
- UL Listed to support up to 4" Pipe per NFPA 13
- Wt./C 13 Lbs. (5.9 kg)

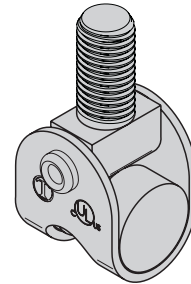

**HN  
Hex Nuts**

- Standard finish: Zinc-Plated, Stainless Steel
- Channel nuts and hardware are sold in full box quantities.

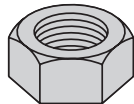

**MSQN  
Machine Square Nut**

- For use with B755 Beam Clamp
- Standard finish: Zinc-Plated
- Channel nuts and hardware are sold in full box quantities.

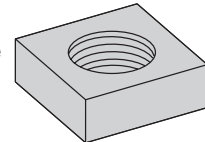

Part No.	Wt./C	
	Lbs.	kg
1/4" HN	.7	(.32)
5/16" HN	1.0	(.45)
3/8" HN	1.5	(.68)
1/2" HN	3.6	(1.63)
5/8" HN	7.2	(3.26)
3/4" HN	11.1	(5.03)
7/8" HN	17.9	(8.12)
1" HN	27.2	(12.34)

Part No.	Wt./C	
	Lbs.	kg
MSQN 1/4"	.6	(.27)
MSQN 5/16"	1.2	(.54)
MSQN 3/8"	1.8	(.81)

**SQN  
Square Nuts**

- Standard finish: Zinc-Plated
- Channel nuts and hardware are sold in full box quantities.

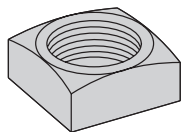

Part No.	Wt./C	
	Lbs.	kg
1/2" SQN	5.7	(2.58)
5/8" SQN	10.1	(4.58)

Reference page 78 for general fitting and standard finish specifications.

# Hardware

## SLN

### Slip on Lock Nut

- Material: ASTM A307 Gr. A.
- Safety Factor of 3.
- Standard finish: Zinc-Plated
- Channel nuts and hardware are sold in full box quantities

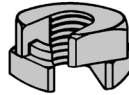

Part No.	Thread Size	B		C		Recommended Load		Wt./C	
		In.	mm	In.	mm	Lbs.	kN	Lbs.	kg
SLN-1/2	1/2"-13	1 1/8"	(28.6)	5/8"	(15.9)	1330	(5.91)	6.0	(2.7)
SLN-5/8	5/8"-11	1 5/16"	(33.3)	5/8"	(15.9)	1650	(7.34)	7.0	(3.2)

## Buzznut™

- Can be installed at any desired position on the ATR, eliminating the need to thread hex nuts up along ATR.
- Loading Safety Factor of 3.
- Torque: 6 ft./lbs (8 Nm)
- Available in Zinc Plated or 316 stainless steel.
- Channel nuts and hardware are sold in full box quantities

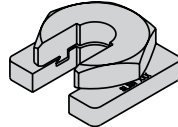

Part No.	Thread Size	Loading Lbs.	kN	Wt./C Lbs.	kg
SLWN1/4	1/4"-20	240	(1.07)	14.4	(6.5)
SLWN3/8	3/8"-16	730	(3.24)	15.4	(7.0)
SLWN1/2	1/2"-13	1350	(6.00)	18.8	(8.5)
SLWN5/8	5/8"-11	2100	(9.33)	25.4	(11.5)
SLWNM6	M6	200	(0.90)	14.1	(6.4)
SLWNM8	M8	380	(1.70)	16.3	(7.4)
SLWNM10	M10	584	(2.60)	17.2	(7.8)
SLWNM12	M12	840	(3.70)	18.9	(8.6)

## FW

### Flat Washers

- Standard finish: Zinc-Plated, Stainless Steel
- Channel nuts and hardware are sold in full box quantities

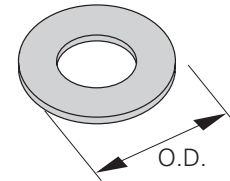

Part No.	O.D. Outside Dia. in.	mm	Wt./C Lbs.	kg
1/4" FW	47/64"	(18.7)	.7	(.32)
5/16" FW	7/8"	(22.2)	1.4	(.63)
3/8" FW	1"	(25.4)	1.7	(.77)
1/2" FW	1 3/8"	(34.9)	3.9	(1.77)
5/8" FW	1 15/32"	(37.3)	6.4	(2.90)
3/4" FW	2"	(50.8)	10.9	(4.94)
7/8" FW	2 1/4"	(57.1)	13.4	(6.08)
1" FW	2 1/2"	(63.5)	18.8	(8.53)

## FFW

### Flat Fender Washers

- Standard finish: Zinc-Plated
- Channel nuts and hardware are sold in full box quantities

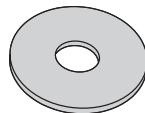

Part No.	Wt./C	
	Lbs.	kg
1/4" x 1 1/4" FFW	2.2	(1.00)
1/4" x 1 1/2" FFW	3.1	(1.40)
3/8" x 1 1/4" FFW	2.0	(.91)
3/8" x 1 1/2" FFW	3.0	(1.36)
1/2" x 2" FFW	5.4	(2.45)

## LW

### Lock Washers

- Standard finish: Zinc-Plated, Stainless Steel
- Channel nuts and hardware are sold in full box quantities

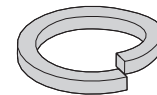

Part No.	Wt./C	
	Lbs.	kg
1/4" LW	.3	(.13)
5/16" LW	.4	(.18)
3/8" LW	.6	(.27)
1/2" LW	1.3	(.59)
5/8" LW	2.4	(1.09)
3/4" LW	3.8	(1.72)
7/8" LW	5.9	(2.67)
1" LW	8.8	(3.99)

**SC228  
Hanger Rod Stiffener**

- For  $\frac{3}{8}$ " thru  $\frac{5}{8}$ " ATR
- Strut ordered separately
- Standard finish: ZN
- Wt./C 21 Lbs. (9.5 kg)

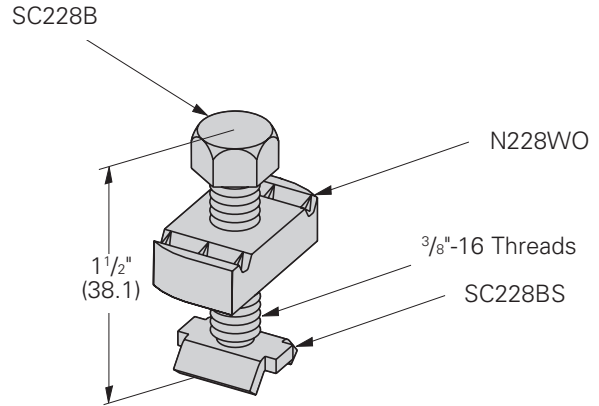
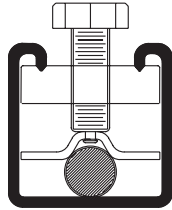

**Fig. 98  
Rod Stiffener**

- For  $\frac{3}{8}$ " thru  $\frac{7}{8}$ " ATR
- Use with 12 ga. strut only, ordered separately
- Secures channel to hanger rod for vertical seismic bracing
- Available finishes: 304 stainless steel, 316 stainless steel and HDG
- Wt./C 11 Lbs. (5.0 kg)

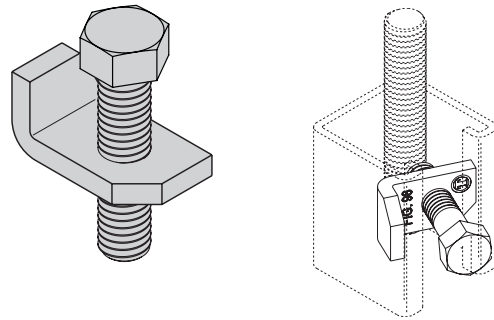

**Fig. 98B  
Rod Stiffener with Break-Off Bolt Head**

- For  $\frac{3}{8}$ " thru  $\frac{7}{8}$ " ATR
- Use with 12 ga. strut only, ordered separately
- Secures channel to hanger rod for vertical seismic bracing
- Uses a snap-off bolt head
- Standard finish: ZN
- Wt./C 13 Lbs. (5.9 kg)

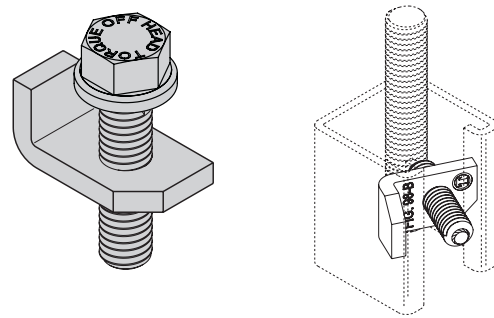

**SC-UB  
Hanger Rod Stiffener**

- For  $\frac{3}{4}$ " thru  $\frac{7}{8}$ " ATR
- Strut ordered separately
- Includes: (1) B3188-1 $\frac{1}{2}$ " WO U-Bolt  
(2)  $\frac{3}{8}$ "-16 Hex Nuts  
(1) 2-Hole Plate
- Standard finish: ZN
- Wt./C 50 Lbs. (22.7 kg)

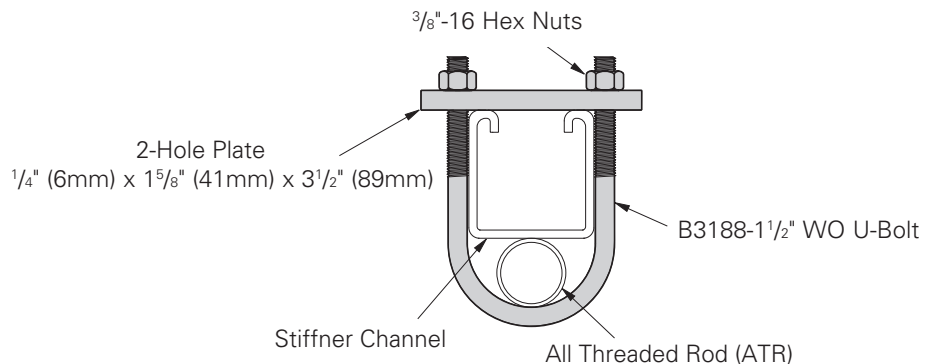

Channel Nuts & Hardware

Reference page 78 for general fitting and standard finish specifications.

# Hardware

## ATR

### All Threaded Rod

- Available in 36" (91.4 cm), 72" (182.9 cm), 120" (304.8 cm), 144" (365.7 cm) lengths
- Safety Factor of 5 on recommended load
- Standard finish: Zinc-Plated, Stainless Steel Type 304

Part No. & Size	Threads Per Inch	Recommended Load		Wt./C Ft. (3048.0 cm)	
		Lbs.	kN	Lbs.	kg
ATR 1/4"	20	240	(1.07)	12	(5.44)
ATR 5/16"	18	400	(1.78)	19	(8.62)
ATR 3/8"	16	730	(3.24)	29	(13.15)
ATR 1/2"	13	1350	(6.00)	53	(24.04)
ATR 5/8"	11	2160	(9.60)	89	(40.37)
ATR 3/4"	10	3230	(14.37)	123	(55.79)
ATR 7/8"	9	4480	(19.93)	170	(77.11)
ATR 1"	8	5900	(26.24)	225	(102.06)

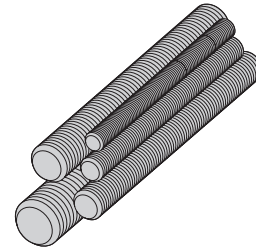

## B655 Rod Coupling B656 Reducer Rod Coupling

- Load rating for each coupler meets All Threaded Rod value
- Standard finish: Zinc-Plated, Stainless Steel Type 304
- Channel nuts and hardware are sold in full box quantities

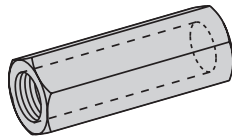

Part No.	Size	Recommended Load		Length		Wt./C	
		Lbs.	kN	In.	mm	Lbs.	kg
B655-1/4	1/4"-20	240	(1.07)	7/8"	(22.2)	1.9	(.86)
B655-5/16	5/16"-18	380	(1.69)	7/8"	(22.2)	1.8	(.81)
B655-3/8	3/8"-16	730	(3.24)	1 1/8"	(28.6)	3.6	(1.63)
B655-1/2	1/2"-13	1350	(6.00)	1 3/4"	(44.4)	11.3	(5.12)
B655-5/8	5/8"-11	1810	(8.05)	2 1/8"	(54.0)	17.6	(7.98)
B655-3/4	3/4"-10	2710	(12.05)	2 1/4"	(57.1)	28.1	(12.74)
B655-7/8	7/8"-9	3770	(16.77)	2 1/2"	(63.5)	57.2	(25.94)
B655-1	1"-8	4960	(22.06)	2 3/4"	(69.8)	73.7	(33.43)

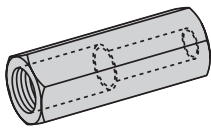

Part No.	Size	Recommended Load		Length		Wt./C	
		Lbs.	kN	In.	mm	Lbs.	kg
B656-3/8 x 1/4	3/8"-16 & 1/4"-20	240	(1.07)	1"	(25.4)	3.7	(1.68)
B656-1/2 x 3/8	1/2"-13 & 3/8"-16	730	(3.24)	1 1/4"	(31.7)	6.6	(2.99)
B656-5/8 x 1/2	5/8"-11 & 1/2"-13	1350	(6.00)	1 1/4"	(31.7)	11.6	(5.26)
B656-3/4 x 5/8	3/4"-10 & 5/8"-11	1810	(8.05)	1 1/2"	(38.1)	20.6	(9.34)
B656-7/8 x 3/4	7/8"-9 & 3/4"-10	2710	(12.05)	1 3/4"	(44.4)	39.4	(17.87)

## BHR Series Hot Rods for Trapeze Hangers

- 12" length of threaded rod completely assembled with rod coupling, locking hex nuts, square washer, and channel nut.
- Standard finish: Zinc-Plated

Part No.	Rod Size	Recommended Load		Wt./C	
		Lbs.	kN	Lbs.	kg
BHR1225ZN	1/4"-20	240	(1.07)	41	(18.6)
BHR1238ZN	3/8"-16	730	(3.24)	63	(28.6)
BHR1250ZN	1/2"-13	1350	(6.00)	98	(44.4)
BHR1262ZN	5/8"-11	1500	(6.67)	148	(67.1)

Note: Based on use with 12 ga. channel.

(BHR1225, BHR1238, and BHR1250 use combo nut washers instead of square washers and channel nuts)





Note: Channel nuts and hardware are sold in full box quantities.



## KwikWire Clamps

Part No.	For Use With Wire Rope Diameters	Box Qty.
<b>BKC100</b>	1/16" (1.6mm) & 3/32" (2.3mm)	100
<b>BKC200-1</b>	3/32" (2.4mm) 1/8" (3.2mm) & 3/16" (4.7mm)	50

See table below for KwikWireClamp Working Loads

### KwikWire Clamp Working Loads\*

Clamp Part No.	Wire Rope Dia.	Lbs. Safety Factor 4
<b>BKC100</b>	1/16"	0-75
<b>BKC100</b>	3/32"	25-150
<b>BKC200-1</b>	3/32"	25-150
<b>BKC200-1</b>	1/8"	25-250
<b>BKC200-1</b>	3/16"	50-500

\* Working loads shown are for hanging vertically.

For suspending at 15°, 30°, 45° or 60°

angles from vertical, use the following percentage of the working loads from the chart:

15° = 96%
30° = 86%
45° = 70%
60° = 50%

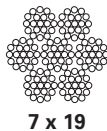
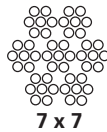

### KwikWire Wire Rope (Uncoated Galvanized Wire)

Part No.	Rope Dia.		Working Load		Spool
	in.	mm	Lbs.	kg	
<b>BKW063</b> <sup>(1)</sup>	1/16"	(1.6)	96	(43.5)	500 ft.
<b>BKW094</b> <sup>(1)</sup>	3/32"	(2.3)	184	(83.4)	500 ft.
<b>BKW125</b> <sup>(1)</sup>	1/8"	(3.2)	340	(154.2)	500 ft.
<b>BKW188</b> <sup>(2)</sup>	3/16"	(4.8)	840	(381.0)	250 ft.

<sup>(1)</sup> Wire Rope Construction Type 7 x 7

<sup>(2)</sup> Wire Rope Construction Type 7 x 19

### Instructions for installing the wire rope in the clamp - No tools are required.



1 Pass the wire rope through the KwikWire Clamp



2 Loop wire rope through/around support



3 Pass wire rope back through KwikWire Clamp

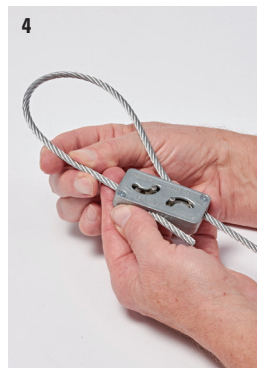

4 Push wire rope through clamp leaving 2" to 3" tail, then apply tension on wire rope



5 To adjust, remove tension and pull wire rope slightly to disengage teeth, slide adjustment pin in direction shown by arrow to release wire rope.





## KwikPak Wire Rope & Clamps KwikPak

Part No.	For Use With Wire Rope Diameters	Box Qty.
BKP10063	BKC100 (100 pcs.) 1/16" Ø Wire Rope (500 ft.)	1
BKP10094	BKC100 (100 pcs.) 3/32" Ø Wire Rope (500 ft.)	1
	BKC200-1 (50 pcs.) 3/32" Ø Wire Rope (500 ft.)	1
BKP20125	BKC200-1 (50 pcs.) 1/8" Ø Wire Rope (500 ft.)	1
BKP20188	BKC200-1 (50 pcs.) 3/16" Ø Wire Rope (500 ft.)	1

- KwikPak™ include KwikWire clamps and a spool of wire rope.
- KwikPak is shipped in a specially designed dispenser box to ease field cutting of wire.

### KwikWire System Recommendations:

- Do not exceed the safe working load of the products
- KwikWire Clamp load ratings are guaranteed only when used in combination with our supplied wire rope
- Do not use for overhead lifting or hoisting
- Do not use if cable or components are visibly distorted or worn. Remove damaged cable end prior to inserting in KwikWire Clamp
- Do not paint cable near working area of KwikWire Clamp
- Do not apply lubricant
- Keep product clean and free of dirt
- Do not use clamp on coated wire rope
- Do not use in chlorinated or caustic atmospheres
- For use in dry locations
- BKCC tool is recommended for cutting wire rope to prevent fraying



### KwikWire Cable Cutter

Part No.	Box Qty.
BKCC	1

- Wire rope cutter for cutting all wire rope sizes
- \*\* Never use cutters on energized circuits, wire, or cable.**

**NEVER USE CUTTERS ON ENERGIZED CIRCUITS, WIRE, OR CABLE.**



- KwikWire hanger combines the versatility of a bolt with an adjustable wire rope solution.
- Can be quickly installed in existing anchors or metal brackets with a nut.
- ARS, ARC, and ARW anchors are ideal for use with KwikWire Hangers.
- Ideal for supporting light fixtures, wire basket cable tray, HVAC ducts, and sign/banner supports.
- Allows for tool-less adjustment of wire rope.

## KwikWire Hanger

Part No.	Thread Size	Wire Rope Dia.		Loading* SF5	
		in.	mm	Lbs.	kg
<b>BKF100-4</b>	1/4"-20	1/16"	(1.6)	45	(20.4)
		3/32"	(2.3)	90	(40.8)
<b>BKF100-6</b>	3/8"-16	1/16"	(1.6)	45	(20.4)
		3/32"	(2.3)	90	(40.8)

## KwikWire Hanger installation



1  
Screw KwikWire Hanger into installed hanger support (ARS anchor pictured)



2  
Push cable wire up through the bottom of KwikWire Hanger



3  
Continue pushing through until 1/4" minimum is extending out the side of the KwikWire Hanger

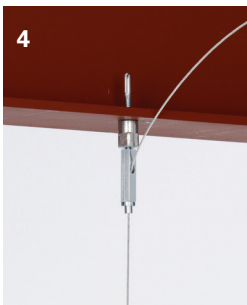

4  
To adjust up - pull or push more cable wire through KwikWire Hanger



5  
To adjust down - push up on bottom of KwikWire Hanger and allow cable wire to feed down

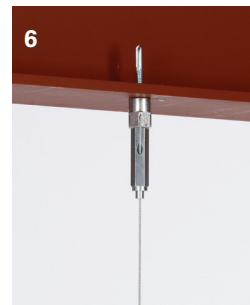

6  
When hanging the cable wire is complete, cut off any excess cable wire if desired

## KwikWire Accessory Features

- Reduces on the job installation time
- Can be installed quickly without drilling into existing structure
- Increases versatility in the field
- KwikWire accessory system reduces inventory and shipping costs
- No more sawing, filing, or fixing nuts
- Designed for use with cable tray, lighting, and HVAC
- Eliminates the need for all threaded rod
- Cost effective solution for jack chain
- "Y" style accessories require 50% less drilling

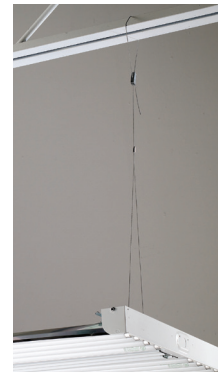

## KwikWire Accessory Numbering System

Product Line	Assembly Configuration	Leg Termination	Leg Length	Wire Rope Diameter	Straight Length	Assembly or Kit
BK = KwikWire	Blank = Single Leg Y = 2 Legs 3 - 3 Legs	A = Angle Bracket w/Pin H = Hook L = Loop T = Toggle W = Fuse Cut B25 = Bolt w/ 1/4"-20 Thread B38 = Bolt w/ 3/8"-16 Thread BM6 = Bolt w/ M6 Thread BM8 = Bolt w/ M8 Thread BM10 = Bolt w/ M10 Thread	Blank = See Straight Length 18 = 18" Leg 30 = 30" Leg	063 = 1/16" 094 = 3/32"	Blank = Loop w/ Plastic Tube 18 = 18" 30 = 30" 40 = 40" 80 = 80" 120 = 120" 180 = 180" 240 = 240" 360 = 360"	Blank = Assembly Only K = Kit (Assembly & BKC100 Clamp)

## Examples

### BKYT18-094-120K



KwikWire Accessory  
2 legs - toggle leg termination - 18" legs - 1/16" diameter wire - 120" straight length - kit with clamp

### BKL-063-120K



KwikWire Accessory  
single leg - looped leg termination - 1/16" diameter wire - 120" straight length - kit with clamp

## KwikWire Loop Termination

Part No.	Wire Rope Dia.		Length	
	in.	mm	in.	mm
<b>BKL-063-40</b>	1/16"	(1.6)	40"	(1016)
<b>BKL-063-80</b>	1/16"	(1.6)	80"	(2032)
<b>BKL-063-120</b>	1/16"	(1.6)	120"	(3048)
<b>BKL-063-180</b>	1/16"	(1.6)	180"	(4572)
<b>BKL-063-240</b>	1/16"	(1.6)	240"	(6096)
<b>BKL-063-360</b>	1/16"	(1.6)	360"	(9144)
<b>BKL-094-40</b>	3/32"	(2.3)	40"	(1016)
<b>BKL-094-80</b>	3/32"	(2.3)	80"	(2032)
<b>BKL-094-120</b>	3/32"	(2.3)	120"	(3048)
<b>BKL-094-180</b>	3/32"	(2.3)	180"	(4572)
<b>BKL-094-240</b>	3/32"	(2.3)	240"	(6096)
<b>BKL-094-360</b>	3/32"	(2.3)	360"	(9144)

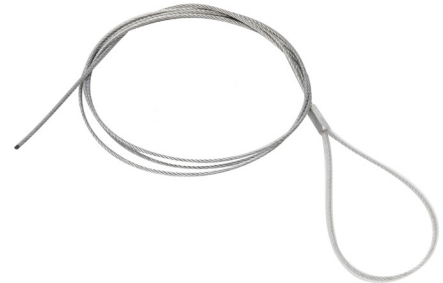

### Box Quantity - 20

5 bags containing 4 pieces per bag

## KwikWire Loop Termination Kits

Part No.	Wire Rope Dia.		Length	
	in.	mm	in.	mm
<b>BKL-063-40K</b>	1/16"	(1.6)	40"	(1016)
<b>BKL-063-80K</b>	1/16"	(1.6)	80"	(2032)
<b>BKL-063-120K</b>	1/16"	(1.6)	120"	(3048)
<b>BKL-063-180K</b>	1/16"	(1.6)	180"	(4572)
<b>BKL-063-240K</b>	1/16"	(1.6)	240"	(6096)
<b>BKL-063-360K</b>	1/16"	(1.6)	360"	(9144)
<b>BKL-094-40K</b>	3/32"	(2.3)	40"	(1016)
<b>BKL-094-80K</b>	3/32"	(2.3)	80"	(2032)
<b>BKL-094-120K</b>	3/32"	(2.3)	120"	(3048)
<b>BKL-094-180K</b>	3/32"	(2.3)	180"	(4572)
<b>BKL-094-240K</b>	3/32"	(2.3)	240"	(6096)
<b>BKL-094-360K</b>	3/32"	(2.3)	360"	(9144)



### Box Quantity - 20

5 bags containing 4 pieces per bag

- Available as a wire rope with loop termination only or as a ready-to-use kit with a BKC100 clamp.
- Available in lengths of 40", 80", 120", 180", 240", and 360".

## KwikWire Single Style Hook Termination



**Box Quantity - 20**  
5 bags containing 4 pieces per bag



Part No.	Wire Rope Dia.		Length	
	in.	mm	in.	mm
<b>BKH-094-40</b>	3/32"	(2.3)	40"	(1016)
<b>BKH-094-80</b>	3/32"	(2.3)	80"	(2032)
<b>BKH-094-120</b>	3/32"	(2.3)	120"	(3048)
<b>BKH-094-180</b>	3/32"	(2.3)	180"	(4572)
<b>BKH-094-240</b>	3/32"	(2.3)	240"	(6096)
<b>BKH-094-360</b>	3/32"	(2.3)	360"	(9144)

## KwikWire Single Style Hook Termination Kits

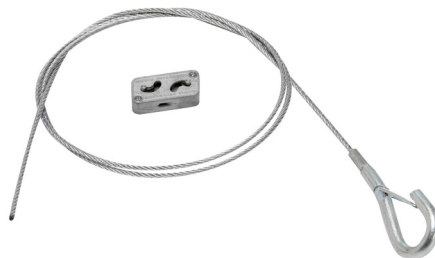

**Box Quantity - 20**  
5 bags containing 4 pieces per bag



Part No.	Wire Rope Dia.		Length	
	in.	mm	in.	mm
<b>BKH-094-40K</b>	3/32"	(2.3)	40"	(1016)
<b>BKH-094-80K</b>	3/32"	(2.3)	80"	(2032)
<b>BKH-094-120K</b>	3/32"	(2.3)	120"	(3048)
<b>BKH-094-180K</b>	3/32"	(2.3)	180"	(4572)
<b>BKH-094-240K</b>	3/32"	(2.3)	240"	(6096)
<b>BKH-094-360K</b>	3/32"	(2.3)	360"	(9144)

## KwikWire 'Y' Style Hook Termination With Loop



**Box Quantity - 10**  
5 bags containing 2 pieces per bag



Part No.	Wire Rope Dia.		Length	
	in.	mm	in.	mm
<b>BKYH18-094</b>	3/32"	(2.3)	18"	(457)
<b>BKYH30-094</b>	3/32"	(2.3)	30"	(762)

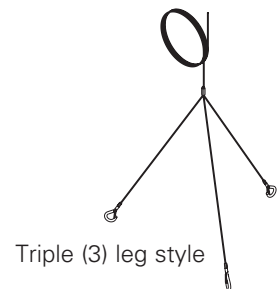

- Hook designed to accept up to 3/8" diameter wire.
- Available as a wire rope with hook termination only or as a ready-to-use kit with a BKC100 clamp.
- Available in lengths of 40", 80", 120", 180", 240", and 360".
- Available in single, double (Y), and triple (3) leg styles

KwikWire 'Y' Style Hook Termination

Part No.	Leg Length		Wire Rope Dia.		Length	
	in.	mm	in.	mm	in.	mm
BKYH18-094-40	18"	(457)	3/32"	(2.3)	40"	(1016)
BKYH18-094-80	18"	(457)	3/32"	(2.3)	80"	(2032)
BKYH18-094-120	18"	(457)	3/32"	(2.3)	120"	(3048)
BKYH18-094-180	18"	(457)	3/32"	(2.3)	180"	(4572)
BKYH18-094-240	18"	(457)	3/32"	(2.3)	240"	(6096)
BKYH18-094-360	18"	(457)	3/32"	(2.3)	360"	(9144)
BKYH30-094-40	30"	(762)	3/32"	(2.3)	40"	(1016)
BKYH30-094-80	30"	(762)	3/32"	(2.3)	80"	(2032)
BKYH30-094-120	30"	(762)	3/32"	(2.3)	120"	(3048)
BKYH30-094-180	30"	(762)	3/32"	(2.3)	180"	(4572)
BKYH30-094-240	30"	(762)	3/32"	(2.3)	240"	(6096)
BKYH30-094-360	30"	(762)	3/32"	(2.3)	360"	(9144)



**Box Quantity - 10**

5 bags containing 2 pieces per bag

KwikWire 'Y' Style Hook Termination Kits

Part No.	Leg Length		Wire Rope Dia.		Length	
	in.	mm	in.	mm	in.	mm
BKYH18-094-40K	18"	(457)	3/32"	(2.3)	40"	(1016)
BKYH18-094-80K	18"	(457)	3/32"	(2.3)	80"	(2032)
BKYH18-094-120K	18"	(457)	3/32"	(2.3)	120"	(3048)
BKYH18-094-180K	18"	(457)	3/32"	(2.3)	180"	(4572)
BKYH18-094-240K	18"	(457)	3/32"	(2.3)	240"	(6096)
BKYH18-094-360K	18"	(457)	3/32"	(2.3)	360"	(9144)
BKYH30-094-40K	30"	(762)	3/32"	(2.3)	40"	(1016)
BKYH30-094-80K	30"	(762)	3/32"	(2.3)	80"	(2032)
BKYH30-094-120K	30"	(762)	3/32"	(2.3)	120"	(3048)
BKYH30-094-180K	30"	(762)	3/32"	(2.3)	180"	(4572)
BKYH30-094-240K	30"	(762)	3/32"	(2.3)	240"	(6096)
BKYH30-094-360K	30"	(762)	3/32"	(2.3)	360"	(9144)



**Box Quantity - 10**

5 bags containing 2 pieces per bag

- Hook designed to accept up to 3/8" diameter wire.
- Available as a wire rope with loop termination only or as a ready-to-use kit with a BKC100 clamp.
- Available in lengths of 40", 80", 120", 180", 240", and 360".

## KwikWire Single Style Toggle Termination



### Box Quantity - 20

5 bags containing 4 pieces per bag

Part No.	Wire Rope Dia.		Length	
	in.	mm	in.	mm
<b>BKT-063-40</b>	1/16"	(1.6)	40"	(1016)
<b>BKT-063-80</b>	1/16"	(1.6)	80"	(2032)
<b>BKT-063-120</b>	1/16"	(1.6)	120"	(3048)
<b>BKT-063-180</b>	1/16"	(1.6)	180"	(4572)
<b>BKT-063-240</b>	1/16"	(1.6)	240"	(6096)
<b>BKT-063-360</b>	1/16"	(1.6)	360"	(9144)

## KwikWire Single Style Toggle Termination Kits



### Box Quantity - 20

5 bags containing 4 pieces per bag

Part No.	Wire Rope Dia.		Length	
	in.	mm	in.	mm
<b>BKT-063-40K</b>	1/16"	(1.6)	40"	(1016)
<b>BKT-063-80K</b>	1/16"	(1.6)	80"	(2032)
<b>BKT-063-120K</b>	1/16"	(1.6)	120"	(3048)
<b>BKT-063-180K</b>	1/16"	(1.6)	180"	(4572)
<b>BKT-063-240K</b>	1/16"	(1.6)	240"	(6096)
<b>BKT-063-360K</b>	1/16"	(1.6)	360"	(9144)

## KwikWire 'Y' Style Toggle Termination With Loop



### Box Quantity - 10

5 bags containing 2 pieces per bag

Part No.	Wire Rope Dia.		Length	
	in.	mm	in.	mm
<b>BKYT12-063</b>	1/16"	(1.6)	12"	(305)
<b>BKYT18-063</b>	1/16"	(1.6)	18"	(457)
<b>BKYT30-063</b>	1/16"	(1.6)	30"	(762)

- Available as a wire rope with toggle termination only or as a ready-to-use kit with a BKC100 clamp.
- Available in lengths of 40", 80", 120", 180", 240", and 360".
- Available in single, double (Y), and triple (3) leg styles
- All triple (3) leg styles are non-stock, contact us for lead times

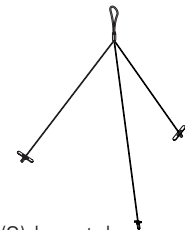

Triple (3) leg style

KwikWire 'Y' Style Toggle Termination

Part No.	Leg Length		Wire Rope Dia.		Length	
	in.	mm	in.	mm	in.	mm
BKYT12-063-40	12"	(305)	1/16"	(1.6)	40"	(1016)
BKYT12-063-80	12"	(305)	1/16"	(1.6)	80"	(2032)
BKYT12-063-120	12"	(305)	1/16"	(1.6)	120"	(3048)
BKYT12-063-180	12"	(305)	1/16"	(1.6)	180"	(4572)
BKYT12-063-240	12"	(305)	1/16"	(1.6)	240"	(6096)
BKYT12-063-360	12"	(305)	1/16"	(1.6)	360"	(9144)
BKYT18-063-40	18"	(457)	1/16"	(1.6)	40"	(1016)
BKYT18-063-80	18"	(457)	1/16"	(1.6)	80"	(2032)
BKYT18-063-120	18"	(457)	1/16"	(1.6)	120"	(3048)
BKYT18-063-180	18"	(457)	1/16"	(1.6)	180"	(4572)
BKYT18-063-240	18"	(457)	1/16"	(1.6)	240"	(6096)
BKYT18-063-360	18"	(457)	1/16"	(1.6)	360"	(9144)
BKYT30-063-40	30"	(762)	1/16"	(1.6)	40"	(1016)
BKYT30-063-80	30"	(762)	1/16"	(1.6)	80"	(2032)
BKYT30-063-120	30"	(762)	1/16"	(1.6)	120"	(3048)
BKYT30-063-180	30"	(762)	1/16"	(1.6)	180"	(4572)
BKYT30-063-240	30"	(762)	1/16"	(1.6)	240"	(6096)
BKYT30-063-360	30"	(762)	1/16"	(1.6)	360"	(9144)



**Box Quantity - 10**  
5 bags containing 2 pieces per bag

KwikWire 'Y' Style Toggle Termination Kits

Part No.	Leg Length		Wire Rope Dia.		Length	
	in.	mm	in.	mm	in.	mm
BKYT12-063-40K	12"	(305)	1/16"	(1.6)	40"	(1016)
BKYT12-063-80K	12"	(305)	1/16"	(1.6)	80"	(2032)
BKYT12-063-120K	12"	(305)	1/16"	(1.6)	120"	(3048)
BKYT12-063-180K	12"	(305)	1/16"	(1.6)	180"	(4572)
BKYT12-063-240K	12"	(305)	1/16"	(1.6)	240"	(6096)
BKYT12-063-360K	12"	(305)	1/16"	(1.6)	360"	(9144)
BKYT18-063-40K	18"	(457)	1/16"	(1.6)	40"	(1016)
BKYT18-063-80K	18"	(457)	1/16"	(1.6)	80"	(2032)
BKYT18-063-120K	18"	(457)	1/16"	(1.6)	120"	(3048)
BKYT18-063-180K	18"	(457)	1/16"	(1.6)	180"	(4572)
BKYT18-063-240K	18"	(457)	1/16"	(1.6)	240"	(6096)
BKYT18-063-360K	18"	(457)	1/16"	(1.6)	360"	(9144)
BKYT30-063-40K	30"	(762)	1/16"	(1.6)	40"	(1016)
BKYT30-063-80K	30"	(762)	1/16"	(1.6)	80"	(2032)
BKYT30-063-120K	30"	(762)	1/16"	(1.6)	120"	(3048)
BKYT30-063-180K	30"	(762)	1/16"	(1.6)	180"	(4572)
BKYT30-063-240K	30"	(762)	1/16"	(1.6)	240"	(6096)
BKYT30-063-360K	30"	(762)	1/16"	(1.6)	360"	(9144)



**Box Quantity - 10**  
5 bags containing 2 pieces per bag

Channel Nuts & Hardware

- Available as a wire rope with loop termination only or as a ready-to-use kit with a BKC100 clamp.
- Available in lengths of 40", 80", 120", 180", 240", and 360".



## KwikWire Bolt Termination



**Box Quantity - 20**  
5 bags containing 4 pieces per bag

Part No.	Thread Size	Wire Rope Dia.		Length	
		in.	mm	in.	mm
<b>BKB25-063-40</b>	1/4"-20	1/16"	(1.6)	40"	(1016)
<b>BKB25-063-80</b>	1/4"-20	1/16"	(1.6)	80"	(2032)
<b>BKB25-063-120</b>	1/4"-20	1/16"	(1.6)	120"	(3048)
<b>BKB25-063-180</b>	1/4"-20	1/16"	(1.6)	180"	(4572)
<b>BKB25-063-240</b>	1/4"-20	1/16"	(1.6)	240"	(6096)
<b>BKB25-063-360</b>	1/4"-20	1/16"	(1.6)	360"	(9144)
<b>BKB38-094-40</b>	3/8"-16	3/32"	(2.3)	40"	(1016)
<b>BKB38-094-80</b>	3/8"-16	3/32"	(2.3)	80"	(2032)
<b>BKB38-094-120</b>	3/8"-16	3/32"	(2.3)	120"	(3048)
<b>BKB38-094-180</b>	3/8"-16	3/32"	(2.3)	180"	(4572)
<b>BKB38-094-240</b>	3/8"-16	3/32"	(2.3)	240"	(6096)
<b>BKB38-094-360</b>	3/8"-16	3/32"	(2.3)	360"	(9144)

- Ideal for use with ARS, ARC, ADI, ACPW, or ACPD anchors.
- Available as a wire rope with bolt termination only or as a ready-to-use kit with a BKC100 clamp.
- Available in lengths of 40", 80", 120", 180", 240", and 360".
- Available in single, double (Y), and triple leg (3) styles
- All (Y) and triple (3) styles are non-stock, contact us for lead times

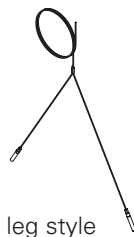

Double (Y) leg style

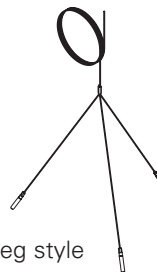

Triple (3) leg style

KwikWire Bolt Termination Kits

Part No.	Thread Size	Wire Rope Dia.		Length	
		in.	mm	in.	mm
<b>BKB25-063-40K</b>	1/4"-20	1/16"	(1.6)	40"	(1016)
<b>BKB25-063-80K</b>	1/4"-20	1/16"	(1.6)	80"	(2032)
<b>BKB25-063-120K</b>	1/4"-20	1/16"	(1.6)	120"	(3048)
<b>BKB25-063-180K</b>	1/4"-20	1/16"	(1.6)	180"	(4572)
<b>BKB25-063-240K</b>	1/4"-20	1/16"	(1.6)	240"	(6096)
<b>BKB25-063-360K</b>	1/4"-20	1/16"	(1.6)	360"	(9144)
<b>BKB38-094-40K</b>	3/8"-16	3/32"	(2.3)	40"	(1016)
<b>BKB38-094-80K</b>	3/8"-16	3/32"	(2.3)	80"	(2032)
<b>BKB38-094-120K</b>	3/8"-16	3/32"	(2.3)	120"	(3048)
<b>BKB38-094-180K</b>	3/8"-16	3/32"	(2.3)	180"	(4572)
<b>BKB38-094-240K</b>	3/8"-16	3/32"	(2.3)	240"	(6096)
<b>BKB38-094-360K</b>	3/8"-16	3/32"	(2.3)	360"	(9144)



**Box Quantity - 20**

5 bags containing 4 pieces per bag

- Ideal for use with ARS, ARC, ADI, ACPW, or ACPD anchors.
- Available as a wire rope with bolt termination only or as a ready-to-use kit with a BKC100 clamp.
- Available in lengths of 40", 80", 120", 180", 240", and 360".
- Available in single, double (Y), and triple (3) styles
- All double (Y) and triple (3) styles are non-stock, contact us for lead times



Double (Y) leg style



Triple (3) leg style

## KwikWire Angle Bracket Termination

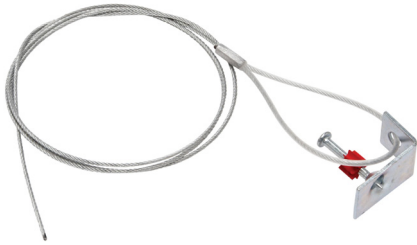

### Box Quantity - 20

5 bags containing 4 pieces per bag

Part No.	Wire Rope Dia.		Length	
	in.	mm	in.	mm
<b>BKA-063-40</b>	1/16"	(1.6)	40"	(1016)
<b>BKA-063-80</b>	1/16"	(1.6)	80"	(2032)
<b>BKA-063-120</b>	1/16"	(1.6)	120"	(3048)
<b>BKA-063-180</b>	1/16"	(1.6)	180"	(4572)
<b>BKA-063-240</b>	1/16"	(1.6)	240"	(6096)
<b>BKA-063-360</b>	1/16"	(1.6)	360"	(9144)

## KwikWire Angle Bracket Termination Kits

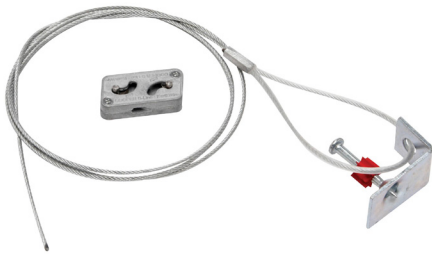

### Box Quantity - 20

5 bags containing 4 pieces per bag

Part No.	Wire Rope Dia.		Length	
	in.	mm	in.	mm
<b>BKA-063-40K</b>	1/16"	(1.6)	40"	(1016)
<b>BKA-063-80K</b>	1/16"	(1.6)	80"	(2032)
<b>BKA-063-120K</b>	1/16"	(1.6)	120"	(3048)
<b>BKA-063-180K</b>	1/16"	(1.6)	180"	(4572)
<b>BKA-063-240K</b>	1/16"	(1.6)	240"	(6096)
<b>BKA-063-360K</b>	1/16"	(1.6)	360"	(9144)

- Available as a wire rope with angle bracket termination only or as a ready-to-use kit with a BKC100 clamp.
- Available in lengths of 40", 80", 120", 180", 240", and 360".

