

# Twido and Altivar Magelis & OTB FTB System User Guide

[source code]

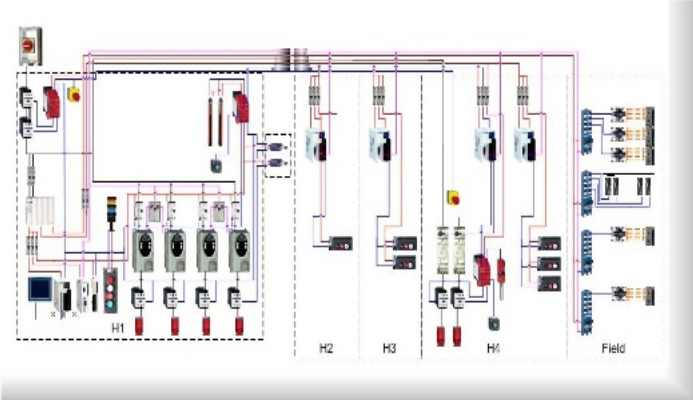

Preferred Implementation:  
Distributed CANopen Optimized

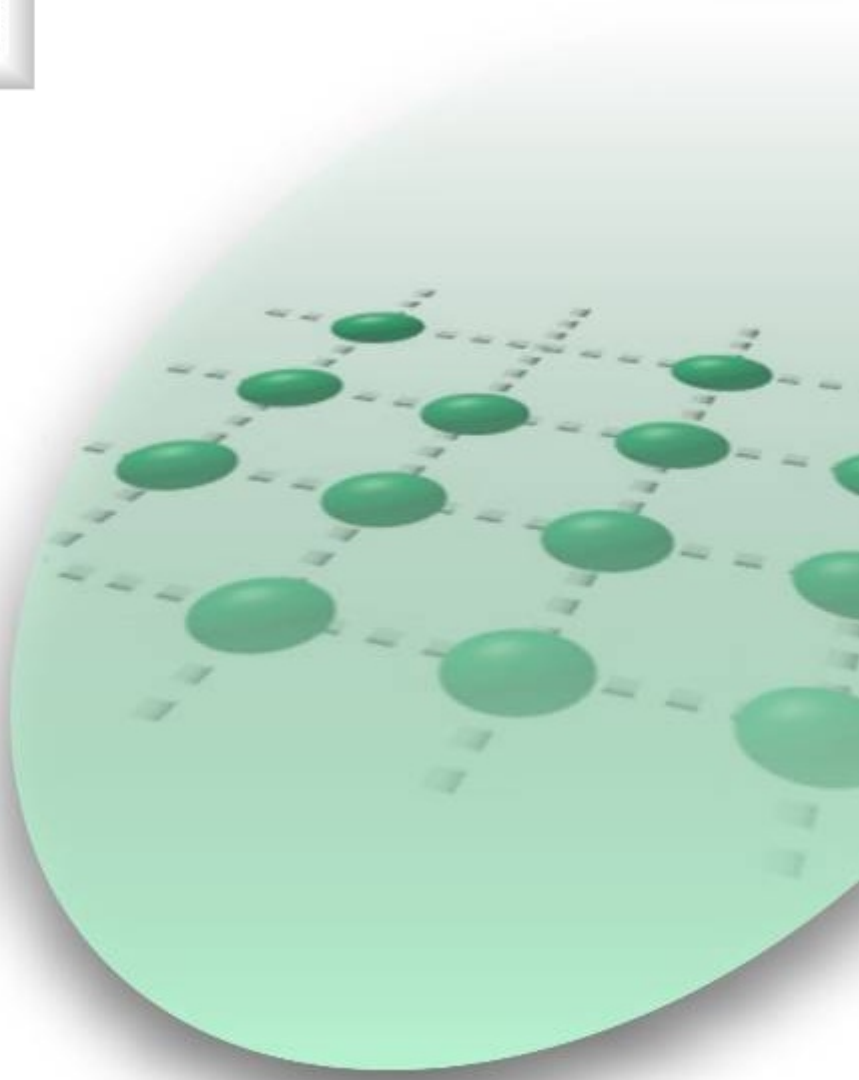

33003614.01

Merlin Gerin  
Square D  
Telemecanique

**Schneider**  
 **Electric**  
*Building a New Electric World*

Sep 2006

# Contents

<b>Application Source Code</b> .....	<b>4</b>
<b>Typical Applications</b> .....	<b>5</b>
<b>System</b> .....	<b>6</b>
<b>Architecture</b> .....	<b>6</b>
<b>Installation</b> .....	<b>9</b>
Hardware .....	16
Software .....	24
Communication .....	25
<b>Implementation</b> .....	<b>29</b>
Communication .....	32
HMI .....	38
PLC.....	55
Devices.....	88
Performance.....	101
<b>Appendix</b> .....	<b>102</b>
<b>Detailed Component List</b> .....	<b>102</b>
<b>Component Protection Classes</b> .....	<b>106</b>
<b>Component Features</b> .....	<b>107</b>
<b>Contact</b> .....	<b>115</b>

---

## Introduction

This document is intended to provide a quick introduction to the described System. It is not intended to replace any specific product documentation. On the contrary, it offers additional information to the product documentation, for installing, configuring and starting up the system.

A detailed functional description or the specification for a specific user application is not part of this document. Nevertheless, the document outlines some typical applications where the system might be implemented.

---

# Abbreviations

Word / Expression	Signification
<b>AC</b>	Alternating Current
<b>Advantys</b>	SE product name for a family of I/O modules
<b>Altivar (ATV)</b>	SE product name for a family of VSDs
<b>CANopen</b>	Name for a communications machine bus system
<b>CB</b>	Circuit Breaker
<b>CoDeSys</b>	Hardware-independent IEC 61131-3 programming software
<b>ConneXium</b>	SE product name for a Family of Transparent Factory devices
<b>DC</b>	Direct Current
<b>EDS</b>	Electronic Data Sheet
<b>E-OFF, E-STOP</b>	Emergency Off switch
<b>Harmony</b>	SE product name for a family of switches and indicators
<b>HMI</b>	Human Machine Interface
<b>I/O</b>	Input/Output
<b>IcIA (ICLA)</b>	SE product name for a compact drive
<b>Lexium/Lexium05/LXM</b>	SE product name for a family of servo-drives
<b>Magelis</b>	SE product name for a family of HMI-Devices
<b>MB - SL</b>	SE name for a serial Modbus communications protocol
<b>Micro</b>	SE product name for a middle range family of PLCs
<b>NIM</b>	SE product name for a Network Interface Module
<b>PC</b>	Personal Computer
<b>Phaseo</b>	SE product name for a family of power supplies
<b>PLC</b>	Programmable Logic Computer
<b>Powersuite</b>	An SE software product for configuring ALTIVAR drives
<b>Premium</b>	SE product name for a middle range family of PLCs
<b>Preventa</b>	SE product name for a family of safety devices
<b>PS1131 (CoDeSys)</b>	SE Product name for PLC programming software with CoDeSys
<b>PS</b>	Power Supply
<b>SE</b>	Schneider Electric
<b>Sycon</b>	SE product name of a Field bus programming software
<b>Telefast</b>	SE product name for a series of distributed I/O devices
<b>TesysU</b>	SE product name for a decentralised I/O System
<b>Twido</b>	SE product name of a middle range family of PLCs
<b>TwidoSoft</b>	SE product name for a PLC programming software
<b>TwidoSuite</b>	SE product name for a PLC programming software
<b>Unity (Pro)</b>	SE product name for a PLC programming software
<b>Vijeo Designer</b>	An SE software product for programming Magelis HMI devices
<b>VSD</b>	Variable Speed Drive
<b>WxHxD</b>	Dimensions : Width, Height and Depth
<b>XBT-L1000</b>	An SE software product for programming Magelis HMI devices

# Application Source Code

## Introduction

Examples of the source code and wiring diagrams used to attain the system function as described in this document can be downloaded from our website under [this](#) link.

The example source code is in the form of configuration, application and import files. Use the appropriate software tool to either open or import the files.

Extension	File Type	Software Tool Required
<b>AIW</b>	Configuration File	Advantys
<b>CNF</b>	<b>C</b> onfiguration <b>F</b> ile	Sycon
<b>CO</b>	<b>CAN</b> open definitions file	Sycon
<b>CSV</b>	<b>C</b> omma <b>S</b> eperated <b>V</b> alues, Spreadsheet	Twidosoft
<b>CTX</b>		Unity
<b>DCF</b>	<b>D</b> evice <b>C</b> onfiguration <b>F</b> ile	Advantys
<b>DIB</b>	<b>D</b> evice <b>I</b> ndependent <b>B</b> itmap	Sycon
<b>DOC</b>	<b>D</b> ocument file	Microsoft Word
<b>DOP</b>	Project File	Magelis XBTL
<b>EDS</b>	<b>E</b> lectronic <b>D</b> ata <b>S</b> heet – Device Definition	Industrial standard
<b>FEF</b>	Export file	PL7
<b>GSD</b>	EDS file ( <b>G</b> eraete <b>S</b> tamm <b>D</b> atei)	Profibus
<b>ISL</b>	<b>I</b> sland file, project file	Advantys
<b>PB</b>	<b>P</b> rofibus definitions file	Sycon
<b>PDF</b>	<b>P</b> ortable <b>D</b> ocument <b>F</b> ormat - document	Adobe Acrobat
<b>PS2</b>	Export file	Powersuite export file
<b>RTF</b>	<b>R</b> ich <b>T</b> ext <b>F</b> ile - document	Microsoft Word
<b>SPA</b>	Schneider Product Archive	TwidoSuite
<b>STU</b>	Project file	Unity Pro
<b>STX</b>	Project file	PL7
<b>TLX</b>	Project file	Twinline control tool
<b>TWD</b>	Project file	TwidoSoft
<b>VDZ</b>	Project file	Vijeo Designer
<b>XEF</b>	Export file	Unity Pro
<b>XPR</b>	Project File	TwidoSuite
<b>ZM2</b>	Project File	Zeliosoft



# Typical Applications

## Introduction

Here you will find a list of the typical applications, and their market segments, where this system or subsystem can be applied:

### Industrial

- Small automated machine or plant components
- Remote automation systems used to supplement large and medium-sized machines

### Buildings/Services





- Conveyor belt with turntable
- Irrigation systems for greenhouses

### Infrastructure

- Air-conditioning/ventilation for tunnel systems

### Food & Beverage/Pharmaceuticals

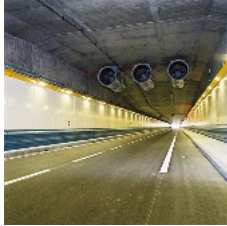
- Control and monitoring of pumps and valves

Application	Description	Image
Conveyor belt with turntable	These plant components are often connected upstream of a larger packaging or filling plant as feeder system components. Sorting is possible using photo barriers or weight sensors.	
Irrigation systems for greenhouses	This application controls irrigation in greenhouses. Temperature, light and humidity sensors permit the correct irrigation of all types of plants.	
Air-conditioning/ventilation for tunnel systems	Tunnel systems must be ventilated according to weather and traffic conditions. Small-scale systems can control turbines and valves in ventilation shafts and monitor carbon monoxide levels and air quality.	
Control and monitoring of pumps and valves	As part of an overall plant or external station in a water supply/drainage system. Pressure sensors, flow meters and level measuring (e.g., inductive measurements) can be used to adjust delivery according to demand.	

---

# System

---

## Introduction

The system chapter describes the architecture, the dimensions, the quantities and different types of components used within this system.

---

## Architecture

---

### General

The control section of this application consists of a Twido PLC, which can be controlled via a connected Magelis HMI panel. The load section is implemented using Altivar 31 VSDs, which are connected to the control system via the CANopen bus system and two TeSys U-line starter-controllers with reversing contactors.

The solution illustrated below offers three optional safety packages: a Preventa evaluation unit featuring an emergency-off function that can be accessed via 2 tamper-proof emergency-off buttons, and an evaluation unit of the same type that ensures door safety within the context of this application by using safety limit switches. A Preventa evaluation unit is also used to monitor a light curtain.

Four other OTBs are used as digital I/O for the remote locations H2-H3. Four FTBs are used for sensor acquisition in the field.

---

### Layout

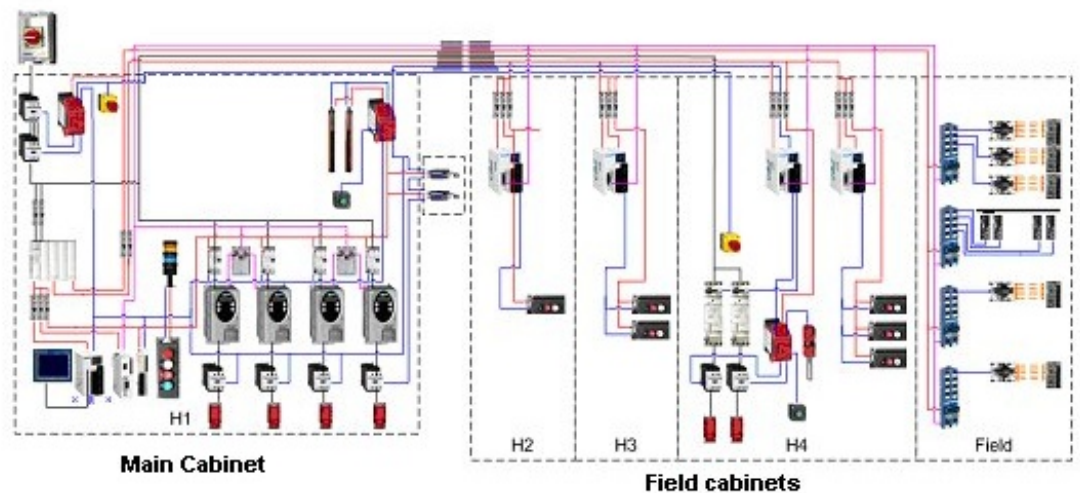

---

**Components****Hardware:**

- Emergency Off Master switch, 3-pole, 20A, 7.5KW (VCF 02GE)
- Motor fuse protector Multi 9 21107
- Altivar ATV31 variable speed drive with CANopen interface
- Motor starter, TeSysU-line type
- XALK locking-type emergency-off button with rotary unlocking (tamper-proof)
- Emergency-off switching devices, Preventa type
- Phaseo ABL7 RE power supply unit
- Modular/compact Twido PLC with CANopen module
- Magelis XBT-G compact color display terminal
- Advantys OTB and FTB modules for CANopen
- ZB5 pushbuttons and indicator lamps
- OSI family sensors (Osiprox, Osiswitch, Osiris)
- Standard AC motors

**Software:**

- TwidoSuite Version 1.0
- Advantys Lite Version 1.4
- PowerSuite 2.3
- Vijeo Designer V4.4

---

**Quantities of Components**

For a complete and detailed list of components, the quantities required and the order numbers, please refer to the components list at the rear of this document.

---

**Degree of Protection**

Not all the components in this configuration are designed to withstand the same environmental conditions. Some components may need additional protection, in the form of housings, depending on the environment in which you intend to use them. For environmental details of the individual components please refer to the list in the appendix of this document and the appropriate user manual.

---

**Technical Data**

Supply voltage	400 V AC
Total supply output	~ 11 kW
Drive rated powers	4 x 0.37 kW
Motor brake	None
Connector cross-section	5 x 2.5mm <sup>2</sup> (L1, L2, L3, N, PE)
Safety category	Cat. 3 (optional)

---

---

**Safety notice**

The standard and level of safety you apply to your application is determined by your system design and the overall extent to which your system may be a hazard to people and machinery.

As there are no moving mechanical parts in this application example, category 3 (according to EN954-1) has been selected as an optional safety level.

Whether or not the above safety category should be applied to your system should be ascertained with a proper risk analysis.

This document is not comprehensive for any systems using the given architecture and does not absolve users of their duty to uphold the safety requirements with respect to the equipment used in their systems or of compliance with either national or international safety laws and regulations

---

**Dimensions**

The dimensions of the devices used for H1 (e.g., the PLC, variable speed drive and the power supply) are suitable for installation inside a small control cabinet measuring 800x600x300 mm (WxHxD).

In addition, the display and control elements (e.g., start/emergency-off acknowledgment) can be integrated into the control cabinet door along with the Magelis HMI.

The Advantys OTB devices for H2 and H3 with their connection components should be installed directly on site in two small cabinet measuring 300x300x250mm (WxHxD). The buttons can be fed through or, with greater depths (300mm), installed inside the cabinet.

The Advantys OTB devices combined with the TeSys U units in H4 should be installed in a cabinet measuring 600x600x300mm (WxHxD). In addition, the display and control elements (e.g., start/emergency-off acknowledgment) can be integrated into the control cabinet door.

---

# Installation

---

## Introduction

This chapter describes the steps required to assemble the hardware and install the software in order to solve the application task concerned.

---

## Assembly

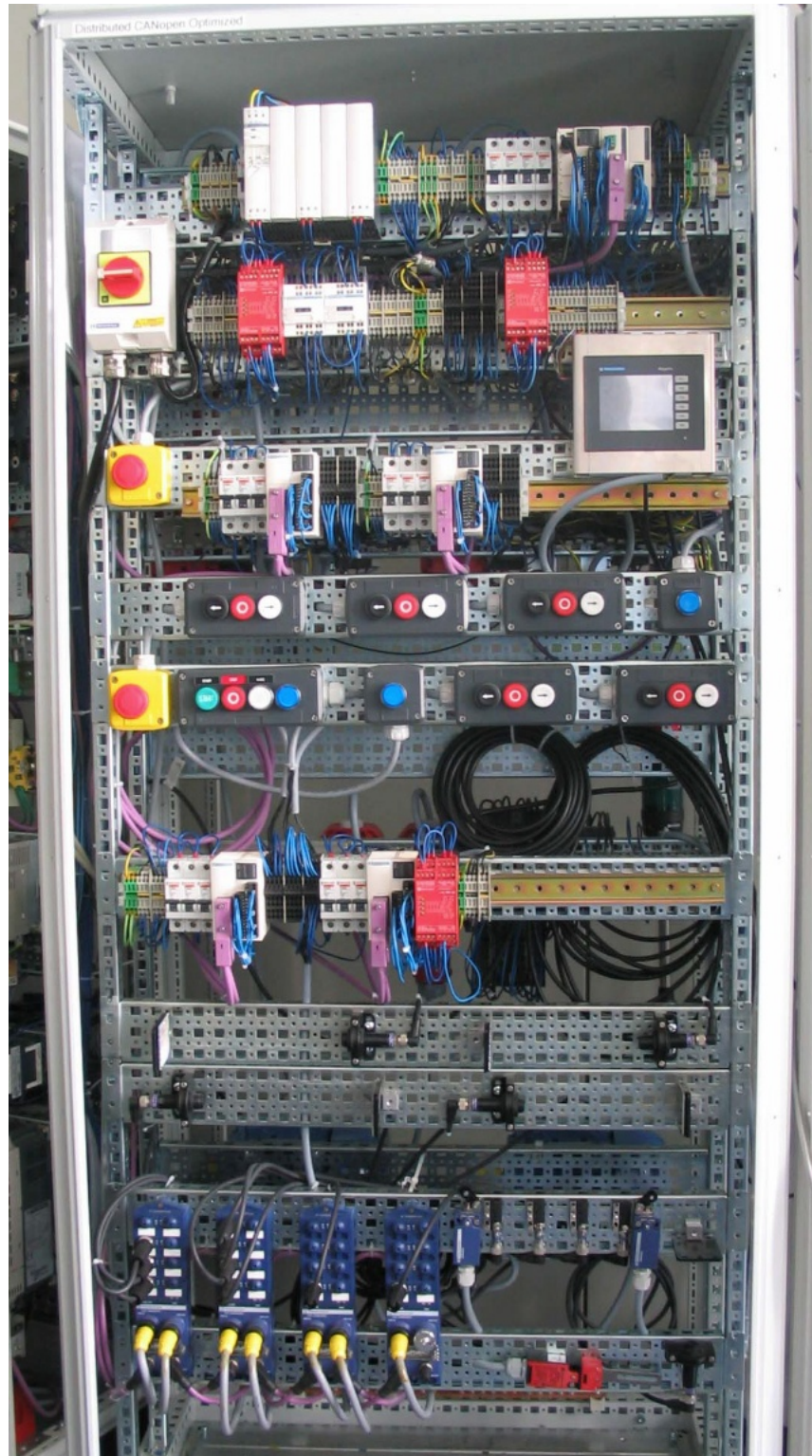



**Assembly  
Contd.**

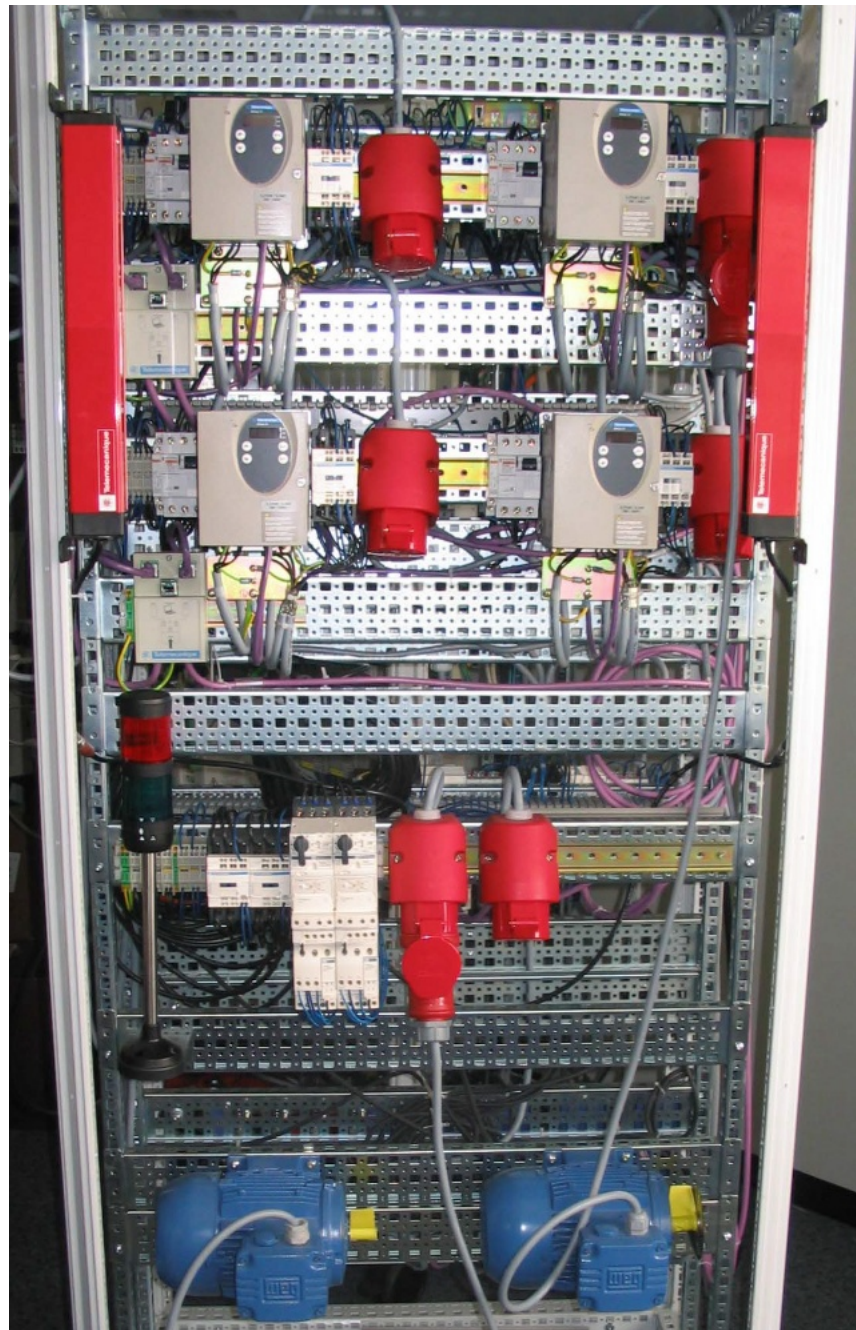

**Note**

The configuration used for this application is based on the example of a pallet conveyor system with a turntable.

The components and I/O points listed below represent a cross-section of the components and signals that are essential for control and display purposes, and a number of optional inputs and outputs that can be used in this application with the architecture described.

**Wiring of the Control Inputs and Outputs**

<p><b>Twido PLC inputs</b></p>	<p>%I 0.0 %I 0.1 %I 0.2 %I 0.3 %I 0.4 %I 0.5 %I 0.6 %I 0.7 %I 0.8 %I 0.9 %I 0.10 %I 0.11</p> <p>%I 2.0 %I 2.1 %I 2.2 %I 2.3 %I 2.4 %I 2.5 %I 2.6 %I 2.7</p>	<p>Emergency-off Preventa activated Emergency-off switch 1 pressed Emergency-off contactor activated Light curtain activated Light curtain Preventa activated Motor contactors 1-4 controlled Acknowledge button error Start button Stop button Manual mode button Free Free</p> <p>Limit switch 1 activated Limit switch 2 activated Emergency-off switch 2 pressed Free Belt 1 fuse OK Belt 2 fuse OK Belt 3 fuse OK Turntable fuse OK</p>
<p><b>Twido PLC outputs</b></p>	<p>%Q 1.0 (Trans) %Q 1.1 (Trans) %Q 1.2 %Q 1.3 %Q 1.4 %Q 1.5 %Q 1.6 %Q 1.7</p>	<p>Free Free Signal lamps – green - Running Signal lamps – yellow - Manual mode Signal lamps – red - Fault Button – blue - Running Button – white - Manual mode Button – blue – Acknow. light curtain</p>
<p><b>Twido power supply</b></p>	<p>Com (inputs) -V Com (+) Com 1 Com 2 Com 3</p>	<p>0 V DC reference voltage 0 V DC reference voltage +24 V DC +24 V DC +24 V DC +24 V DC</p>

**Wiring of  
OTB1**

<b>Advantys OTB inputs</b>	%IWC1.8.0:X0 %IWC1.8.0:X1 %IWC1.8.0:X2 %IWC1.8.0:X3 %IWC1.8.0:X4 %IWC1.8.0:X5 %IWC1.8.0:X6 %IWC1.8.0:X7 %IWC1.8.1:X0 %IWC1.8.1:X1 %IWC1.8.1:X2 %IWC1.8.1:X3	Reverse belt 1 Stop belt 1 Forward belt 1 Free Free Free Free Free Free Free Free Free
<b>Advantys OTB outputs</b>	%QWC1.8.0:X0 Trans %QWC1.8.0:X1 Trans %QWC1.8.0:X2 %QWC1.8.0:X3 %QWC1.8.0:X4 %QWC1.8.0:X5 %QWC1.8.0:X6 %QWC1.8.0:X7	Free Free Free Free Free Free Free Free
<b>Advantys OTB power supply</b>	Com (inputs) -V Com (+) Com 1 Com 2 Com 3 CANopen	0 V DC reference voltage 0 V DC reference voltage +24 V DC +24 V DC +24 V DC +24 V DC

**Wiring of  
OTB2**

<b>Advantys OTB inputs</b>	%IWC1.9.0:X0 %IWC1.9.0:X1 %IWC1.9.0:X2 %IWC1.9.0:X3 %IWC1.9.0:X4 %IWC1.9.0:X5 %IWC1.9.0:X6 %IWC1.9.0:X7 %IWC1.9.1:X0 %IWC1.9.1:X1 %IWC1.9.1:X2 %IWC1.9.1:X3	Reverse belt 2 Stop belt 2 Forward belt 2 Reverse belt 3 Stop belt 3 Forward belt 3 free free free free free free
<b>Advantys OTB outputs</b>	%QWC1.9.0:X0 Trans %QWC1.9.0:X1 Trans %QWC1.9.0:X2 %QWC1.9.0:X3 %QWC1.9.0:X4 %QWC1.9.0:X5 %QWC1.9.0:X6 %QWC1.9.0:X7	free free free free free free free free
<b>Advantys OTB power supply</b>	Com (inputs) -V Com (+) Com 1 Com 2 Com 3 CANopen	0 V DC reference voltage 0 V DC reference voltage +24 V DC +24 V DC +24 V DC +24 V DC





**Wiring of  
OTB3**

<b>Advantys OTB inputs</b>	%IWC1.10.0:X0 %IWC1.10.0:X1 %IWC1.10.0:X2 %IWC1.10.0:X3 %IWC1.10.0:X4 %IWC1.10.0:X5 %IWC1.10.0:X6 %IWC1.10.0:X7 %IWC1.10.1:X0 %IWC1.10.1:X1 %IWC1.10.1:X2 %IWC1.10.1:X3	free Reverse belt turntable Stop belt turntable Forwards belt turntable Reverse belt process Stop belt process Forwards belt process Reverse turntable Stop turntable Forwards turntable free free
<b>Advantys OTB outputs</b>	%QWC1.10.0:X0 Trans %QWC1.10.0:X1 Trans %QWC1.10.0:X2 %QWC1.10.0:X3 %QWC1.10.0:X4 %QWC1.10.0:X5 %QWC1.10.0:X6 %QWC1.10.0:X7	free free free free free free free free
<b>Advantys OTB power supply</b>	Com (inputs) -V Com (+) Com 1 Com 2 Com 3 CANopen	0 V DC reference voltage 0 V DC reference voltage +24 V DC +24 V DC +24 V DC +24 V DC

**Wiring of  
OTB4**

<b>Advantys OTB inputs</b>	%IWC1.11.0:X0 %IWC1.11.0:X1 %IWC1.11.0:X2 %IWC1.11.0:X3 %IWC1.11.0:X4 %IWC1.11.0:X5 %IWC1.11.0:X6 %IWC1.11.0:X7 %IWC1.11.1:X0 %IWC1.11.1:X1 %IWC1.11.1:X2 %IWC1.11.1:X3	Free Free Free Door safety contactor Door safety Preventa Module Belt Turntable in reverse Belt Turntable running forwards Belt Process in reverse Belt Process running forwards free free free
<b>Advantys OTB outputs</b>	%QWC1.11.0 :X0 Trans %QWC1.11.0 :X1 Trans %QWC1.11.0:X2 %QWC1.11.0:X3 %QWC1.11.0:X4 %QWC1.11.0:X5 %QWC1.11.0:X6 %QWC1.11.0:X7	free free Belt Turntable command reverse Belt Turntable command forwards Belt Process command reverse Belt Process command reverse free free
<b>Advantys OTB power supply</b>	Com (inputs) -V Com (+) Com 1 Com 2 Com 3 CANopen	0 V DC reference voltage 0 V DC reference voltage +24 V DC +24 V DC +24 V DC +24 V DC

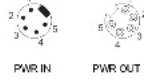
**Wiring of  
FTB1**

<b>Advantys FTB</b>	%IWC1.4.0:X0 %IWC1.4.0:X1 %IWC1.4.0:X2 %IWC1.4.0:X3 %IWC1.4.0:X4 %IWC1.4.0:X5 %IWC1.4.0:X6 %IWC1.4.0:X7	light curtain belt 1 light curtain belt 2 light curtain belt 3 free free free free free																																				
	%QWC1.4.0 %QWC1.4.1	free free																																				
<b>Advantys FTB power supply</b>	CANopen	<p>On FTB 1CN modules, the power supply is connected by means of a 5-pin 7/8" Mini-Style connector.</p>  <p>PWR IN PWR OUT</p> <p>Fig. 5-4: Power supply 5-pin 7/8" Mini-Style connector</p> <p>The table below shows pin assignment:</p> <table border="1"> <thead> <tr> <th>Pin</th> <th>Signal</th> </tr> </thead> <tbody> <tr> <td>Pin 1</td> <td>0V</td> </tr> <tr> <td>Pin 2</td> <td>0V</td> </tr> <tr> <td>Pin 3</td> <td>PE</td> </tr> <tr> <td>Pin 4</td> <td>Sensor &amp; bus power supply</td> </tr> <tr> <td>Pin 5</td> <td>Actuator power supply</td> </tr> </tbody> </table> <p>On FTB 1CN modules, the CAN Bus is connected by means of a 5-pin, M12 connector.</p>  <p>Fig. 5-2: Bus connection 5-pin 7/8" connector</p> <p>The table below shows pin assignment:</p> <table border="1"> <thead> <tr> <th>Pin</th> <th>Signal</th> <th>Color</th> <th>Comment</th> </tr> </thead> <tbody> <tr> <td>1</td> <td>Screen</td> <td>Screen</td> <td>Bridge, plug-socket and PE socket</td> </tr> <tr> <td>2</td> <td>NC</td> <td>Red</td> <td>Not connected</td> </tr> <tr> <td>3</td> <td>V-</td> <td>Black</td> <td>Bridge, plug-socket</td> </tr> <tr> <td>4</td> <td>CAN_H</td> <td>White</td> <td>Bridge, plug-socket</td> </tr> <tr> <td>5</td> <td>CAN_L</td> <td>Blue</td> <td>Bridge, plug-socket</td> </tr> </tbody> </table>	Pin	Signal	Pin 1	0V	Pin 2	0V	Pin 3	PE	Pin 4	Sensor & bus power supply	Pin 5	Actuator power supply	Pin	Signal	Color	Comment	1	Screen	Screen	Bridge, plug-socket and PE socket	2	NC	Red	Not connected	3	V-	Black	Bridge, plug-socket	4	CAN_H	White	Bridge, plug-socket	5	CAN_L	Blue	Bridge, plug-socket
Pin	Signal																																					
Pin 1	0V																																					
Pin 2	0V																																					
Pin 3	PE																																					
Pin 4	Sensor & bus power supply																																					
Pin 5	Actuator power supply																																					
Pin	Signal	Color	Comment																																			
1	Screen	Screen	Bridge, plug-socket and PE socket																																			
2	NC	Red	Not connected																																			
3	V-	Black	Bridge, plug-socket																																			
4	CAN_H	White	Bridge, plug-socket																																			
5	CAN_L	Blue	Bridge, plug-socket																																			

**Wiring of  
FTB2**

<b>Advantys FTB</b>	%IWC1.5.0:X0 %IWC1.5.0:X1 %IWC1.5.0:X2 %IWC1.5.0:X3 %IWC1.5.0:X4 %IWC1.5.0:X5 %IWC1.5.0:X6 %IWC1.5.0:X7	Proximity sensor Pos1 Proximity sensor Pos1.2 Proximity sensor Pos2 Proximity sensor Pos2.2 free free free free
	%QWC1.5.0 %QWC1.5.1	frei frei
<b>Advantys FTB power supply</b>	CANopen	See FTB1

**Wiring of FTB3**

<b>Advantys FTB</b>	%IWC1.6.0:X0	Photo barrier belt turntable
	%IWC1.6.0:X1	free
	%IWC1.6.0:X2	free
	%IWC1.6.0:X3	free
	%IWC1.6.0:X4	free
	%IWC1.6.0:X5	free
	%IWC1.6.0:X6	free
	%IWC1.6.0:X7	free
	%QWC1.6.0	frei
	%QWC1.6.1	frei
<b>Advantys FTB power supply</b>	CANopen	See FTB1

**Wiring of FTB4**

<b>Advantys FTB</b>	%IWC1.7.0:X0	Photo barrier belt sequence
	%IWC1.7.0:X1	free
	%IWC1.7.0:X2	free
	%IWC1.7.0:X3	free
	%IWC1.7.0:X4	free
	%IWC1.7.0:X5	free
	%IWC1.7.0:X6	free
	%IWC1.7.0:X7	free
	%QWC1.7.0	free
	%QWC1.7.1	free
<b>Advantys FTB power supply</b>	CANopen	See FTB1

**Wiring of VSD1**

<b>ATV31</b>	CANopen	<p><b>Wiring diagram for factory settings</b></p> <p>(1) Line choke, if used (single phase or 3 phase)  (2) Fault relay contacts, for remote indication of the drive status</p>
--------------	---------	---

**Wiring of VSD2**

<b>ATV31</b>	CANopen	See VSD1
--------------	---------	----------

**Wiring of VSD3**

<b>ATV31</b>	CANopen	See VSD1
--------------	---------	----------











**Wiring of VSD4**







<b>ATV31</b>	CANopen	See VSD1
--------------	---------	----------



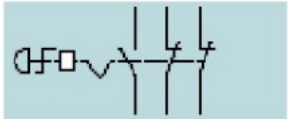

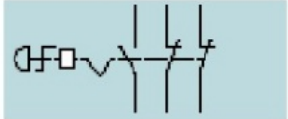
# Hardware

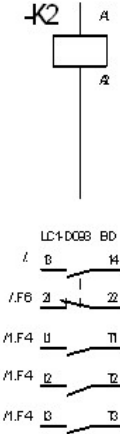
## General

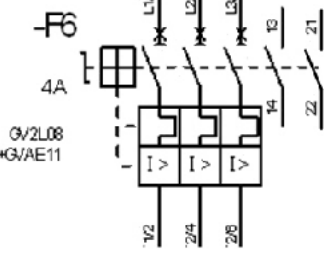

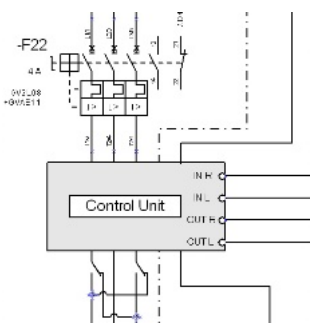

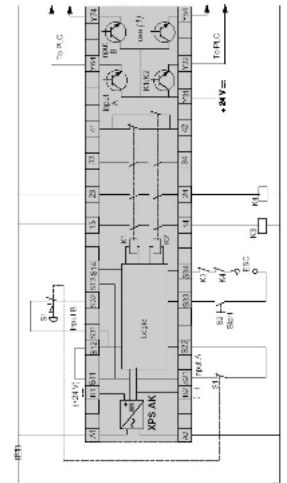
- The components designed for installation in a control cabinet, i.e., master switch, Twido PLC, Phaseo power supply unit, emergency-off switching device, line circuit breaker, contactors and motor circuit breaker, can be snapped onto a 35 mm DIN rail.
- The Altivar variable speed drive can also be snapped onto a DIN rail using an adapter, but can also be screwed directly onto the mounting plate without the need for an adapter plate.
- The emergency-off and door-safety switches, indicator bank as well as the housing for display and acknowledge indicators, are designed for backplane assembly in the field; with the exception of the door-safety switch, all switches can also be installed directly in a control cubicle (e.g., in cubicle door) without their enclosing housings.
- There are two options for installing XB5 pushbuttons or indicator lamps: These pushbuttons or switches can be installed either in a 22 mm hole, e.g., drilled into the front door of the control cabinet, or in an XALD-type housing suitable for up to 5 pushbuttons or indicator lamps. The XALD pushbutton housing is designed for backplane assembly or direct wall mounting.
- The individual components must be interconnected in accordance with the detailed circuit diagram in order to ensure they function correctly.

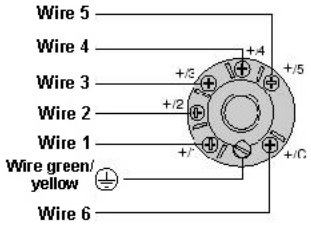
<p><b>Master switch complete</b></p> <p><b>VCF02GE</b></p>		<p>Wiring Diagrams Circuit Breaker in Housing or Switchblocks</p>  <p>Main Contact Module</p>  <p>Neutral Conductor Module</p>  <p>Auxiliary Contact Module</p> <p>VZ-T    VZ-20    VZM-05    VDM-06</p> 
<p><b>Option for Cabinet door</b></p> <p><b>Emergency OFF Master Switch</b></p> <p><b>VCD0</b></p>		<p>Wiring Diagrams Circuit Breaker in Housing or Switchblocks</p>  <p>Main Contact Module</p>  <p>Neutral Conductor Module</p>  <p>Auxiliary Contact Module</p> <p>VZ-T    VZ-20    VZM-05    VDM-06</p> 



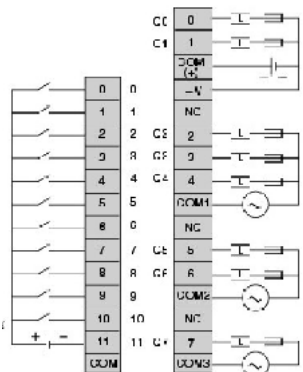

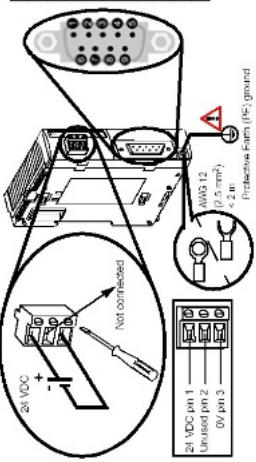
<p><b>EMERGENCY-OFF switch (tamper-proof)</b></p> <p><b>XALK174G</b></p>		
<p><b>Option for Cabinet door</b></p> <p><b>Emergency OFF Switch (Tamper Proof)</b></p> <p><b>XB5AS8445</b></p>		
<p><b>Contactor TesyS</b></p> <p><b>LC1D093BD</b></p>		
<p><b>Contactor TeSys</b></p> <p><b>GV2L08 +GV2AE11 (Maintenance Switch)</b></p>		

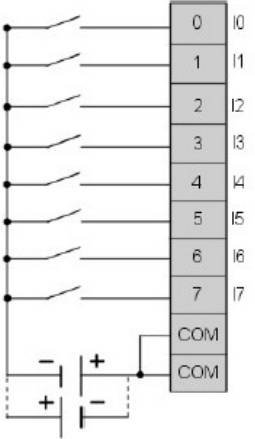

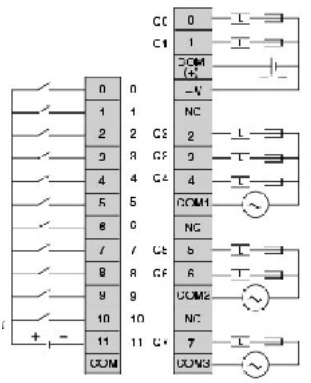

<p><b>TeSys U-line module</b></p> <p><b>contactor</b></p> <p>LUB12 + LU2B12BL + LUA1C11 + LUFN11 + LUCA05BL</p>		
<p><b>Preventa</b></p> <p><b>safety relay</b></p> <p>XPS AK331144P</p>		 <p>Module XPS AK associated with an Emergency stop button with 2 NC contacts.</p> <p>Wiring connection according to voltage: ~ across terminals A1/A2, or - 24 V across terminals S1/S2.</p> <p>ESR: External fault conditions.</p>
<p><b>Indicator Beacon</b></p> <p>XVB-C</p>		 <p>Wire 5</p> <p>Wire 4</p> <p>Wire 3</p> <p>Wire 2</p> <p>Wire 1</p> <p>Wire green/yellow</p> <p>Wire 6</p>

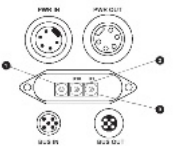
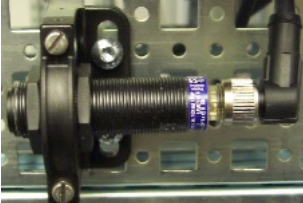
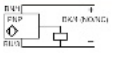

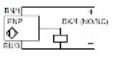
<p><b>Twido PLC</b> modular power base</p> <p><b>TWDLMDA20DRT</b></p>	 <p>TWDLMDA 20DRT</p>																															
<p><b>Twido PLC</b> interface module CANopen master</p> <p><b>TWDNCO1M</b></p>		<p><b>CANopen Master TWDNCO1M Module Connection</b></p> <p><b>CAN bus cable connection</b></p> <table border="1" data-bbox="1220 638 1428 817"> <thead> <tr> <th>Pin</th> <th>Signal</th> <th>Description</th> </tr> </thead> <tbody> <tr><td>1</td><td>Unused</td><td>Reserved</td></tr> <tr><td>2</td><td>CAN_L</td><td>CAN bus line</td></tr> <tr><td>3</td><td>CAN_GND</td><td>CAN Ground</td></tr> <tr><td>4</td><td>Unused</td><td>Reserved</td></tr> <tr><td>5</td><td>CAN_SHIELD</td><td>Optional CAN shielding</td></tr> <tr><td>6</td><td>GND</td><td>Optional Ground</td></tr> <tr><td>7</td><td>CAN_H</td><td>CAN bus line</td></tr> <tr><td>8</td><td>Unused</td><td>Reserved</td></tr> <tr><td>9</td><td>CAN_V+</td><td>NC</td></tr> </tbody> </table> 	Pin	Signal	Description	1	Unused	Reserved	2	CAN_L	CAN bus line	3	CAN_GND	CAN Ground	4	Unused	Reserved	5	CAN_SHIELD	Optional CAN shielding	6	GND	Optional Ground	7	CAN_H	CAN bus line	8	Unused	Reserved	9	CAN_V+	NC
Pin	Signal	Description																														
1	Unused	Reserved																														
2	CAN_L	CAN bus line																														
3	CAN_GND	CAN Ground																														
4	Unused	Reserved																														
5	CAN_SHIELD	Optional CAN shielding																														
6	GND	Optional Ground																														
7	CAN_H	CAN bus line																														
8	Unused	Reserved																														
9	CAN_V+	NC																														
<p><b>Twido DC IN module</b> 8x DC IN</p> <p><b>TWDDDI8DT</b></p>																																

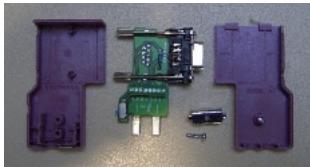
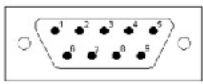
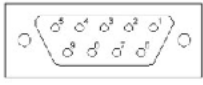
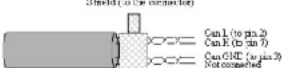

<p><b>Twido OTB</b></p> <p><b>OTB1C0DM9LP</b></p> <p>CANopen module 12x DC IN/6x DC OUT/2x AC OUT</p>																										
<p><b>FTB module</b></p> <p>8 IN/diagnostic 8 OUT</p> <p><b>FTB1CN08E08S</b></p>		<p><b>Sensor and actuator connections</b></p>  <p>Pin 1: +24 V Pin 2: I0 to I7 diagnostic or function input or output Pin 3: 0 V Pin 4: O0 to O7 function input or output Pin 5: PE</p> <p>The "Track-ID" (as index of the FTB 1C module) is indicated by the number using the necessary address (see Fig. 5 page below).</p>  <ul style="list-style-type: none"> <li>● Track-ID = 0</li> <li>● Track-ID = 10</li> <li>● Track-ID = 1</li> </ul>																								
<p><b>Light Curtain</b></p> <p><b>XUB1APANM12</b></p>		<p><b>Connections</b></p> <table border="1"> <thead> <tr> <th>M12 connector</th> <th>Pre-cabled</th> <th>PNP</th> </tr> </thead> <tbody> <tr> <td>1 (+)</td> <td>(+) 24 V (24 V)</td> <td>PNP</td> </tr> <tr> <td>2 (-)</td> <td>(-) 0 V (0 V)</td> <td>PNP</td> </tr> <tr> <td>3 (DI1) Output</td> <td>(DI1) Output (DI1)</td> <td>PNP</td> </tr> <tr> <td>4 (DI2) Output</td> <td>(DI2) Output (DI2)</td> <td>PNP</td> </tr> <tr> <td>5 (DO1) Output</td> <td>(DO1) Output (DO1)</td> <td>PNP</td> </tr> <tr> <td>6 (DO2) Output</td> <td>(DO2) Output (DO2)</td> <td>PNP</td> </tr> <tr> <td>7 (V) (V)</td> <td>(V) (V)</td> <td>PNP</td> </tr> </tbody> </table> 	M12 connector	Pre-cabled	PNP	1 (+)	(+) 24 V (24 V)	PNP	2 (-)	(-) 0 V (0 V)	PNP	3 (DI1) Output	(DI1) Output (DI1)	PNP	4 (DI2) Output	(DI2) Output (DI2)	PNP	5 (DO1) Output	(DO1) Output (DO1)	PNP	6 (DO2) Output	(DO2) Output (DO2)	PNP	7 (V) (V)	(V) (V)	PNP
M12 connector	Pre-cabled	PNP																								
1 (+)	(+) 24 V (24 V)	PNP																								
2 (-)	(-) 0 V (0 V)	PNP																								
3 (DI1) Output	(DI1) Output (DI1)	PNP																								
4 (DI2) Output	(DI2) Output (DI2)	PNP																								
5 (DO1) Output	(DO1) Output (DO1)	PNP																								
6 (DO2) Output	(DO2) Output (DO2)	PNP																								
7 (V) (V)	(V) (V)	PNP																								
<p><b>Proximity sensor</b></p> <p><b>XS608B1PAM12</b></p>		<p><b>Connections</b></p> <table border="1"> <thead> <tr> <th>M12 connector</th> <th>Pre-cabled</th> <th>PNP</th> </tr> </thead> <tbody> <tr> <td>1 (+)</td> <td>(+) 24 V (24 V)</td> <td>PNP</td> </tr> <tr> <td>2 (-)</td> <td>(-) 0 V (0 V)</td> <td>PNP</td> </tr> <tr> <td>3 (DI1) Output</td> <td>(DI1) Output (DI1)</td> <td>PNP</td> </tr> <tr> <td>4 (DI2) Output</td> <td>(DI2) Output (DI2)</td> <td>PNP</td> </tr> <tr> <td>5 (DO1) Output</td> <td>(DO1) Output (DO1)</td> <td>PNP</td> </tr> <tr> <td>6 (DO2) Output</td> <td>(DO2) Output (DO2)</td> <td>PNP</td> </tr> <tr> <td>7 (V) (V)</td> <td>(V) (V)</td> <td>PNP</td> </tr> </tbody> </table> 	M12 connector	Pre-cabled	PNP	1 (+)	(+) 24 V (24 V)	PNP	2 (-)	(-) 0 V (0 V)	PNP	3 (DI1) Output	(DI1) Output (DI1)	PNP	4 (DI2) Output	(DI2) Output (DI2)	PNP	5 (DO1) Output	(DO1) Output (DO1)	PNP	6 (DO2) Output	(DO2) Output (DO2)	PNP	7 (V) (V)	(V) (V)	PNP
M12 connector	Pre-cabled	PNP																								
1 (+)	(+) 24 V (24 V)	PNP																								
2 (-)	(-) 0 V (0 V)	PNP																								
3 (DI1) Output	(DI1) Output (DI1)	PNP																								
4 (DI2) Output	(DI2) Output (DI2)	PNP																								
5 (DO1) Output	(DO1) Output (DO1)	PNP																								
6 (DO2) Output	(DO2) Output (DO2)	PNP																								
7 (V) (V)	(V) (V)	PNP																								

<p><b>Cable for photo barriers and proximity sensor</b></p> <p><b>XZCP1264L2</b></p> <p>Only 1x M12 connector for sensor: other side must be extended with connector XZCC12FDM40B</p>		<p><b>Connections</b></p> <table border="1"> <thead> <tr> <th>M12 connector</th> <th>Pre-cabled</th> <th>PNP</th> </tr> </thead> <tbody> <tr> <td>1 IN</td> <td>10 BU (Blue)</td> <td>10 BU (Blue)</td> </tr> <tr> <td>2 IN</td> <td>14 BN (Black)</td> <td>14 BN (Black)</td> </tr> <tr> <td>4 OUT/Output</td> <td>10 OUT/Output BK (Black)</td> <td>10 OUT/Output BK (Black)</td> </tr> <tr> <td>2 Brown/Brwn</td> <td>20 Brwn (Brown)</td> <td>20 Brwn (Brown)</td> </tr> <tr> <td>Red/Red</td> <td>21 Red</td> <td>21 Red</td> </tr> </tbody> </table> 	M12 connector	Pre-cabled	PNP	1 IN	10 BU (Blue)	10 BU (Blue)	2 IN	14 BN (Black)	14 BN (Black)	4 OUT/Output	10 OUT/Output BK (Black)	10 OUT/Output BK (Black)	2 Brown/Brwn	20 Brwn (Brown)	20 Brwn (Brown)	Red/Red	21 Red	21 Red
M12 connector	Pre-cabled	PNP																		
1 IN	10 BU (Blue)	10 BU (Blue)																		
2 IN	14 BN (Black)	14 BN (Black)																		
4 OUT/Output	10 OUT/Output BK (Black)	10 OUT/Output BK (Black)																		
2 Brown/Brwn	20 Brwn (Brown)	20 Brwn (Brown)																		
Red/Red	21 Red	21 Red																		
<p><b>CANopen connector</b></p> <p><b>TSX CANKCDF90TP</b> (additional contact for bus analysis) or <b>TSX CANKCDF90T</b> Both incl. terminating resistor for connection to Twido CANopen Master</p> <p><b>CANopen cable</b> <b>TSXCANCA50</b></p>	 <p>Male (pins)</p>  <p>Female (sockets)</p>  <table border="1"> <thead> <tr> <th>Pin N°</th> <th>Signal</th> <th>Description</th> </tr> </thead> <tbody> <tr> <td>2</td> <td>CAN_L</td> <td>CAN_L bus Line</td> </tr> <tr> <td>3</td> <td>CAN_GND</td> <td>CAN ground</td> </tr> <tr> <td>7</td> <td>CAN_H</td> <td>CAN_H bus Line</td> </tr> </tbody> </table> <p>Shield (to be connected)</p> 	Pin N°	Signal	Description	2	CAN_L	CAN_L bus Line	3	CAN_GND	CAN ground	7	CAN_H	CAN_H bus Line							
Pin N°	Signal	Description																		
2	CAN_L	CAN_L bus Line																		
3	CAN_GND	CAN ground																		
7	CAN_H	CAN_H bus Line																		
<p><b>Magelis operator terminal</b></p> <p><b>XBTGT1100</b></p>	 <p><b>And on the rear panel:</b></p> <ol style="list-style-type: none"> <li>1 A removable screw terminal for <math>\pm 24</math> V power supply.</li> <li>2 A RJ45 connector for RS 232 C or RS 485 serial link to PLCs (COM1).</li> <li>3 A 8-way female mini-DIN connector for application transfer cable.</li> <li>4 A polarization switch for serial link used in RS 485 Modbus.</li> </ol> <p>On XBT GT1130 only</p> <ol style="list-style-type: none"> <li>5 A RJ45 connector for Ethernet TCP/IP (10BASE-T) link.</li> </ol> 																			

**Variable speed drive  
Altivar ATV31**

**ATV31H037N4**

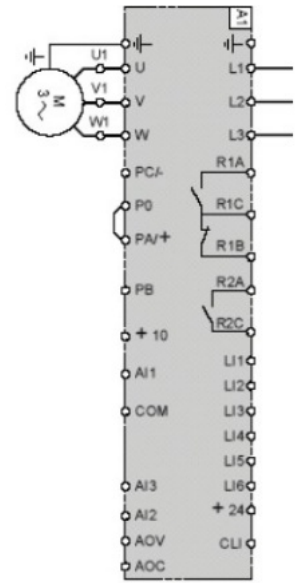

**CANopen TAP**

**VW3CANTAP2**

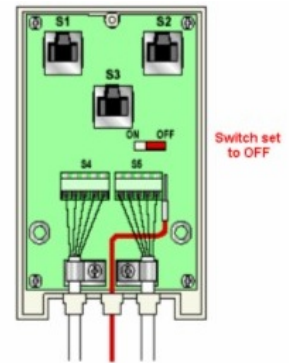
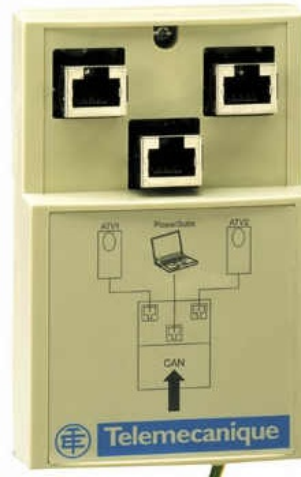

Pin	Signal	Description
1	GND	Ground
2	CAN_L	CAN_L bus line
3	SHLD	Optional shield
4	CAN_H	CAN_H bus line
5	(V+)	Optional supply (1)

---

## Software

---

### General

The software is primarily used for programming the Twido PLC and configuring CANopen communication, as well as for visualization.

The TwidoSuite programming tool is used for programming the PLC.

The HMI application on the XBT-GT 1100 Magelis display terminal is configured using Vijeo Designer software.

Although Altivar 31 variable speed drives can be parameterized via the front panel, the PowerSuite software is a more user-friendly option. As well as providing a convenient means of setting drive parameters, this software also enables data to be saved and archived. These functions are extremely useful as they mean that parameters can be restored rapidly whenever service tasks need to be performed. The software can also help you to optimize the parameters online. The software is supplied with the drive.

To use the software packages, your PC must have the appropriate Microsoft Windows operating system installed:

- Windows 2000 *or*
- Windows XP

The software tools have the following default install paths:

- TwidoSuite  
C:\Program Files\Schneider Electric\TwidoSuite
- Advantys  
C:\Program Files\Schneider Electric\Advantys
- Vijeo Designer  
C:\Program Files\Schneider Electric\VijeoDesigner
- PowerSuite ATV31  
C:\Program Files\Schneider Electric\PowerSuite



## Communication

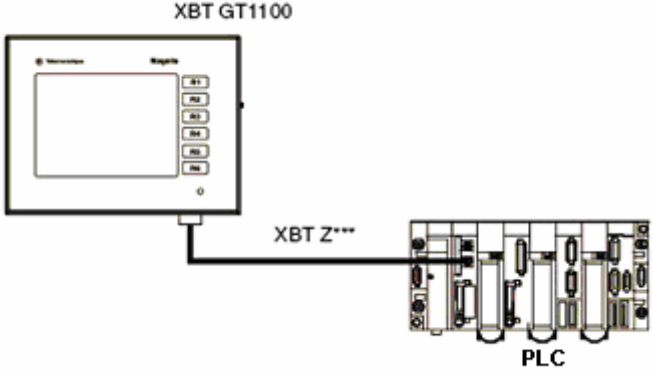
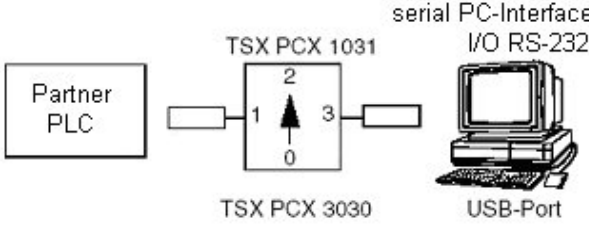

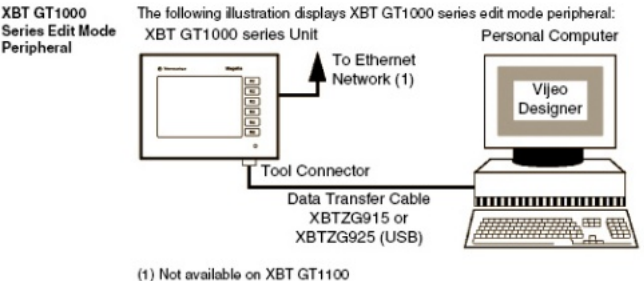
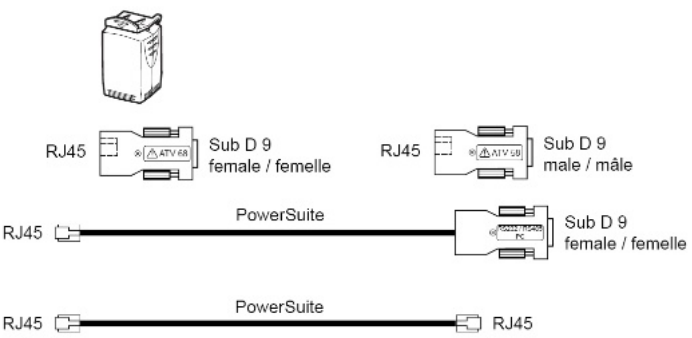

<p style="text-align: center;"><b>HMI &lt;&gt; Twido</b></p>	<p>A Modbus connection is used to exchange data between the Magelis terminal and the Twido PLC. The XBTZ9780 communication cable shown below is needed to connect these two devices. The software driver required for Modbus communication is already contained in the software packages for the Magelis panel and the Twido.</p>
<p style="text-align: center;"><b>Magelis communication cable</b> <b>XBTZ9780</b></p>	 <p>The diagram illustrates the connection between a Magelis terminal (model XBT GT1100) and a PLC. A communication cable (labeled XBT Z***) is connected between the terminal and the PLC's communication port.</p>
<p style="text-align: center;"><b>Twido &lt;&gt; PC</b></p>	<p>A TSXPCX1031 (serial) or TSXPCX3030 (USB) communication cable is used to exchange data between the Twido PLC and the programming PC. An extra driver must be installed for the USB cable. The driver for the serial cable is integrated into the TwidoSoft tool.</p> <p>Ensure that switch position 2 is set on the cable. Port 1 must be set/configured on the control system for point-to-point communication.</p>
<p style="text-align: center;"><b>Twido programming cable</b> <b>TSXPCX1031 (serial)</b> <b>or</b> <b>TSXPCX3030 (USB)</b></p>	 <p>The diagram shows a Partner PLC connected to a PC through a communication cable. The cable has a switch with positions 0, 1, 2, and 3. Position 2 is indicated as the correct setting. The cable is labeled TSX PCX 1031 and TSX PCX 3030. The PC side is labeled 'serial PC-Interface I/O RS-232' and 'USB-Port'.</p>





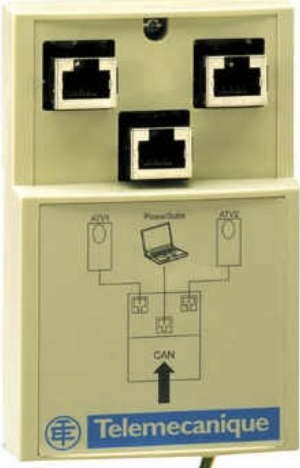

<p align="center"><b>HMI &lt;&gt; PC</b></p>	<p>An XBTGZ915 communications cable is used to exchange data between the HMI XBTGT 1100 and the programming PC.</p> <p>This is contained in the Vijeo Designer software package.</p>
<p align="center"><b>XBTG programming cable</b> <b>XBTGZ915</b></p>	<p>The following illustration displays XBT GT1000 series edit mode peripheral:</p>  <p>(1) Not available on XBT GT1100</p>
<p align="center"><b>ATV31 &lt;&gt; PC</b></p>	<p>Programming the Altivar is done using the cable <b>VW3A8106</b> and the Powersuite cable RJ45&lt;&gt;SubD9 (black).</p>
<p align="center"><b>ATV31-Programming Cable</b> <b>VW3A8106</b></p>	



## CANopen

The data transfer between the individual bus clients can be implemented with either self made or pre-confectioned cable. Below you will find a component description.

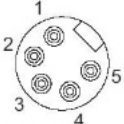
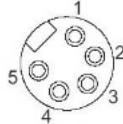
<p><b>CANopen Master Module</b></p> <p><b>TWDNCO1M</b></p> <p>The CANopen-Interface-Module is plugged into the Twido PLC and has a Sub-D-9 CANopen connection</p>																			
<p><b>CANopen Plug</b></p> <p><b>TSXCANKCDF90T</b></p> <p>Use this plug on the <b>TWDNCO1M</b>. Plug includes a terminal resistor.</p> <p><b>CANopen-Kabel</b></p> <p><b>TSXCANCD50</b></p> <p>Flexibles Kabel</p>																			
<p><b>CANopen-TAP</b></p> <p><b>VW3CANTAP2</b></p> <p>Connection for 2 drives of type Altivar 31. Configuration port for use with PowerSuite. Terminal resistor can be selected using the ON/OFF switch.</p> <p>The image shows the resistor set to OFF.</p>	 <table border="1" data-bbox="1157 1554 1401 1666"> <thead> <tr> <th>Pin</th> <th>Signal</th> <th>Description</th> </tr> </thead> <tbody> <tr> <td>1</td> <td>GND</td> <td>Ground</td> </tr> <tr> <td>2</td> <td>CAN_L</td> <td>CAN_L bus line</td> </tr> <tr> <td>3</td> <td>SHLD</td> <td>Optional shield</td> </tr> <tr> <td>4</td> <td>CAN_H</td> <td>CAN_H bus line</td> </tr> <tr> <td>5</td> <td>(V+)</td> <td>Optional supply (1)</td> </tr> </tbody> </table>	Pin	Signal	Description	1	GND	Ground	2	CAN_L	CAN_L bus line	3	SHLD	Optional shield	4	CAN_H	CAN_H bus line	5	(V+)	Optional supply (1)
Pin	Signal	Description																	
1	GND	Ground																	
2	CAN_L	CAN_L bus line																	
3	SHLD	Optional shield																	
4	CAN_H	CAN_H bus line																	
5	(V+)	Optional supply (1)																	
<p><b>CanOpen Branch Cable</b></p> <p><b>VW3CANRR1</b></p> <p>Connects the TAP to the Altivar 31 with two RJ54 plugs.</p>																			

<p><b>Bus Cable CANopen</b></p> <p><b>FTXCN3210</b></p> <p>Connect the FTB modules in serie starting with the</p> <p><b>CANopen-Tap</b></p> <p><b>VW3CANTDM4.</b></p>	 <div style="display: flex; justify-content: space-around; align-items: center;"> <div style="text-align: center;"> <p><b>BUS IN</b></p>  </div> <div style="text-align: center;"> <p><b>BUS OUT</b></p>  </div> </div> <table border="1" style="margin-top: 10px;"> <thead> <tr> <th>PIN</th> <th>Signal</th> <th>Colour</th> </tr> </thead> <tbody> <tr> <td>1</td> <td>Shld</td> <td>-</td> </tr> <tr> <td>2</td> <td>V+</td> <td>Red</td> </tr> <tr> <td>3</td> <td>GND</td> <td>Black</td> </tr> <tr> <td>4</td> <td>CAN_H</td> <td>White</td> </tr> <tr> <td>5</td> <td>CAN_L</td> <td>Blue</td> </tr> </tbody> </table>	PIN	Signal	Colour	1	Shld	-	2	V+	Red	3	GND	Black	4	CAN_H	White	5	CAN_L	Blue
PIN	Signal	Colour																	
1	Shld	-																	
2	V+	Red																	
3	GND	Black																	
4	CAN_H	White																	
5	CAN_L	Blue																	
<p><b>Power Supply Cable</b></p> <p><b>FTXDP2210</b></p> <p>the FTB power supply cables are linked in serie from one module to the next.</p>	 <div style="display: flex; justify-content: space-around; align-items: center;"> <div style="text-align: center;"> <p><b>POWER IN</b></p>  </div> <div style="text-align: center;"> <p><b>POWER OUT</b></p>  </div> </div> <table border="1" style="margin-top: 10px;"> <thead> <tr> <th>PIN</th> <th>Signal</th> <th>Cable</th> </tr> </thead> <tbody> <tr> <td>1</td> <td>0V</td> <td>1</td> </tr> <tr> <td>2</td> <td>0V</td> <td>2</td> </tr> <tr> <td>3</td> <td>PE</td> <td>Green/Yellow</td> </tr> <tr> <td>4</td> <td>+24V DI</td> <td>3</td> </tr> <tr> <td>5</td> <td>+24V DO</td> <td>4</td> </tr> </tbody> </table>	PIN	Signal	Cable	1	0V	1	2	0V	2	3	PE	Green/Yellow	4	+24V DI	3	5	+24V DO	4
PIN	Signal	Cable																	
1	0V	1																	
2	0V	2																	
3	PE	Green/Yellow																	
4	+24V DI	3																	
5	+24V DO	4																	
<p><b>Advantys FTB Terminal Resistor CANopen</b></p> <p><b>FTXCNTL12</b></p> <p>Connect to the last FTBModule in the series on the BUS OUT-Socket.</p>																			



---

# Implementation

---

<b>Introduction</b>	The implementation chapter describes all the steps necessary to initialise, to configure, to program and start-up the system to achieve the application functions as listed below.
<b>Function</b>	This is a simple function which has been selected to illustrate all of the components used in a practical application and to demonstrate their functions. The function can of course be modified to your own requirements.
<b>General</b>	<p>The conveyor belt system consists of five belts. The packets are delivered via the chute onto the first belt. The first three belts, operating at different speeds, increase the distance between the packets and are controlled by the first three VSDs. The next stage is a short belt on a turntable. The turntable alters the direction of transport by 90°. The packet is finally conveyed via a fifth belt to the exit. Here the packet is passed onto the next section by a robot.</p> <p>Photo barriers are used to isolate the packets so that at any time there is only one packet in a segment/belt. All three belts are controlled by variable speed drives (VSD) to permit differing speeds.</p> <p>Belt 4 only accepts packets from belt 3 in the "Receive" position, during which belt 4 is driven then stopped as soon as the photo barrier is broken. The turntable then moves to the next position, "Release". As soon as the turntable reaches the "Release" position, the belt is restarted and then runs for a certain time to ensure that the packet has left the belt. The turntable then returns to the "Receive" position.</p> <p>The turntable is controlled by a fourth VSD and monitored by four proximity sensors as position indicators and two limit switches as impact protection devices..</p> <p>Belt 5 receives the packet in the "Receive" position and conveys it until it has passed the photo barrier. If the photo barrier is then opened, the belt is run as "Empty".</p> <p>Belts 4 and 5 are both controlled by a TeSys U. The belts are thus run at a constant speed.</p>
<b>Manual &amp; Auto</b>	<p>There are 3 operation modes: Manual and Automatic and HMI. A pushbutton is provided to change between manual and automatic. It reacts to a rising edge.</p> <p>The individual buttons for motor control are only enabled in manual mode but the buttons in the 4-button housing and the two individual acknowledge buttons are excluded from this pre-condition. The HMI mode can only be selected and de-selected on the Magelis XBTG device.</p>

## Safety devices

**the Emergency-off buttons** switch the power off for the complete plant. This excludes all PLC components and sensors. This is registered and displayed as a fault on the illuminated beacon. As long as the fault is present, the acknowledge button blinks, turning to permanent when the emergency off buttons have been unlocked.

When activated, the **light curtain** isolates all four VSDs from the motors. This is signaled and displayed as a fault on the illuminated beacon. Although an acknowledgement is possible, the acknowledge button for the light curtain assumes that the fault is still active and blinks permanently.

The **door switch** disconnects the two belt motors from the TeSys U units when the door is opened. Although an acknowledgement is possible, the acknowledge button for the door switch assumes that the fault is still active and blinks permanently.

All switch-off operations are performed on the hardware itself, only the relevant fault signaling must be performed in the PLC.

## Push Buttons

The buttons as described here and in the assembly model, are housed in an external housing. They could, however, be built into a cabinet door. If you decide on this option, the buttons require a 22mm diameter hole and you do not need to order the separate button housing.

The quadruple button housing is for the buttons **Start**, **Stop**, **Man/Auto** und **Acknowledge**.

**Start** → CANopen Master Reset on Slave fault  
**Stop** → Error reset for ATV31 Devices after CANopen Initialisation.  
**Man/Auto** → Automatic Mode (white LED off) / Manual Mode (white LED blinks)  
**Acknowledge1** → **E-OFF button 1** and **E\_OFF button 2**

**Acknowledge button 2** → **Light curtain**

**Acknowledge button 3** → **Door switch**

All **Preventa modules** send Information to the **PLC**.

Manual mode provides 3 control buttons for all belts:

**Button 1** → reverse belt  
**Button 2** → stop belt  
**Button 3** → belt forwards

## Illuminated beacon

The **illuminated beacon** displays the various states. It consists of three indicator lamps.

The **green** lamp indicates **Run**. It is permanently lit when the plant is operating normally.

The **red** lamp indicates a **Fault**. The lamp flashes for **emergency-off/safety violations**; for other faults caused by logic- or component-related problems, the light should burn continuously.

The **yellow** lamp indicates Manual or HMI mode.

**Plant Example**  
**Conveyor belt system**

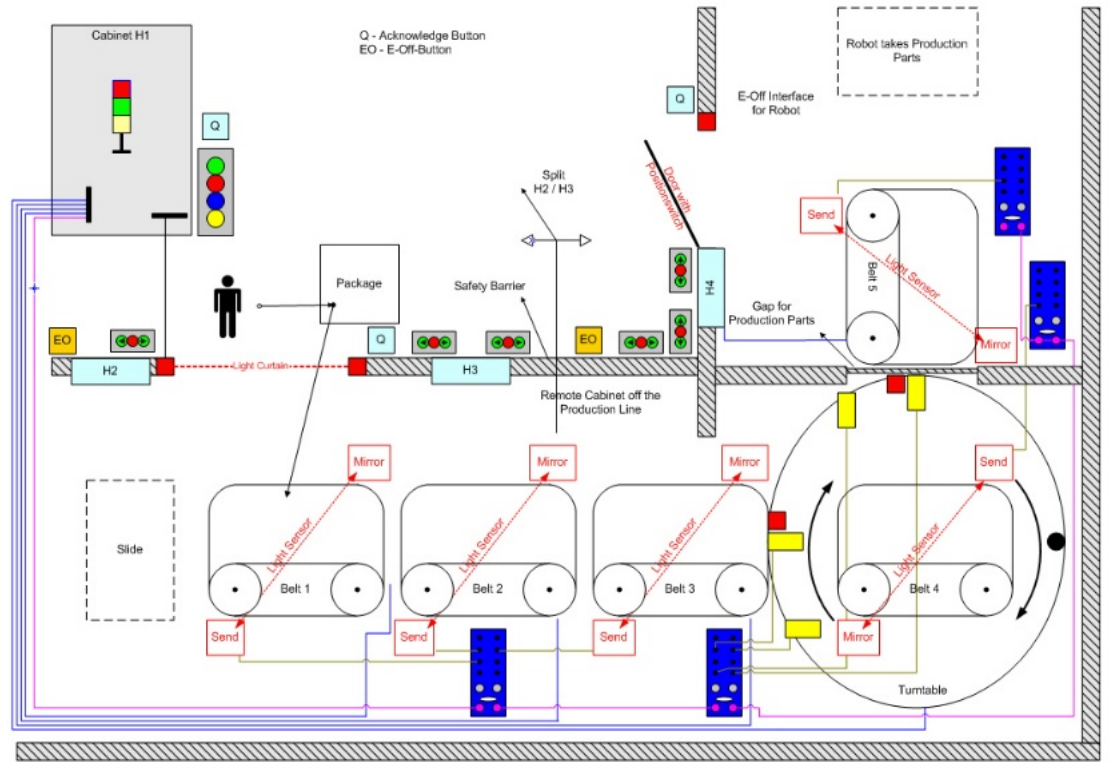

**CANopen**  
**Layout**

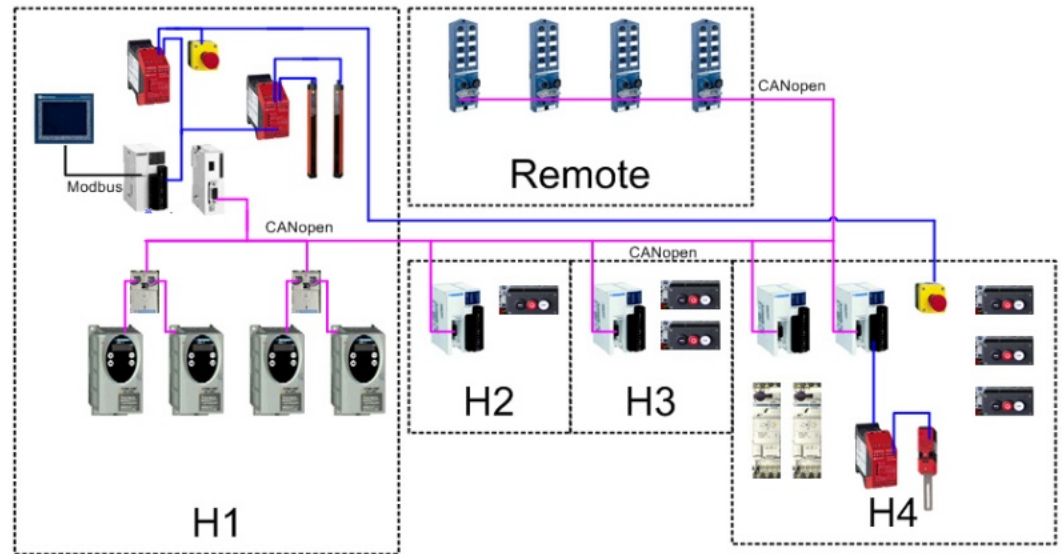

# Communication

## Introduction

This lists the individual points between which data is exchanged via the bus systems (e.g., CANopen, Modbus Plus or TCP/IP) that are not directly linked to digital or analog hardware interfaces.

This list contains:

- The devices concerned in each case
- The direction of transfer
- The symbolic name *and*
- The direct bus address on the device concerned.

## Device Links

The Modbus and CANopen bus systems are used in this application. The devices below are networked via **CANopen**:

- a Twido PLC, bus address 127 (fixed setting)
- four Altivar variable speed drives, bus addresses 1..4
- four FTBs, bus addresses 5..8
- four OTBs, bus addresses 9..12

Only two devices are interconnected via **Modbus**:

- Magelis-Panel XBT-G, bus address 1
- Twido PLC, bus address 2

## Datalink Drive\_1 <> PLC

Twido PLC (CANopen master, #127)		Altivar 31, Drive_1 (CANopen slave #1)	
<b>Data direction ATV -&gt; PLC</b>			
Address	Name	Index	Designation
%IWC1.0.0	D_STATUS_DRIVE_1	6041	Drivecom status register
%IWC1.0.1	D_CONTROL_DRIVE_1	6044	Control effort
%IWC1.0.2	D_IERROR_DRIVE_1	603F	Error Code
<b>Data direction PLC -&gt; ATV</b>			
Address	Name	Index	Designation
%QWC1.0.0	D_COMMAND_DRIVE_1	6040	Drivecom command register
%QWC1.0.1	D_TARGET_DRIVE_1	6042	Target velocity

## Datalink Drive\_2 <> PLC

Twido PLC (CANopen master, #127)		Altivar 31, Drive_2 (CANopen slave #2)	
<b>Data direction ATV -&gt; PLC</b>			
Address	Name	Index	Designation
%IWC1.1.0	D_STATUS_DRIVE_2	6041	Drivecom status register
%IWC1.1.1	D_CONTROL_DRIVE_2	6044	Control effort
%IWC1.1.2	D_IERROR_DRIVE_2	603F	Error Code
<b>Data direction PLC -&gt; ATV</b>			
Address	Name	Index	Designation
%QWC1.1.0	D_COMMAND_DRIVE_2	6040	Drivecom command register
%QWC1.1.1	D_TARGET_DRIVE_2	6042	Target velocity

Datalink  
Drive\_3 <> PLC

Twido PLC (CANopen master, #127)		Altivar 31, Drive_3 (CANopen slave #3)	
<b>Data direction ATV -&gt; PLC</b>			
Address	Name	Index	Designation
%IWC1.2.0	D_STATUS_DRIVE_3	6041	Drivecom status register
%IWC1.2.1	D_CONTROL_DRIVE_3	6044	Control effort
%IWC1.2.2	D_IERROR_DRIVE_3	603F	Error Code
<b>Data direction PLC -&gt; ATV</b>			
Address	Name	Index	Designation
%QWC1.2.0	D_COMMAND_DRIVE_3	6040	Drivecom command register
%QWC1.2.1	D_TARGET_DRIVE_3	6042	Target velocity

Datalink  
Drive\_4 <> PLC

Twido PLC (CANopen master, #127)		Altivar 31, Drive_1 (CANopen slave #4)	
<b>Data direction ATV -&gt; PLC</b>			
Address	Name	Index	Designation
%IWC1.3.0	D_STATUS_DRIVE_4	6041	Drivecom status register
%IWC1.3.1	D_CONTROL_DRIVE_4	6044	Control effort
%IWC1.3.2	D_IERROR_DRIVE_4	603F	Error Code
<b>Data direction PLC -&gt; ATV</b>			
Address	Name	Index	Designation
%QWC1.3.0	D_COMMAND_DRIVE_4	6040	Drivecom command register
%QWC1.3.1	D_TARGET_DRIVE_4	6042	Target velocity

Datalink  
FTB1 <> PLC

Twido PLC (CANopen master, #127)		FTB1 (CANopen slave #5)	
<b>Data direction FTB -&gt; PLC</b>			
Address	Name	Index	Designation
%IWC1.4.0	FTB_IN_1	6000	Digital Input 8 Bits
<b>Data direction PLC -&gt; FTB</b>			
Address	Name	Index	Designation
%QWC1.4.0	Test_FTb1	6200	Write Outputs 1 to 8

Datalink  
FTB2 <> PLC

Twido PLC (CANopen master, #127)		FTB2 (CANopen slave #6)	
<b>Data direction FTB -&gt; PLC</b>			
Address	Name	Index	Designation
%IWC1.5.0	FTB_IN_2	6000	Digital Input 8 Bits
<b>Data direction PLC -&gt; FTB</b>			
Address	Name	Index	Designation
%QWC1.5.0	Test_FTb2	6200	Write Outputs 1 to 8

Datalink  
FTB3 <> PLC

Twido PLC (CANopen master, #127)		FTB3 (CANopen slave #7)	
<b>Data direction FTB -&gt; PLC</b>			
Address	Name	Index	Designation
%IWC1.6.0	FTB_IN_3	6000	Digital Input 8 Bits
<b>Data direction PLC -&gt; FTB</b>			
Address	Name	Index	Designation
%QWC1.6.0	Test_FTb3	6200	Write Outputs 1 to 8

Datalink  
FTB4 ↔ PLC

Twido PLC (CANopen master, #127)		FTB4 (CANopen slave #8)	
<b>Data direction FTB -&gt; PLC</b>			
Address	Name	Index	Designation
%IWC1.7.0	FTB_IN_4	6000	Digital Input 8 Bits
<b>Data direction PLC -&gt; FTB</b>			
Address	Name	Index	Designation
%QWC1.7.0	Test_FTb4	6200	Write Outputs 1 to 8

Datalink  
OTB1 ↔ PLC

Twido PLC (CANopen master, #127)		OTB1 (CANopen slave #9)	
<b>Data direction OTB -&gt; PLC</b>			
Address	Name	Index	Designation
%IWC1.8.0	OTB1_IN_00_07	6000	Digital Input 0 to 7
%IWC1.8.1	OTB1_IN_08_11	6000	Digital Input 8 to 11
<b>Data direction PLC -&gt; OTB</b>			
Address	Name	Index	Designation
%QWC1.8.0	OTB1_OUT_00_07	6200	Write Outputs 0 to 7

Datalink  
OTB2 ↔ PLC

Twido PLC (CANopen master, #127)		OTB2 (CANopen slave #10)	
<b>Data direction OTB -&gt; PLC</b>			
Address	Name	Index	Designation
%IWC1.9.0	OTB2_IN_00_07	6000	Digital Input 0 to 7
%IWC1.9.1	OTB2_IN_08_11	6000	Digital Input 8 to 11
<b>Data direction PLC -&gt; OTB</b>			
Address	Name	Index	Designation
%QWC1.9.0	OTB2_OUT_00_07	6200	Write Outputs 0 to 7

Datalink  
OTB3 ↔ PLC

Twido PLC (CANopen master, #127)		OTB3 (CANopen slave #11)	
<b>Data direction OTB -&gt; PLC</b>			
Address	Name	Index	Designation
%IWC1.10.0	OTB3_IN_00_07	6000	Digital Input 0 to 7
%IWC1.10.1	OTB3_IN_08_11	6000	Digital Input 8 to 11
<b>Data direction PLC -&gt; OTB</b>			
Address	Name	Index	Designation
%QWC1.10.0	OTB3_OUT_00_07	6200	Write Outputs 0 to 7

Datalink  
OTB4 ↔ PLC

Twido PLC (CANopen master, #127)		OTB4 (CANopen slave #12)	
<b>Data direction OTB -&gt; PLC</b>			
Address	Name	Index	Designation
%IWC1.11.0	OTB4_IN_00_07	6000	Digital Input 0 to 7
%IWC1.11.1	OTB4_IN_08_11	6000	Digital Input 8 to 11
<b>Data direction PLC -&gt; OTB</b>			
Address	Name	Index	Designation
%QWC1.11.0	OTB4_OUT_00_07	6200	Write Outputs 0 to 7

Datalink  
HMI -> PLC

Twido PLC (Modbus #2)		HMI Magelis XBT-G (Modbus #1)	
Data direction HMI -> PLC			
Address	Name	Address	Designation
%M101	M_AUTO	%M102	Automatic mode
%M106	HMI_resetcanopen	%M106	Reset CANopen Master
%M107	HMI_resetaltivar	%M107	Reset Altivar31
%M121	M_HAND	%M122	Manual mode
%M131	M_HMI	%M131	HMI mode
%M200	Mhmi_D1_FWD	%M200	Drive 1 Forward HMI
%M201	Mhmi_D1_REV	%M201	Drive 1 Reverse HMI
%M202	Mhmi_D1_STOP	%M202	Drive 1 Stop HMI
%M205	Mhmi_D2_FWD	%M205	Drive 2 Forward HMI
%M206	Mhmi_D2_REV	%M206	Drive 2 Reverse HMI
%M207	Mhmi_D2_STOP	%M207	Drive 2 Stop HMI
%M210	Mhmi_D3_FWD	%M210	Drive 3 Forward HMI
%M211	Mhmi_D3_REV	%M211	Drive 3 Reverse HMI
%M212	Mhmi_D3_STOP	%M212	Drive 3 Stop HMI
%M215	Mhmi_D4_FWD	%M215	Drive 4 Forward HMI
%M216	Mhmi_D4_REV	%M216	Drive 4 Reverse HMI
%M217	Mhmi_D4_STOP	%M217	Drive 4 Stop HMI
%M220	Mhmi_D5_FWD	%M220	Drive 5 Forward HMI
%M221	Mhmi_D5_REV	%M221	Drive 5 Reverse HMI
%M222	Mhmi_D5_STOP	%M222	Drive 5 Stop HMI
%M225	Mhmi_D6_FWD	%M225	Drive 6 Forward HMI
%M226	Mhmi_D6_REV	%M226	Drive 6 Reverse HMI
%M227	Mhmi_D6_STOP	%M227	Drive 6 Stop HMI
%MW15	Manu_Velo_1	%MW15	Drive 1 Target Value
%MW16	Manu_Velo_2	%MW16	Drive 2 Target Value
%MW17	Manu_Velo_3	%MW17	Drive 3 Target Value
%MW18	Manu_Velo_4	%MW18	Drive 4 Target Value
%MW230	CAN_Failure_Slaves	%MW17	Failure bit for every Slave
%MW232	CAN_Failure_BUS	%MW18	Failure bit for the BUS

Datalink  
PLC -> HMI

Twido PLC (Modbus #2)		HMI Magelis XBT-G (Modbus #1)	
<i>Data direction PLC -&gt; HMI</i>			
Address	Name	Address	Designation
%M101	M_auto	%M101	Automatic Mode
%M102	HMI_estop1	%M102	E-off 1 pressed
%M103	HMI_lightcurtain	%M103	Light curtain active
%M104	HMI_door	%M104	Door Protection Triggered
%M105	HMI_estop2	%M105	E-off 2 pressed
%M140	M_no_error_drive1	%M140	Drive1 o.k.
%M141	M_no_error_drive2	%M141	Drive2 o.k.
%M142	M_no_error_drive3	%M140	Drive3 o.k.
%M143	M_no_error_drive4	%M140	Drive4 o.k.
%M144	M_no_error_drive5	%M140	Drive5 o.k.
%M145	M_no_error_drive6	%M140	Drive6 o.k.
%MW15	Manu_Velo_1	%MW15	Drive 1 Target Value
%MW16	Manu_Velo_2	%MW16	Drive 2 Target Value
%MW17	Manu_Velo_3	%MW17	Drive 3 Target Value
%MW18	Manu_Velo_4	%MW18	Drive 4 Target Value
%MW204	B1Actual	%MW204	Drive 1 Actual Value
%MW205	B2Actual	%MW205	Drive 2 Actual Value
%MW206	B3Actual	%MW206	Drive 3 Actual Value
%MW207	B4Actual	%MW207	Drive 4 Actual Value
%MW230	CAN_Failure_Slaves	%MW230	Failure bit for every Slave
%MW232	CAN_Failure_BUS	%MW232	Failure bit for the BUS



## General Addressing

<p>Various hardware addresses, as well as flags and flag words, are used in the PLC example program. To facilitate orientation, an overview of the addresses used appears below in list format.</p>		
Type	Address	Comment
Digital inputs	%Ir.m.x	Digital inputs are specified on a hardware basis: r indicates the rack number, m the slot and x the input number. Example: Emergency-off feedback %I0.3.0.
Digital outputs	%Qr.m.x	Digital outputs are specified on a hardware basis: r indicates the rack number, m the slot and x the output number. Example: Indicator lamp for manual mode %Q0.5.1.
Analog inputs	%IWr.m.c	Analog inputs are specified on a hardware basis: r indicates the rack number, m the slot and c the channel number. Example: Emergency-off feedback %IW0.3.0.
Analog outputs	%QWr.m.c	Analog outputs are specified on a hardware basis: r indicates the rack number, m the slot and c the channel number. Example: Emergency-off feedback %QW0.3.0.
CANopen inputs	%MW0 to %MW31	CANopen inputs are written to flag words; individual bits can be addressed via %MWi.x. Example: 2. ATV status word %MW2
CANopen outputs	%MW100 to %MW131	CANopen outputs are read by flag words; individual bits can be addressed via %MWi.x. Example: 3. ATV control word %MW104
Data for Viewer	%MW200 to %MW299	Data for Viewer is written to flag words. Individual bits are written via block BIT_TO_WORD. Example: Motor velocity %MW220
Data from Viewer	%MW300 to %MW399	Data from Viewer is read by flag words. Individual bits are extracted via block WORD_TO_BIT. Example: Motor velocity %MW220
CANopen status	%CHr.m.c	Status data for CANopen is read via data structure T_COM_CPP110 (IODDT). Channel address: r indicates the rack number, m the slot and c the channel number. Example: CANopen status %CH0.1.1

# HMI

## Introduction

This application features a Magelis XBT-GT1100 HMI device, which is connected to the PLC via Modbus protocol.

Vijeo Designer software is used to program and configure the terminal. The following pages describe how to create and upload a program.

Proceed as follows to integrate the HMI:

- Create a New Project
- Install the Correct Driver
- Configure the Programming Connection
- Configure the driver
- Linking Variables
- Create a Variable
- Import Project
- Creating Screens – examples
- Build the Project
- Download the Project

## Preconditions

In order to work with Vijeo Designer you must first:

- Install Vijeo-Designer V4.4 on your PC.
- check that the Magelis terminal is connected to a power supply and turned on
- Connect the Magelis terminal to the PC using the data cable **XBTZG925 (USB)**.

## Vijeo Designer Layout

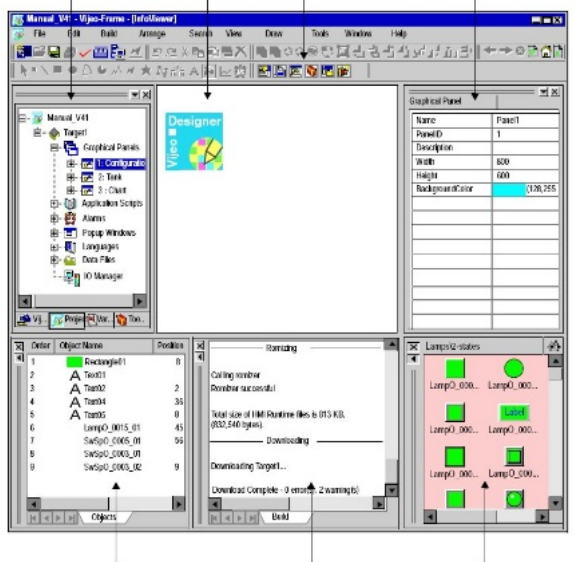
1	<p>The Vijeo Designer environment consists of the following elements:</p> <ol style="list-style-type: none"><li>1 - Navigator</li><li>2 - Info display</li><li>3 - Inspector</li><li>4 - Data list</li><li>5 - Feedback zone</li><li>6 - Toolbox</li></ol>	
---	--	--

## Create a new Project

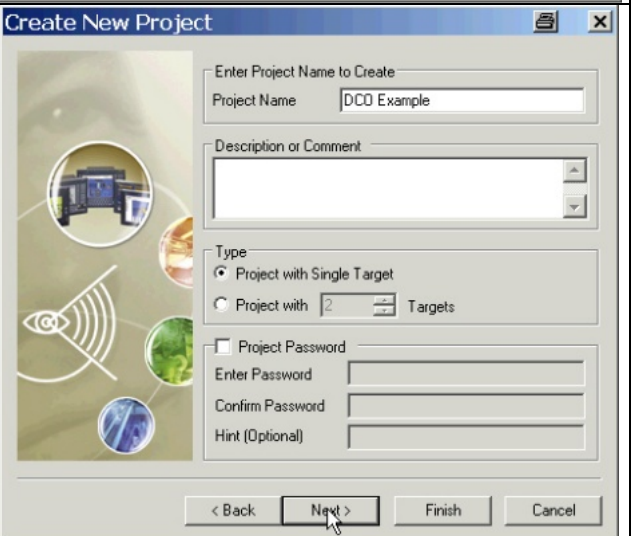
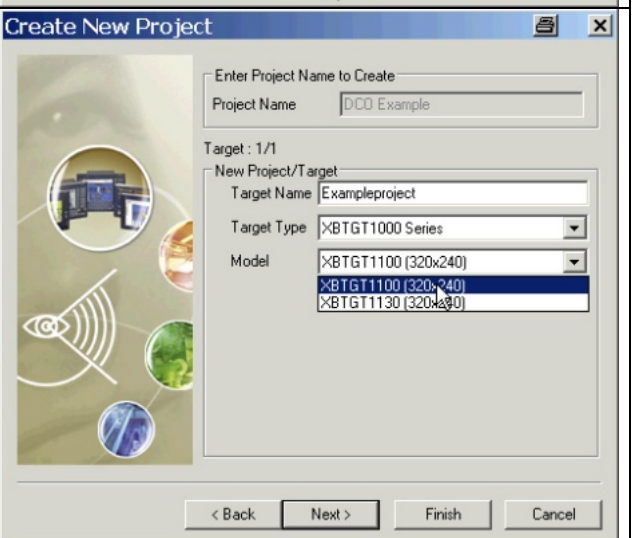
<p>1</p>	<p>Start up Vijeo Designer and select</p> <p><b>Create new Project.</b></p> <p>You will be automatically guided through the subsequent steps.</p> <p>continue with <b>Next&gt;</b>.</p>	
<p>2</p>	<p>Now enter the project name for the application, e.g., "DCO Example".</p> <p>A more detailed description can be added in the <b>Description or Comment</b> box.</p> <p>No accented characters or umlauts (ö, ü, ä, etc.) are permitted.</p> <p>Continue with <b>Next&gt;</b>.</p>	
<p>3</p>	<p>Select the target device to be used. Your <b>target name</b> can be any name you wish.</p> <p>Target Name: Exampleproject</p> <p>Target Type: <b>XBT-GT1000 Series</b></p> <p>XBTG Model: <b>XBT-GT1100</b></p> <p>Continue with <b>Next&gt;</b></p>	

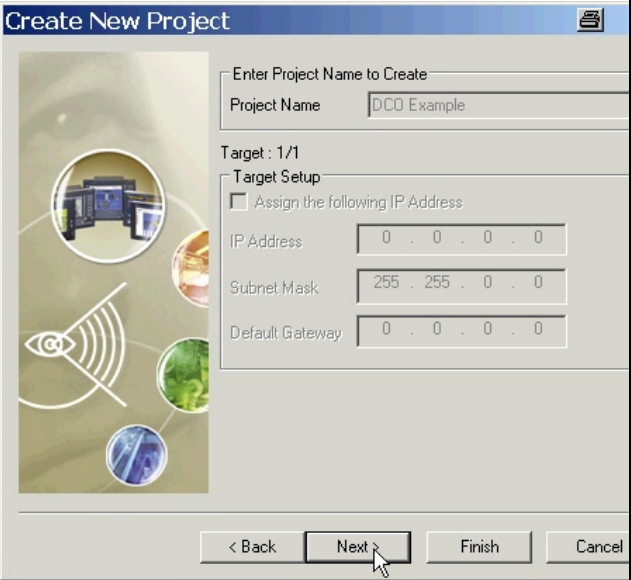
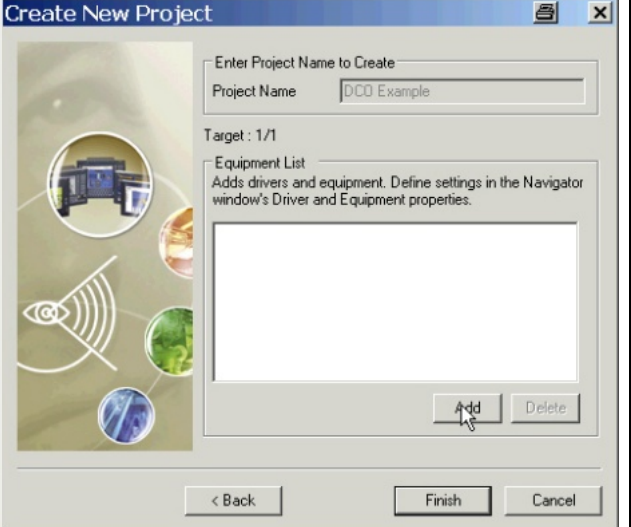
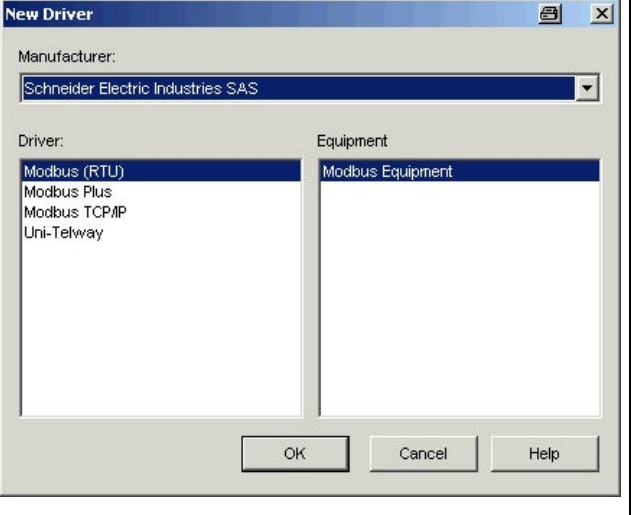
4	<p>The selected device has no Ethernet port, so you can go to the next screen using <b>Next&gt;</b>.</p>	
5	<p>In order to be able to exchange data with the PLC, the Magelis terminal requires a communication driver.</p> <p>In the <b>Create New Project</b> dialog, select:</p> <p><b>Add</b></p> <p>to go to the <b>New Driver</b> dialog.</p>	
6	<p>In the <b>New Driver</b> dialog select:</p> <p><b>Schneider Electric Industries SAS</b></p> <p>in the <b>manufacturer's</b> list.</p> <p>Now transfer the <b>Modbus (RTU)</b> driver to the <b>Equipment</b> list as <b>Modbus Equipment</b> for communication with the Twido PLC.</p> <p>Confirm the settings with <b>OK</b>.</p>	

**Install the correct driver**

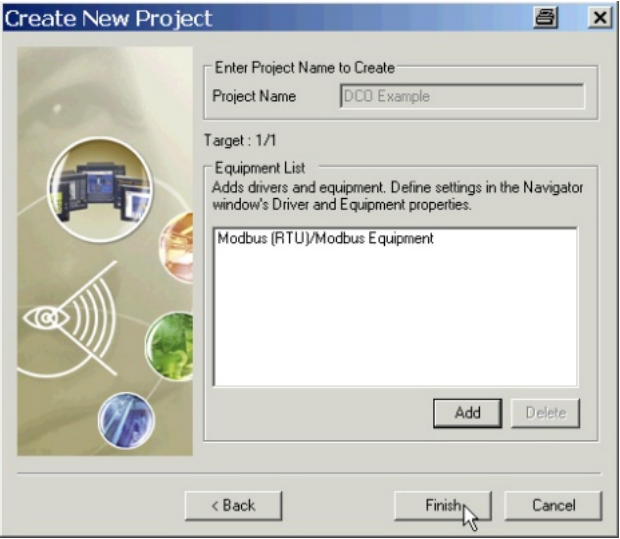
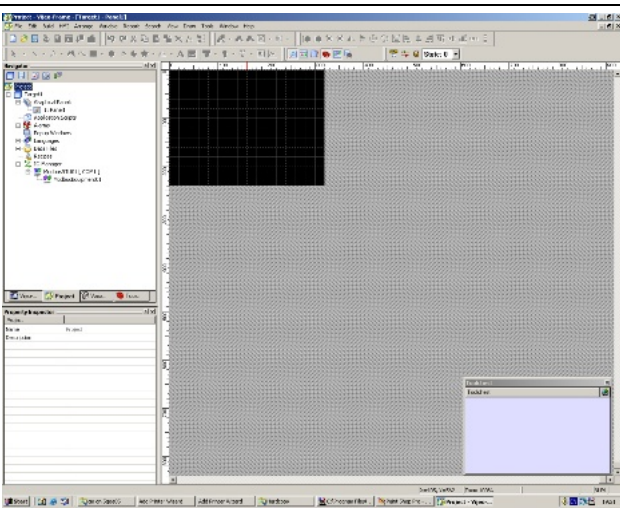
7	<p>Once you have added the driver, exit the driver configuration process with <b>Finish</b>.</p>	
8	<p>Vijeo Designer now returns you to its work top, with an empty display and the project navigator</p> <p>A single mouseclick on <b>Target1</b> in the <b>navigator</b> lists the properties of target1 in <b>properties inspector</b></p> <p>(or if the <b>properties inspector</b> is closed, a right mouseclick on Target1 and selecting <b>Properties</b> in the pop-up menu, opens up the <b>properties inspector</b>)</p>	

## Configure the Programming Connection

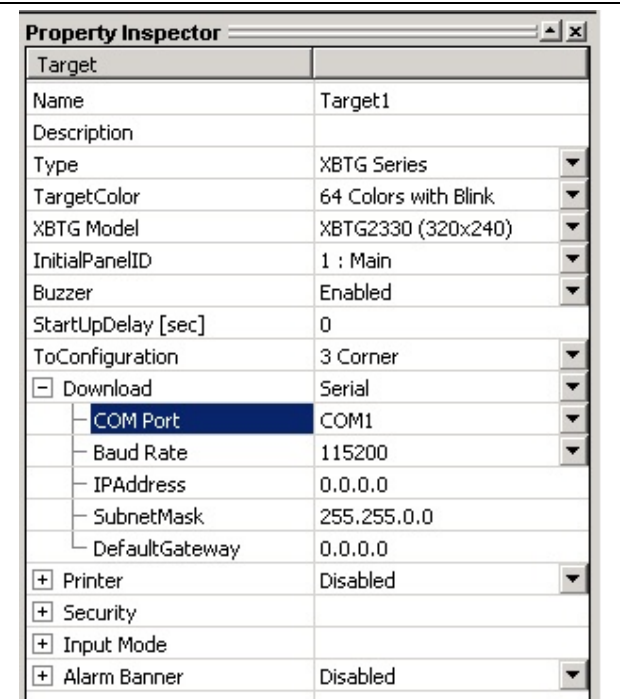
1	<p>First check the setup for the USB programming cable <b>XBTZG925</b>.</p> <p>Check the properties of the project and in particular the properties of the <b>COM port</b>. As default it is set to serial and <b>COM1</b>.</p> <p><b>As we are using a USB cable the connection must be changed.</b></p>	
---	---	--

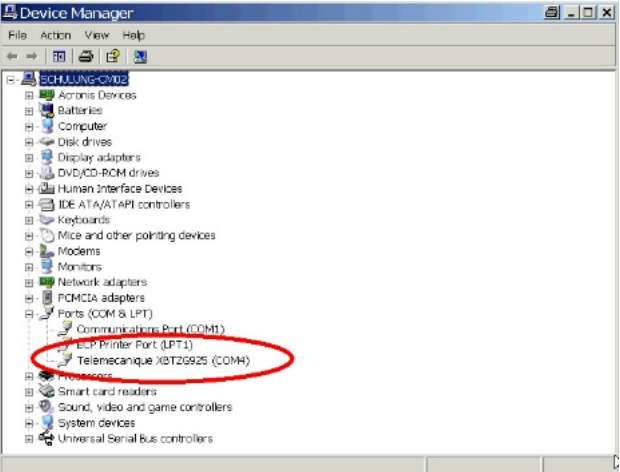
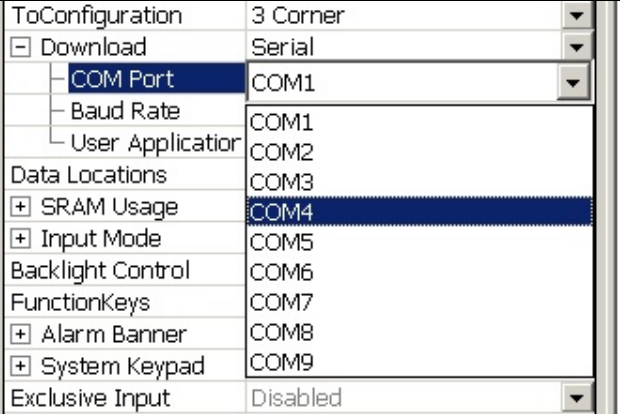
<p>2</p>	<p>First check in the <b>Windows Device Manager</b> which COM port is used for the USB connection.</p> <p>Here COM4 is used.</p>	
<p>3</p>	<p>In Vijeo Designer select the COM to match the Windows setup, in this case COM4, and input it as the <b>COM port</b>.</p> <p>Leave the connection type as it is, <b>Serial</b>.</p>	

### Configure the driver

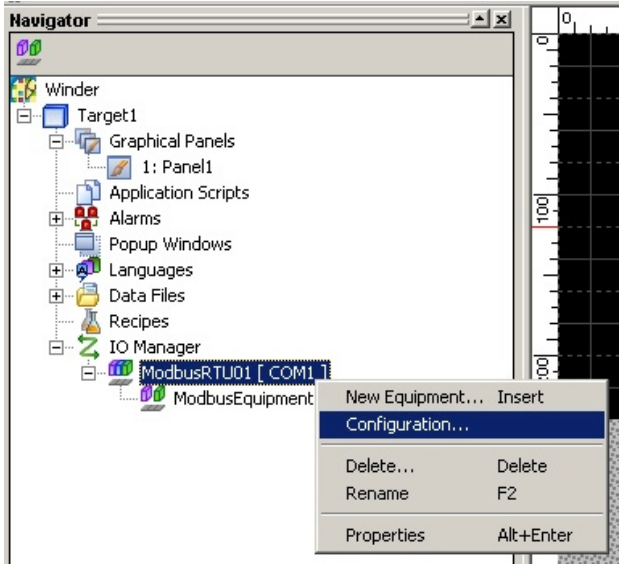
<p>1</p>	<p>For the communications to work you must set up the parameters in the Modbus RTU-Driver.</p> <p>For this, right mouseclick on <b>ModbusRTU01</b> in the <b>Navigator</b></p> <p>and select <b>Configuration...</b></p>	
----------	--	--

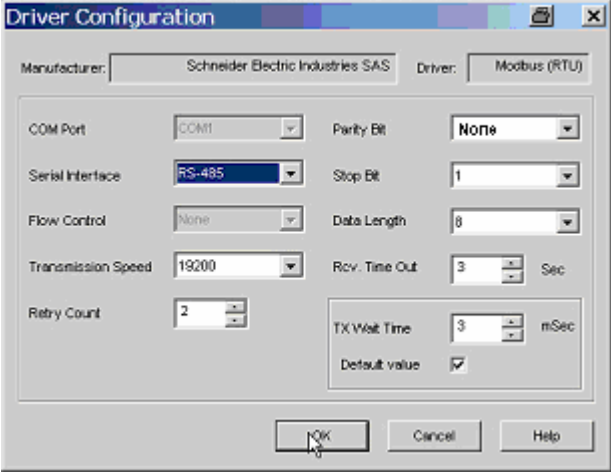
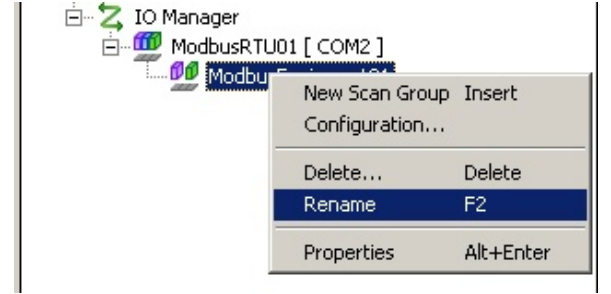
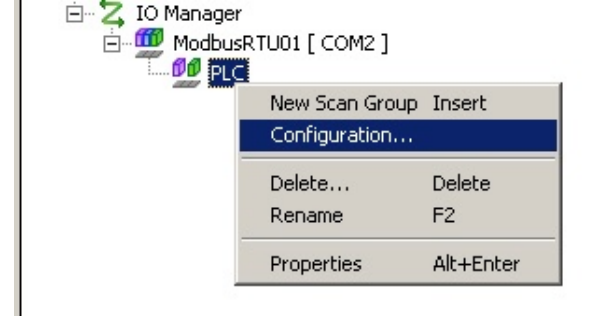
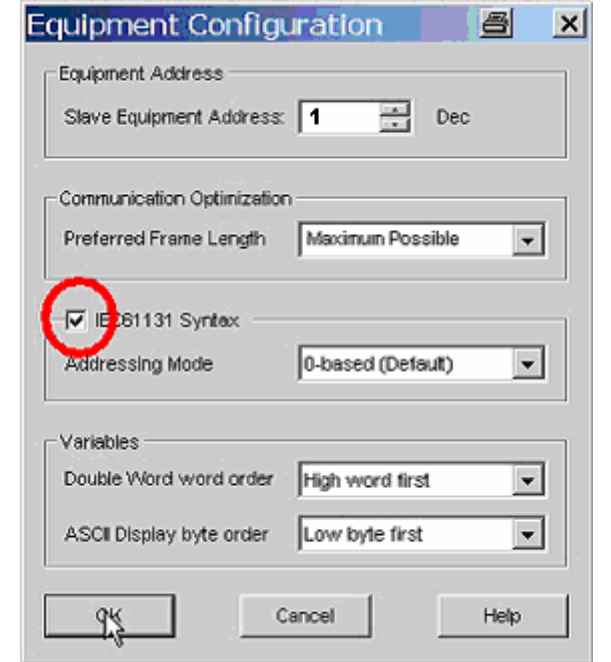

<p><b>2</b></p> <p>In the Driver Configuration dialog,</p> <p>input:</p> <ul style="list-style-type: none"> <li>- <b>19200 Baud</b></li> <li>- <b>8 Data bits</b></li> <li>- <b>1 Stop bit</b></li> <li>- <b>No Parity</b></li> </ul> <p>Note: The configuration must match the port definition on the Twido.</p> <p>Exit the dialog with <b>OK</b>.</p>		
<p><b>3</b></p> <p>In the Navigator you can rename the configuration to <b>PLC</b> with a right mouseclick on the name and selecting <b>Rename</b>.</p>		
<p><b>4</b></p> <p>Rightmouse click on <b>PLC</b> to go to the device configuration.</p> <p>In this configuration the HMI is slave, the PLC is master.</p>		
<p><b>5</b></p> <p>In the Equipment Configuration dialog set the Slave Equipment Address to <b>2</b>. and set the checkbox for <b>IEC61131 Syntax</b></p> <p>you can leave the other inputs at their default values.</p> <p>Exit with <b>OK</b>.</p>		

6	<p>Acknowledge the confirmation for the <b>IEC61131 Syntax</b> with <b>YES</b>.</p>	
---	---	--

## Linking Variables

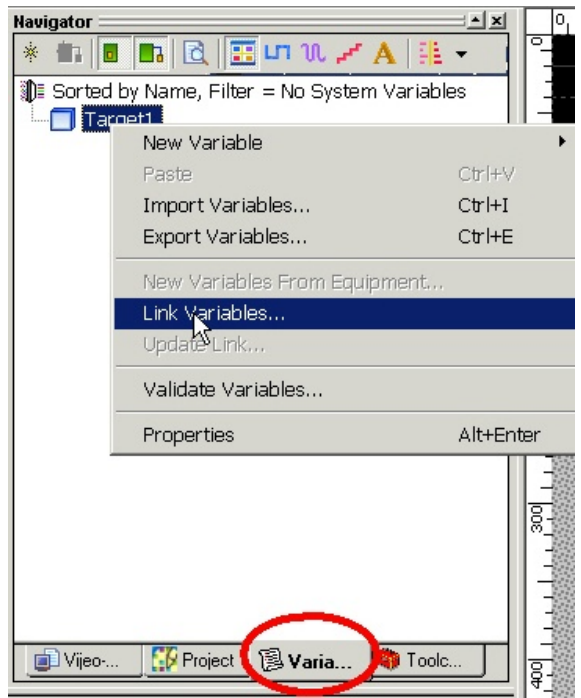
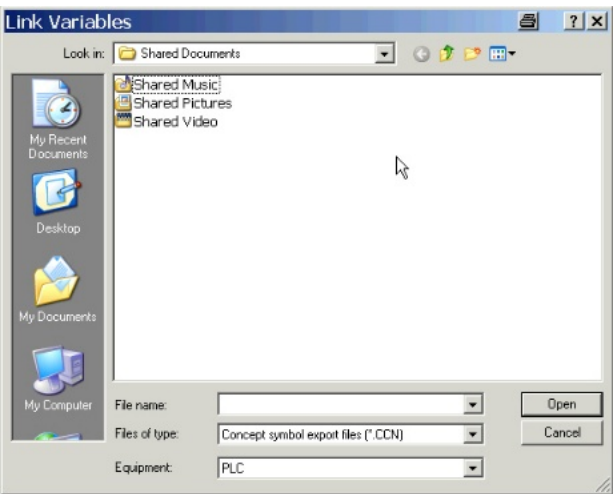
1	<p>As the variables have already been input in TwidoSuite (or some other Schneider product) . Vijeo-Designer offers an option to link up to these variables.</p> <p>Select the <b>Variables</b> tab in the the <b>Navigator</b>.</p> <p>Right mouse click on the project name (here TARGET1) and select</p> <p><b>Link Variables...</b></p> <p>in the pop-up menu</p>	
2	<p>In the <b>Link Variables</b> window give the path to the file, the type of file and the <b>Equipment</b> type (here as named above PLC)</p> <p>Select the file and click on <b>Open</b>.</p>	



3 In this example the path was set to the TwidoSoft directory, the file type set to TwidoSoft and the **Equipment** set to PLC.

Then a Twido file (\*.twd) was selected and opened.

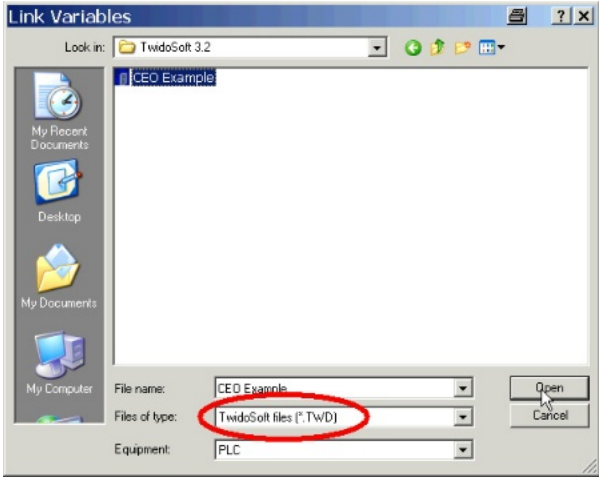

4 Once the file was successfully opened you will be offered a selection list of the available variables

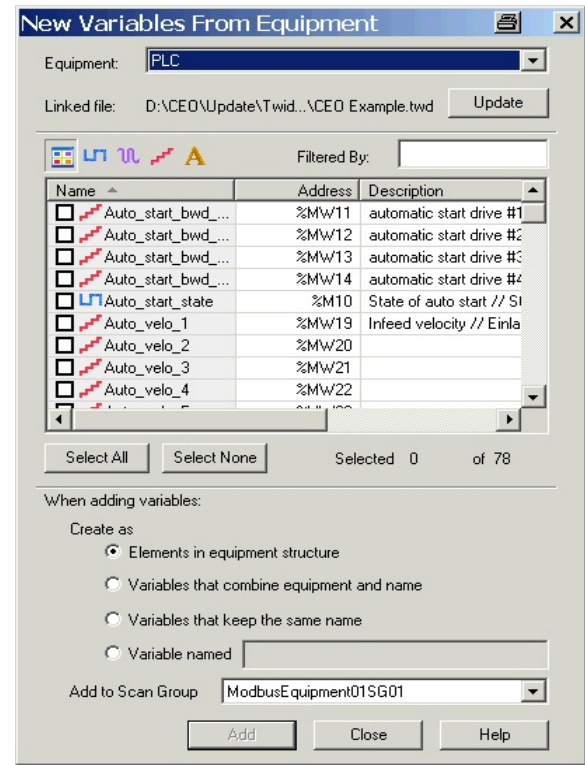

5 Mark the variables you wish to link to and click on **Add**.

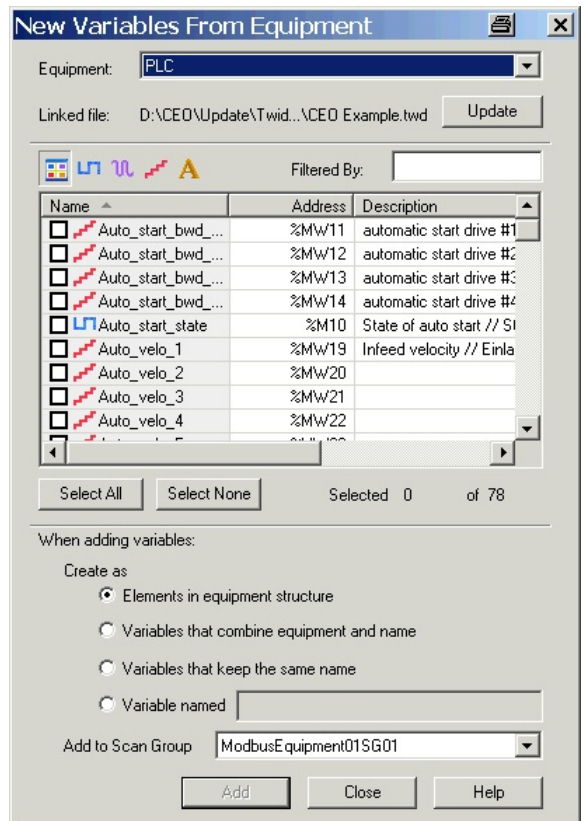

6 Linked variables are now deactivated with grey text.

If you have finished linking the variables you require, exit the dialog with a click on **Close**.

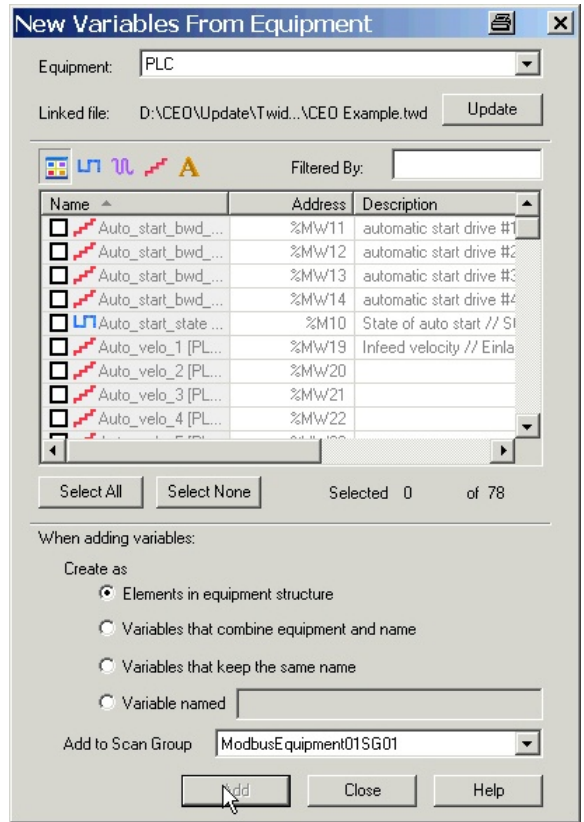

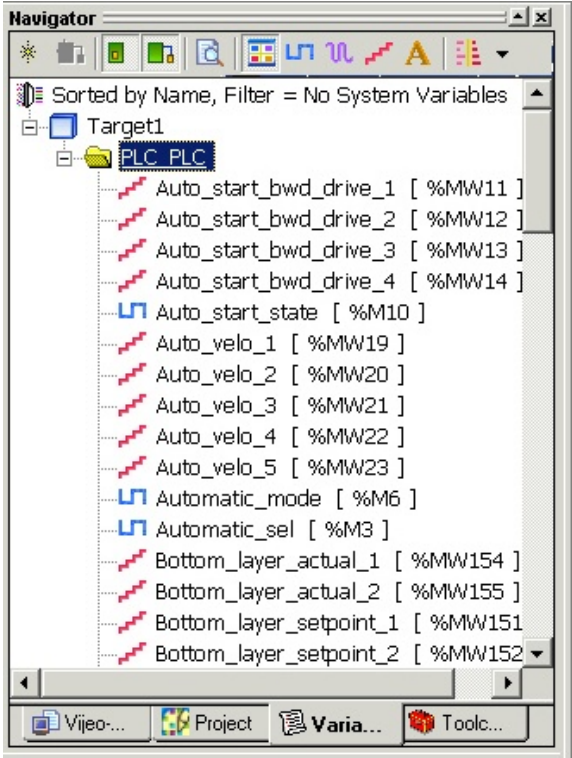
7	<p>All variables can now be viewed in the <b>navigator</b> on the <b>Variables</b> tab.</p>	
---	---	--

## Creating a variable

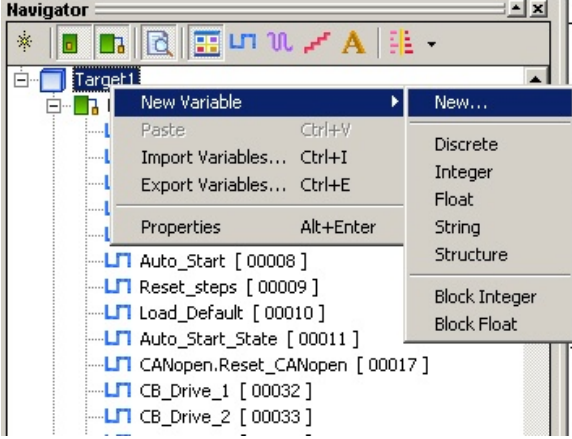
1	<p>To create variables, click on the Tab <b>Variable</b> in the navigator.</p> <p>A right mouse click on <b>Target1</b> opens up the pop-up menu Click on :</p> <p><b>New Variable -&gt; New...</b></p> <p>followed by the <b>datatype</b> required to go to variable definition dialog.</p>	
---	--	--

2 To create a variable you must input a:

- **Variable name**
- **Data type**
- **Data Source (External)**
- **Address in the PLC**

In the variable properties dialog you can enter the name and a description for the variable

Important here is what device delivers the value if it comes from an external system.

If this is the case you must enter a **ScanGroup** and a **Device Address**.

The device address is not the hardware address. It is the memory address in the device that delivers the value.

To select a device address click on the button at the right end of the list box.

Device Address:

Here you can address bits (%M..), memory words (%MW..) in the PLC.

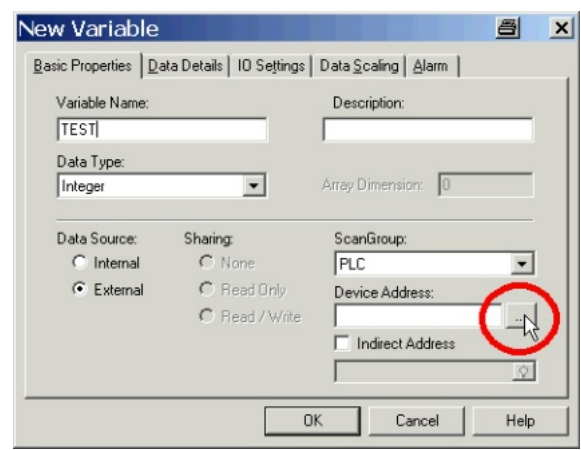

3 clicking on the **Device Address** opens up a dialog for the input of the address.

PLC internal formats such as counters must first be transferred to memory words before the Magelis can display them.

Integers and Reals :  
 30001 + i and  
 40001 + l

Discretes:  
 00001 + i and  
 10001 + i and  
 30001 + i, j and  
 40001 + i, j

where „i“ represents the bit number or word number i.e. you address them with the appropriate offset.

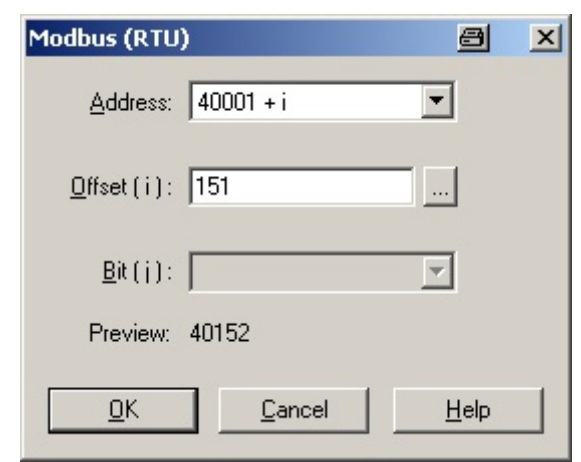

4

Examples:

PLC %M106  
HMI 00001 + 106  
=> 00107

PLC %MW207  
HMI 40001 + 207  
=> 40208

PLC %MW100 Bit5  
HMI 40001 + 100, 5  
⇒ 40101,05

The image shows the variable **Test** with its attributes listed in the **Property Inspector**.

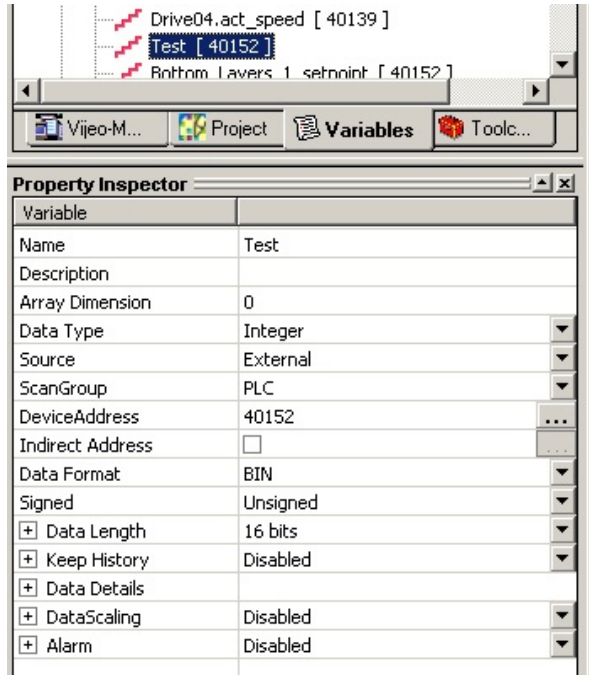

The screenshot shows the 'Property Inspector' window for a variable named 'Test'. The variable is located at address 40152. The table below lists its properties:

Variable	
Name	Test
Description	
Array Dimension	0
Data Type	Integer
Source	External
ScanGroup	PLC
DeviceAddress	40152
Indirect Address	<input type="checkbox"/>
Data Format	BIN
Signed	Unsigned
+ Data Length	16 bits
+ Keep History	Disabled
+ Data Details	
+ DataScaling	Disabled
+ Alarm	Disabled

## Import Project

1



To import a project select the **Vijeo-Manager** tab in the Navigator. Right mouse click on **Vijeo-Manager** in the tab window opens a pop-up menu.

select **Import Project..**

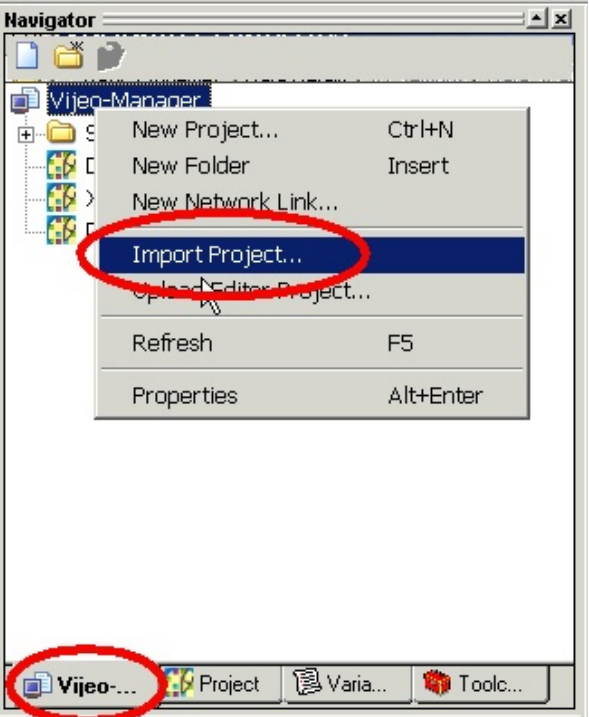
If the function is de-activated (greyed) close any open projects first and re-try.

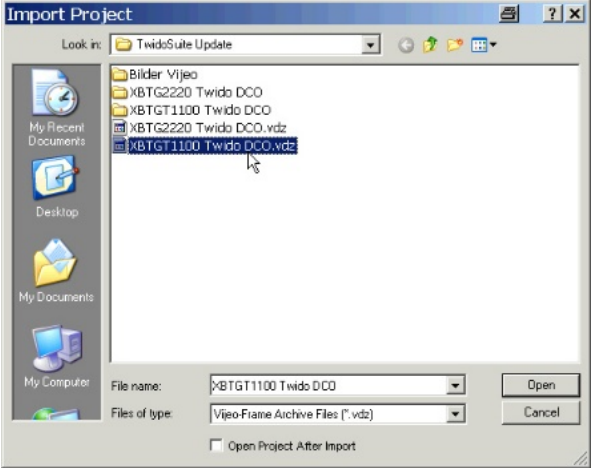

The screenshot shows the 'Navigator' window with a right-click context menu open over the 'Vijeo-Manager' tab. The 'Import Project...' option is highlighted with a red circle. The menu also includes options like 'New Project...', 'New Folder', 'New Network Link...', 'Upload Editor Project...', 'Refresh', and 'Properties'. The 'Vijeo-Manager' tab icon in the bottom toolbar is also circled in red.

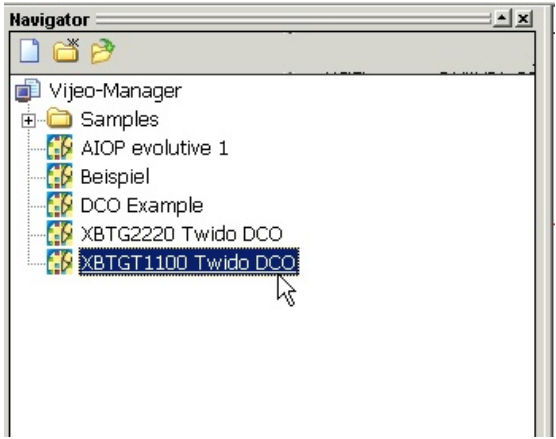
<p><b>2</b></p>	<p>Enter the path to search in, the file type (*.VDZ) and select a project file from the list offered.</p> <p>Import the project by clicking on <b>Open</b>.</p>	
<p><b>3</b></p>	<p>When the import is finished, acknowledge with <b>OK</b>.</p>	
<p><b>4</b></p>	<p>In the <b>Navigator</b> you can now see the project listed. Double click on it to open it.</p>	

**Creating Screens Examples**

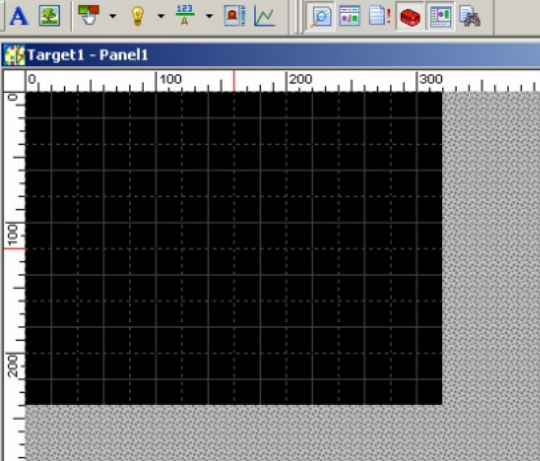
<p><b>1</b></p>	<p>Example: Insert Text</p> <p>Select the text tool in the tool bar.</p> <p>The toolbar displays the toolbox with tools for editing the display.</p>	
-----------------	--	--

**2** Example: Create Text

With the text tool, position the text box on the display. You can adjust its size by „pulling“ on the box or by giving a value in the text editor dialog.

Double click on the text box to open up the **text editor** dialog you can input the text to be displayed and define its size, font, etc.

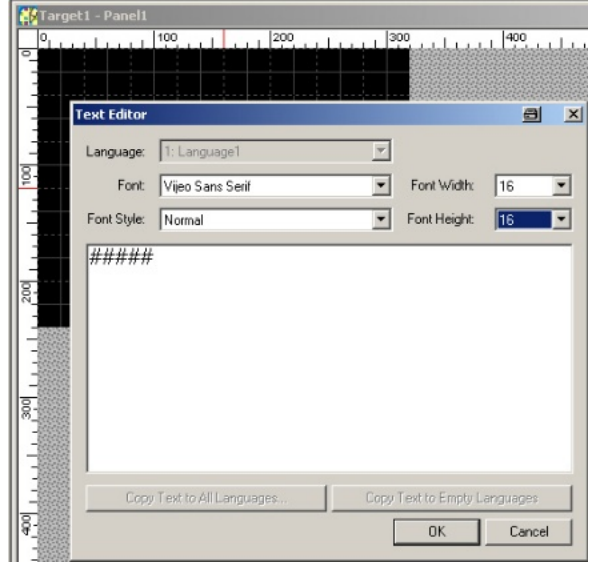

**3** After inputting the text you can define/change the text characteristics in the **Property Inspector**

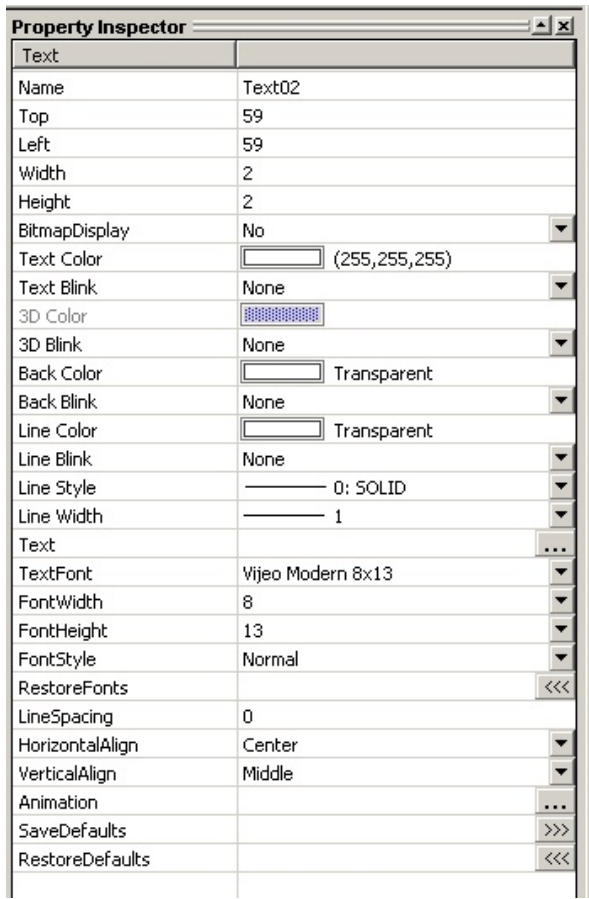



4 A right mouse click on the text object in the display leads to the **animation**.

This is the same animation as seen in the property inspector (see image above) but in another format. Both formats contain the same attributes.

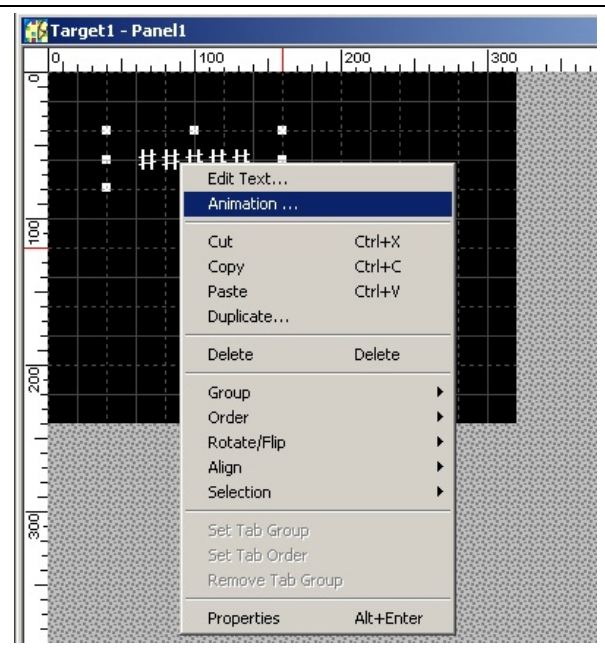

5 Animation Properties:

- Colour
- Position
- Value
- Visibility

For the variable used to animate this object, you can either manually input the variable or click on the lightbulb icon to browse the variable list and select a variable.

If you input an unknown variable it is shown in red – the variable has yet to be defined

Once activated variables can be selected and their display format defined.

If the value requires further processing before use, such as trigonometric functions, you can select these via the calculator icon.

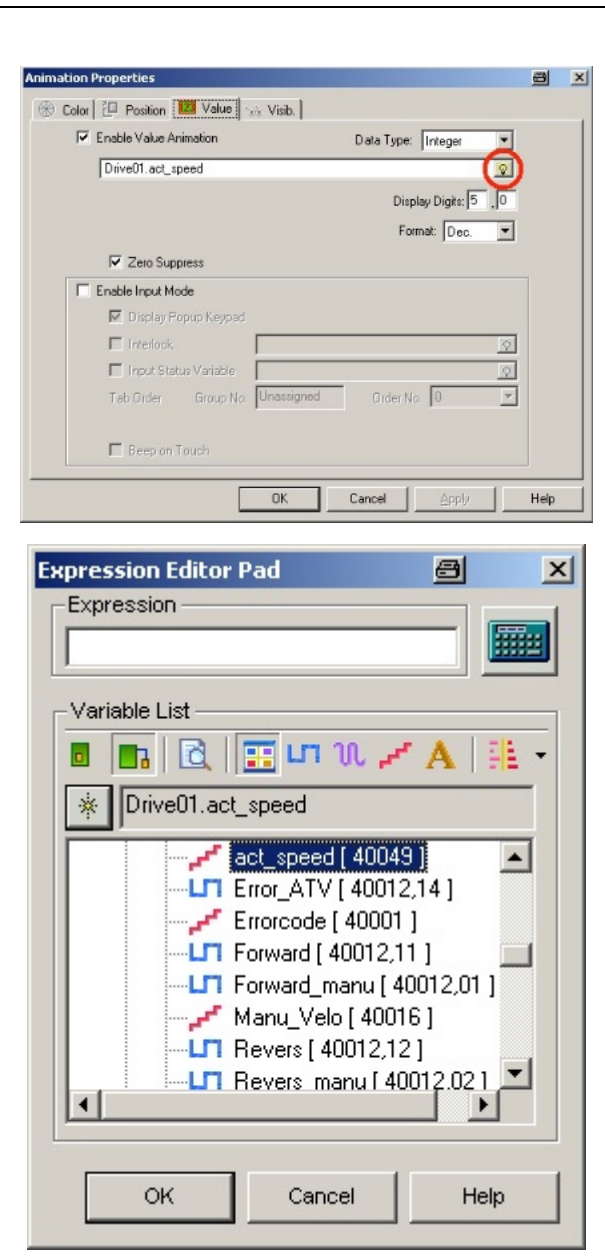

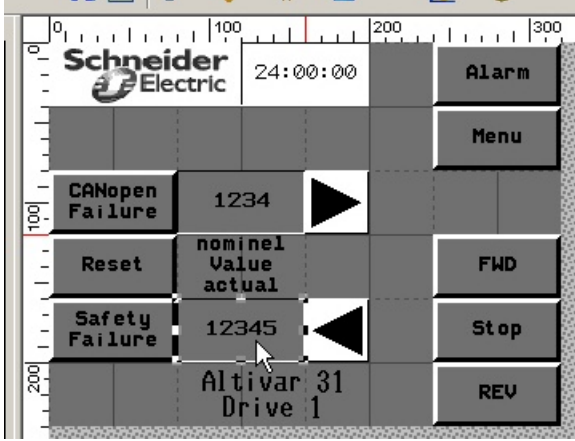

6	Text and Graphics examples.	
7	This picture shows one the finished configuration screens with some animations and buttons	

## Build the project

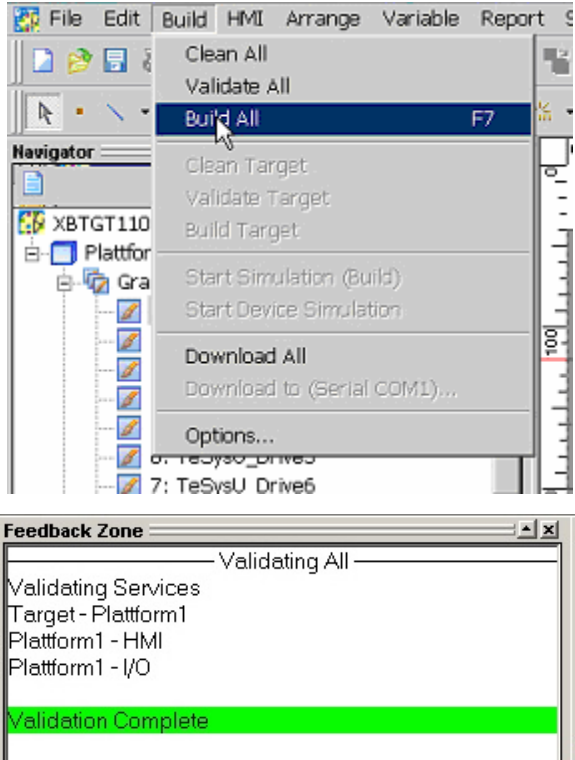
1	<p>Before you download the project to the Magelis you must validate it.</p> <p>With <b>Validate All</b> you can analyse your project.</p> <p>The <b>Feedback Zone</b> shows you the results of the analysis.</p> <p>You can invoke the project analysis using <b>Build All</b> too.</p>	
---	---	--

## Download the Project

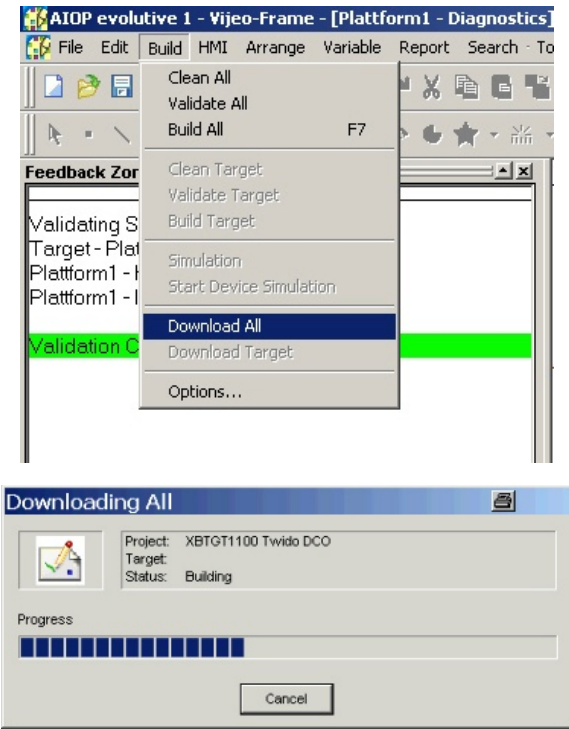
1	<p>Before you can download the project you must <b>build the project</b> (see the section above)</p> <p>Downloading the project to the Magelis (HMI):</p> <p>Select the project in the <b>Navigator</b>.</p> <p>Use <b>Build-&gt;Download All</b> to transfer the project to the HMI device.</p> <p>The transfer is done using the configured protocol (modbus in this case).</p> <p>The download process is indicated with a progress bar.</p>	 <p>The screenshot shows the software interface with the 'Build' menu open. The 'Download All' option is highlighted in blue. Below the menu, a 'Downloading All' dialog box is visible, showing the project name 'XBTGT1100 Twido DCO', the target 'Platform1 - i', and the status 'Building'. A progress bar is shown with several blue segments, and a 'Cancel' button is at the bottom.</p>
---	---	---

---

# PLC

---

## Introduction

The PLC chapter describes how to initialize, parameterize and load the program to the PLC in order to implement the functional description described above.

The PLC program is created using TwidoSuite.

## Pre-conditions

Before carrying out the steps described below, you must ensure the following:

- The TwidoSuite programming tool is installed on your PC
- The TwidoSuite example project is available
- The Twido PLC is switched on and supplied with power
- The PLC is connected to the PC with programming cable (TSXPCX1031)

## Starting Twidosuite

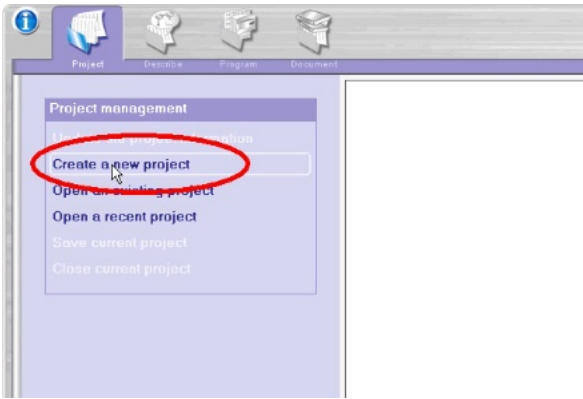
<p><b>1</b></p>	<p>To start work with Twidosuite, click on:</p> <p><b>Programming Mode</b></p> <p>Use the language selection buttons to set the language for this session.</p>	
<p><b>2</b></p>	<p>The start up screen for the main menu is displayed.</p> <p>With</p> <p><b>Create a new project</b></p> <p>you can start a new project.</p>	

## Create a new Project

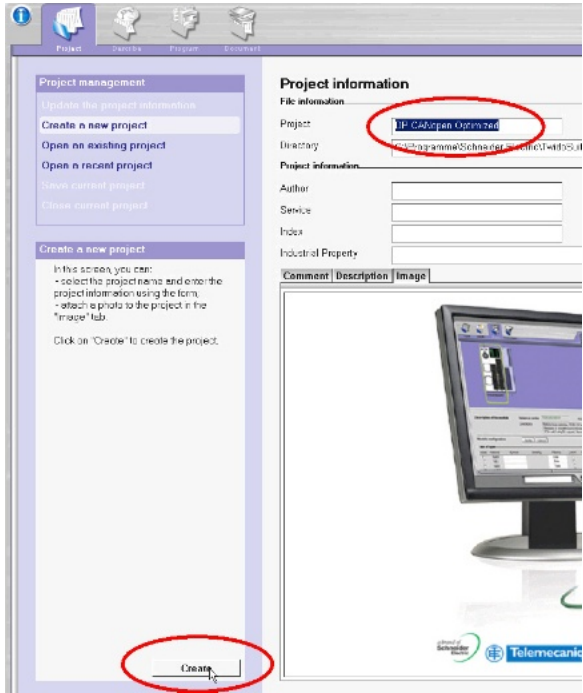
<p>1</p>	<p>Once <b>Create a new Project</b> is selected, enter a <b>Project</b> name and select the <b>Directory</b> path to save it.</p> <p>You can enter <b>Project Information</b> if required but it is not mandatory.</p> <p>Confirm with <b>Create</b>.</p>	
----------	---	--

## Select the Hardware

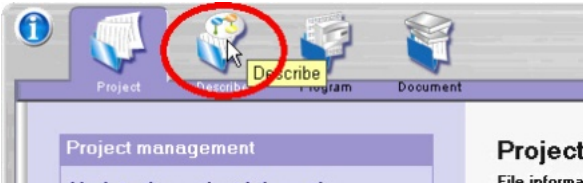
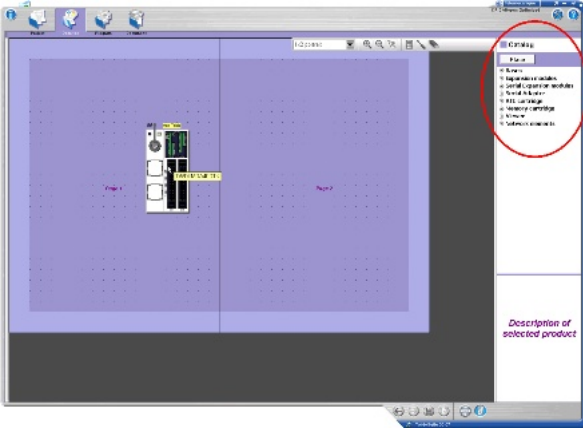
<p>1</p>	<p>Now go to <b>Describe</b> to configure the hardware.</p>	
<p>2</p>	<p>In the configuration <b>Workspace</b> you will see a Twido PLC.</p> <p>In the Catalog on the RHS you can select the hardware/modules you wish to configure</p> <p>The Workspace offers you graphical documentation.</p>	

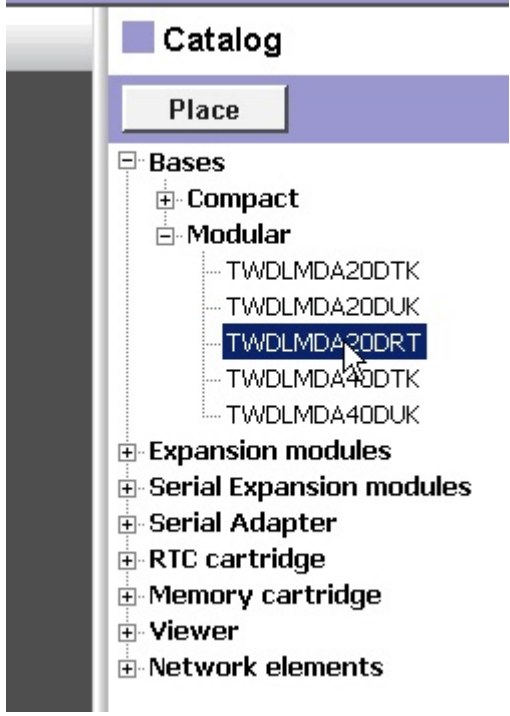
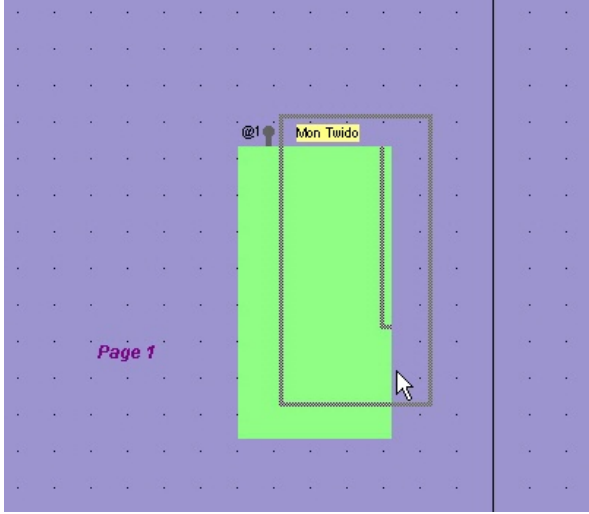
<p><b>3</b></p> <p>In the <b>Catalog</b>, first select the correct type of Twido</p> <p><b>TWDLMDA20DRT.</b></p>	
<p><b>4</b></p> <p>Use Drag&amp;Drop to drag the selection to the graphical image of the Twido.</p> <p>The graphical image will change to green.</p> <p>Drop the selected Twido while the mouse icon is in the green field.</p>	

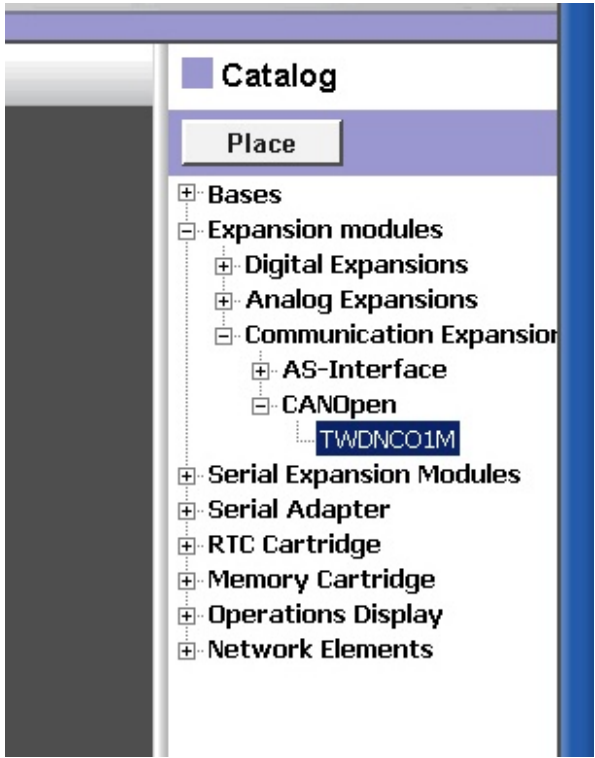
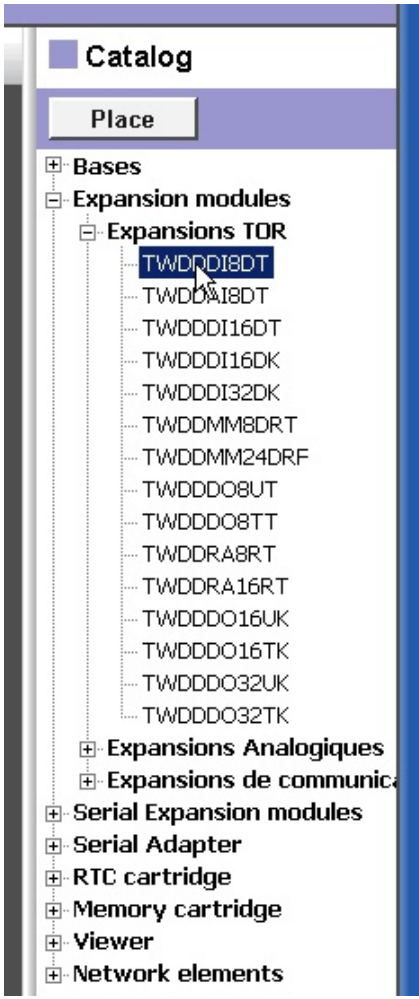
<p><b>5</b></p> <p>As next module select the CANopen Master</p> <p><b>TWDNCO1M.</b></p> <p>Use Drag&amp;Drop to place it to the right of the Twido PLC in the graphical image.</p>	 <p>The screenshot shows a software catalog window titled 'Catalog' with a 'Place' button. The tree structure is as follows:</p> <ul style="list-style-type: none"> <li>[-] Bases</li> <li>[-] Expansion modules       <ul style="list-style-type: none"> <li>[-] Digital Expansions</li> <li>[-] Analog Expansions</li> <li>[-] Communication Expansion           <ul style="list-style-type: none"> <li>[-] AS-Interface</li> <li>[-] CANOpen               <ul style="list-style-type: none"> <li><b>TWDNCO1M</b></li> </ul> </li> </ul> </li> <li>[-] Serial Expansion Modules</li> <li>[-] Serial Adapter</li> <li>[-] RTC Cartridge</li> <li>[-] Memory Cartridge</li> <li>[-] Operations Display</li> <li>[-] Network Elements</li> </ul> </li> </ul>
<p><b>6</b></p> <p>Now add the extra digital inputs module</p> <p><b>TWDDDI18DT</b></p> <p>Again, using drag&amp;drop place it next to the CANopen Master.</p>	 <p>The screenshot shows the same software catalog window. The tree structure is as follows:</p> <ul style="list-style-type: none"> <li>[-] Bases</li> <li>[-] Expansion modules       <ul style="list-style-type: none"> <li>[-] Expansions TOR           <ul style="list-style-type: none"> <li><b>TWDDDI18DT</b></li> <li>TWDDDI18DT</li> <li>TWDDDI16DT</li> <li>TWDDDI16DK</li> <li>TWDDDI32DK</li> <li>TWDDMM8DRT</li> <li>TWDDMM24DRF</li> <li>TWDDDO8UT</li> <li>TWDDDO8TT</li> <li>TWDDRA8RT</li> <li>TWDDRA16RT</li> <li>TWDDDO16UK</li> <li>TWDDDO16TK</li> <li>TWDDDO32UK</li> <li>TWDDDO32TK</li> </ul> </li> <li>[-] Expansions Analogiques</li> <li>[-] Expansions de communication</li> <li>[-] Serial Expansion modules</li> <li>[-] Serial Adapter</li> <li>[-] RTC cartridge</li> <li>[-] Memory cartridge</li> <li>[-] Viewer</li> <li>[-] Network elements</li> </ul> </li> </ul>

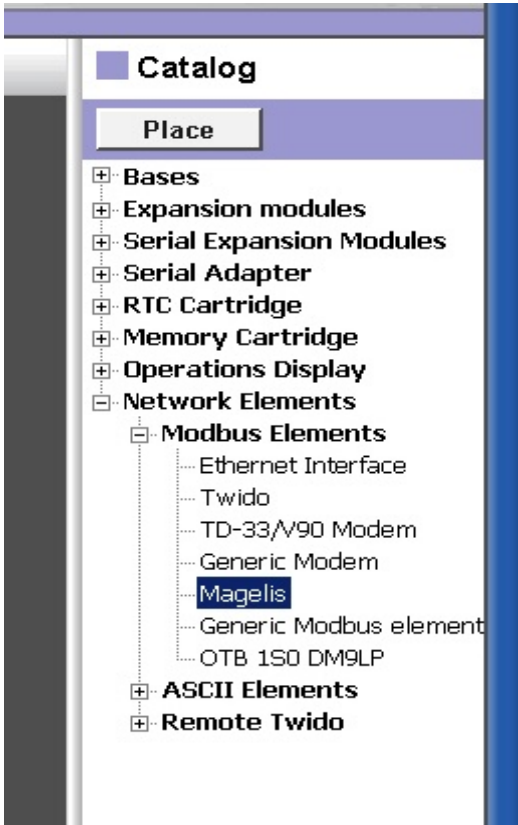
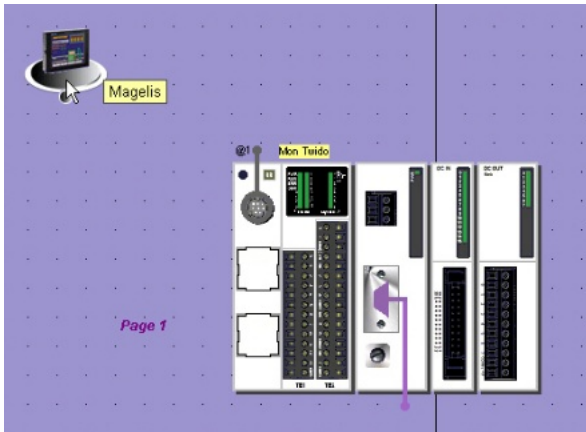
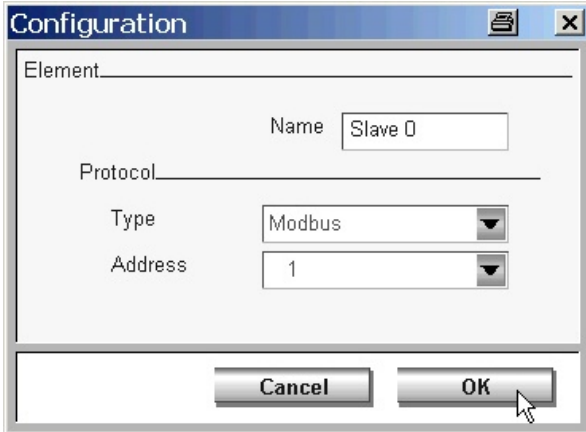
<p>7</p> <p>Now add the Magelis Terminal</p> <p><b>XBTGT1100</b></p> <p>For this add the general Magelis Modbus element to the configuration.</p>		 <p>The screenshot shows a software interface titled 'Catalog'. Under a 'Place' button, there is a tree view of components. The 'Modbus Elements' folder is expanded, showing sub-items: Ethernet Interface, Twido, TD-33/V90 Modem, Generic Modem, <b>Magelis</b> (highlighted), Generic Modbus element, and OTB 1SO DM9LP. Other folders include Bases, Expansion modules, Serial Expansion Modules, Serial Adapter, RTC Cartridge, Memory Cartridge, Operations Display, ASCII Elements, and Remote Twido.</p>
<p>8</p> <p>The Workspace now shows a graphic display of the configured modules/devices.</p> <p>The connection HMI/PLC, via the Modbus interface, has still to be done.</p>		 <p>The screenshot shows a workspace with a grid background. A rack of modules is visible, including a 'Modbus Twido' module. A 'Magelis' icon is placed on the rack. The text 'Page 1' is visible in the bottom left corner.</p>
<p>9</p> <p>To configure the HMI connection, move the mouse icon over the HMI until the mouse icon changes to a <b>screwdriver</b>. Now a doubleclick opens up the <b>configuration</b> dialog.</p> <p>Give the device a <b>Name</b> and check that the default Protocol <b>Modbus</b> at <b>Address 1</b> is offered.</p> <p>Confirm with <b>OK</b>.</p>		 <p>The screenshot shows a 'Configuration' dialog box with the following fields: 'Element' (empty), 'Name' (Slave 0), 'Protocol' (Modbus), and 'Address' (1). There are 'Cancel' and 'OK' buttons at the bottom.</p>

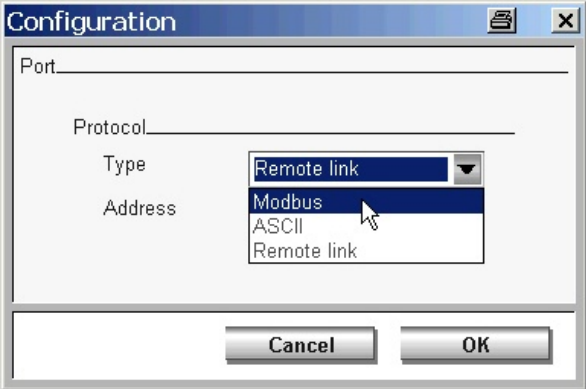
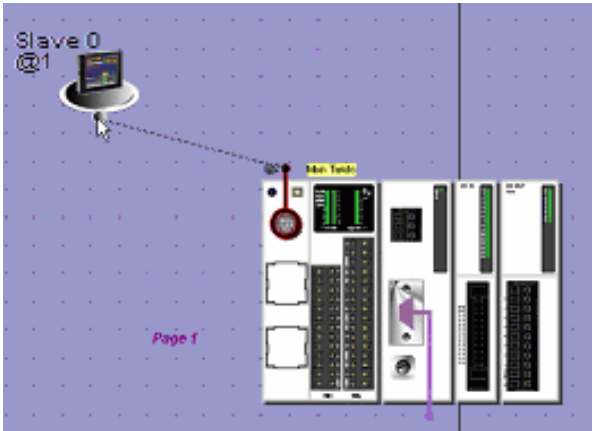
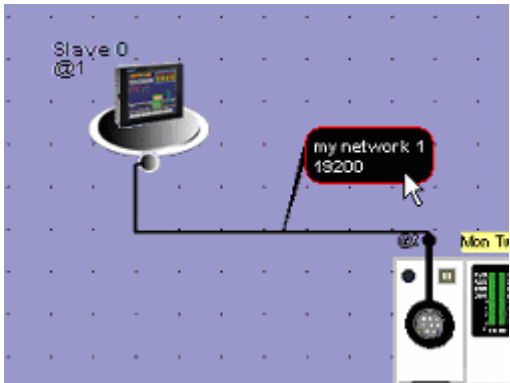
<p><b>10</b></p>	<p>Name and Modbus address now appear in the graphic display next to the HMI device.</p>	
<p><b>11</b></p>	<p>Now do the same for the PLC modbus interface. Position the mouse icon on the modbus interface of the PLC. When the mouse icon changes to a screwdriver, doubleclick to open up the configuration dialog.</p> <p>Change the Protocol type to <b>Modbus</b> and set the <b>Address</b> to <b>2</b>.</p> <p>Confirm with <b>OK</b>.</p>	
<p><b>12</b></p>	<p>Now connect the two devices in the graphics display by linking the white crosses that represent the linking points.</p> <p>To do this click on the white cross of one device and then the next so that the link is displayed.</p>	
<p><b>13</b></p>	<p>After linking the devices you can give the <b>network</b> a <b>name</b> and set the baud rate by double clicking on the connecting line or the network box.</p> <p>In this case we use the default values.</p>	

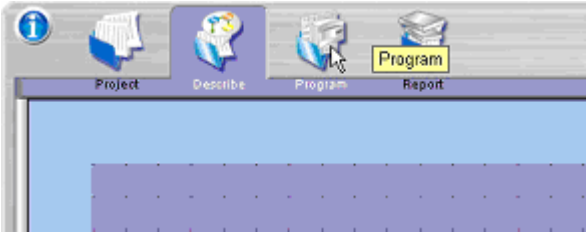
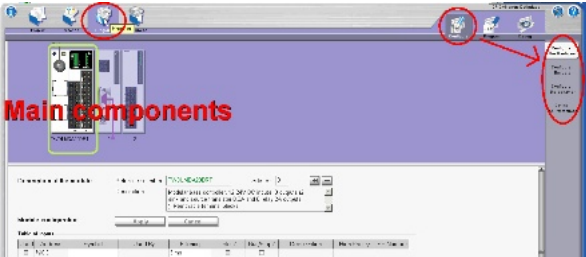

## Hardware Configuration

<p><b>1</b></p>	<p>For the hardware configuration select the main menu <b>Program</b>.</p>	
<p><b>2</b></p>	<p>The screen shows the PLC rack.</p> <p>Note the menus on the RHS and bottom of the display area.</p> <p>Menus on the RHS are sub-menus to the main menu along the top.</p>	

## Twido SPS

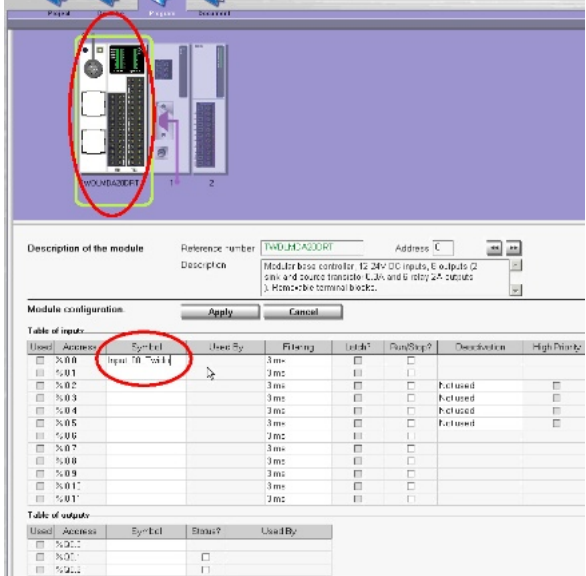
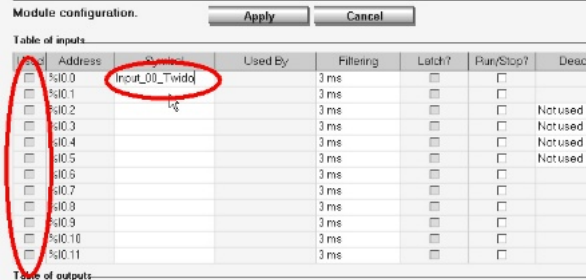
<p><b>1</b></p>	<p>You can now configure all the I/O variables for the PLC.</p> <p>To name the variables click on the <b>Symbol</b> column for a particular I/O and input the new name.</p>	
<p><b>2</b></p>	<p>Spaces and special characters are not allowed in symbol names.</p> <p>If the variable is already in use in the program, the check box to the LHS is activated.</p>	

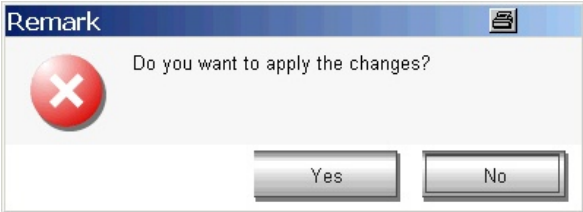
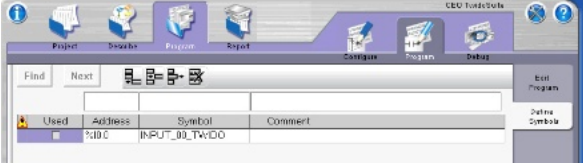

3	All symbol names are shown in uppercase.	<p><b>Table of inputs</b></p> <table border="1"> <thead> <tr> <th>Used</th> <th>Address</th> <th>Symbol</th> </tr> </thead> <tbody> <tr> <td><input type="checkbox"/></td> <td>%I0.0</td> <td>INPUT_00_TWIDO</td> </tr> <tr> <td><input type="checkbox"/></td> <td>%I0.1</td> <td></td> </tr> <tr> <td><input type="checkbox"/></td> <td>%I0.2</td> <td></td> </tr> </tbody> </table>	Used	Address	Symbol	<input type="checkbox"/>	%I0.0	INPUT_00_TWIDO	<input type="checkbox"/>	%I0.1		<input type="checkbox"/>	%I0.2	
Used	Address	Symbol												
<input type="checkbox"/>	%I0.0	INPUT_00_TWIDO												
<input type="checkbox"/>	%I0.1													
<input type="checkbox"/>	%I0.2													
4	<p>Changes are only made when the <b>Apply</b> button is pressed.</p> <p>If you try to exit the dialog without pressing <b>Apply</b>, you will be reminded.</p>	<p>Module configuration. <input type="button" value="Apply"/> <input type="button" value="Cancel"/></p> <p>Table of inputs</p> 												
5	Symbols entered in the configuration are automatically inserted into the variable list.													

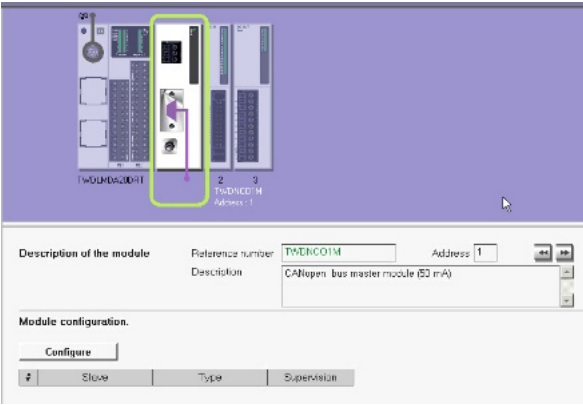
## CANopen Master

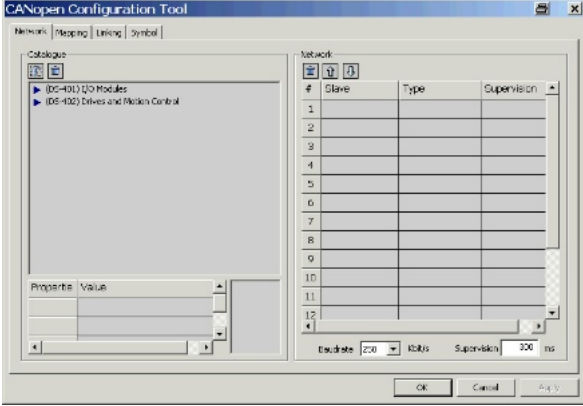
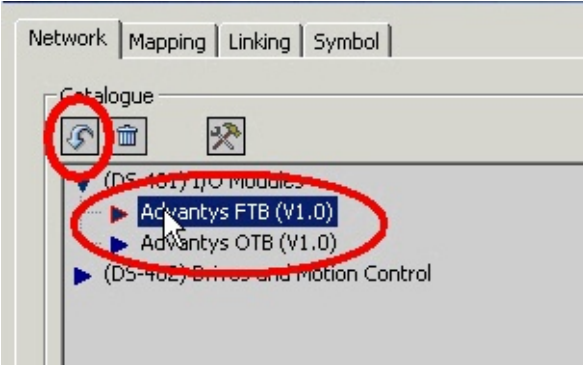
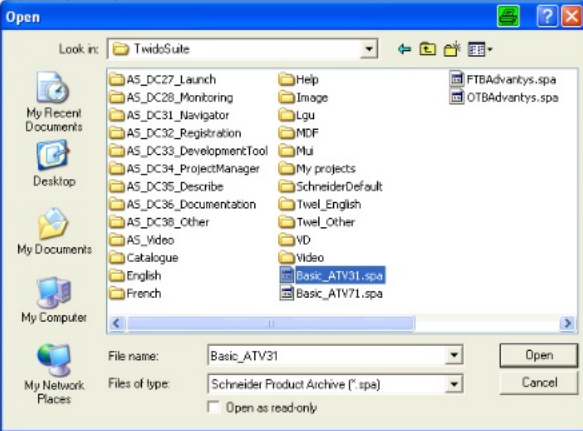
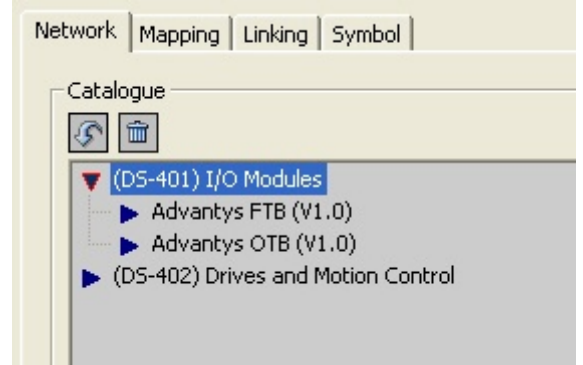
1	<p>The next step is to configure the CANopen Master.</p> <p>Click on the CANopen module in the graphics image.</p>									
2	Click on <b>Configure</b> in the <b>module configuration</b> .	<p>Module configuration.</p> <p><input type="button" value="Configure"/></p> <table border="1"> <thead> <tr> <th>#</th> <th>Slave</th> <th>Type</th> <th>Supervision</th> </tr> </thead> <tbody> <tr> <td></td> <td></td> <td></td> <td></td> </tr> </tbody> </table>	#	Slave	Type	Supervision				
#	Slave	Type	Supervision							

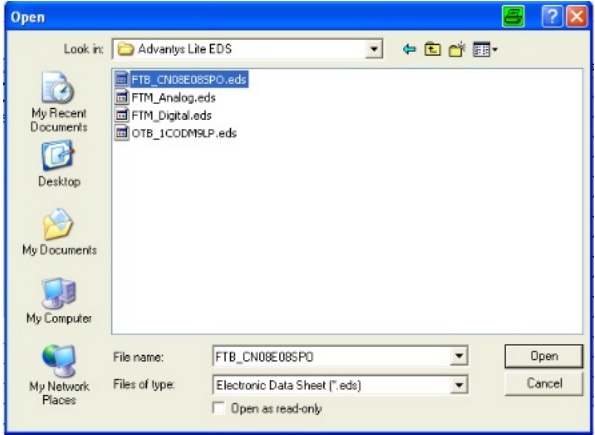
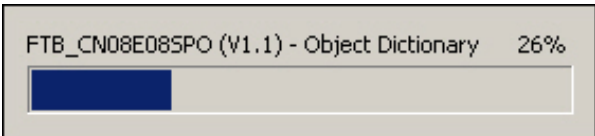
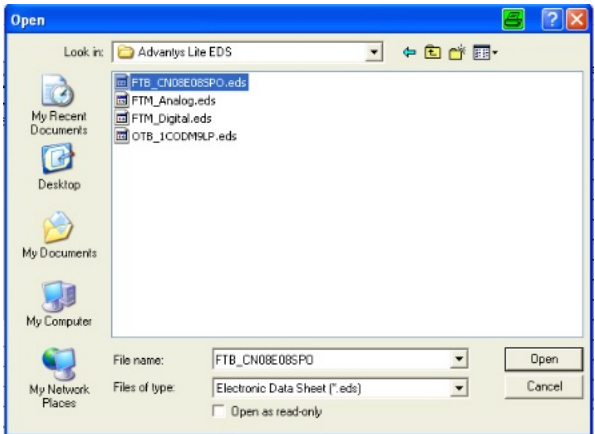
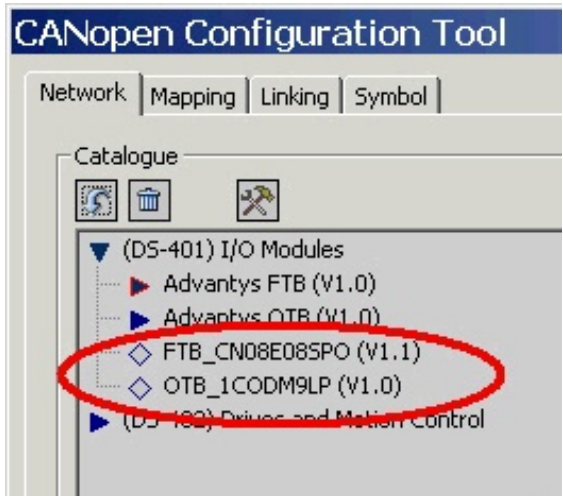
<p>3</p>	<p>The <b>CANopen Configuration Tool</b> appears.</p>	
<p>4</p>	<p>If there is no entry in the <b>catalogue</b> for Advantys FTB or Advantys OTB, the SPA files have not been imported. The files are installed with Twidosuite.</p> <p>To import the files, click on the import/export function (arrow icon, top left) to go to the standard Windows <b>Open</b> dialog</p>	
<p>5</p>	<p>In the <b>open</b> dialog set the path to the required SPA (Schneider Product Archive) files:</p> <p>File type : <b>*.SPA</b></p> <p>Path: Twidosuite</p>	
<p>6</p>	<p>Once the SPA files are imported they appear in the list under <b>DS-401</b> .</p>	

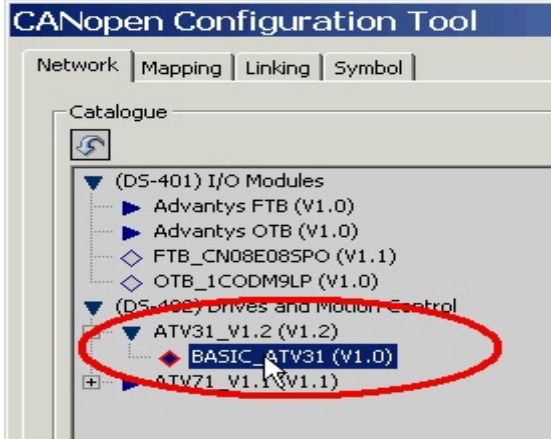
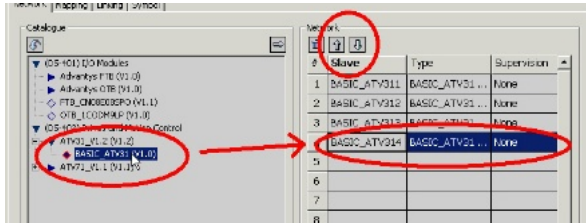
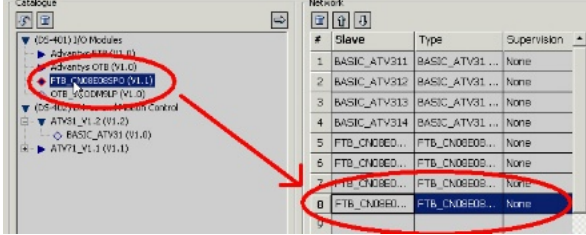
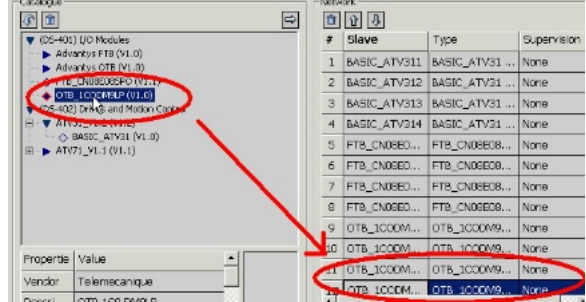
7	<p>Use the import function to import the <b>EDS Files</b> (Electronic Data Sheet) for the components.</p> <p>Here :</p> <p><b>FTB_CN08E08SPO.eds</b></p> <p>(See the example project)</p>	
8	<p>The import displays a progress bar.</p>	
9	<p>do the same for</p> <p><b>OTB_1CODM9LP.eds.</b></p>	
10	<p>After a successful import the components are listed as <b>DS-401 I/O Modules</b>.</p>	

<p><b>11</b></p>	<p>The configuration files for the Altivar 31 drives are already installed.</p>	 <p>The screenshot shows the 'CANopen Configuration Tool' interface. The 'Catalogue' tab is active, displaying a tree view of modules. Under '(DS-402) Drives and Motion Control', the 'ATV31_V1.2 (V1.2)' folder is expanded, and 'BASIC_ATV31 (V1.0)' is highlighted with a red circle. Other modules like 'Advantys FTB (V1.0)' and 'Advantys OTB (V1.0)' are also visible.</p>																																							
<p><b>12</b></p>	<p>For our example the first four slaves are used by the Altivars. To insert an Altivar as slave, double click on the Altivar entry in the <b>catalogue</b>.</p> <p>Use the arrow icons to move the entries up/down in the list.</p>	 <p>The screenshot shows the 'Network' tab of the configuration tool. A table lists slaves with columns for '# Slave', 'Type', and 'Supervision'. The first four rows are highlighted in blue, representing the Altivar slaves: 1 BASIC_ATV311, 2 BASIC_ATV312, 3 BASIC_ATV313, and 4 BASIC_ATV314. The 'BASIC_ATV314' entry is also highlighted with a red circle. Red arrows indicate the movement of entries in the list.</p> <table border="1"> <thead> <tr> <th># Slave</th> <th>Type</th> <th>Supervision</th> </tr> </thead> <tbody> <tr><td>1</td><td>BASIC_ATV311</td><td>None</td></tr> <tr><td>2</td><td>BASIC_ATV312</td><td>None</td></tr> <tr><td>3</td><td>BASIC_ATV313</td><td>None</td></tr> <tr><td>4</td><td>BASIC_ATV314</td><td>None</td></tr> <tr><td>5</td><td>FTB_CN08E0...</td><td>None</td></tr> <tr><td>6</td><td>FTB_CN08E0...</td><td>None</td></tr> <tr><td>7</td><td>FTB_CN08E0...</td><td>None</td></tr> <tr><td>8</td><td>FTB_CN08E0...</td><td>None</td></tr> </tbody> </table>	# Slave	Type	Supervision	1	BASIC_ATV311	None	2	BASIC_ATV312	None	3	BASIC_ATV313	None	4	BASIC_ATV314	None	5	FTB_CN08E0...	None	6	FTB_CN08E0...	None	7	FTB_CN08E0...	None	8	FTB_CN08E0...	None												
# Slave	Type	Supervision																																							
1	BASIC_ATV311	None																																							
2	BASIC_ATV312	None																																							
3	BASIC_ATV313	None																																							
4	BASIC_ATV314	None																																							
5	FTB_CN08E0...	None																																							
6	FTB_CN08E0...	None																																							
7	FTB_CN08E0...	None																																							
8	FTB_CN08E0...	None																																							
<p><b>13</b></p>	<p>Slaves 5-8 are the FTB modules.</p>	 <p>The screenshot shows the 'Network' tab. The table lists slaves 5 through 8, which are FTB modules. The entry 'FTB_CN08E0...' is highlighted with a red circle. Red arrows indicate the movement of entries in the list.</p> <table border="1"> <thead> <tr> <th># Slave</th> <th>Type</th> <th>Supervision</th> </tr> </thead> <tbody> <tr><td>1</td><td>BASIC_ATV311</td><td>None</td></tr> <tr><td>2</td><td>BASIC_ATV312</td><td>None</td></tr> <tr><td>3</td><td>BASIC_ATV313</td><td>None</td></tr> <tr><td>4</td><td>BASIC_ATV314</td><td>None</td></tr> <tr><td>5</td><td>FTB_CN08E0...</td><td>None</td></tr> <tr><td>6</td><td>FTB_CN08E0...</td><td>None</td></tr> <tr><td>7</td><td>FTB_CN08E0...</td><td>None</td></tr> <tr><td>8</td><td>FTB_CN08E0...</td><td>None</td></tr> </tbody> </table>	# Slave	Type	Supervision	1	BASIC_ATV311	None	2	BASIC_ATV312	None	3	BASIC_ATV313	None	4	BASIC_ATV314	None	5	FTB_CN08E0...	None	6	FTB_CN08E0...	None	7	FTB_CN08E0...	None	8	FTB_CN08E0...	None												
# Slave	Type	Supervision																																							
1	BASIC_ATV311	None																																							
2	BASIC_ATV312	None																																							
3	BASIC_ATV313	None																																							
4	BASIC_ATV314	None																																							
5	FTB_CN08E0...	None																																							
6	FTB_CN08E0...	None																																							
7	FTB_CN08E0...	None																																							
8	FTB_CN08E0...	None																																							
<p><b>14</b></p>	<p>OTB Modules are Slaves 9-12.</p>	 <p>The screenshot shows the 'Network' tab. The table lists slaves 9 through 12, which are OTB modules. The entry 'OTB_1CODM9...' is highlighted with a red circle. Red arrows indicate the movement of entries in the list.</p> <table border="1"> <thead> <tr> <th># Slave</th> <th>Type</th> <th>Supervision</th> </tr> </thead> <tbody> <tr><td>1</td><td>BASIC_ATV311</td><td>None</td></tr> <tr><td>2</td><td>BASIC_ATV312</td><td>None</td></tr> <tr><td>3</td><td>BASIC_ATV313</td><td>None</td></tr> <tr><td>4</td><td>BASIC_ATV314</td><td>None</td></tr> <tr><td>5</td><td>FTB_CN08E0...</td><td>None</td></tr> <tr><td>6</td><td>FTB_CN08E0...</td><td>None</td></tr> <tr><td>7</td><td>FTB_CN08E0...</td><td>None</td></tr> <tr><td>8</td><td>FTB_CN08E0...</td><td>None</td></tr> <tr><td>9</td><td>OTB_1CODM...</td><td>None</td></tr> <tr><td>10</td><td>OTB_1CODM...</td><td>None</td></tr> <tr><td>11</td><td>OTB_1CODM...</td><td>None</td></tr> <tr><td>12</td><td>OTB_1CODM...</td><td>None</td></tr> </tbody> </table>	# Slave	Type	Supervision	1	BASIC_ATV311	None	2	BASIC_ATV312	None	3	BASIC_ATV313	None	4	BASIC_ATV314	None	5	FTB_CN08E0...	None	6	FTB_CN08E0...	None	7	FTB_CN08E0...	None	8	FTB_CN08E0...	None	9	OTB_1CODM...	None	10	OTB_1CODM...	None	11	OTB_1CODM...	None	12	OTB_1CODM...	None
# Slave	Type	Supervision																																							
1	BASIC_ATV311	None																																							
2	BASIC_ATV312	None																																							
3	BASIC_ATV313	None																																							
4	BASIC_ATV314	None																																							
5	FTB_CN08E0...	None																																							
6	FTB_CN08E0...	None																																							
7	FTB_CN08E0...	None																																							
8	FTB_CN08E0...	None																																							
9	OTB_1CODM...	None																																							
10	OTB_1CODM...	None																																							
11	OTB_1CODM...	None																																							
12	OTB_1CODM...	None																																							
<p><b>15</b></p>	<p>Set the baudrate for the CANopen bus to:</p> <p><b>500Kbit/s</b></p>	 <p>The screenshot shows a dialog box for setting the baudrate. The 'Baudrate' dropdown menu is open, and '500' is selected. The 'Supervision' field is set to '300 ms'. Buttons for 'OK', 'Abbrechen', and 'Übernehmen' are visible.</p>																																							

16 Double click on the **Supervision** column for each slave and set the supervision type to **heartbeat**

(the default is normally set to **None**)

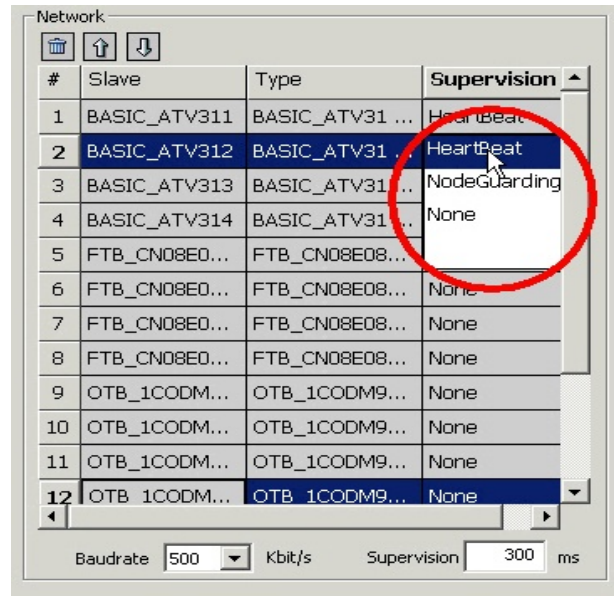

17 In the **Mapping** tab you can edit the **Transmit** and **Receive PDOs**.

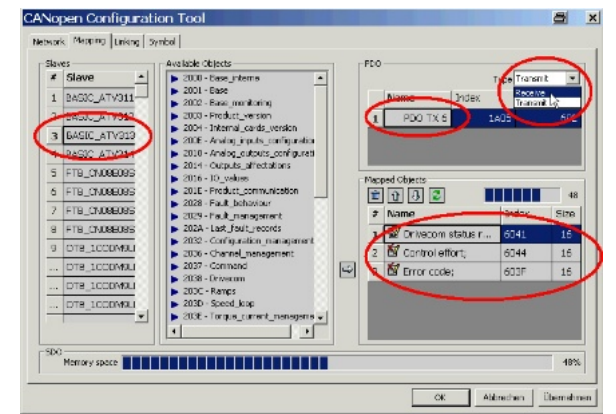

18 **Note:**  
You do not need to change the PDOs. If you do however, bear in mind that the SDO memory requirement changes.

The maximum SDO memory is fixed in the PLC and cannot be exceeded.

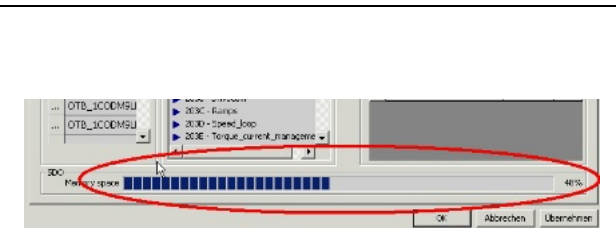

19 Use the tab **Linking** to select the PDOs that are to be transferred.

You must do this for both the **transmit** and **receive** direction.

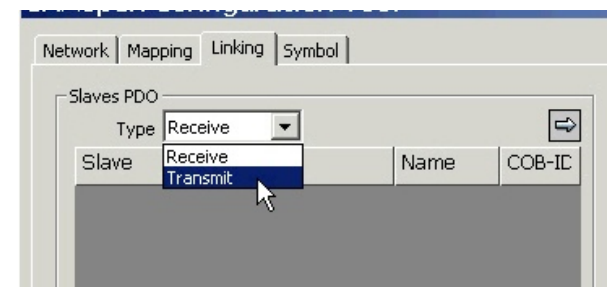



**20** Under **receive AND transmit**, doubleclick on the PDO to move it from the slave to the master PDO.

Note : all PDOs that are used must be moved. Normally you would move all PDOs. Those not moved are redundant

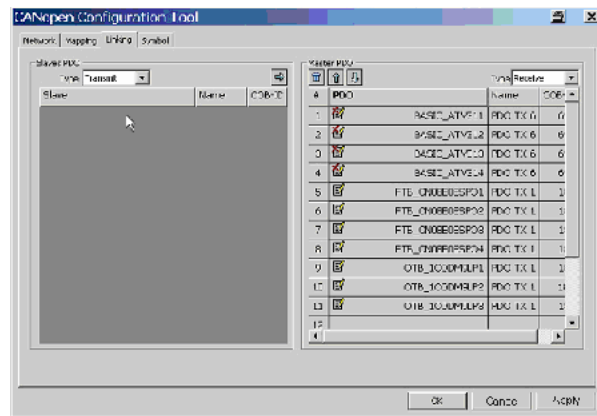
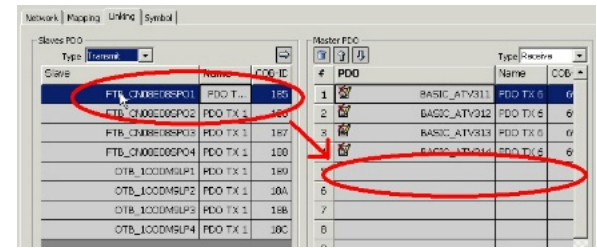

**21** Use the **Symbol** tab give your I/O variables names.

The Altivar 31 variables have standard names but can still be changed.

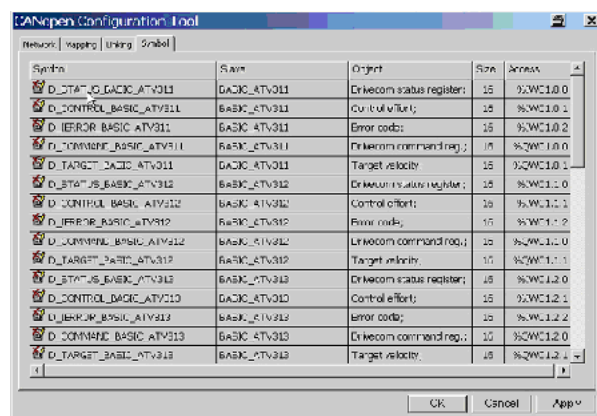

**22** Variables without names do not appear in the variable list. For ease of programming it is preferable to give the variables names.

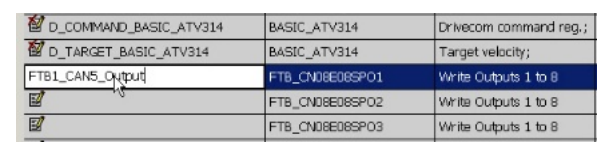

**23** To save the configuration click on **Apply** then exit the dialog with **OK**.

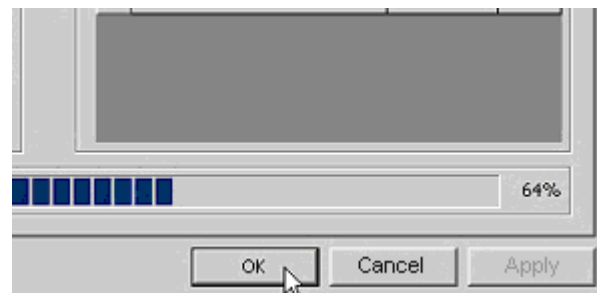

27 TwidoSuite now displays a table with all the configured CANopen slaves.

#	Slave	Type	Supervision
1	BASIC_ATV311	BASIC_ATV31 (V1.0)	HeartBeat
2	BASIC_ATV312	BASIC_ATV31 (V1.0)	HeartBeat
3	BASIC_ATV313	BASIC_ATV31 (V1.0)	HeartBeat
4	BASIC_ATV314	BASIC_ATV31 (V1.0)	HeartBeat
5	FTB_CN08E08SPO1	FTB_CN08E08SPO (V1.1)	HeartBeat
6	FTB_CN08E08SPO2	FTB_CN08E08SPO (V1.1)	HeartBeat
7	FTB_CN08E08SPO3	FTB_CN08E08SPO (V1.1)	HeartBeat
8	FTB_CN08E08SPO4	FTB_CN08E08SPO (V1.1)	HeartBeat
9	OTB_1CODM8LP1	OTB_1CODM8LP (V1.0)	HeartBeat
10	OTB_1CODM8LP2	OTB_1CODM8LP (V1.0)	HeartBeat
11	OTB_1CODM8LP3	OTB_1CODM8LP (V1.0)	HeartBeat
12	OTB_1CODM8LP4	OTB_1CODM8LP (V1.0)	HeartBeat

## Digital Input-Modul

1 Click on the the digital input module in the graphic.

The list of Inputs appears for the module.  
**Symbol** names can be input and applied.

The variables are automatically inserted into the variable list

**Description of the module** Reference number TWDDI8DT  
Description Expansion mod  
terminal, 1 com  
)

**Module configuration.**

**Table of inputs**

Used	Address	Symbol
<input type="checkbox"/>	%I0.2.0	
<input type="checkbox"/>	%I0.2.1	
<input type="checkbox"/>	%I0.2.2	
<input type="checkbox"/>	%I0.2.3	

## Drive Macros

1 To use the TwidoSuite macros for the Altivar 31, they must first be configured.

To do this select:

**Program->  
Configure->  
Configure the Data->  
Advanced object->  
Macros drive**

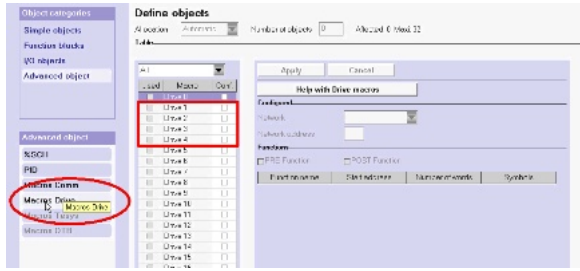
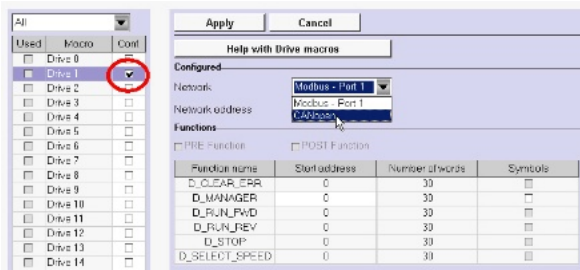
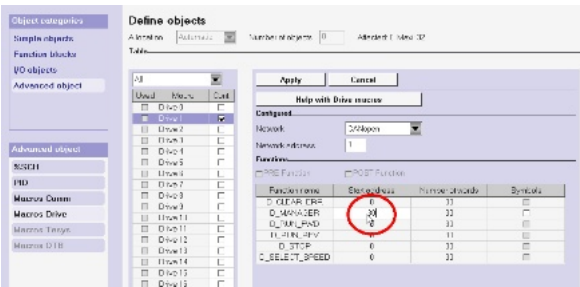
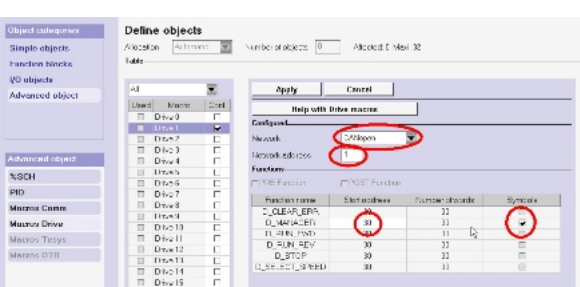
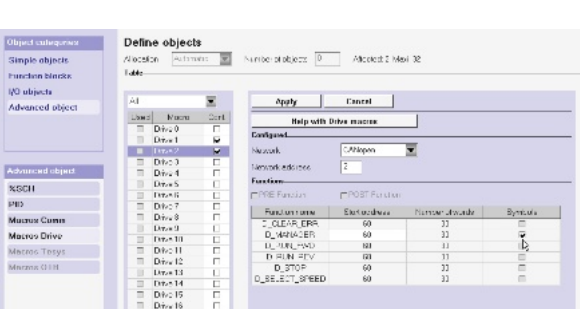

2	<p>For legibility, the macros are given the same number as the slave addresses, i.e. 1 – 4.</p>	
3	<p>Select a macro to configure it by activating the check box.</p> <p>Set:</p> <p>Network: <b>CANopen</b> Network Address : <b>1</b></p>	
4	<p>Reserve the memory words for the function in the entry <b>D_Manager</b>. In the example 30 words are reserved for macro drive 1, from MW30 to MW59, by giving the start address and the number of words required</p>	
5	<p>Setting the check box in the <b>Symbols</b> column allows the variables to be included in the variable list.</p>	
6	<p>Click <b>Apply</b> to implement the drive configuration.</p> <p>In the example drives 1-4 are set up with MW30, MW60, MW90 and MW120</p>	

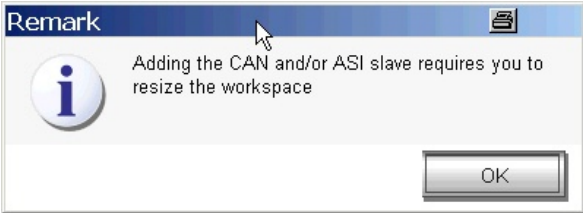
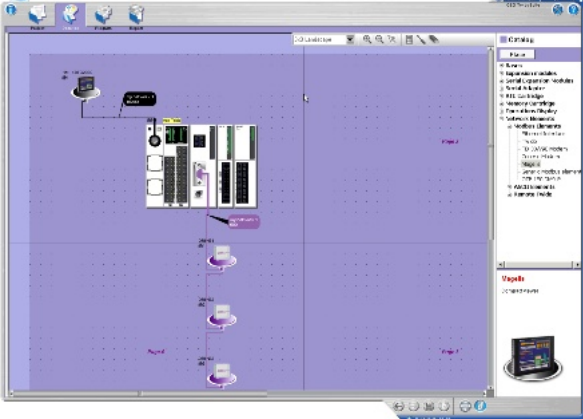
<p><b>7</b></p>	<p>Change now to the main menu <b>Describe</b> and you will receive a request to resize the workspace.</p> <p>Acknowledge the message with OK.</p>	 <p>Remark</p> <p>Adding the CAN and/or ASI slave requires you to resize the workspace</p> <p>OK</p>
<p><b>8</b></p>	<p>TwidoSuite has increased the workspace and the configured drives and CANopen bus are now shown in the graphics.</p>	 <p>Screenshot of the TwidoSuite workspace showing a 3x3 grid layout with various components like drives and CANopen buses.</p>

## Resizing Workspace

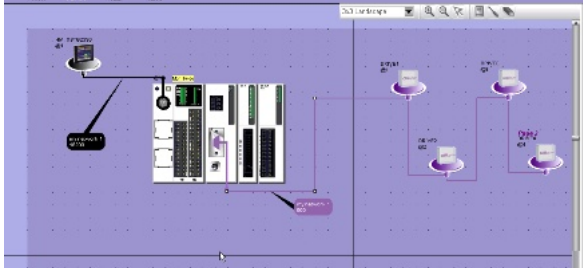
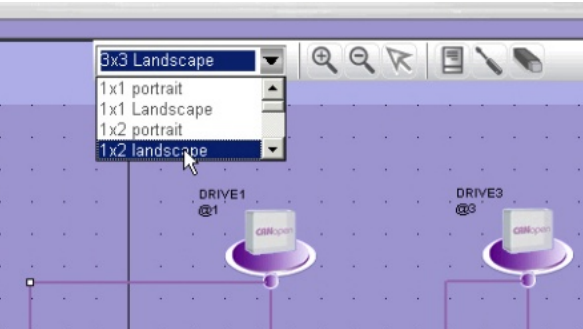
<p><b>1</b></p>	<p>You can re-position objects in the graphic to save space and for better legibility.</p> <p>Note: if you now print the image for documentation purposes empty fields are printed too.</p>	 <p>Screenshot of the workspace showing objects repositioned to save space.</p>
<p><b>2</b></p>	<p>To delete the empty fields, change the workspace format from 3x3 to 1x2.</p>	 <p>Screenshot of the workspace showing the format menu open, with options like 3x3 Landscape, 1x1 portrait, 1x1 Landscape, 1x2 portrait, and 1x2 landscape.</p>

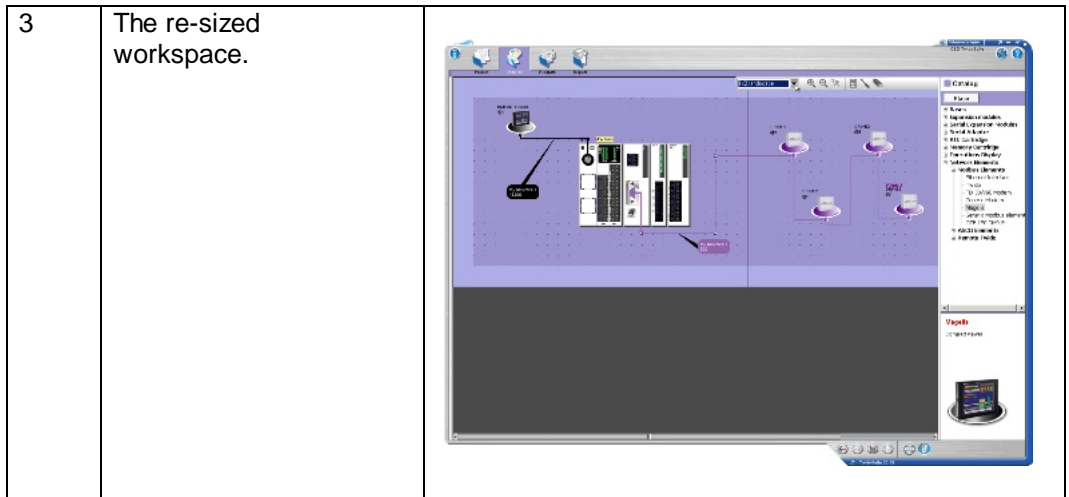

### Variable List

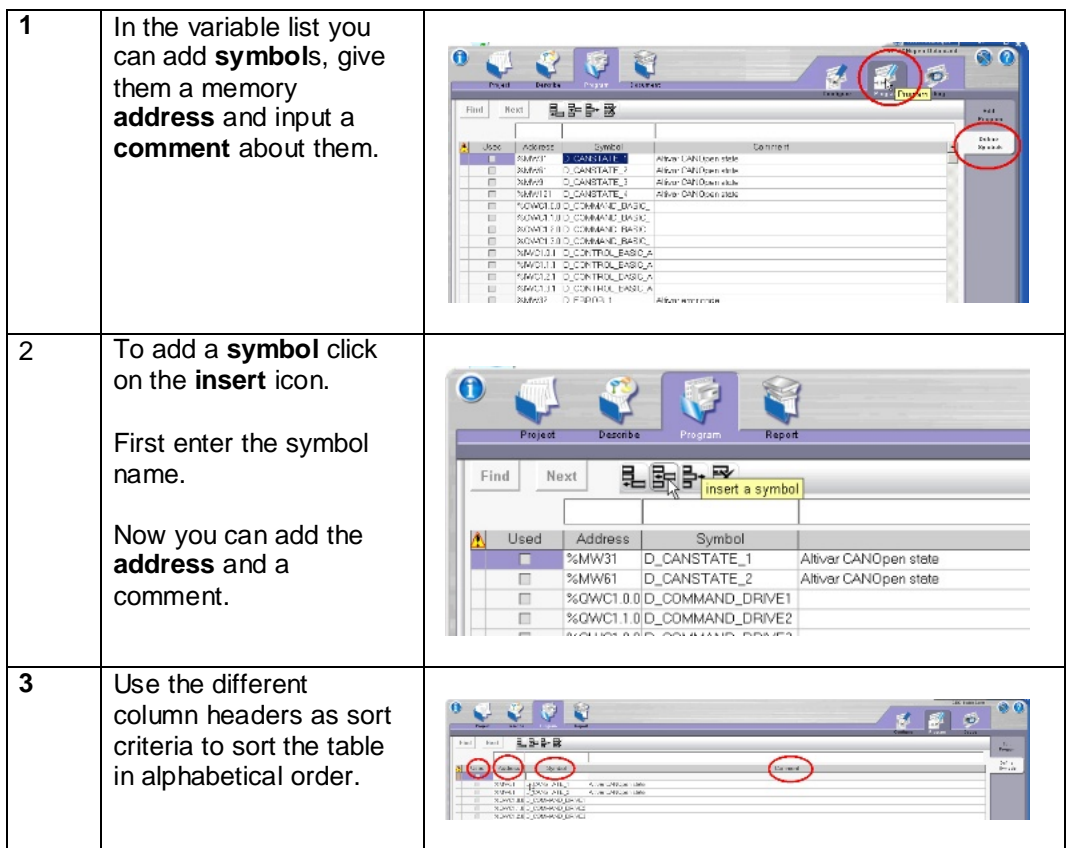

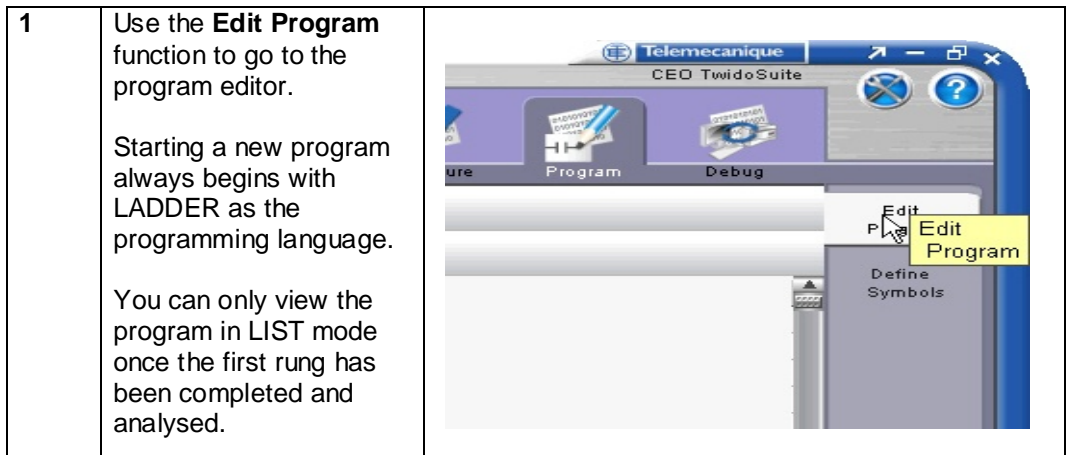

### Create an application Program

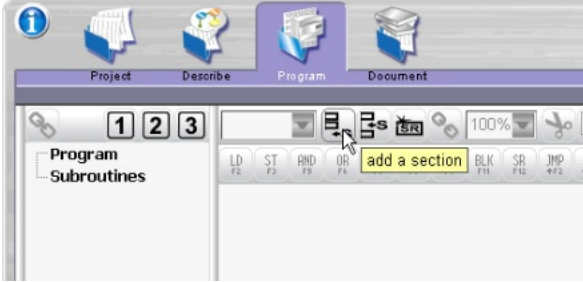
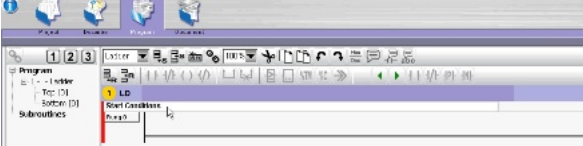
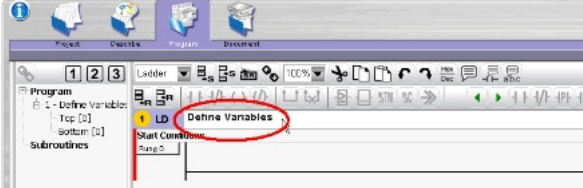
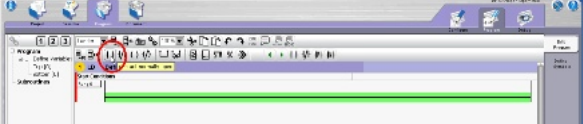
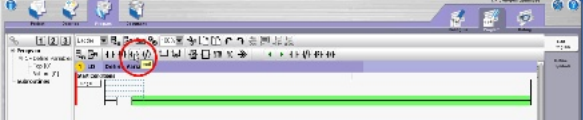
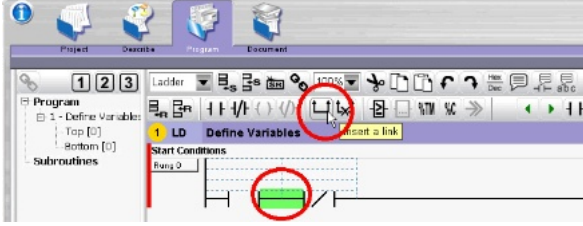

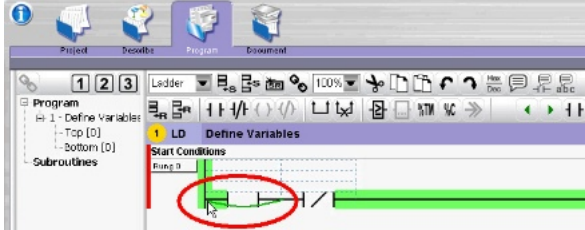
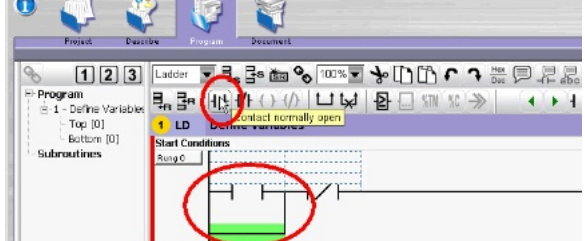
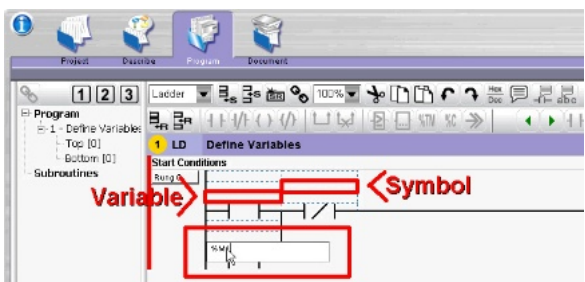
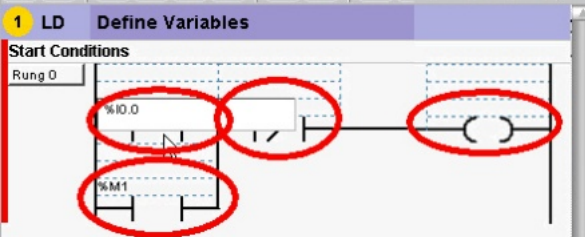
2	<p>Starting with an empty program, <b>add a section</b>. This will create a section with empty rungs. The first rung is marked in red on the LHS to denote that it has logical errors.</p>	
3	<p>Click on the top of a rung to rename it.</p>	
4	<p>You can also rename the section</p>	
5	<p>Clicking on the rung changes its colour to green and indicates the current rung being edited. Clicking on an icon in the toolbar inserts the selected object at the first available place on the rung. So, you can add contacts...</p>	
6	<p>....and outputs, etc.</p>	
7	<p>To make a logical connection, simply mark the source and pull it to the destination. All possible connecting points are shown in green</p>	

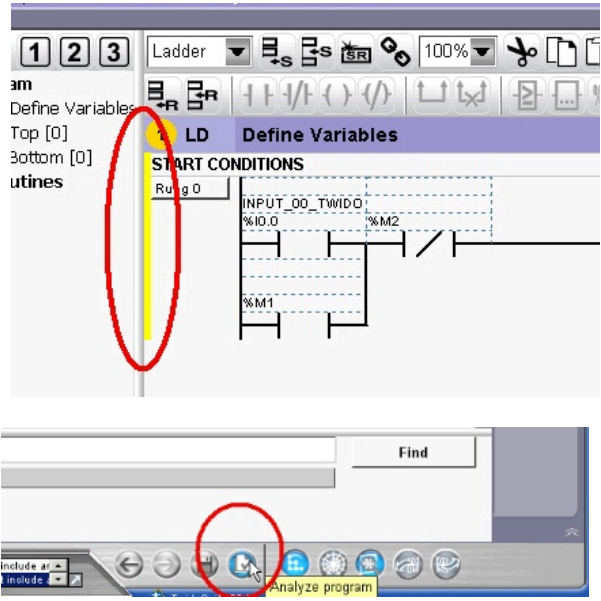
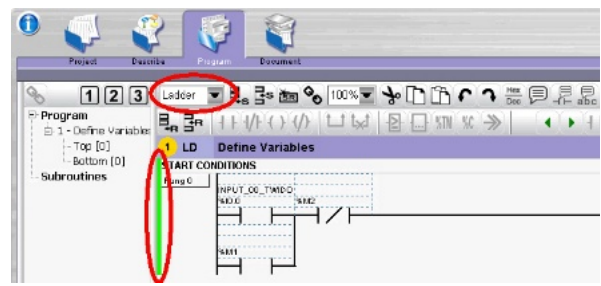

8	<p>Once a link has been inserted you can add a contact to form the logical OR.</p>	
9	<p>To assign an object to an address or variable, click on the upper half of the object</p>	
10	<p>The editor automatically recognises whether a rung is syntactically complete and marks it in yellow.</p> <p>The rung, however, has not yet been analysed. The analyze program button is in the bottom right hand corner.</p>	
11	<p>The Analysis is done for all contacts.</p>	

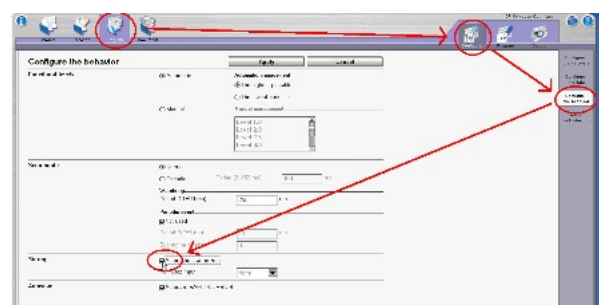

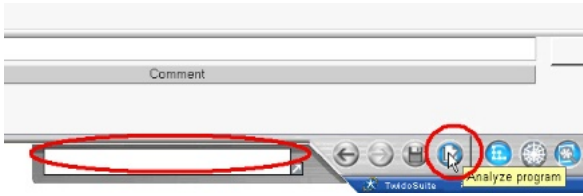
<p><b>12</b></p> <p>If the analysis is error free, the yellow band changes to green.</p> <p>You can now change the display mode to LIST if you wish.</p>		
<p><b>13</b></p> <p>If errors are found, these are listed at the bottom of the edit field.</p> <p>Click on the arrow icon to enlarge the display.</p>		
<p><b>14</b></p> <p>A common error is</p> <p><b>No Start In Run Was Selected</b></p>		
<p><b>15</b></p> <p>To fix this, select:</p> <p><b>Program-&gt; Configure-&gt; Configure the behavior</b></p> <p>In the <b>Configure the Behavior</b> dialog select:</p> <p><b>Automatic start in Run</b></p> <p>This is an operation mode that causes the PLC to start up automatically on return of power after a power failure.</p>		

16	After restarting the analysis the error field is empty.	
----	---	--

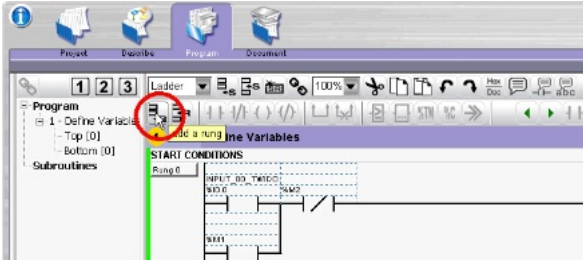
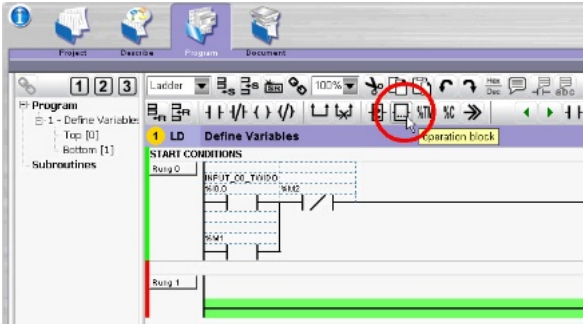
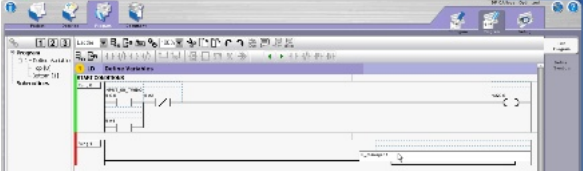
## Macro Drive

1	To use the macros for the drives, a second rung is added using the <b>add a rung</b> icon.	
2	Insert an <b>operation block</b> for the macro.	
3	To link the operation block to the macro drive input <b>D_manager 1</b> . <b>D_manager</b> is the macro function to access the drive and the 1 indicates Drive 1.	
4	The space between <b>D_manager</b> and the 1 is mandatory.	

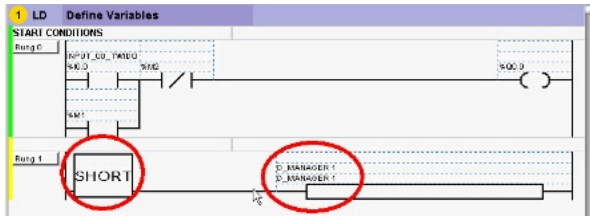

<p><b>5</b></p>	<p>As the macro is already configured, the address field also contains the symbolic macro name <b>D_MANAGER 1</b>. The <b>SHORT</b> seen here must be exchanged for a control variable.</p> <p>You can now repeat this for the other macros:</p> <p><b>D_CLEAR_ERR</b> <b>D_RUN_FWD</b> <b>D_RUN_REV</b> <b>D_STOP</b> und <b>D_SELECT_SPEED</b> .</p>	
-----------------	--	--

**Save / export the project**

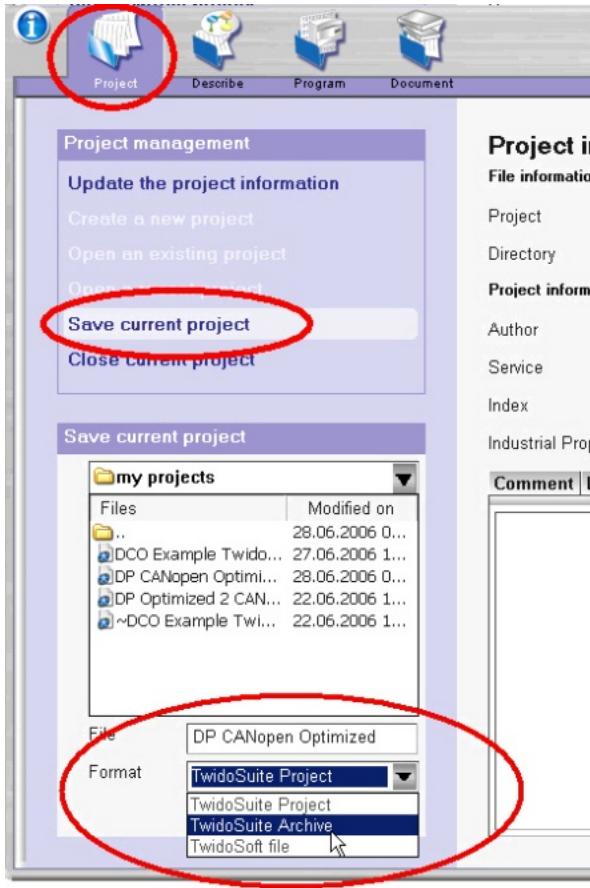
<p><b>1</b></p>	<p>To save the project select <b>Save current project</b> in the <b>Project</b> menu.</p> <p>In the <b>Save current project</b> window you can select the folder for the save, input the file name and designate the file <b>Format</b>.</p> <p>You can save the file as a normal <b>Project</b> file or as an <b>Archive</b> file. The Archive file has the advantage of being portable and is a single file.</p>	
-----------------	--	---

## Open a Project

1 To open a project use the **Open an existing project** function in the **Project** menu.

In the **open an existing project** window select the medium :  
**disk or Controller**

Give the file type under **Format** (for a project file: Project), select the folder and select the file you wish to open.

When ready, click on **Open** to open the project

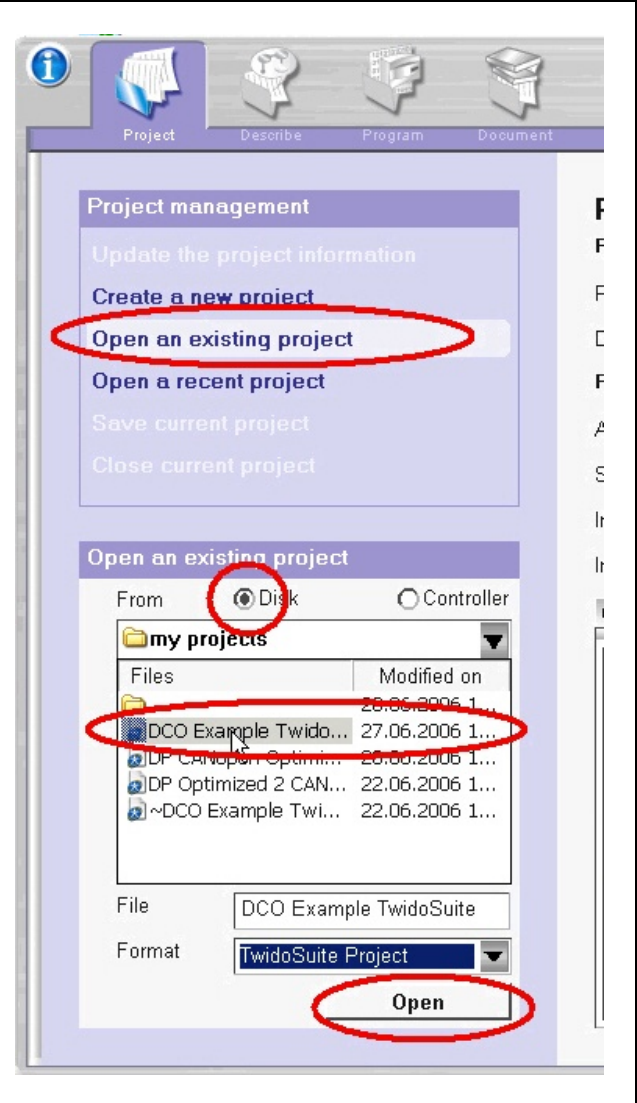

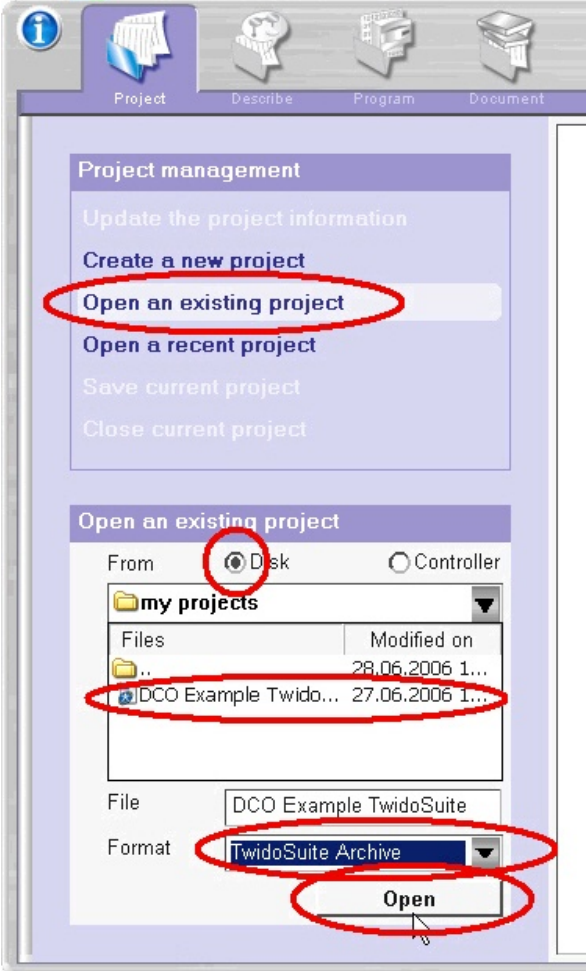

## Import a Project



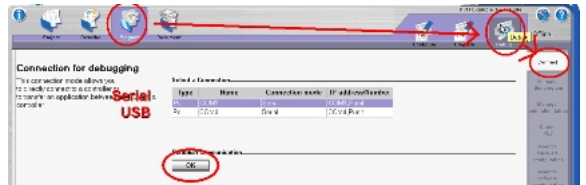
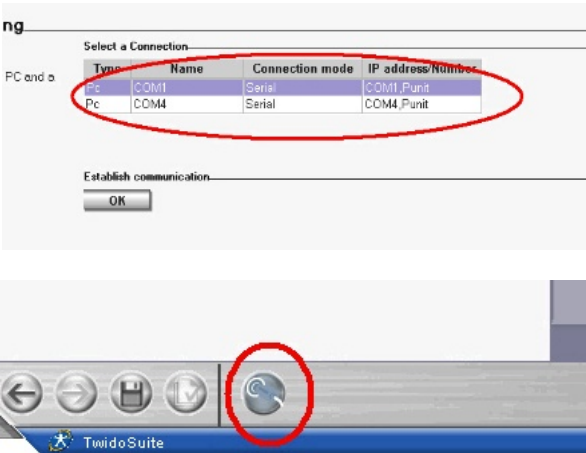

<p>1</p>	<p>Proceed as for <b>Open a project</b> (above) except for import, the file type is <b>Archive</b>.</p>	
----------	---	---

## Connecting to the PLC

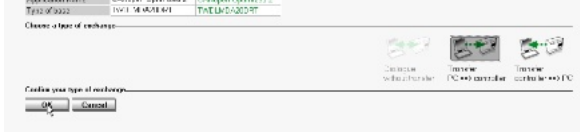
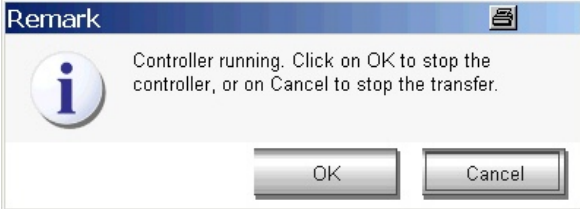
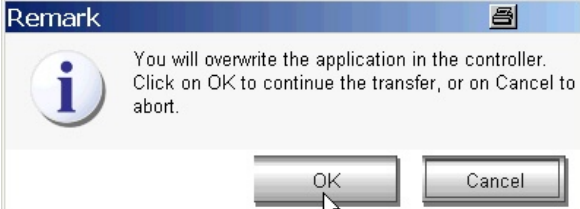
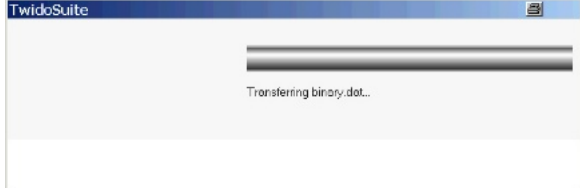
<p>1</p>	<p>To connect the PC to the PLC select <b>Program</b> in the main menu, then <b>Debug</b> in the sub-menu to get access to the connect selection.</p>													
<p>2</p>	<p>You can now either configure a new connection (see menu at bottom of window) or select a pre-configured connection.  To connect click on <b>OK</b>.</p>	 <table border="1" data-bbox="874 1538 1461 1787"> <thead> <tr> <th>Type</th> <th>Name</th> <th>Connection mode</th> <th>IP address/Number</th> </tr> </thead> <tbody> <tr> <td>Pc</td> <td>COM1</td> <td>Serial</td> <td>COM1_Punit</td> </tr> <tr> <td>Pc</td> <td>COM4</td> <td>Serial</td> <td>COM4_Punit</td> </tr> </tbody> </table>	Type	Name	Connection mode	IP address/Number	Pc	COM1	Serial	COM1_Punit	Pc	COM4	Serial	COM4_Punit
Type	Name	Connection mode	IP address/Number											
Pc	COM1	Serial	COM1_Punit											
Pc	COM4	Serial	COM4_Punit											

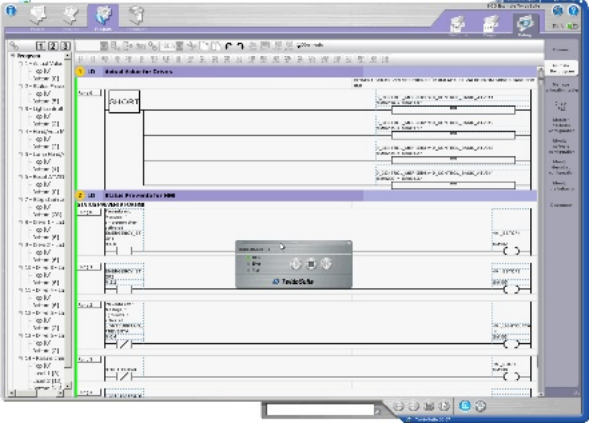
## Download a Program

3	<p>you will be shown a progress bar while Twidosuite establishes the connection.</p>	
1	<p>After successfully connecting to the Twido, Twidosuite compares the status of the project and the Twido PLC.</p> <p>Now you can either download your project or upload the contents of the PLC.</p>	
2	<p>To download the project select:</p> <p><b>Transfer PC-&gt;controller</b></p> <p>and confirm with <b>OK</b></p>	
3	<p>If the Twido is already running it must be stopped first.</p> <p>Confirm with <b>OK</b> if you wish to proceed.</p>	
4	<p>You will be shown a warning that the contents of the PLC are about to be overwritten</p> <p>confirm with <b>OK</b> to continue.</p>	
5	<p>The download condition is indicated with a process bar.</p>	

<p>6</p>	<p>After a successful download, Twidosuite jumps automatically to the online viewing.</p>	
<p>7</p>	<p>A control panel appears in the foreground. Here you can start and stop the PLC.</p> <p>The upper button extends the window, offering more PLC status information</p>	
<p>8</p>	<p>If you start the PLC you will be asked to confirm the action</p> <p>If you wish to proceed with the start click on <b>OK</b>.</p>	
<p>9</p>	<p>After successfully starting the PLC the <b>RUN LED</b> changes from yellow to <b>green</b>.</p>	

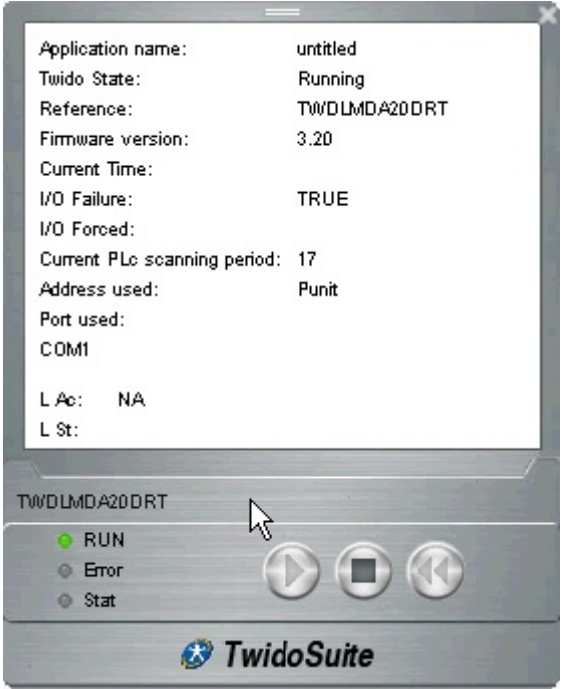
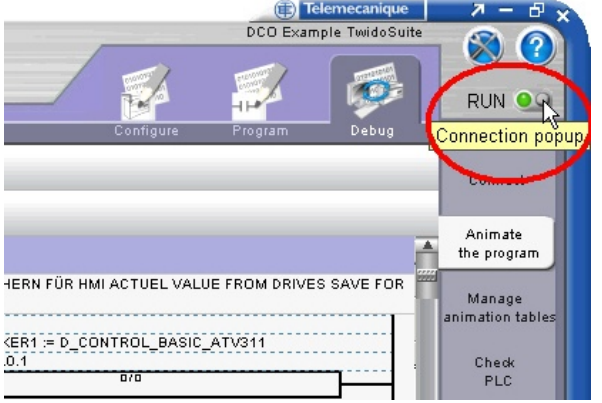
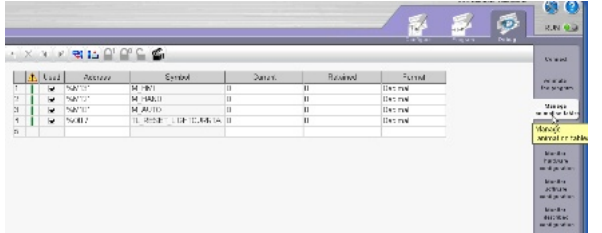
<p><b>10</b></p>	<p>Here the expanded window with the PLC in run mode.</p>																																					
<p><b>11</b></p>	<p>If the online status window is closed, a click in the upper left hand corner of the main window opens it again.</p>																																					
<p><b>12</b></p>	<p>The sub-menu <b>Manage animation tables</b> allows access to animation tables.</p>	 <table border="1" data-bbox="871 1451 1318 1626"> <thead> <tr> <th>Load</th> <th>Address</th> <th>Error</th> <th>Status</th> <th>Required</th> <th>Format</th> </tr> </thead> <tbody> <tr> <td>1</td> <td>%M0</td> <td>M 001</td> <td>0</td> <td>0</td> <td>0x1 rw</td> </tr> <tr> <td>2</td> <td>%M01</td> <td>M 002</td> <td>0</td> <td>0</td> <td>0x1 rw</td> </tr> <tr> <td>3</td> <td>%M02</td> <td>M 003</td> <td>0</td> <td>0</td> <td>0x1 rw</td> </tr> <tr> <td>4</td> <td>%M03</td> <td>M 004</td> <td>0</td> <td>0</td> <td>0x1 rw</td> </tr> <tr> <td>5</td> <td>%M04</td> <td>M 005</td> <td>0</td> <td>0</td> <td>0x1 rw</td> </tr> </tbody> </table>	Load	Address	Error	Status	Required	Format	1	%M0	M 001	0	0	0x1 rw	2	%M01	M 002	0	0	0x1 rw	3	%M02	M 003	0	0	0x1 rw	4	%M03	M 004	0	0	0x1 rw	5	%M04	M 005	0	0	0x1 rw
Load	Address	Error	Status	Required	Format																																	
1	%M0	M 001	0	0	0x1 rw																																	
2	%M01	M 002	0	0	0x1 rw																																	
3	%M02	M 003	0	0	0x1 rw																																	
4	%M03	M 004	0	0	0x1 rw																																	
5	%M04	M 005	0	0	0x1 rw																																	

**13** Use the project browser to navigate through the program sections.

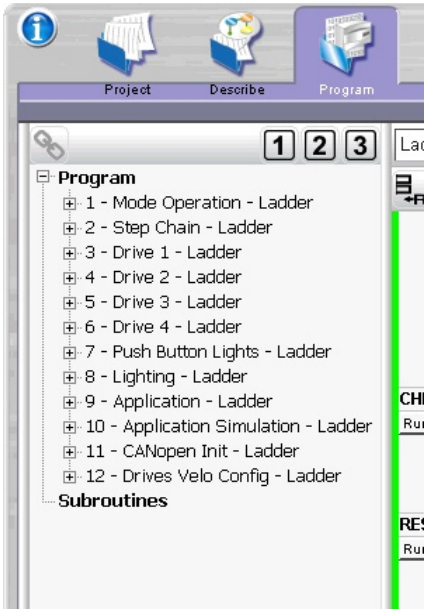



# Advantys OTB/FTB

## Introduction

The OTB/FTB chapter describes how to address the Advantys OTB and Advantys FTB devices to fulfill the system functionality as described above.

## General

OTB and FTB addressing are performed in an identical manner on the device using a small screwdriver.

Since in our example the OTB and FTB devices operate with a CANopen bus which connects them to the Twido PLC, the addresses lie within the range 1-16.

The CANopen bus can normally manage up to 128 slaves, but since a Twido is used for the master PLC in this example, only 16 slaves with addresses 1-16 can be used. Other bus components with higher addresses are neither detected nor addressed.

## Setting the CANopen Address

1 During the TwidoSoft CANopen configuration process, an address is automatically assigned to the individual CANopen bus components in their order of installation.

In our example there are four ATV31 drives on addresses 1-4, four FTBs on addresses 5-8 and four OTBs on addresses 9-12.

We will use OTB4 with address 12 to illustrate how to assign addresses to the components.

The individual components are addressed as follows in the software:



For the first OTB with CANopen address 9, the input word is read in the form %IWC1.8.0.

This means:

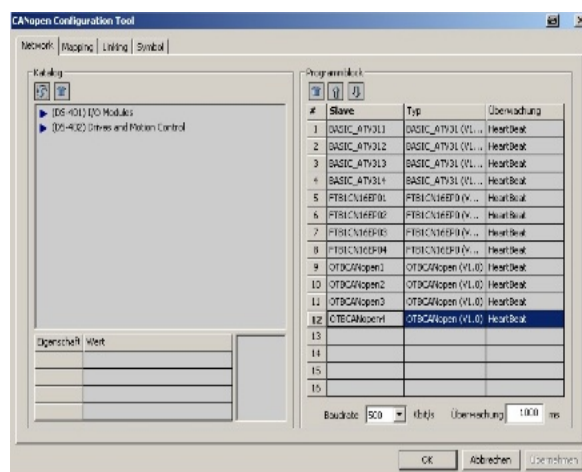
- %IW = input word
- C = CANbus
- 1 = CANopen master slot
- 8 = CANopen address -1 (9-1=8)



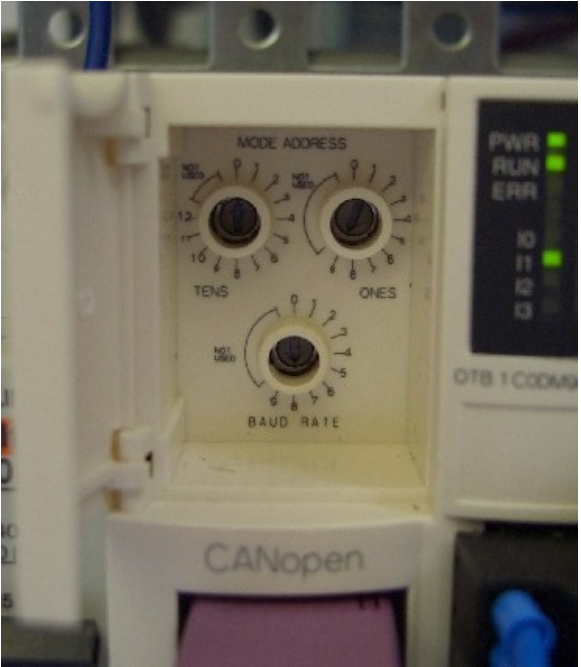

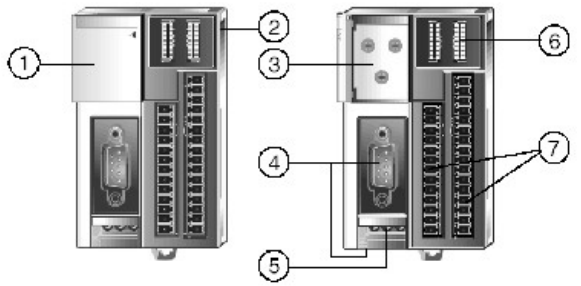
**OTB**

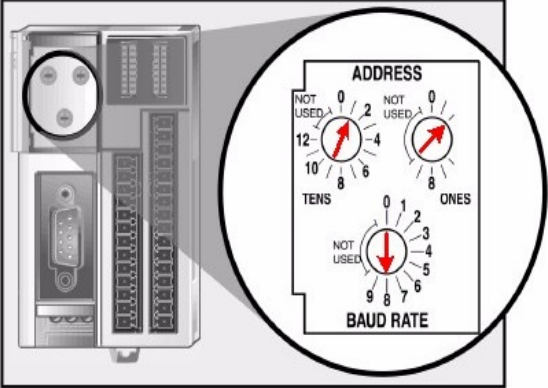
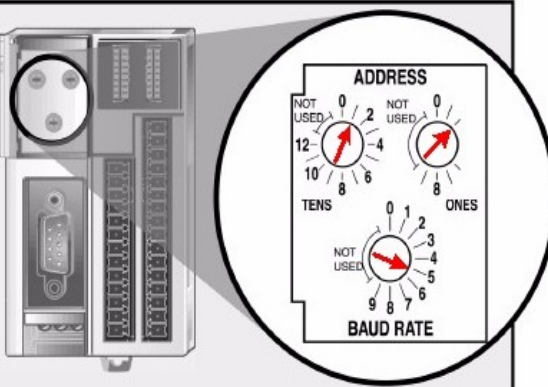
<p><b>2</b></p>	<p>The OTB address is set using the rotating switches.</p> <p>The tens range from 0-12 which corresponds to 0-120 in steps of 1/10.</p> <p>The units ranges from 0-9.</p> <p>The baud rate is set using lower switch.</p>	
<p><b>3</b></p>	<p>Use a small screwdriver to adjust the settings.</p> <p>The slot in the adjuster screw has an arrow at one end to indicate the selected address.</p>	
<p><b>4</b></p>	<p>The first image shows the OTB cover closed.</p> <p>The second, the three adjuster switches with the OTB cover open.</p>	

<p><b>5</b></p>	<p>In this example, address 12 is set to automatic baud rate recognition (position 8).</p> <p>With automatic recognition, an attempt is made on initialization to synchronize each baud rate, from the highest value (1Mbps) to the lowest.</p> <p>Note: automatic baudrate recognition takes longer than manual input.</p>																					
<p><b>6</b></p>	<p>In the table opposite, the relevant baud rate can be determined from the lower adjuster switch.</p>																					
<p><b>7</b></p>	<p>In the table opposite, the relevant baud rate can be determined for the baud rate switch.</p> <p>In our example, a baud rate of 500 kbps is entered in TwidoSoft. Either <b>5</b> for <b>500</b> kbps or <b>8</b> for <b>automatic</b> must therefore be set on the OTBs.</p>	<table border="1"> <tr><td>0</td><td>10 kBit/s</td></tr> <tr><td>1</td><td>20 kBit/s</td></tr> <tr><td>2</td><td>50 kBit/s</td></tr> <tr><td>3</td><td>125 kBit/s</td></tr> <tr><td>4</td><td>250 kBit/s</td></tr> <tr><td>5</td><td>500 kBit/s</td></tr> <tr><td>6</td><td>800 kBit/s</td></tr> <tr><td>7</td><td>1 MBit/s</td></tr> <tr><td>8</td><td>Auto</td></tr> <tr><td>9</td><td>Standard-Baudrate (250 kBit/s)</td></tr> </table>	0	10 kBit/s	1	20 kBit/s	2	50 kBit/s	3	125 kBit/s	4	250 kBit/s	5	500 kBit/s	6	800 kBit/s	7	1 MBit/s	8	Auto	9	Standard-Baudrate (250 kBit/s)
0	10 kBit/s																					
1	20 kBit/s																					
2	50 kBit/s																					
3	125 kBit/s																					
4	250 kBit/s																					
5	500 kBit/s																					
6	800 kBit/s																					
7	1 MBit/s																					
8	Auto																					
9	Standard-Baudrate (250 kBit/s)																					

**FTB**

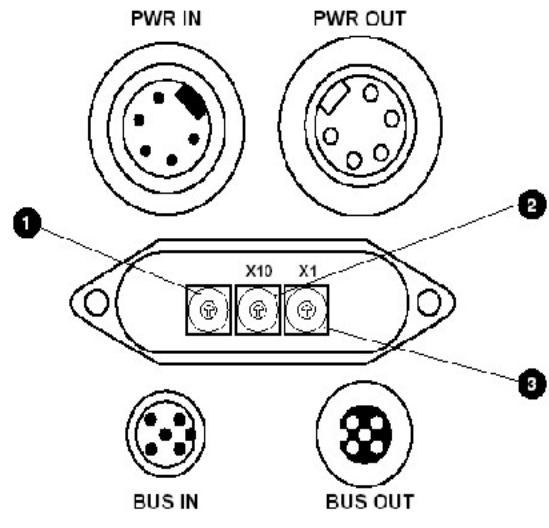
<p><b>1</b></p>	<p>The FTB is shown here.</p> <p>Point 6 shows the adjuster screws on the FTB.</p> <p>The setting area is protected by an IP67 cover. Before adjusting the settings, the cover must first be removed by loosening the two side screws.</p>																																	
<p><b>2</b></p>	<p>In the table opposite, the relevant baud rate can be determined for the baud rate adjuster.</p> <p>In our example, a baud rate of 500 kbps is entered in TwidoSoft. Either <b>7</b> for <b>500</b> kbps or <b>0</b> for <b>automatic</b> must therefore be set on the FTBs.</p>	<table border="0"> <thead> <tr> <th></th> <th>DATA RATE</th> <th>NODE</th> <th>ADDRESS</th> </tr> <tr> <th></th> <th></th> <th>x 10</th> <th>x 1</th> </tr> </thead> <tbody> <tr> <td></td> <td></td> <td></td> <td></td> </tr> <tr> <td>Data Rate :</td> <td>0 = AUTO</td> <td>5 = 125 kbit/s</td> <td></td> </tr> <tr> <td></td> <td>1 = 10 kbit/s</td> <td>6 = 250 kbit/s</td> <td></td> </tr> <tr> <td></td> <td>2 = 20 kbit/s</td> <td>7 = 500 kbit/s</td> <td></td> </tr> <tr> <td></td> <td>3 = 50 kbit/s</td> <td><b>8 = 800 kbit/s</b></td> <td></td> </tr> <tr> <td></td> <td>4 = 100 kbit/s</td> <td><b>9 = 1000 kbit/s</b></td> <td></td> </tr> </tbody> </table>		DATA RATE	NODE	ADDRESS			x 10	x 1					Data Rate :	0 = AUTO	5 = 125 kbit/s			1 = 10 kbit/s	6 = 250 kbit/s			2 = 20 kbit/s	7 = 500 kbit/s			3 = 50 kbit/s	<b>8 = 800 kbit/s</b>			4 = 100 kbit/s	<b>9 = 1000 kbit/s</b>	
	DATA RATE	NODE	ADDRESS																															
		x 10	x 1																															
Data Rate :	0 = AUTO	5 = 125 kbit/s																																
	1 = 10 kbit/s	6 = 250 kbit/s																																
	2 = 20 kbit/s	7 = 500 kbit/s																																
	3 = 50 kbit/s	<b>8 = 800 kbit/s</b>																																
	4 = 100 kbit/s	<b>9 = 1000 kbit/s</b>																																

<p><b>3</b></p> <p>Selector 1 here shows the baud rate setting . Selector 2 shows the “tens” position and selector 3 shows the “units” position.</p> <p>Setting is performed as for the OTB. The table for the baud rates and the adjuster screw positions are also identical.</p> <p>In our example, setting proceeds from left to right:</p> <ul style="list-style-type: none"> <li>- 7 for 500kbits/s baud rate</li> <li>- 0 for the tenths position</li> <li>- 5-8 for the four addresses of our FTBs</li> </ul>																														
<p><b>4</b></p> <p>Another configuration must be created in the software for the FTB modules. Particular output words must be set for this purpose.</p> <p>The FTBs have M12 connectors on which pin 4 stands for an input signal. Pin 2 can then be used for another sensor (with an inverted signal!) or for an alarm prompt.</p>		<p><b>Object 2000H: Parameter input/diagnostic pin 2</b></p> <p>On receipt of parameter information, the current parameter setting is compared with the new data. The FTB CANopen module is re-parameterized if data has changed. The FTB CANopen can be re-parameterized at any time.</p> <table border="1"> <thead> <tr> <th>Sub-Index</th> <th>PDO-Mapping</th> <th>Access</th> <th>Data Type</th> <th>Default Value</th> <th>Description</th> </tr> </thead> <tbody> <tr> <td>0</td> <td>no</td> <td>ro</td> <td>UNSIGNED8</td> <td>01H</td> <td>Number of entries</td> </tr> <tr> <td>1</td> <td>yes</td> <td>rw</td> <td>UNSIGNED8</td> <td>FFH</td> <td>Input functionality diagnostic (Pin2 only)</td> </tr> </tbody> </table> <table border="1"> <thead> <tr> <th>Sub-Index</th> <th>Bit-No.</th> <th>Status</th> <th>Test</th> </tr> </thead> <tbody> <tr> <td rowspan="2">1</td> <td rowspan="2">0 to 7</td> <td>1</td> <td>Pin 2, M12 socket 0 to 7: Diagnostic input</td> </tr> <tr> <td>0</td> <td>Pin 2, M12 socket 0 to 7: Digital input</td> </tr> </tbody> </table> <p> Parameterization of manufacturer-specific device profiles must precede parameter assignment of device profiles</p>	Sub-Index	PDO-Mapping	Access	Data Type	Default Value	Description	0	no	ro	UNSIGNED8	01H	Number of entries	1	yes	rw	UNSIGNED8	FFH	Input functionality diagnostic (Pin2 only)	Sub-Index	Bit-No.	Status	Test	1	0 to 7	1	Pin 2, M12 socket 0 to 7: Diagnostic input	0	Pin 2, M12 socket 0 to 7: Digital input
Sub-Index	PDO-Mapping	Access	Data Type	Default Value	Description																									
0	no	ro	UNSIGNED8	01H	Number of entries																									
1	yes	rw	UNSIGNED8	FFH	Input functionality diagnostic (Pin2 only)																									
Sub-Index	Bit-No.	Status	Test																											
1	0 to 7	1	Pin 2, M12 socket 0 to 7: Diagnostic input																											
		0	Pin 2, M12 socket 0 to 7: Digital input																											
<p><b>5</b></p> <p>The graphic opposite shows the configuration necessary for our four FTBs.</p> <p>Flag words are used here for an FTB with CANopen address 6 (corresponding to %QWC1.5.0/1) to simulate modifications to the configuration in Run mode.</p> <p>This configuration can be retransmitted at any time. The FTB is initialized only on reception of a new configuration.</p>		<pre> LD ST AND OR XOR IN MPS BLK SR JMP ZI ZO ZM ZS ZTM F2 F3 F5 F6 F7 F8 F9 F11 F12 +F2 +F3 +F5 +F6 +F7 +F8 ----- SR (* INITIALISIERUNG FTB *) ----- (* INITZIALISATION FTB *) 0 LD 1 1 [ FTB1_CONFIGWORD2 := 16#0000 ] 2 [ FTB2_CONFIGWORD2 := %MW171 ] 3 [ FTB3_CONFIGWORD2 := 16#0000 ] 4 [ FTB4_CONFIGWORD2 := 16#0000 ] 5 LD 1 6 [ FTB1_CONFIGWORD1 := 16#FFFF ] 7 [ FTB2_CONFIGWORD1 := %MW173 ] 8 [ FTB3_CONFIGWORD1 := 16#FFFF ] 9 [ FTB4_CONFIGWORD1 := 16#FFFF ] ----- (* ----- *) </pre>																												

---

# Devices

---

## Advantys OTB

---

### Introduction

The Advantys OTB chapter describes how to add an OTB in TwidoSuite and how to create an EDS file.

### Pre-conditions



Before carrying out the steps described below, you must ensure the following:

- The TwidoSuite programming tool is installed on your PC
- The OTB.spa file must already be in the TwidoSuite configuration
- The Advantys tool is installed on your PC

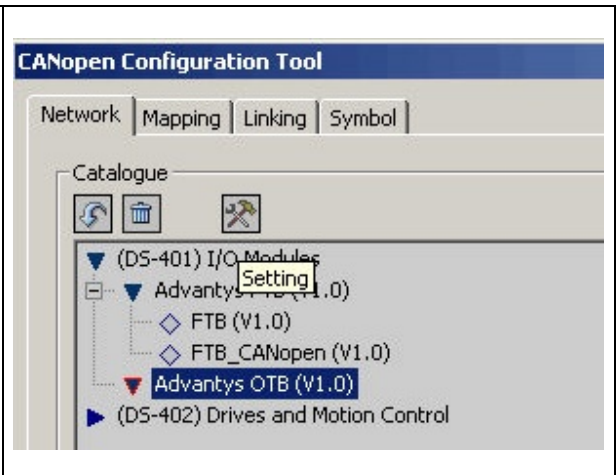
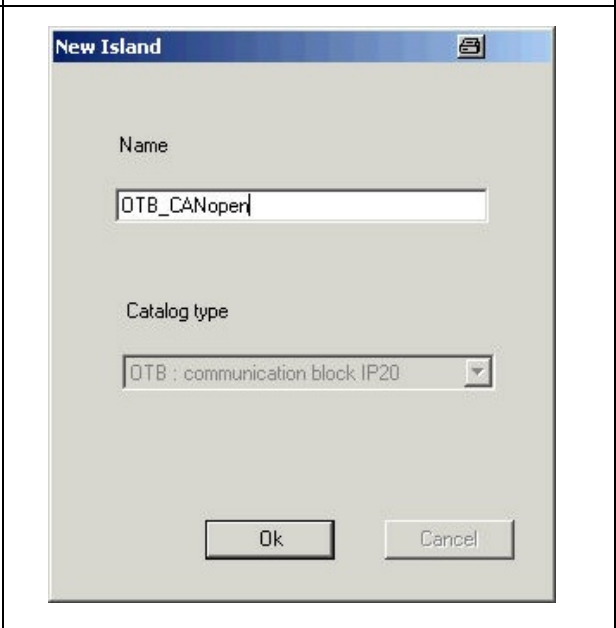
### Starting Advantys for OTB

1	<p>In order to start Advantys from the TwidoSoft program, select <b>Advantys OTB</b> after the <b>SPA</b> files have been loaded.</p> <p>Click on the icon with the hammer&amp;spanner to start the Advantys tool for the OTB</p>	
2	<p>In the <b>New Island</b> dialog, assign a name.</p> <p>In our example this is: "OTB_CANopen".</p> <p>Confirm with <b>OK</b>.</p>	

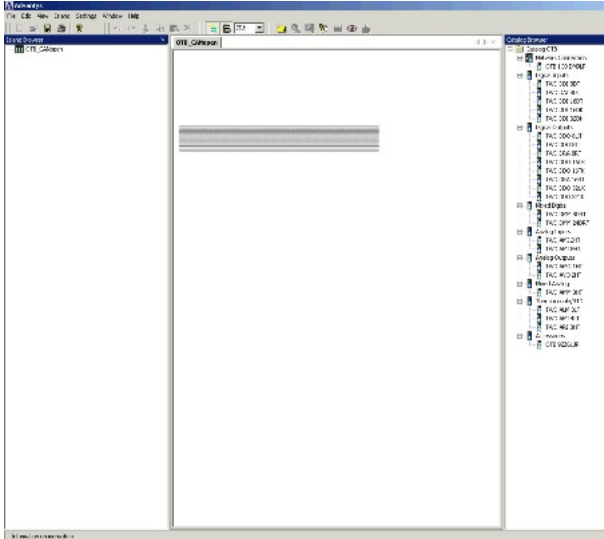

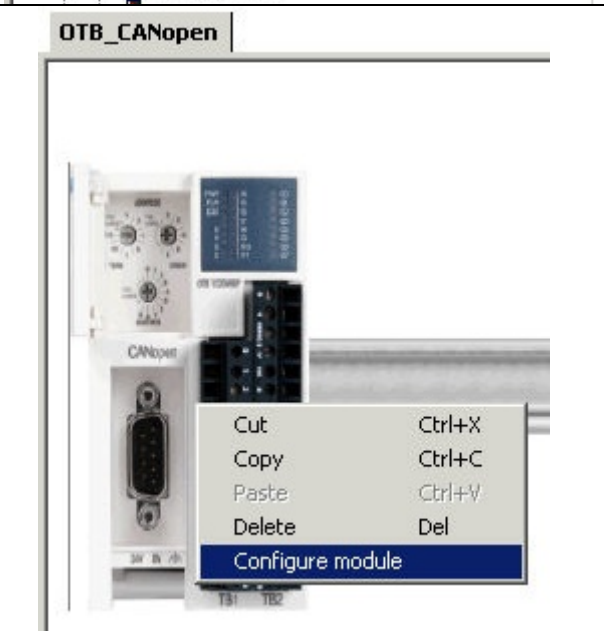
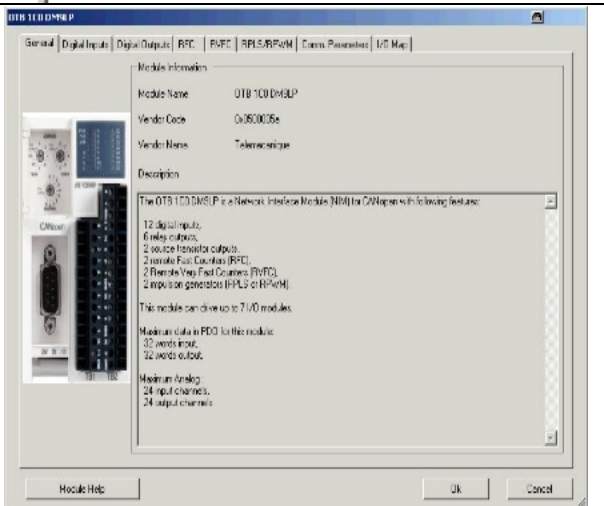
<p><b>3</b></p> <p>A startup screen is then displayed.</p> <p>The middle field is the configuration area in which the OTB and its extension modules are created.</p> <p>All known OTB modules and extensions appear on the right-hand side in the <b>Catalog Browser</b>.</p>	
<p><b>4</b></p> <p>Select the CANopen OTB used in our example,</p> <p><b>OTB 1CO DM9LP</b></p>	
<p><b>5</b></p> <p>The OTB now appears as a graphics picture in the central area.</p> <p>Right-click on the image to open up a pop-up menu and select:</p> <p><b>Configure module.</b></p>	
<p><b>6</b></p> <p>The window for the</p> <p><b>OTB 1CO DM9LP</b></p> <p>module opens and you are shown a general summary on the first page.</p>	

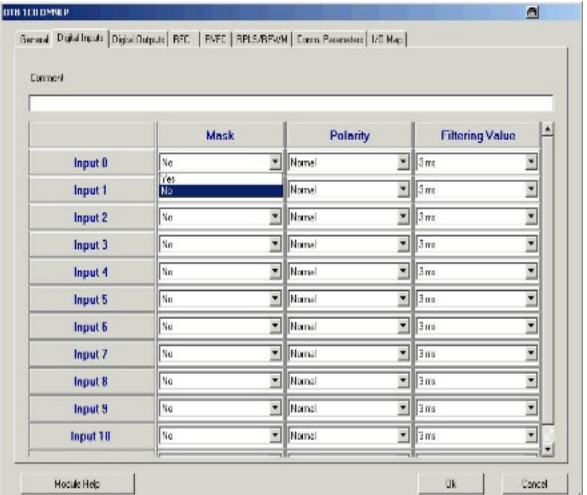
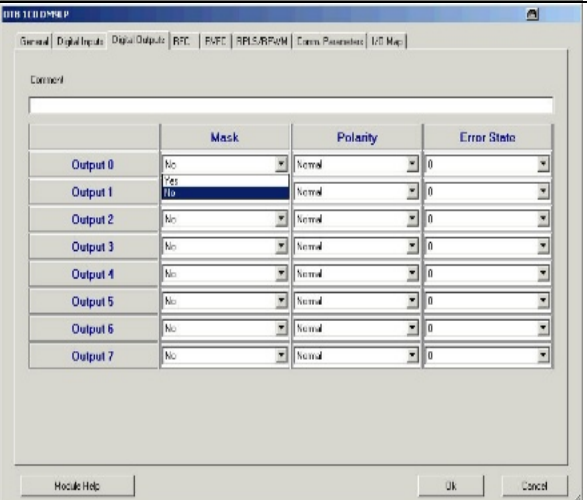
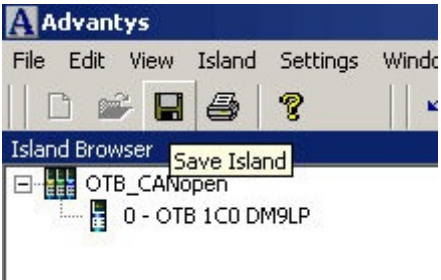
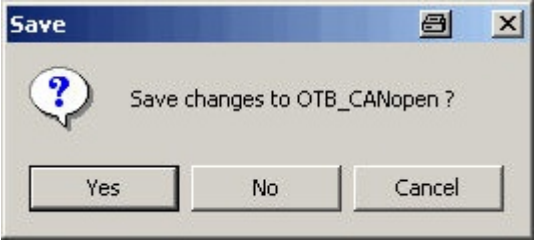
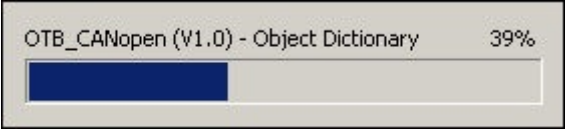

<p><b>7</b></p>	<p>The <b>Digital Inputs</b> tab allows you to define unused inputs.</p> <p>To do this, assign a <b>Yes</b> to the relevant bit (Input 0 = Bit 0, etc.) in the <b>Mask</b> column.</p> <p>Inputs marked <b>Yes</b> will not now be acquired.</p> <p>In our example, all inputs must be marked <b>No</b>.</p>	 <table border="1" data-bbox="890 271 1426 607"> <thead> <tr> <th></th> <th>Mask</th> <th>Polarity</th> <th>Filtering Value</th> </tr> </thead> <tbody> <tr><td>Input 0</td><td>No</td><td>Normal</td><td>3 ms</td></tr> <tr><td>Input 1</td><td>No</td><td>Normal</td><td>3 ms</td></tr> <tr><td>Input 2</td><td>No</td><td>Normal</td><td>3 ms</td></tr> <tr><td>Input 3</td><td>No</td><td>Normal</td><td>3 ms</td></tr> <tr><td>Input 4</td><td>No</td><td>Normal</td><td>3 ms</td></tr> <tr><td>Input 5</td><td>No</td><td>Normal</td><td>3 ms</td></tr> <tr><td>Input 6</td><td>No</td><td>Normal</td><td>3 ms</td></tr> <tr><td>Input 7</td><td>No</td><td>Normal</td><td>3 ms</td></tr> <tr><td>Input 8</td><td>No</td><td>Normal</td><td>3 ms</td></tr> <tr><td>Input 9</td><td>No</td><td>Normal</td><td>3 ms</td></tr> <tr><td>Input 10</td><td>No</td><td>Normal</td><td>3 ms</td></tr> </tbody> </table>		Mask	Polarity	Filtering Value	Input 0	No	Normal	3 ms	Input 1	No	Normal	3 ms	Input 2	No	Normal	3 ms	Input 3	No	Normal	3 ms	Input 4	No	Normal	3 ms	Input 5	No	Normal	3 ms	Input 6	No	Normal	3 ms	Input 7	No	Normal	3 ms	Input 8	No	Normal	3 ms	Input 9	No	Normal	3 ms	Input 10	No	Normal	3 ms
	Mask	Polarity	Filtering Value																																															
Input 0	No	Normal	3 ms																																															
Input 1	No	Normal	3 ms																																															
Input 2	No	Normal	3 ms																																															
Input 3	No	Normal	3 ms																																															
Input 4	No	Normal	3 ms																																															
Input 5	No	Normal	3 ms																																															
Input 6	No	Normal	3 ms																																															
Input 7	No	Normal	3 ms																																															
Input 8	No	Normal	3 ms																																															
Input 9	No	Normal	3 ms																																															
Input 10	No	Normal	3 ms																																															
<p><b>8</b></p>	<p>This is also the case for <b>Digital Outputs</b>.</p> <p>No modifications are required to any of the other tabs.</p> <p>Confirm with <b>OK</b>.</p>	 <table border="1" data-bbox="890 777 1426 1023"> <thead> <tr> <th></th> <th>Mask</th> <th>Polarity</th> <th>Error State</th> </tr> </thead> <tbody> <tr><td>Output 0</td><td>No</td><td>Normal</td><td>0</td></tr> <tr><td>Output 1</td><td>No</td><td>Normal</td><td>0</td></tr> <tr><td>Output 2</td><td>No</td><td>Normal</td><td>0</td></tr> <tr><td>Output 3</td><td>No</td><td>Normal</td><td>0</td></tr> <tr><td>Output 4</td><td>No</td><td>Normal</td><td>0</td></tr> <tr><td>Output 5</td><td>No</td><td>Normal</td><td>0</td></tr> <tr><td>Output 6</td><td>No</td><td>Normal</td><td>0</td></tr> <tr><td>Output 7</td><td>No</td><td>Normal</td><td>0</td></tr> </tbody> </table>		Mask	Polarity	Error State	Output 0	No	Normal	0	Output 1	No	Normal	0	Output 2	No	Normal	0	Output 3	No	Normal	0	Output 4	No	Normal	0	Output 5	No	Normal	0	Output 6	No	Normal	0	Output 7	No	Normal	0												
	Mask	Polarity	Error State																																															
Output 0	No	Normal	0																																															
Output 1	No	Normal	0																																															
Output 2	No	Normal	0																																															
Output 3	No	Normal	0																																															
Output 4	No	Normal	0																																															
Output 5	No	Normal	0																																															
Output 6	No	Normal	0																																															
Output 7	No	Normal	0																																															
<p><b>9</b></p>	<p>To save the configuration and create a portable EDS file, click on the icon with the floppy disk.</p> <p>The EDS file is saved to the <b>EDS</b> folder of the Advantys software.</p>																																																	
<p><b>10</b></p>	<p>Now close the Advantys window using the system exit.</p> <p>You are automatically prompted to save the changes.</p> <p>confirm with <b>Yes</b>.</p>																																																	
<p><b>11</b></p>	<p>The installation/save progress bar appears.</p>																																																	

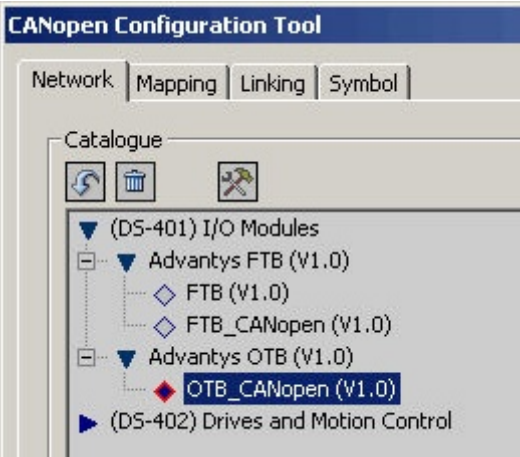
<p><b>11</b></p>	<p>Following the configuration process, the <b>CANopen Configuration Tool</b> re-appears.</p> <p>The OTB file that you have created now appears in the <b>Advantys OTB (V1.0)</b> entry.</p>	 <p>The screenshot shows the 'CANopen Configuration Tool' interface. At the top, there are four tabs: 'Network', 'Mapping', 'Linking', and 'Symbol'. Below the tabs is a 'Catalogue' section with three icons: a refresh icon, a trash icon, and a wrench icon. The catalogue is expanded to show a tree structure of modules:</p> <ul style="list-style-type: none"><li>(DS-401) I/O Modules<ul style="list-style-type: none"><li>Advantys FTB (V1.0)<ul style="list-style-type: none"><li>FTB (V1.0)</li><li>FTB_CANopen (V1.0)</li></ul></li><li>Advantys OTB (V1.0)<ul style="list-style-type: none"><li><b>OTB_CANopen (V1.0)</b> (highlighted with a red diamond)</li></ul></li></ul></li><li>(DS-402) Drives and Motion Control</li></ul>
------------------	--	--

# Advantys FTB

## Introduction



The Advantys FTB chapter describes how to configure the procedures required to add an FTB to the TwidoSoft.

## Preconditions

Before carrying out the steps described below, you must ensure the following:

- The TwidoSuite programming tool is installed on your PC
- The FTB.spa file must already be in the TwidoSuite configuration
- The Advantys tool is installed on your PC

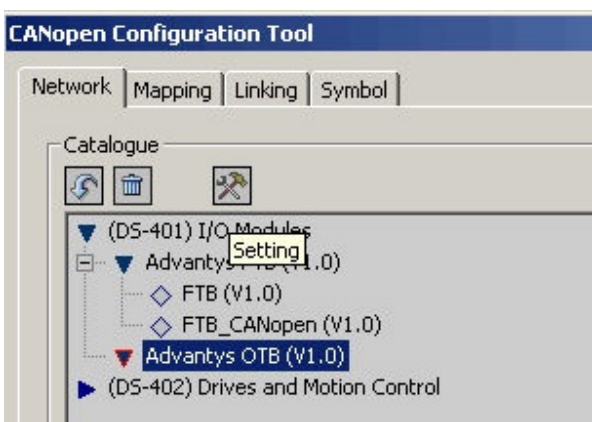
## Adding an FTB Island to Twidosuite

<p><b>1</b></p>	<p>In order to start Advantys from the TwidoSoft program, select <b>Advantys FTB</b> after the “*.spa” files have been loaded.</p> <p>Click on the icon with the hammer&amp;spanner to start the Advantys tool for the FTB.</p>	
<p><b>2</b></p>	<p>In the <b>New Island</b> dialog, assign a name.</p> <p>In our example this is <b>FTB_CANopen</b>.</p>	

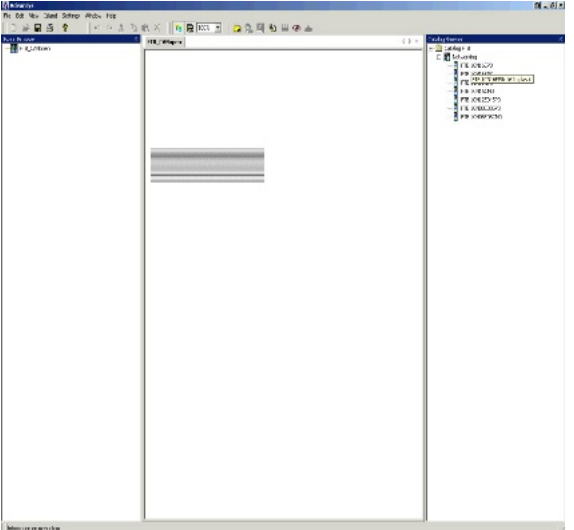
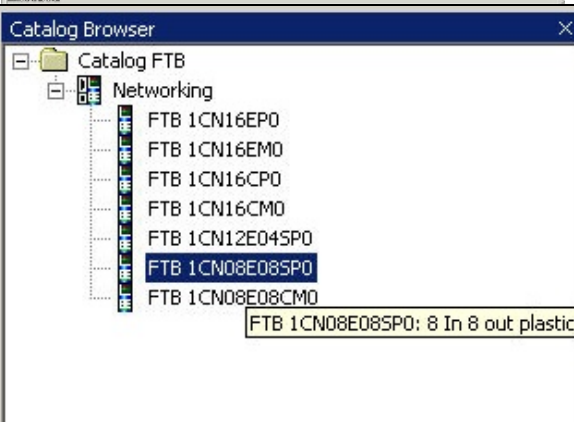
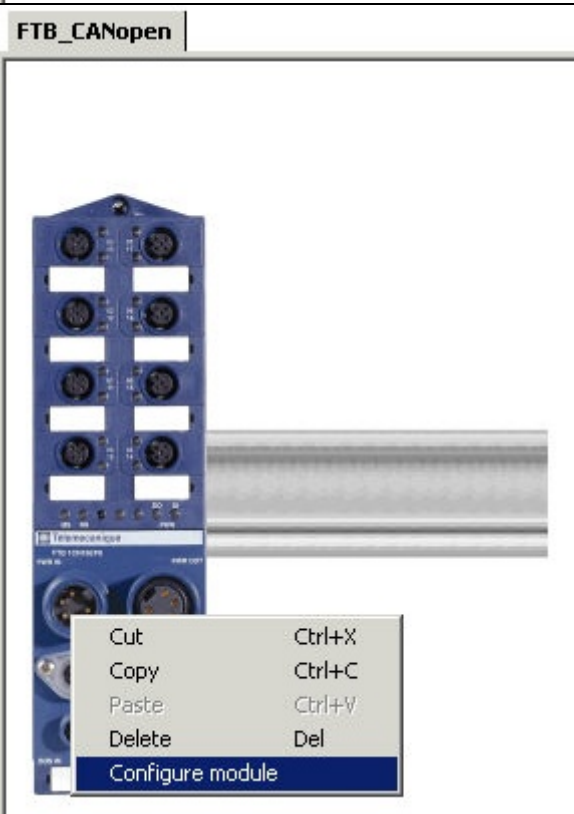
<p><b>3</b></p>	<p>A startup screen is then displayed.</p> <p>The middle field is the configuration area in which the OTB and its extension modules are created.</p> <p>All known OTB modules and extensions appear in the <b>catalog browser</b> on the right hand side.</p>	
<p><b>4</b></p>	<p>Select the CANopen FTB used in our example</p> <p><b>FTB1CN08E08SPO</b></p>	
<p><b>5</b></p>	<p>The FTB now appears as a graphic image in the central area.</p> <p>Right-click on the image and in the pop-up menu, select</p> <p><b>Configure module</b></p>	

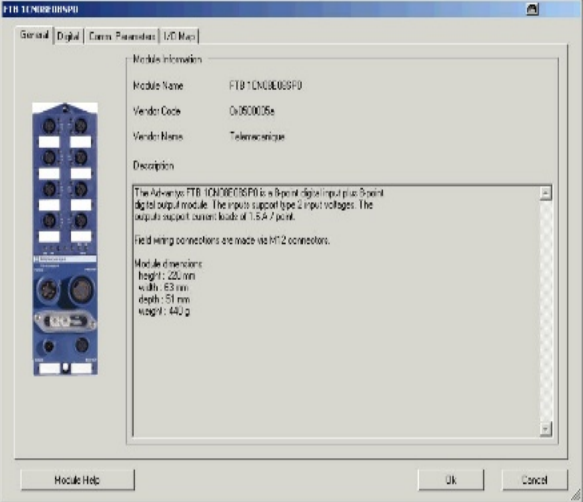
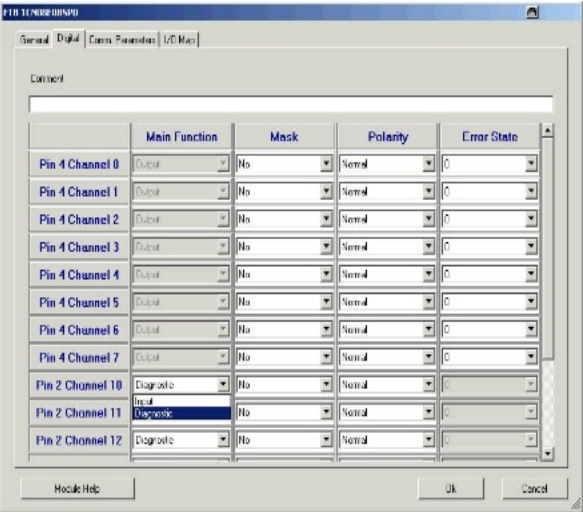
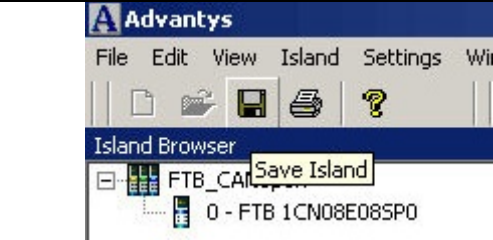
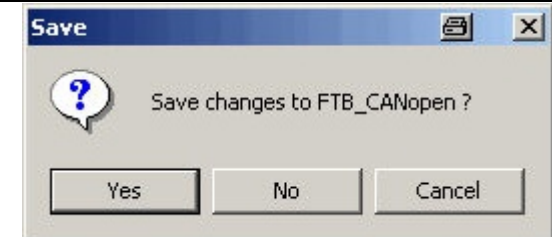
<p><b>6</b></p>	<p>The dialog for the <b>FTB1CN08E08SPO</b> module opens and displays a general summary on the first page.</p>																																																													
<p><b>7</b></p>	<p>The <b>Digital</b> tab allows you to mask unused inputs.</p> <p>To do this, assign a <b>Yes</b> to the relevant channel in the <b>Mask</b> list.</p> <p>Inputs with a <b>Yes</b> will not be acquired.</p> <p>In our example, all inputs must remain at <b>No</b>.</p> <p>In addition, you can determine here whether the eight inputs definable with <b>FTB1CN08E08SPO</b> should be used as inputs or as diagnostics.</p>	 <table border="1" data-bbox="890 857 1422 1198"> <thead> <tr> <th></th> <th>Main Function</th> <th>Mask</th> <th>Polarity</th> <th>Error State</th> </tr> </thead> <tbody> <tr><td>Pin 4 Channel 0</td><td>Output</td><td>No</td><td>Normal</td><td>0</td></tr> <tr><td>Pin 4 Channel 1</td><td>Output</td><td>No</td><td>Normal</td><td>0</td></tr> <tr><td>Pin 4 Channel 2</td><td>Output</td><td>No</td><td>Normal</td><td>0</td></tr> <tr><td>Pin 4 Channel 3</td><td>Output</td><td>No</td><td>Normal</td><td>0</td></tr> <tr><td>Pin 4 Channel 4</td><td>Output</td><td>No</td><td>Normal</td><td>0</td></tr> <tr><td>Pin 4 Channel 5</td><td>Output</td><td>No</td><td>Normal</td><td>0</td></tr> <tr><td>Pin 4 Channel 6</td><td>Output</td><td>No</td><td>Normal</td><td>0</td></tr> <tr><td>Pin 4 Channel 7</td><td>Output</td><td>No</td><td>Normal</td><td>0</td></tr> <tr><td>Pin 2 Channel 10</td><td>Diagnostic Input</td><td>No</td><td>Normal</td><td>0</td></tr> <tr><td>Pin 2 Channel 11</td><td>Diagnostic Input</td><td>No</td><td>Normal</td><td>0</td></tr> <tr><td>Pin 2 Channel 12</td><td>Diagnostic Input</td><td>No</td><td>Normal</td><td>0</td></tr> </tbody> </table>		Main Function	Mask	Polarity	Error State	Pin 4 Channel 0	Output	No	Normal	0	Pin 4 Channel 1	Output	No	Normal	0	Pin 4 Channel 2	Output	No	Normal	0	Pin 4 Channel 3	Output	No	Normal	0	Pin 4 Channel 4	Output	No	Normal	0	Pin 4 Channel 5	Output	No	Normal	0	Pin 4 Channel 6	Output	No	Normal	0	Pin 4 Channel 7	Output	No	Normal	0	Pin 2 Channel 10	Diagnostic Input	No	Normal	0	Pin 2 Channel 11	Diagnostic Input	No	Normal	0	Pin 2 Channel 12	Diagnostic Input	No	Normal	0
	Main Function	Mask	Polarity	Error State																																																										
Pin 4 Channel 0	Output	No	Normal	0																																																										
Pin 4 Channel 1	Output	No	Normal	0																																																										
Pin 4 Channel 2	Output	No	Normal	0																																																										
Pin 4 Channel 3	Output	No	Normal	0																																																										
Pin 4 Channel 4	Output	No	Normal	0																																																										
Pin 4 Channel 5	Output	No	Normal	0																																																										
Pin 4 Channel 6	Output	No	Normal	0																																																										
Pin 4 Channel 7	Output	No	Normal	0																																																										
Pin 2 Channel 10	Diagnostic Input	No	Normal	0																																																										
Pin 2 Channel 11	Diagnostic Input	No	Normal	0																																																										
Pin 2 Channel 12	Diagnostic Input	No	Normal	0																																																										
<p><b>8</b></p>	<p>To save the configuration, simply press the button with the floppy disk icon.</p> <p>Now close the window using the system exit.</p>																																																													
<p><b>9</b></p>	<p>You are now prompted to save the changes to "FTB_CANopen".</p> <p>Confirm with <b>Yes</b> and the installation progress bar appears.</p>																																																													

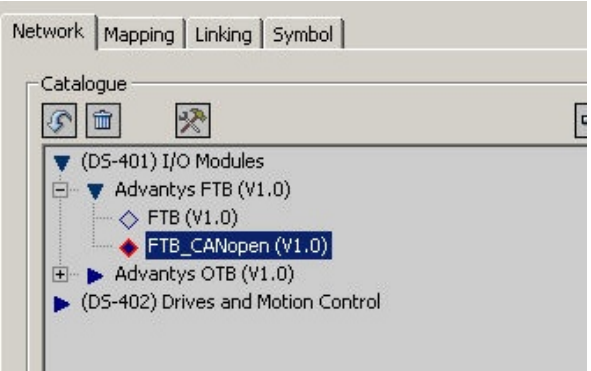
<b>10</b>	<p>Following the configuration process, the CANopen Configuration Tool re-appears.</p> <p>The FTB file “FTB_CANopen” that you have created now appears in the Advantys FTB (V1.0) directory.</p>	 <p>The screenshot shows the 'Network' tab of the configuration tool. The 'Catalogue' pane on the left displays a tree structure of modules. Under '(D5-401) I/O Modules', the 'Advantys FTB (V1.0)' directory is expanded, showing 'FTB (V1.0)' and 'FTB_CANopen (V1.0)'. The 'FTB_CANopen (V1.0)' file is highlighted with a blue selection bar. Other visible items include 'Advantys OTB (V1.0)' and '(D5-402) Drives and Motion Control'.</p>
-----------	--	--

# Altivar 31

## Introduction

The ATV31 Devices chapter describes how to initialize and parameterize the Altivar ATV31 devices in order to fulfill the system functionality described above.

PowerSuite software is used to initialize and parameterize the devices.

## General

The ATV31 parameters can also be entered or modified via the front panel. The advantages of using PowerSuite are that you

- Can save the data on your PC and copy it as you wish
- Can print out the documentation *and*
- Can be assisted in optimizing the parameters online.

## PowerSuite with ATV31

The Parameters can be configured with the Powersuite configuration software. Here, the configuration was done using Powersuite V2.3

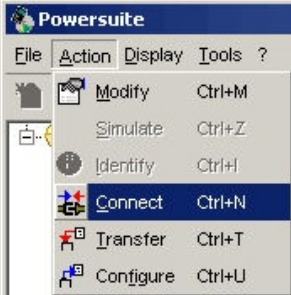
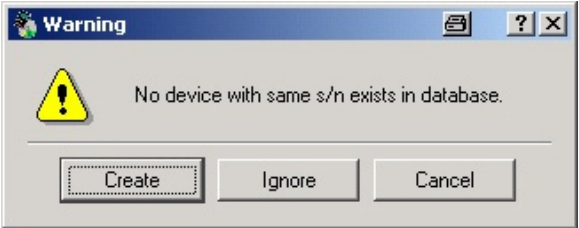
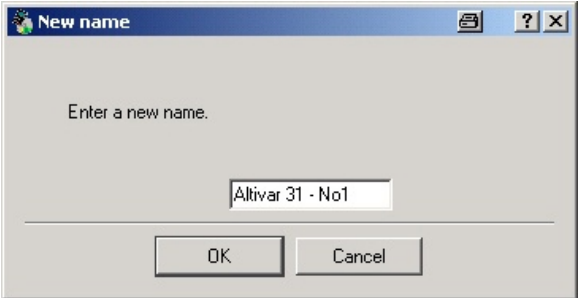
<p><b>1</b></p>	<p>After starting Powersuite, select the entry</p> <p><b>Example- folder</b></p>	
<p><b>2</b></p>	<p>Via the menu</p> <p><b>Action→ Connect</b></p> <p>try to connect to the device.</p> <p>Note: make sure the device is connected with thye proper cable.</p>	
<p><b>3</b></p>	<p>It will be confirmed that you are trying to connect to a new device.</p> <p>Click on <b>Create</b> to continue.</p>	
<p><b>4</b></p>	<p>In the <b>New name</b> dialog give the configuration for the device a name.</p>	

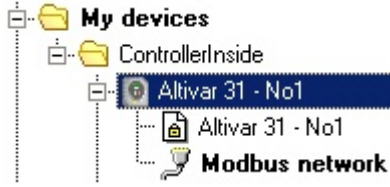
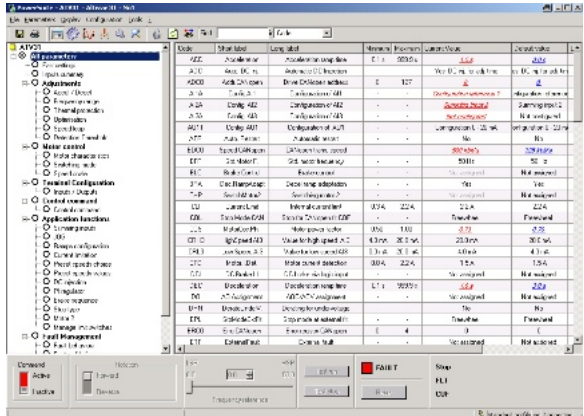

5	You will see a progress bar as the data is read from the altivar 31 device.																															
6	When the transfer is complete, the device data is displayed.	 <p><b>Characteristics</b></p> <table border="1" data-bbox="900 770 1430 1030"> <tr> <td><b>Reference</b></td> <td>ATV71H075N4*</td> </tr> <tr> <td><b>Nominal power</b></td> <td>0,75 kW</td> </tr> <tr> <td><b>Supply Voltage</b></td> <td>380 / 480 V</td> </tr> <tr> <td><b>Maximum transient current</b></td> <td>3,5 A</td> </tr> <tr> <td><b>Continuous output current</b></td> <td>2,3 A</td> </tr> </table> <p><b>Structure</b></p> <table border="1" data-bbox="884 1088 1439 1214"> <thead> <tr> <th>Card</th> <th>Reference</th> <th>Serial number</th> <th>Version</th> <th>Vendor name</th> </tr> </thead> <tbody> <tr> <td>Device</td> <td>ATV31H037N4</td> <td>XXX5 11 C21 076</td> <td>V. 2IE03</td> <td>TELEMECANIQUE</td> </tr> <tr> <td>Control Board</td> <td></td> <td>XXXYYMMNN</td> <td>V. 2IE03</td> <td>TELEMECANIQUE</td> </tr> <tr> <td>HMI Board</td> <td>VX4A311/312(A)</td> <td>XXXYYMMNN</td> <td>V. 1IE02</td> <td>TELEMECANIQUE</td> </tr> </tbody> </table>	<b>Reference</b>	ATV71H075N4*	<b>Nominal power</b>	0,75 kW	<b>Supply Voltage</b>	380 / 480 V	<b>Maximum transient current</b>	3,5 A	<b>Continuous output current</b>	2,3 A	Card	Reference	Serial number	Version	Vendor name	Device	ATV31H037N4	XXX5 11 C21 076	V. 2IE03	TELEMECANIQUE	Control Board		XXXYYMMNN	V. 2IE03	TELEMECANIQUE	HMI Board	VX4A311/312(A)	XXXYYMMNN	V. 1IE02	TELEMECANIQUE
<b>Reference</b>	ATV71H075N4*																															
<b>Nominal power</b>	0,75 kW																															
<b>Supply Voltage</b>	380 / 480 V																															
<b>Maximum transient current</b>	3,5 A																															
<b>Continuous output current</b>	2,3 A																															
Card	Reference	Serial number	Version	Vendor name																												
Device	ATV31H037N4	XXX5 11 C21 076	V. 2IE03	TELEMECANIQUE																												
Control Board		XXXYYMMNN	V. 2IE03	TELEMECANIQUE																												
HMI Board	VX4A311/312(A)	XXXYYMMNN	V. 1IE02	TELEMECANIQUE																												
7	You can view the parameter in list form or ...																															

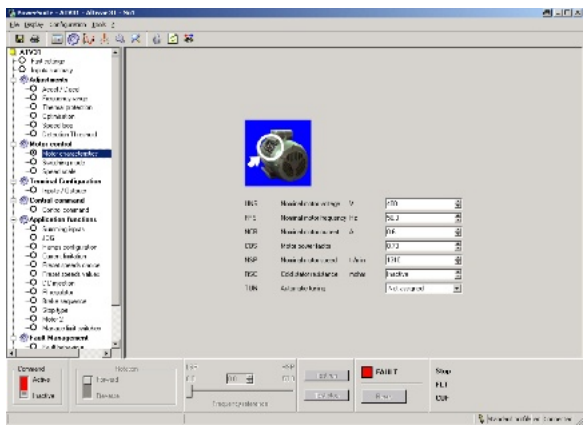
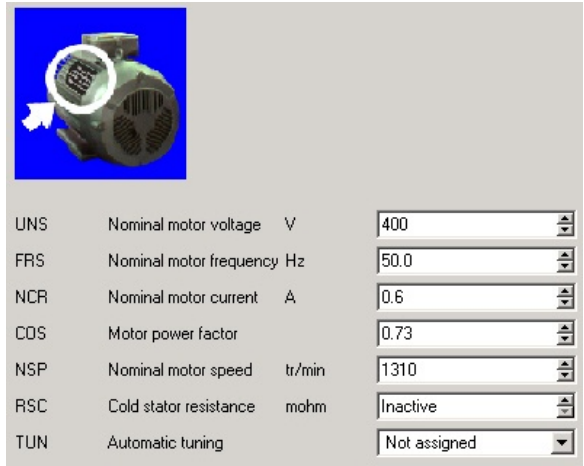
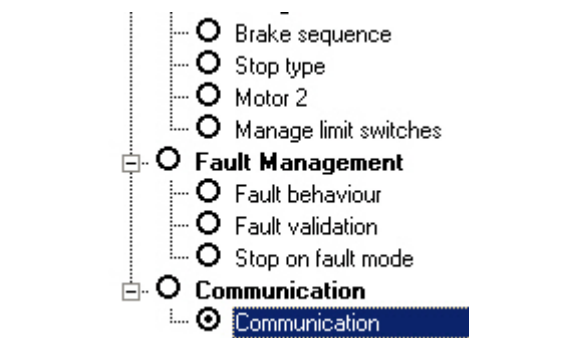
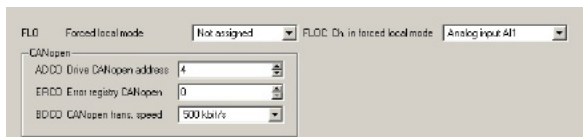
<p>8</p>	<p>... in an input mask which can be viewed via:</p> <p><b>Adjustments-&gt; Motor control -&gt; Motor Characteristics</b></p>																													
<p>9</p>	<p>Enter the Motor data of the type of motors used.</p>	 <table border="1" data-bbox="863 864 1450 1122"> <tr> <td>UNS</td> <td>Nominal motor voltage</td> <td>V</td> <td>400</td> </tr> <tr> <td>FRS</td> <td>Nominal motor frequency</td> <td>Hz</td> <td>50.0</td> </tr> <tr> <td>NCR</td> <td>Nominal motor current</td> <td>A</td> <td>0.6</td> </tr> <tr> <td>COS</td> <td>Motor power factor</td> <td></td> <td>0.73</td> </tr> <tr> <td>NSP</td> <td>Nominal motor speed</td> <td>tr/min</td> <td>1310</td> </tr> <tr> <td>RSC</td> <td>Cold stator resistance</td> <td>mohm</td> <td>Inactive</td> </tr> <tr> <td>TUN</td> <td>Automatic tuning</td> <td></td> <td>Not assigned</td> </tr> </table>	UNS	Nominal motor voltage	V	400	FRS	Nominal motor frequency	Hz	50.0	NCR	Nominal motor current	A	0.6	COS	Motor power factor		0.73	NSP	Nominal motor speed	tr/min	1310	RSC	Cold stator resistance	mohm	Inactive	TUN	Automatic tuning		Not assigned
UNS	Nominal motor voltage	V	400																											
FRS	Nominal motor frequency	Hz	50.0																											
NCR	Nominal motor current	A	0.6																											
COS	Motor power factor		0.73																											
NSP	Nominal motor speed	tr/min	1310																											
RSC	Cold stator resistance	mohm	Inactive																											
TUN	Automatic tuning		Not assigned																											
<p>10</p>	<p>In the entry</p> <p><b>Communication</b></p> <p>enter the <b>CANopenAddress</b> (for this application 1 to 4) and select :</p> <p><b>Baudrate: 500 kbit/s.</b></p>	 <ul style="list-style-type: none"> <li><input type="radio"/> Brake sequence</li> <li><input type="radio"/> Stop type</li> <li><input type="radio"/> Motor 2</li> <li><input type="radio"/> Manage limit switches</li> <li><input checked="" type="radio"/> <b>Fault Management</b> <ul style="list-style-type: none"> <li><input type="radio"/> Fault behaviour</li> <li><input type="radio"/> Fault validation</li> <li><input type="radio"/> Stop on fault mode</li> </ul> </li> <li><input checked="" type="radio"/> <b>Communication</b> <ul style="list-style-type: none"> <li><input checked="" type="radio"/> <b>Communication</b></li> </ul> </li> </ul>  <table border="1" data-bbox="863 1581 1450 1720"> <tr> <td>FLD</td> <td>Forced local mode</td> <td>Not assigned</td> <td>FLOD Ch in forced local mode</td> <td>Analog input All</td> </tr> <tr> <td colspan="5">CANopen</td> </tr> <tr> <td>ADD0</td> <td>Drive CANopen address</td> <td>4</td> <td colspan="2"></td> </tr> <tr> <td>ERR0</td> <td>Error registry CANopen</td> <td>0</td> <td colspan="2"></td> </tr> <tr> <td>BDD0</td> <td>CANopen items speed</td> <td>500 kbit/s</td> <td colspan="2"></td> </tr> </table>	FLD	Forced local mode	Not assigned	FLOD Ch in forced local mode	Analog input All	CANopen					ADD0	Drive CANopen address	4			ERR0	Error registry CANopen	0			BDD0	CANopen items speed	500 kbit/s					
FLD	Forced local mode	Not assigned	FLOD Ch in forced local mode	Analog input All																										
CANopen																														
ADD0	Drive CANopen address	4																												
ERR0	Error registry CANopen	0																												
BDD0	CANopen items speed	500 kbit/s																												

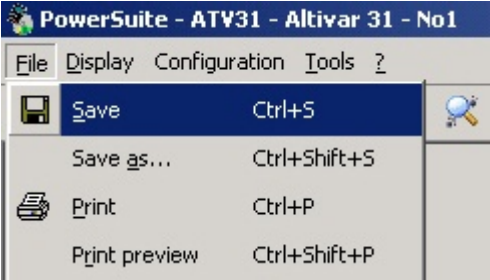
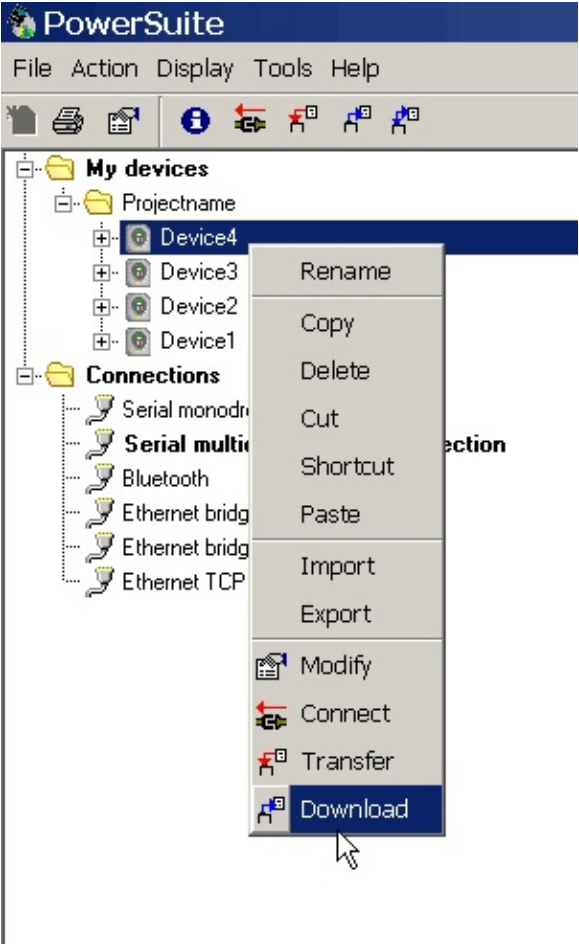
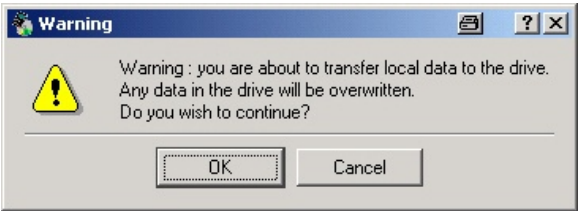
11	<p><b>Save the data..</b></p>	
12	<p>To transfer the new parameters to an individual device, right mouse click on the entry for the device and select:</p> <p><b>download</b></p> <p>in the pop-up menu.</p>	
13	<p>Confirm the warning message with <b>OK</b> .</p>	

## Manual Input using the Altivar Front Panel

You can configure the ATV 31 by inputting the parameters using the front panel display and buttons on each Altivar, as follows:

<p><b>1</b> The CANopen-Address and Baudrate can be input using the buttons on the front panel of the Altivar.</p>	
<p><b>2</b> Using the buttons on the front panel, select the sub-menu <b>Communication</b> auszuwählen.</p>	
<p><b>3</b> In the <b>Communication</b> sub-menu input the CANopen address in the parameter <b>AdC0</b>. In the example application the addresses for the four controllers are 1 to 4.</p>	
<p><b>4</b> Also in the <b>Communication</b> sub-menu, in the parameter <b>BdC0</b>, set the baudrate to <b>500.0</b> (kBits).</p>	
<p><b>5</b> Alternatively you can use the PowerSuite software to configure the CANopen addresses and baudrates.</p>	
<p><b>6</b> To activate the downloaded bus parameters (address and baudrate) you must now switch off the controller (display goes off). On switching back on, the new parameters are ready.</p>	

# Performance

---

## **Scan time and cycle time**

A cycle time of 2 ms was not exceeded with the present configuration including the required application code. The memory utilization of the Twido PLC specified and used in this SMD was 7% for system data and 2% for the logic component.

Trials with additional integrated extension modules (a digital I/O module with 16 inputs and 8 relay outputs as well as an analog module with 1 output and 2 inputs, which was used as the I/O level for 2 PID controllers) showed that the cycle time could be increased to a maximum of 6 ms. When using these two additional extension modules, memory usage for system data rose to 22% but, as expected, memory usage of the logic component did not change.

---

## Appendix

### Detailed Component List

<b>Hardware components – Group 1: Master switch</b>				
Item	Qty	Description	Part no.	Rev./Vers.
1.1	1	3-pole VARIO master switch, 10A at 400V	VCF02GE	
1.2	opt	Optional: E-OFF master switch 3-pole 25A with 400V Door mounting	VCD0	
1.3	1	Additional module protective conductor 10...32A	VZ14	
1.4	1	Additional module neutral conductor 10...32A	VZ11	

<b>Hardware components – Group 2: Safety</b>				
Item	Qty	Description	Part no.	Rev./Vers.
2.1	2	Emergency-off switch with overload protection	XALK178-G	
2.2	opt	<b>Optional:</b> E-OFF switch, tamper free + extra auxiliary switch block, door mounting	XB5AS8445+ ZBE102	
2.3	1	Safety light curtain 0.3...9m 35cm high	XUSLTR5A0350	
2.4	1	Receiver extension 10m	XSZTCR10	
2.5	1	Transmitter extension 10m	XSZTCT10	
2.6	1	Safety limit switch 2 N/C	XCSP1751	
2.7	2	OSIswitch position switch with roller tappet, lateral startup direction	XCKD2121P16	
2.8	3	Preventa safety relay 24V	XPSAK311144P	
2.9	8	Load contactor Tesys model D 4KW at 400V	LC1D093BD	
2.10	3	ACK and safety indicator pushbutton activated (blue)	XB5AW-363	
2.11	3	Single-pushbutton housing	XALD01	
2.12	5	Auxiliary switch block "N/O"	ZBE-101	
2.13	3	Lamp holder with LED 24V (white)	ZBV-B1	
2.14	3	Attachment flange	ZB5-AZ009	

<b>Hardware components – Group 3: Display and signaling</b>				
Item	Qty	Description	Part no.	Rev./Vers.
3.1	1	Indicator bank, connection element	XVBC12	
3.2	1	Connection element + cover	XVBC21	
3.3	1	Signal element green LED 24 VDC	XVBC2B3	
3.4	1	Signal element red LED 24 VDC	XVBC2B4	
3.5	1	Signal element yellow LED 24 VDC	XVBC2B8	
3.6	1	Colour Markings set	XVBC22	

<b>Hardware components – Group 4: Control components</b>				
Item	Qty	Description	Part no.	Rev./Vers.
4.1	1	Twido modular device	TWDLMDA20DRT	V1.0
4.2	1	CanOpen card	TWDNCO1M	V1.03
4.3	1	CanOpen plug second contact	TSX CANKCDF90TP	
4.4	4	CanOpen plug normal	TSX CANKCDF90T	
4.5	1	CANopen cable 50 m	TSXCANCA50	
4.6	2	CANopen junction box	VW3CANTAP2	
4.7	4	CAN bus connection cable 1 m	VW3CANCARR1	
4.8	1	Twido input card 8 digital inputs	TWDDDI8DT	

<b>Hardware components – Group 5: Magelis HMI</b>				
Item	Qty	Description	Part no.	Rev./Vers.
5.1	1	Magelis panel XBT-GT1100, without Ethernet	XBTGT1100	V1.0
5.2	1	Interface cable to Twido	XBTZ9780	

<b>Hardware components – Group 6: 24 V power supplies</b>				
Item	Qty	Description	Part no.	Rev./Vers.
6.1	1	Primary fuse C60N, 2P, 3A	24518	
6.2	1	Power supply 240 VAC 1-phase, 24VDC10A	ABL7RE2410	
6.3	14	Secondary fuse C60N 1P 1A B curve (3 per OTB, 1x Twido, 1x Twido expansion)	24045	
6.4	1	Secondary fuse C60N 1P 2A B curve (1x Twido inputs and outputs)	24046	
6.5	2	Secondary fuse C60N 1P 4A (1x power supply for FTBs, 1x power supply for H2-H4 field)	24173	

<b>Hardware components – Group 7: Variable speed drives and load components</b>				
Item	Qty	Description	Part no.	Rev./Vers.
7.1	4	Motor circuit breaker GV2 4,0A	GV2L08	
7.2	4	Motor circuit breaker auxiliary contact GV2	GV2AE11	
7.3	4	0.37 kW 3-phase AC variable speed drive	ATV31H037N4	1.2
7.4	2	ATV31 attachment plate for mounting on DIN rail	VW3A31852	



<b>Hardware components – Group 8: Advantys OTB FTB</b>				
Item	Qty	Description	Part no.	Rev./Vers.
8.1	4	OTB distributed I/O	OTB1CODM9LP	
8.2	4	FTB I/O systems in block version IP67 8 inputs/8 outputs/diagnostic	FTB1CN08E08SP O	
8.3	1	Terminating resistor CANopen M12 IP67	FTXCNTL12	
8.4	3	FTB connection cable CANopen with M12 plug IP67 0.6m	FTXCN3206	
8.5	3	FTB connection cable 24V with 7/8 plug IP67 0.6m	FTXDP2206	
8.6	1	FTB connection cable 24V with 7/8 plug and one free end IP67 3m	FTXDP2130	
8.7	1	FTB connection cable CANopen with M12 plug IP67 and one free end 3m	FTXCN3230	
8.8	1	Cover cap 7/8 metal IP67	FTXC78B	
8.9	3	Cover cap M12 plastic IP67 (10 units)	FTXCM12B	

<b>Hardware components – Group 9: Sensors</b>				
Item	Qty	Description	Part no.	Rev./Vers.
9.1	5	Photo barrier	XUB 1APANM12	
9.2	5	Reflectors 50x50	XUZC50	
9.3	5	Plastic fastener for photo barrier sensor	XUZA218	
9.4	4	Proximity sensor inductive 3-wire	XS608B1PAM12	
9.5	4	Attachment flange 8mm	XSZ B108	
9.6	9	Sensor connection cable 5m Preconfigured with M12 plug	XZCP1264L2	
9.7	9	Plug for connection to FTB	XZCC12FDM40B	

<b>Hardware components – Group 10: TeSysU</b>				
Item	Qty	Description	Part no.	Rev./Vers.
10.1	2	Tesys U power base	LUB12	
10.2	2	Tesys U reversing contactor combination 12A 24V DC	LU2B12BL	
10.3	2	Auxiliary switch 1"N/C" 1"N/O"	LUA1C11	
10.5	2	Control unit 1.25....5A 24 V DC VSD module auxiliary switch 1"N/C" 1"N/O"	LUCA05BL LUFN11	

<b>Hardware components – Group 11: Buttons and switches</b>				
Item	Qty	Description	Part no.	Rev./Vers.
11.1	6	Modular housing Style 5 with Harmony buttons (Run/Stop/Reverse) complete IP66	XALD324	
11.2	1	Modular housing Style 5 empty	XALD04	
11.3	1	Harmony button “I” green (Start)	ZB5AA331	
11.4	1	Harmony button “O” red (Stop)	ZB5AA434	
11.5	1	Harmony button, with light, white (Manual mode)	ZB5AW313	
11.6	6	Auxiliary switch block “N/C”	ZBE102	
11.7	6	Auxiliary switch block “N/O”	ZBE101	
11.8	3	Lamp holder with LED 24V (white)	ZBVB1	
11.9	6	Attachment flange	ZB5AZ009	

<b>Software components – Group 12</b>				
Item	Qty	Description	Part no.	Rev./Vers.
12.1	1	TwidoSuite programming software	TWD BTU10EF	1.00
12.2	1	Twido programming cable serial	TSXPCX1031	
12.3	opt.	Twido programming cable USB	TSXPCX3030	
12.4	1	Programming software for Magelis XBT-GT	VJDSSDTGGSV43M	4.4
12.5	1	Magelis programming cable	XBTZG915	
12.6	1	PowerSuite ATV31 parameterization software	VW3A8104	
12.7	1	Altivar set of connection accessories	VW3A8106	
12.8	1	Advantys configuration tool	Advantys	2.0

<b>Cabinet Components – Group 13 (SAREL)</b>				
Item	Qty	Description	Part no.	Rev./Vers.
13.1	1	Cabinet, 800x600x300mm (HxWxD, with Mounting plate, Sarel)	ENN83357	
13.2	2	Cabinet, 300x300x250mm (HxWxD, with Mounting plate, Sarel)	ENN83303	
13.3	1	Cabinet, 600x600x300mm (HxWxD, with Mounting plate, Sarel)	ENN83330	
13.4	3	Filter Fan, 230V, 56 m³/h (Sarel)	ENN17901	
13.5	3	Filter for Fan (Sarel)	ENN17911	
13.6	2	Thermostat for filter fan, 0..60°C (Sarel)	ENN17562	

## Component Protection Classes

**Positioning  
Protection  
Class**

Component	In Field, on Site			Cabinet		
	IP54	IP65	IP67	Front		inside
				IP55	IP65	IP20
Master switch in housing		X				
Emergency-off switch housing XALK		X				
Preventa modules XPAK311144P						X
Contactors, LC1D093BD, 3-pole AC 3, 1x N/O + 1x N/C						X
Safety light curtain compact model		X				
Safety limit switch			X			
Osiswitch position switch			X			
Indicator bank with all components					X	
Illuminated pushbuttons and lamps, all colors, flat					X	
Motor protection switch, all types and ratings						X
Phaseo power supplies 24 V DC, 20 A						X
Proximity sensors, all types			X			
Photo barriers, all types			X			
Twido PLC components						X
CANopen taps with CAN cable						X
Advantys OTB for CANopen						X
Advantys FTB for CANopen			X			
Altivar 31 variable speed drive, 3-phase power supply 380/500 V AC, all rating classes						X
Magelis XBTGT touch panel, all versions					X	

# Component Features

---

## Components **Twido PLC**

The PLC used in this example comprises the power base of a Twido modular PLC and a programming set comprising software and a programming cable:

- 24 V DC
- 12 digital inputs
- 8 digital relay outputs
- Can be extended up to a maximum of 7 modules (analog and communication modules are also possible)

Three programming languages:

- Ladder Language (LD)
- Instruction List (IL)
- Sequential Function Chart/Grafcet (SFC)

Predefined functions:

- Drum controller
- High-speed counter up to 5 kHz
- Very high-speed counter up to 20 kHz
- Frequency meter 1 to 20 kHz
- Register areas for LIFO/FIFO execution
- PWM/PCS output
- External PLC start
- PID controller



## **CANopen master module TWDNCO1M**

Master interface module for Twido PLCs with the following technical specifications:

- Management of max. 16 slaves
- Baud rates supported 125/250/500 kbps
- Slave monitoring with NodeGuarding or Heartbeat
- Configuration tool integrated in TwidoSoft
- Bus parameterization via bus backplane module on PLC
- Integrated macros for rapid startup



Advantages when integrating or replacing module

- Slimline design
- Plug-in contacts
- PLC sends configuration every time the power supply is connected

## Components Contd.

### 8 x digital IN module TWDDDI8DT

Interface module for Twido PLCs with the following technical specifications:

- Bus parameterization via bus backplane module on PLC
- Integrated macros for rapid startup
- 8-channel input
- Removable screw terminal block

Advantages when integrating or replacing module

- Slimline design
- Plug-in contacts
- PLC sends configuration every time the power supply is connected

TWDDDI8DT



### Preventa safety relays XPSAK331144P

- Safety block for monitoring emergency-off circuits, position switches, BWS systems, safety shut-off mats and connecting blocks
- Category 4 to EN 954-1
- 24V DC/240V AC
- 3+1 safety-oriented switching contacts
- 4 semiconductor output for PLC
- Emergency-off monitoring in accordance with EN418 and EN60204-1



### Light curtain compact model XUSLTR5A0350

- With static outputs
- Detection capacity 30mm
- Switching distance 0.3...9m (20m also available)
- Response time 20ms
- Approvals: CE, TÜV, UL, CSA



**Components  
Contd.**

**Safety limit switch type TCSPL751**

- Convertible operating head
- Devices with 1 or 2 wiring configurations
- Tap hole PG11
- IP 67 in accordance with IEC 60529
- Operation: -25...+70°C Storage: -40...+70°C
- Approvals: UL, CSA, BG



**Phaseo power supply unit: ABL7RE2410**

- 100..240V AC/24V DC
- 10A secondary
- Slimline design
- Parallel connection possible
- Short-circuit-proof and protected against overload
- Approvals: UL, CSA, TÜV, Ctick (ABL7UPS: cULus, cRLus)



**OTB distributed I/O OTB1CODM9LP**

- Up to 7 expansion modules can be connected
- Very compact
- 12 digital inputs integrated
- 8 digital outputs integrated



**Performance  
Contd.**

**Advantys FTB I/O module**

- Suitable for use in harsh environments
- Also available with metal housing for extreme environments
- Communication possible via CANopen, DeviceNet, Profibus-DP or Interbus
- Combined input/output module
- Diagnostic state information via LEDs and via the bus for each channel and for the module so that faults can be pinpointed
- Possible to connect Desina sensors with integrated diagnostic function
- Outputs protected against short-circuits and overvoltages
- Temperature range: 0..+ 55°C
- Approvals: UL Listed



**Altivar VSD: ATV31H037N4**

- 0.37 kW, 380..500V AC three-phase
- Integrated class B EMC filter
- Temperature range: - 10..+ 50°C
- Speed range from 1 to 20 (0 to 200 Hz)
- Speed control with flow vector check
- Operation via Modbus or CANopen possible
- 2 analog inputs plus 1 analog output
- 6 digital inputs
- 2 or 3 digital status outputs possible
- Protection of drive and motor
- Compact design, side-by-side installation also possible on a DIN rail using bracket VW3A11852
- Approvals: UL, CSA, NOM 117, C-Tick

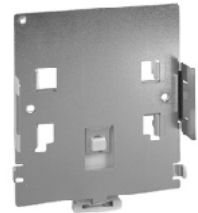



**Performance  
Contd.**

**TeSys U-line module contactor**

- Protection and switching of single or three-phase motors
- Protection against overcurrents, short-circuits and thermal overload
- Modules can be mounted safely and easily by snapping them onto the power base
- Power base for one or two directions of rotation
- Various control units, e.g., for application monitoring (running time, number of errors, motor-current values), log (error memory), alarms
- Communication modules for parallel wiring, AS-i and Modbus; FIPIO, Profibus-DP, DeviceNet also possible, for example, if gateway modules are used
- Use of additional auxiliary switches supported
- Temperature range: -25..+ 70°C (multifunctional control unit up to +55°C)
- Approvals: UL, CSA



**Motor contactor LC1D093BD TeSys Model D contactors**

- Up to 75 kW at 400 V, AC-3
- Integrated quick-acting auxiliary switch, 1 N/C contact, 1 N/O contact
- Various operating voltages, even with low power consumption
- Additional auxiliary-switch blocks can be mounted
- Approvals: UL, CSA



**Motor Protection Switch GV2-L08**

- Magnetic Activation as protection against short circuits
- Rotation switch can be door mounted
- Lockable
- Temperature range: - 25..+ 70°C
- Certificates UL, CSA, TSE, BV, GL, LROS, DNV



**XAL-K pushbutton housing: EMERGENCY-OFF  
pushbutton**

- Housing for 1-5 front elements, each able to accommodate a maximum of 3 auxiliary-switch blocks
- Can be mounted on front element or in housing base
- Front elements can be labeled however you want
- Approvals: UL Listed, CSA



## Performance Contd.

### Emergency Off master switch in housing VFC02GE

- 3-pole switch disconnecter, from 10A to 140A, with rotary drive, in accordance with IEC 947-4-1 and IEC 204
- Lockable handle (supplied without padlocks)
- Housing IP65 protection, lead-sealable and lockable
- Locking of housing cover in switch position "I" (ON) up to 63A



### Position switch OSIswitch XCKD2121P16

- Operation: -25...+70°C, Storage: -40...+70°C
- IP 66 and IP67 in accordance with IEC 60529
- Individual components with variable configuration
- In metal or plastic capsule
- Approvals: UL, CSA



### Photo barrier Osiris XUB1APANM12

- 3-wire technology
- Transistor output
- 0.6-5.5m reflective photo barrier
- Up to 20m unidirectional photo barrier
- IP67
- Operation: -25...+70°C Storage: -40...+70°C
- Certificates: UL, CSA, CE

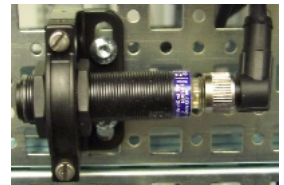

### Signal Beacon Harmony XVB

- Optical and acoustic signal, blink and flashing
- Temperature Range: -25...+50°C  
Storage: -40...+70°C
- element colours: green,red,orange,yellow,white
- Combination of max. 5 elements
- Simple wiring via flexible terminals in connection element
- Certificates: CSA, UL



## Performance Contd.

### Magelis XBT-G2220 display terminal

- Touch panels (STN/TFT technology) with 24 V DC supply
- Brightness and contrast adjustment
- Supports communication via Uni-Telway, Modbus and (to some extent) Ethernet TCP/IP
- Flat design
- Memory expansion for application
- Temperature range: 0..+ 50°C
- Approvals: UL, CSA



### CANopen junction box VW3CANTAP2

- 2 CANopen slaves can be connected via RJ45 (Altivar/Lexium)
- Third port enabling connection of a PC



### Proximity sensor Osiprox XS608B1PAM12

- induction sensor
- Flush fitting
- Connector M12
- 3-wire technology
- Switching distance 0...2mm (up to 12 possible)
- IP67
- Operation: -25...+70°C    Storage: -40...+85°C
- Certificates: UL, CSA, CE



---

## Components

### Optional

#### E-OFF Button

- for maximal 3 auxiliary switch blocks
- tamper free
- rotational locking
- Certificates UL Listed, CSA



### Optional

#### E-OFF master switch for door mounting VCD0

- Power off switch 3pole, 10A to 140A, rotational, conforming to IEC 947-4-1 und IEC 204
- Lockable (padlock not included)

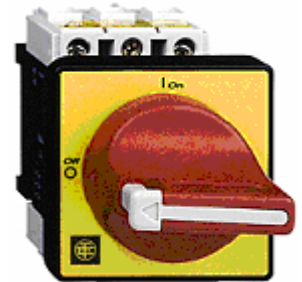

## Contact

---

Author	Telephone	E-mail
Schneider Electric GmbH Machines and Process Architectures	+49 6182 81 2555	<a href="mailto:cm.systems@de.schneider-electric.com">cm.systems@de.schneider-electric.com</a>

Schneider Electric GmbH  
Steinheimer Strasse 117  
D - 63500 Seligenstadt  
Germany

As standards,  
specifications and  
designs change from  
time to time, please ask  
for confirmation of the  
information given in this  
publication..