

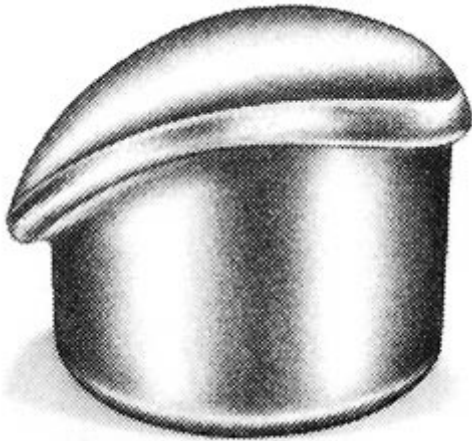

Product Datasheet

ANDERSON FARGO

WTT152424 -- Tee, Aluminum Weldment



Tee, Aluminum Weldment, Angle, Tube to Tube, 2-1/2 to 2-1/2 IPS/EHIPS tubes

Product Specifications

Family Image



Tees

Tees



WTT-15 Series
Tube to Tube, 15 Degree
Aluminum Weldment Tees

PDF Catalog Page

[Click HERE to view the web page.](#)

Dimension A

2.00 in (50.8 mm)

Dimension B

4.31 in (109.6 mm)

Dimension L

4.63 in (117.5 mm)

Material Type

Non-Standard

UPC Code

09635934308

Standard Package

9

Standard Package Unit

Each

Min Order Qty

1

Weight / Ea.

2.156 lbs

Compressed Product Number

WTT152424

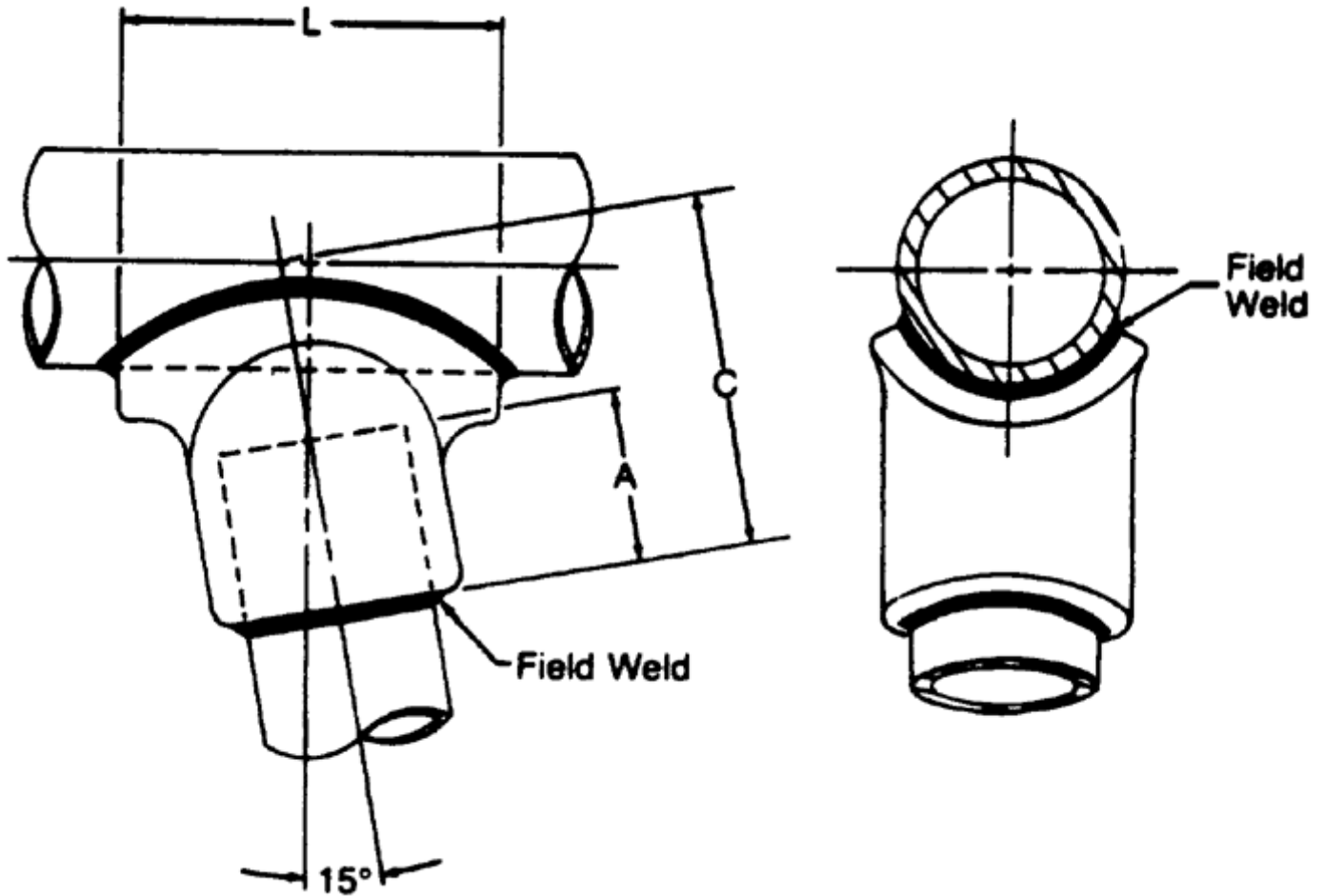

[Catalog Home](#)



[Warranty Info](#) | [Trademarks](#) | [Terms of Use](#)

All contents Copyright © 2007 Hubbell Power Systems, Inc. All rights reserved.

NOTE: Because Hubbell has a policy of continuous product improvement, we reserve the right to change design and specifications without notice.