

-NOTES-

1. HOT DIP GALVANIZE PER ASTM A153 (LATEST REVISION).
2. BOLT PER ASTM A325 TYPE 1 (LATEST REVISION).
3. BOLT PER ASTM A193 GRADE B7 (LATEST REVISION).
4. MAXIMUM DIAMETER GUY STRANDS ARE TWICE R AND R1.
5. PULLING EYE FITS CHANCE STANDARD HOIST HOOKS 2 TONS AND LESS. PULLING EYE RATED AT AN ULTIMATE LOAD OF 12,000 LB.
6. ALL FORGED GUY ADAPTERS ARE 18" END TO END.
7. ADD "Y" TO END OF CATALOG NUMBERS INDICATED BY ASTERISK FOR YELLOW PAINT OVER GALVANIZING.
8. ADD USA SUFFIX TO CATALOG NUMBER FOR BUY AMERICA ITEMS. PURCHASERS OF BUY AMERICA ITEMS WILL BE PROVIDED A DATED CERTIFICATE OF COMPLIANCE TO SPECIFIC BUY AMERICA PROVISIONS IF REQUESTED AT THE TIME OF ORDER. CONTACT HUBBELL POWER SYSTEMS CUSTOMER SERVICE FOR DETAILS.

(1) C1100041	(1) C1020023	(1) T1100311 (1) T1100312	(1) C1020024A (2) C1020024	(1) T1100964A (2) T1100964 (2) T1101229	(1) C1020025A (2) C1020025	(1) T1100465A (1) T1100629A (2) T1100465 (2) T1100629
--------------	--------------	------------------------------	-------------------------------	---	-------------------------------	--

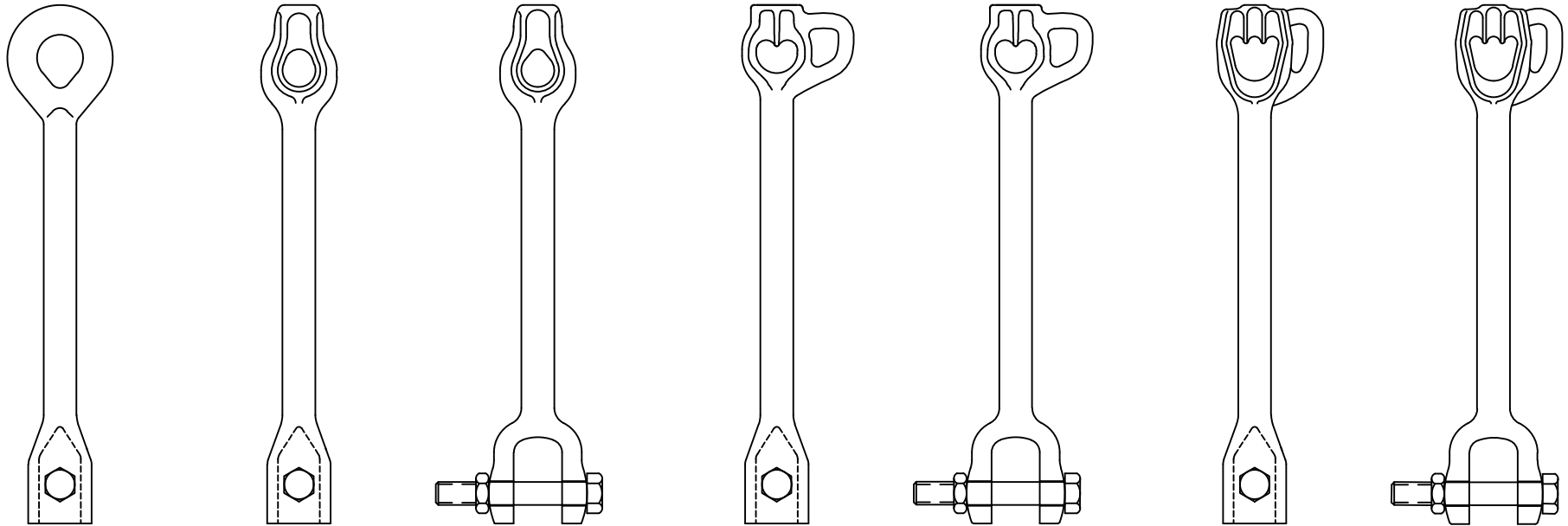

CATALOG NUMBER (NOTE 7)			
(1) W/O PULLING EYE	(2) W/ PULLING EYE	ADAPTER	COUPLER
C1100041	N/A	OVALEYE	SS5/150
C1020023*	N/A	THIMBLEYE®	SS5/150
T1100311*	N/A	THIMBLEYE®	SS175
T1100312*	N/A	THIMBLEYE®	SS200
C1020024A	C1020024*	TWINEYE®	SS5/150
C1020025A	C1020025*	TRIPLEYE®	SS5/150
T1100964A	T1100964*	TWINEYE®	SS175
T1100465A	T1100465*	TRIPLEYE®	SS175
N/A	T1101229	TWINEYE®	SS200
T1100629A	T1100629*	TRIPLEYE®	SS200

CHANCE TOLERANCE CHART	HUBBELL® POWER SYSTEMS
CONFIDENTIAL: THIS DRAWING AND ITS CONTENTS ARE CONFIDENTIAL AND THE EXCLUSIVE PROPERTY OF HUBBELL POWER SYSTEMS. NO PUBLICATION, DISTRIBUTION OR COPIES MAY BE MADE WITHOUT THE WRITTEN CONSENT OF HUBBELL POWER SYSTEMS. HUBBELL POWER SYSTEMS UNPUBLISHED ALL RIGHTS RESERVED UNDER THE COPYRIGHT LAWS.	
TITLE FORGED GUY ADAPTERS	
SIZE DWG NO. C SA1020024	CAT / PART / ASSY NO. SEE TABLE
DO NOT SCALE THIS DRAWING	DRN BY TMK DATE 11/2/12 SHEET 1/2

ADAPTER

DVALEYE

THIMBLEYE®

TWINEYE®

TRIPLEYE®

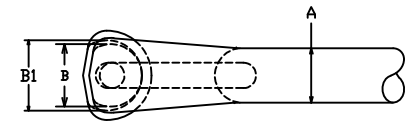
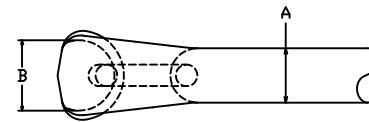
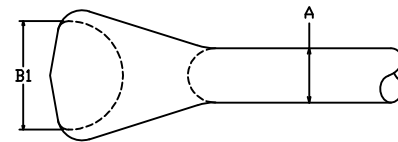
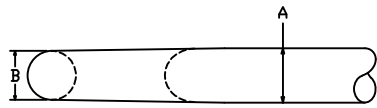
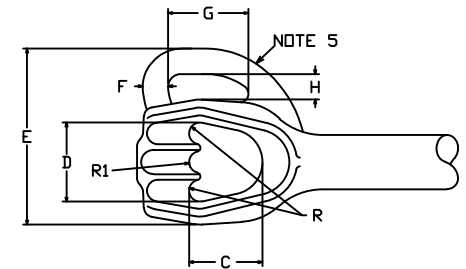
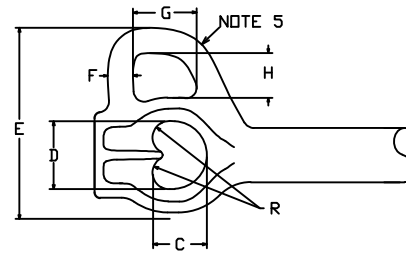
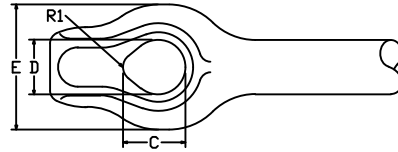
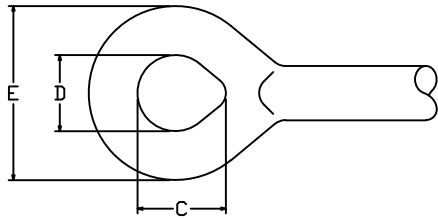

COUPLER

CLEVIS

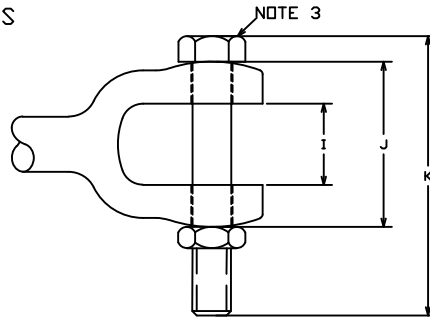
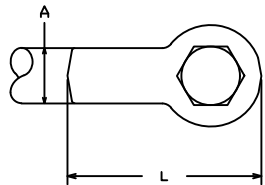

SOCKET

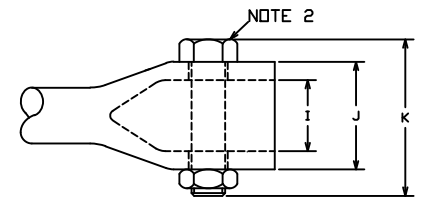
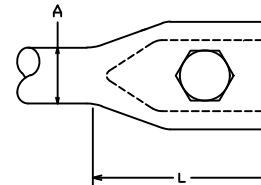

DIM.	ADAPTER					
	(1) W/O PULLING EYE			(2) W/ PULLING EYE		
	DVALEYE	THIMBLEYE®	TWINEYE®	TRIPLEYE®	TWINEYE®	TRIPLEYE®
A	1.25	1.25	1.25	1.25	1.25	1.25
B	1.06	N/A	1.62	1.44	1.62	1.44
B1	N/A	2.50	N/A	1.62	N/A	1.62
C	2.25	1.44	1.24	1.69	1.24	1.69
D	1.75	1.25	1.56	1.82	1.56	1.82
E	3.90	2.88	2.12	2.30	4.16	4.05
F	N/A	N/A	N/A	N/A	0.50	0.58
G	N/A	N/A	N/A	N/A	1.48	1.77
H	N/A	N/A	N/A	N/A	1.00	1.00
R	N/A	N/A	0.38	0.25	0.38	0.25
R1	N/A	0.53	N/A	0.28	N/A	0.28

DIM.	COUPLER		
	SOCKET	CLEVIS	
	SS5/150	SS175	SS200
A	1.25	1.25	1.25
I	1.59	1.84	2.17
J	2.41	3.74	3.92
K	3.5	6.33	6.33
L	4.0	4.39	4.34

CHANCE
TOLERANCE CHART

HUBBELL® POWER SYSTEMS

POWER SYSTEMS, INC.

CONFIDENTIAL: THIS DRAWING AND ITS CONTENTS ARE CONFIDENTIAL AND THE EXCLUSIVE PROPERTY OF HUBBELL POWER SYSTEMS. NO PUBLICATION, DISTRIBUTION OR COPIES MAY BE MADE WITHOUT THE WRITTEN CONSENT OF HUBBELL POWER SYSTEMS. HUBBELL POWER SYSTEMS UNPUBLISHED. ALL RIGHTS RESERVED UNDER THE COPYRIGHT LAWS.

TITLE: FORGED GUY ADAPTERS

SIZE: C	DWG NO.: SA1020024	CAT / PART / ASSY NO.: SEE TABLE	REV: G
DO NOT SCALE THIS DRAWING	DRN BY: TMK	DATE: 11/2/12	SHEET: 2/2