

**30 Amp, 3Ø 480 and 3Ø 600 Volts AC
3 Pole, 4 Wire, Grounding**



30A 3Ø 480V AC NEMA L16-30R 10 HP	30A 3Ø 600V AC NEMA L17-30R
---	--------------------------------

Connector Bodies

Watertight Safety-Shroud®

Description	Cord Dia.	Catalog Number	IP66 SUITABILITY	UL Type 4x, 12
Black Valox® housing, white Valox® clamps.	.350"-1.150" (9-29)	HBL2733SW	HBL2743SW	

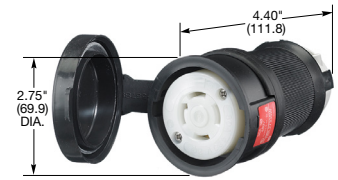

HBL2733SW

Insulgrip®

Description	Cord Dia.	Catalog Number	IP20 SUITABILITY	UL Type 4x, 12
Black and white nylon.	.350"-1.150" (9-29)	HBL2733	HBL2743	
Black and white nylon, spring termination	.350"-1.150" (9-29)	HBL2733ST	-	
Corrosion resistant, yellow nylon.	.350"-1.150" (9-29)	HBL27CM33	HBL27CM43	



HBL2733

Note: See page B-52 for accessories.

Receptacles

Watertight Safety-Shroud®

Description	Catalog Number	IP66 SUITABILITY	UL Type 4x, 12
Gray Valox® housing and flange, back wired.	HBL2730SW	HBL2740SW	

Note: See page B-54 for accessories.

Safety-Shroud® Twist-Lock®

Description	Catalog Number	IP20 SUITABILITY	UL Type 4x, 12
Gray Valox® angle housing, one gang, back wired.	HBL2730AR	HBL2740AR	
Gray Valox® surface mounting, one gang, back wired.	HBL2730SR	HBL2740SR	
Gray Valox® semi-flush, two gang, back wired.	HBL2730SR2	HBL2740SR2	



HBL2733ST

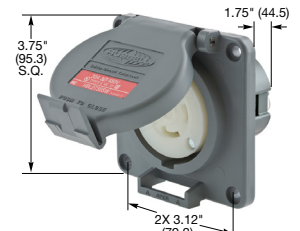

HBL2730SW

Single Flush Receptacles

Description	Catalog Number	IP20 SUITABILITY	UL Type 4x, 12
Black nylon face, back and side wired.	HBL2730	HBL2740	
Black and white nylon, spring termination.	HBL2730ST	-	

Note: See page B-52 for accessories.

Insulgrip® Flanged Receptacles

Description	Catalog Number	IP20 SUITABILITY	UL Type 4x, 12
Nylon casing, back wired.	HBL2736	HBL2746	
Nylon casing, back wire, spring termination	HBL2736ST	-	

Note: See page B-52 for accessories.

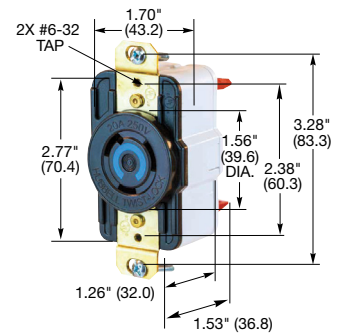

HBL2730ST

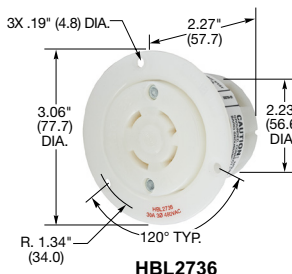

HBL2736

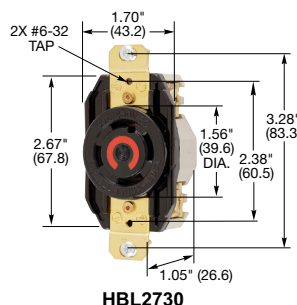

HBL2730

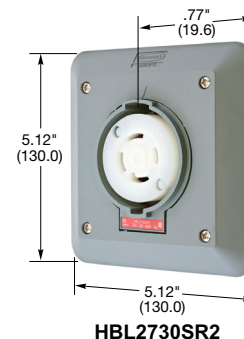

HBL2730SR2

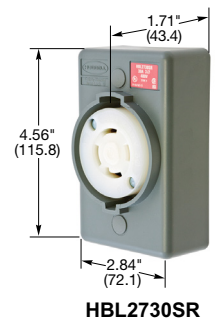

HBL2730SR

Valox® is a trademark of SABIC Innovative Plastics, acquired from General Electric Company.

Dimensions in Inches (mm)