



Product Datasheet

ANDERSON FARGO

YCS2490 -- Y-Clevis Eye



Y-Clevis Eye, Rotated, Ductile Iron, 0.750" Curved Bolt, Eye: 2.500" with 0.688" Hole, UTS 30,000 lb

Product Specifications

<p>Hardware Family</p>	 <p>Clevis Eye & Y-Clevis Eye Coupling Fittings</p>
<p>Clevis Eye Fittings</p>	<p>YCS1090 Photo Sample</p> <p>YCS-90 Series Y-Clevis Eye, Rotated Coupling Fittings</p>
<p>PDF Catalog Page</p>	<p>Click HERE to view the web page.</p>
<p>Ultimate Strength</p>	<p>30,000 lb (13,608 kg)</p>
<p>Coupling Length</p>	<p>2.438 in (61.91 mm)</p>
<p>Eye Width</p>	<p>2.500 in (63.50 mm)</p>
<p>Eye Hole Diameter</p>	<p>0.688 in (17.48 mm)</p>
<p>Dimension B</p>	<p>1.625 in (41.28 mm)</p>
<p>Dimension R</p>	<p>0.813 in (20.64 mm)</p>
<p>Dimension W</p>	<p>2.50 in (63.50 mm)</p>
<p>Dimension PD</p>	<p>0.750 in (19.05 mm)</p>
<p>Material</p>	<p>Ductile Iron</p>

Cotter Pin Material	Stainless Steel
Clevis Pin Material	Galvanized Steel
Material Type	Non-Standard
UPC Code	09635934473
Standard Package	1
Standard Package Unit	Each
Min Order Qty	1
Weight / Ea.	2.94 lbs

Compressed Product Number

YCS2490

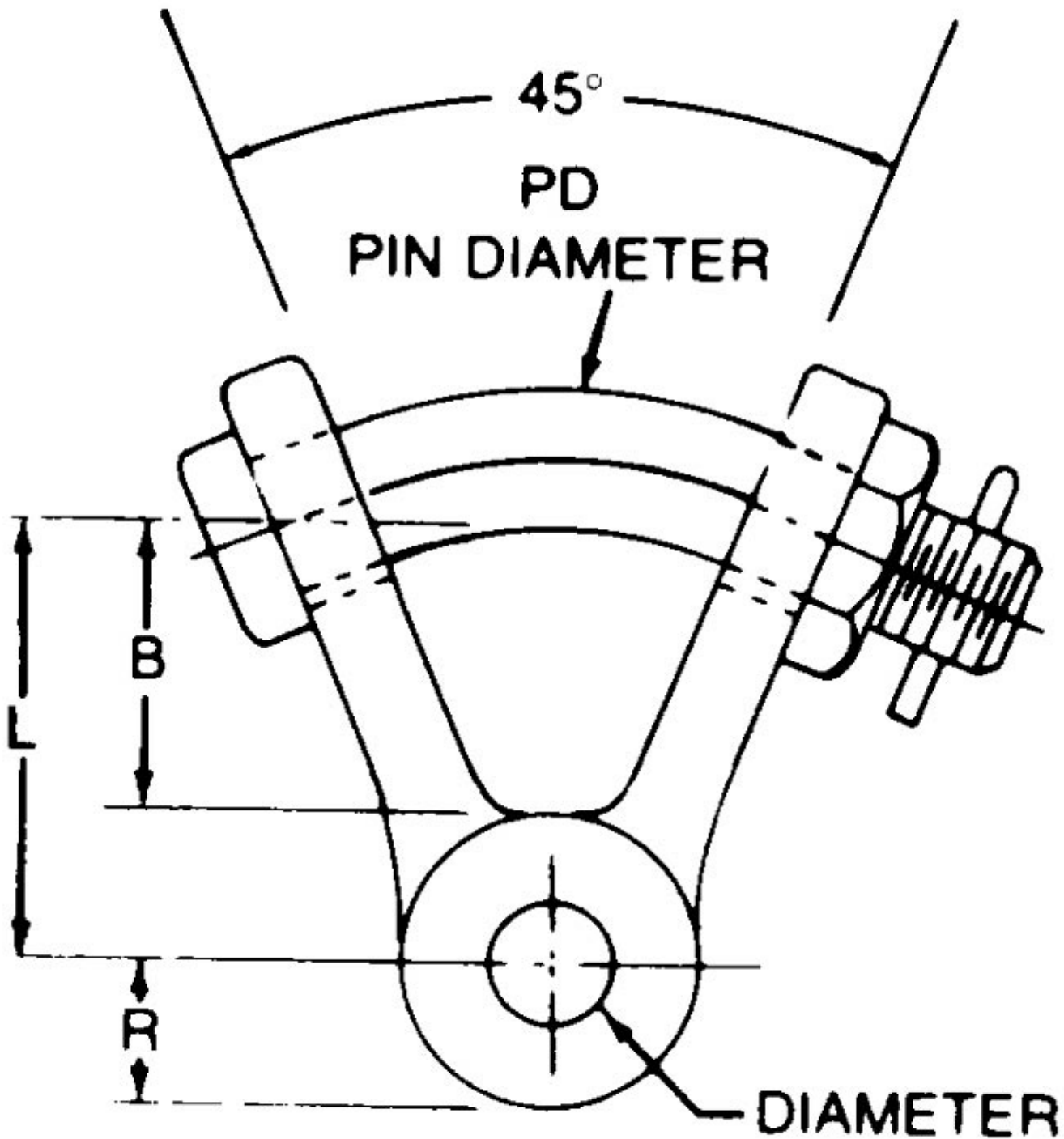

FIGURE 2 YCS-90

[Catalog Home](#)



[Warranty Info](#) | [Trademarks](#) | [Terms of Use](#)

All contents Copyright © 2007 Hubbell Power Systems, Inc. All rights reserved.

NOTE: Because Hubbell has a policy of continuous product improvement, we reserve the right to change design and specifications without notice.