



CONNECT AND PROTECT

Selection guide

For Self-Regulating Heat-Tracing Systems

nvent

RAYCHEM

nVent RAYCHEM TraceCalc Net software design in three easy steps:

1. Select your heat-tracing design

<https://raychem.nvent.com/en-gb/tracecalc-net>



2. Enter the design data



3. Get a bill of materials and request a quotation



Project Bill Of Materials Report
TraceCalc Net

Project Name: Project 1
Project Number: N/A
Customer Name: N/A
Customer Reference: N/A

| Catalog Number | Description | Quantity |
|---------------------------|--|----------|
| 887V1-C7 | 3-Wire, 120V Raychem Self-Regulating Cable | 170.0 |
| J8H-100-A | 4-Wire 8-Wire Power/Ground/Tea Kit with J-Box | 1 each |
| J8D-100-A | Single-Entry Power Kit with J-Box | 1 each |
| T-100 | Tea or Tee Connection Kit | 2 each |
| E-100-A | Above-insulation End Cap Kit | 3 each |
| PS-10 | Pipe Strap 1 to 1.5 in. | 8 each |
| PS-1 | Pipe Strap 1.5 to 2 in. | 4 each |
| UT-40 | Gasket Tape (not for stainless-steel pipes) | 12.00 |
| ETL-ENCLOSURE | Electric Tracing Line for stacked pipes and tanks | 50 each |
| UT-TRIMMING-TOOL-OR-CABLE | Trimming Tool for Terminating Self-Regulating Cables | 0 each |

We manage the heat you need...

... with easy project design

1 >>

FOLLOW THIS DESIGN GUIDE

to get to the right solution for your application. First select the correct heating cable, then take care of the electrical design and select the components and accessories to complete your heat-tracing system.



2 >>

OR USE OUR SOFTWARE DESIGN TOOLS

TraceCalc Net or TraceCalc Pro can generate a complete bill of materials, design summary and line list for your heat-tracing system. Both offer the possibility to do designs for use in hazardous or non-hazardous areas and for frost protection or temperature maintenance. With **TraceCalc Net** selecting the appropriate industrial pipe heat-tracing products is easy.

The simple 3-step design process consists of:

1. Select your heat-tracing design
2. Enter the design data
3. Get a bill of materials and request a quotation

Register for this online design tool at:

<https://raychem.nvent.com/en-gb/tracecalc-net>

For heat-tracing in industrial applications, **TraceCalc Pro** provides design calculations such as pipe heat loss, number of circuits, electrical loads and maximum temperatures, automated heating cable and component selection, recommendations for control and monitoring selection, and much more.

It provides easy-to-use standard reports and last but not least, its powerful features help you obtain the best heat-tracing solution for your particular project.

With TraceCalc Pro, nVent provides you with an unprecedented design tool giving you an optimal heat-tracing solution. Download this tool at :

<https://raychem.nvent.com/en-be/resources/design-tools/tracecalc-pro>



3 >>

OR LET US DO THE DESIGN FOR YOU

Simply complete the project information sheet provided at the end of this guide and email it back to your nVent representative who will quickly provide you with a most appropriate design, a bill of materials and pricing.



... with a 'high performance' heat-tracing system

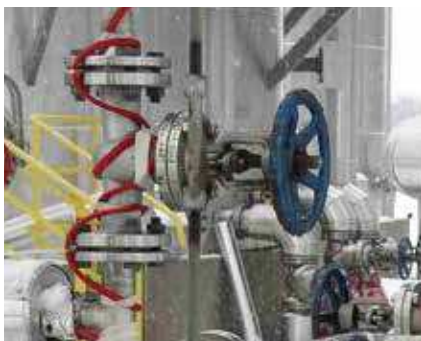

Our nVent RAYCHEM self-regulating heat-tracing system is ...



... SUPER SAFE

- nVent RAYCHEM self-regulating heat-tracing cables are certified for unconditional T-rating in accordance with European Standard EN 60079-30-1. The surface temperature of the heating cable will never exceed its T-class temperature.
- The self-regulating principle ensures that the cable senses overlaps. It regulates its heat accordingly and prevents any heat build-up or burn out. Furthermore, complex shapes like valves, flanges or pipe supports are easily traced with this system.

... COST SAVING

- The cable is easy to tee, splice, install and repair. No special skills are required, resulting in reduced installation time.
- Due to its self-regulating principle, this system saves energy and thus operational costs.
- The system requires a minimum of maintenance and is fully resistant to all pipe maintenance procedures.
- To easily accommodate design changes on site, the cable can be cut-to-length when being installed.

km cable sold
550 000



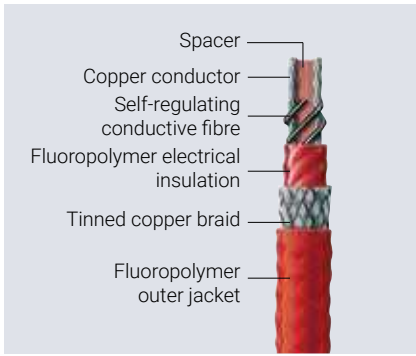

Fibre construction



Solid construction



... RELIABLE

- Toughness is a major attribute of self-regulating heat-tracing cables. We use large metallic conductors, a tin or nickel plated braid, and high performance polymers for high mechanical, thermal and chemical strength.
- The cable compensates for variations in heat loss and voltage. It can be fine-tuned to control your pipe temperature to a tolerance of 3°C by installing a pipe sensor and feeding the input to a control unit.
- Even variations in ambient temperature are automatically compensated for by the self-regulating heating cable.
- Our company can build on 50 years of experience in the heat-tracing business.
- With nVent, customers can rely on a company that has shipped over 550,000 km of self-regulating heat-tracing cables.

- nVent RAYCHEM heating cables are known for high power retention, superior performance and a long design life, up to 20 years or more. They come with the product warranty of 10 years.

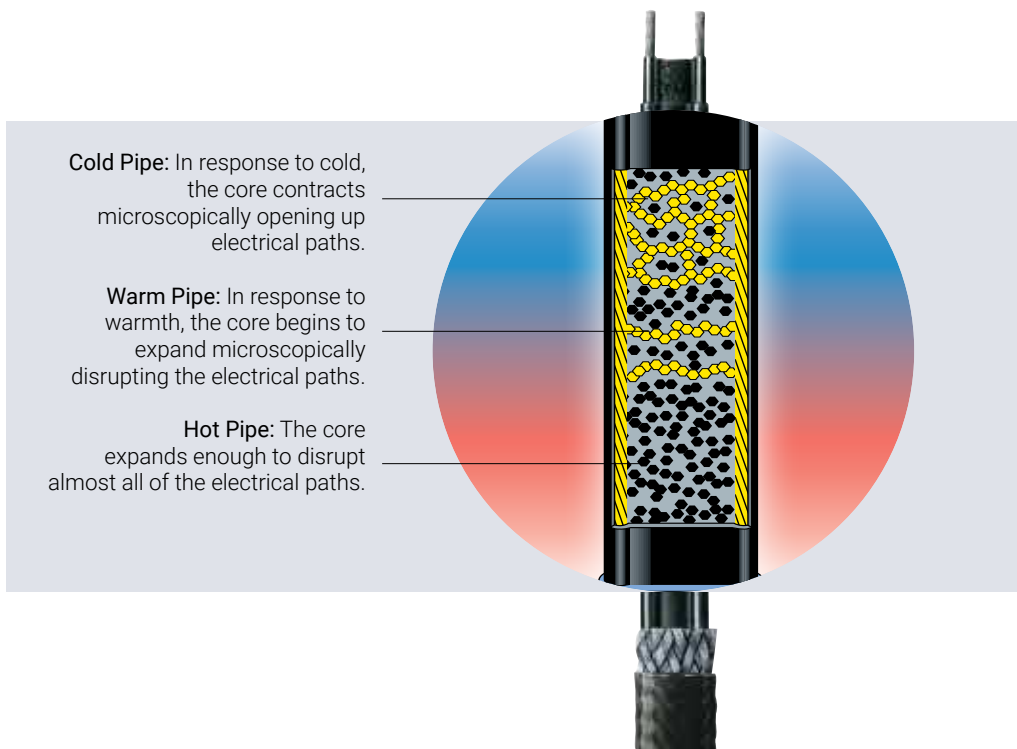

Heat-Tracing Design Guide

How to select and design the heat-tracing system for pipes

This Design Guide outlines a simple procedure for designing and selecting a complete heat-tracing system using BTV, QTVR, XTV or HTV heating cables.

By following the design steps in the 3 sections, a bill of materials can be easily produced which includes the heating cable type, length, components and accessories needed to install the heat-tracing system correctly.

1.0 Heating cable selection

2.0 Electrical design

3.0 Components and accessories selection

Installation

nVent heat-tracing systems must be installed following nVent guidelines. Contact your nVent representative for a copy of the installation manual. All components are supplied with easy-to-follow instructions.

Additional information

Full technical information on components and heating cables can be found in our Technical Databook. Combined with the installation instructions this supplements the information in this guide. These documents are available from your local nVent representative and from the nVent website (nVent.com).

1.0 Heating cable selection

To select the correct heating cable determine

- Pipe or tubing diameter
- Thermal insulation thickness
- T_m : Maintain Temperature (desired fluid temperature)

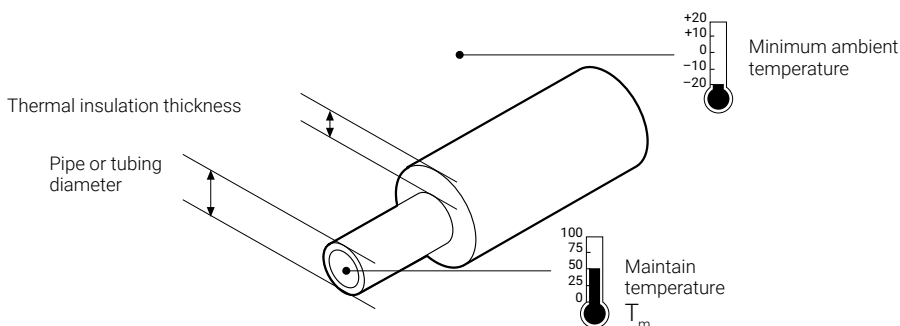

EXAMPLE:

Fluid: Process liquid, steam-cleaned

Line size: NB 50 mm

Insulation thickness: 50 mm

T_m : 50°C

STEP 1.1 DETERMINE HEAT LOSS

Table 1 Heat Loss Table

The table is based on the following parameters:

- Mineral wool insulation
- Minimum expected ambient temperature: -20°C
- Pipes located outdoors
- Steel pipes
- Safety factor 10%

For other configurations (dimensions, temperatures, etc.), please use TraceCalc Pro or TraceCalc Net software or consult your nVent representative.

1. Select the pipe diameter and insulation thickness
2. Select the desired maintain temperature
3. Note the heat loss result

Example:

NB 50 mm, 50 mm insulation thickness
 Tm: 50°C
 18.8 W/m

| DN= Ø pipe (NB) | Insulation thickness (mm) | Maintain temperature (°C) | | | | | | |
|-----------------|---------------------------|---------------------------|------|------|------|------|------|------|
| | | 5 | 10 | 20 | 30 | 40 | 50 | 60 |
| 8 | 25 | 3.9 | 4.7 | 6.4 | 8.1 | 9.9 | 11.8 | 13.7 |
| | 30 | 3.5 | 4.3 | 5.8 | 7.5 | 9.1 | 10.8 | 12.6 |
| | 40 | 3.1 | 3.8 | 5.1 | 6.5 | 8.0 | 9.5 | 11.0 |
| 15 | 25 | 4.9 | 6.0 | 8.2 | 10.4 | 12.7 | 15.1 | 17.6 |
| | 30 | 4.5 | 5.4 | 7.4 | 9.4 | 11.5 | 13.7 | 15.9 |
| | 40 | 3.9 | 4.7 | 6.4 | 8.1 | 9.9 | 11.8 | 13.7 |
| 20 | 25 | 5.7 | 6.9 | 9.4 | 11.9 | 14.6 | 17.4 | 20.2 |
| | 30 | 5.1 | 6.2 | 8.4 | 10.7 | 13.1 | 15.6 | 18.1 |
| | 40 | 4.4 | 5.3 | 7.2 | 9.2 | 11.2 | 13.3 | 15.5 |
| 25 | 25 | 6.6 | 7.9 | 10.8 | 13.8 | 16.9 | 20.0 | 23.3 |
| | 30 | 5.9 | 7.1 | 9.6 | 12.3 | 15.0 | 17.9 | 20.8 |
| | 40 | 4.9 | 6.0 | 8.1 | 10.4 | 12.7 | 15.1 | 17.5 |
| 32 | 25 | 7.6 | 9.3 | 12.6 | 16.1 | 19.7 | 23.3 | 27.1 |
| | 30 | 6.8 | 8.2 | 11.2 | 14.2 | 17.4 | 20.7 | 24.1 |
| | 40 | 5.7 | 6.9 | 9.3 | 11.9 | 14.6 | 17.3 | 20.1 |
| 40 | 25 | 8.4 | 10.2 | 13.8 | 17.6 | 21.5 | 25.6 | 29.7 |
| | 30 | 7.4 | 9.0 | 12.2 | 15.5 | 19.0 | 22.6 | 26.2 |
| | 40 | 6.1 | 7.4 | 10.1 | 12.9 | 15.8 | 18.7 | 21.8 |
| 50 | 30 | 8.6 | 10.5 | 14.2 | 18.2 | 22.2 | 26.4 | 30.6 |
| | 40 | 7.1 | 8.6 | 11.7 | 14.9 | 18.2 | 21.7 | 25.2 |
| | 50 | 6.1 | 7.5 | 10.1 | 12.9 | 15.8 | 18.8 | 21.8 |
| 65 | 30 | 10.2 | 12.4 | 16.9 | 21.5 | 26.4 | 31.3 | 36.4 |
| | 40 | 8.3 | 10.1 | 13.7 | 17.5 | 21.4 | 25.4 | 29.6 |
| | 50 | 7.2 | 8.7 | 11.8 | 15.0 | 18.4 | 21.8 | 25.4 |
| 80 | 40 | 9.3 | 11.3 | 15.4 | 19.6 | 24.0 | 28.5 | 33.1 |
| | 50 | 8.0 | 9.7 | 13.1 | 16.7 | 20.5 | 24.3 | 28.3 |
| | 80 | 5.9 | 7.1 | 9.7 | 12.3 | 15.1 | 17.9 | 20.8 |
| 100 | 50 | 9.5 | 11.6 | 15.7 | 20.1 | 24.5 | 29.1 | 33.9 |
| | 80 | 6.9 | 8.3 | 11.3 | 14.5 | 17.7 | 21.0 | 24.4 |
| | 100 | 6.0 | 7.2 | 9.8 | 12.5 | 15.3 | 18.2 | 21.2 |
| 150 | 50 | 12.8 | 15.6 | 21.2 | 27.0 | 33.0 | 39.2 | 45.6 |
| | 80 | 9.0 | 10.9 | 14.9 | 18.9 | 23.2 | 27.5 | 32.0 |
| | 100 | 7.7 | 9.3 | 12.7 | 16.2 | 19.8 | 23.5 | 27.3 |

STEP 1.2 SELECT HEATING CABLE FAMILY

- Verify that maximum exposure temperatures of heating cable are sufficient
- Select correct heating cable according to temperature classification

Example:

Steam-cleaned: System is cleaned for 6 hours per year using 20 bar saturated steam (215°C)
 Normal operating temperature is 50°C
 Temperature classification is T3
 Correct family is XTV2-CT-T3

| Cable type | Temperature classification | Max. exposure temperatures | |
|-----------------------------|----------------------------|----------------------------|---|
| | | Continuous | Intermittent * (1000 hours cumulated) ** (2000 hours cumulated) |
| BTV2-CT | T6 | 65°C | 85°C |
| QTVR2-CT | T4 | 110°C | 110°C |
| XTV2-CT-T3 | T3 | 121°C | 250°C (*) |
| 20XTV2-CT-T2 | T2 | 121°C | 250°C (*) |
| HTV2-CT (all except 20HTV2) | T3 | 205°C | 260°C (**) |
| 20HTV2-CT | T2 | 205°C | 260°C (**) |

(*): The 250°C rating applies to all products printed "MAX INTERMITTENT EXPOSURE 250C".

STEP 1.3 SELECT HEATING CABLE

- Select graph below based on the heating cable family
- Draw a vertical line at the maintain temperature
- Draw a horizontal line for the heat loss
- Select nearest cable above crossover of these two lines

BTV2-CT

- A 10BTV2-CT
- B 8BTV2-CT
- C 5BTV2-CT
- D 3BTV2-CT

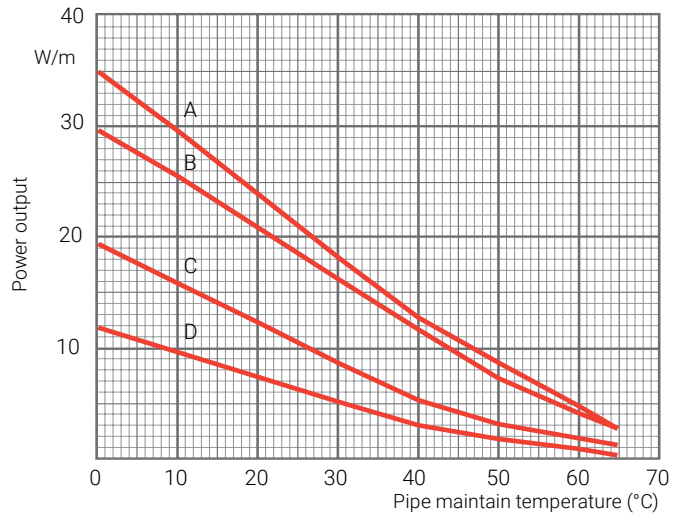

QTVR2-CT

- A 20QTVR2-CT
- B 15QTVR2-CT
- C 10QTVR2-CT

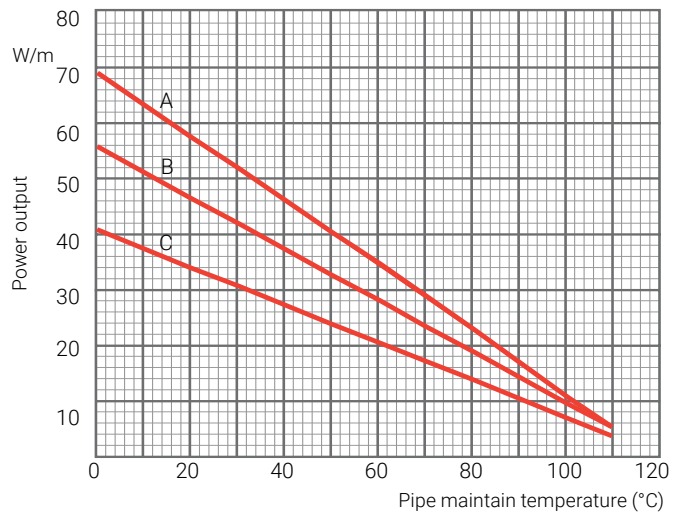

XTV2-CT-T* (*=3 or 2)

- A 20XTV2-CT-T2
- B 15XTV2-CT-T3
- C 12XTV2-CT-T3
- D 8XTV2-CT-T3
- E 4XTV2-CT-T3

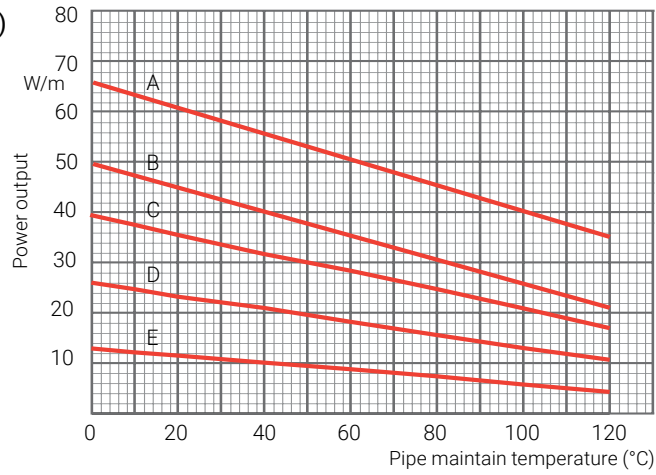

HTV2-CT

- A 20HTV2-CT
- B 15HTV2-CT
- C 12HTV2-CT
- D 10HTV2-CT
- E 8HTV2-CT
- F 5HTV2-CT
- G 3HTV2-CT

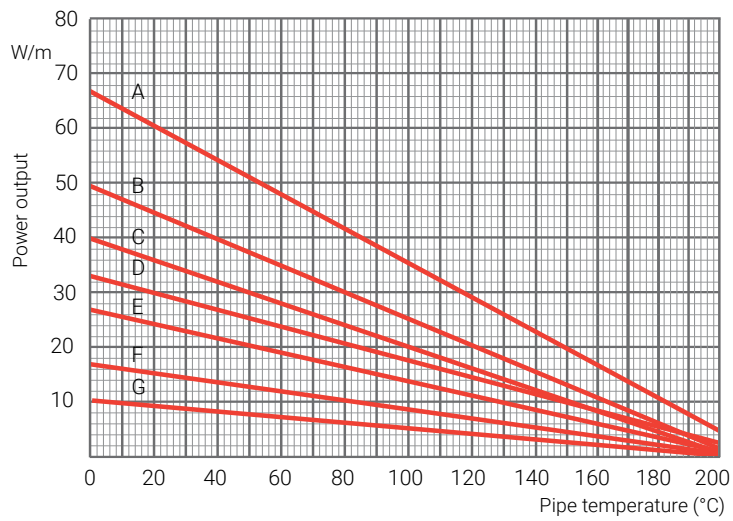

Example:

XTV graph

Maintain temperature = 50°C

Heat loss = 18.8 W/m

Nearest cable above cross-over is D = 8XTV2-CT-T3

- A 20XTV2-CT-T2
- B 15XTV2-CT-T3
- C 12XTV2-CT-T3
- D 8XTV2-CT-T3
- E 4XTV2-CT-T3

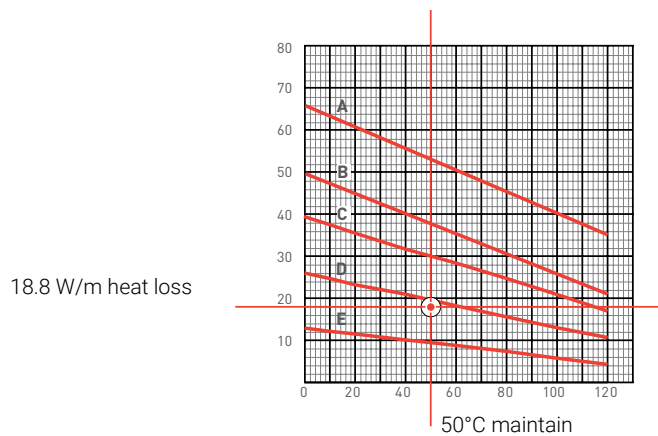

STEP 1.4 DETERMINE HEATING CABLE LENGTH

Determine the total length of the heating cable by combining lengths from each component in the piping system.

For the piping

Calculate the amount of heating cable required for the pipe length. In the case of a straight heating cable run, this quantity is equal to the total length of the piping.

Add at least one metre to allow for the entry into a junction box and the end seal.

Add a heating cable length of 5-10% for bends, flanges, elbows etc.

For each valve

Add the following heating cable lengths:

| Valve type | Heating cable length (m) per valve |
|------------|------------------------------------|
| Gate | 1.0 |
| Butterfly | 0.4 |
| Ball | 0.5 |
| Globe | 0.9 |

Pipe supports

Add the following heating cable lengths:

| Pipe size (mm) | Support Type | Heating cable length (m) per support |
|----------------|-----------------------------|--------------------------------------|
| 8 - 25 | Pipe hangers | 0 |
| 32 - 50 | Small shoe (100 mm x 5 mm) | 1.0 |
| 65 - 150 | Medium shoe (150 mm x 8 mm) | 2.0 |

Other fittings and fixtures

Consult your local nVent representative.

Example:

Heating cable length =

Pipe: 30 m = 30.0 m

Junction Box entry + end seal = 1.0 m

Flanges: 5% = 1.5 m

Valves: 3 ball valves x 0.5 = 1.5 m

Supports: 5 small shoes x 1 = 5.0 m

Total length of 8XTV2-CT-T3 = 39.0 m

2.0 Electrical Design

All nVent RAYCHEM heating cables must be installed with electrical protection in accordance with local codes and practices.

Circuit definition

For ease of system design and use, only one type of heating cable should be connected in each circuit. Each heat-tracing circuit should have its own electrical protection.

A circuit may be composed of several branches (see figure below) but the sum of all heating cable lengths should not exceed the maximum circuit length determined in section 2.2.

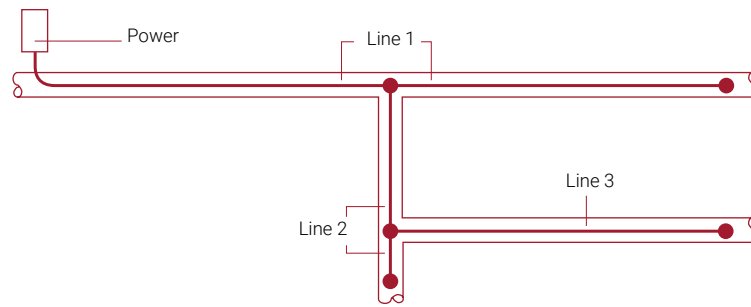

Example:

$\text{Line 1} + \text{Line 2} + \text{Line 3} \leq \text{Maximum Circuit length}$

Electrical protection sizing

nVent RAYCHEM heating cables are self-regulating: power output and current draw decrease as temperature increases. This current draw must be co-ordinated with the electrical protection. Table 2 on page 12 shows maximum circuit lengths for use with commonly available protection devices (Type C to EN 60898 circuit breaker) and applies for nVent RAYCHEM heating cables installed on thermally insulated surfaces without the use of heat transfer aids. The table was generated in accordance with European practices for heating cables powered at 230 Vac.

For other supply voltages, applications, protection devices, start-up temperatures or products, consult your nVent representative.

Earth leakage protection

nVent requires the use of a 30 mA residual current device to provide maximum safety and protection from fire.

To select the circuit breaker sizing, determine:

- minimum start-up temperature
- total length of heating cable

STEP 2.1 DETERMINE MINIMUM PIPE START-UP TEMPERATURE (°C)

The power output and current draw of a nVent RAYCHEM heating cable depend on its temperature. Electrical protection sizing must be based on the minimum pipe start-up temperature.

Example: 0°C

STEP 2.2 SELECT PROTECTION RATING

From table 2 on page 12, match the heating cable catalogue number (see step 1-3) at the expected minimum start-up temperature with the total heating cable length (see step 1.4).

Select protection rating (A) for which the length of the heating cable is less or equal than the maximum recommended heating cable length ($L \leq L_{\text{max}}$).

Power cable sizing

Power supply cables from the electrical protection to the nVent RAYCHEM connection system should be sized to meet appropriate codes of practice, protection rating and voltage drop considerations.

Table 2

1. Select heating cable
2. Select min. start-up temperature
3. Match the total heating cable length

Example:

8XTV2-CT-T3
 0°C, 39 m, 10 A Type C circuit breaker
 Max. heating cable length = 60 m

| Start-up temperature | Circuit breaker size (type C) | Maximum recommended heating cable length (m) - L max | | | | | | | | | | | | | | | | | | |
|----------------------|-------------------------------|--|----------|----------|-----------|------------|------------|------------|-------------|-------------|--------------|--------------|--------------|----------|----------|----------|-----------|-----------|-----------|-----------|
| | | 3BTV2-CT | 5BTV2-CT | 8BTV2-CT | 10BTV2-CT | 10QTVR2-CT | 15QTVR2-CT | 20QTVR2-CT | 4XTV2-CT-T3 | 8XTV2-CT-T3 | 12XTV2-CT-T3 | 15XTV2-CT-T3 | 20XTV2-CT-T2 | 3HTV2-CT | 5HTV2-CT | 8HTV2-CT | 10HTV2-CT | 12HTV2-CT | 15HTV2-CT | 20HTV2-CT |
| 5°C | 6A | 90 | 60 | 35 | 20 | 25 | 20 | 15 | 60 | 40 | 30 | 20 | 15 | 72 | 53 | 39 | 33 | 28 | 22 | 17 |
| | 10A | 150 | 100 | 60 | 40 | 45 | 35 | 25 | 100 | 65 | 45 | 35 | 25 | 121 | 89 | 64 | 55 | 47 | 37 | 28 |
| | 13A | 195 | 135 | 80 | 50 | 60 | 45 | 35 | 130 | 85 | 60 | 50 | 35 | 157 | 115 | 84 | 72 | 62 | 48 | 37 |
| | 16A | 200 | 160 | 100 | 60 | 75 | 60 | 45 | 165 | 100 | 75 | 60 | 45 | 193 | 142 | 103 | 88 | 76 | 59 | 45 |
| | 20A | 200 | 160 | 125 | 75 | 95 | 75 | 55 | 205 | 130 | 95 | 75 | 55 | 241 | 177 | 129 | 110 | 95 | 74 | 56 |
| | 25A | 200 | 160 | 125 | 95 | 115 | 95 | 70 | 245 | 160 | 120 | 95 | 70 | 293 | 222 | 161 | 138 | 119 | 92 | 70 |
| | 32A | 200 | 160 | 125 | 110 | 115 | 100 | 90 | 245 | 175 | 140 | 120 | 90 | 293 | 224 | 173 | 150 | 138 | 118 | 90 |
| | 40A | NA | NA | NA | NA | 115 | 100 | 110 | 245 | 175 | 140 | 130 | 110 | 293 | 224 | 173 | 150 | 138 | 119 | 96 |
| 0°C | 6A | 80 | 55 | 35 | 20 | 25 | 20 | 15 | 60 | 35 | 25 | 20 | 15 | 71 | 52 | 38 | 32 | 28 | 22 | 17 |
| | 10A | 135 | 95 | 55 | 35 | 45 | 35 | 25 | 100 | 60 | 45 | 35 | 25 | 118 | 86 | 63 | 54 | 46 | 36 | 28 |
| | 13A | 175 | 120 | 75 | 45 | 60 | 45 | 35 | 130 | 80 | 60 | 45 | 35 | 154 | 112 | 81 | 70 | 60 | 47 | 36 |
| | 16A | 200 | 150 | 90 | 55 | 70 | 55 | 40 | 160 | 100 | 75 | 55 | 45 | 189 | 138 | 100 | 86 | 74 | 58 | 44 |
| | 20A | 200 | 160 | 115 | 70 | 90 | 70 | 55 | 200 | 125 | 90 | 70 | 55 | 237 | 172 | 125 | 108 | 93 | 72 | 55 |
| | 25A | 200 | 160 | 125 | 90 | 115 | 90 | 65 | 245 | 155 | 115 | 90 | 70 | 293 | 215 | 157 | 135 | 116 | 90 | 69 |
| | 32A | 200 | 160 | 125 | 110 | 115 | 100 | 85 | 245 | 175 | 140 | 115 | 90 | 293 | 224 | 173 | 152 | 138 | 115 | 88 |
| | 40A | NA | NA | NA | NA | 115 | 100 | 105 | 245 | 175 | 140 | 130 | 110 | 293 | 224 | 173 | 152 | 138 | 119 | 95 |
| -10°C | 6A | 65 | 45 | 30 | 15 | 25 | 20 | 15 | 55 | 35 | 25 | 20 | 15 | 67 | 49 | 36 | 31 | 26 | 21 | 16 |
| | 10A | 110 | 80 | 50 | 30 | 40 | 30 | 25 | 95 | 60 | 45 | 35 | 25 | 111 | 82 | 60 | 52 | 44 | 34 | 26 |
| | 13A | 145 | 100 | 65 | 40 | 55 | 40 | 30 | 120 | 75 | 55 | 45 | 35 | 145 | 107 | 78 | 67 | 57 | 45 | 34 |
| | 16A | 180 | 125 | 80 | 50 | 65 | 50 | 40 | 150 | 95 | 70 | 55 | 40 | 178 | 132 | 96 | 82 | 70 | 55 | 42 |
| | 20A | 200 | 160 | 100 | 60 | 85 | 65 | 50 | 190 | 120 | 85 | 70 | 50 | 222 | 165 | 120 | 103 | 88 | 69 | 53 |
| | 25A | 200 | 160 | 125 | 80 | 105 | 80 | 60 | 235 | 150 | 110 | 85 | 65 | 278 | 206 | 150 | 129 | 110 | 86 | 66 |
| | 32A | 200 | 160 | 125 | 100 | 115 | 100 | 80 | 245 | 175 | 140 | 110 | 85 | 293 | 224 | 173 | 150 | 138 | 110 | 84 |
| | 40A | NA | NA | NA | NA | 115 | 100 | 100 | 245 | 175 | 140 | 130 | 105 | 293 | 224 | 173 | 150 | 138 | 119 | 89 |
| -20°C | 6A | 55 | 40 | 25 | 15 | 20 | 15 | 15 | 50 | 35 | 25 | 20 | 15 | 63 | 47 | 34 | 30 | 25 | 20 | 15 |
| | 10A | 95 | 70 | 45 | 25 | 40 | 30 | 20 | 90 | 55 | 40 | 30 | 25 | 105 | 79 | 57 | 49 | 42 | 33 | 25 |
| | 13A | 125 | 90 | 55 | 35 | 50 | 40 | 30 | 115 | 75 | 55 | 40 | 30 | 136 | 103 | 74 | 64 | 55 | 43 | 33 |
| | 16A | 155 | 110 | 70 | 45 | 60 | 50 | 35 | 145 | 90 | 65 | 55 | 40 | 168 | 126 | 92 | 79 | 67 | 53 | 40 |
| | 20A | 195 | 140 | 90 | 55 | 75 | 60 | 45 | 180 | 115 | 85 | 65 | 50 | 210 | 158 | 115 | 99 | 84 | 66 | 50 |
| | 25A | 200 | 160 | 110 | 70 | 95 | 75 | 60 | 225 | 145 | 105 | 85 | 65 | 262 | 197 | 143 | 123 | 105 | 82 | 63 |
| | 32A | 200 | 160 | 125 | 90 | 115 | 100 | 75 | 245 | 175 | 135 | 105 | 80 | 293 | 224 | 173 | 152 | 134 | 105 | 81 |
| | 40A | NA | NA | NA | NA | 115 | 100 | 95 | 245 | 175 | 140 | 135 | 105 | 293 | 224 | 173 | 152 | 138 | 119 | 88 |

3.0 Components and accessories selection

A complete range of cold applied components and accessories is available for all BTV, QTVR, XTV and HTV heating cable types. All of the components work together to provide a safe and reliable heat-tracing system that is easy to install and maintain. nVent RAYCHEM components must be used to ensure proper functioning of the product and compliance with relevant standards and regulations. A heat-tracing system consists of at least one power connection and one end seal. Additional components such as splices and tees are used as required.

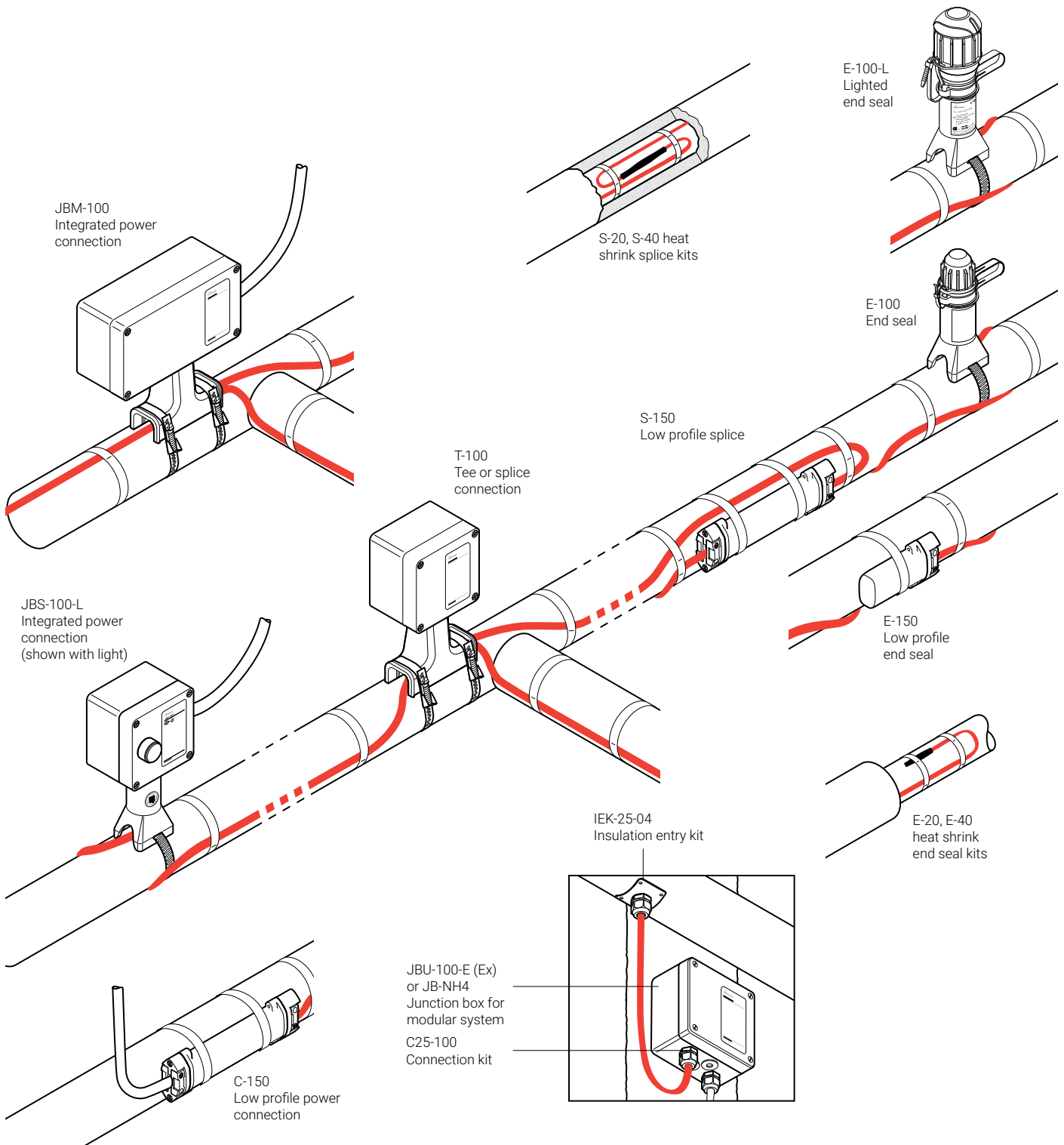

POWER CONNECTIONS

Power connections may be mounted on or off the pipe. For pipe mounted applications, select one of the integrated components below. For mounting off the pipe, select a separate junction box and the necessary connection kits and insulation entry kits from the modular components table on the next page. The kits can be used with nVent RAYCHEM industrial heating cables: BTV, QTVR, XTV and HTV.

The power connections JBS, JBM and JBU can also be ordered with a green light for simple indication if power is on.

INTEGRATED COMPONENTS

Integrated components combine the functions of the junction box, connection, insulation entry, and support bracket. These components provide full protection of the heating cable for safe operation. The cold-applied core sealing and innovative cage clamp terminals ensure reliable connections and significantly reduce installation time. The integrated components are designed for industrial applications and are approved for use in hazardous areas.

Threads are metric (M25).

ABOVE THE INSULATION

JBS-100-E

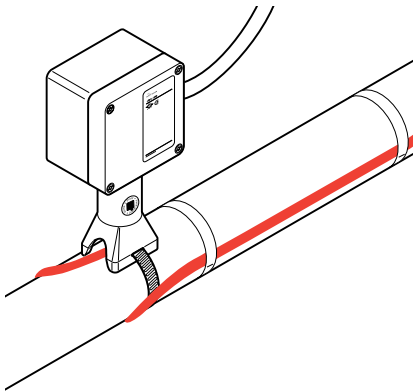

Integrated power connection for 1 heating cable.

Cold applied.

One power cable gland included.

Requires 1 pipe strap, to be ordered separately.

Part number P/N: 829939-000

With green light, order reference: JBS-100-L-E

(P/N 054363-000)

JBS-100-EP

Integrated power connection for 1 heating cable.

Includes earth plate and earth stud for use with armoured cables.

Cold applied. Requires 1 pipe strap and 1 metal power cable gland to be ordered separately.

Part number P/N: 158251-000

With green light, order reference: JBS-100-L-EP

(P/N 075249-000)

JBM-100-E

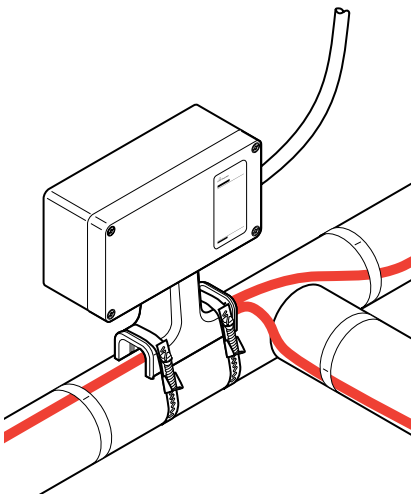

Integrated power connection for up to 3 heating cables.

May also be used for tee and splice connections.

Cold applied.

One power cable gland included.

Requires 2 pipe straps, to be ordered separately.

Part number P/N: 831519-000

With green light, order reference: JBM-100-L-E

(P/N 395855-000)

JBM-100-EP

Integrated power connection for up to 3 heating cables.

Includes earth plate and earth stud for use with armoured cables.

May also be used for tee and splice connections.

Cold applied. Requires 2 pipe straps and 1 metal power cable gland to be ordered separately.

Part number P/N: 986415-000

With green light, order reference: JBM-100-L-EP

(P/N 300273-000)

UNDER THE INSULATION

C-150-E

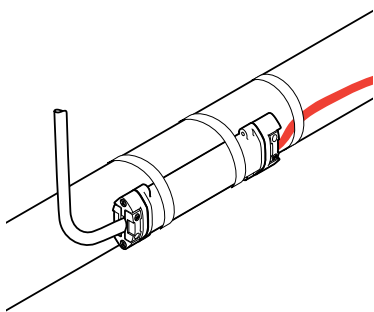

Low profile power connection for 1 heating cable.

Maximum load of 25A

Cold applied

Suitable for non-armoured power cables up to 2.5 mm² with stranded copper conductors

C-150-E is used as a connector:

- where connection to a junction box is difficult e.g. because of space limitations
- on instrument lines or loading arms
- where installation of under insulation components is preferred
- as a cost effective alternative for JBS-100-E on short lines

Part number P/N: 073704-000

Note: Not for use with HTV heating cables

MODULAR COMPONENTS

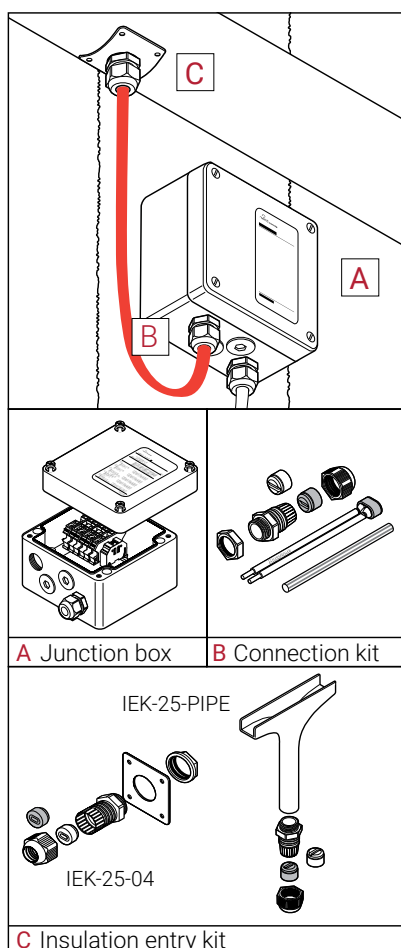

Modular components are used for making power connections for up to 3 heating cables. The junction boxes are designed for surface mounting, and versions for both hazardous and non-hazardous areas are available. The JBU-100 includes innovative cage clamp terminals. The connection kits and insulation entry kits are cold applied and have to be ordered separately. Select one junction box (maximum 3 heating cables per box). Select one connection kit and one insulation entry kit for each heating cable terminated in the junction box. Optionally a conduit system for mechanical protection of the heating cable where it transitions from the junction box to the pipe can be selected.

Metric system (M25)

Hazardous

Non-Hazardous

| | Hazardous | Non-Hazardous |
|---|---|--|
| A Junction boxes | | |
| For non-armoured power cable | JBU-100-E ⁽¹⁾ P/N: 051976-000 | JB-NH4 P/N: 1244-020911 JB-NH2 P/N: 1244-020910 |
| For armoured power cable | JBU-100-EP ⁽¹⁾⁽²⁾ P/N: 243948-000 | – |
| B Connection kits | | |
| | C25-100 P/N: 263012-000 | C25-100 P/N: 263012-000 |
| C Insulation entry kit | | |
| For pipes, vessels, pumps and instruments | IEK-25-04 P/N: 332523-000 | IEK-25-04 P/N: 332523-000 |
| For pipes | IEK-25-PIPE ⁽³⁾ P/N: 1244-001050 | IEK-25-PIPE ⁽³⁾ P/N: 1244-001050 |
| D Conduit system | | |
| For medium temperature applications | CCON25-100 + CCON-CMT-2M | CCON25-100 + CCON-CMT-2M |
| For high temperature applications | CCON25-100 + CCON-CHT-2M | CCON25-100 + CCON-CHT-2M |

⁽¹⁾ with green light, order reference: JBU-100-L-E or JBU-100-L-EP

⁽²⁾ includes internal earth plate and earth stud; requires metal power cable gland, to be ordered separately.

⁽³⁾ requires 2 pipe straps, to be ordered separately

SPLICES AND TEES

For in-line joining or making T-connections of the heating cables. Approved for use in hazardous areas (Ex e).

ABOVE THE INSULATION

JBM-100-E

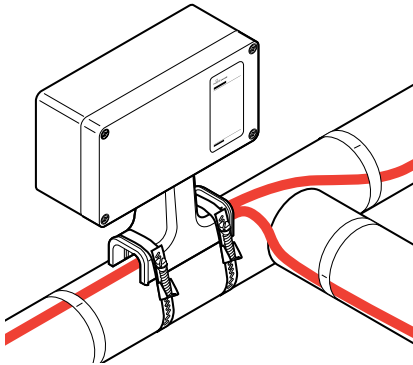

For making splice or tee connections with terminals above the insulation.

Cold applied.

Requires 2 pipe straps, to be ordered separately.

Part number P/N: 831519-000

With internal earth plate and earth stud, order reference: JBM-100-EP
(P/N 986415-000)

T-100

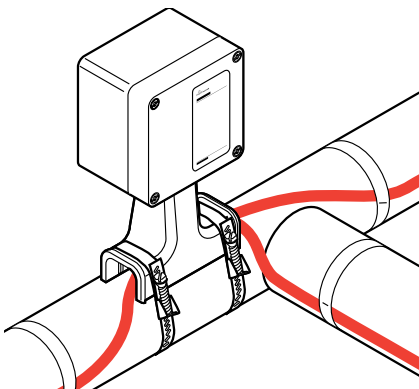

For making tee or splice connections with crimps above the insulation.

Cold applied.

Requires 2 pipe straps, to be ordered separately.

Part number P/N: 447379-000

Required crimp tool, reference: T-100-CT

(P/N 954799-000)

(Panduit: CT-1570)

UNDER THE INSULATION

S-150

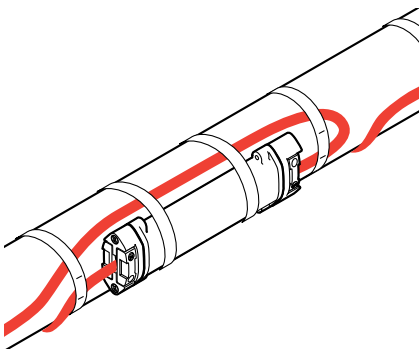

For making splice connections with terminals under the insulation.

Cold applied.

Part number: 497537-000

Note: Not for use with HTV heating cables

S-20 and S-40

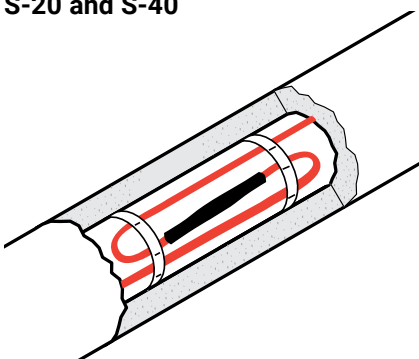

Heat shrinkable splice kit

S-20

Part Number: 1244-022490

S-40

Part Number: 1244-022492

END SEALS

End seals are used for terminating the heating cable. Approved for use in hazardous areas. Select 1 end seal for each remote heating cable end.

ABOVE THE INSULATION

E-100-E

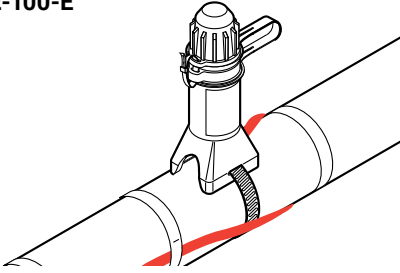

Mechanical end seal (Ex e).
Cold applied.
Requires 1 pipe strap, to be ordered separately.
Part number: 101255-000

E-100-L-E

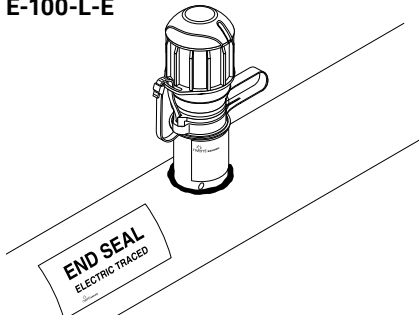

Mechanical end seal with green LED light module (Ex em).
Cold applied.
Requires 1 pipe strap, to be ordered separately.
Part number: P000001583

UNDER THE INSULATION

E-150-E

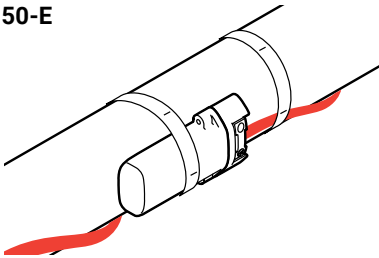

Low profile end seal (Ex e).
Cold applied.
Part number: 979099-000
Note: Not for use with HTV heating cables

E-20 and E-40

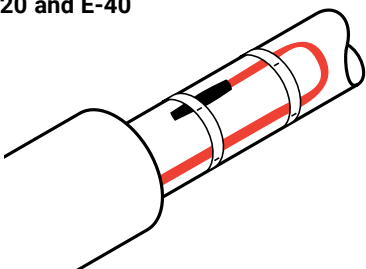

Heat shrinkable end seal kit
E-20
Part Number : 1244-022489
E-40
Part Number : 1244-022491

CONDUIT SYSTEMS

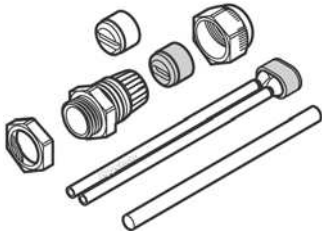

CCON25-100

Conduit connection kit for parallel heating cables.
Part number: 1244-003272

CCON25-CMT-2M

Medium temperature conduit for parallel heating cables, 2m pre-cut length.
Part number: 1244-003281

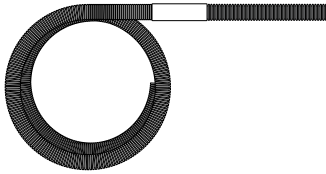

CCON25-CHT-2M

High temperature conduit for parallel heating cables, 2m pre-cut length.
part number: 1244-003284

CCON25-CMT-25M

Medium temperature conduit for parallel heating cables, 25m spool .
Part number: 1244-003280

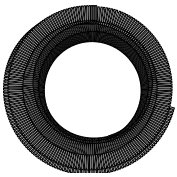

CCON25-CHT-25M

High temperature conduit for parallel heating cables, 25m spool.
part number: 1244-003284

CCON25-CMT/ HT-1.67/0.33M

Mixed medium temperature conduit (1.67m) with high temperature conduit (0.33m) joined with a heat shrink sleeve
Part number: 1244-003474

THERMOSTATS

Thermostats may be required for process temperature maintenance (surface sensing) or freeze protection (ambient sensing) applications. Use the table below to select the appropriate thermostat. For surface sensing, select one thermostat per circuit.

For ambient sensing, select one thermostat per site.

For significant reductions in energy consumption in freeze protection applications, select the RAYSTAT V5. This electronic thermostat continuously matches the heat-tracing output to the pipe heat loss based on the ambient temperature.

| Area | Type | Catalogue number |
|---------------|------------------------------|----------------------------|
| Non-hazardous | Ambient sensing | AT-TS-13 |
| | Proportional Ambient sensing | RAYSTAT-V5 |
| | Surface sensing | AT-TS-14 RAYSTAT-V5 |
| Hazardous | Ambient sensing | ETS-05-A2-E (electronic) |
| | Surface sensing | RAYSTAT-EX-02 (mechanical) |
| | | ETS-05-L2-E (electronic) |

RAYSTAT-V5

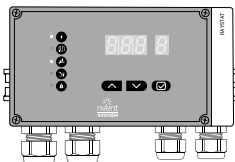

Electronic control thermostat with display, advanced alarm facilities and the capability of switching large currents (25 A). For non-hazardous areas only.

Sensor type: CTN standard 2,0 kOhm à 25°C, 2 wire

Mounting: wall or DIN rail mounted

Setpoint range: 0°C to +90°C

Switching capacity: 20A

Part number: 1244-022440

SM-PT100-1



Plug-in Sensor module for PT 100 sensor – 1 terminal for RAYSTAT-V5

Part number: 1244-022441

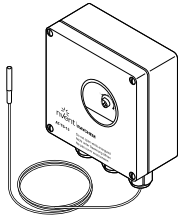
AT-TS-13

Electronic ambient sensing thermostat for use in non-hazardous areas
 Sensor type: PTC KTY 83-110
 Mounting: wall mounted, or pipe mounted using SB-110 or SB-111(option)
 Setpoint range: -5°C to +15°C
 Switching capacity: 16A
 Part number: 728129-000

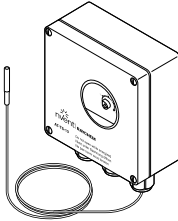
AT-TS-14

Electronic surface sensing thermostat for use in non-hazardous areas
 Sensor type: PTC KTY 83-110
 Mounting: surface mounted, or pipe mounted using SB-110 or SB-111 (option)
 Setpoint range: 0°C to +120°C
 Switching capacity: 16A
 Part number: 648945-000

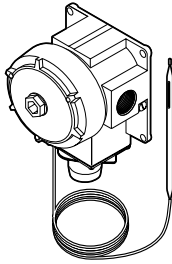
RAYSTAT-EX-02

Mechanical surface sensing thermostat for use in hazardous areas
 Sensor type: bulb and capillary
 Sensor length: 3 m
 Approval: **Ex** II 2GD Ex d IIC T6 (Ta -40°C to +60°C)
 Ex tD A21 IP6X T80°C (-40°C ≤ Tamb ≤ +60°C)
 Mounting: on pipe with SB-100 or SB-101 (option) or surface mounted
 Setpoint range: -4 to +163°C
 Switching capacity: 22 A
 Cable gland (3/4" NPT) to be ordered separately: for armoured cable use GL-33; for non-armoured cable use GL-34.
 Part number: 404385-000

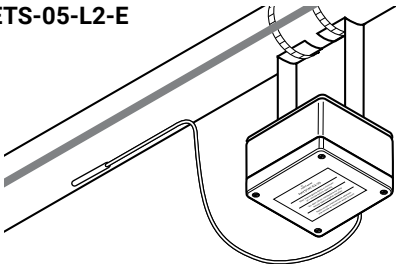
ETS-05-L2-E

Electronic surface and ambient sensing thermostat for use in hazardous areas
 Sensor type: M16 gland with 3 wire PT100 flexible sensor
 Sensor length: 2 m
 Approval: **Ex** II 2(1)G II 2D Ex e ia mb (Ga) IIC T5 Gb Ex tb IIIC T100°C Db Ta -40 to +60°C
 Mounting: Support bracket SB-100, SB-101, SB-110, SB-111, SB-130 or surface mounting with 4 fixing holes on 106 x 82 mm centres
 Setpoint range: 0 to +199°C
 Switching capacity: 32 A resistive load
 Part number: 1244-014367

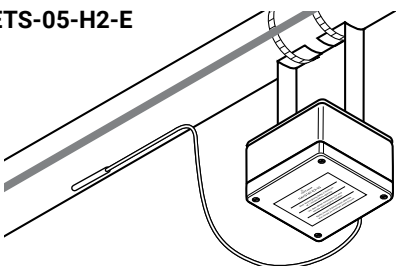
ETS-05-H2-E

Electronic surface and ambient sensing thermostat for use in hazardous areas
 Sensor type: M16 gland with 3 wire PT100 stainless steel sensor
 Sensor length: 2 m
 Approval: **Ex** II 2(1)G II 2D Ex e ia mb (Ga) IIC T5 Gb Ex tb IIIC T100°C Db Ta -40 to +60°C
 Mounting: Support bracket SB-100, SB-101, SB-110, SB-111, SB-130 or surface mounting with 4 fixing holes on 106 x 82 mm centres
 Setpoint range: 0 to +499°C
 Switching capacity: 32 A resistive load
 Part number: 1244-014368

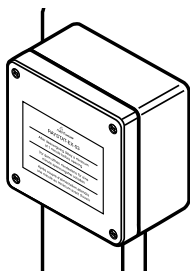
ETS-05-A2-E

Electronic ambient sensing thermostat for use in hazardous areas
 Sensor: MONI-PT100-EXE-AMB sensor
 Approval: No EAC Ex available yet
 Mounting: To be mounted at representative location for correct ambient temperature measurement.
 Setpoint range: 0 to +49°C
 Switching capacity: 32 A
 Part number: 1244-022311

Control and Monitoring products

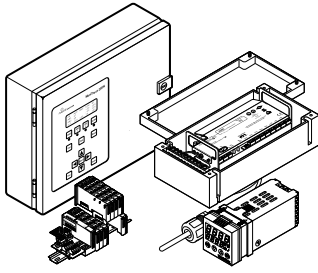

In addition to products in this document, nVent also offers control & monitoring units ranging from single up to hundreds of circuits. For further information, refer to the Product Catalogue for Industrial Heat-Tracing Systems, visit our website (nVent.com) or contact your nVent representative.

ACCESSORIES

Stainless steel support brackets

Support brackets are used to fix equipment such as thermostats or junction boxes on pipes. Support brackets require additional pipe straps which are to be ordered separately. They include a set of M6 and/or M4 fixing screws, nuts, washers and spring lock washers for the fixation of one junction box or thermostat. The table below outlines the typical compatibility of each bracket with relevant equipment, for other equipment please contact your nVent representative.

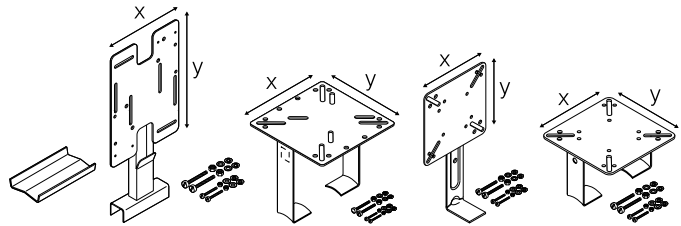

| | SB-100 | SB-101 | SB-110 | SB-111 |
|--------------------------------|----------------|------------|-------------|------------|
| AT-TS-13 | x | x | x | x |
| AT-TS-14 | x | x | x | x |
| JBU-100-E | x | x | | |
| JBU-100-EP | x | x | | |
| RAYSTAT-V5 | x | | x | |
| RAYSTAT-EX-02 | x | x | x | x |
| ETS-05-L2-E | x | x | | |
| ETS-05-A2-E | x | x | | |
| | Technical data | | | |
| plate size (mm) X x Y | 160 x 230 | 160 x 160 | 130 x 130 | 130 x 130 |
| distance pipe-plate (mm) | 100 | 160 | 100 | 100 |
| number of pipe straps required | 2 | 2 | 1 | 2 |
| Part number | 192932-000 | 990944-000 | 707366-0000 | 579796-000 |

WARNING LABELS

Warning labels indicate the presence of electrical heat-tracing under the insulation of the pipe or other equipment. (min. of 1 label per 5 m of heat-tracing line).



| Language | EHT label reference | Product number |
|------------------------------|---------------------|----------------|
| Arabic | LAB-ETL-AR | 036236-000 |
| Bulgarian | LAB-ETL-BG | 1244-002183 |
| Czech | LAB-ETL-CZ | 731605-000 |
| Danish | LAB-ETL-DK | C97690-000 |
| Dutch | LAB-ETL-NL | 749153-000 |
| English | LAB-I-01 | 938947-000 |
| Estonian/English | LAB-ETL-EN/EE | 1244-001415 |
| Finnish/Swedish | LAB-ETL-SE/FI | 756479-000 |
| French | LAB-I-05 | 883061-000 |
| German/French/Italian (230V) | LAB-ETL-DE/FR/IT | 148648-000 |
| German | LAB-ETL-DE | 597779-000 |
| Hungarian | LAB-ETL-HU | 623725-000 |
| Italian | LAB-ETL-IT | C97688-000 |
| Kazakh/Russian/English | LAB-ETL-KZ/RU/EN | 1244-017393 |
| Latvian | LAB-ETL-LV | 841822-000 |
| Lithuanian | LAB-ETL-LT | 105300-000 |
| Norwegian | LAB-ETL-NO | C97689-000 |
| Norwegian/English | LAB-ETL-EN/NO | 165899-000 |
| Polish | LAB-ETL-PL | 258203-000 |
| Portugese | LAB-ETL-PT | 945960-000 |
| Romanian | LAB-ETL-RO | 902104-000 |
| Russian | LAB-ETL-RU | 574738-000 |
| Russian/English | LAB-ETL-EN/RU | 1244-001060 |
| Russian/English/Azeri | LAB-ETL-AZ/RU/EN | 1244-012283 |
| Russian/English/Uzbek | LAB-ETL-UZ/RU/EN | 1244-022143 |
| Spanish | LAB-ETL-ES | C97686-000 |
| Swedish | LAB-ETL-SE | 691703-000 |
| Turkish/English | LAB-ETL-EN/TR | 1244-014860 |



| Language | Component label reference | Product number |
|-----------------|-----------------------------|---------------------------|
| English | LAB-I-02 | 774499-000 |
| Russian/English | LAB-I-02/E/R LAB-ENDSEAL | 1244-001059 146909-000 |
| English | ETL-END-SEAL LAB-SPLICE | 103405-000 007063-000 |

PIPE STRAPS

Are used for fixing components. Select the appropriate pipe strap (stainless steel) according to the pipe diameter. For JBS-100, JBM-100, E-100, E-100-L, T-100 and IEK-25-PIPE, add 25 mm to the pipe diameter.

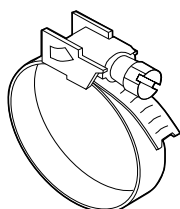

| Pipe outer diameter in mm | (inches) | Pipe strap | Part number |
|---------------------------|-----------------|------------|-------------|
| 20-47 | (1/2" - 1 1/4") | PSE-047 | 700333-000 |
| 40-90 | (1 1/4" - 3") | PSE-090 | 976935-000 |
| 60-288 | (2" - 10") | PSE-280 | 664775-000 |
| 60-540 | (2" - 20") | PSE-540 | 364489-000 |

THERMOSTAT KIT

HWA-WAGO-TSTAT-KIT

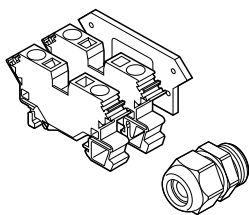

Kit with supplementary terminals to connect thermostat type RAYSTAT-EX-02 to the junction boxes JBS, JBM and JBU.

The kit includes 2 terminals WAGO 284 series (1 x L,1 x PE) and 1 power cable gland GL-36-M25.

Part number: 966659-000

FIXING TAPE

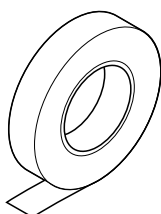

Select the tape according to the pipe material.

Applied in 3 turns every 300 mm across heating cable.

Determine the quantity from the table below.

$$\text{Number of rolls} = \frac{\text{Total pipe length}}{\text{m of pipe per roll}}$$

Add another 20% to allow for fixing the heating cable on valves, flanges, etc. if appropriate.

GT-66 Standard glass cloth tape.
For carbon steel pipes.
20 m per roll.
Part number: C77220-000

GS-54 Glass cloth tape with low halogen content.
For carbon and stainless steel pipes.
16 m per roll.
Part number: C77221-000

For the use of aluminium tape as heat transfer aid, use TraceCalc Pro or TraceCalc Net or consult your nVent representative.

| Pipe size Ø mm | Ø inches | GT-66 m of pipe per roll | GS-54 m of pipe per roll |
|-------------------|-------------|-----------------------------|-----------------------------|
| 8 | 1/4" | 46.5 | 37.2 |
| 15 | 1/2" | 29.9 | 23.9 |
| 20 | 3/4" | 23.8 | 19.1 |
| 25 | 1" | 19.1 | 15.2 |
| 32 | 1 1/4" | 15.1 | 12.1 |
| 40 | 1 1/2" | 13.2 | 10.5 |
| 50 | 2" | 10.6 | 8.4 |
| 65 | 2 1/2" | 8.7 | 7.0 |
| 80 | 3" | 7.2 | 5.7 |
| 100 | 4" | 5.6 | 4.5 |
| 150 | 6" | 3.8 | 3.0 |

PROTECTIVE GROMMET

G-02

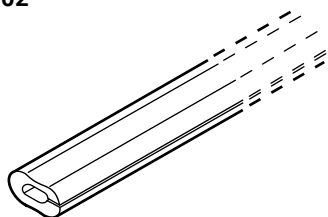

Protective grommet to protect the heating cable from mechanical damage (e.g. at a sharp edge).

Supplied in 1 m sections, to be cut to length.

Part number: 412549-000

GLANDS

GL-33

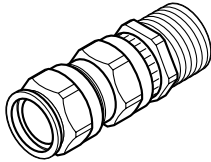

3/4" NPT cable gland (Ex d II C) for RAYSTAT-EX-02.

Nickel plated brass, silicone grommet.

For use with armoured power cables with outer sheath diameter of 13.5 - 21 mm and inner sheath diameter of 10 - 15.5 mm.

PN: 1244-017517

Weight: 0.14 kg

GL-34

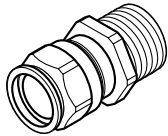

3/4" NPT cable gland (Ex d II C) for RAYSTAT-EX-02.

Nickel plated brass, silicone grommet.

For use with non-armoured power cables with outer sheath diameter of 10 - 15.5 mm.

PN: 1244-017518

Weight: 0.08 kg

GL-36-M25

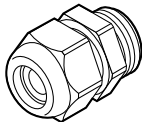

M25 power cable gland (Ex e).

Polyamide.

For use with non-armoured power cables with outer diameter range 8-17,5 mm.

Temperature range: -20°C/+70°C.

Spare part for JBS-100, JBM-100 and JBU-100.

PN: 1244-019082

Weight: 0.016 kg

GL-38-M25-METAL

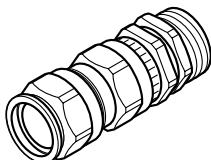

M25 power cable gland (Ex e II and Ex d IIC) for use with junction boxes with internal earth plate (-EP) or metal boxes. Nickel plated brass, silicone grommet.

For use with armoured power cables with sheath diameter of 13.5 - 21 mm and inner sheath diameter 10 - 15.5 mm.

PN: 056622-000

Weight: 0.15 kg

EXAMPLE

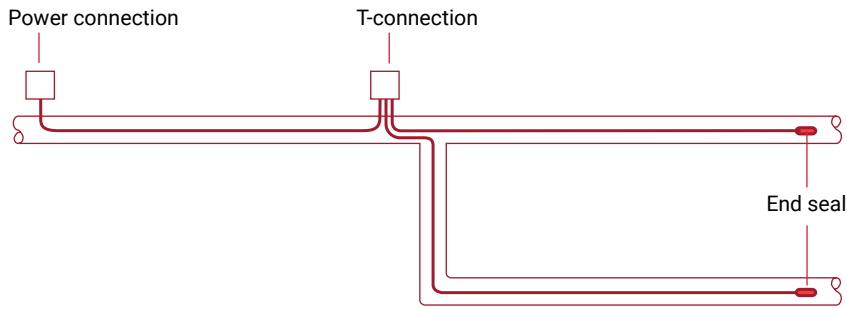

Area classification: Hazardous
Power cables, non-armoured
Pipe Ø: 50 mm
Heating cable type: 8XTV2-CT-T3
Heating cable length: 39 m

Bill of materials
1 x JBS-100-E integrated power connection
1 x T-100 T-connection
2 x E-100 end seal kit
8 x LAB-I-01 warning label
5 x PSE-090 pipe strap
4 x GT-66 fixing tape



Distributor:

Email to:

| | |
|----------------------|------------------------|
| Customer info | Name |
| | Company |
| | Email Date |

| | |
|---------------------------|---------------------------------|
| Project parameters | Project name and location |
| | Done for |
| | Done by |
| | Tel Email |

| | | | |
|--------------------------|----------------------------|---|--|
| Design parameters | Application | <input type="checkbox"/> Frost protection | <input type="checkbox"/> Temperature maintenance |
| | | <input type="checkbox"/> Condensation prevention | |
| | Temperatures | Maintain temperature | °C |
| | | Ambient temperature | min. °C max. °C |
| | | Process temperature | continuous: °C intermittent (upset) max.: °C |
| | | Max. pipe temperature | °C |
| | | Max. allowed pipe temperature | °C |
| | | Start-up temperature | °C |
| | | Pipes are steam-cleaned | <input type="checkbox"/> yes <input type="checkbox"/> no max. temp. °C |
| | Voltage | <input type="checkbox"/> 230 Vac | <input type="checkbox"/> Other Vac |
| | Location | <input type="checkbox"/> Indoors | <input type="checkbox"/> Outdoors |
| | Insulation type | <input type="checkbox"/> Mineral wool (Rockwool) | |
| | | <input type="checkbox"/> Other | Insulation k-factor @ 10°C W/(m · K) |
| | Area Classification | <input type="checkbox"/> Zone 1 | <input type="checkbox"/> Zone 2 <input type="checkbox"/> Zone 11 <input type="checkbox"/> Zone 21 <input type="checkbox"/> Non-Hazardous |
| | Temperature Classification | <input type="checkbox"/> T1 | <input type="checkbox"/> T2 <input type="checkbox"/> T3 <input type="checkbox"/> T4 <input type="checkbox"/> T5 <input type="checkbox"/> T6 <input type="checkbox"/> Non-Hazardous |
| | Pipe material | <input type="checkbox"/> Steel <input type="checkbox"/> Stainless steel <input type="checkbox"/> PE <input type="checkbox"/> PVC <input type="checkbox"/> Other | |

| Lines | | | | | | | | | |
|--------------|---------|---------------|---------------------------|-----------------|---------------|----|----------------------|----|---------|
| | Ref. No | Diameter (mm) | Insulation thickness (mm) | Pipe length (m) | Pipe supports | | Valves /Pumps etc... | | Flanges |
| | | | | | Type | N° | Type | N° | N° |
| 1 | | | | | | | | | |
| 2 | | | | | | | | | |
| 3 | | | | | | | | | |
| 4 | | | | | | | | | |
| 5 | | | | | | | | | |
| 6 | | | | | | | | | |
| 7 | | | | | | | | | |
| 8 | | | | | | | | | |





Europe, Middle East, Africa

Tel +32.16.213.502

Fax +32.16.213.604

thermal.info@nVent.com

Our powerful portfolio of brands:

CADDY ERICO HOFFMAN RAYCHEM SCHROFF TRACER



nVent.com/RAYCHEM