

N36

CHRISTY®

COVER

Style:	Flush
Material:	Composite with UV Inhibitor
Model:	17" x 30"
Weight:	76 lbs
Options:	Special Markings
Surface:	Skid Resistant & Marked*
Coefficient of Friction:	>0.6 ASTM 1028
Performance:	ASTM C 857, WUC 3.6

Cover comes standard with permanent markings for manufacturer, load rating, model size and manufacturing location.

BODY

Material:	Reinforced Concrete with Composite Cap
Model:	22" x 35"
Weight:	172 lbs
Wall Type:	Straight
Mouseholes:	0 - 2
Performance:	ASTM C 857, WUC 3.6

EXTENSION

Material:	Reinforced Concrete
Depth:	12"
Weight:	189 lbs

LOAD RATING / NOTES



LIGHT DUTY
PEDESTRIAN / GREENBELT

For use in non-vehicular traffic situations only. Weights and dimensions may vary slightly. Actual load rating is determined by the box and cover combination.

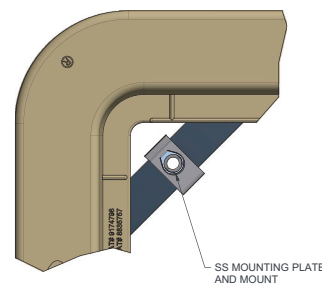
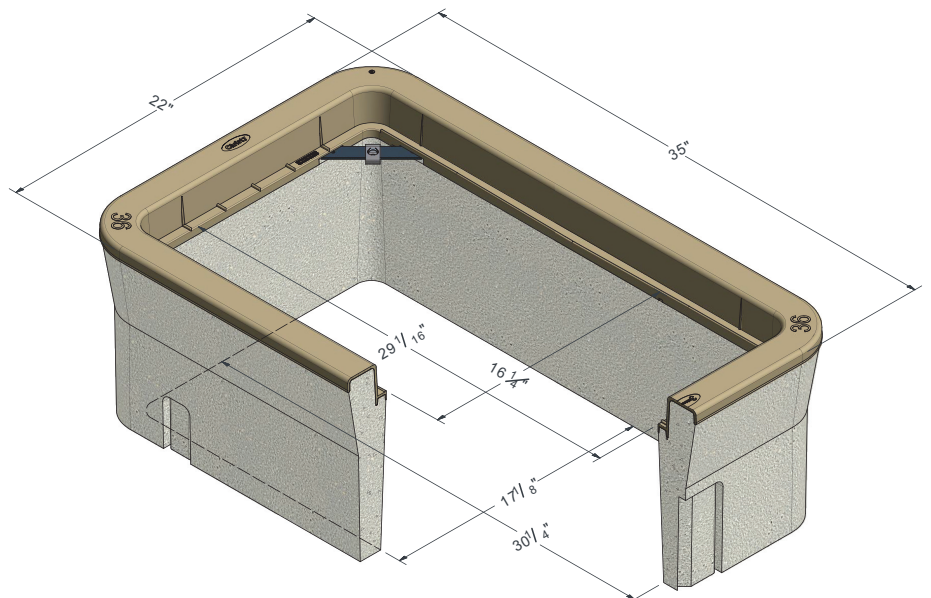
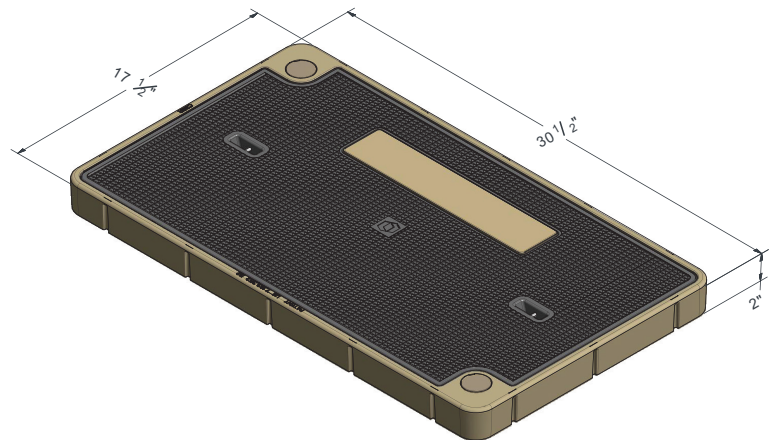

Bolt Down Detail

N36

CHRISTY®

COVER OPTIONS

- R-Series, Flush Solid
- R-Series, Flush with AMR Opening
- Concrete, Flush with Cast Iron Reader Door
- Concrete, Flush with Concrete Reader Lid
- Steel Checker Plate, Solid
- Steel Checker Plate, with Reader Door

COVER OPTIONS

- Bolt Down Locking (R-Series Covers)
- Galvanizing (Steel Covers)
- EMS Marker

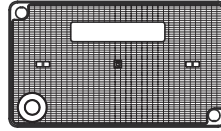

R-Series
with AMR Opening

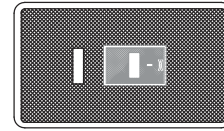

Concrete with
Cast Iron Reader Door

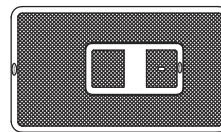

Concrete with
Concrete Reader Lid

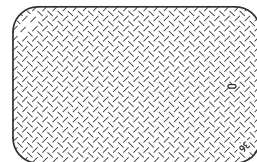

Steel Checker Plate

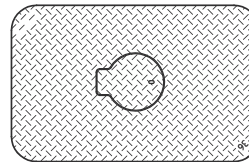

Steel with 8" Round
Reader Door

WARNING: Cancer and Reproductive Harm - www.P65Warnings.ca.gov

All information contained on this sheet is current at the time of publication.
Oldcastle reserves the right to discontinue or update product information without notice.

Revision 12/06/18
© 2018 Oldcastle Infrastructure