

Enerlin'X

Digital Solutions for Smart Systems

Catalog

0614CT1802
04/2019



by Schneider Electric

Legal Information

The Schneider Electric brand and any trademarks of Schneider Electric SE and its subsidiaries referred to in this guide are the property of Schneider Electric SE or its subsidiaries. All other brands may be trademarks of their respective owners.

This guide and its content are protected under applicable copyright laws and furnished for informational use only. No part of this guide may be reproduced or transmitted in any form or by any means (electronic, mechanical, photocopying, recording, or otherwise), for any purpose, without the prior written permission of Schneider Electric.

Schneider Electric does not grant any right or license for commercial use of the guide or its content, except for a non-exclusive and personal license to consult it on an "as is" basis. Schneider Electric products and equipment should be installed, operated, serviced, and maintained only by qualified personnel.

As standards, specifications, and designs change from time to time, information contained in this guide may be subject to change without notice.

To the extent permitted by applicable law, no responsibility or liability is assumed by Schneider Electric and its subsidiaries for any errors or omissions in the informational content of this material or consequences arising out of or resulting from the use of the information contained herein.

Table of Contents

Introduction.....	5
Focus on Smart Systems.....	5
Connected Circuit Breakers with Enerlin'X EIFE Ethernet Add-On Module for Drawout Masterpact MTZ.....	5
Optimized Energy and Operation Monitoring with Enerlin'X Ethernet Gateways and Servers.....	5
Smart System Projects with EcoStruxure™ Power Commission Software.....	6
Improved Maintenance Team Efficiency with EcoStruxure Facility Expert.....	6
Energy Performance Improvements with EcoStruxure Facility Advisor.....	6
Ethernet-Ready Smart Systems.....	7
Future Savings and Peace-of-Mind.....	8
Day-to-Day Energy Management.....	9
Power Availability and Quality, Energy Performance.....	10
Measurement and Protection Devices.....	11
Use Equipment to Collect Electrical Data.....	11
Power and Energy Stand-Alone Metering.....	11
Power Supply and Protection Monitoring, Class 1 Embedded Metering.....	11
Circuit and Load Controls.....	12
Ethernet Ready Smart Equipment.....	13
Plug Electrical Equipment Into the Ethernet LAN.....	13
Enerlin'X Digital System.....	14
Smart System Architectures.....	15
Smart System Configuration Tools.....	15
Smart System Design.....	16
Sources of Useful Information in Electrical Equipment.....	16
Masterpact MTZ System Information.....	17
Masterpact NT/NW and PowerPact Circuit Breaker System Information.....	19
Masterpact Enerlin'X Functions.....	20
PowerPact H/J/L Circuit Breakers.....	21
Enerlin'X Gateways and Interface Connectivity.....	23
Enerlin'X Components for Smart Systems.....	24
Enerlin'X Digital Systems.....	24
Enerlin'X Component Overview.....	25
Com'X 210.....	26
Com'X 210 Energy Data Loggers.....	26
Com'X 210 Functions and Characteristics.....	27
Com'X 510.....	28
Com'X 510 Energy Saver.....	28
Com'X 510 Functions and Part Numbers.....	29
Com'X 210/510.....	30

Com'X 210/510 Connectivity	30
Com'X 210/510 Setup and Configuration	32
Com'X 210/510 Specifications	33
FDM128 Ethernet Display	34
FDM128 Status Indications	34
FDM128 Remote Control	34
FDM128 Main Characteristics	35
FDM128 Mounting	35
FDM128 Navigation	35
Communication Components and FDM128 Connection	36
FDM121 System Display	37
FDM121 Display of Micrologic Measurements and Alarms	37
FDM121 Status Indications and Remote Control	37
FDM121 Main Characteristics	38
FDM121 Mounting	38
FDM121 Navigation	39
Communication Components and FDM121 Connections	40
IFE System Interface	41
IFE System Interface Description	41
IFE System Required Circuit Breaker Communication Modules	41
IFE System General Characteristics	42
IFE Interfaces, IFE Switchboard Server Web Pages	43
EIFE Embedded Ethernet Interface for Drawout Devices	44
EIFE Embedded Ethernet Interface Description	44
EIFE Required Circuit Breaker Communication Accessory	45
EIFE General Characteristics	45
EIFE Web Page Description	46
Link150 Ethernet Gateway for System	46
IFM Modbus Interface for System	49
IFM Modbus Interface Function	49
IFM Modbus Interface Characteristics	49
IFM Catalog Numbers and Technical Characteristics	51
Recommended IFM Installation	52
IO Application Module for System	53
IO Application Module Description	53
IO Application Module Characteristics	55
Commissioning Software	57
EcoStruxure Power Commission Software	57
Ecostruxure Facility Expert Cloud-Based Software	59
Commercial References	61
Meters and Auxiliary Devices	61
Commercial Reference Numbers	62

Introduction

Focus on Smart Systems

Connected Circuit Breakers with Enerlin'X EIFE Ethernet Add-On Module for Drawout Masterpact MTZ



Ethernet connection with EIFE Ethernet add-on module or Micrologic™ X control unit + IFE interface

The EIFE module is directly mounted on the cradle, saving space and wiring.

An IP address is provided to drawout Masterpact™ MTZ devices.

The Enerlin'X™ IFE interface remains the solution for fixed Masterpact™ MTZ devices.

Micrologic X control unit with the IFE interface is an alternative for connecting any Masterpact MTZ to Ethernet, with extended possibilities (refer to catalog *0614CT1701 Masterpact MTZ Circuit Breakers and Switches*).

Optimized Energy and Operation Monitoring with Enerlin'X Ethernet Gateways and Servers



Energy Server Com'X 510 DataLogger

Com'X 510: compact plug and play gateways and data logger. This is an important part of an entry level energy management system, enabling monitoring and logging of data from various devices installed in a building.

- Aggregation of WAGES (Water, Air, Gas, Electricity, and Steam).
- Environmental parameters (Temperature, Humidity, CO₂).

Com'X 510 provides access to reports such as on-board device and circuit summary pages, as well as on-board data logs. Data can be securely accessed in real time or transmitted as a report to an Internet database server (cloud platform).



IFE Switchboard Server

IFE switchboard server: is mainly dedicated to communication with low-voltage power circuit breakers (Ethernet or Modbus SL) to enable remote monitoring, logging of circuit breaker data (such as status and electrical measurements), and circuit breaker control operations.

Smart System Projects with EcoStruxure™ Power Commission Software



Use EcoStruxure Power Commission software on a PC for faster, easier Smart System project setup and operation.

EcoStruxure Power Commission software is an invaluable tool during commissioning, testing, and maintenance phases of the project life cycle.

It provides automatic device discovery, communication tests, and other functions that help save time and avoid errors.

EcoStruxure Power Commission software generates reports and creates a repository of projects in the Cloud.

Improved Maintenance Team Efficiency with EcoStruxure Facility Expert



EcoStruxure™ Facility Expert helps facility manager and maintenance teams, keep key assets up and running and improve maintenance efficiency.

Use EcoStruxure Facility Expert is on smartphone, tablet, online or offline, to simplify operation & maintenance:

- automated notifications in case of issue, see where the problem is and quickly implement corrective actions
- immediate access to all data needed to maintain assets efficiently (operations history, maintenance plan, or technical documentation), from anywhere
- information sharing with maintenance team in real time for more efficient, traceable troubleshooting.

EcoStruxure Facility Expert gathers data, generates maintenance Reports, stores and send them to the right person.

Energy Performance Improvements with EcoStruxure Facility Advisor



Energy performance follow-up and improvement is possible with EcoStruxure Facility Advisor

EcoStruxure Facility Expert helps business owners and site managers reduce their energy costs.

On a web portal, it gives insights into energy data and provides the visibility needed to reduce energy consumption.

Facility managers get a clear vision on real time energy consumption for all managed sites from any location.

Advanced management functions are provided: energy allocation per zone and usage, performance comparison with relevant indicators, overrun power demand tracking. With EcoStruxure Facility Advisor, organizations can easily comply with ISO5001 and buildings meet quality certification such as LEED, Nabers, etc.

Ethernet-Ready Smart Systems

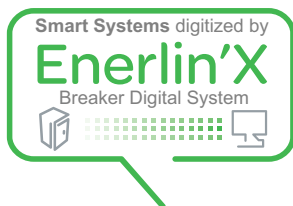

Ethernet-ready Smart Systems enable electrical distribution control and expertise. “Protect”, “Measure”, and “Connect” are the three pillars of this technology.

1. **Connect**

Give a voice to the equipment.

Secured Ethernet network data transmission is part of the design of protection and metering devices.

2. **Measure**

Keep a close eye on energy flows.

The electrical equipment captures building-related data, by gathering it from the critical protection and metering components.

3. **Protect**

Electrical protection is at the core of Smart Systems.

High-performance technology is built into every circuit breaker.

4. **Act**

Future savings, peace-of-mind

Access to Smart System status and values is essential for taking advantages of monitoring and management services, locally or remotely.

Future Savings and Peace-of-Mind

Access Smart System status and values to take advantages of monitoring and management services, locally or remotely.

Access large, non-critical buildings with EcoStruxure Building and with EcoStruxure Energy Expert.

Access Small/Medium Buildings with FDM128, Com'X 510, IFE, EcoStruxure™ Facility Expert

Optimize Energy Efficiency

- Visualize, record energy consumption and WAGES.
- Comply with regulation.



Local electrical device monitoring and control with FDM128.



View device data on Com'X 510 web pages or IFE web pages (PowerView)



Remote management with EcoStruxure Facility Expert on Smartphone, tablet, or PC

Improve Continuity of Service

- Get instant notifications.
- Manage with assets-maintenance platform.
- Get and analyze data for quick crisis-recovery.

Increase Maintenance Efficiency

- Operate preventive maintenance tools.
- Follow maintenance & planning.
- Provide business owner instant access to maintenance reports.

Day-to-Day Energy Management

Access Large, Non-Critical Buildings with EcoStruxure Building and EcoStruxure Energy Expert

For dealing with building user's needs and energy constraints. EcoStruxure Building Management provides electrical management, monitoring and energy accounting.



Manage Equipment and Key Assets

- Check operating status on custom one-line diagrams.



Monitor the Electrical Network

- Observe voltage disturbances and harmonics.
- See power factor information.



Account for Energy

- Record power meter data on dashboards.
- Allocate energy consumption with costs.
- Follow conservation goals.

Power Availability and Quality, Energy Performance

Access Large, Critical Buildings with EcoStruxure Power Monitoring Expert

Energy decisions are often crucial in large critical buildings.

EcoStruxure Power Monitoring Expert PC software collects Smart System values to provide expert analysis.



*http://
pmedemo.
biz/web/
ID: demo &
Password:
demo*

EcoStruxure
Power
Monitoring
Expert



Analyze Power Events

- Speed up downtime crisis recovery.
- Determine incident root cause, events sequence.
- Troubleshoot power quality issues.



Monitor the Electrical Network

- Observe voltage disturbances and harmonics.
- See power factor information.



Account for Energy

- Record power meter data on dashboards.
- Allocate energy consumption with costs.
- Follow conservation goals.

Measurement and Protection Devices

Use Equipment to Collect Electrical Data

Thirty percent of energy used in commercial buildings is wasted on average (Source: US Environmental Protection Agency, US Department of Energy)

Electrical equipment is the most convenient location to collect data about electrical supplies throughout the building.

Schneider Electric provides a variety of devices for electrical protection, control, and measurement.

Schneider Electric also creates new digital possibilities through connectivity using the EnerlinX system components embedded in the Schneider Electric power operating devices.

Power and Energy Stand-Alone Metering

PowerLogic™ Meters

Monitor key distribution points 24 hours a day, from generators, substations, and service entrances to mains, feeders, and loads. All data is accessible locally or remotely. Help improve network reliability by tracking real-time power quality, equipment status, trending loads, and logging events and alarms.



Energy Metering Solutions

Energy meters for a variety of applications: single-phase (iEM2000 series) or three-phase (iEM3000 series) circuits, basic kWh meters for elementary applications to MID-compliant meters for billing applications, and advanced energy meters capable of measuring a variety of electrical parameters. Data is visible locally or accessible remotely.



Power Supply and Protection Monitoring, Class 1 Embedded Metering



Masterpact circuit breakers with Micrologic control units provide operating status, electrical measurements, diagnostics, and maintenance information. The embedded control units reduce the installation cost and provide valuable data to facility managers and maintenance technicians for use in daily and periodic tasks.

The Masterpact MTZ app “EcoStruxure Power Device” makes information from main circuit breakers visible on a smartphone.

Circuit and Load Controls

To improve user comfort, lighting or other loads are switched on and off— independently or together—via the digital system. This can be done via remote instruction to the device (using a MX/XF/MN tripping device) or by a predefined schedule.

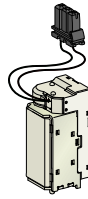

MX, XF for Masterpact NT/NW and PowerPact P/R



XF, MX, MN for Masterpact MTZ



MX, MN for PowerPact H/J/L

Ethernet Ready Smart Equipment

Plug Electrical Equipment Into the Ethernet LAN



Ethernet is the most widespread communication protocol in professional buildings, providing fast data transmission.

With the Enerlin'X digital system, electrical equipment can be connected via Ethernet like any other device through an RJ45 socket.



Enerlin'X Digital System

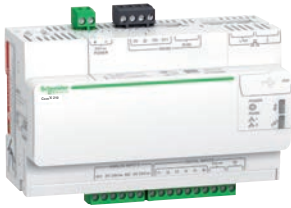

Com'X 210 Energy Data Logger

- Collects WAGES¹ data from various devices throughout the building
- Delivers batches of data ready to be processed by StruxureWare™ solutions or Facility Insight Services (direct connectivity) or any online service

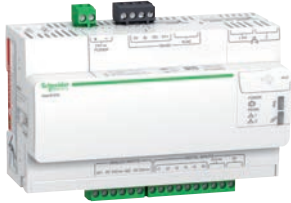

Com'X 510 Energy Saver

- Collects WAGES¹ data from device sensors throughout the building
- Provides detailed and global views of energy consumption allowing to detect the most important savings opportunities accessible via a web browser



Enerlin'X IFE

- Ethernet communication interface for power circuit breakers.
- Embedded web pages for energy control, and maintenance.
- Modbus master, with automatic detection and configuration of "slave" devices.
- Switchboard server aggregates, computes, and displays data from all devices in the switchboard, connected either by Modbus serial or Ethernet.
- Automatic e-mail sent upon configured events Enerlin'X IFM.



Enerlin'X IFM

- Modbus connection and data collection for one PowerPact or Masterpact device.



Enerlin'X IO

- Provides tailored additional functions such as drawout circuit breaker cradle position and ERMS (Energy Reduction Maintenance Setting).

1. Water, Air, Gas, Electricity, Steam

Smart System Architectures

Smart System has been certified through Schneider Electric's "TVDA" quality process.

Tested in performance labs by experts, in various possible configurations.

Validated full functional compatibility of devices.

Documented, with user guide, predefined CAD panel designs and wiring diagrams.

Schneider Electric labs have validated that Smart Panels digital architectures are ready to implement.

Technical guides are available online to explain, step by step, how to arrange Enerlin'X components to transform electrical equipment into Smart Systems.

- ULP System for Masterpact and PowerPact - User Guide (0602IB1503)
- Data Acquisition Guide Tech Guide

Smart System Configuration Tools

As a part of the Schneider Electric services library, EcoStruxure Power Commission software is designed for project management

With EcoStruxure Power Commission software, electrical devices are configured, tested and commissioned in the simplest way.

EcoStruxure Power Commission software reduces the commissioning time of electrical equipment by 70% and supports the system during operation and maintenance.

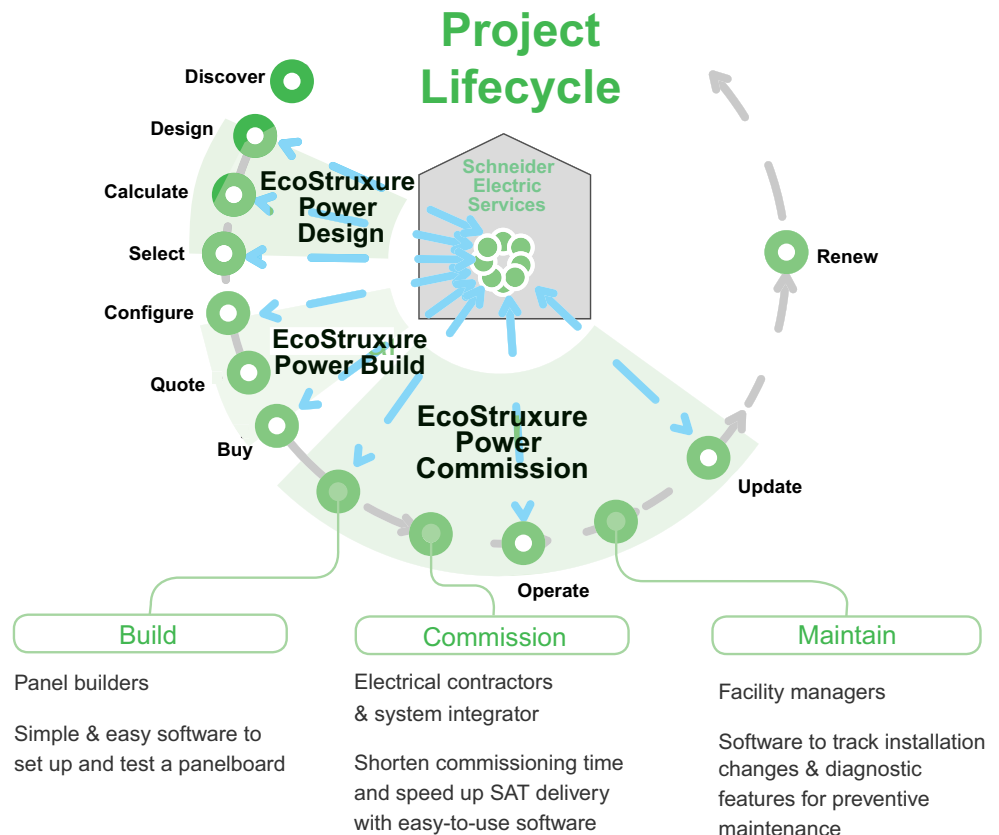

Smart System Design

Sources of Useful Information in Electrical Equipment

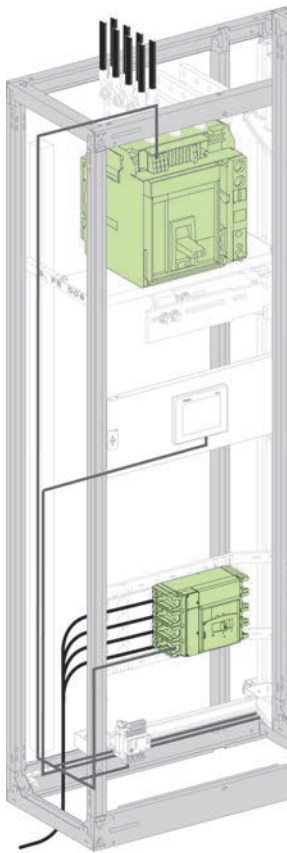

- Auxiliary contacts indicate circuit breaker status.
- Embedded sensors provide electrical values.
- Status contacts and sensors are monitored by the embedded Micrologic control unit.

Web pages generated by the IFE interface, the IFE switchboard server, or the EIFE interface (for drawout Masterpact MTZ) monitor circuit breaker information:

Monitoring Electrical Values—Circuit Breaker Status

Basic Reading: Micrologic H			
Load Current (A)	Power	Voltage LL	Voltage LN
●	—	—	—
Parameter	Minimum	Present	Maximum
Breaker Status		Open	

Information for Maintenance

Micrologic H (Arch 1)	
Operation Counters	Counters Value
Circuit Breaker Operation	
Total number of indication contacts (OF) operation	54
Indication contacts (OF) operation since last reset	54
Trip indication contact (SD) operation	—
Fault trip indication contact (SDE) operation	78
Contact wear indicator	—
Cradle Operation	
Cradle connected	62
Cradle disconnected	20
Cradle test	7

Masterpact MTZ System Information



Masterpact MTZ

Masterpact MTZ has embedded Class 1 accuracy for active power and energy measurement, compliant and third-party certified as per IEC 61557-12.

The Masterpact MTZ circuit breaker’s new Micrologic X control unit and EIFE interface module makes the Masterpact MTZ circuit breaker a connected device, providing data, wireless and Ethernet communication for mobile smart devices as well as tripping the circuit breaker in case of necessity and monitoring the downstream circuit. Alarms may be programmed for remote indications. Electrical measurements and operation data for predictive maintenance are provided for local display or distant monitoring.

Micrologic X Control Unit Protection Functions

The Micrologic X control unit is suitable for different systems of voltage, three or four wires up to 600 Vac, 50/60 Hz and for grounded systems.

<p>Micrologic 3.0 X</p>	<p>LI: Long time + Instantaneous</p>		
<p>Micrologic 5.0 X</p>	<p>LSI: Long-time + Short-time + Instantaneous</p>		
<p>Micrologic 6.0 X</p>	<p>LSIG: Long-time + Short-time + Instantaneous + Ground-fault</p>		

Layout of the Micrologic X Control Unit

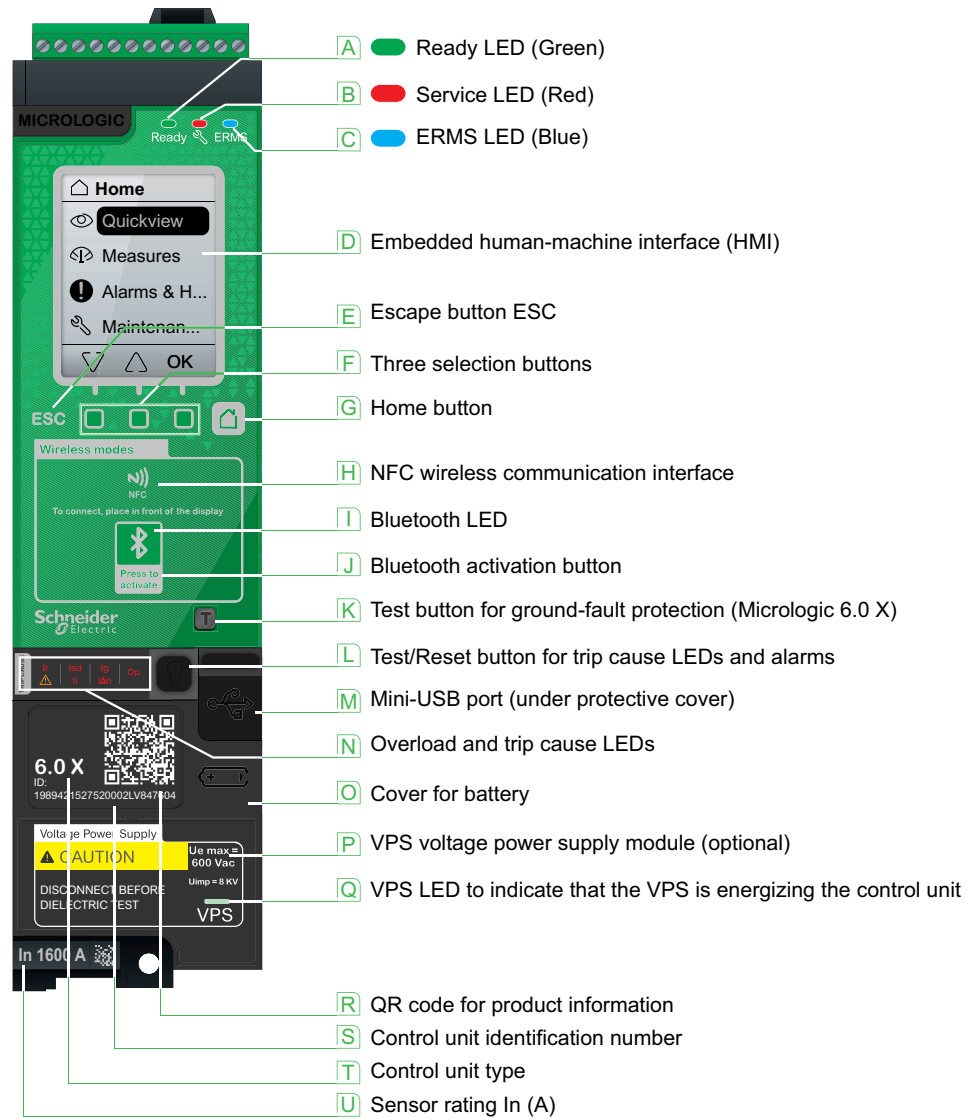

Masterpact NT/NW and PowerPact Circuit Breaker System Information



Micrologic Trip Units



BCM ULP Communication Module

Provides ULP communication port to a Micrologic trip unit, giving monitoring and control access from upstream networks.

Masterpact NT/NW and Powerpact P/R circuit breakers can be equipped with a Micrologic trip unit. This adjustable unit is mainly designed for tripping the circuit breaker in case of necessity and monitoring the downstream circuit. Alarms may be programmed for remote indications. Electrical measurements, operation data for predictive maintenance, are provided for local display or distant monitoring.

Available Functions	Micrologic Type		
	A	P	H
Status Indications			
ON/OFF (O/F)	●	●	●
Spring charged CH	●	●	●
Ready to close	●	●	●
Fault-trip SDE	●	●	●
Connected / disconnected / test position CE/CD/CT	●	●	●
Controls			
MX1 open	●	●	●
XF close	●	●	●
Measurements			
Instantaneous measurement information	●	●	●
Averaged measurement information	—	●	●
Maximeter / minimeter	●	●	●
Energy metering	—	●	●
Demand for current and power	—	●	●
Power quality	—	—	●
Operating Assistance			
Protection and alarm settings	—	●	●
Histories	—	●	●
Time stamped event tables	—	●	●
Maintenance indicators	●	●	●

Masterpact Enerlin'X Functions

Fixed Masterpact NT/NW, PowerPact P/R Circuit Breaker

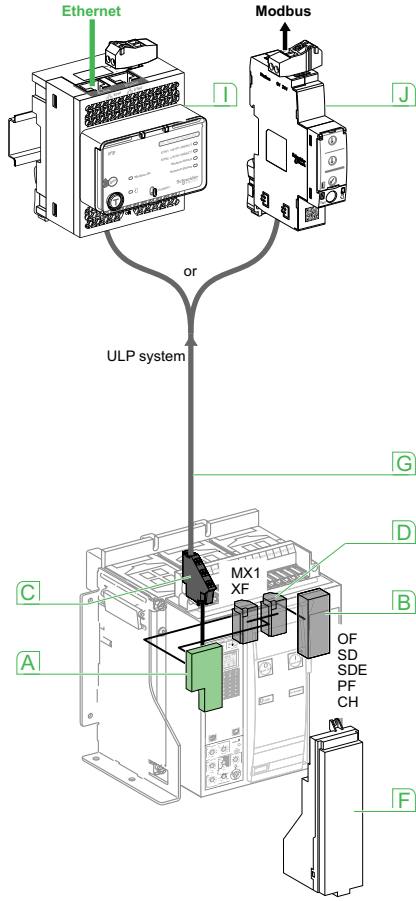

Drawout Masterpact NT/NW, PowerPact P/R Circuit Breaker

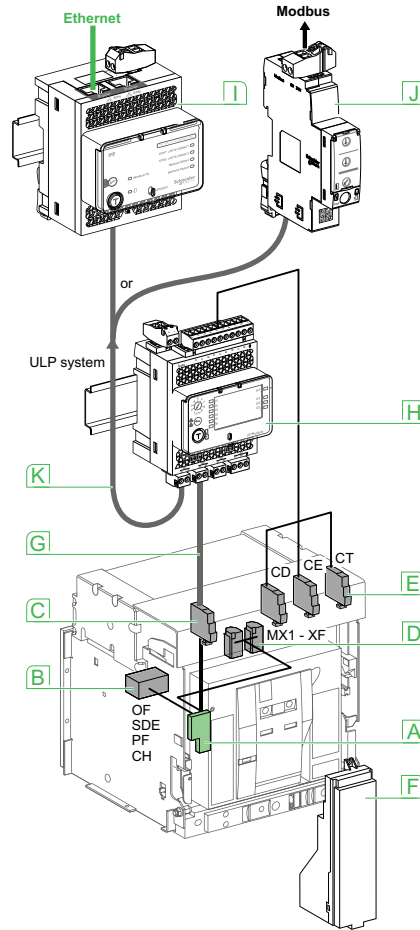

Fixed Masterpact MTZ Circuit Breaker

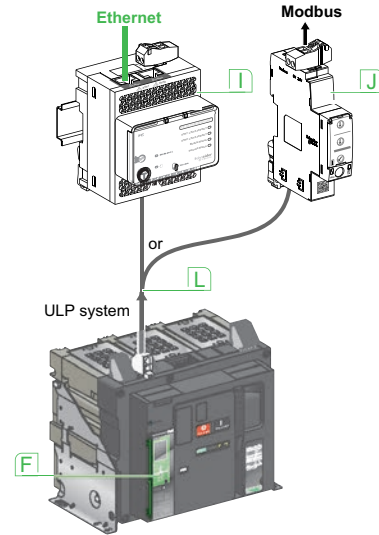

Drawout Masterpact MTZ Circuit Breaker

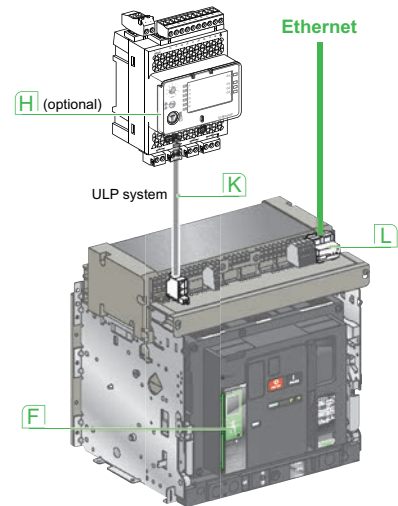

ULP system	IFE, EIFE interfaces	IFM	IO
<p>The ULP system is a fast communication link dedicated to circuit breaker monitoring and control.</p> <p>Based on a RS485 physical liaison with cable segments up to 5 meters, it is well adapted to severe environment.</p> <p>A choice of 6 cables of different lengths is provided.</p>	<p>ULP to Ethernet interface module provides an IP address to any circuit breaker (EIFE is dedicated to Masterpact MTZ) directly accessible from an Ethernet compatible display (FDM128), a PC with common browser, or IFE switchboard server which generates its own web pages</p>	<p>ULP to Modbus Interface module makes all available data of a circuit breaker fitted with an ULP port accessible via a Modbus network.</p> <p>IFM acts as a Modbus slave, accessible from a Modbus master (IFE switchboard server, or Com'X device).</p>	<p>IO application module is dedicated to circuit breakers with ULP liaison.</p> <p>It provides the monitoring of the cradle position by means of CE, CD, CT contacts and control of applications around the circuit breaker (lighting or load control, coding system, pulse metering acquisition...).</p>

- A BCM ULP
- B OF, SDE... microswitches
- C COM terminal block (E1 to E6)
- D MX1 and XF communicating voltage releases
- E CE, CD and CT contacts
- F Micrologic trip unit
- G Breaker ULP cord
- H IO module
- I IFE interface module
- J IFM module
- K ULP cable
- L EIFE Module

PowerPact H/J/L Circuit Breakers

PowerPact H/J/L Status and Electrical Values

Available Information and Functions

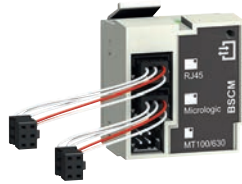

BSCM (Required by trip unit for Open/Closed and Fault-trip SDE)



Micrologic Trip Units—3 pole



Micrologic Trip Units—4 pole

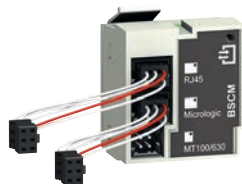

Available Functions	Micrologic Type	
	A	E
Status Indications		
Open/Closed	●	●
Fault-trip SDE	●	●
Connected / disconnected / test position CE/CD/CT (IO module only)	●	●
Controls		
Open	●	●
Close	●	●
Measurements		
Instantaneous measurement information	●	●
Averaged measurement information	—	●
Maximeter / minimeter	●	●
Energy metering	—	●
Demand for current and power	—	●
Power quality	—	●
Operating assistance		
Protection and alarm settings	●	●
Histories	●	●
Time stamped event tables	●	●
Maintenance indicators	●	●

Micrologic Trip Unit

Electronic-trip PowerPact H/J/L circuit breakers are equipped with a Micrologic trip unit. This adjustable unit is mainly designed for tripping the circuit breaker in case of necessity and monitoring the downstream circuit. Alarms may be programmed for remote indications.

Electrical measurements, operation data for predictive maintenance, are provided for local display or distant monitoring.

BSCM Module

This module provides a ULP communication port for these circuit breaker's Micrologic trip unit, giving monitoring and control access from upstream networks, Modbus or Ethernet.

PowerPact Enerlin'X Functions

Fixed Circuit Breaker

Drawout Circuit Breaker

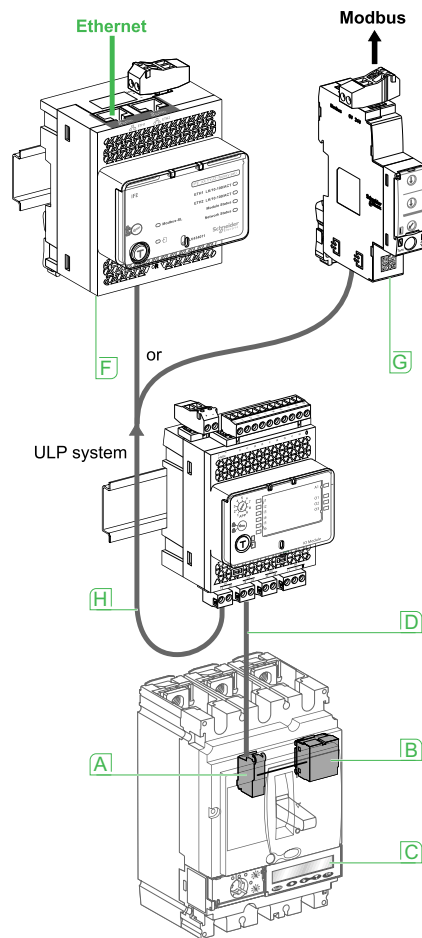
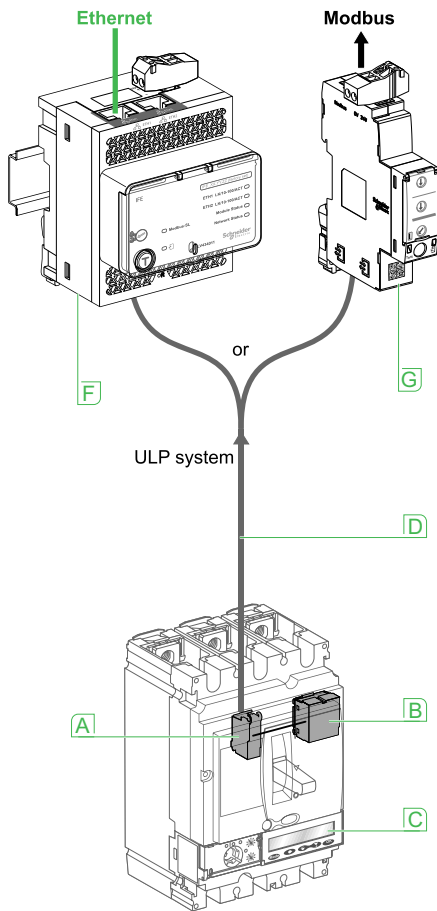

- A** Internal terminal block for communication via NSX cord
- B** BSCM module
- C** Micrologic trip unit
- D** NSX cord
- E** IO module
- F** IFE interface module
- G** IFM module
- H** ULP cable

ULP System	IFE Interface	IFM Interface	IO Application Module
<p>The ULP system is a fast communication link dedicated to circuit breaker monitoring and control.</p> <p>Based on a RS485 physical liaison with cable segments up to 5 meters, it is well adapted to severe environment.</p> <p>A choice of 6 pre-connected cables with different length is provided.</p>	<p>The IFE ULP to Ethernet interface module provides an IP address to any circuit breaker fitted with a ULP port.</p> <p>The IFE interface makes all available data from the circuit breaker accessible from an Ethernet compatible display (FDM128), a PC with common browser, or IFE switchboard server which generates its own web pages.</p>	<p>The IFM ULP to Modbus Interface module makes all available data of a circuit breaker fitted with an ULP port accessible via a Modbus network.</p> <p>The IFM acts as a Modbus slave, accessible from a Modbus master (IFE switchboard server or Com'X device).</p>	<p>The IO application module is dedicated to circuit breaker with ULP liaison. It provides the monitoring and control of any application around the circuit breaker (lighting or load control, cooling system, pulse metering acquisition...).</p>

Enerlin'X Gateways and Interface Connectivity

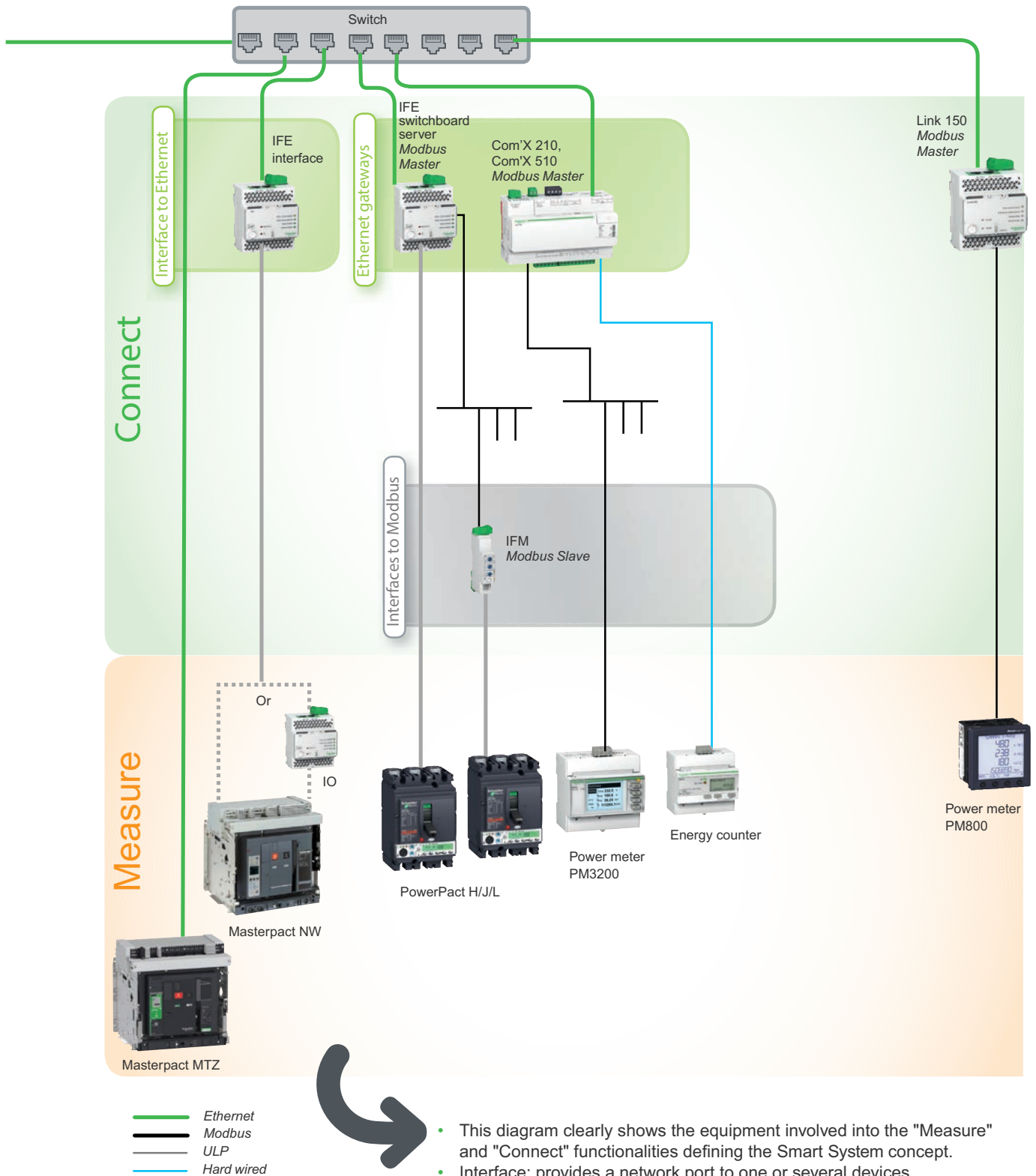

- This diagram clearly shows the equipment involved into the "Measure" and "Connect" functionalities defining the Smart System concept.
- Interface: provides a network port to one or several devices (circuit breakers, actuators, counters,...) from their hard wired or ULP links.
- Gateway: provides the communication between two networks with different protocols (Ethernet and Modbus).

Enerlin'X Components for Smart Systems

Enerlin'X Digital Systems

Enerlin'X communication system provides access to status, electrical values and devices control using Ethernet and Modbus Serial communication protocols.





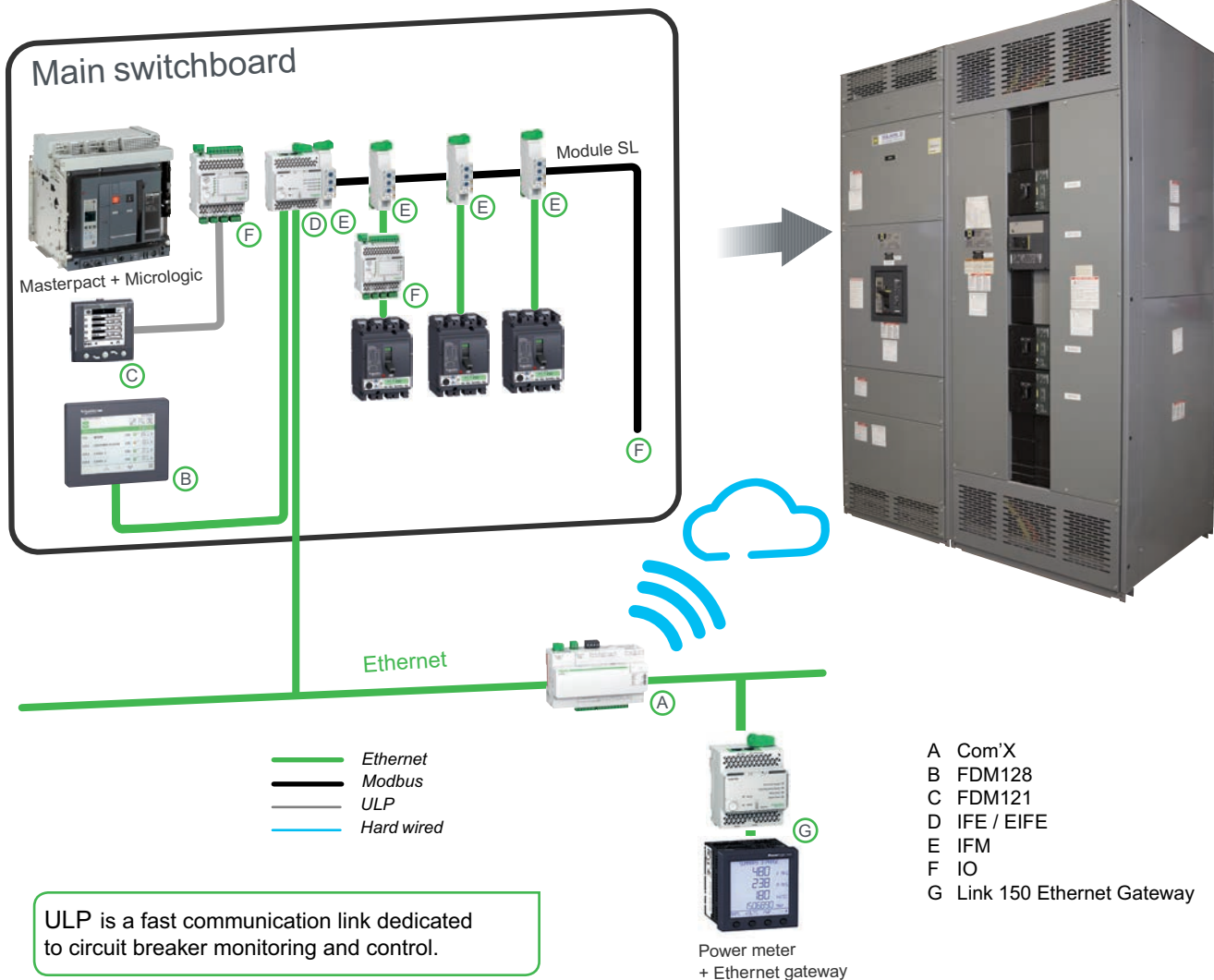

Ethernet has become the universal link between electrical equipment, computers and communication devices inside buildings. The large amount of information which can be transferred makes the connection of Enerlin'X digital system to hosted web services of Schneider Electric a reality. Using configuration web pages available remotely or on the local Ethernet network allows integrators access to information about the electrical system.

Modbus is the most widely used communication protocol in industrial networks.

It operates in master-slave mode. The devices (slaves) communicate one after the other with a gateway (master).



Enerlin'X Component Overview

Enerlin'X Digital Devices and Displays							
	Name	Function	Port		Inputs	Outputs	Reference
			(to device)	(to server)			
	Com'X 210 24 Vdc + PoE	Energy data logger+ Ethernet Gateway	Ethernet Modbus Master ZigBee (to wireless meters)	Ethernet (cable or Wi-Fi)	64 devices 6 digital, 2 analog, 32 Modbus devices + other Ethernet devices (Modbus TCP)	—	<i>EBX210</i>
	Com'X 510 24 Vdc + PoE	Energy server + Ethernet					<i>EBX510</i>
	FDM128	Ethernet LCD color touch screen for 8 circuit breakers	Ethernet	Ethernet	—	—	<i>LV434128</i>
	FDM121	LCD display for 1 circuit breaker	ULP	ULP	1 circuit breaker	—	<i>STRV00121</i>
	IFE Switchboard server	Switchboard server	Modbus Master & ULP	Ethernet	20 circuit breakers	—	<i>LV434002</i>
	IFE interface	Ethernet interface for circuit breakers	ULP	Ethernet	1 circuit breaker	—	<i>LV434001</i>
	EIFE embedded interface	Ethernet interface for Masterpact MTZ drawout circuit breaker	ULP	Ethernet	1 circuit breaker	—	<i>LV851001SP</i>
	IFM	Modbus interface for circuit breaker	ULP	Modbus slave	1 circuit breaker	—	<i>LV434000</i>
	IO	Input/Output application module for circuit breaker	ULP	ULP	6 digital 1 analog (PT100 sensor)	3 digital	<i>LV434063</i>
	Link 150 Ethernet gateway	Ethernet gateway for Modbus slave device	Modbus Master	Ethernet	32 directly or 247 indirectly coded devices	—	<i>EGX150</i>

Ethernet Gateway or Interface: routes an internal traffic (ULP or other protocols) to the Ethernet, with output in Modbus TCP/IP.

Server (Switchboard, Energy): routes the internal traffic to the Internet. Provides other complementary functions such as data logging and storage. Provides devices status and energy trends on embedded web pages.

Com'X 210

Com'X 210 Energy Data Loggers

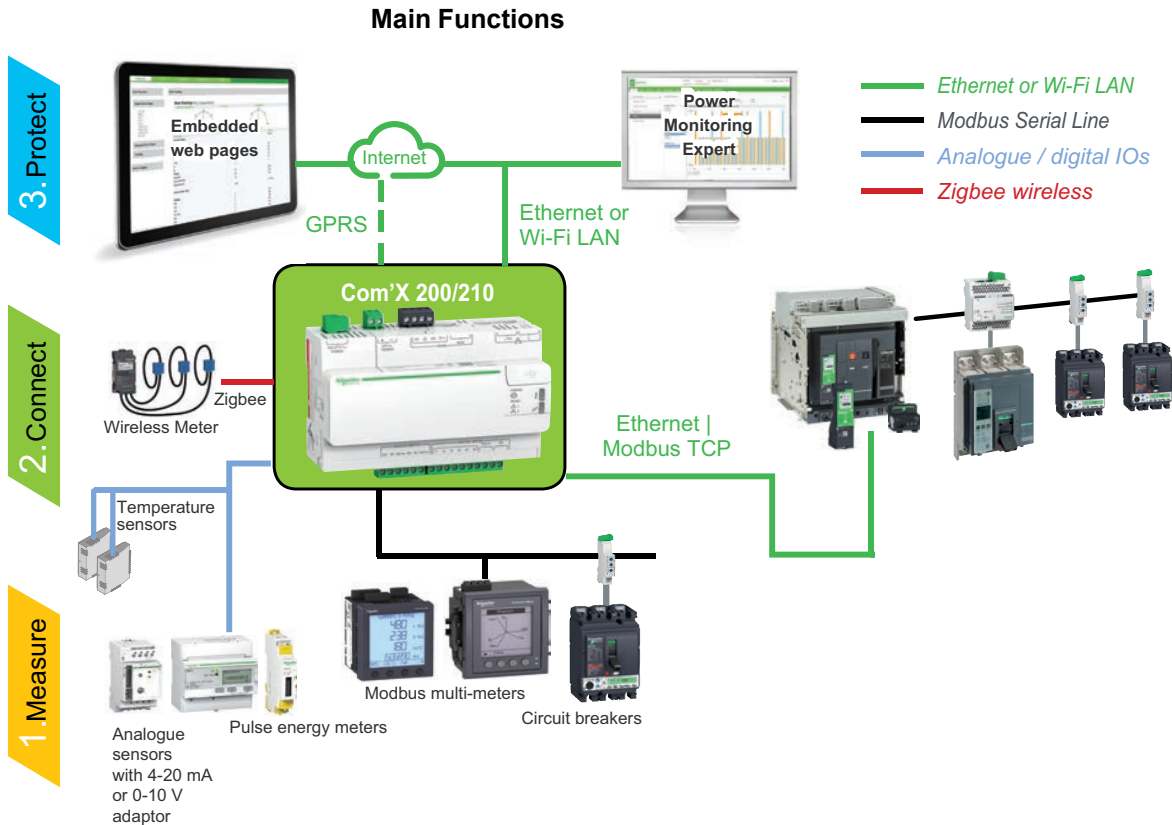

Data collector

Collects and stores energy data from up to 64 field devices, connected to either:

- Ethernet TCP/IP field network.
- Modbus Serial line network (up to 32 devices).
- Embedded digital and analogue inputs.

"Field devices" consist of:

- PowerLogic meters for power and energy monitoring.
- Masterpact, PowerPact, or Compact circuit breakers for protection and monitoring.
- Water, Air, Gas, Electricity, and Steam consumption meters, from specialized manufacturers, delivering pulses as per standard (see table at end of this document).
- Environmental sensors for temperature, humidity, and CO₂ levels in a building, providing analogue input.

Data logging and storage capabilities include:

- Data logging period: can be configured from every minute to once a week.
- Data storage duration: up to two years, depending on quantity of collected data.

Com'X 210 Functions and Characteristics



Com'X 210 data logger

Data Publisher

Batches of collected data periodically transmitted to an Internet server, as:

- XML files, for processing by EcoStruxure Analytics & Services Products, such as Facility Advisor
- CSV files for viewing in Excel or transformed for upload into programs such as EcoStruxure Power Monitoring Expert or any compatible software
- Support for Weather Sentry™.

Data publishing function supports 4 transfer protocols over Ethernet or Wi-Fi:

- HTTP
- HTTPS
- FTP
- SMTP.

Gateway

If selected by the user, the Com'X 210 can also make all data from connected devices available in real-time:

- in Modbus TCP/IP format over Ethernet or Wi-Fi
- for requests by an energy management software
- gateway to Zigbee device data by external Modbus TCP/IP clients.

Modbus packets can be sent from managing software to field devices through Modbus serial line or Modbus TCP/IP over Ethernet.

Com'X 210 Catalog Numbers

Com'X 210 data logger 24 Vdc power supplied UL rated	<i>EBX210</i>
Com'X Wi-Fi USB interface	<i>EBXA-USB-WiFi</i>
Com'X GPRS interface SIM card	<i>EBXA-GPRS-SIM</i>
Com'X GPRS interface	<i>EBXA-GPRS</i>
Com'X External GPRS antenna	<i>EBXA-ANT-5M</i>
Com'X Zigbee USB interface	<i>EBXA-USB-Zigbee</i>

Please see your Schneider Electric representative for complete ordering information.

Com'X 510

Com'X 510 Energy Saver

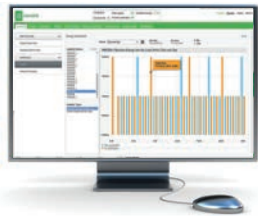
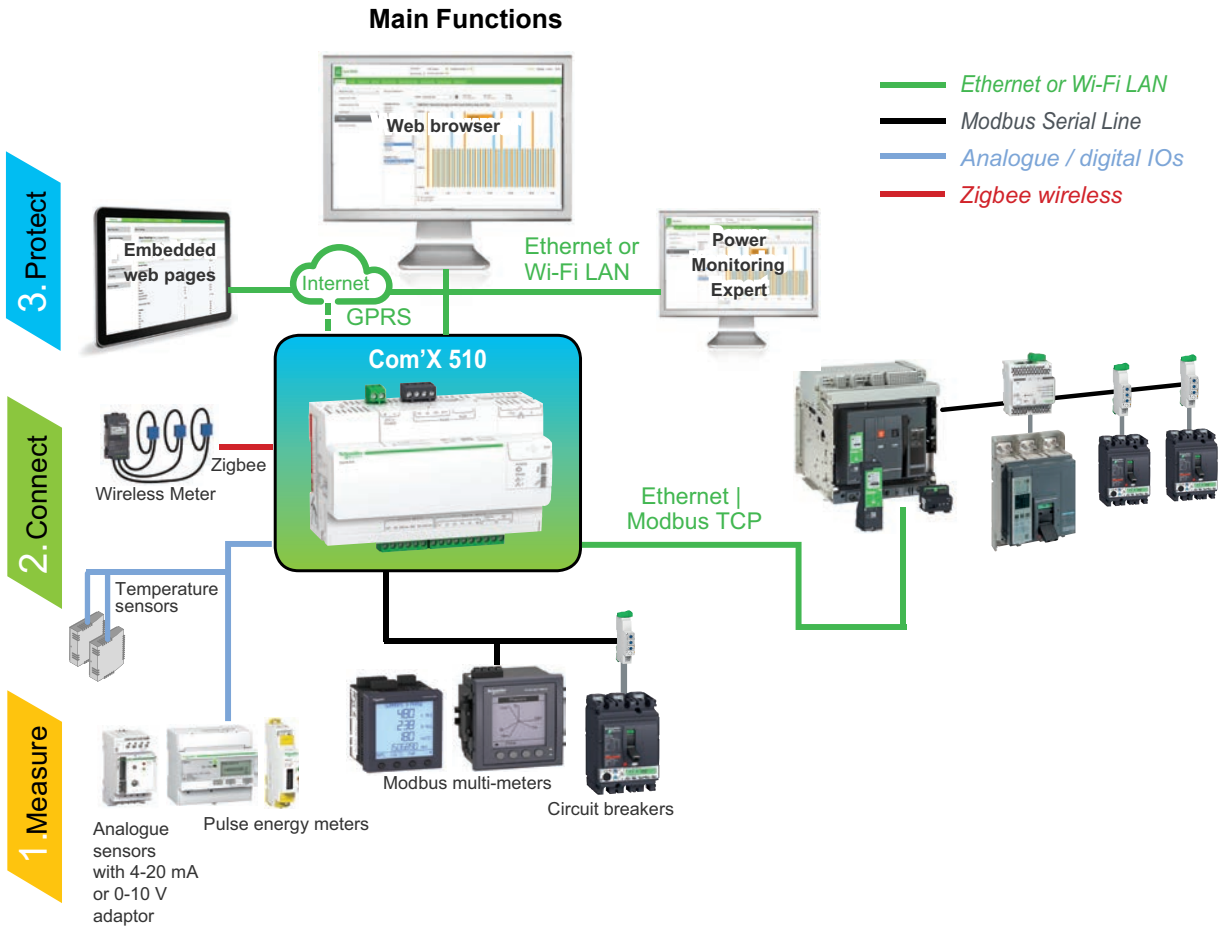

Energy dashboard comparing accumulated over time energy values (partial screen)

Data Collector

Collects and stores energy data from up to 64 field devices, connected to either:

- Ethernet TCP/IP field network
- Modbus Serial line network (up to 32 devices)
- Embedded digital and analog inputs.

"Field devices" consist of:

- PowerLogic meters for power and energy monitoring.
- Masterpact, PowerPact, or Compact circuit breakers for protection and monitoring.
- Water, Air, Gas, Electricity, and Steam consumption meters, from specialized manufacturers, delivering pulses as per standard (see table at end of this document).
- Environmental sensors such as temperatures, humidity, and CO2 levels in a building, providing analogue information.

Data logging and storage capabilities include:

- Data logging period: configured from every minute to once a week.
- Data storage duration: up to two years, depending on quantity of collected data.
- Able to set time and send reset instructions to field devices.

Embedded Energy Management Software

Com'X provides the end-user with immediate visibility into energy consumption throughout the site. When Com'X is connected to the Local Area Network (LAN), several web pages are accessible via any standard web browser, (without plug-in or additional components).

These web pages display real-time data as it is collected, in easy to understand tabular and summary formats. In addition, users can get simple analysis of historical data in bar graph or trending formats.

Com'X 510 Functions and Part Numbers

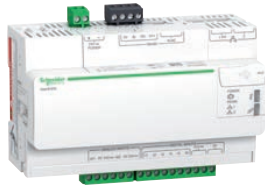

Energy Server Com'X 510

Additional Functions

Data Publisher

Batches of collected data can also be periodically transmitted to an Internet server, as:

- XML files, for processing by EcoStruxure Analytics & Services Products, such as Facility Advisor
- CSV files for viewing in Excel or transformed or uploading to programs such as EcoStruxure Power Monitoring Expert or any compatible software.

Data publishing function supports 4 transfer protocols over Ethernet or Wi-Fi:

- HTTP
- HTTPS
- FTP
- SMTP.

Gateway

If selected by the user, the Com'X510 can make data from connected devices available in real time:

- in Modbus TCP/IP format over Ethernet or Wi-Fi
- for requests by energy management software
- gateway to Zigbee device data by external Modbus TCP/IP clients.

Modbus packets can be sent from managing software to field devices through Modbus serial line or Modbus TCP/IP over Ethernet.



Raw data and measurements from one field device (partial screen)



Historical trend comparing multiple devices or multiple topics (partial screen)

Com'X 510 Catalog Numbers

Com'X 510 data logger 24 Vdc or 230 Vac power supplied	<i>EBX510</i>
Com'X Wi-Fi USB interface	<i>EBXA-USB-WiFi</i>
Com'X GPRS interface SIM card	<i>EBXA-GPRS-SIM</i>
Com'X GPRS interface	<i>EBXA-GPRS</i>
Com'X External GPRS antenna	<i>EBXA-ANT-5M</i>
Com'X Zigbee USB interface	<i>EBXA-USB-Zigbee</i>

Please see your Schneider Electric representative for complete ordering information.

Com'X 210/510

Com'X 210/510 Connectivity

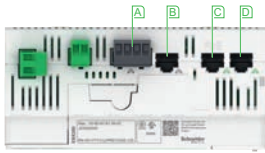

Connection points

A Terminal block

B RJ45 cable

C Ethernet port #1

D Ethernet port #2



Power supply to analogue and digital inputs

Connectivity

Modbus Serial /RS485 connections to field devices

- By cable with RJ45 connector.

Two Ethernet ports

- Used to either separate upstream connection from field devices network or to daisy chain Ethernet devices.
- RJ45 10/100 Base connectors.
- Static IP address.

Ethernet port #1

- Connection to Local Area Network (LAN)
- PoE Class 3 (802.3af) can act as main/backup power supply for the Com'X
- DHCP client.

Ethernet port #2

- Connection to field devices
- DHCP client or server.

Power supply to analogue and digital outputs

Outputs to supply sensors and inputs when Com'X is supplied through 24 Vdc input on top:

- 12 Vdc– 60 mA for digital inputs
- 24 Vdc for analogue inputs.

Compliant with electrical switchboard environment (temperature, electromagnetic compatibility).

Two inputs for analogue sensors

- PT100 or PT1000 temperature probes.
- Various sensors (humidity, CO₂, etc.) with 0-10 V output.
- Various sensors with 4-20 mA output.

Six inputs for dry contact sensors or pulse counters

- Max 25 pulses per second (min duration 20 ms).
- IEC 62053-31 Class A.

Wi-Fi USB stick

- As an alternative for data publication over Ethernet, connects Com'X to the site Wi-Fi router for regular data transmission.
- Can also be used for Com'X 510 configuration through one-to-one connection with PC or tablet.
- Plugs into USB port 2 under front cover.



Wi-Fi USB stick



GPRS modem

GPRS Modem

- For connection to the data processing server through cellular or user's APN network.
- Also connects to Schneider Electric's Digital Service Platform.
- Especially suitable for sites with no internet access.
- Simply plugs into dedicated port under the front cover.

GPRS antenna

- Improves GPRS signal strength in case of poor transmission conditions.
- Recommended for Com'X located inside metallic electrical panels.

Zigbee dongle (not shown)

For connection to wireless digital enabled field devices such as PowerLogic EM4300 meters. Plugs into USB ports.

PowerLogic WT4200 wireless transmitters, connected to Modbus RS485, enables collecting data also from water, air, gas or steam meters.



GPRS antenna

Com'X 210/510 Setup and Configuration



Device settings page (partial), as displayed after auto-discovery, enabling user to assign circuit identifications and select data for logging and publication.

Installation

- DIN rail fitting (Front face IP40, terminals IP20)
- weight 450 g
- dimensions (HxWxD) 91 x 144 x 65.8 mm.

Setup and Configuration

Connection to LAN

When connected to the LAN, it can be detected and assigned an IP address by DHCP. Your operating system's DPWS feature allows your computer to automatically recognize the device as Com'X. Embedded web pages are then immediately accessible by clicking each Com'X device icon or by typing the assigned IP address into your web browser.

Field Device Auto-Discovery

The user-activated device discovery function automatically identifies all field devices connected to Modbus Serial, Ethernet port or Zigbee dongle.

- Schneider Electric devices are displayed along with their the product image.
- Other devices appear as “unknown,” allowing the user to manually assign a device type.
- User can assign their own device types.
- Users can complete additional device identification fields, such as circuit ID or building zone.

Data Selection for Logging and Publication

Web page configuration tabs allow you to configure, in just a few clicks, which connected field devices collect and publish data.

Advanced Diagnostics and Troubleshooting Features

- Modbus serial and TCP/IP device statistics.
- Ethernet network statistics.
- Communications check wizard.
- Direct reading of register values from local and remote devices.

Additional Features and Benefits

- Cyber security - integrates with your cyber security architecture.
- Two Ethernet ports to separate upstream cloud connection, or to daisy chain with other Ethernet devices, from field device network.
- Data storage in case of loss of communication.
- Local backup of configuration parameters - back up your system to a USB storage device and have it available for system restore or to duplicate the configuration on another device.

When Associated with Schneider Electric Services:

- remotely managed (configuration backup, troubleshooting, parameter setting)
- GPRS SIM contract management (with EBXA-GPRS-SIM).

NOTE: For correct installation of all products please consult the appropriate Schneider Electric Installation Guide.

Com'X 210/510 Specifications

Com'X 210/510 Environment			
Operating temperature		-25 to +70°C (-13 to 158°F) Com'X 210/510	
Storage temperature		-40 to +85°C (-40 to +185°F)	
GPRS dongle	Operating temperature	-20 to +60°C (-4 to +140°F)	
	Storage temperature	-40 to +85°C (-40 to +185°F)	
Wif-Fi dongle	Operating temperature	0 to +50°C (32 to +122°F)	
	Storage temperature	-20 to +80°C (-4 to +176°F)	
Humidity	5 to 95% relative humidity (without condensation) at + 55°C (131°F)		
Pollution	Class III		
Safety Standards / Regulation			
International (CB scheme)	IEC 60950		
USA	UL 508		
USA	UL 60950		
Canada	cUL 60950		
Canada	cULus 508		
Europe	EN 60950		
Power Supply		Com'X 210	Com'X 510
DC	24 Vdc (+/- 10%)	●	●
Power over Ethernet	15.4 W DC	●	●
Max power	26 W max	●	●
Mechanical			
IP	Front face IP40, terminals IP20	●	●
Dimensions (H x W x D)	91 x 144 x 65.8 mm (3.58 x 5.67 x 2.59 in.)	●	●
Weight	450 g (0.99 lb)	●	●

FDM128 Ethernet Display

Micrologic measurement capabilities come into full play with the FDM128 display. It connects to Ethernet communication via RJ45 port and displays Micrologic information. The result is a true integrated unit combining a circuit breaker and a Power Meter.

Additional operating assistance functions can also be displayed.



FDM128 display.

The FDM128 collects data from up to eight devices via the Ethernet network:

- Data is collected individually from circuit breakers such as Masterpact or PowerPact, via their Ethernet interfaces or gateways.
- FDM128 generates and displays a dedicated screen for each circuit breaker, with the monitored status, values, and the potential controls.
- Provides remote display of FDM128 web pages on tablet or phone with smart application.

Masterpact and PowerPact Monitoring and Control

The FDM128 displays the data of a Micrologic A/E/P/H trip unit embedded into a Masterpact or PowerPact circuit breaker. They consist of electrical measurements, trips and operating information. Protection setting cannot be modified from the FDM128.

- Measurements are easily accessed via a menu.
- Trips are automatically displayed.
- A pop-up window displays the time-stamped description of the trip.

FDM128 Status Indications

As long as the circuit breaker is equipped with a BCM ULP or BSCM communication module and the appropriate status contacts (with or without Micrologic unit), a minimum of information can be displayed:

- O/F: ON/OFF
- SDE: Fault-trip indication (overload, short-circuit, ground fault)
- PF: ready to close
- CH: charged (spring loaded)
- CE, CD, CT cradle management with IO application module
- A blinking LED indicates the physical location of the communicating ULP modules.

FDM128 Remote Control

When the circuit breaker is equipped with a BCM ULP or BSCM communication module (including their kit for connection to XF and MX1 communication voltage releases or MO motor operator, respectively), the FDM128 display can also be used to control (open/close) the circuit breaker. Two operating modes are available:

- Local mode: open/close commands are enabled from FDM128 while disabled from communication network
- Remote mode: open/close commands are disabled from FDM128 while enabled from the communications network.

FDM128 Main Characteristics

- 115.2 x 86.4 mm (4.53 x 3.40 in.) with 5.7" QVGA display 320 x 240 pixels.
- Color TFT LCD, LED backlight.
- Wide viewing angle: vertical $\pm 80^\circ$, horizontal $\pm 70^\circ$.
- High resolution: excellent reading of graphic symbols.
- Operating temperature range -10°C to $+55^\circ\text{C}$ (14°F to 131°F).
- CE / UL / CSA marking.
- 24 Vdc power supply, with tolerances 24 V (limit 20.4 - 28.8 Vdc).
- Consumption ≤ 6.8 W.

FDM128 Mounting

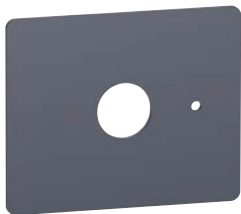

Surface Mount Accessory



The FDM128 can be easily installed on electrical equipment.

- Standard door hole $\varnothing 22$ mm (0.87 in.).
- The FDM128 degree of protection is IP65 in front and IP54.

Connection

The FDM128 is equipped with:

- 24 Vdc terminal block: power supply range of 24 Vdc (limit 20.4–28.8 Vdc). The FDM128 display unit has a 2-point screw connector on the rear panel of the module for this purpose.
- One RJ45 Ethernet port. FDM128 connects to the circuit breakers on Ethernet via IFE modules.

FDM128 Navigation

Touch screen is used for intuitive and fast navigation.

The user can select the display language (Chinese, English, French, German, Italian, Portuguese, Spanish, etc.).

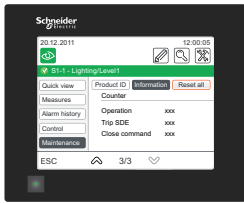

Product Identification

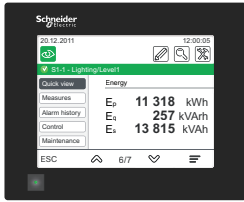

Metering: Meter

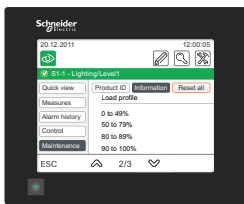

Services

Screens

Main menu				
Quick View	Metering	Maintenance	Maintenance	Maintenance

When not in use, the screen is automatically shifted to low-power back-lighting.

Fast access to essential information

- "Quick view" provides access to five screens that display a summary of essential operating information (I, U, f, P, E, THD, circuit breaker status).

Access to detailed information

- "Metering" can be used to display the measurement data (I, U-V, f, P, Q, S, E, THD, PF) with the corresponding min/max values.
- Alarms displays the trip history.
- Services provides access to the operation counters, energy and maximeter reset function, maintenance indicators, identification of modules connected to the internal bus and FDM128 internal settings (language, contrast, etc.).

Communication Components and FDM128 Connection

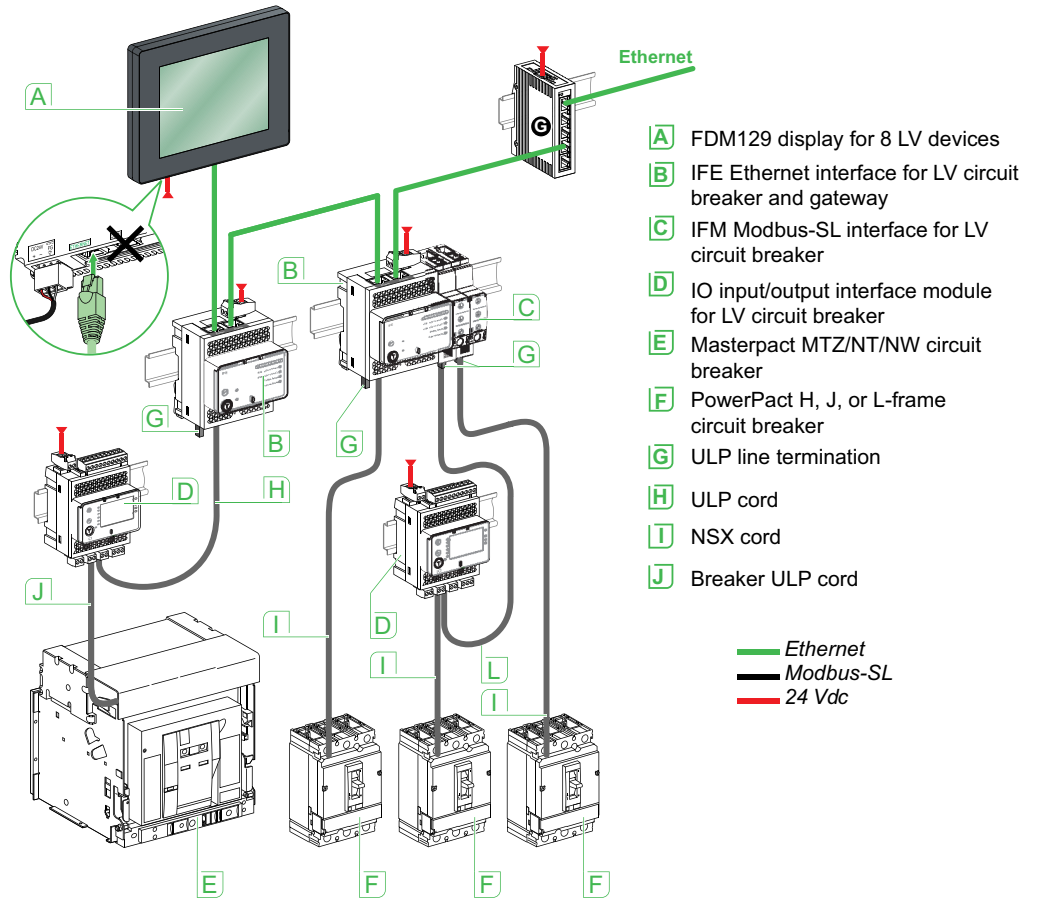

FDM121 System Display

Micrologic measurement capabilities come into full play with the FDM121 switchboard display. It connects to the circuit breaker via ULP and displays Micrologic information. The result is a true integrated unit combining a circuit breaker and a Power Meter. Additional operating assistance functions can also be displayed.

An FDM121 display unit can be connected to a circuit breaker via a ULP cord to display all measurements, alarms, histories and event tables, maintenance indicators, management of installed devices on a screen. The result is a veritable 96 x 96 mm power meter. The display unit requires a 24 Vdc power supply.

The FDM121 can be integrated in PowerPact H/J/L/P/R or Masterpact systems. It uses the Micrologic trip unit's sensors and processing capacity. It is easy to use, requires no special software or settings, and is operational upon connection to a circuit breaker by a ULP cord. It also provides monitoring and control with the use of an IO application module, a motor mechanism module, or a breaker status module. The FDM121 requires very little depth. The anti-glare graphic screen is backlit for easy reading even under poor ambient lighting and at sharp angles.

FDM121 Display of Micrologic Measurements and Alarms



FDM121 Display

Display of Micrologic Measurements and Alarms

The FDM121 displays Micrologic measurements, alarms and operating information. It cannot be used to modify the protection settings. Measurements may be easily accessed via a menu. All user-defined alarms are automatically displayed.

The display mode depends on the priority level selected during alarm set-up:

- High priority: a pop-up window displays the time-stamped description of the alarm and the orange LED flashes
- Medium priority: the orange "Alarm" LED goes steady on

All faults resulting in a trip automatically produce a high-priority alarm, without any special settings required. In all cases, the alarm history is updated. Micrologic saves the information in its non-volatile memory in the event of an FDM121 power loss.

FDM121 Status Indications and Remote Control

Status Indications and Remote Control

For circuit breakers equipped with the Breaker Status Module, the FDM121 display can also be used to view circuit breaker status conditions:

- O/F: ON/OFF
- SD: trip indication
- SDE: Fault-trip indication (overload, short-circuit, ground fault)

When the circuit breaker system is equipped with the IO application module, the FDM121 can monitor and control:

- cradle management
- circuit breaker operation
- light and load control
- custom application.

When the circuit breaker system is equipped with the communicating motor mechanism module, the FDM121 offers remote closing and opening control.

FDM121 Main Characteristics

Main Characteristics

- 96 x 96 x 30 mm (3.8 x 3.8 x 1.2 in.) screen requiring 10 mm (0.4 in.) behind the door. Screen requires 20 mm (0.8 in.) when the 24 V power supply connector is used.
- White backlighting.
- Wide viewing angle: vertical $\pm 60^\circ$, horizontal $\pm 30^\circ$.
- High resolution: excellent reading of graphic symbols.
- Alarm LED: flashing orange for alarm pick-up, steady orange after operator reset if alarm condition persists.
- Operating temperature range -10°C to $+55^\circ\text{C}$ (14°F to 131°F).
- CE / UL / CSA marking (pending).
- 24 Vdc power supply, with tolerances $-20\%/+10\%$ (19.2 Vdc to 26.4 Vdc). When the FDM121 is connected to the communication network, the 24 Vdc can be supplied by the communication system wiring system.
- Consumption 40 mA.

FDM121 Mounting



Surface Mount Accessory



Connection with FDM121 Display Unit

Mounting

The FDM121 is easily installed in a switchboard.

- Standard door cut-out 92 x 92 mm (3.6 x 3.6 in.).
- Attached using clips.

To avoid a cut-out in the door, an accessory is available for surface mounting by drilling only two 22 mm (0.87 in.) diameter holes.

The FDM121 degree of protection is IP54 in front. IP54 is maintained after switchboard mounting by using the supplied gasket during installation.

Connection

The FDM121 is equipped with:

- a 24 Vdc terminal block:
 - Plug-in type with two wire inputs per point for easy daisy-chaining
 - Power supply range of 24 Vdc $-20\%/+10\%$ (19.2 V to 26.4 V).

A 24 Vdc type auxiliary power supply must be connected to a single point on the ULP system. The FDM121 display unit has a 2-point screw connector on the rear panel of the module for this purpose. The ULP module to which the auxiliary power supply is connected distributes the supply via the ULP cable to all the ULP modules connected to the system and therefore also to Micrologic.

- Two RJ45 jacks.

The FDM121 connects to the internal communication terminal block on the Masterpact via the breaker ULP cord. Connection to one of the RJ45 connectors on the FDM121 automatically establishes communication between the Micrologic and the FDM121 and supplies power to the Micrologic measurement functions.

When the second connector is not used, it must be fitted with a line terminator

FDM121 Navigation

Five buttons are used for intuitive and fast navigation.

The "Context" button may be used to select the type of display (digital, bar graph, analogue). The user can select the display language (Chinese, English, French, German, Italian, Portuguese, Spanish, etc.).

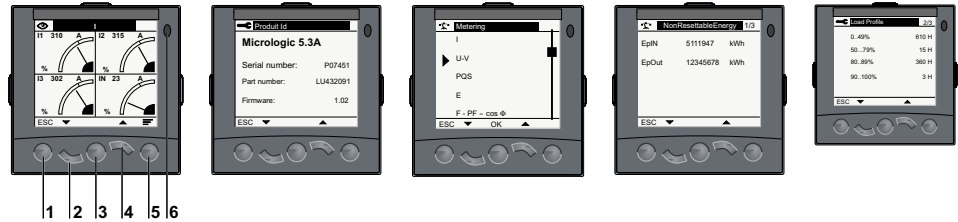

1. Escape
2. Down
3. OK
4. Up
5. Context
6. Alarm LED

Product identification

Metering: sub-menu





Metering: meter

Services

Screens

When powered up, the FDM121 screen automatically displays the ON/OFF status of the device.

Main Menu

				
Quick view	Metering	Control	Alarms	Maintenance

When not in use, the screen is not backlit. Backlighting can be activated by pressing one of the buttons. It goes off after 3 minutes.

Fast access to essential information

- "Quick view" provides access to five screens that display a summary of essential operating information (I, V, f, P, E, THD, circuit breaker On / Off).

Access to detailed information

- "Metering" can be used to display the measurement data (I, V, f, P, Q, S, E, THD, PF) with the corresponding min/max values.
- Alarms displays active alarms and the alarm history.
- Services provides access to the operation counters, energy and maximeter reset function, maintenance indicators, identification of modules connected to the internal bus and FDM121 internal settings (language, contrast, etc.).

Communication Components and FDM121 Connections

Communication Components and FDM121 Connections

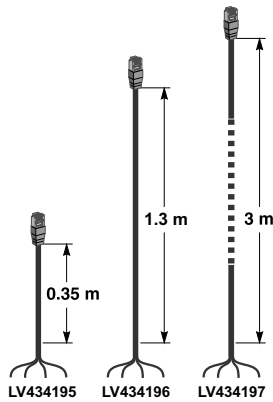

Breaker ULP cord

Connections

Masterpact is connected to the ULP devices (FDM121 display, IFM, IFE interface or IO module) via the circuit breaker ULP cord.

- Cord is available in three lengths: 0.35 m (1.2 ft.), 1.3 m (4.3 ft.), and 3 m (9.8 ft.).
- Lengths up to 10 m (32 ft.) are possible using extensions.

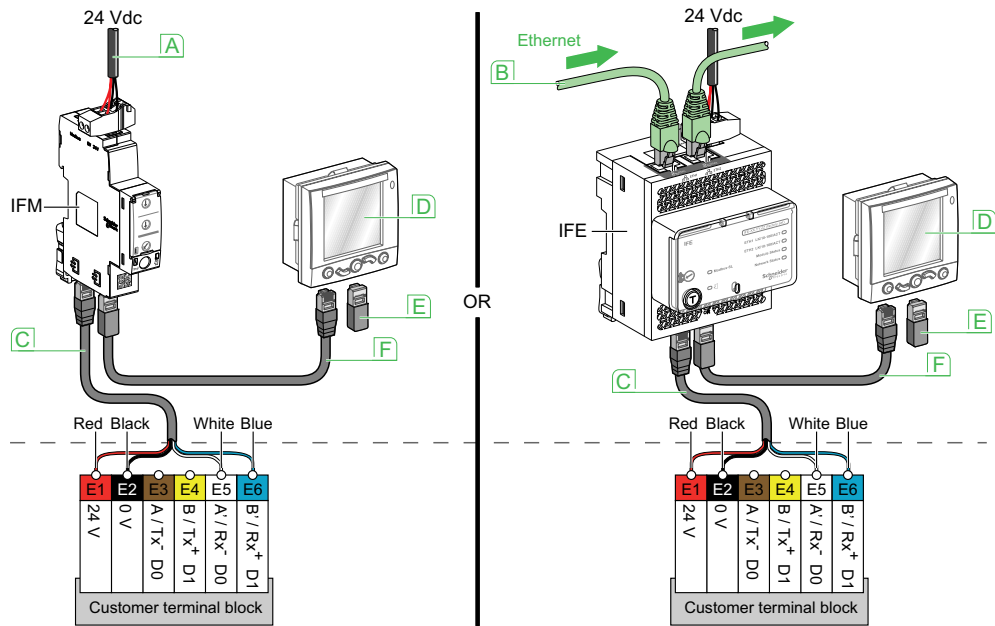

- A. Modbus network.
- B. Ethernet network.
- C. Breaker UL cord.
- D. FDM121 display.
- E. ULP termination.
- F. ULP cable.

IFE System Interface

IFE System Interface Description



IFE interface, ref.:
LV434001



IFE Switchboard Server,
ref. LV434002



PowerView Web Pages

The IFE interface and IFE switchboard server enable Masterpact or PowerPact LV circuit breakers to be connected to an Ethernet network.

- The IFE interface module provides Ethernet access to a single LV circuit breaker.
- The IFE switchboard server interface module provides Ethernet access for up to 20 LV circuit breakers.

Functions

- Interface - one circuit breaker is connected to the IFE interface via its ULP port .
- Server: several circuit breakers on a Modbus network are connected via a stacking connector to the IFE switchboard server master Modbus port.
- Collects and provides data to the PowerView Remote Access on web pages from multiple IP devices (other IFE, PM5000,...).

IFE interface, IFE switchboard server features

- Dual 10/100 Mbps Ethernet port for simple daisy chain connection.
- Device profile web service for discovery of the IFE interface, IFE switchboard server on the LAN.
- ULP compliant for localization of the IFE interface in the switchboard.
- Ethernet interface for Compact, Masterpact and PowerPact circuit breakers.
- Gateway for Modbus-SL connected devices (IFE switchboard server only).
- Embedded set-up web pages.
- Embedded monitoring web pages.
- Embedded control web pages.
- Built-in e-mail alarm notification.

Mounting

The IFE interface, IFE switchboard server are DIN rail mounting devices.

A stacking accessory enables the user to connect several IFMs (ULP to Modbus interfaces) to an IFE switchboard server without additional wiring.

24 Vdc Power Supply

The IFE interface, IFE switchboard server requires 24 Vdc power.

IFMs stacked to an IFE switchboard server are supplied by the IFE switchboard server so it is not necessary to supply them separately. Use a UL listed and recognized limited voltage/limited current or a Class 2 power supply with a 24 Vdc, 3 A maximum.

IFE Interface, IFE Switchboard Server Firmware Update

The firmware can be updated using EcoStruxure Power Commission software.

IFE System Required Circuit Breaker Communication Modules

The connection to IFE interface or IFE switchboard server requires a communication module embedded into the circuit breaker:

- PowerPact H/J/L: NSX cord and/or BSCM module
- Masterpact NT/NW, PowerPact P/R (Fixed electrically operated): BCM ULP communication module
- Drawout Masterpact NT/NW, PowerPact P/R: BCM ULP and its respective IO (Input/Output) application module.

All connection configurations for Masterpact NT/NW, PowerPact P, PowerPact R require the breaker ULP cord. The insulated NSX cord is only for PowerPact H/J/L. It is not needed for Proxima architecture due to optical isolation between the trip unit and the BCM ULP. When the second ULP RJ45 connector is not used, install a ULP terminator (TRV00880) into the unused ULP port.

IFE System General Characteristics

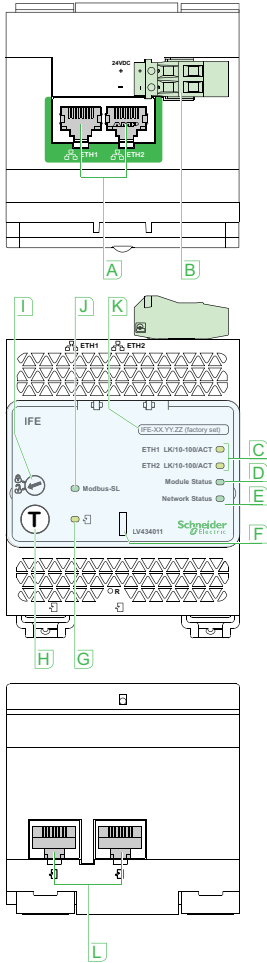

- A** Ethernet 1 and Ethernet 2 communication port.
- B** 24 V DC power supply terminal block.
- C** Ethernet communication LEDs:
 - yellow: 10 Mb
 - green: 100 Mb.
- D** Module status LED:
 - steady off: no power
 - steady green: device operational
 - steady red: major fault
 - flashing green: standby
 - flashing red: minor fault
 - flashing green/red: self test
- E** Network status LED:
 - steady off: not power/no valid IP address
 - steady green: connected, valid IP address
 - steady orange: default IP address
 - steady red: duplicated IP address
 - flashing green/red: self test
- F** Sealable transparent cover.
- G** ULP status LED.
- H** Test button (accessible closed cover).
- I** Locking pad.
- J** Modbus traffic status LED (LV434002 only)
- K** Device name label.
- L** ULP ports.

Environmental Characteristics

Conforming to standards	UL 508, UL 60950, IEC 60950, 60947-6-2
Certification	c UL us, GOST, FCC, CE
Ambient temperature	-20 to +70°C (-4 to +158°F)
Relative humidity	5–85%
Level of pollution	Level 3
Flame resistance	ULV0

Mechanical Characteristics

Shock resistance	1000 m/s ²
Resistance to sinusoidal vibrations	5 Hz < f < 8.4 Hz

Electrical Characteristics

Resistance to electromagnetic discharge	Conforming to IEC/EN 61000-4-3
Immunity to radiated fields	10 V/m
Immunity to surges	Conforming to IEC/EN 61000-4-5
Consumption	120 mA at 24 V input

Physical Characteristics

Dimensions	72 x 105 x 71 mm (2.83 x 4.13 x 2.79 in.)
Mounting	DIN rail
Weight	182.5 g (0.41 lb)
Degree of protection of the installed IO application module	<ul style="list-style-type: none"> • On the front panel (wall mounted enclosure): IP4x
Connections screw type terminal blocks	<ul style="list-style-type: none"> • Connectors: IP2x • Other parts: IP3x
Connections	Screw type terminal blocks

Technical Characteristics - 24 Vdc Power Supply

Power supply type	Regulated switch type
Rated power	72 W
Input voltage	100–120 Vac for single phase 200–500 Vac phase-to-phase
PFC filter	With IEC 61000-3-2
Output voltage	24 Vdc
Power supply out current	3 A

NOTE: It is recommended to use a UL listed/UL recognized limited voltage/limited current or a class 2 power supply with a 24 Vdc, 3 A maximum.

IFE Interfaces, IFE Switchboard Server Web Pages

Monitoring web page	Real time data
	Device logging
Control web page	Single device control
Diagnostics web page	Statistics
	Device information
	IMU information
	Read device registers
Maintenance web page	Communication check
	Maintenance log
Setup web page	Maintenance counters
	Device localization/name
	Ethernet configuration (dual port)
	IP configuration
	Modbus TCP/IP filtering
	Serial port
	Date and time
	E-mail server configuration
	Alarms to be e-mailed
	Device list
	Device logging
	Device log export
	SNMP parameters
	Documentation links
	Preferences
	Advanced services control
User accounts	
Web page access	

EIFE Embedded Ethernet Interface for Drawout Devices

EIFE Embedded Ethernet Interface Description



EIFE Embedded Ethernet Interface ref. *LV851001SP*

The EIFE embedded Ethernet interface module enables drawout Masterpact MTZ circuit breakers to be connected to an Ethernet network.

It provides digital access to all the data provided by the Masterpact control unit Micrologic X. In addition it monitors the three positions of the circuit breaker when inserted in its cradle:

- Circuit breaker racked IN (CE),
- Circuit breaker racked OUT (CD),
- Circuit breaker in test position (CT).

EIFE is a direct Ethernet solution for high-uptime-demanding electrical equipment. It provides Ethernet access to a single drawout Masterpact MTZ circuit breaker.

One circuit breaker is connected to the EIFE interface via its ULP port.

EIFE Interface Features

- Dual 10/100 Mbps Ethernet port for simple daisy chain connection.
- Device profile web service for discovery of the EIFE interface on the LAN.
- Ethernet interface for drawout Masterpact MTZ circuit breakers.
- Embedded set-up web pages.
- Embedded monitoring web pages.
- Embedded control web pages.
- Cradle status management (CE, CD, CT)
- Built-in e-mail alarm notification.

Mounting

The EIFE interface is mounted on the cradle of the drawout MTZ circuit breaker.

There are two types of dedicated ULP cable, one for the MTZ1 and one for MTZ2/MTZ3.

24 Vdc Power Supply

The EIFE power supply is provided by the ULP port through the dedicated ULP cable.

EIFE Interface Firmware Update

The firmware can be updated using EcoStruxure Power Commission software.

EIFE Required Circuit Breaker Communication Accessory

The connection to EIFE interface requires an ULP communication port on the cradle of the drawout Masterpact MTZ circuit breakers.

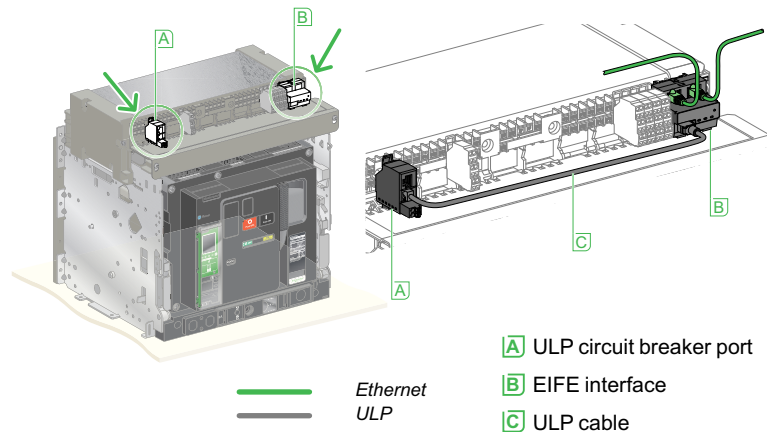

EIFE Mounting and Cabling

EIFE General Characteristics

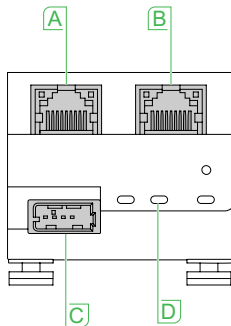

- A** Ethernet port 1
- B** Ethernet port 2
- C** ULP port
- D** Status LEDs

General Characteristics	
Conforming to standards IEC 60950, IEC 60947-6-2, UL 508, UL 60950, IACS E10	
Certification	
CE, c UL us, EAC, FCC markings	
Ambient temperature	Storage
	Operation
	-40 to +85 °C (-40 to +185 °F)
	-25 to +70 °C (-13 to +158 °F)
Relative humidity	5 - 85 %
Level of pollution	Level 3
Flame resistance	ULV0 conforming to IEC/EN 60068-2-30
Mechanical Characteristics	
Shock resistance	As the EIFE is mounted on the circuit breaker it complies with its mechanical characteristics
Resistance to sinusoidal vibrations	
Electrical Characteristics	
Consumption	250 mA at 24 Vdc at room temperature
Resistance to electrostatic discharge	Conforming to IEC/EN 61000-4-2 8 kV AD
Immunity to radiated fields	Conforming to IEC/EN 61000-4-3 10 V/m
Immunity to surges	Conforming to IEC/EN 61000-4-5 Class 2
Physical Characteristics	
Dimensions	51 x 51 x 52.5 mm
Mounting circuit breaker	DIN rail of MTZ1 & MTZ2/MTZ3
Weight	t 75 grams EIFE alone
Degree of protection of the installed module	<ul style="list-style-type: none"> • IP20 for connectors • IP30 for other areas
Connections	<ul style="list-style-type: none"> • RJ45 for Ethernet • Industrial USB connector for ULP

EIFE Web Page Description

Monitoring web page:

- real time data
- device logging.

Control web page:

- single device control.

Diagnostics web page:

- statistics
- device information
- IMU information
- read device registers
- communication check.

Maintenance web page:

- maintenance log
- circuit breaker health status
- maintenance counters.

Setup web page:

- device localization/name
- Ethernet configuration (dual port)
- IP configuration
- Modbus TCP/IP filtering
- date and time
- e-mail server configuration
- alarms to be e-mailed
- device logging
- device log export
- SNMP parameters
- preferences
- advanced services control
- user accounts
- web page access.

Link150 Ethernet Gateway for System



Link150

The Link150 gateway provides Ethernet connectivity in the most demanding applications, from a single building to a multi-site enterprise. This gateway supports meters, monitors, protective relays, trip units, motor controls and other devices that need to communicate data quickly and efficiently. It is your simple, cost-effective Modbus serial line to full Ethernet connectivity.

Applications

- Energy management.
- Power distribution.
- Building automation.
- Factory automation.

Access controls

- The user interface is secured by requiring the user's name and password for login.
- Advanced features to allow users to specify which Modbus TCP/IP master devices may access attached serial slave devices.
 - Modbus TCP/IP filtering feature.
 - Allows user to specify the level of access for each master device as Read-only or Full access.
- Web pages provide easy configuration and setup.

Advantages

- Easy to install and setup.
- Easy to maintain.
- Compatible with Schneider Electric software offerings (EcoStruxure Power Monitoring Expert, PowerSCADA Operations, etc.).
- Proven Modbus to Ethernet protocol conversion.

Part Numbers

Powerlogic Link150

Link150

EGX150

Link 150 Characteristics

Weight	Weight 175 g (6.17 oz) without packing
Dimensions (HxWxD)	Dimensions (H x W x D) 72 x 105 x 71 mm (2.83 x 4.13 x 2.79 in.)
Mounting	Mounting DIN rail
Power-over-Ethernet (PoE)	Power-over-Ethernet (PoE) Class 3
Power supply	Power supply 24 Vdc (-20/+10%) or Power over Ethernet (PoE Class 3 IEEE 802.3 af) at 15 W
Consumption (typical)	24 Vdc, 130 mA at 20°C (68°F)
	PoE 48 Vdc, 65 mA at 20°C (68°F)
Ambient operating temperature	-25 to +70°C (-13 to +158°F)
Ambient storage temperature	-40 to +85°C (-40 to +185°F)
Humidity rating	5 to 95% relative humidity (without condensation) at +55°C (+131°F)
Pollution Degree	Level 2
IP Ratings	On the front panel (wall-mounted enclosure): IP4x
	Connectors: IP20
	Other parts: IP30

Regulatory/standards compliance for electromagnetic interference

Emissions (radiated and conducted)		
Immunity for industrial environments:	electrostatic discharge	EN 61000-6-2
	radiated RF	EN 61000-4-2
	electrical fast transients	EN 61000-4-3
	surge	EN 61000-4-4
	conducted RF	EN 61000-4-5
	power frequency	EN 61000-4-6
	magnetic field	EN 61000-4-8

Regulatory/Standards Compliance for Safety

Safety - IEC	IEC60950
Safety - UL/CSA (Dual listed for US and Canada)	UL 60950
	UL 61010-2-201
EMC	IEC6100-6-2
Australia	C-tick - RCM
Sustainability	Green Premium

Serial Ports

Number of ports	2 (1 available at a time)
Types of ports	RS232 or RS485 (2-wire or 4-wire), depending on settings
Protocol	Modbus, Serial
Baud rates	19200 bps (factory setting), 2400 bps, 4800 bps, 9600 bps, 38400 bps, 56000 bps (2), 57600 bps ²
Maximum number of connected devices	32 (directly)
	247 (indirectly)

2. Only available when Physical Interface is set to RS232 and Transmission Mode is set to Modbus ASCII

Link 150 Characteristics (Continued)

Ethernet Ports (used as a switch)	
Number of ports	2
Type of port	10/100 Base TX (802.3af) port
Protocol	HTTP, Modbus TCP/IP, FTP, SNMP (MIB II)

Parts

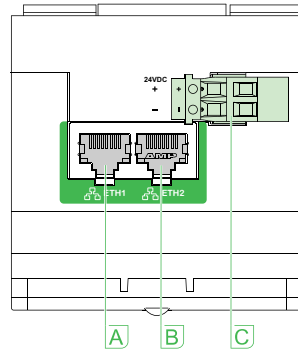

- A** Ethernet 1 communication port
- B** Ethernet 2 (PoE) communication port
- C** 24 Vdc power supply terminal block

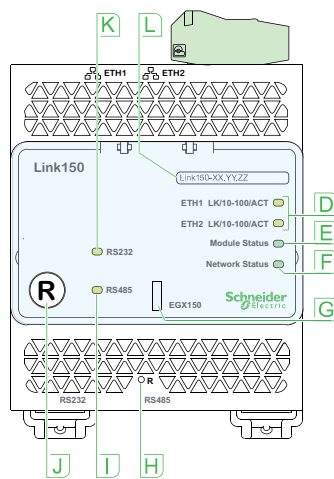

- D** Ethernet communication LEDs
- E** Module status LED
- F** Network status LED
- G** Sealable transparent cover
- H** IP reset pin
- I** RS485 traffic status LED
- J** Device soft restart button (Accessible through closed cover)
- K** RS232 traffic status LED
- L** Device name label

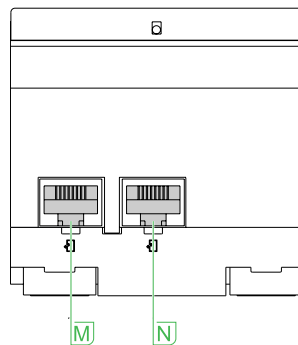

- M** RS232 port
- N** RS485 port

IFM Modbus Interface for System

IFM Modbus Interface Function



IFM Modbus communication interface.
Ref.: LV434000

IFM - Modbus communication interface - is required for connecting Masterpact or PowerPact circuit breakers to the Modbus serial network whenever the circuit breaker has a ULP port (Universal Logic Plug). The port is available on BCM ULP for Masterpact range and BSCM module for the PowerPact range.

Once connected to IFM, the circuit breaker is considered as a slave by the Modbus master. Its electrical values, alarm status, open/close signals can be monitored or controlled by a Programmable Logic Controller or any other system.

IFM Modbus Interface Characteristics

ULP Port

Two RJ45 sockets, internal parallel wiring.

- Connection of a single circuit breaker.
- An ULP line terminator, IO module, or FDM121 display unit must be connected to the second RJ45 ULP socket.

The RJ45 sockets deliver 24 Vdc from the Modbus socket.

Built-in test function, for checking the correct connection to the circuit breaker and FDM121 display unit.

Modbus Slave Port

- Modbus Serial RJ45 port - RJ45 connector provides fast and accurate wiring.
- Lateral socket, for DIN rail stackable connector.

Both top and lateral sockets are internally parallel wired.

- Multiple IFM can be stacked, thus sharing a common power supply and Modbus line without individual wiring.
- On the front face:
 - Modbus address setting (1 to 99): 2 coded rotary switches
 - Modbus locking pad: enables or disable the circuit breaker remote control and modification of IFM parameters.
- Self adjusting communication format (Baud rate, parity).

24 Vdc Power Supply

- Screw clamp terminal block
- High electrical insulation between Modbus and 24 Vdc connectors + separated lines provides improved communication robustness.

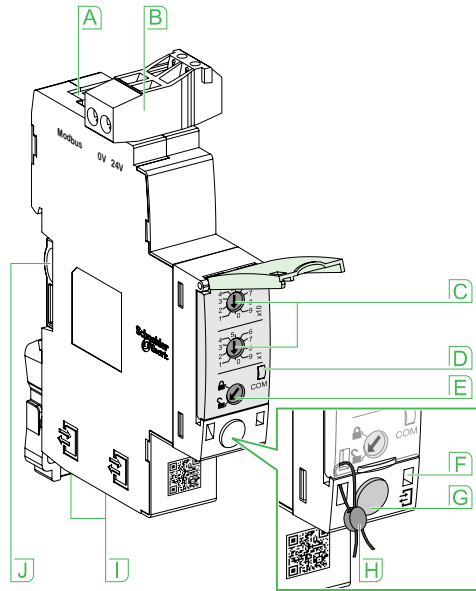

- A** Modbus Serial RJ45 port
- B** 0-24 Vdc power supply
- C** Modbus address switches
- D** Modbus traffic LED
- E** Modbus locking pad
- F** ULN activity LED
- G** Test button
- H** Mechanical lock and locking seal
- I** ULN RJ45 connectors
- J** Stacking accessory connection

IFM Catalog Numbers and Technical Characteristics



VW3A8306TF03

VW3A8306TF10



VW3A8306D30



VW3A8306RC



VW3A8306R03

VW3A8306R10

VW3A8306R30

Catalog Numbers

Type		Catalog No.
IFM -Modbus communication interface module		LV434000
Stacking accessories if more than 1 IFM	Set of 10	TRV00217
ULP line terminator		TRV00880
Modbus line terminator		VW3A8306RC
RJ45 T connector 0.3 m	0.3 m (0.09 ft.)	VW3A8306TF03
RJ45 T connector 1 m	1 m (3.28 ft.)	VW2A8306TF10
Cables: RJ 45 - flying leads		VW3A8306D30
Cables: RJ 45 - Both sides 0.3 m	0.3 m (0.09 ft.)	VW3A8306R03
	1 m (3.28 ft.)	VW3A8306R10
	3 m (9.84 ft.)	VW3A8306R30
Modbus splitter box		LU9GC3

Technical Characteristics

Dimensions 18 x 73 x 90 mm		18 x 73 x 90 mm (0.81 x 2.87 x 3.54 in.)
Maximum number of stacked IFM 12		12
Degree of protection of the installed module	Part projecting beyond the escutcheon	IP4x
	Other module parts	IP3x
	Connectors	IP2x
Operating temperature		-25...+70°C (-13...158°F)
Power supply voltage		24 Vdc -20%/+10% (19.2–26.4 Vdc)
Consumption	Typical	21 mA/24 Vdc at 20°C (68°F)
	Maximum	30 mA/19.2 Vdc at 60°C (140°F)

Certification

CE	IEC/EN 60947-1
UL	UL 508 - Industrial Control Equipment
CSA	CSA No. 142-M1987 - Process Control Equipment <ul style="list-style-type: none"> CAN/CSA C22.2 No. 0-M91 - General requirements - Canadian Electrical Code Part CAN/CSA C22.2 No. 14-05 - Industrial Control Equipment

Recommended IFM Installation

Stacking IFM

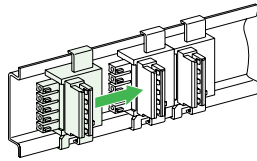

Stacking Accessories

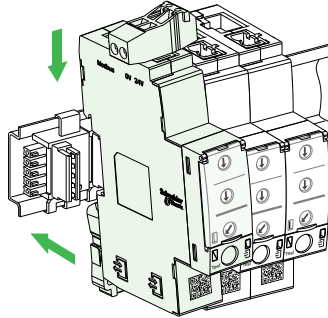

Up to 12 stacked IFM

Stacking an IFE switchboard server with IFMs

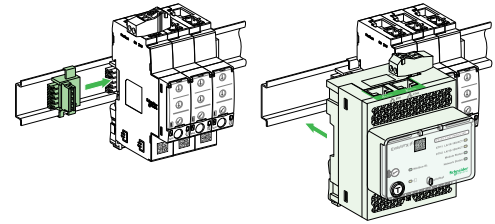

IO Application Module for System

IO Application Module Description



IO (Input/Output)
application module.
Ref.: LV434063

The IO (Input/Output) application module for LV breaker is part of an ULP system with built-in functionalities and applications to enhance the application needs.

The ULP system architecture can be built using the wide range of circuit breakers.

The IO application module is compliant with the ULP system specifications.

Two IO application modules can be connected in the same ULP network.

The LV circuit breakers enhanced by the IO application module are:

- Masterpact NW
- Masterpact NT
- Masterpact MTZ
- PowerPact P, R
- PowerPact H, J, L

IO (Input/Output) application module for LV breaker resources

The IO application module resources are:

- Six digital inputs that are self powered for either NO and NC dry contact or pulse counter.
- Three digital outputs that are bistable relay (5 A maximum).
- One analog input for Pt100 temperature sensor.

Pre-Defined Applications

Pre-defined application adds new functions to the IMU:

- Selection by the application rotary switch on the IO application module, defining the application with pre-defined input/output assignment and wiring diagram.
- No additional setting with the customer engineering tool required.

The resources not assigned to the pre-defined application are free for additional user-defined applications:

- Cradle management.
- Circuit breaker operation.
- Cradle management and Energy Reduction Maintenance Setting (ERMS).
- Light and load control.
- Custom.

User-Defined Applications

User-defined applications are processed by the IO application module in addition to the pre-defined application selected.

The user-defined applications are available depending on:

- The pre-defined application selected.
- The IO application module resources (inputs and outputs) not used by the application.

The resources required by user-defined applications are assigned using the customer engineering tool:

- protection
- control
- energy management
- monitoring.

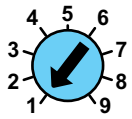

Mounting

The IO application module is a DIN rail mounting device.

Application Rotary Switch

The application rotary switch enables the selection of the pre-defined application.

It has nine positions and each position is assigned to a pre-defined application.

The factory set position of the switch is pre-defined application 1.

Setting Locking Pad

The setting locking pad on the front panel of the IO application module enables the setting of the IO application module by the customer engineering tool, EcoStruxure Power Commission software.

IO Application Module Characteristics

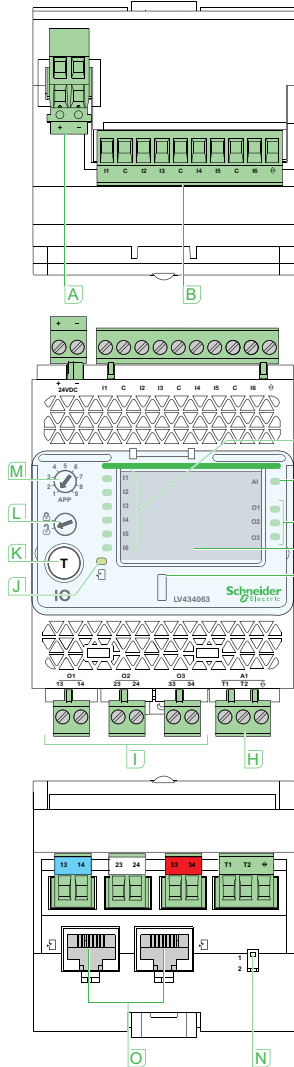

Environmental Characteristics	
Conforming to standards	UL 508, UL 60950, IED 60950, 60947-6-2
Certification	c UL us, GOST, FCC, CE
Ambient temperature	-20 to +70°C (-4 to +158°F)
Relative humidity	5–85%
Level of pollution	Level 3
Flame resistance	ULV0

Mechanical Characteristics	
Shock resistance	1000 m/s ²
Resistance to sinusoidal vibrations	5 Hz < f < 8.4 Hz

Electrical Characteristics	
Resistance to electromagnetic discharge	Conforming to IEC/EN 61000-4-3
Immunity to radiated fields	10 V/m
Immunity to surges	Conforming to IEC/EN 61000-4-5
Consumption	165 mA

Physical Characteristics	
Dimensions	71.7 x 116 x 70.6 mm (2.83 x 4.56 x 2.78 in.)
Mounting	DIN rail
Weight 229.5	229.5 g (0.51 lb)
Degree of protection of the installed IO application module	<ul style="list-style-type: none"> On the front panel (wall mounted enclosure): IP4x IO parts: IP3x Connectors: IP2x
Connections	Screw type terminal blocks

24 Vdc Power Supply		
Power supply	24 Vdc, -20%/+10% (19.2–26.4 Vdc)	
Consumption	Typical	24 Vdc, 100 ms at 20°C (68°F)
	Maximum with ULP	19.2 Vdc, 130 mA at 60°C (140°F)

Digital Inputs	
Digital input type	Self powered digital input with current limitations as per IEC 61131-2 type 2 standards (7 mA)
Input limit values at state 1 (close)	19.8–25.2 Vdc, 6.1–8.8 mA
Input limit values at state 0 (open)	0–19.8 Vdc, 0 mA
Maximum cable length	10 m (33 ft)

NOTE: For lengths between 10 m (33 ft.) and 300 m (1,000 ft.), a shielded twisted cable is required. The shielded cable is connected to the IO functional ground of the IO application module.

Digital Outputs	
Digital output type	Bistable relay
Rated load	5 A at 250 Vac
Rated carry current	5 A
Maximum switching voltage	380 Vac, 125 Vdc

Maximum switch current	5 A
Maximum switching power	1250 VA, 150 W
Minimum permissible load	10 mA at 5 Vdc
Contact resistance	30 mΩ
Maximum operating frequency	<ul style="list-style-type: none"> • 18000 operations/hr (Mechanical) • 1800 operations/hr (Electrical)
Digital output relay protection by an external fuse	External fuse of 5 A or less
Maximum cable length	10 m (33 ft)

Analog Inputs

The IO application module analog input can be connected to a Pt100 temperature

Range	-30 to 200 °C	-22 to 392 °F
Accuracy	<ul style="list-style-type: none"> • ±2°C from -30 to 20°C • ±1°C from 20 to 140°C • ±2°C from 140 to 200°C 	<ul style="list-style-type: none"> • ±3.6°F from - 22 to 68°F • ±1.8°F from - 22 to 284°F • ±3.6°F from 284 to 392°F
Refresh interval	5 s	5 s

Commissioning Software

EcoStruxure Power Commission Software

EcoStruxure Power Commission software provides support during build, commission and maintenance phases of Smart Panels projects.

EcoStruxure Power Commission software is dedicated to electrical asset management.

Office or onsite: configuring and commissioning of multiple electrical equipment of an installation (circuit breakers, Enerlin'X communication interfaces,...).

Onsite: simultaneous interface with equipment via LAN for commissioning and testing. Automatic report generation.

Projects database: saved in a protected cloud account.



Panel Design and Build

- Offline design of electrical distribution architectures: electrical and communication devices description with their ratings and settings.
- Save as a new project: architecture and all related documents (of any file types).
- Projects library management: save, load project.
- Reuse of existing project: modify, save as a new project.

Devices Commissioning

- Automatic discovery of devices in a digitized switchboard.
- Settings download, upload.
- Communication tests.
- Automatic communication report generation.

Circuit Breaker Commissioning

- Trip units settings download.
- Online checks, tests.
- Automatic report generation.

Operation and Maintenance

- Devices monitoring and control.
- Measurement parameter logs.
- Log reports.
- Download of current devices settings, compare with previous settings saved in EEcoStruxure Power Commission software.

- Firmware upgrade and compatibility matrix.

Compatibility

Devices

Configuration of below devices through the range of Enerlin'X interfaces devices.

- Circuit breakers: Masterpact, PowerPact ranges.
- Enerlin'X range and control components.

EcoStruxure Power Commission software for PC

- Compatible with Windows 7, Windows 10.

Example of EcoStruxure Power Commission Software

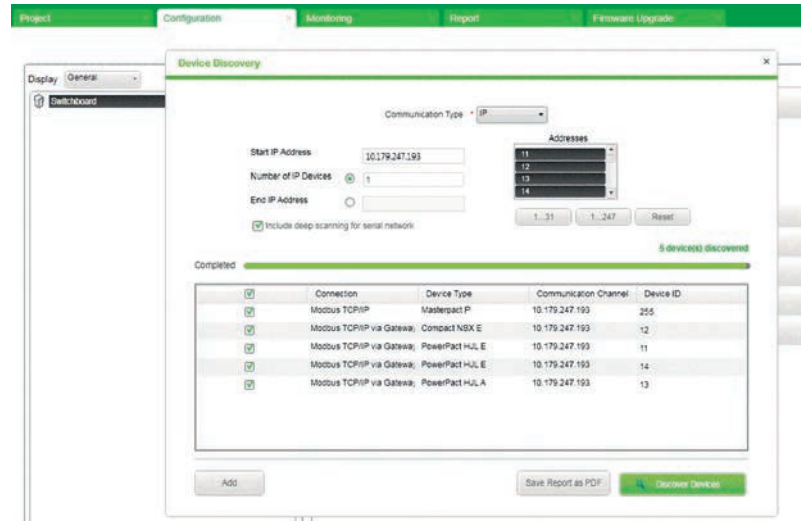

Ecostruxure Facility Expert Cloud-Based Software

DB428351



Click or scan

Presentation video:
EcoStruxure Power for
Small and Medium
Buildings

EcoStruxure™ Facility Expert, a software for operation & maintenance

EcoStruxure Facility Expert helps Business owners and Site Managers to improve the performance of their buildings at lower operating costs, while at the same time maximizing the business continuity.

It is a cloud based software available on PCs and mobile devices that provides valuable information on energy costs and on asset conditions along with tools to manage the maintenance activities.

EcoStruxure Facility Expert is fully adapted to multi-sites projects delivering performance views and reports to site manager while maintenance manager and field technicians get access to detailed dashboard, instant alerts and maintenance tasks.

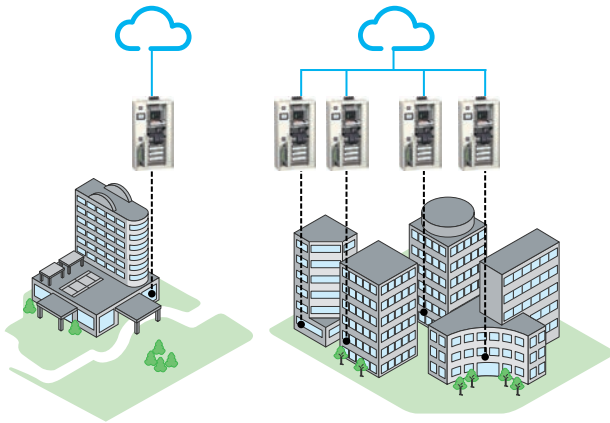

EcoStruxure Facility Expert leverages all communication capabilities of Smart Panels and Enerlin'X components to retrieve energy and operational data on the cloud via Ethernet or cellular network.

Dashboards are pre-configured which enables a simple commissioning.

Tested and proven architecture make devices and software simply work.

This minimizes costs in the construction phase.

Schneider Electric Partners Network

Schneider Electric local partners are trained and certified to sell, install and commission EcoStruxure Facility Expert. They can also operate the solution if the site manager wants to delegate this task.

Energy Performance Monitoring Features

Provide energy, cost, performance information for building energy efficiency.

A set of simple and relevant graphs and charts is available on a web portal.

- Main energy consumptions tracking
- Power demand overrun and low power factor tracking and alerts
- Consumption per zones & usage
- **Multi-site** comparison
- **Energy cost** allocation
- **Building performance:** benchmarking against local energy performance scale (regulatory compliance to ISO5001, LEED, NABERS)

Energy kiosk:

Displayed on building public TV screens show the site green image to visitors and promote occupant ecofriendly behaviors.

Operation and Maintenance Features

Provide maintenance alarms and information shared on maintenance team's mobile devices, to reduce mean time to repair with faster troubleshooting.

- Standard alarms on equipment fault
- Custom alerts on crossing thresholds status change
- Events tracking
- Maintenance & repair log records
- Asset information shared by all maintenance contributors

Commercial References

EcoStruxure Facility Expert		Part Number
Smart Power subscription 5 energy meters, 5 connected assets, 2 maintenance contributors	For 1 site	<i>SVSFE1001</i>
One additional connected meter	Optional	<i>SVSFEOPT001</i>
One additional connected asset	Optional	<i>SVSFEOPT002</i>
Energy cost dashboard	Optional	<i>SVSFEOPT00A</i>
Energy kiosk	Optional	<i>SVSFEOPT007</i>
One additional maintenance contributor	Optional	<i>SVSFEOPT003</i>





Software and options can be purchased from our website:

<http://godigital.schneider-electric.com/smp/home/home.page>







Commercial References

Meters and Auxiliary Devices



Energy Meters

Type	Pulse Output			Modbus
				
Series	iEM2000T, iEM2010	iEM2105	iEM3110, iEM3210 i	iEM215x, iEM315x, iEM325x, iEM335x

Multifunction Meters

Output Type	Pulse	Modbus TCP, Modbus RTU PowerLogic multifunction meters PM5xxx range, PM8xxx range					
							
Series	PM200P	ION6200	PM3000	PM5350	PM5300	PM5560	PM8000

Circuit Breakers with Built-In Power Meter

Series			
			
Series	Powerpact H/J/L + Micrologic E	Masterpact NT/NW + Micrologic H, P	Masterpact MTZ + Micrologic X

Compatible Counters, Power Meters (Old Ranges), Other Devices

Pulse Counters

ME1Zr, ME3zr, ME4zr, PM9p, PM200p, EN40 P

Power Meters – Modbus Exchange Protocol

PM9c, PM500 series, PM700 series, PM1200, EM6400 series

Analog Sensors

RTD (Pt100, Pt1000)

4–20 mA sensor
0–10 V sensor

Series Modbus / TCP/IP Modbus gateways

Link150, COM'X510

Commercial Reference Numbers

Product	Part No.
Interfaces + Gateways	
Com'X 210 Ethernet Energy data logger	<i>EBX210</i>
Com'X 510 Ethernet Energy server	<i>EBX510</i>
IFE switchboard server	<i>LV434002</i>
Interfaces	
IFM	<i>LV434000</i>
IFE	<i>LV434001</i>
EIFE interface	<i>LV851001</i>
Link150 Ethernet gateway	<i>EGX150</i>
IO Module	
IO	<i>LV434063</i>
Displays	
FDM128 Ethernet switchboard display	<i>LV434128</i>
FDM121 switchboard display	<i>TRV00121</i>
Accessories for Com'X200, 210, 510	
GPRS Modem	<i>EBXA-GPRS</i>
Aerial for GPRS modem EBXA-ANT-5M	<i>EBXA-ANT-5M</i>
Wi-Fi USB modem	<i>EBXA-USB-WIFI</i>
Com'X GPRS interface SIM card	<i>EBXA-GPRS-SIM</i>
Com'X GPRS interface	<i>EBXA-GPRS</i>
Com'X Zigbee USB interface	<i>EBXA-USB-zigbee</i>
Accessories for IFM	
Stacking accessories	<i>V00217</i>
ULP line terminator	<i>TRV00880</i>
Modbus line terminator	<i>VW3A8306RC</i>
RJ45 T connector 0.3 m	<i>VW3A8306TF03</i>
RJ45 T connector 1 m	<i>VW2A8306TF10</i>
Modbus splitter box	<i>LU9GC3</i>

Schneider Electric

800 Federal Street
Andover, MA 01810
USA

888-778-2733

www.schneider-electric.com

As standards, specifications, and design change from time to time,
please ask for confirmation of the information given in this publication.

© 2019 – Schneider Electric. All rights reserved.

0614CT1802