

# Modbus serial link for Machines

Catalog

June **2019**

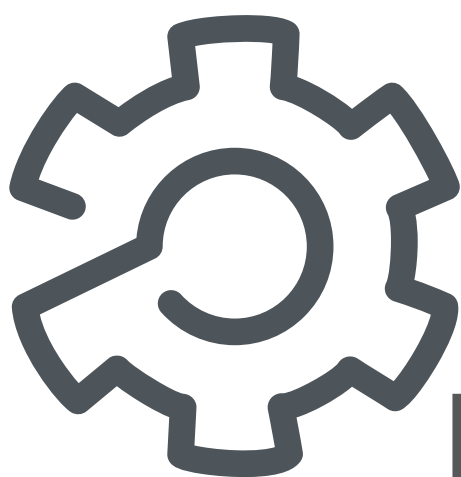

**MODBUS**  
MODBUS

**Schneider**  
Electric

# Quick access to product information

## Get technical information about your product

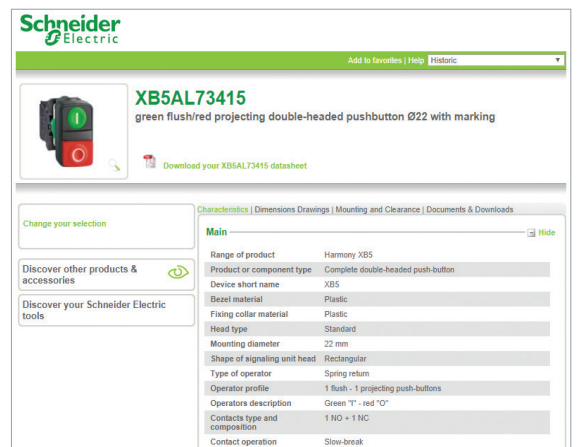
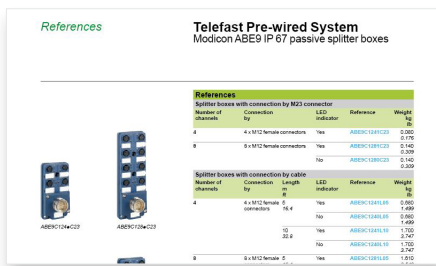

Each commercial reference presented in a catalog contains a hyperlink. Click on it to obtain the technical information of the product:

- Characteristics, Dimensions and drawings, Mounting and clearance, Connections and schemas, Performance curves
- Product image, Instruction sheet, User guide, Product certifications, End of life manual

## Find your catalog

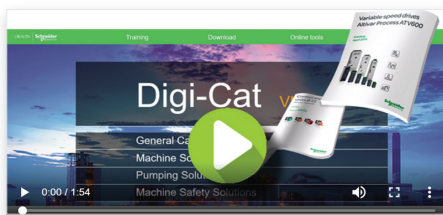

- > With just 3 clicks, you can reach the Industrial Automation and Control catalogs, in both English and French
- > Download Digi-Cat with this [link](#)

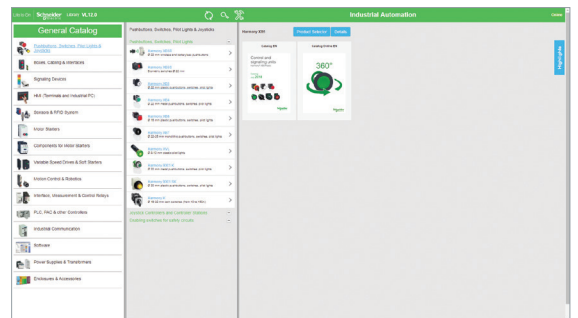

- Updated quarterly
- Embeds product selectors and configurators, 360° images, training centers
- Optimized search by commercial reference

## Select your training



- > Find the right [Training](#) for your needs on our Global website
- > Locate the training center with the selector tool, using this [link](#)

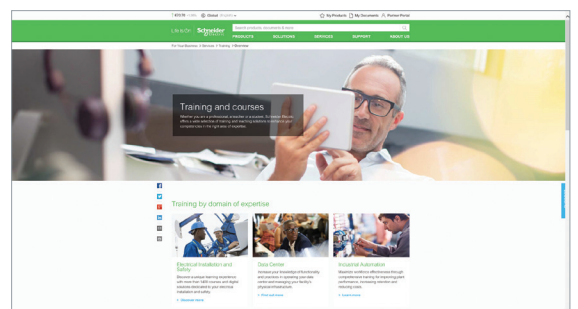

# General content

*Introduction to EcoStruxure Machine* ..... page 2

*Selection guide: controllers for industrial machines* ..... page 4

*Machine automation* ..... page 6

## **Modbus Serial link for Machines**

### ■ with Modicon M221 and M221 Book logic controllers

- Presentation ..... page 8

- References ..... page 9

### ■ with Modicon M241 and M251 logic controllers, and modicon M622 Logic/Motion controller

- Presentation ..... page 10

- References ..... page 10

### ■ with Modicon M258 logic controllers, and Modicon LMC058 motion controllers

- Presentation ..... page 12

- References ..... page 12

■ **Product reference index** ..... page 14

To be competitive in today's digital era, machine builders must be innovative. Smart machines, those that are better connected, more flexible, more efficient, and safe, are enabling machine builders to innovate in ways never before possible.

EcoStruxure, Schneider Electric's open, IoT-enabled architecture and platform, offers powerful solutions for the digital era. As part of this, EcoStruxure Machine brings powerful opportunities for machine builders and OEMs, empowering them to offer smart machines and compete in the new, digital era.

EcoStruxure Machine brings together key technologies for product connectivity and edge control on premises, and cloud technologies to provide analytics and digital services. EcoStruxure Machine helps you bring more innovation and added value to your customers throughout the entire machine life cycle.

**Innovation at Every Level for Machines is full systems across three layers:**

- Connected products  
Our connected products for measuring, actuating, device level monitoring, and control adhere to open standards to provide unmatched integration opportunities and flexibility
- Edge Control  
We are IIoT-ready with a proven set of tested and validated reference architectures that enable the design of end-to-end open, connected, and interoperable systems based on industry standards. Ethernet and OPC UA facilitates IT/OT convergence meaning machine builders reap benefits from web interfaces and cloud.

- Apps, Analytics & Services  
Seamless integration of machines to the IT layer allows the collection and aggregation of data ready for analysis – for machine builders and end users alike this means increased uptime and the ability to find information faster for more efficient operations and maintenance.

**These levels are completely integrated from shop floor to top floor. And we have cloud offers and end-to-end cybersecurity wrapped around.**

EcoStruxure Machine makes it easier for OEMs/ machine builders to offer their customers smarter machines. The advent of smart machines is driven by the changing needs of end users:

- Evolving workforce
- Reducing costs
- Dynamic markets
- Shorter life cycles
- Prioritizing safety and cybersecurity

EcoStruxure Machine provides one solution for the whole machine life cycle:

- With Smart Design & Engineering the time to market is reduced by up to 30% using our automated engineering and the simulation capabilities
- During Commissioning & Operation of the machine, resources such as energy, material and loss can be improved, and with seamless integration to the IT world efficiency can be improved by up to 40%
- Smart Maintenance & Services reduces the time for corrective actions up to 50%

# EcoStruxure™ Machine





Innovation At Every Level



\* The Schneider Electric industrial software business and AVEVA have merged to trade as AVEVA Group plc, a UK listed company. The Schneider Electric and Life is On trademarks are owned by Schneider Electric and are being licensed to AVEVA by Schneider Electric.

# Modbus serial link for Machines

## Controllers for industrial machines

Applications		Logic controller			Logic/Motion controller		Motion controller	
Type	Specification	For hardwired architectures	For performance-demanding applications		For modular and distributed architectures	IIoT ready for performance machines	For automating machines/lines with 0 - 130 servo or robot axes	
								
								
Performance		0.2 µs/inst	22 ns/inst		22 ns/inst	3...5 ns/inst	0.5...2 ns/inst	
Memory		640 KB RAM, 2 MB Flash	64 MB RAM, 128 MB Flash		64 MB RAM, 128 MB Flash	256 MB RAM, 256 MB Flash	128 KB to 256 KB NV RAM 512 MB DDR2 to 1 GB DDR3L	
Supply voltage		24 V $\overline{\text{---}}$ or 100...240 V $\sim$	24 V $\overline{\text{---}}$ or 100...240 V $\sim$		24 V $\overline{\text{---}}$	24 V $\overline{\text{---}}$	24 V $\overline{\text{---}}$	
Communication fieldbus and networks		Embedded	<ul style="list-style-type: none"> <li>■ EtherNet/IP</li> <li>■ RS 232/RS 485 serial link</li> <li>■ USB mini-B programming port</li> </ul>	<ul style="list-style-type: none"> <li>■ Ethernet</li> <li>■ CANopen (master) and SAE J1939</li> <li>■ 2 serial links</li> <li>■ USB mini-B programming port</li> </ul>	<ul style="list-style-type: none"> <li>■ EtherNet/IP</li> <li>■ CANopen (master) and SAE J1939</li> <li>■ Serial link</li> <li>■ USB mini-B programming port</li> </ul>	<ul style="list-style-type: none"> <li>■ EtherNet/IP</li> <li>■ Sercos III</li> <li>■ Modbus TCP</li> <li>■ Serial link</li> <li>■ USB mini-B programming port</li> </ul>	<ul style="list-style-type: none"> <li>■ EtherNet/IP</li> <li>■ Sercos III</li> <li>■ CANopen</li> <li>■ Profibus</li> <li>■ Profinet</li> <li>■ EtherCAT</li> </ul>	
		Optional	<ul style="list-style-type: none"> <li>■ 1 Serial Line</li> </ul>	<ul style="list-style-type: none"> <li>■ Ethernet</li> <li>■ Profibus DP</li> </ul>	<ul style="list-style-type: none"> <li>■ Ethernet</li> <li>■ Profibus DP</li> </ul>	<ul style="list-style-type: none"> <li>■ Ethernet</li> <li>■ CANopen</li> </ul>	<ul style="list-style-type: none"> <li>■ CANopen</li> <li>■ Profibus DP</li> <li>■ RT-Ethernet</li> </ul>	
Embedded I/O		Input types	Up to 40 logic inputs Up to 2 analog inputs	Up to 24 logic inputs	–	4 fast digital inputs	Up to 20 digital inputs Up to 16 touch probe inputs Up to 4 interrupt inputs Up to 2 analog inputs	
		Output types	Up to 16 relay outputs Up to 16 transistor outputs	Up to 16 transistor outputs	–	4 fast digital outputs	Up to 16 digital outputs Up to 2 analog outputs	
Synchronized axes		–	–		–	Up to 16 synchronized axes	Up to 130 synchronized axes	
Configuration software		EcoStruxure Machine Expert-Basic (1)	EcoStruxure Machine Expert V1.1 (2)		EcoStruxure Machine Expert V1.1 (2)	EcoStruxure Machine Expert V1.1	EcoStruxure Machine Expert V1.1 (2)	
Compatible expansion I/O module ranges (consult the catalog)		<ul style="list-style-type: none"> <li>● Local I/O</li> </ul>	<ul style="list-style-type: none"> <li>● Modicon TM3 (<a href="#">DIA3ED2140109EN</a>)</li> </ul>	<ul style="list-style-type: none"> <li>● Modicon TM3 (<a href="#">DIA3ED2140109EN</a>)</li> </ul>	<ul style="list-style-type: none"> <li>● Modicon TM3 (<a href="#">DIA3ED2140109EN</a>)</li> </ul>	<ul style="list-style-type: none"> <li>● Modicon TM3 (<a href="#">DIA3ED2140109EN</a>)</li> </ul>	–	
		<ul style="list-style-type: none"> <li>● Remote I/O</li> </ul>	<ul style="list-style-type: none"> <li>● Modicon TM3 (<a href="#">DIA3ED2140109EN</a>)</li> </ul>	<ul style="list-style-type: none"> <li>● Modicon TM3 (<a href="#">DIA3ED2140109EN</a>)</li> </ul>	<ul style="list-style-type: none"> <li>● Modicon TM3 (<a href="#">DIA3ED2140109EN</a>)</li> </ul>	<ul style="list-style-type: none"> <li>● Modicon TM3 (<a href="#">DIA3ED2140109EN</a>)</li> </ul>	<ul style="list-style-type: none"> <li>● Modicon TM3 (<a href="#">DIA3ED2140109EN</a>)</li> </ul>	<ul style="list-style-type: none"> <li>● Modicon TM5 (<a href="#">DIA3ED2131204EN</a>)</li> </ul>
		<ul style="list-style-type: none"> <li>● Distributed I/O on Ethernet</li> </ul>	<ul style="list-style-type: none"> <li>● Modicon TM3 (<a href="#">DIA3ED2140109EN</a>)</li> </ul>	<ul style="list-style-type: none"> <li>● Modicon TM3 (<a href="#">DIA3ED2140109EN</a>)</li> <li>● Modicon TM5 (<a href="#">DIA3ED2131204EN</a>)</li> </ul>	<ul style="list-style-type: none"> <li>● Modicon TM3 (<a href="#">DIA3ED2140109EN</a>)</li> <li>● Modicon TM5 (<a href="#">DIA3ED2131204EN</a>)</li> </ul>	<ul style="list-style-type: none"> <li>● Modicon TM3 (<a href="#">DIA3ED2140109EN</a>)</li> <li>● Modicon TM5 (<a href="#">DIA3ED2131204EN</a>)</li> </ul>	<ul style="list-style-type: none"> <li>● Modicon TM3 (<a href="#">DIA3ED2140109EN</a>)</li> <li>● Modicon TM5 (<a href="#">DIA3ED2131204EN</a>)</li> </ul>	<ul style="list-style-type: none"> <li>● Modicon TM5 (<a href="#">DIA3ED2131204EN</a>)</li> <li>● Modicon TM7 (<a href="#">DIA3ED2140405EN</a>)</li> </ul>
		<ul style="list-style-type: none"> <li>● Distributed I/O on CANopen</li> </ul>	–	–	–	–	<ul style="list-style-type: none"> <li>● Modicon TM5 (<a href="#">DIA3ED2131204EN</a>)</li> <li>● Modicon TM7 (<a href="#">DIA3ED2140405EN</a>)</li> </ul>	<ul style="list-style-type: none"> <li>● Modicon TM5 (<a href="#">DIA3ED2131204EN</a>)</li> </ul>
		<ul style="list-style-type: none"> <li>● Distributed I/O on Sercos</li> </ul>	–	–	–	–	<ul style="list-style-type: none"> <li>● Modicon TM5 (<a href="#">DIA3ED2131204EN</a>)</li> </ul>	<ul style="list-style-type: none"> <li>● Modicon TM5 (<a href="#">DIA3ED2131204EN</a>)</li> </ul>
<ul style="list-style-type: none"> <li>● Safety I/O</li> </ul>	<ul style="list-style-type: none"> <li>◁ Modicon TM3 (<a href="#">DIA3ED2140109EN</a>)</li> </ul>	<ul style="list-style-type: none"> <li>◁ Modicon TM3 (<a href="#">DIA3ED2140109EN</a>)</li> </ul>	<ul style="list-style-type: none"> <li>◁ Modicon TM3 (<a href="#">DIA3ED2140109EN</a>)</li> </ul>	<ul style="list-style-type: none"> <li>◁ Modicon TM3 (<a href="#">DIA3ED2140109EN</a>)</li> </ul>	<ul style="list-style-type: none"> <li>◁ Modicon TM3 (<a href="#">DIA3ED2140109EN</a>)</li> <li>◁ Modicon TM5 (<a href="#">DIA3ED2131204EN</a>)</li> <li>◁ Modicon TM7 (<a href="#">DIA3ED2140405EN</a>)</li> </ul>	<ul style="list-style-type: none"> <li>◁ Modicon TM5 (<a href="#">DIA3ED2131204EN</a>)</li> <li>◁ Modicon TM7 (<a href="#">DIA3ED2140405EN</a>)</li> </ul>		
Controller range		<b>Modicon M221/M221 Book</b>	<b>Modicon M241</b>		<b>Modicon M251</b>	<b>Modicon M262</b>	<b>LMC Eco, LMC Pro2</b>	
More details in catalog		<a href="#">DIA3ED2140106EN</a>	<a href="#">DIA3ED2140107EN</a>		<a href="#">DIA3ED2140108EN</a>	<a href="#">DIA3ED2180503EN</a>	<a href="#">DIA7ED2160303EN</a>	

(1) Formerly named SoMachine Basic.

(2) Formerly named SoMachine, EcoStruxure Machine Expert merges both former software ranges, SoMachine and SoMachine Motion.



### Machine Automation

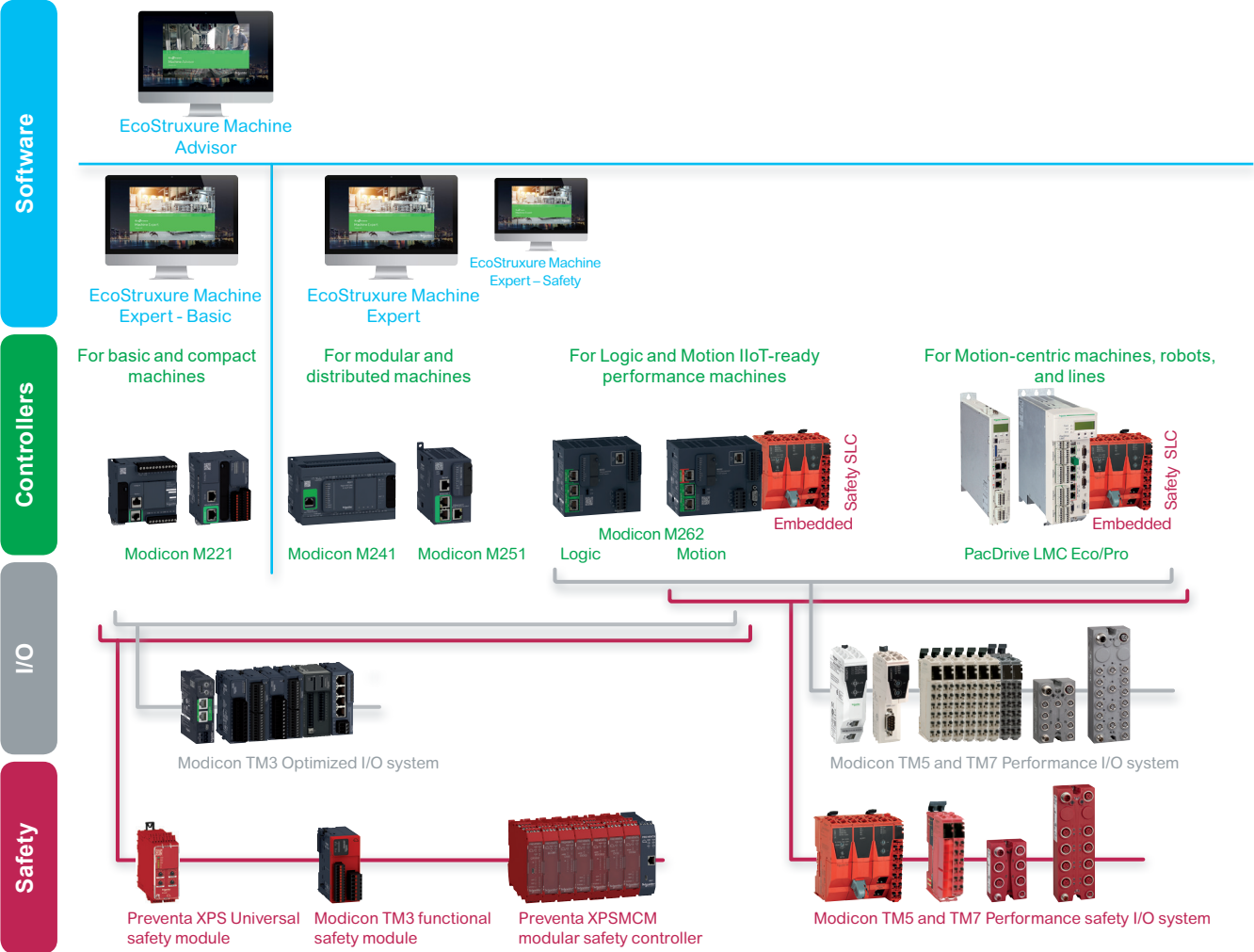

### Machine control

The scalability and consistency of I/O ranges allow you to select the right offer depending on your needs

Embedded Safety provides holistic solutions to Modicon M262 and PacDrive LMC controllers, increasing overall safety demand in Machine Automation

All these devices are managed within a single software, EcoStruxure Machine Expert, a powerful and collaborative engineering environment

- > From basic to motion- and robot-centric machines with the PacDrive 3 offer, Modicon controllers and solutions bring a consistent and scalable response to achieving flexibility, performance, productivity, and digitization.
- > Modicon TM3 Optimized I/O system for more compact and modular machines
- > Modicon TM5 for more performance-demanding machines, with Modicon TM7 for harsh environments; Both Performance I/O ranges (Modicon TM5 and TM7) allow safety functions to be implemented using the Modicon TM5CSLC safety logic controller
- > Preventa XPS Universal safety modules cover a wide range of safety functions, suitable for small applications with 4-5 safety functions, with diagnostic information provided to controllers via a single wire connection
- > Modicon TM3 safety functional modules are suitable for small applications covering E-Stop functions and diagnostics via TM3 bus
- > Preventa XPSMCM modular safety controllers are suitable for medium size applications with up to 20 safety functions and diagnostics via Modbus TCP, EtherNet/IP, EtherCAT, or Profinet
- > **EcoStruxure Machine Expert – Safety** optional add-on for programming safety logic controllers
- > **EcoStruxure Machine Expert – Basic** software for programming Modicon M221 logic controllers: an intuitive standalone environment accessible to basic skilled technicians
- > **EcoStruxure Machine Advisor** is a cloud-based services platform designed for machine builders to track machines in operation worldwide, monitor performance data, and resolve exceptional events, while reducing support costs by up to 50%

### Machine Automation

### Comprehensive Schneider offers for machine builders

- > Lexium servo drives, motors, and robotics are designed to control applications ranging from a single independent axis up to high-performance synchronized multi-axis machines requiring high-speed and precise positioning and movements



[Robotics](#)



[Integrated drives](#)



[Servo Drives & Motors](#)



[Steppers Drives & Motors](#)

- > The Lexium offer is designed for a broad range of motion-centric machines in applications such as [Packaging](#), [Material Handling](#), [Material Working](#), [Food and Beverage](#), and [Electronics](#)
- > Schneider Electric has developed Tested Validated & Documented Architectures (TVDA) applicable for generic machine control applications as well as for dedicated segment applications such as Packaging, Material Handling, Material Working, Hoisting, Pumping, or generic [Machine Control applications](#)

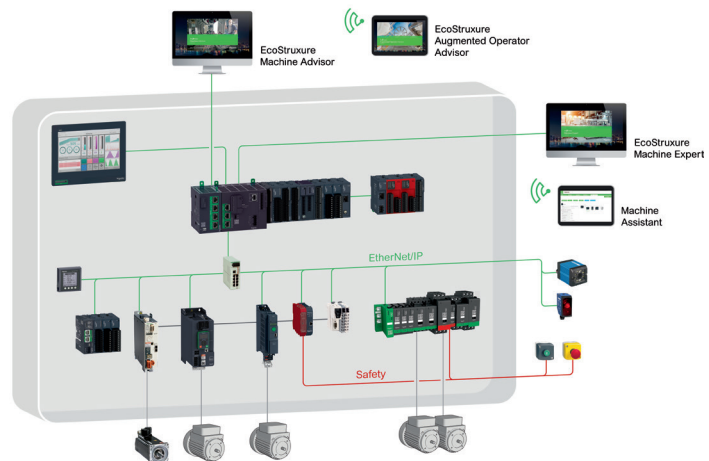

### Choose Schneider Electric to help secure your investment and benefit from worldwide services at every step of your project

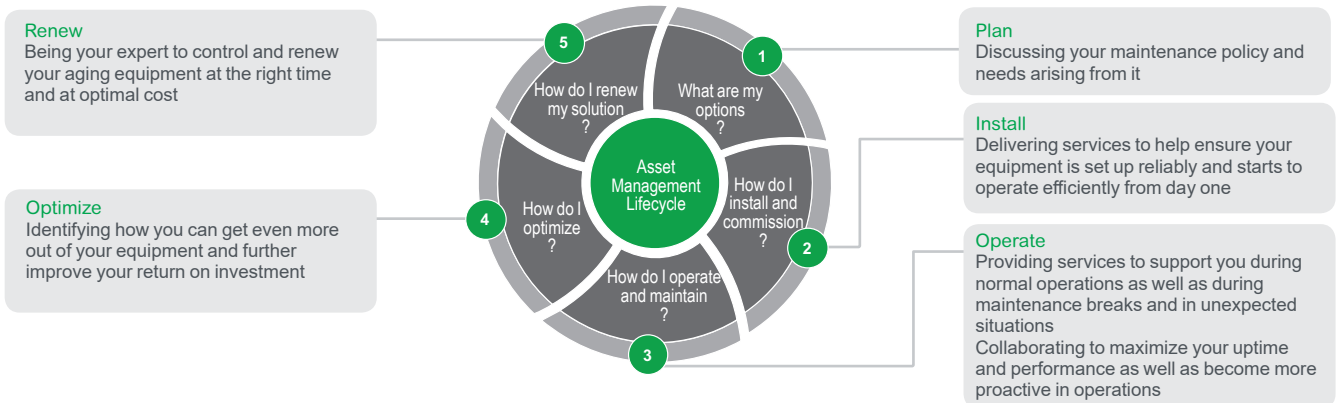

- > From planning and inception to modernization, we help ensure optimal technical and business performance. Our field service engineers combine 30+ years of manufacturer-level experience with the latest technology to bring innovation to every level of our offer, and every step of your project.
- > Our machine control dedicated services empower you to maximize your business infrastructure and face increasingly stringent demands on productivity, safety, equipment availability, and performance optimization.

# Modbus serial link for machines

## With Modicon M221 logic controller

### Presentation

RS232/RS485 serial links offer a simple solution to the communication needs of compact machines.

Modbus and ASCII communication protocols are used to connect numerous devices such as HMIs, printers, energy meters, variable speed drives, motor starters, and remote I/O (RIO).

Thanks to the I/O Scanner function, these devices are just as easy to integrate into the application as the local I/O.

### Description

Modicon M221 Book logic controllers with 16, 24, or 40 I/O have the following on the front panel:

- 1 A serial link port with an RJ45 connector delivering a voltage of 5 V (200 mA) to power an HMI or Bluetooth® adapter
- 2 A slot for a second serial link port (with connection on screw terminals) by inserting the **TMC2SL1** communication cartridge or the **TMC2CONV01** application cartridge (1)

Modicon M221 Book logic controllers with 16 or 32 I/O have the following on the front panel:

- 3 A serial link port with an RJ45 connector delivering a voltage of 5 V (200 mA) to power an HMI or Bluetooth® adapter
- 4 A second serial port also equipped with an RJ45 connector for **TM221M16●●** and **TM221M32●●** controllers (controllers without embedded Ethernet)

Controller type	Embedded ports		Optional port (1 max. per controller) On TMC2SL1 or TMC2CONV01 option cartridges (connection on screw terminals)
	"Serial" or Serial 1" port (RJ45 connector)	"Serial 2" port (RJ45 connector)	
<b>TM221C●●●●</b>	RS232/RS485 with 5 V (200 mA) power supply for HMI or Bluetooth communication adapter (items 1 and 3)	—	RS232/RS485 (item 2)
<b>TM221M●●●●</b>	—	RS485 (item 4)	—
<b>TM221ME●●●●</b>	—	—	—

(1) TM221C40●●●● controllers have 2 slots for a cartridge; only one cartridge, TMC2SL1 or TMC2CONV01, can be used per controller. The other slot remains available for an analog I/O cartridge or an application cartridge.

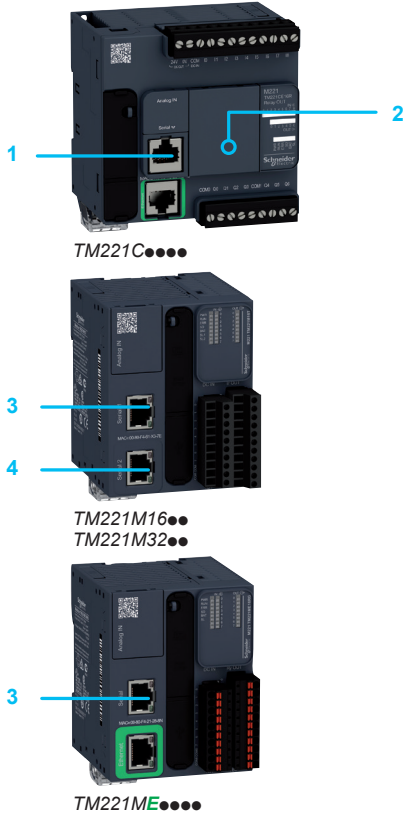

### Modbus serial link wiring system

#### Non-isolated link

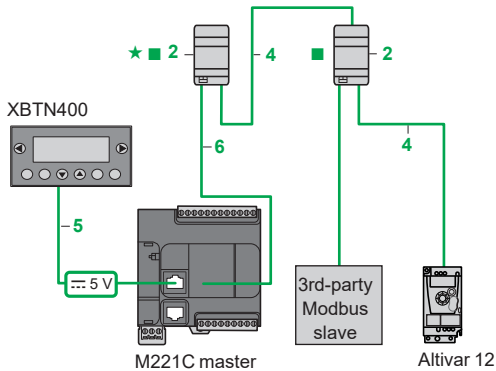

- Total length of cables between M221 and ATV 12:  $\leq 30\text{ m}$  (98.43 ft)
- Length of cable 4:  $\leq 10\text{ m}$  (32.8 ft)
- ★ Active line polarization ■ Line termination

#### Isolated link (recommended for link > 10 m (32.8 ft))

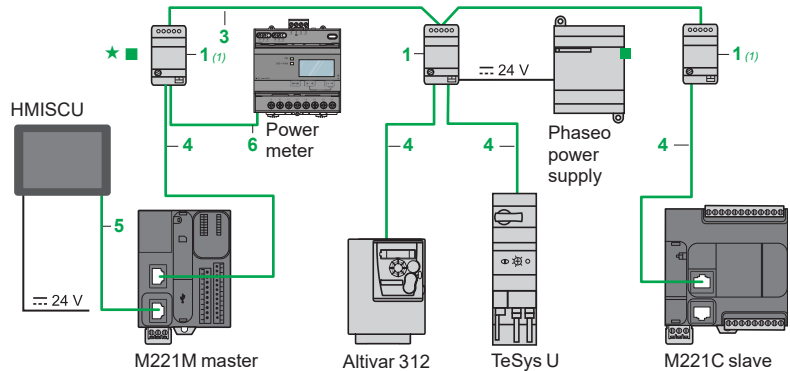

- Total length of cables between isolation boxes 1:  $\leq 1,000\text{ m}$  (3,281 ft)
- Length of drop cables 4 or 5:  $\leq 10\text{ m}$  (32.8 ft)
- ★ Active line polarization ■ Line termination
- (1) Box powered by the logic controller

Refer to the catalog below:



[DIA3ED2140106EN](#)





TWDXCAISO



TWDXCAT3RJ



LU9GC3

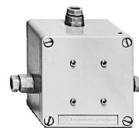

TSXSACA50



XGSZ24

References						
Designation	Description	Item	Length	Unit reference	Weight kg lb	
<b>Tap-off and adapter components for RS485 serial link</b>						
<b>T-junction box with line isolation</b> Screw terminal block for trunk cable 2x RJ45 for tap-off	<input type="checkbox"/> Isolation of the RS485 link (1) <input type="checkbox"/> Line termination (RC 120 Ω, 1nF) <input type="checkbox"/> Line pre-polarization (2 R 620 Ω) <input type="checkbox"/> 24 V $\overline{\text{---}}$ power supply (screw terminal block) or 5 V $\overline{\text{---}}$ (via RJ45) <input type="checkbox"/> Mounting on 35 mm (1.38 in.) $\perp$	1	–	TWDXCAISO	0.100 0.220	
<b>T-junction box</b> 1x RJ45 for trunk cable 2x RJ45 for tap-off	<input type="checkbox"/> Line termination (RC 120 Ω, 1nF) <input type="checkbox"/> Line pre-polarization (2 R 620 Ω) <input type="checkbox"/> Mounting on 35 mm (1.38 in.) $\perp$	2	–	TWDXCAT3RJ	0.080 0.176	
<b>Modbus splitter box</b> Screw terminal block for trunk cable 10x RJ45 for tap-off	<input type="checkbox"/> Mounting on 35 mm (1.38 in.) $\perp$ on plate or panel	–	–	LU9GC3	0.500 1.102	
<b>T-junctions</b> 2x RJ45 for trunk cable	1 integrated cable with RJ45 connector for tap-off dedicated to Altivar variable speed drive	–	0.3 m 0.98 ft	VW3A8306TF03	–	
			1 m 3.28 ft	VW3A8306TF10	–	
<b>Passive T-junction box</b>	<input type="checkbox"/> 1-channel line extension and tap-off on screw terminals <input type="checkbox"/> Line termination	–	–	TSXSACA50	0.520 1.146	
<b>RS232C/RS485 line converter</b>	<input type="checkbox"/> Max. data rate 19.2 Kbps, No modem signals <input type="checkbox"/> 24 V $\overline{\text{---}}$ /20 mA power supply <input type="checkbox"/> Mounting on 35 mm (1.38 in.) $\perp$	–	–	XGSZ24	0.100 0.220	
<b>Cables and cordsets for RS485 serial link</b>						
<b>RS485 double shielded twisted pair trunk cables</b>	Modbus serial link, supplied without connector	3	100 m 328 ft	TSXCSA100	5.680 12.522	
			200 m 656 ft	TSXCSA200	10.920 24.074	
			500 m 1,640 ft	TSXCSA500	30.000 66.139	
<b>Modbus RS485 cordsets</b>	2x RJ45 connectors	4	0.3 m 0.98 ft	VW3A8306R03	0.030 0.066	
			1 m 3.28 ft	VW3A8306R10	0.050 0.110	
			3 m 9.84 ft	VW3A8306R30	0.150 0.331	
	1x RJ45 connector and 1 end with flying leads	6	3 m 9.84 ft	VW3A8306D30	0.150 0.331	
<b>Controller to Magelis HMI cordsets</b>	2x RJ45 connectors Compatible with:	5	2.5 m 8.2 ft	XBTZ9980	0.230 0.507	
	<input type="checkbox"/> Com port 1 on XBTN200, XBTN400, and XBTR400 (2) <input type="checkbox"/> Com port 1 on HMISTO, HMISTU, and HMISCU <input type="checkbox"/> Com port 2 on XBTGT2●●0 and HMIGTO	5	10 m 32.81 ft	XBTZ9982	–	
	1x RJ45 connector and 1x 25-way SUB-D connector Compatible with Com port 1 on XBTN410, XBTR410, and XBTR411	–	2.5 m 8.2 ft	XBTZ938	0.210 0.463	
	1x RJ45 connector and 1x 9-way SUB-D connector Compatible with Com port 1 on XBTGT2●●0	–	2.5 m 8.2 ft	XBTZ9008	0.150 0.331	
<b>TMC2SL1 cartridge to Magelis HMI cordsets</b>	1x RJ45 connector and stripped wires Compatible with:	–	3 m 9.84 ft	VW3A8306D30	0.150 0.331	
	<input type="checkbox"/> Com port 1 on HMISTO, HMISTU, and HMISCU <input type="checkbox"/> Com port 2 on XBTGT2●●0 and HMIGTO					
<b>Line terminator</b> Sold in packs of 2	For RJ45 connector R = 120 Ω, C = 1 nF	–	–	VW3A8306RC	0.200 0.441	
<b>Cordsets for RS232 serial link</b>						
<b>Cordset for DTE terminal</b> (printer) (3)	Serial link for data terminal equipment (DTE) 1x RJ45 connector and 1x 9-way female SUB-D connector		3 m 9.84 ft	TCSMCN3M4F3C2	0.150 0.331	
<b>Cordset for DCE terminal</b> (modem, converter)	Serial link for data connection equipment (DCE) 1x RJ45 connector and 1x 9-way male SUB-D connector		3 m 9.84 ft	TCSMCN3M4M3S2	0.150 0.331	

(1) Line isolation recommended for line distances > 10 m (32.8 ft).

(2) Can only be connected to the controller SL or SL1 ports in order to supply the Magelis terminal with power.

(3) If the terminal is equipped with a 25-way SUB-D connector, you will also need a 25-way female/9-way male SUB-D adapter.

# Modbus serial link for machines

With Modicon M241 logic controller, Modicon M251 logic controller, and Modicon M262 Logic/Motion controller

## Presentation

RS232/RS485 serial links offer a simple solution to the communication needs of machines.

Modbus and ASCII communication protocols are used to connect numerous devices such as HMIs, printers, energy meters, variable speed drives, motor starters, and remote I/O (RIO).

## Description

**Modicon M241** logic controllers have the following on their top panel:

- 1 A "Serial 1" link port with an RJ45 connector for connecting a Magelis HMI, Bluetooth® communication adapter, or other device
- 2 A second serial link port "Serial 2" (with connection on screw terminals)

Controller type	Embedded ports	
	"Serial 1" port (RJ45 connector)	"Serial 2" port (connection on screw terminals)
TM241●●●●	RS232/RS485 with 5V (200 mA) power supply for HMI or Bluetooth communication adapter (item 1)	RS485 (item 2)

- 3 Modicon M251 logic controllers and **Modicon M262** Logic/Motion controllers have a serial link (SL) port on their front panel (RS232 or RS485, RJ45 connector) for communicating with peripheral devices supporting the Modbus protocol as either a master or slave, ASCII protocol (printer, modem, etc.), and Machine Expert protocol (HMI, etc.).



Modicon M241 logic controller

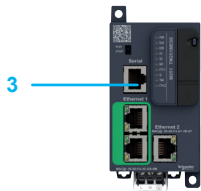

Modicon M251 logic controller

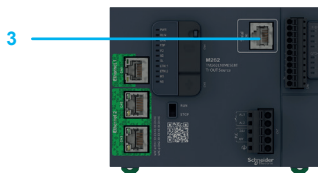

Modicon M262 Logic/Motion controller

## Modbus serial link wiring system

### Non-isolated link

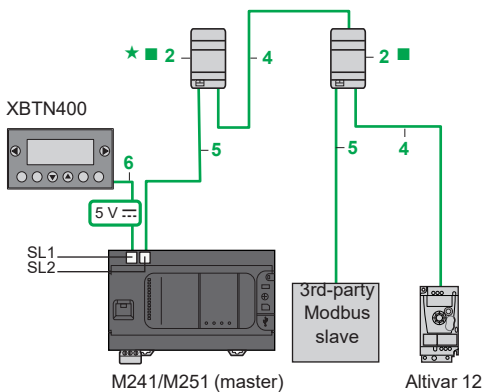

### Isolated link (recommended for link > 10 m (32.8 ft))

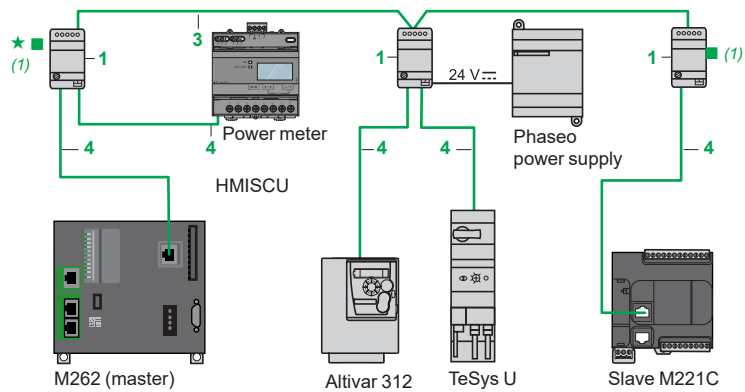

- Total length of cables between M241/M251 and ATV12 ≤ 30 m (98.43 ft)
- Length of cable 4: ≤ 10 m (32.8 ft)
- ★ Active line polarization ■ Line termination

- Total length of cables between isolation boxes 1: ≤ 1,000 m (3,281 ft)
- Length of cable 4: ≤ 10 m (32.8 ft)
- ★ Active line polarization ■ Line termination
- (1) Box powered by the logic controller

Refer to the catalogs below:



[DIA3ED2140107EN](#)









[DIA3ED2140108EN](#)



[DIA3ED2180503EN](#)

# Modbus serial link for machines

With Modicon M241 logic controller, Modicon M251 logic controller, and Modicon M262 Logic/Motion controller

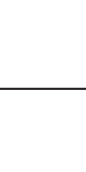
References									
Designation	Description	Item	Length	Reference	Weight kg lb				
<b>Tap-off and adapter components for RS485 serial link</b>									
 TWDXCAISO	<b>T-junction box with line isolation</b> Screw terminal block for trunk cable 2x RJ45 for tap-off	<input type="checkbox"/> Isolation of the RS485 link (1) <input type="checkbox"/> Line termination (RC 120 Ω, 1nF) <input type="checkbox"/> Line pre-polarization (2 R 620 Ω) <input type="checkbox"/> 24 V $\overline{\text{---}}$ power supply (screw terminal block) or 5 V $\overline{\text{---}}$ (via RJ45) <input type="checkbox"/> Mounting on 35 mm (1.38 in.) $\perp$	1	–	TWDXCAISO	0.100			
						0.220			
 TWDXCAT3RJ	<b>T-junction box</b> 1x RJ45 for trunk cable 2x RJ45 for tap-off	<input type="checkbox"/> Line termination (RC 120 Ω, 1nF) <input type="checkbox"/> Line pre-polarization (2 R 620 Ω) <input type="checkbox"/> Mounting on 35 mm (1.38 in.) $\perp$	2	–	TWDXCAT3RJ	0.080			
						0.176			
 LU9GC3	<b>Modbus splitter box</b> Screw terminal block for trunk cable 10x RJ45 for tap-off	<input type="checkbox"/> Mounting on 35 mm (1.38 in.) $\perp$ on plate or panel	–	–	LU9GC3	0.500			
						1.102			
 TSXSACA50	<b>T-junctions</b> 2x RJ45 for trunk cable	1 integrated cable with RJ45 connector for tap-off dedicated to Altivar variable speed drive	–	0.3 m	VW3A8306TF03	–			
				0.98 ft		–			
 XGSZ24	<b>Passive T-junction box</b>	<input type="checkbox"/> 1-channel line extension and tap-off on screw terminals <input type="checkbox"/> Line termination	–	–	TSXSACA50	0.520			
						1.146			
 RS232C/RS485 line converter		<input type="checkbox"/> Max. data rate 19.2 Kbps, No modem signals <input type="checkbox"/> 24 V $\overline{\text{---}}$ /20 mA power supply <input type="checkbox"/> Mounting on 35 mm (1.38 in.) $\perp$	–	–	XGSZ24	0.100			
						0.220			
<b>Cables and cordsets for RS485 serial link</b>									
 LU9GC3	<b>RS485 double shielded twisted pair trunk cables</b>	Modbus serial link, supplied without connector	3	100 m	TSXCSA100	5.680			
				328 ft		11.023			
				200 m		TSXCSA200	10.920		
				656 ft		24.074			
 TSXSACA50	<b>Modbus RS485 cordsets</b>	2x RJ45 connectors	4	0.3 m	VW3A8306R03	0.030			
				0.98 ft		0.066			
				1 m		VW3A8306R10	0.050		
				3.28 ft		0.110			
 TSXSACA50	<b>Cordsets for use between M241 (SL1), M251 controllers and Magelis HMI</b>	2x RJ45 connectors Compatible with: <input type="checkbox"/> Com port 1 on XBTN200, XBTN400, and XBTR400 (2) <input type="checkbox"/> Com port 1 on HMISTO, HMISTU, and HMISCU <input type="checkbox"/> Com port 2 on XBTGT2●●0 and HMIGTO	6	2.5 m	XBTZ9980	0.230			
				8.2 ft		0.507			
				10 m		XBTZ9982	–		
				32.8 ft		–			
 XGSZ24	<b>Cordsets for use between M241 (SL2) controllers and Magelis HMI</b>	1x RJ45 connector and 1x 25-way SUB-D connector Compatible with Com port 1 on XBTN410, XBTR410, and XBTR411 <input type="checkbox"/> Com port 1 on HMISTO, HMISTU, and HMISCU <input type="checkbox"/> Com port 2 on XBTGT2●●0 and HMIGTO	–	2.5 m	XBTZ938	0.210			
				8.2 ft		0.463			
				1x RJ45 connector and 1x 9-way SUB-D connector Compatible with Com port 1 on XBTGT2●●0		–	2.5 m	XBTZ9008	–
				8.2 ft			–		
 TWDXCAISO	<b>Line terminator</b> Sold in packs of 2	For RJ45 connector R = 120 Ω, C = 1 nF	–	–	VW3A8306RC	0.200			
						0.441			
<b>Cordsets for RS232 serial link</b>									
 TWDXCAISO	<b>Cordset for DTE terminal (printer) (3)</b>	Serial link for data terminal equipment (DTE) 1x RJ45 connector and 1x 9-way female SUB-D connector	–	3 m	TCSMCN3M4F3C2	0.150			
				9.84 ft		0.331			
 TWDXCAISO	<b>Cordset for DCE terminal (modem, converter)</b>	Serial link for data connection equipment (DCE) 1x RJ45 connector and 1x 9-way male SUB-D connector	–	3 m	TCSMCN3M4M3S2	0.150			
				9.84 ft		0.331			

(1) Line isolation recommended for line distances > 10 m (32.8 ft).

(2) Can only be connected to the controller SL or SL1 ports in order to supply the Magelis terminal with power.

(3) If the terminal is equipped with a 25-way SUB-D connector, you will also need a 25-way female/9-way male SUB-D adapter.

# Modbus serial link for machines

With Modicon M258 logic controller and Modicon LMC058 motion controller

## Modbus serial link wiring system

### Non-isolated link

### Isolated link

Magelis XBT

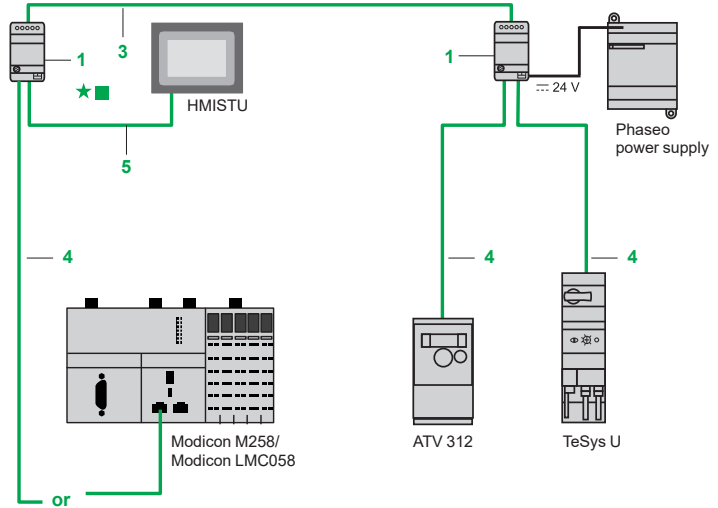
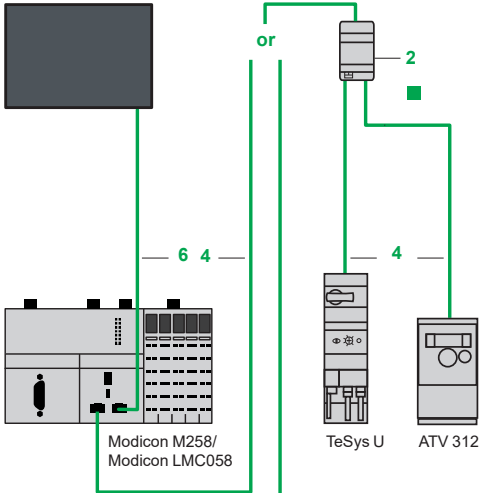

Magelis XBT

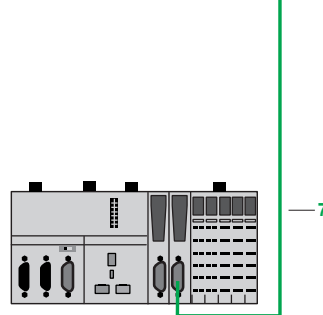
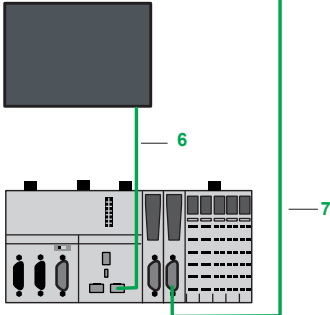

Modicon M258 + TM5 PCRS●/  
Modicon LMC058 + TM5 PCRS●

Modicon M258 + TM5 PCRS●/  
Modicon LMC058 + TM5 PCRS●

- Length of cables between Modicon M258 and Altivar:  
≤ 30 m (98.43 ft)

- Total length of cables between isolation boxes 1: ≤ 1,000 m (3,281 ft)

★ Active line polarization

- Length of drop cables 4, 5, or 6 ≤ 10 m (32.8 ft)

■ Line termination

Refer to the catalogs below:



DIA6ED2100402EN



DIA7ED2100803EN

# Modbus serial link for machines

With Modicon M258 logic controller and Modicon LMC058 motion controller



TWD XCA ISO



TWD XCA T3RJ



LU9 GC3



TSX SCA 50



XGS Z24

References						
Designation	Description	Item	Length	Unit reference	Weight	
					kg	lb
<b>Tap-off and adapter components for RS485 serial link</b>						
<b>Isolation box</b> Screw terminal block for trunk cable 2x RJ45 for tap-off	<input type="checkbox"/> Isolation of the RS485 link (1) <input type="checkbox"/> Line termination (RC 120 Ω, 1nF) <input type="checkbox"/> Line pre-polarization (2 R 620 Ω) <input type="checkbox"/> 24 V $\bar{\text{---}}$ power supply (screw terminal block) or 5 V $\bar{\text{---}}$ (via RJ45) <input type="checkbox"/> Mounting on 35 mm (1.38 in.) $\perp$	1	–	TWDXCAISO	0.100 0.220	
<b>Tap junction box</b> 1x RJ45 for main cable 2x RJ45 for tap-off	<input type="checkbox"/> Line termination (RC 120 Ω, 1nF) <input type="checkbox"/> Line pre-polarization (2 R 620 Ω) <input type="checkbox"/> Mounting on 35 mm (1.38 in.) $\perp$	2		TWDXCAT3RJ	0.080 0.176	
<b>Modbus splitter box</b> Screw terminal block for trunk cable 10x RJ45 for tap-off	<input type="checkbox"/> Mounting on 35 mm (1.38 in.) $\perp$ on plate or panel	–	–	LU9GC3	0.500 1.102	
<b>T-junctions</b> 2x RJ45 for trunk cable	1 integrated cable with RJ45 connector for tap-off dedicated to Altivar variable speed drive	–	0.3 m 0.98 ft	VW3A8306TF03	–	
			1 m 3.28 ft	VW3A8306TF10	–	
<b>Passive T-junction box</b>	<input type="checkbox"/> 1-channel line extension and tap-off on screw terminals <input type="checkbox"/> Line termination	–	–	TSXSCA50	0.520 1.146	
<b>RS232C/RS485 line converter</b>	<input type="checkbox"/> Max. data rate 19.2 Kbps, No modem signals <input type="checkbox"/> 24 V $\bar{\text{---}}$ /20 mA power supply <input type="checkbox"/> Mounting on 35 mm (1.38 in.) $\perp$	–	–	XGSZ24	0.100 0.220	
<b>Cables and cordsets for RS485 serial link</b>						
<b>RS485 double shielded twisted pair trunk cables</b>	Modbus serial link, supplied without connector	3	100 m 328 ft	TSXCSA100	5.680 12.522	
			200 m 656 ft	TSXCSA200	10.920 24.074	
			500 m 1,640 ft	TSXCSA500	30.000 66.139	
<b>Modbus RS485 cordsets</b>	2x RJ45 connectors	4	0.3 m 0.98 ft	VW3A8306R03	0.030 0.066	
			1 m 3.28 ft	VW3A8306R10	0.050 0.110	
			3 m 9.84 ft	VW3A8306R30	0.150 0.331	
	1x RJ45 connector and 1 end with free wires	–	3 m 9.84 ft	VW3A8306D30	0.150 0.331	
<b>Cordsets for Modicon M258 (SL1, SL2) to Magelis display unit and terminal</b>	2x RJ45 connectors Compatible with: <input type="checkbox"/> Com port 1 on XBTN200, XBTN400, and XBTR400 (2) <input type="checkbox"/> Com port 1 on HMISTO, HMISTU, and HMISCU <input type="checkbox"/> Com port 2 on XBTGT2●●0 and HMIGTO	6	2.5 m 8.2 ft	XBTZ9980	0.150 0.331	
	1x RJ45 connector and 1x 25-way SUB-D connector Compatible with Com port 1 on XBTN410, XBTR410, and XBTR411	5, 6	2.5 m 8.2 ft	XBTZ938	0.210 0.463	
	1x RJ45 connector and 1x 9-way SUB-D connector Compatible with Com port 1 on XBTGT2●●0	6	2.5 m 8.2 ft	XBTZ9008	0.150 0.331	
<b>Cordset for Magelis Small Panel display unit and terminal</b>	1x RJ45 connector and stripped wires Compatible with: <input type="checkbox"/> Com port 1 on HMISTO, HMISTU, and HMISCU <input type="checkbox"/> Com port 2 on XBTGT2●●0 and HMIGTO	5	3 m 9.84 ft	VW3A8306R30	0.150 0.331	
<b>Line terminator</b> Sold in packs of 2	For RJ45 connector R = 120 Ω, C = 1 nf	–	–	VW3A8306RC	0.200 0.440	
<b>Cordsets for RS232 serial link</b>						
<b>Cordset for DTE terminal (printer) (3)</b>	Serial link for data terminal equipment (DTE) 1x RJ45 connector and 1x 9-way female SUB-D connector	7	3 m 9.84 ft	TCSMCN3M4F3C2	0.150 0.331	
<b>Cordset for DCE terminal (modem, converter)</b>	Serial link for data connection equipment (DCE) 1x RJ45 connector and 1x 9-way male SUB-D connector	7	3 m 9.84 ft	TCSMCN3M4M3S2	0.150 0.331	

(1) Line isolation recommended for line distances > 10 m (32.8 ft).

(2) Can only be connected to the controller SL or SL1 ports in order to supply the Magelis terminal with power.

(3) If the terminal is equipped with a 25-way SUB-D connector, you will also need a 25-way female/9-way male SUB-D adapter.



**L**

LU9GC3	9
	11
	13

**T**

TCSMCN3M4F3C2	9
	11
	13

TCSMCN3M4M3S2	9
	11
	13

TSXCSA100	9
	11
	13

TSXCSA200	9
	11
	13

TSXCSA500	9
	11
	13

TSXCSA50	9
	11
	13

TWDXCAISO	9
	11
	13

TWDXCAT3RJ	9
	11
	13

**V**

VW3A8306D30	9
	11
	13

VW3A8306R03	9
	11
	13

VW3A8306R10	9
	11
	13

VW3A8306R30	9
	11
	13

VW3A8306RC	9
	11
	13

VW3A8306TF03	9
	11
	13

VW3A8306TF10	9
	11
	13

**X**

XBTZ9008	9
	11
	13

XBTZ938	9
	11
	13

XBTZ9980	9
	11
	13

XBTZ9982	9
	11

XGSZ24	9
	11
	13



[www.schneider-electric.com/Machine control solutions](http://www.schneider-electric.com/Machine control solutions)

#### Schneider Electric Industries SAS

Head Office  
35, rue Joseph Monier  
F-92500 Rueil-Malmaison  
France

The information provided in this documentation contains general descriptions and/or technical characteristics of the performance of the products contained herein. This documentation is not intended as a substitute for and is not to be used for determining suitability or reliability of these products for specific user applications. It is the duty of any such user or integrator to perform the appropriate and complete risk analysis, evaluation and testing of the products with respect to the relevant specific application or use thereof. Neither Schneider Electric nor any of its affiliates or subsidiaries shall be responsible or liable for misuse of the information contained herein.

Design: Schneider Electric  
Photos: Schneider Electric