

Single Gang Cast Device Boxes & Covers

3/4 INCH FSC BOX W/O COVER -SGFT



Catalog Number PRFSC2
UPC 784011205349

Description

PVC coated device boxes and covers, available in several configurations, may be used in coated conduit systems to accommodate wiring devices, to serve as pull boxes for conductors, or to allow for splices and taps in conductors. Electrical continuity of the conduit system is maintained across assembled joints.

Application

- Used in coated conduit systems to accommodate wiring devices, to serve as pull boxes for conductors, or to allow for splices and taps in conductors

Features

- 40 mil gray PVC exterior coating
- 2 mil red urethane interior coating
- 3 trade sizes from 1/2" through 1"
- Available in Standard (FS) and Deep (FD) Styles
- Internal grounding screw is standard
- Sealing sleeves on all conduit openings

General Information

Trade Size	3/4
Material	FERROUS METAL
Material	FERROUS METAL
Exterior Finish	A nominal .040 inch (40 mil) gray PVC coating
Interior Finish	A nominal .002 inch (2 mil) red urethane
Body Style	FS - Shallow
Configuration	Single Gang
Feed Type	Feed Thru

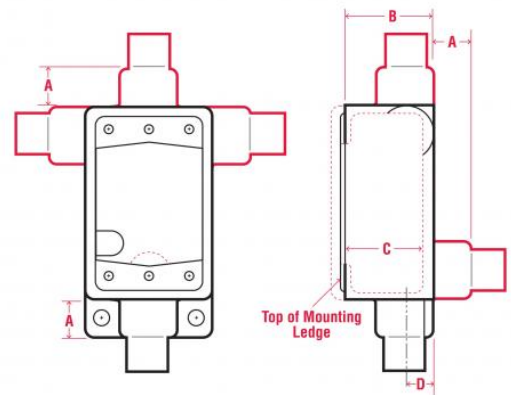

Dimensions

Dimension A (Inches)	0.88
Dimension B (Inches)	1.92
Dimension C (Inches)	1.69
Dimension D (Inches)	0.79
Nominal Weight (Pounds)	2.4

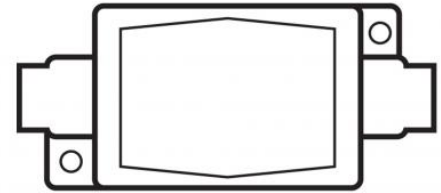

Standards

CSA Certified	CSA C22.2 No. 42
CSA Certified	CSA C22.2 No. 18
UL 514A, 514D	E231035

Technical Specification Documents

Specification Guide (1995 Master)	AVAILABLE ON WEBSITE
Specification Guide (2004 Master)	AVAILABLE ON WEBSITE
Installer Certification and Tools	AVAILABLE ON WEBSITE
Chemical Resistance Charts	AVAILABLE ON WEBSITE
Performance Specifications	AVAILABLE ON WEBSITE

Technical Information

Conduit Body	FSC
Feed Type	Feed Thru
Fitting Configuration	1GANG
Fitting Type	SHALLOW
Product Category	CONDUIT BOX FS/FD
Product Family	Single Gang Cast Device Boxes & Covers

Notes

- Covers available separately

