



Product Datasheet



ANDERSON FARGO

WTT2153014 -- Tee, Aluminum Weldment



Tee, Aluminum Weldment, Angle, Tube to Two Tubes, 3 to 1-1/2 IPS/EHIPS tubes

Product Specifications

<p>Family Image</p>	 <p>Tees</p>
<p>Tees</p>	 <p>WTT2-15 Series Tube to Two Tubes, 15 Degree Aluminum Weldment Tees</p>
<p>PDF Catalog Page</p>	<p>Click HERE to view the web page.</p>
<p>Dimension A</p>	<p>1.50 in (38.1 mm)</p>
<p>Dimension B</p>	<p>6.06 in (154.0 mm)</p>
<p>Dimension C</p>	<p>2.44 in (61.9 mm)</p>
<p>Dimension L</p>	<p>3.50 in (88.9 mm)</p>
<p>Material Type</p>	<p>Non-Standard</p>
<p>UPC Code</p>	<p>09635934343</p>
<p>Standard Package</p>	<p>1</p>
<p>Standard Package Unit</p>	<p>Each</p>
<p>Min Order Qty</p>	<p>1</p>
<p>Weight / Ea.</p>	<p>1.862 lbs</p>

Compressed Product Number

WTT2153014

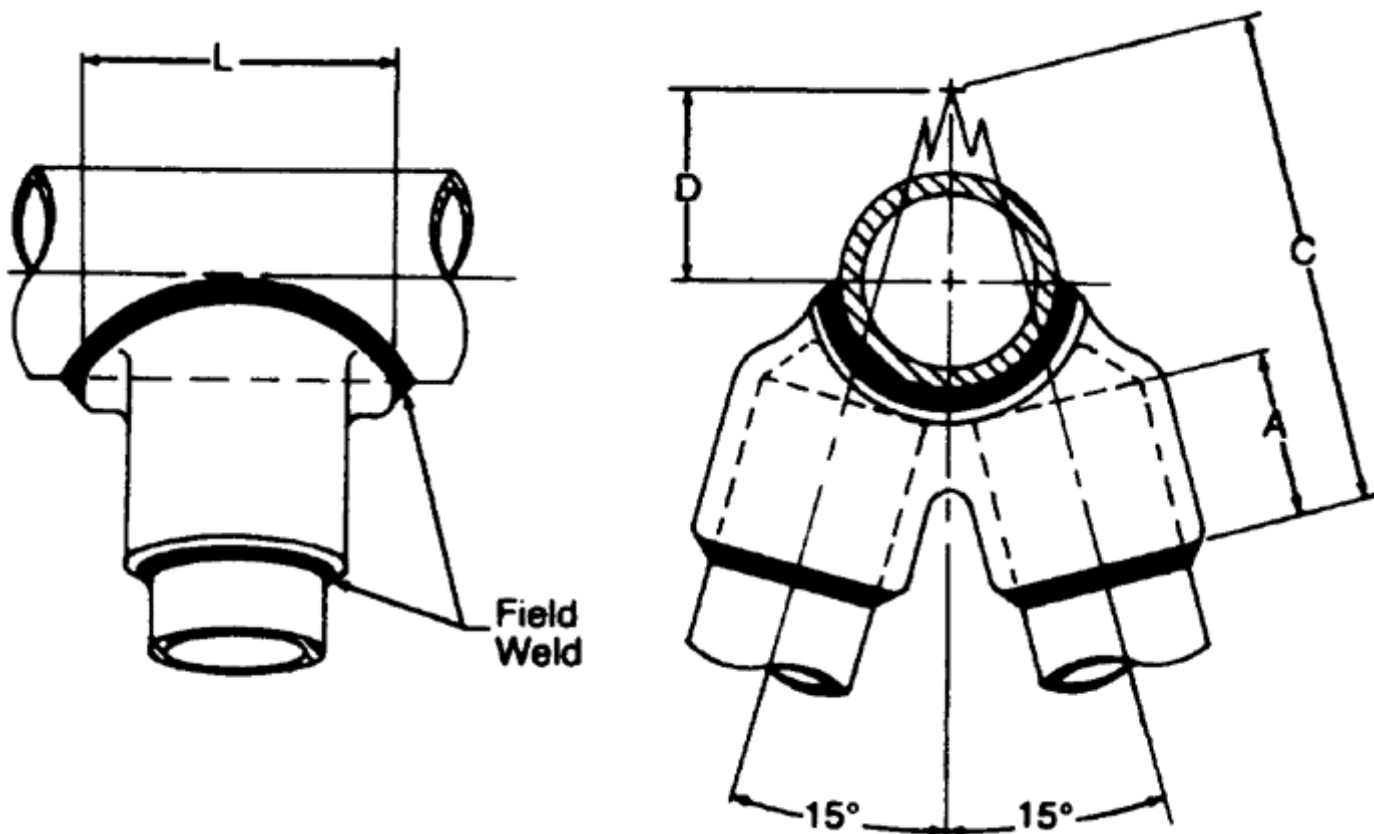

[Catalog Home](#)



[Warranty Info](#) | [Trademarks](#) | [Terms of Use](#)

All contents Copyright © 2007 Hubbell Power Systems, Inc. All rights reserved.

NOTE: Because Hubbell has a policy of continuous product improvement, we reserve the right to change design and specifications without notice.