

Terminal Blocks

Class 9080 NEMA Type Terminal Blocks

Catalog

9080CT9601R08/21

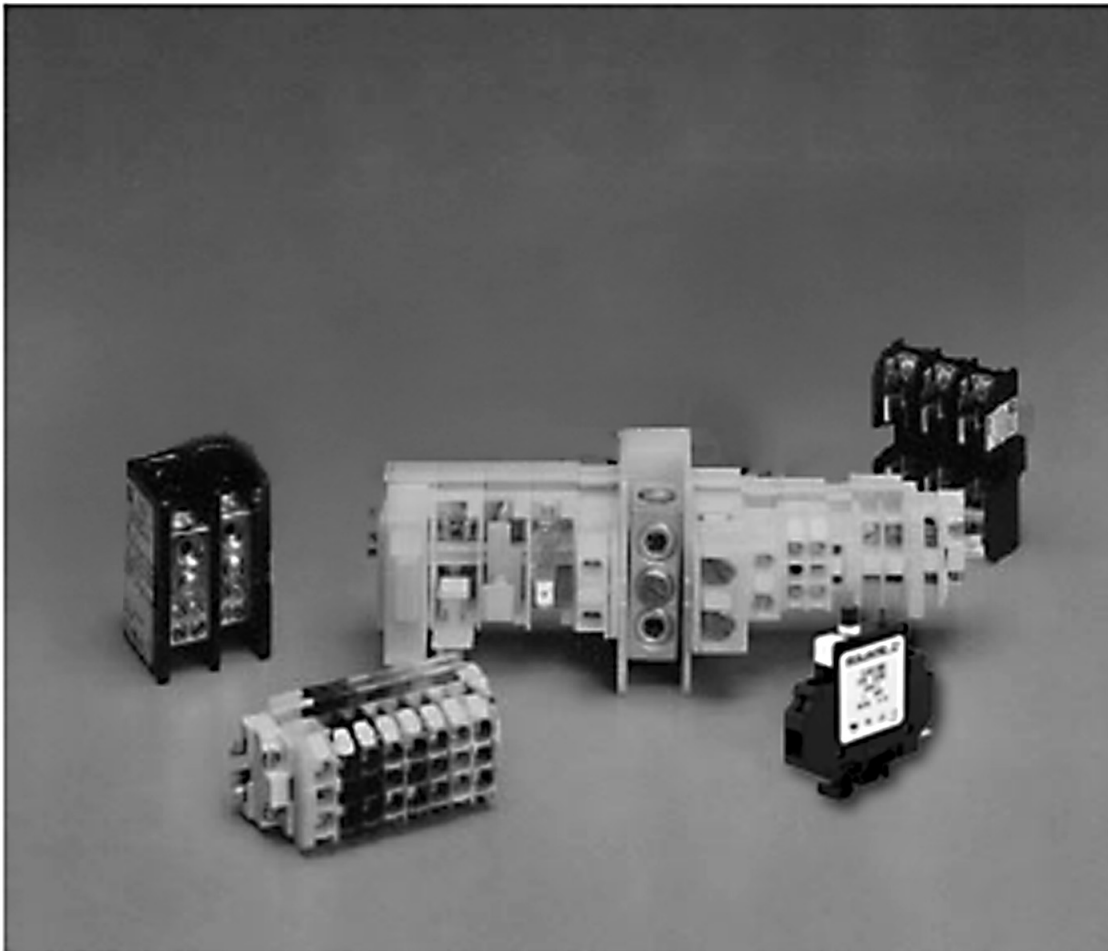

Legal Information

The Schneider Electric brand and any trademarks of Schneider Electric SE and its subsidiaries referred to in this guide are the property of Schneider Electric SE or its subsidiaries. All other brands may be trademarks of their respective owners.

This guide and its content are protected under applicable copyright laws and furnished for informational use only. No part of this guide may be reproduced or transmitted in any form or by any means (electronic, mechanical, photocopying, recording, or otherwise), for any purpose, without the prior written permission of Schneider Electric.

Schneider Electric does not grant any right or license for commercial use of the guide or its content, except for a non-exclusive and personal license to consult it on an "as is" basis. Schneider Electric products and equipment should be installed, operated, serviced, and maintained only by qualified personnel.

As standards, specifications, and designs change from time to time, information contained in this guide may be subject to change without notice.



To the extent permitted by applicable law, no responsibility or liability is assumed by Schneider Electric and its subsidiaries for any errors or omissions in the informational content of this material or consequences arising out of or resulting from the use of the information contained herein.

Schneider Electric, Fingersafe, Linergy, and Square D are trademarks and the property of Schneider Electric SE, its subsidiaries, and affiliated companies. All other trademarks are the property of their respective owners.



Table of Contents

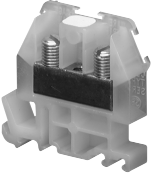

Product Overview.....	5
Quick Selector	7
Box Lug Termination.....	9
Other Terminations	13
Other Blocks	15
Mounting Tracks.....	17
Accessories	19
Single-Pole Thermal-Magnetic Control Circuit Protectors.....	22
Dimensions	25
Type G Block Approximate Dimensions	25
Circuit Protectors and Assemblies Approximate Dimensions.....	27
Mounting Track and End Clamps Approximate Dimensions and Diagrams	28

Product Overview

Family	Description
<p>Figure 1 - Class 9080 Type G</p> 	<p>Square D™ 9080 Terminal Blocks</p> <p>This family of NEMA blocks and accessories offers features such as a large variety of colors, high density to save space in applications, multiple mounting methods such as 35 mm DIN rail, 9080GH (3/4") track, or direct panel mounting. They are UL component recognized, CSA approved, RoHS compliant, and CE marked.</p>
<p>Figure 2 - Class 9080 Type GCB</p> 	<p>Square D Circuit Protectors</p> <p>The Class 9080 Type GCB Series C thermal-magnetic circuit protector is a trip-free, track-mountable device with current ratings from 0.1–15 A. The thermal feature trips when there is an overload of ten times rated current or less. The magnetic mechanism trips instantaneously when there is a short circuit. Maximum interrupt rating of 200 A, but not exceeding 10,000% (100 times) rated current.</p>

NOTE: The product lines listed below are not shown in this catalog. Please refer to the referenced catalog included with each family.

Family	Description
<p>Figure 3 - NSYEB Enclosed Power Distribution Blocks</p> 	<p>Schneider Electric™ NSYEB Enclosed Power Distribution Blocks</p> <p>NSYEB power distribution blocks are enclosed IEC versions of our NEMA 9080 power distribution blocks, which are finger safe from the front according to IP20, and available with copper or aluminum lugs. They have Short-Circuit Current Ratings (SCCR) up to 100 kA. They are one-pole modular units with an interlocking dovetail feature that enables ganging of the blocks to create multi-pole configurations according to application requirements. Most are UL Listed (some are UL component recognized), CSA approved, and RoHS compliant. CE marking ensures acceptance throughout the European community. The UL Listed blocks meet feeder circuit spacing requirements.</p> <p>Refer to catalog 9080CT9603</p>
<p>Figure 4 - Class 9080 Type LB</p> 	<p>Square D 9080 Open Power Distribution Blocks</p> <p>Available in a wide variety of sizes, these NEMA open power distribution blocks are available in one, two, and three pole versions with either aluminum or copper lugs. Many blocks have been tested to achieve SCCR up to 100 kA. They are UL component recognized, CSA approved, RoHS compliant, and CE marked. A selection of covers completes this family.</p> <p>Refer to catalog 9080CT9603</p>



Family	Description
<p>Figure 5 - Class 9080 Type FB</p> 	<p>Square D 9080 FB Fuse Holders</p> <p>This family of NEMA fuse holders will accept types H, R, CC, M, and J fuses up to 200 amperes. Both 250 V and 600 V versions are available. Types H, R, J, and CC are UL Listed. Type M fuse holders are UL component recognized. They are all CSA approved, CE marked, and RoHS compliant.</p> <p>Refer to catalog 9080CT9603</p>
<p>Figure 6 - Linergy Terminal Block</p> 	<p>Schneider Electric Linergy™ Terminal Blocks</p> <p>Depending on the application, there are several types of IEC terminal blocks:</p> <ul style="list-style-type: none"> • Screw technology terminal blocks are suitable for the majority of connection applications due to their wide range of functions and connection possibilities. • Spring technology requires no maintenance and helps provide a separation of mechanical and electrical functions. • Push-in terminal blocks reduce wiring time and eliminate the need for regular re-tightening. • The hybrid offer is a combination of screw terminal and Insulation Displacement Connection (IDC). <p>These blocks are UL component recognized, CSA approved, CE marked, and RoHS compliant.</p> <p>Refer to catalog 9080CT1301.</p>

Quick Selector

All Square D terminal blocks are:



- 600 V rated (except the 9080 GT6 transient voltage suppressor, which is 120 V)
- Track mountable (9080GK6 can also be directly mounted).

Table 1 - Box Lug Termination

Termination		Box Lug						
Block Material		Nylon						
Wire Range mm ² (AWG) solid or stranded copper wire only		6.0–0.34 (10–22)	10–0.34 (8–22)	10–0.34 (8–22)	6.0–0.34 (10–22)	25–0.75 (4–18)	55–4.0 (1/0–12)	120–16 (250 kcmil–6)
Maximum Amperage ¹	UL	30	60	60	70	110	180	255
	CSA	30	60	60	40	85	170	280
Sections per foot		51	34	34	34	28	17	10
Temperature Rating		-40 to 257 °F (-40 to 125 °C)						
Flammability Rating		UL94V2						
Listings		 File E60616, Guide XCFR2				File LR62144, Class 6228 01	RoHS Compliant	
Catalog Number		GM6	GR6	GR6T	GK6	GC6	GD6	GE6
Page		Types GM6, GR6, and GR6T, page 9	Types GM6, GR6, and GR6T, page 9	Types GM6, GR6, and GR6T, page 9	Types GK6, GC6, GD6, and GE6, page 11	Types GK6, GC6, GD6, and GE6, page 11	Types GK6, GC6, GD6, and GE6, page 11	Types GK6, GC6, GD6, and GE6, page 11

1. These maximum current values assume the use of insulated copper conductors with 167 °F (75 °C) temperature rating, and are calculated based on NEC Article 310, Table 310-16. In most cases this value is the maximum ampacity of that wire or combination of wires (as listed in the above table) which has the greatest current carrying capacity. The actual allowable current for a particular application is dependent upon the number, size, insulation class and other characteristics of the wires used.



Table 2 - Other Terminations

Termination		Flat Screw	Pressure Wire	Slip-On	Fuse Block	Circuit Isolating Switch	Transient Voltage Suppressor
Block Material		Nylon					
Wire Range mm ² (AWG) solid or stranded copper wire only		4.0–0.34 (12–22)	4.0–0.75 (12–18)	4.0–0.34 (12–22)	6.0–0.75 (10–18)	6.0–0.75 (10–18)	6.0–0.75 (10–18)
Maximum Amperage ²	UL	40	40	20	30	30	N/A
	CSA	40	40	20	30	30	N/A
Sections per foot		32	32	16	16	16	24
Temperature Rating		-40 to 257 °F (-40 to 125 °C)					
Flammability Rating		UL94V2					
Listings			File E60616, Guide XCFR2			File LR62144, Class 6228 01	
Catalog Number		GA6	GP6	GS6	GF6	GG6	GT6
Page		Types GA6, GP6, and GS6, page 13	Types GA6, GP6, and GS6, page 13	Types GA6, GP6, and GS6, page 13	Types GF6, GG6, and GT6, page 15	Types GF6, GG6, and GT6, page 15	Types GF6, GG6, and GT6, page 15

2. These maximum current values assume the use of insulated copper conductors with 167 °F (75 °C) temperature rating, and are calculated based on NEC Article 310, Table 310-16. In most cases this value is the maximum ampacity of that wire or combination of wires (as listed in the above table) which has the greatest current carrying capacity. The actual allowable current for a particular application is dependent upon the number, size, insulation class and other characteristics of the wires used.

Box Lug Termination

Table 3 - Types GM6, GR6, and GR6T

Class 9080		TYPE GM6	TYPE GR6	TYPE GR6T
		Figure 7 - High Density Block 	Figure 8 - Without Test Probe Adapter 	Figure 9 - With Test Probe Adapter 
Maximum Voltage Rating		600	600	600
Maximum Amperage Rating ³	UL	30	60	60
	CSA	30	60	60
Wire Range mm ² (AWG) solid or stranded copper wire only		6.0–0.34 (10–22)	10–0.34 (8–22)	10–0.34 (8–22)
Maximum Wire Combination Quantity, mm ² (AWG)		1, 6.0 (10) 1, 4.0 (12) 1, 2.5 (14) 1 or 2, 1.5 (16) 1 or 2, 0.75 (18) 1 to 5, 0.50 (20) 1 to 8, 0.34 (22)	1, 10 (8) 1, 6.0 (10) 1 to 3, 4.0 (12) 1 to 4, 2.5 (14) 1 to 4, 1.5 (16) 1 to 5, .075 (18) 1 to 8, 0.50 (20) 1 to 10, 0.34 (22)	1, 10 (8) 1, 6.0 (10) 1 to 3, 4.0 (12) 1 to 4, 2.5 (14) 1 to 4, 1.5 (16) 1 to 5, 0.75 (18) 1 to 8, 0.50 (20) 1 to 10, 0.34 (22)
Wire Type		Solid or Stranded Copper Wire	Solid or Stranded Copper Wire	Solid or Stranded Copper Wire
Density—Sections per foot		51	34	34
Approx. Dimensions: D x H x W		1.72 x 1.82 x .235 in. (44 x 46 x 6 mm)	1.72 x 1.82 x .35 in. (44 x 46 x 9 mm)	1.72 x 1.82 x .35 in. (44 x 46 x 9 mm)
Block Material		Nylon		
Busbar Material		Tin Plated Brass	N/A	N/A
Screw Material		Steel with Zinc Plating and Chromate Film		
Box Lug Material		Zinc Plated Steel	Copper	
Temperature Rating		-40 to 257° F (-40 to 125° C)	-40 to 257° F (-40 to 125° C)	-40 to 257° F (-40 to 125° C)
Flammability Rating		UL94V2	UL94V2	UL94V2
Recommended Tightening Torque		7–8 lbf-in (0.8–0.9 N•m)	18–20 lbf-in (2.1–2.3 N•m)	18–20 lbf-in (2.1–2.3 N•m)
Listings	UL	File E60616, Guide XCFR2		
	CSA	File LR62144, Class 6228 01		
Fingersafe™ per DIN 57470		YES	YES	YES
Block:				
• Natural (White)		GM6	GR6	GR6T
• Black		GMB6	GRB6	—
• Blue		GML6	GRL6	—





3. These maximum current values assume the use of insulated copper conductors with 167 °F (75 °C) temperature rating, and are calculated based on NEC Article 310, Table 310-16. In most cases this value is the maximum ampacity of that wire or combination of wires (as listed in the above table) which has the greatest current carrying capacity. The actual allowable current for a particular application is dependent upon the number, size, insulation class and other characteristics of the wires used.

Table 3 - Types GM6, GR6, and GR6T (Continued)

Class 9080	TYPE GM6	TYPE GR6	TYPE GR6T
	Figure 7 - High Density Block 	Figure 8 - Without Test Probe Adapter 	Figure 9 - With Test Probe Adapter 
• Green	GMG6	GRG6	—
• Grey	GME6	GRE6	—
• Orange	GMS6	GRS6	—
• Red	GMR6	GRR6	—
• Yellow	GMY6	GRY6	—
End Barrier	GM6B	GM6B	GM6B
Six ft assembly	—	GR6204BC	—
Mounting Track:⁴			
• DIN 3: 0.5 m long	MH320	MH320	MH320
• DIN 3: 1.0 m long	MH339	MH339	MH339
• DIN 3: 2.0 m long	MH379	MH379	MH379
• Standard: 3 ft long	GH136	GH136	GH136
• Snap-Off: 3 ft long	GH236	GH236	GH236
• High Rise: 3 ft long	GH336	GH336	GH336
End Clamps:			
• Screw-in	GH10	GH10	GH10
• Slip-in	GH11	GH11	GH11
• DIN 3 End Clamp	MHA10	MHA10	MHA10
Jumpers:			
• 2 pole	GH700	GH72	GH72
• 6 pole	GH710	GH73	GH73
Fanning Strip	—	GH52	GH52
Cover	—	GH62	GH62
Vinyl Marking Strip	GH220	GH220	GH220
Sheets of Blank Marking Tabs	—	GH200	GH200
Sheets of Marked Tabs	—	GH210	GH210
Marking Strip End Plug	GH60	GH60	GH60

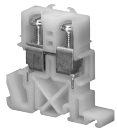
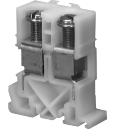

4. For additional mounting tracks, see Mounting Tracks, page 17.

Table 4 - Types GK6, GC6, GD6, and GE6

Class 9080		TYPE GK6	TYPE GC6	TYPE GD6	TYPE GE6
		 (Mounts on channel or directly to a panel)			
Maximum Voltage Rating		600	600	600	600
Maximum Amperage Rating ⁵	UL	70	110	180	255
	CSA	40	85	170	280
Wire Range mm ² (AWG) solid or stranded copper wire only		6.0–0.34 (10–22)	25–0.75 (4–18)	55–4.0 (1/0–12)	120–16 (250 kcmil–6)
Maximum Wire Combination Quantity, mm ² (AWG)		1, 6.0 (10) 1 or 2, 4.0 (12) 1 or 2, 2.5 (14) 1 to 4, 1.5 (16) 1 or 5, 0.75 (18) 1 to 8, 0.50 (20) 1 to 10, 0.34 (22)	1, 25 (4) 1, 16 (6) 1 or 2, 10 (8) 1 to 4, 6.0 (10) 1 or 5, 4.0 (12) 1 or 6, 2.5 (14) 1 to 6, 1.5 (16) 1 to 8, 0.75 (18)	1, 50 (1) 1, 35 (2) 1 or 2, 25 (4) 1 to 3, 16 (6) 1 to 5, 10 (8) 1, 6.0 (10) 1 to 6, 6.0 (10) 1 to 7, 4.0 (12)	1, 120 (250 kcmil) 1, 120 (4/0) 1, 95 (3/0) 1, 70 (2/0) 1, 55 (1/0) 1, 50 (1) 1, 35 (2) 1, 25 (4) or 16 (6)
Wire Type		Solid or Stranded Copper Wire	Solid or Stranded Copper Wire	Solid or Stranded Copper Wire	Copper or Aluminum Wire
Density—Sections per foot		35	28	17	10
Approx. Dimensions: D x H x W		1.40 x 1.39 x .35 in. (36 x 35 x 9 mm)	1.99 x 2.13 x .43 in. (50 x 54 x 11 mm)	2.12 x 2.71 x .70 in. (54 x 69 x 18 mm)	3.32 x 2.34 x 1.17 in. (84 x 59 x 30 mm)
Block Material		Nylon			
Busbar Material		N/A	Tin Plated Brass	Tin Plated Copper	N/A
Screw Material		Steel with Zinc Plating and Chromate Film			Aluminum with Tin Plating
Box Lug Material		Copper	Zinc Plated Steel	Tin Plated Steel	Tin Plated Aluminum
Temperature Rating		-40 to 257° F (-40 to 125° C)	-40 to 257° F (-40 to 125° C)	-40 to 257° F (-40 to 125° C)	-40 to 257° F (-40 to 125° C)
Flammability Rating		UL94V2	UL94V2	UL94V2	UL94V2
Recommended Tightening Torque		11–12 lbf-in (1.2–1.4 N•m)	32–35 lbf-in (3.6–4.0 N•m)	45–50 lbf-in (5.0–5.6 N•m)	225–250 lbf-in (25.4–28.2 N•m)
Listings		File E60616, Guide XCFR2			
RoHS Compliant		File LR62144, Class 6228 01			
Fingersafe per DIN 57470		NO	NO	NO	NO
Block:					
• Natural (White)		GK6	GC6	GD6	GE6
• Black		GKB6	—	—	—
• Blue		GKL6	—	—	—
• Green		GKG6	—	—	—

5. These maximum current values assume the use of insulated copper conductors with 167 °F (75 °C) temperature rating, and are calculated based on NEC Article 310, Table 310-16. In most cases this value is the maximum ampacity of that wire or combination of wires (as listed in the above table) which has the greatest current carrying capacity. The actual allowable current for a particular application is dependent upon the number, size, insulation class and other characteristics of the wires used.

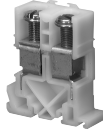

Table 4 - Types GK6, GC6, GD6, and GE6 (Continued)

Class 9080	TYPE GK6	TYPE GC6	TYPE GD6	TYPE GE6
	 (Mounts on channel or directly to a panel)			
• Grey	GKE6	—	—	—
• Orange	GKS6	—	—	—
• Red	GKR6	—	—	—
• Yellow	GKY6	—	—	—
End Barrier	GK6B	GC6B	GD6B	—
Mounting Track:⁶				
• DIN 3: 0.5 m long	—	MH320	MH320	MH320
• DIN 3: 1.0 m long	—	MH339	MH339	MH339
• DIN 3: 2.0 m long	—	MH379	MH379	MH379
• Standard: 3 ft long	GH136	GH136	GH136	GH136
• Snap-Off: 3 ft long	GH236	GH236	GH236	GH236
• High Rise: 3 ft long	GH336	GH336	GH336	GH336
End Clamps:				
• Screw-in	GH10	GH10	GH10	GH10
• Slip-in	—	GH11	GH11	—
• DIN 3 End Clamp	—	MHA10	MHA10	MHA10
Jumpers:				
• 2 pole	GH72	GH74	GH76	—
• 6 pole	GH73	GH75	GH77	—
Fanning Strip	GH52	—	—	—
Cover	—	—	—	—
Vinyl Marking Strip	GH220	GH220	GH220	GH220
Sheets of Blank Marking Tabs	—	—	GH200	—
Sheets of Marked Tabs	—	—	GH210	—
Marking Strip End Plug	GH60	GH60	GH60	GH60

6. For additional mounting track, see Mounting Tracks, page 17.



Other Terminations

Table 5 - Types GA6, GP6, and GS6

Class 9080		TYPE GA6	TYPE GP6	TYPE GS6
		Figure 10 - Flat Terminal Connectors 	Figure 11 - Pressure Wire Connectors 	Figure 12 - Slip-On Connectors 
Maximum Voltage Rating		600	600	600
Maximum Amperage Rating ⁷	UL	40	40	20
	CSA	40	40	20
Wire Range mm ² (AWG) solid or stranded copper wire only		4.0–0.34 (12–22)	4.0–0.75 (12–18)	4.0–0.34 (12–22)
Maximum Wire Combination Quantity, mm ² (AWG)		Ring or Spade Connectors 1 or 2, 4.0 (12) 1 or 2, 2.5 (14) 1 or 2, 1.5 (16) 1 or 2, 0.75 (18) 1 or 2, 0.50 (20) 1 or 2, 0.34 (22)	1 or 2, 4.0 (12) 1 or 2, 2.5 (14) 1 or 2, 1.5 (16) 1 or 2, 0.75 (18)	0.250 x 0.032 in. Slip-on Connectors 1 or 2, 4.0 (12) 1 or 2, 2.5 (14) 1 or 2, 1.5 (16) 1 or 2, 0.75 (18) 1 or 2, 0.50 (20) 1 or 2, 0.34 (22)
Wire Type		Solid or Stranded Copper Wire	Solid or Stranded Copper Wire	Solid or Stranded Copper Wire
Density—Sections per foot		32	32	16
Approx. Dimensions: D x H x W		1.80 x 1.48 x 0.37 in. (46 x 38 x 10 mm)	1.80 x 1.48 x 0.37 in. (46 x 38 x 10 mm)	2.19 x 1.69 x 0.75 in. (56 x 43 x 19 mm)
Block Material		Nylon		
Busbar Material		Tin Plated Brass		
Screw Material		Steel with Zinc Plating and Chromate Film		N/A
Box Lug Material		N/A	N/A	N/A
Temperature Rating		-40 to 257° F (-40 to 125° C)	-40 to 257° F (-40 to 125° C)	-40 to 257° F (-40 to 125° C)
Flammability Rating		UL94V2	UL94V2	UL94V2
Recommended Tightening Torque		18–20 lbf-in (2.1–2.3 N•m)	18–20 lbf-in (2.1–2.3 N•m)	N/A
Listings	UL	File E60616, Guide XCFR2		
	CSA	File LR62144, Class 6228 01		
RoHS Compliant				
Fingersafe per DIN 57470		YES	NO	NO
Block:				
• Natural (White)		GA6	GP6	GS6
• Black		—	—	—
• Blue		—	—	—
• Green		—	—	—

7. These maximum current values assume the use of insulated copper conductors with 167 °F (75 °C) temperature rating, and are calculated based on NEC Article 310, Table 310-16. In most cases this value is the maximum ampacity of that wire or combination of wires (as listed in the above table) which has the greatest current carrying capacity. The actual allowable current for a particular application is dependent upon the number, size, insulation class, and other characteristics of the wires used.

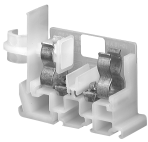



Table 5 - Types GA6, GP6, and GS6 (Continued)

Class 9080	TYPE GA6	TYPE GP6	TYPE GS6
	Figure 10 - Flat Terminal Connectors 	Figure 11 - Pressure Wire Connectors 	Figure 12 - Slip-On Connectors 
• Grey	—	—	—
• Orange	—	—	—
• Red	—	—	—
• Yellow	—	—	—
End Barrier	GP6B	GP6B	GF6B
Six ft assembly	GP6188BO	—	—
Mounting Track:⁸			
• DIN 3: 0.5 m long	MH320	MH320	MH320
• DIN 3: 1.0 m long	MH339	MH339	MH339
• DIN 3: 2.0 m long	MH379	MH379	MH379
• Standard: 3 ft long	GH136	GH136	GH136
• Snap-Off: 3 ft long	GH236	GH236	GH236
• High Rise: 3 ft long	GH336	GH336	GH336
End Clamps:			
• Screw-in	GH10	GH10	GH10
• Slip-in	GH11	GH11	GH11
• DIN 3 End Clamp	MHA10	MHA10	MHA10
Jumpers:			
• 2 pole	GH78	GH78	—
• 6 pole	GH79	GH79	—
Cover	—	—	—
Vinyl Marking Strip	GH220	GH220	—
Sheets of Blank Marking Tabs	—	—	GH200
Sheets of Marked Tabs	—	—	GH210
Marking Strip End Plug	GH60	GH60	—

8. For additional mounting track, see the figure Mounting Tracks, page 17.



Other Blocks

Table 6 - Types GF6, GG6, and GT6

Class 9080		TYPE GF6	TYPE GG6	TYPE GT6
		Figure 13 - Fuse Block 	Figure 14 - Circuit Isolating Switch 	Figure 15 - Transient Voltage Suppressor 
Maximum Voltage Rating		600	600	600
Maximum Amperage Rating ⁹	UL	30	30	N/A
	CSA	30	30	N/A
Wire Range mm ² (AWG) solid or stranded copper wire only		6.0–0.75 (10–18)	6.0–0.75 (10–18)	6.0–0.75 (10–18)
Maximum Wire Combination Quantity, mm ² (AWG)		1, 6.0 (10) 1, 4.0 (12) 1, 2.5 (14) 1 to 4, 1.5 (16) 1 to 4, 0.75 (18)	1, 6.0 (10) 1, 4.0 (12) 1, 2.5 (14) 1 to 4, 1.5 (16) 1 to 4, 0.75 (18)	1, 6.0 (10) 1, 4.0 (12) 1, 2.5 (14) 1 to 4, 1.5 (16) 1 to 4, 0.75 (18)
Wire Type		Solid or Stranded Copper Wire	Solid or Stranded Copper Wire	Solid or Stranded Copper Wire
Density—Sections per foot		16	16	24
Approx. Dimensions: D x H x W		2.19 x 2.33 x 0.75 in. (56 x 59 x 19 mm)	2.19 x 2.07 x 0.76 in. (56 x 53 x 19 mm)	2.16 x 2.55 x 0.50 in. (55 x 65 x 13 mm)
Block Material		Nylon		
Busbar Material		Tin Plated Copper		N/A
Screw Material		Steel with Zinc Plating and Chromate		
Box Lug Material		N/A	N/A	Copper
Temperature Rating		-40 to 221 ° F (-40 to 105° C)	-40 to 257° F (-40 to 125° C)	-40 to 257° F (-40 to 125° C)
Flammability Rating		UL94V2	UL94V2	UL94V2
Recommended Tightening Torque		18–20 lbf-in (2.1–2.3 N•m)	18–20 lbf-in (2.1–2.3 N•m)	18–20 lbf-in (2.1–2.3 N•m)
Listings		File E60616, Guide XCFR2		
RoHS Compliant		File LR62144, Class 6228 01		
Fingersafe per DIN 57470		YES	NO	NO
Block:				
• Natural (White)		GF6	GG6	GT6
• Black		—	—	—
• Blue		—	—	—
• Green		—	—	—

9. These maximum current values assume the use of insulated copper conductors with 167 °F (75 °C) temperature rating, and are calculated based on NEC Article 310, Table 310-16. In most cases this value is the maximum ampacity of that wire or combination of wires (as listed in the above table) which has the greatest current carrying capacity. The actual allowable current for a particular application is dependent upon the number, size, insulation class and other characteristics of the wires used.

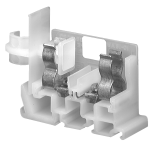
Table 6 - Types GF6, GG6, and GT6 (Continued)

Class 9080	TYPE GF6	TYPE GG6	TYPE GT6
	Figure 13 - Fuse Block 	Figure 14 - Circuit Isolating Switch 	Figure 15 - Transient Voltage Suppressor 
• Grey	—	—	—
• Orange	—	—	—
• Red	—	—	—
• Yellow	—	—	—
End Barrier	GF6B	GF6B	GT6B
Mounting Track: ¹⁰			
• DIN 3: 0.5 m long	MH320	MH320	MH320
• DIN 3: 1.0 m long	MH339	MH339	MH339
• DIN 3: 2.0 m long	MH379	MH379	MH379
• Standard: 3 ft long	GH136	GH136	GH136
• Snap-Off: 3 ft long	GH236	GH236	GH236
• High Rise: 3 ft long	GH336	GH336	GH336
End Clamps:			
• Screw-in	GH10	GH10	GH10
• Slip-in	GH11	GH11	GH11
• DIN 3 End Clamp	MHA10	MHA10	MHA10
Blown Fuse Indicator: 120–240 V	GLP3	N/A	N/A
Blown Fuse Indicator: 277–600 V	GLP6	N/A	N/A
Replacement Fuse Puller	GH63	N/A	N/A
Vinyl Marking Strip	N/A	GH220	GH220
Sheets of Blank Marking Tabs	GH200	GH200	GH200
Sheets of Marked Tabs	GH210	GH210	GH210
Marking Strip End Plug	N/A	N/A	—

10. For additional mounting tracks, see Mounting Tracks, page 17.

Mounting Tracks

Table 7 - Mounting Tracks





Description		Length: m (in.)	Catalog Number
IEC Type Mounting Track			
<p>DIN 3</p> <p>Symmetrical rail 35 x 7.5 mm (1.38 in. x .295 in.) in compliance with EN 50022 standard (DIN 462777-3). Available in shorter length. Contact Schneider Electric.</p>	<p>Galvanized steel, no mounting holes</p> 	0.5 m (19.68 in.)	9080 MH220
		1 m (39.37 in.)	9080 MH239
		2 m (78.74 in.)	9080 MH279
	<p>Galvanized steel, prepunched</p> 	0.5 m (19.68 in.)	9080 MH320
		1 m (39.37 in.)	9080 MH339
		2 m (78.74 in.)	9080 MH379
NEMA Type Mounting Track			
<p>Standard Channel</p> <p>This item is made of galvanized steel. Supplied with prepunched holes to make installation easy.</p> 	0.08 m (3 in.)	9080 GH103	
	0.10 m (4 in.)	9080 GH104	
	0.13 m (5 in.)	9080 GH105	
	0.15 m (6 in.)	9080 GH106	
	0.18 m (7 in.)	9080 GH107	
	0.20 m (8 in.)	9080 GH108	
	0.23 m (9 in.)	9080 GH109	
	0.25 m (10 in.)	9080 GH110	
	0.28 m (11 in.)	9080 GH111	
	0.30 m (12 in.)	9080 GH112	
	0.33 m (13 in.)	9080 GH113	
	0.36 m (14 in.)	9080 GH114	
	0.38 m (15 in.)	9080 GH115	
	0.41 m (16 in.)	9080 GH116	
	0.46 m (18 in.)	9080 GH118	
	0.91 m (36 in.)	9080 GH136	
1.22 m (48 in.)	9080 GH148		
1.83 m (72 in.)	9080 GH172		
<p>Snap-Off Channel</p> <p>This item is made of galvanized steel with serrated segments, spaced approximately 5/16 in. apart. Supplied with prepunched holes to make installation easy.</p> 	0.91 m (36 in.)	9080 GH236	
	1.22 m (48 in.)	9080 GH248	
	1.83 m (72 in.)	9080 GH272	

Table 7 - Mounting Tracks (Continued)

Description	Length: m (in.)	Catalog Number
<p data-bbox="496 253 676 277">High Rise Channel</p> <p data-bbox="496 300 879 324">This item is made of extruded aluminum.</p> 	0.91 m (36 in.)	9080 GH336

Accessories

Table 8 - Jumpers and Fanning Strip







Description	Catalog Number	
<p>Jumpers: 6-pole jumpers can be snapped off to provide 3, 4, or 5 pole jumpers. Material is CDA Alloy 110 Copper.</p>		
	2 pole jumper for 9080 GM6	9080 GH700
	6 pole jumper for 9080 GM6	9080 GH710
	2 pole jumper for 9080 GK6, GR6	9080 GH72
	6 pole jumper for 9080 GK6, GR6	9080 GH73
	2 pole jumper for 9080 GC6	9080 GH74
	6 pole jumper for 9080 GC6	9080 GH75
	2 pole jumper for 9080 GD6	9080 GH76
	2 pole jumper for 9080 GA6, GP6	9080 GH78
	6 pole jumper for 9080 GA6, GP6	9080 GH79
<p>Fanning Strip:</p>		
	Snap-together fanning strip section for 9080 GK6, GR6	9080 GH52

Table 9 - End Clamps



Description	Type
 <p>Screw-on End Clamp for DIN 3 Track</p> <p>This item is made of polycarbonate. Screws are zinc plated steel with iridescent chromate film. Screws are shipped backed out.</p>	<p>MHA10</p>
 <p>Screw-on End Clamp for 9080GH Track</p> <p>This item is made of polycarbonate. Screws are zinc plated steel with iridescent chromate film. Screws are shipped backed out.</p>	<p>9080 GH10</p> <p>NOTE: Not recommended with Snap-off channel.</p>
 <p>Slip-in End Clamp for 9080GH Track</p> <p>This item is made of spring steel with an iridescent chromate film</p>	<p>9080 GH11</p> <p>NOTE: Not to be used with 9080 GE6 or 9080 GK6.</p>

Table 10 - Marking Accessories





Description	Catalog Number
 <p>25 ft. blank vinyl marking strip</p>	<p>9080 GH220</p>
 <p>Vinyl Marking Strips numbered 1–25</p>	<p>For 9080 GK6, GR6</p> <p>9080 GH21</p>
	<p>For 9080 GA6, GP6</p> <p>9080 GH22</p>
	<p>For 9080 GM6</p> <p>9080 GH230</p>
 <p>Blank pin-feed marking tabs—6 x 20 (total 120) marking tabs for 9080 GR6, GD6, and GT6</p>	<p>9080 GH200</p>
 <p>Pre-marked 2 times 01 to 50 plus 20 various marking tabs (total 120 marking tabs) for 9080 GR6, GD6, and GT6</p>	<p>9080 GH210</p>
 <p>Marking strip end plug for 9080 GK6, GR6, GM6, GA6, GP6, GC6, GD6, GE6, GT6</p>	<p>9080 GH60</p>

Table 10 - Marking Accessories (Continued)

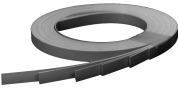

Description		Catalog Number
	Transition barrier between 9080 GK6 and all other G sections	9080 GH61
	Cover for 9080 GR6 and 9080 GR6T	9080 GH62

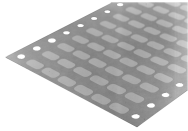
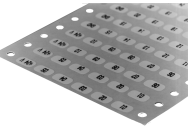
Table 11 - Miscellaneous Accessories

Description		Type
Angle Bracket Kit 	Includes 2 brackets and hardware for mounting track to the brackets.	9080 MH82

Single-Pole Thermal-Magnetic Control Circuit Protectors

Figure 16 - Single-Pole Type GCB Circuit Protector Blocks

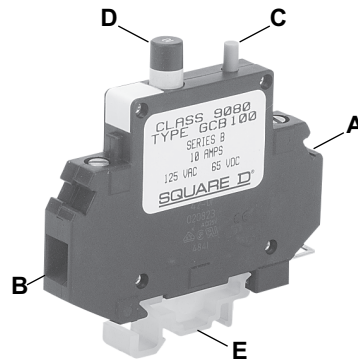

- A. Thermal-magnetic circuit protector
- B. 14 different current ratings: 0.1–15 A
- C. On-Off switch
- D. Visible trip indication
- E. Mounts on Class 9080 GH track and on DIN mounting track

NOTE: 9080GCB circuit protector blocks have solderless box lugs. They accept one CU 6.0 (10)–1.5 (16) wire (for example, the wire gauge conversion of 6.0 mm² is (10) AWG).

Table 12 - Technical Data

Dielectric strength	1500 Vac
Insulation resistance	100 MΩ
Weight	Approximately 2.2 oz.
Terminals	Box lug type
Recommended tightening torque	8–10 lbf-in (0.9–1.1 N·m)
Approvals	UL File: E233026 CNN: QVN02 CE CSA File: 025490 Class: 3211–07
Fingersafe™ per DIN 57470	Yes
Maximum voltage rating <ul style="list-style-type: none"> • GCB01 through GCB70 • GCB100 and GCB150 	<ul style="list-style-type: none"> • 250 Vac / 65 Vdc • 125 Vac / 65 Vdc
Maximum interrupting rating	200 A, but not exceeding 10,000% (100 times) rated current

Selection:

1. Determine the inrush correction factor from the table [Inrush Ratio Correction](#), page 23.
2. Determine the temperature correction factor from the table [Ambient Temperature Correction](#), page 23.
3. Determine the sealed current of the load that is being protected.
4. Multiply the sealed current by the two correction factors and choose the closest circuit protector.

NOTE: Choosing a circuit protector with a value lower than the calculated value might cause nuisance tripping, while choosing the larger might provide a protector that will not properly protect the load.

Example:

A solenoid with sealed current of 0.75 A, an inrush ratio of 1:6, and in an ambient temperature of 85 °F (29.4 °C):

- $0.75 \times 1.5 \times 1.05 = 1.18$
- Choose the 1.2 A protector

The 9080GCB circuit protectors come standard with the track adapter for mounting on 9080GH track (replacement adapter is 9080GH64). Removal of this adapter permits mounting on 9080MH2●●, MH3●●, and AM1 track. See *Mounting Tracks*, page 17 for a complete listing of available tracks.

Table 13 - Maximum Current Values

Maximum Current	Internal Resistance ³ / ₄	Maximum Voltage	Single Pole Type	
0.1	133	250 Vac / 65 Vdc	GCB01	
0.5	6.6		GCB05	
0.8	2.55		GCB08	
1.0	1.97		GCB10	
1.2	1.22		GCB12	
1.5	0.86		GCB15	
2.0	0.49		GCB20	
2.5	0.31		GCB25	
3.0	0.20		GCB30	
4.0	0.10		GCB40	
5.0	0.80		GCB50	
7.0	0.30		GCB70	
10.0	<0.02		125 Vac	GCB100
15.0	<0.02		65 Vdc	GCB150

These maximum current values assume the use of insulated copper conductors with 167° F (75° C) temperature rating, and are calculated based on NEC Article 310, Table 310-16. In most cases this value is the maximum ampacity of that wire or combination of wires (as listed in the above table *Maximum Current Values*, page 23) which has the greatest current carrying capacity. The actual allowable current for a particular application is dependent on the number, size, insulation class and other characteristics of the wires used.

Table 14 - Inrush Ratio Correction

Inrush Ratio	1:1 to 1:4	1:5	1:6	1:7	1:8
Factor	1.3	1.4	1.5	1.6	1.7

Table 15 - Ambient Temperature Correction

Ambient Temperature	70 °F (21.1 °C)	100 °F (37.8 °C)	120 °F (48.9 °C)	140 °F (60 °C)	160 °F (71.1 °C)	180 °F (82.2 °C)	200 °F (93.3 °C)
Factor	1.0	1.1	1.2	1.3	1.4	1.5	1.6

Tripping Time

Tripping time of the circuit protector is determined from the values in the table Tripping Time in Seconds at 70 °F (21.1 °C), page 24. Divide the circuit protector value by the temperature correction factor from the table Ambient Temperature Correction, page 23 above to determine the actual rated current referenced in the table Tripping Time in Seconds at 70 °F (21.1 °C), page 24.

Table 16 - Tripping Time in Seconds at 70 °F (21.1 °C)

Percent rated current	100%	200%	300%	400%	500%	600%	1000%	2000% and greater
Tripping Time (seconds)	no trip	10–40	38	1.5–9	0.8–6	0.003–4	0.003–2	Max. 0.02
<p>NOTE: When several protectors are channel mounted adjacent to each other, the “no trip” current will be 80% of rated current at 70 °F (21.1 °C).</p>								

Dimensions

Type G Block Approximate Dimensions

Dimensions: $\frac{\text{in.}}{\text{mm}}$

Figure 17 - Type GR6 / GR6T

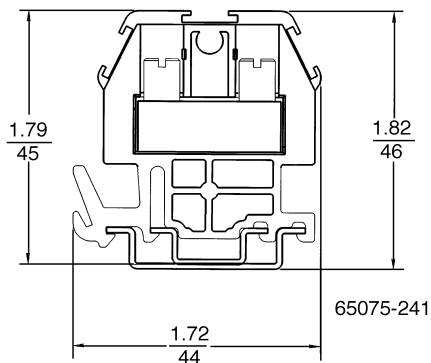

Figure 18 - Type GM6

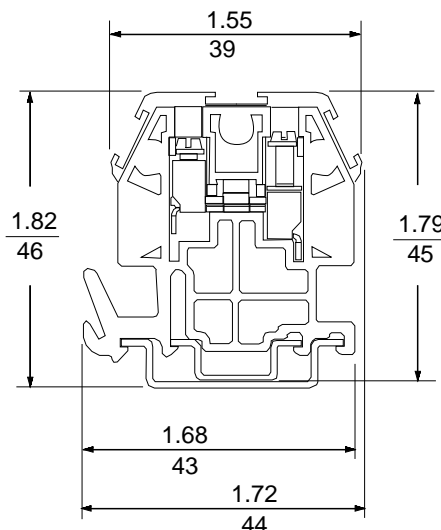

Figure 19 - Type GK6

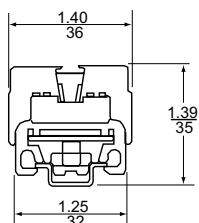

Figure 20 - Type GC6

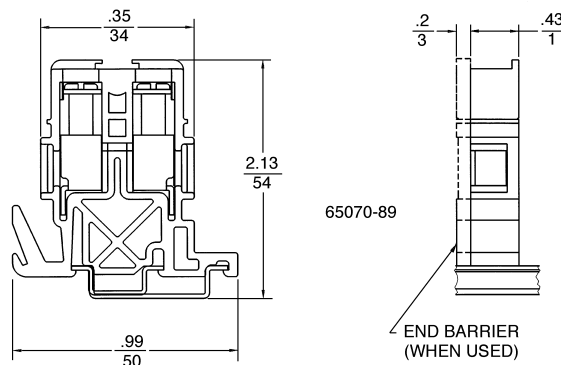

Figure 21 - Type GD6

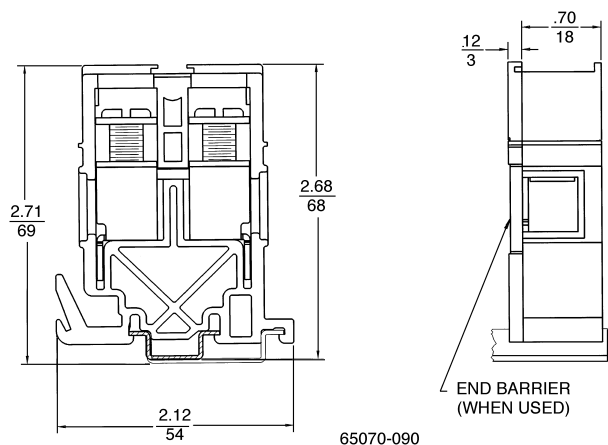

Figure 22 - Type GE6

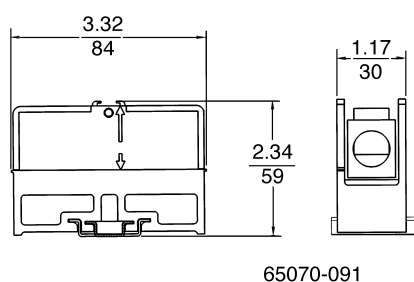

Figure 23 - Type GA6

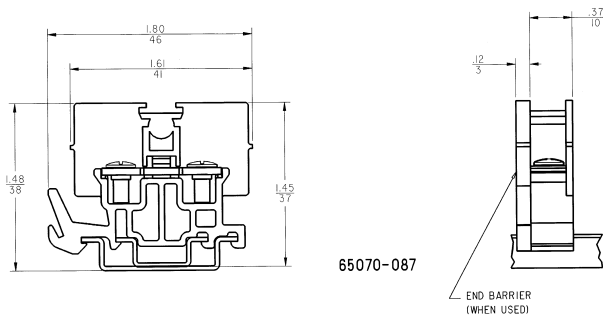

Figure 24 - Type GP6

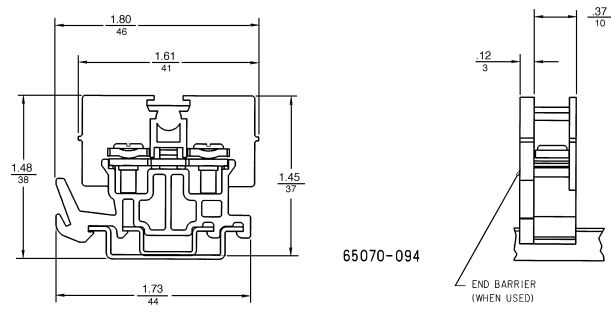

Figure 25 - Type GT6

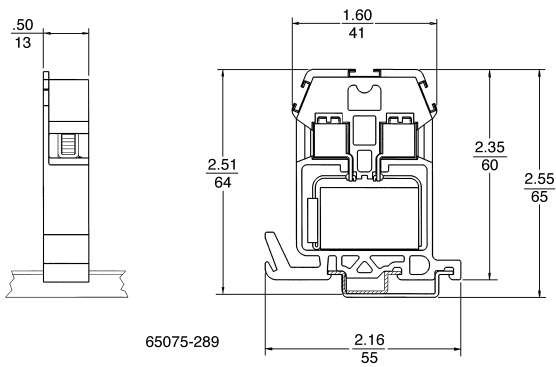

Figure 26 - Type GS6

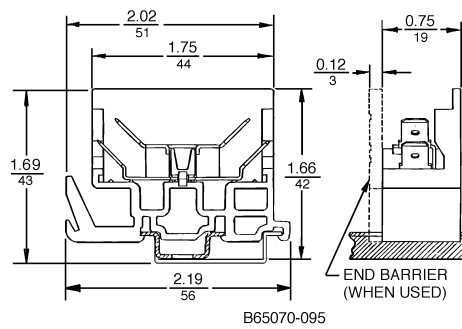

Figure 27 - Type GG6

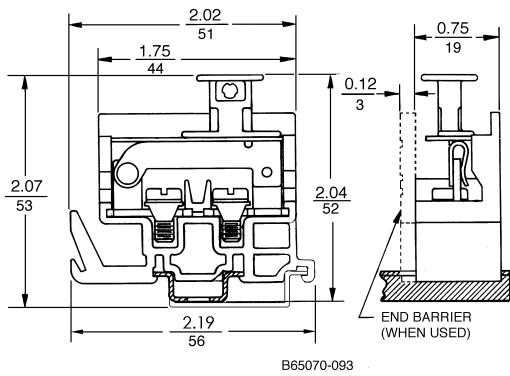

Figure 28 - Type GF6 with Fuse Puller

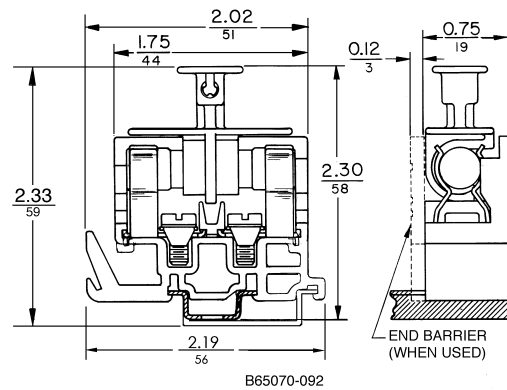
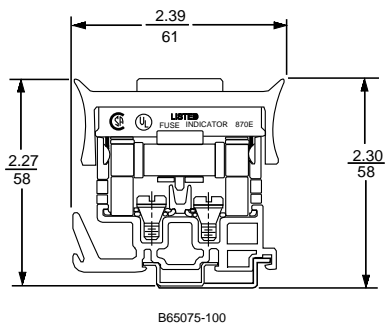

Figure 29 - Type GF6 with Blown Fuse Indicator



Circuit Protectors and Assemblies Approximate Dimensions

Figure 30 - Type GCB

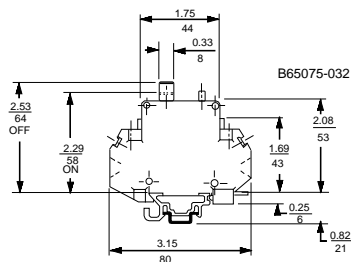

Figure 31 - Type G Assemblies

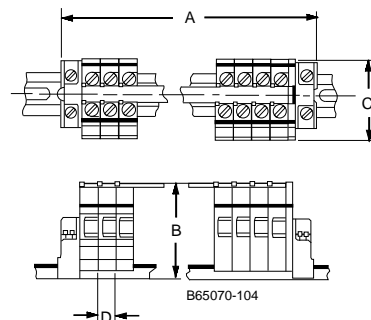

Table 17 - Circuit Protectors and Assemblies Approximate Dimensions

CLASS 9080 TYPE	Dimension A ¹¹ in. (mm)	Dimension B ¹² in. (mm)	Dimension C in. (mm)	Dimension D in. (mm)	Blocks per foot
GA6	0.37 N + 0.93 (9.4 N + 23.6)	1.48 (37.6)	1.80 (45.7)	0.37 (9.4)	32
GC6	0.43 N + 0.93 (10.9 N + 23.6)	2.13 (54.1)	1.99 (50.5)	0.43 (10.9)	28
GD6	0.70 N + 0.93 (17.8 N + 23.6)	2.71 (68.8)	2.12 (53.8)	0.70 (17.8)	17
GE6	1.17 N + 0.93 (29.7 N + 23.6)	2.34 (59.4)	3.32 (84.3)	1.17 (29.7)	10
GF6 (with extractor)	0.75 N + 0.93 (19.1 N + 23.6)	2.33 (59.2)	2.19 (55.6)	0.75 (19.1)	16
GF6 (with blown fuse indicator)	0.75 N + 0.80 (19.1 N + 23.6)	2.39 (60.7)	2.30 (58.4)	0.75 (19.1)	16
GG6	0.75 N + 0.93 (19.1 N + 23.6)	2.07 (52.6)	2.19 (55.6)	0.75 (19.1)	16
GK6	0.35 N + 0.93 (8.9 N + 23.6)	1.39 (35.3)	1.40 (35.6)	0.35 (8.9)	34
GM6	0.24 N + 0.93 (6.0 N + 23.6)	1.82 (46.2)	1.72 (43.7)	0.24 (6.0)	51
GP6	0.37 N + 0.93 (9.5 N + 23.6)	1.48 (37.6)	1.80 (45.7)	0.37 (9.5)	32
GR6	0.35 N + 0.93 (8.9 N + 23.6)	1.82 (46.2)	1.72 (43.7)	0.35 (8.9)	34
GS6	0.75 N + 0.93 (19.1 N + 23.6)	1.69 (42.9)	2.19 (55.6)	0.75 (19.1)	16
GT6	0.50 N + 0.93 (12.7 N + 23.6)	2.55 (64.8)	2.16 (54.9)	0.50 (12.7)	24
GCB	0.50 N + 0.93 (12.7 N + 23.6)	3.38 (85.9)	3.15 (80.0)	0.50 (12.7)	24

11. Where N is the total number of blocks in the assembly. If slip-in end clamps (9080GH11) are used, subtract 0.8 inches (20.3 mm). Slip-in clamps cannot be used with 9080GK6, GE6 blocks.
 12. Dimension shown assumes use of DIN 3 track, except for the 9080 GK6 block.

Mounting Track and End Clamps Approximate Dimensions and Diagrams

Figure 32 - 9080MH2••

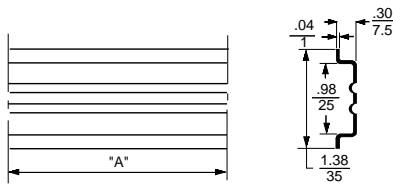
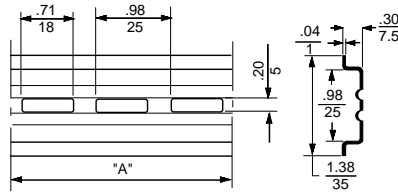

Figure 33 - 9080MH3••



- If the last two digits of the catalog number is 20, then “A” is equal to 19.7 in. (500.38 mm)
- If the last two digits of the catalog number is 39, then “A” is equal to 39.4 in. (1000.76 mm)
- If the last two digits of the catalog number is 79, then “A” is equal to 78.7 in. (1998.98 mm)

Figure 34 - 9080GH1••

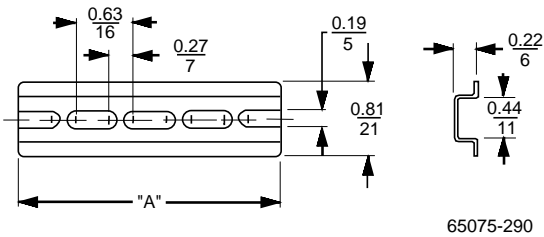
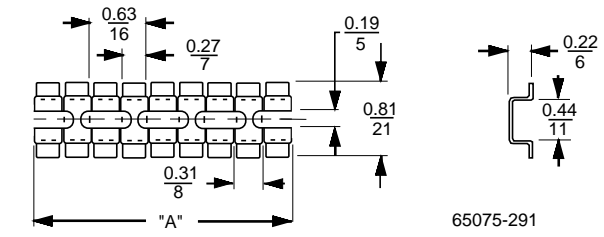

Figure 35 - 9080GH2••



“A” is the last two digits of the catalog number in inches. For example, for 9080GH148, “A” is equal to 48 inches.

Figure 36 - 9080MHA10

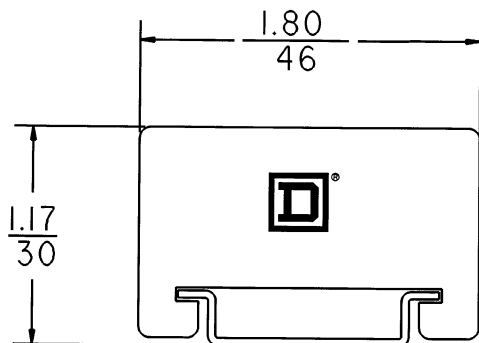
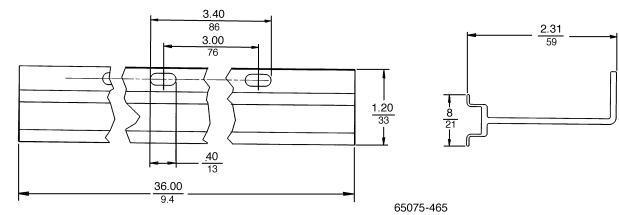

Figure 37 - 9080GH336



Schneider Electric
800 Federal Street
Andover, MA 01810
USA

888-778-2733

www.se.com

As standards, specifications, and design change from time to time,
please ask for confirmation of the information given in this publication.

© 1993 – 2021 Schneider Electric. All rights reserved.

9080CT9601R08/21