

Section 3

Safety Switches



Light Duty



General Duty



Heavy Duty



Stainless Steel Heavy Duty

Light Duty Safety Switches	3-2
Light Duty—Visible Blades 10 kA Short Circuit Current Rating	3-2
General Duty Safety Switches	3-2
General Duty—Up to 100 kA Short Circuit Current Rating	3-2
240 Volt—Single Throw Fusible Switches	3-2
240 Volt—Single Throw Non-Fusible Switches	3-3
UL Listed Maximum Short Circuit Current Ratings — AC Only	3-3
Accessories and Lug Data	3-4
Field-Installed Fuse Puller Kits	3-4
Field-Installed Electrical Interlock Kits	3-4
Equipment Grounding Kits	3-4
Field-Installed Lug Kit 400 A – 600 A	3-4
Terminal Lug Data	3-4
Dimensions for General Duty Safety Switches	3-5
Heavy Duty Safety Switches	3-6
240 Volt—Single Throw Fusible Switches	3-6
600 Volt—Single Throw Fusible Switches	3-7
600 Volt—Single Throw Non-Fusible Switches	3-8
UL Listed Maximum Short Circuit Current Ratings—AC only	3-9
Special Applications	3-10
Receptacle Switches	3-12
Accessories and Special Features	3-13
Dimensions for Heavy Duty Safety Switches	3-19
NEMA Type 1 and 3R	3-19
NEMA Type 4, 4X, 5, 7, 9, and 12	3-20
Double Throw Safety Switches	3-22
Fusible and Non-Fusible Overview	3-22
240 Volt — Double Throw Safety Switches	3-23
600 Volt — Double Throw Safety Switches	3-24
Accessories and Lug Data	3-25
Application Data	3-27
Terminal Lug Data	3-28
Dimensions for Double Throw Safety Switches	3-29
Series F Devices 30–100 A	3-29
Series A, E, and T4 Devices	3-30
Photovoltaic Disconnect Switches	3-31
1000 Vdc Photovoltaic Heavy Duty Disconnect Switch	3-31

SAFETY SWITCHES

3

Light Duty—Visible Blades 10 kA Short Circuit Current Rating

The Square D light duty enclosed switch is ideal for home applications in disconnecting power to workshops, hobby rooms, furnaces, and garages. The light duty safety switch has visible blades and a ground lug as standard features.



L221N

Table 3.1: Fusible

System	Amperes	Fuse	NEMA 1 Indoor Cat. No.	Horsepower Ratings			
				120 Vac		240 Vac	
				Std.	Max.	Std.	Max.
2 Wire (1 Blades and Fuseholders, 1 Neutral)—120 Vac							
	30	Plug	L111N	—	—	—	—
3 Wire (2 Blades and Fuseholders, 1 Neutral)—120/240 Vac							
	30	Plug Cart	L211N L221N	1/2 1/2	2 2	1-1/2 1-1/2	3 3

General Duty—Up To 100 kA Short Circuit Current Rating

General duty safety switches are designed for residential and commercial applications where durability and economy are prime considerations. Typical loads are lighting, air conditioning, and appliances. They are suitable for use as service equipment when equipped with a factory or field-installed neutral assembly or a field-installed service grounding kit, (see page 3-4) as applicable.

General duty safety switches are UL Listed, File E2875, and meet or exceed the NEMA Standard KS1.

240 Volt—Single Throw Fusible Switches

Table 3.2: Fusible

System	Amperes	Fuse	NEMA 1 Indoor Cat. No.	NEMA 3R [1] Rainproof Cat. No.	Class R Fuse Kits [2] Cat. No.	Horsepower Ratings				
						Std. (Fast Acting One-Time Fuses)		Max. (Dual Element Time-Delay Fuses)		
						1Ø	3Ø	1Ø	3Ø	
2 Wire (1 Blade and Fuseholder, 1 Neutral)—120 Vac										
	30	Plug	Use Light Duty Device for this Application (see above)			—	—	—	—	—
	30	Cart.	Use three-wire devices for this application.			—	—	—	—	—
3 Wire (2 Blades and Fuseholders, 1 Neutral)—120/240 Vac (Plug), 240 Vac (Cart.) Maximum										
	30	Plug	D211N	D211NRB	—	1-1/2	—	3	—	—
	30	Cart.	D221N	D221NRB	DRK30	1-1/2	3[3]	3	7-1/2[3]	—
	60	Cart.	D222N	D222NRB	RFK03H	3	7-1/2[3]	10	15[3]	—
	100	Cart.	D223N	D223NRB	RFK10	7-1/2	15[3]	15	30[3]	—
	200	Cart.	D224N [4]	D224NRB [4]	HRK1020	15	25[3]	—	60[3]	—
	400	Cart.	D225N	D225NR	DRK40	—	—	—	—	—
	600 [5]	Cart.	D226N	D226NR	DRK600	—	—	—	—	—
4 Wire (3 Blades and Fuseholders, 1 Neutral)—240 Vac Maximum										
	30	Cart.	D321N	D321NRB	DRK30	1-1/2	3	3	7-1/2	—
	60	Cart.	D322N	D322NRB	RFK03H	3	7-1/2[6]	10	15[6]	—
	100	Cart.	D323N	D323NRB	RFK10	7-1/2	15[6]	15	30[6]	—
	200	Cart.	D324N [4]	D324NRB [4]	HRK1020	15	25[6]	—	60[6]	—
	400	Cart.	D325N	D325NR	DRK40	—	50	—	125	—
	400 [7]	Class T	D325NT	D325NTR	—	—	50	—	—	—
	600 [5]	Cart.	D326N	D326NR	DRK600	—	75	—	150	—
	600 [7]	Class T	D326NT	D326NTR	—	—	75	—	—	—
	800 [7]	Class T	T327N	T327NR	—	—	100	—	—	—





D223N

3 SAFETY SWITCHES

[1] Bolt-on hubs —Refer to Rainproof Bolt-On Hubs, Table 1.27, page 3-13.
 [2] When properly installed, the Class R Fuse Kit rejects all but Class R fuses.
 [3] For corner grounded delta systems only. Use switching poles for ungrounded conductors. See data bulletin 2700DB0202 for additional information.
 [4] For 200% neutral, order (1) additional neutral kit SN20A and (1) neutral jumper kit SN20NI.
 [5] Order Class J Fuse Kit GDJK600 if using Class J fuses.
 [6] If corner grounded delta, use outer switching poles for ungrounded conductors.
 [7] D325NT, D325NTR, D326NT, D326NTR, T327N and T327NR accept only 300Vac Class T fuses.

240 Volt—Single Throw Non-Fusible Switches

Table 3.3: Non-Fusible

System	Amperes	NEMA 1 Indoor	NEMA 3R Rainproof [8]	Horsepower Ratings (Max.)	
		Cat. No.	Cat. No.	1Ø	3Ø
2 Wire (2 Blades)—240 Vac Maximum					
	30	—	DU221RB	3	—
	60	—	DU222RB	10	—
	60	QO260NATS [9] [10]	QO200TR [9] [10] [11]	10	—
	100	QO200NS [9] [10]	QO200NTR [9] [11]	20	—
	200	Use 3P Switch	Use 3P Switch	—	—
	400	Use 3P Switch	Use 3P Switch	—	—
3 Wire (3 Blades)—240 Vac Maximum					
	30	DU321	DU321RB	3	7-1/2
	60	DU322	DU322RB	10	15
	100	DU323 [12]	DU323RB [12]	15	40
	200	DU324 [13]	DU324RB [13]	15	60
	400	DU325	—	—	125
	600	DU326 [14]	—	—	150

UL Listed Maximum Short Circuit Current Ratings — AC Only

Table 3.4: Fusible Safety Switch Short Circuit Current Rating

Fuse Class	UL Listed Short Circuit Rating
Plug	10 kA
H, K	10 kA
J [15], R	100 kA
T [16]	100 kA

Non-Fusible Safety Switches

Systems equal or less than 10 kAIR SCCR—Any brand of circuit breaker or fuse not exceeding the ampere rating of the switch may be used in conjunction with a non-fusible safety switch.

Systems above 10 kAIR SCCR—The UL Listed short circuit current rating for Square D non-fusible switches is based upon the switch being used in conjunction with fuses or Square D circuit breakers or Mag-Gard motor circuit protectors.

Table 3.5: Non-Fusible Safety Switch Short Circuit Current Rating

Fuse Class or Circuit Breaker Type [17]	UL Listed Short Circuit Rating
Any Brand Circuit Breaker	10 kA
H or J PowerPact Circuit Breaker	Up to 65 kA [18]
H, K	10 kA
J, R	100 kA [19]
T	100 kA [20]

[8] Bolt-on hubs—Refer to Hubs, page 3-13.
 [9] Enclosed molded case switch—Refer to Section 1.
 [10] Includes factory-installed grounding kit.
 [11] Not service entrance rated—Refer to Table 3.34 for more information.
 [12] If a neutral assembly is required, order and field install SN0610.
 [13] If a neutral assembly is required, order and field install a SN20A Neutral Assembly Kit. For a 200% neutral application, order and field install (2) SN20A Neutral Assembly Kits and (1) SN20NI Neutral Jumper Kit.
 [14] If a neutral assembly is required, order and field install D600SN.
 [15] Only applicable to 200 A - 600 A except D325NT, D325NTR, D326NT and D326NTR.
 [16] Only applicable to D325NT, D325NTR, D326NT, D326NTR, T327N and T327NR.
 [17] Ampere rating of fuse or circuit breaker not to exceed switch ampere rating.
 [18] Only applicable to DU324 and DU324RB. HD, JD = 25 kA maximum.
 [19] SCCR = 50 kA, applicable to DU222RB, DU322 and DU322RB.
 [20] Only applicable to DU323, DU323RB, DU325 and DU326.



Fuse Puller Kit
Series F Fusible Switches Only

Field-Installed Fuse Puller Kits

Kit consists of three fuse pullers as required for a 3P, fusible, 60 or 100 A general duty switch. Kits can be installed only in 60 or 100 A Series F fusible switches.

Table 3.6: Fuse Puller Kits

Switch Ampere Rating	Series No.	Cat. No.
60	F	FPK03
100	F	FPK0610

Field-Installed Electrical Interlock Kits

Electrical interlocks for Series F 100–200 A general duty safety switches & Series F 60 A fusible general duty safety switches are available in kit form for field installation. Each kit contains instructions for proper field mounting. A pivot arm operates from switch mechanism, breaking the control circuit before the main switch blades break. Switches with electrical interlocks installed are UL Listed.

Table 3.7: Electrical Interlock Kit

Switch Amperes Rating	Electrical Interlock Kit Cat. No. [21]
Fusible Series F 60	EIK031 or EIK032
Series F 100–200	EIK1 or EIK2

Table 3.8: Electrical Interlock Contact Ratings [22]

Interlock Type	AC 50 or 60Hz				DC		
	Volts	Make	Break	Cont.	Volts	Make / Break	Cont.
1 N. O. / 1 N. C. Contact (-1 Suffix [23])	120	40.00 A	15.00 A	15.00 A	115	0.50 A	15.00 A
	240	20.00 A	10.00 A	15.00 A	230	0.25 A	15.00 A
2 N. O. / 2 N. C. Contacts (-2 Suffix [24])	120	30.00 A	3.00 A	10.00 A	115	1.00 A	10.00 A
	240	15.00 A	1.5 A	10.00 A	230	0.30 A	10.00 A

Equipment Grounding Kits

Table 3.9: Equipment Grounding Kits

Switch Ampere Rating	Cat. No.	Lug Wire Range (AWG)
30 [25]	Std.	(1) 14 – 10 Cu or (1) 12 – 8 Al
30	PK3GTA1	(3) 14 – 4 Cu or (3) 12 – 4 Al or (6) 14 – 12 Cu or (6) 12 – 10 Al
60 [26]	GTK03	(2) 14 – 4 Cu or (2) 12 – 4 Al (4) 14 – 12 Cu or (4) 12 – 10 Al
100	GTK0610	(2) 14 – 1/0 Cu or (2) 12 – 1/0 Al (2) 14 – 6 Cu or (2) 12 – 6 Al
200	PKOGTA2	(2) 10 – 2/0 Cu or (2) 6 – 2/0 Cu Al
400, 600	PKOGTA2 [27]	(2) 10 – 2/0 Cu or (2) 6 – 2/0 Cu Al
800	PKOGTA3	(6) 6 – 3/0 Al/Cu Max.

Field-Installed Lug Kit 400 A – 600 A

Table 3.10: Field-Installed Lug Kit 400 A – 600 A

Switch Ampere Rating	Lug Kit Cat. No.	Wire Range/NEC	Lug Wire Range
400 or 600 Series [28]	GD4060LK	1-1/0-600 kcmil 2-1/0-500 kcmil 4-1/0-250 kcmil	2-1/0-600 kcmil 4-1/0-250 kcmil

Terminal Lug Data

Table 3.11: Terminal Lug Data [29]

Amperes	Conductors Per Phase	Wire Range Wire Bending Space Per NEC Table 312.6 AWG/kcmil	Lug Wire Range AWG/kcmil
30 [30]	1	12–8 (Al) or 14–8 (Cu)	12–8 (Al) or 14–8 (Cu)
30	1	12–6 (Al) or 14–6 (Cu)	12–6 (Al) or 14–6 (Cu)
60	1	12–3 (Al) or 14–3 (Cu)	12–2 (Al) or 14–2 (Cu)
100	1	12–1 (Al) or 14–1 (Cu)	12–1/0 (Al) or 14–1/0 (Cu)
200	1	6 – 250 (Al/Cu)	6 – 300 (Al/Cu)
400 Type 1	1 or 2	1/0 – 600 (Al/Cu) or 1/0 – 300 (Al/Cu)	(1) 1/0 – 750 (Al/Cu) or (2) 1/0 – 300 (Al/Cu)
400 Type 3R	2	1/0 – 250 (Al/Cu)	(1) 1 – 600 (Al/Cu) or (2) 1/0 – 250 (Al/Cu)
600	2	4 – 500 (Al/Cu)	4 – 600 (Al/Cu)
800	3	3/0 – 500 (Al/Cu)	3/0 – 500 (Al/Cu)

[21] Electrical interlock kit catalog numbers with -1 suffix indicate one normally open and one normally closed contact; -2 indicates two normally open and two normally closed contacts. Kits are UL Listed.

[22] Single-pole single-throw interlock kits are rated 1/2 hp at 110 and 220 Vac.

[23] -1 Suffix uses a 9007A01 limit switch.

[24] -2 Suffix uses a 9007C03 limit switch.

[25] Light duty safety switches.

[26] 60 A non-fusible switches accept PK3GTA1.

[27] Two required if ground conductors are run in parallel.

[28] Not suitable for use on 400 A Type 3R.

[29] 30–100 A switches suitable for 60°C or 75°C conductors. 200–800 A switches suitable for 75°C conductors.

[30] Light duty switches only.

Dimensions for General Duty Safety Switches

Table 3.12: Approximate Dimensions

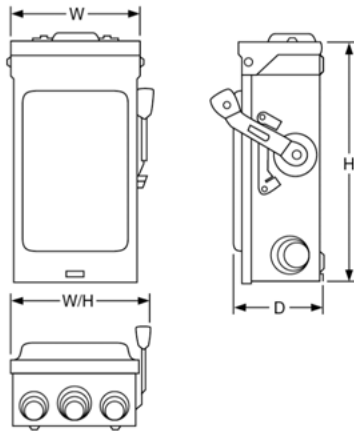

Cat. No.	Series	H		W		W/H		D		Std. Pack
		in.	mm	in.	mm	in.	mm	in.	mm	
L111N	E2	7.63	194	5.00	127	6.13	156	4.00	102	1
L211N	E2	7.63	194	5.00	127	6.13	156	4.00	102	1
L221N	E2	7.63	194	5.00	127	6.13	156	4.00	102	1
D211N	E3	9.25	235	6.75	171	7.25	184	3.63	92	5
D211NRB	E2	9.63	245	7.25	184	7.75	197	3.75	95	5
D221N	E3	9.25	235	6.75	171	7.25	184	3.63	92	5
D221NRB	E3	9.63	245	7.25	184	7.75	197	3.75	95	5
D222N	F1	14.63	372	6.50	165	7.45	189	4.88	124	1
D222NRB	F1	14.88	378	6.63	168	7.45	189	4.88	124	1
D223N	F3	17.50	445	8.50	216	10.50	267	6.50	165	1
D223NRB	F3	17.50	445	8.50	216	10.50	267	6.50	165	1
D224N	F1	29.00	737	17.25	438	19.00	483	8.25	210	1
D224NRB	F1	29.25	743	17.25	438	19.00	483	8.25	210	1
D225N	E3	45.12	1146	24.00	610	24.88	632	8.88	226	1
D225NR	E1	30.63	778	21.38	543	22.25	565	10.13	257	1
D226N	E3	49.13	1248	24.00	610	24.88	632	8.88	226	1
D226NR	E1	49.13	1248	24.75	629	25.13	638	8.88	226	1
D321N	E3	9.25	235	6.75	171	7.25	184	3.63	92	5
D321NRB	E3	9.63	245	7.25	184	7.75	197	3.75	95	5
D322N	F1	14.63	372	6.50	165	7.45	189	4.88	124	1
D322NRB	F1	14.88	378	6.63	168	7.45	189	4.88	124	1
D323N	F3	17.50	445	8.50	216	10.50	267	6.50	165	1
D323NRB	F3	17.50	445	8.50	216	10.50	267	6.50	165	1
D324N	F1	29.00	737	17.25	438	19.00	483	8.25	210	1
D324NRB	F1	29.25	743	17.25	438	19.00	483	8.25	210	1
D325N	E3	45.12	1146	24.00	610	24.88	632	8.88	226	1
D325NT	E3	45.12	1146	24.00	610	24.88	632	8.88	226	1
D325NR	E1	30.63	778	21.38	543	22.25	565	10.13	257	1
D325NTR	E1	30.63	778	21.38	543	22.25	565	10.13	257	1
D326N	E3	49.13	1248	24.00	610	24.88	632	8.88	226	1
D326NT	E3	49.13	1248	24.00	610	24.88	632	8.88	226	1
D326NR	E1	49.13	1248	24.75	629	25.13	638	8.88	226	1
D326NTR	E1	49.13	1246	24.75	629	25.13	638	8.88	226	1
DU221RB	E2	9.63	245	7.25	184	7.75	197	3.75	95	5
DU222RB	E1	9.63	245	7.25	184	7.75	197	3.75	95	5
DU321	E2	9.25	235	6.75	171	7.25	184	3.63	92	5
DU321RB	E2	9.63	245	7.25	184	7.75	197	3.75	95	5
DU322	E1	9.25	235	6.75	171	7.25	184	3.63	92	5
DU322RB	E1	9.63	245	7.25	184	7.75	197	3.75	95	5
DU323	F3	17.50	445	8.50	216	10.50	267	6.50	165	1
DU323RB	F3	17.50	445	8.50	216	10.50	267	6.50	165	1
DU324	F1	29.00	737	17.25	438	19.00	483	8.25	210	1
DU324RB	F1	29.25	743	17.25	438	19.00	483	8.25	210	1
DU325	E3	45.12	1146	24.00	610	24.88	632	8.88	226	1
DU326	E3	49.13	1248	24.00	610	24.88	632	8.88	226	1
QO200TR	G3	6.50	165	4.63	118	—	—	3.88	99	5
QO260NATS	E2	9.25	235	4.88	124	—	—	3.25	83	1
QO2000NRB	E1	14.00	356	7.75	197	—	—	4.50	114	1
QO2000NS	E1	13.38	340	6.13	156	—	—	3.50	89	1
T327N	E1	49.13	1248	24.00	610	24.88	632	8.88	226	1
T327NR	E1	49.13	1248	24.75	629	25.13	638	8.88	226	1

Heavy Duty Safety Switches

Visible blade heavy duty safety switches are designed for application where maximum performance and continuity of service are required. All heavy duty safety switches feature quick-make, quick-break operating mechanism, a dual cover interlock and a color coded indicator handle. They are suitable for use as service equipment when equipped with a field- or factory-installed neutral assembly or equipment grounding kit, unless a 600Y/347 V or 480 Y/277 V, 1000 A or greater, solidly grounded WYE system is used, per NEC 230-95. Heavy duty safety switches are UL Listed (except as noted). Files E2875 and E154828 meet or exceed the NEMA Standard KS1. For UL Listed short circuit current ratings, see [UL Listed Maximum Short Circuit Current Ratings-AC only](#), page 3-9.



Table 3.13: 240 Volt—Single Throw Fusible





System	Amperes	NEMA 1 Indoor	NEMA 3R Rainproof (Bolt-on Hubs [1])	NEMA 4, 4X, 5, [2] 304 Stainless Steel [3] Dust tight, Watertight, Corrosion Resistant (Watertight Hubs [1])	NEMA 12K With Knockouts (Watertight Hubs [1])	NEMA 3R, 5 or 12 [4] Without Knockouts (Watertight Hubs [1])	Horsepower Ratings					
							240 Vac		250 Vdc [5]			
							Std. (Using Fast Acting, One Time Fuses)	Max. (Using Dual Element, Time Delay Fuses)				
							1Ø	3Ø	1Ø	3Ø		
2-Wire (2 Blades and Fuseholders)—240 Vac, 250 Vdc												
	30	Use three-wire devices For two-wire applications		H221DS	H221A	H221AWK	1-1/2	3 [6]	3	7-1/2 [6]	5	
	30					H2212AWK [7]	1-1/2		3		5	
	60			H222DS		H222AWK	3	7-1/2 [6]	10	15 [6]	10	
	100			H223DS	H223A	H223AWK	7-1/2	15 [6]	15	30 [8]	20	
	200			H224DS	H224A	H224AWK	15	25 [6]		60 [6]	40	
	400		H225	H225R	H225DS		H225AWK					50
	600		H226	H226R	H226DS		H226AWK		75 [6]		200 [6]	50
800	H227	H227R			H227AWK	50				50		
1200	H228	H228R			H228AWK	50				50		
3-Wire (2 Blades and Fuseholders, 1 Neutral)—240 Vac, 250 Vdc												
	30	H221N	H221NRB	Use two-wire devices, See Field-Installed Neutral Assemblies, page 3-15			1-1/2	3 [6]	3	7-1/2 [8]	5	
	60	H222N	H222NRB				3	7-1/2 [6]	10	15 [6]	10	
	100	H223N	H223NRB				7-1/2	15 [6]	15	30 [6]	20	
	200	H224N	H224NRB				15	25 [6]		60 [6]	40	
	400	H225N	H225NR	H225NDS		H225NAWK		50 [6]		125 [6]	50	
	600	H226N	H226NR	H226NDS		H226NAWK		75 [6]		200 [6]	50	
	800	H227N	H227NR [9]			H227NAWK	50				50	
1200	H228N	H228NR [9]			H228NAWK	50				50		
3-Wire (3 Blades and Fuseholders)—240 Vac, 250 Vdc												
	30	Use four-wire devices For three-wire applications		H321DS	H321A	H321AWK	1-1/2	3	3	7-1/2	5	
	60			H322DS	H322A	H322AWK	3	7-1/2	10	15	10	
	100			H323DS	H323A	H323AWK	7-1/2	15	15	30	20	
	200			H324DS	H324A	H324AWK	15	25		60	40	
	400		H325	H325R	H325DS		H325AWK		50		125	50
	600		H326	H326R	H326DS		H326AWK		75		200	50
	800		H327	H327R [9]			H327AWK	50	100		250	50
1200	H328	H328R [9]			H328AWK	50	100		250	50		
4-Wire (3 Blades and Fuseholders, 1 Neutral)—240 Vac, 250 Vdc												
	30	H321N	H321NRB	Use three-wire devices, See Field-Installed Neutral Assemblies, page 3-15			1-1/2	3	3	7-1/2	5	
	60	H322N	H322NRB				3	7-1/2	10	15	10	
	100	H323N	H323NRB				7-1/2	15	15	30	20	
	200	H324N	H324NRB				15	25		60	40	
	400	H325N	H325NR	H325NDS		H325NAWK		50		125	50	
	600	H326N	H326NR	H326NDS		H326NAWK		75		200	50	
	800	H327N	H327NR [9]			H327NAWK	50	100		250	50	
1200	H328N	H328NR [9]			H328NAWK	50	100		250	50		
4-Wire (4 Blades and Fuseholders)												
	30	Use 600 Vac devices. See 600 Volt—Single Throw Fusible Switches, page 3-7.										
	60											
	100											
	200											
	400											
600												

Accessories: see page 3-13
 Dimensions: NEMA 1 and 3R, see page 3-19
 Dimensions: NEMA 4, 4X and 5 Stainless and NEMA 12, see page 3-20

[1] For Rainproof Bolt-On Hubs and Watertight Hubs see [Hubs](#), page 3-13.
 [2] Complete rating is NEMA 3, 3R, 4, 4X, 5 and 12. For NEMA 3R applications, remove drain screw from bottom endwall.
 [3] See 316 Grade Stainless Steel—NEMA 3, 3R, 4, 4X, 5, 12, page 3-10.
 [4] Also suitable for NEMA 3R application by removing drain screw from bottom endwall.
 [5] For switching dc, use two outside switching poles.
 [6] For corner grounded delta systems, use switching poles for ungrounded conductors. See data bulletin 2700DB0202 for additional information.
 [7] 60 ampere switch with 30 ampere fuse spacing and clips. Must use 60 A enclosure accessories including electrical interlocks.
 [8] For corner grounded delta systems, use switching poles for ungrounded conductors.
 [9] Suitable for NEMA 5 applications with drain screw installed.

600 Volt—Single Throw Fusible

Table 3.14: 600 Volt—Single Throw Fusible

System	Amperes	NEMA 1 Indoor	NEMA 3R Rainproof (Bolt-on Hubs [10])	NEMA 4, 4X, 5 [11] 304 Stainless Steel (316 stainless [12]) Dust tight, Watertight, Corrosion Resistant (Watertight Hubs [10])	NEMA 12K With Knockouts (Watertight Hubs [10])	NEMA 3R, 5 or 12 [13] Without Knockouts (Watertight Hubs [10])	Horsepower Ratings					dc [14]	
							480 Vac		600 Vac				
							Std. (Using Fast Acting, One Time Fuses)	Max. (Using Dual Element, Time Delay Fuses)	Std. (Using Fast Acting, One Time Fuses)	Max. (Using Dual Element, Time Delay Fuses)	Max. (Using Dual Element, Time Delay Fuses)	250	600
Cat. No.							3Ø	3Ø	3Ø	3Ø	250	600	
2-Wire (2 Blades and Fuseholders)—600 Vac, 600 Vdc													
	30						—	—	—	—	—	—	
	60						—	—	—	—	—	—	
	100						—	—	—	—	—	—	
	200						—	—	—	—	—	—	
	400	H265	H265R	H265DS	—	H265AWK	100 [15]	250 [15]	—	—	—	50	50
	600	H266	H266R	H266DS	—	H266AWK	150 [15]	400 [15]	—	—	—	50	50
800	H267	H267R [16]	—	—	H267AWK	—	—	—	—	—	—	50	
1200	H268	H268R [16]	—	—	H268AWK	—	—	—	—	—	—	50	
3-Wire (3 Blades and Fuseholders)—600 Vac, 600 Vdc													
	30	H361	H361RB	H361DS	H361A	H361AWK	5	15	7-1/2	20	5	15	
	30	H361-2 [16] [17]	H3612RB [17]	—	H361-2A [17]	H3612AWK [17]	5	15	7-1/2	20	—	15	
	60	H362	H362RB	H362DS	H362A	H362AWK	15	30	15	50	—	30	
	100	H363	H363RB	H363DS	H363A	H363AWK	25	60	30	100	—	50	
	200	H364	H364RB	H364DS	H364A	H364AWK	50	125	60	150	40	50	
	400	H365	H365R	H365DS	—	H365AWK	100	250	125	350	50	50	
	600	H366	H366R	H366DS	—	H366AWK	150	400	200	500	50	50	
	800	H367	H367R [16]	—	—	H367AWK	200	500	250	500	—	50	
	1200	H368	H368R [16]	—	—	H368AWK	200	500	250	500	—	50	
4-Wire (3 Blades and Fuseholders, 1 Neutral)—600 Vac, 600 Vdc													
	30	H361N	H361NRB	Use three-wire devices, See Field-Installed Neutral Assemblies, page 3-15			5	15	7-1/2	20	—	15	
	60	H362N	H362NRB				15	30	15	50	—	30	
	100	H363N	H363NRB				25	60	30	75	—	50	
	200	H364N	H364NRB	H364NDS	H364NA	H364NAWK	50	125	60	150	40	50	
	400	H365N	H365NR	H365NDS	—	H365NAWK	100	250	125	350	50	50	
	600	H366N	H366NR	H366NDS	—	H366NAWK	150	400	200	500	50	50	
	800	H367N	H367NR [16]	—	—	H367NAWK	200	500	250	500	—	50	
	1200	H368N	H368NR [16]	—	—	H368NAWK	200	500	250	500	—	50	
	4-Wire (4 Blades and Fuseholders)—600 Vac, 600 Vdc [18]												
	30	H461	—	H461DS	—	H461AWK	7-1/2	20	10	25	5	15	
	60	H462	—	H462DS	—	H462AWK	15	40	20	50	10	30	
	100	H463	—	H463DS	—	H463AWK	25	60	30	75	20	30	
	200	H464	—	H464DS	—	H464AWK	50	125	60	150	40	50	
	400	H465	—	—	—	H465AWK	100	250	125	350	50	50	
	600	H466	—	—	—	—	150	400	200	500	50	50	
6-Wire (6 Blades and Fuseholders)—600 Vac [18]													
	100	—	—	H663DS	—	H663AWK	25	60	30	75	—	—	
	200	—	—	H664DS	—	H664AWK	For applications requiring motor disconnect capability, see Electrical Interlock Kits, page 3-14						

Accessories: see page 3-13
Dimensions: NEMA 1 and 3R, see page 3-19
Dimensions: NEMA 4, 4X and 5 Stainless and NEMA 12, see page 3-20

Class H, R, J, and L Fuse Provisions:

Class H or K Fuse Provisions: Fusible Square D 30–600 A heavy duty safety switches accept Class H or K fuses as standard. With Class H or K fuses installed, the switch is UL Listed for use on systems with up to 10 kA available fault current.

Class R Fuse Provisions: Fusible Square D 30–600 A heavy duty safety switches will accept Class R fuses as standard. A field-installed rejection kit is available which, when installed, rejects all but Class R fuses. With the installation of the rejection kit and Class R fuses, the switch is UL Listed for use on systems with up to 200 kA available fault current. See **Class R Fuse Kits, page 3-14.**

Class J Fuse Provisions: Provisions for installing Class J fuses are included in 30–400 A 600 Volt, and 100–400 A 240 Volt, fusible heavy duty safety switches. Conversion to Class J fuse spacing requires relocating the load side fuse base assembly from the standard Class H fuse location to an alternate position as marked in the enclosure. With Class J fuses installed, the switch is UL Listed for use on systems with up to 200 kA available fault current. Switches rated 600 A, 240 or 600 Volt, require the addition of an adapter kit, H600J. One kit per 3P switch.

Class L Fuse Provisions: Fusible 800 A and 1200 A safety switches use Class L bolt-in fuses and are rated for use on systems with up to 200 kA at 600 Vac maximum. 1200 A switches accept class L fuses from 601–1200 A, 800 A switches accept class L fuses from 601–800 A.

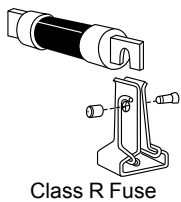





Class R Fuse

[10] For Rainproof Bolt-On Hubs and Watertight Hubs see **Hubs, page 3-13.**
[11] Complete rating is NEMA 3, 3R, 4, 4X, 5 and 12..
[12] See Table 3.18 316 Grade Stainless Steel 3 Pole 600 Vac, 600 Vdc, page 3-10.
[13] Also suitable for NEMA 3R application by removing drain screw from bottom endwall.
[14] For switching dc, use two outside switching poles.
[15] For corner grounded delta systems, use switching poles for ungrounded conductors. See data bulletin 2700DB0202 for additional information.
[16] Suitable for NEMA 5 applications with drain screw installed.
[17] 60 A switch with 30 A fuse spacing and clips. Must use 60 A enclosure accessories including electrical interlocks.
[18] Not suitable for use as service equipment.

600 Volt—Single Throw Non-Fusible

Table 3.15: 600 Volt—Single Throw Non-Fusible

System	Amperes	NEMA 1 Indoor	NEMA 3R Rainproof [19]	NEMA 4, 4X, 5 [20] 304 Stainless Steel [21] Dust tight, Watertight Corrosion Resistant [19]	NEMA 12K With Knockouts [19]	NEMA 3R, 5 or 12 [22] Without Knockouts [19]	Horsepower Ratings (Max.)							
							Volts ac						dc [23]	
							240		480		600		dc [23]	
						1Ø	3Ø	1Ø	3Ø	1Ø	3Ø	250	600	
2-Wire (2 Blades)—600 Vac, 600 Vdc														
	30						—	—	—	—	—	—	—	
	60						—	—	—	—	—	—	—	
	100						—	—	—	—	—	—	—	
	200						—	—	—	—	—	—	—	
	400	HU265	HU265R	HU265DS	—	HU265AWK	—	125	—	250	—	—	50	50
	600	HU266	HU266R	HU266DS	—	HU266AWK	—	200	—	400	—	—	50	50
	800	HU267	HU267R [24]	—	—	HU267AWK	—	—	—	—	50	—	—	50
1200	HU268	HU268R [24]	—	—	HU268AWK	—	—	—	—	50	—	—	50	
3-Wire (3 Blades)—600 Vac, 600 Vdc														
	30	HU361	HU361RB	HU361DS	HU361A	HU361AWK	5	10	7-1/2	20	10	30	5	15
	30	HU361E1[25]	HU361RBE1 [25]	HU361DSE1 [25]	HU361AE1 [25]	HU361AWKE1[25]	5	10	7-1/2	20	10	30	5	15
	30	—	HU3612RB [26]	—	HU3612A[26]	HU3612AWK[26]	5	10	7-1/2	20	10	30	5	15
	60	HU362	HU362RB	HU362DS	HU362A	HU362AWK	10	20	25	50	30	60	10	30
	60	—	—	HU362DSE1[25]	—	—	10	20	25	50	30	60	10	30
	100	HU363	HU363RB	HU363DS	HU363A	HU363AWK	20	40	40	75	40	100	20	50
	200	HU364	HU364RB	HU364DS	HU364A	HU364AWK	15	60	50	125	50	150	40	50
	400	HU365	HU365R	HU365DS	—	HU365AWK	—	125	—	250	—	350	50	50
	600	HU366	HU366R	HU366DS	—	HU366AWK	—	200	—	400	—	500	50	50
	800	HU367	HU367R [24]	—	—	HU367AWK	—	—	—	500	500	—	—	50
1200	HU368	HU368R [24]	—	—	HU368AWK	—	—	—	—	500	500	—	50	
4-Wire (4 Blades)—600 Vac, 600 Vdc [27]														
	30	HU461 [28]	—	HU461DS	—	HU461AWK [29]	10	10	20	20	25	30	10[30]	15[30]
	60	HU462 [28]	—	HU462DS	—	HU462AWK	20	20	40	50	50	60	10	30
	100	HU463 [28]	—	HU463DS	—	HU463AWK	30	40	50	75	50	75	20	30
	200	HU464 [28]	—	HU464DS	—	HU464AWK	50	60	50	125	50	150	40	50
	400	HU465	—	—	—	HU465AWK	—	125	—	250	—	350	50	50
	600	HU466	—	—	—	—	—	200	—	400	—	500	50	50
6-Wire (6 Blades)—600 Vac [27]														
	30	—	—	HU661DS	—	HU661AWK	—	10	—	20	—	30	—	—
	60	—	—	HU662DS	—	HU662AWK	—	20	—	50	—	60	—	—
	100	—	—	HU663DS	—	HU663AWK	—	50	—	75	—	75	—	—
	200	—	—	HU664DS	—	HU664AWK	—	60	—	125	—	150	—	—

SAFETY SWITCHES

[19] For Rainproof Bolt-On Hubs and Watertight Hubs see Hubs, page 3-13.
 [20] Complete rating is NEMA 3, 3R, 4, 4X, 5 and 12.
 [21] For 316 stainless, see 316 Grade Stainless Steel—NEMA 3, 3R, 4, 4X, 5, 12, page 3-10.
 [22] Also suitable for NEMA 3R application by removing drain screw from bottom endwall.
 [23] For switching dc, use two outside switching poles.
 [24] Suitable for NEMA 5 applications with drain screw installed.
 [25] Switches with EI suffix are stocked with factory-installed electrical interlocks with one normally-open and one normally-closed contact.
 [26] Use 60 A enclosure accessories, including electrical interlocks.
 [27] Not suitable for use as service equipment.
 [28] No knockouts are provided.
 [29] Requires 60 A accessories. See NEMA Type 4, 4X, 5, 7, 9, and 12, page 3-20 for series rating.
 [30] HU461AWK (Series F6) is rated 5 hp@250 Vdc, 15 hp@600 Vdc.

NOTE: Consult the wiring diagram of the switch to verify the UL Listed short circuit current rating.

UL Listed Maximum Short Circuit Current Ratings—AC only

Table 3.16: Fusible Safety Switches

Heavy Duty Safety Switch Type	UL Listed Fuse Class	UL Listed Short Circuit Current Ratings
Fusible	H, K	10 kA
	R, J, L	200 kA [31]

Non-Fusible Safety Switches

Systems equal or less than 10 kAIR SCCR—Any brand of circuit breaker or fuse not exceeding the ampere rating of the switch may be used in conjunction with a non-fusible safety switch.

Systems above 10 kAIR SCCR—The UL Listed short circuit current rating for Square D non-fusible switches is based upon the switch being used in conjunction with fuses or Square D circuit breakers or Mag-Gard motor circuit protectors.

Table 3.17: Non-Fusible Safety Switches [32] [33]

Heavy Duty Safety Switch Type	Switch Rating (A)	Fuse or Circuit Breaker Type [34]	3-Phase			250 Vdc / 600 Vdc
			240 Vac	480 Vac	600 Vac	
Circuit Breaker						
Non-Fusible Switches	All	Any brand circuit breaker	Up to 10 kA			Up to 10 kA
		H, K				
		R, T, J, L	200 kA	200 kA	200 kA	
Fuse						
All	30–100	H [35]	65 kA	35 kA	35 kA	Up to 10 kA
	30–100	FA	14 kA	14 kA	14 kA	
	30–100	FH	18 kA	18 kA	18 kA	
	200	H, J [36]	65 kA	35 kA	35 kA	
	400	LA	22 kA	22 kA	22 kA	
	400	LH	25 kA	25 kA	25 kA	
	400	L	100 kA	65kA	65kA	
	600	L	100 kA	65kA	65kA	

[31] On 600 V, 200 A switches, 100,000 A max. on corner grounded delta when protected by Class J or R fuses.
 [32] For Type 4X Fiberglass Reinforced Polyester switches, see page 3-10.
 [33] Type 7/9 SCCR 10 kAIR 600 Vac maximum.
 [34] Ampere rating of fuse or circuit breaker not to exceed switch ampere rating.
 [35] All H and J Powerpact™ circuit breakers are acceptable, but will only support the noted Short Circuit Current Rating.
 [36] All L Powerpact™ circuit breakers are acceptable, but will only support the noted Short Circuit Current Rating.

Special Application Heavy Duty Safety Switches
316 Grade Stainless Steel—NEMA 3, 3R, 4, 4X, 5, 12

Type 316 stainless steel enclosure safety switches offer superior corrosion resistance to a wider range of chemicals than Type 304 stainless switches. Type 316 better resists chloride and is often used in marine, waste treatment and transportation applications. Use watertight hubs, see [Hubs](#), page 3-13. Equipment grounding lugs are supplied as standard through 200 A. See [Table 3.42 Terminal Lug Data](#), page 3-18 for wire Termination data for grounding lugs. (For Type 304 stainless switches, see [240 Volt](#), page 3-6 and [600 Volt](#), page 3-7.



H361SS

Table 3.18: 316 Grade Stainless Steel 3 Pole 600 Vac, 600 Vdc

Amperes	Cat. No	Horsepower Ratings—3Ø				
		480 Vac [37]		600 Vac [37]		600 Vdc [38]
		Std.	Max.	Std.	Max.	
Fusible—3P, 600 Vac, 600 Vdc						
30	H361SS	5	15	7-1/2	20	15
60	H362SS	15	30	15	50	30
100	H363SS	25	60	30	75	50
200	H364SS	50	125	60	150	50
400	H365SS	100	250	125	350	50
600	H366SS	150	400	200	500	50
Non-Fusible—3P, 600 Vac, 600 Vdc						
30	HU361SS	—	20	—	30	15
60	HU362SS	—	50	—	60	30
100	HU363SS	—	75	—	100	50
200	HU364SS	—	125	—	150	50
400	HU365SS	—	250	—	350	50
600	HU366SS	—	400	—	500	50

Fiberglass Reinforced Polyester Enclosures—NEMA 4X

Fiberglass reinforced polyester enclosures are watertight, corrosion resistant, and impervious to windblown dust, rain, and splashing liquid. The molded fiberglass is extremely stable in a wide range of operating temperatures and can withstand heavy impact. Switches are furnished with hubs, conduit provisions [Table 3.43](#), and equipment grounding lugs. See CAD drawings of the switch to verify the UL listed short circuit current rating or the enclosed safety switch catalog. UL Listed.



H363DF

Table 3.19: Fiberglass Reinforced Polyester Enclosures NEMA 4X 3 Pole 600 Vac, 600 Vdc

Amperes	Cat. No.	Solid Neutral Assembly Kit	Class R Fuse Kits	Electrical Interlock Kits Field-Installed Cat. No.		Horsepower Ratings—3Ø					Hubs[39]	
				Cat. No.	1 NO/1 NC Contacts	2 NO/2 NC Contacts	480 Vac [37]		600 Vac [37]			600 Vdc [38]
							Std.	Max.	Std.	Max.		
Fusible—3P, 600 Vac, 600 Vdc												
30	H361DF	SN03	RFK06	9999TC10	9999TC20	5	15	7-1/2	20	15	3/4	
60	H362DF	SN03	RFK06H	9999TC10	9999TC20	15	30	15	50	30	1-1/4	
100	H363DF	SN0610	RFK10	9999TC10	9999TC20	25	60	30	75	50	2	
200	H364DF	—	HRK1020	9999R8	9999R9	50	125	60	150	50	2-1/2	
Non-Fusible—3P, 600 Vac, 600 Vdc												
30	HU361DF	SN03	—	9999TC10	9999TC20	—	20	—	30	15	3/4	
60	HU362DF	SN03	—	9999TC10	9999TC20	—	50	—	60	30	1-1/4	
100	HU363DF	SN0610	—	9999TC10	9999TC20	—	75	—	75	50	2	
200	HU364DF	—	—	9999R8	9999R9	—	125	—	150	50	2-1/2	

[37] Std.—Using fast acting, one time fuses. Max.—Using dual element time delay fuses.

[38] For switching dc use two switching poles.

[39] Two hubs and hub drilling template are provided for field installation.



H361DX

Krydon™ Enclosures—NEMA 4X

Krydon enclosures are compression molded of fiberglass reinforced polyester, specially formulated to withstand attack from almost any corrosive atmosphere found in the toughest industrial application. Switches are furnished with watertight hubs and equipment grounding lugs. See CAD drawing of the switch to verify the UL listed short circuit current rating or the enclosed safety switch catalog. UL Listed.

Table 3.20: Krydon™ Enclosures — NEMA 4X 3 Pole 600 Vac, 600 Vdc

Amperes	Cat. No.	Solid Neutral Assembly Kit	Class R Fuse Kits	Electrical Interlock Kits Field-Installed Cat. No.		Horsepower Ratings—3Ø					Hubs [40]
						480 Vac [41]		600 Vac [41]		600 Vdc [42]	
						Std.	Max.	Std.	Max.	Max.	
Fusible—3P, 600 Vac, 600 Vdc											
30	H361DX	H60SN	RFK06	9999TC10	9999TC20	5	15	7-1/2	20	15	3/4
60	H362DX	H60SN	RFK06H	9999TC10	9999TC20	15	30	15	50	30	1-1/4
100	H363DX	SN0610	RFK10	9999TC10	9999TC20	25	60	30	75	50	2
Non-Fusible—3P, 600 Vac, 600 Vdc											
30	HU361DX	H60SN	—	9999TC10	9999TC20	—	20	—	30	15	3/4
60	HU362DX	H60SN	—	9999TC10	9999TC20	—	50	—	60	30	1-1/4
100	HU363DX	SN0610	—	9999TC10	9999TC20	—	75	—	75	50	2



H60XFA

NEMA 7 and 9

An enclosed automatic molded case switch for use in Divisions 1 and 2 of the following: Class I, Groups C and D; Class II, Groups E, F and G; or Class III, Hazardous Locations as defined in NEC™ Article 500. Furnished with threaded conduit openings in both top and bottom endwall. Suitable for use as service equipment and listed as “Raintight” for outdoor applications. cULus Listed. Equipment grounding lugs supplied as standard. See CAD drawing of the switch to verify the UL listed short circuit current rating or the enclosed safety switch catalog.

Table 3.21: NEMA 7/9, 3 Pole Molded Case Switch, 600 Vac, 250 Vdc [43], Short Circuit Current Rating 10 kA AIR

Amperes	Enclosed Molded Case Switch [44]	Solid Neutral Assembly	Horsepower Ratings—3Ø			Size of Threaded Conduit Openings Provided (in.) [45]
	Cat. No.	Cat. No.	240 Vac	480 Vac	600 Vac	
60	H60XFA	100SNA	15	30	50	3/4
60	H60XFA1212 [46]	100SNA	15	30	50	3/4
100	H100XFA	100SNA	30	60	75	1-1/4
100	H100XFA1212 [46]	100SNA	30	60	75	1-1/4
225	H225XJG [47]	225SNA	60	125	150	2-1/2
225	H225XJGAA [47] [46]	225SNA	60	125	150	2-1/2

[40] Two hubs and hub drilling template are provided for field installation.
 [41] Std.—Using fast acting one time fuses. Max.—Using dual element time delay fuses.
 [42] For switching dc, use two outside switching poles.
 [43] For switching dc, use two outside switching poles. Not for use on dc motor applications.
 [44] Includes PKDB1, breather and drain kit, required for rainproof application.
 [45] Threaded conduit opening provided in top and bottom endwall.
 [46] Includes 1NO/1NC auxiliary contacts.
 [47] Not cULus listed due to wire bending space.

Interlocked Receptacle Switches

Interlocked Receptacle Switches [48] are furnished with a factory-installed three-phase four-wire Appleton Powertite™, Crouse-Hinds Style 2 Arktite™, or Hubbellock™ receptacle. The fourth wire is connected to the switch equipment grounding terminal and is not a solid neutral termination. Interlocking linkage between the receptacle and switch mechanism prevents insertion or removal of the plug while the switch is in the “ON” position or insertion of any plug other than specified. Grounding lugs are included. See wiring diagram of the switch to verify the UL listed short circuit current rating or the enclosed safety switch catalog.

Appleton Powertite Receptacle

- UL Listed and CSA Certified
- Available in 30 - 100 A, 600 Vac/250 Vdc, fused or non-fused, Type 1, Type 4/4X/5 stainless steel and Type 12/3R
- Suitable for use as service equipment (USA only)
- Receptacles are epoxy powder coated over copper-free cast aluminum



H362AWA Interlocked Receptacle Switch with Appleton Powertite Receptacle

Table 3.22: Appleton Powertite Receptacle Switches

Amperes	NEMA 1	NEMA 3, 3R, 4, 4X, 5, 12 304 Stainless Steel Enclosure	NEMA 12, 3R	Use with Plug [49]	Horsepower Ratings—3Ø					
					480 Vac [50]		600 Vac [50]		250 Vdc [51]	
					Std.	Ma-x.	Std.	Ma-x.	Std.	Ma-x.
Fusible—3P, 600 Vac, 250 Vdc										
30	H361WA	H361DSWA	H361AWA	ACP3034BC	5	15	7-1/2	20	5	—
60	H362WA	H362DSWA	H362AWA	ACP6034BC	15	30	15	50	10	—
100	H363WA	H363DSWA	H363AWA	ACP1034CD	25	60	30	75	20	—
Non-Fusible—3P, 600 Vac, 250 Vdc										
30	HU361WA	HU361DSWA	HU361AWA	ACP3034BC	—	20	—	30	—	5
60	HU362WA	HU362DSWA	HU362AWA	ACP6034BC	—	50	—	60	—	10
100	HU363WA	HU363DSWA	HU363AWA	ACP1034CD	—	75	—	100	—	20

Table 3.23: Appleton Powertite 600 Vac Short Circuit Current Rating

Amperes	10 kAIR Fuses	100 kAIR Fuses	200 kAIR Fuses	14 kAIR Circuit Breaker	18kAIR Circuit Breaker
Fusible—3P, 600 Vac, 250 Vdc					
30	H, K	—	J, R	—	—
60	H, K	—	J, R	—	—
100	H, K	—	J, R	—	—
Non-Fusible—3P, 600 Vac, 250 Vdc					
30	H, K	J, R, T [52]	J, R, T	FA	FH
60	H, K	—	J, R, T	FA	FH
100	H, K	—	J, R, T	FA	FH

Crouse-Hinds Arktite Receptacle

- UL Listed
- Available in 30 - 100 A, 600 Vac/250 Vdc, fused or non-fused, Type 1, Type 4/4X/5 stainless steel and Type 12/3R
- Suitable for use as service equipment
- Receptacles are cast aluminum, copper free for Type 1 and Type 12/3R safety switches
- Receptacles are epoxy powder coated, copper free cast aluminum for Type 4/4X/5 stainless steel safety switches



H362AWC Interlocked Receptacle Switch with Crouse-Hinds Arktite Receptacle

Table 3.24: Crouse-Hinds Arktite Safety Switch

Amperes	NEMA 1	NEMA 4, 4X, 5 304 Stainless Steel Enclosure	NEMA 12, 3R	Use with Plug	Horsepower Ratings—3Ø					
					480 Vac [50]		600 Vac [50]		250 Vdc [51]	
					Std.	Max.	Std.	Ma-x.	Std.	Ma-x.
Fusible—3P, 600 Vac, 250 Vdc										
30	H361WC	H361DSWC	H361AWC	APJ3485	5	15	7-1/2	20	5	—
60	H362WC	H362DSWC	H362AWC	APJ6485	15	30	15	50	10	—
100	H363WC	H363DSWC	H363AWC	APJ10487	25	60	30	75	20	—
Non-Fusible—3P, 600 Vac, 250 Vdc										
30	HU361WC	HU361DSWC	HU361AWC	APJ3485	—	20	—	30	—	5
60	HU362WC	HU362DSWC	HU362AWC	APJ6485	—	50	—	60	—	10
100	HU363WC	HU363DSWC	HU363AWC	APJ10487	—	60	—	100	—	20

[48] Accessories and Special Features, page 3-13

[49] Receptacle UL listed for use with Appleton™ ACP or CPH plugs; UL Classified for use with Crouse-Hinds APJ Arktite™ plugs. (see Table 3.24.)

[50] Std.—Using fast acting one time fuses. Max.—Using dual element time delay fuses.

[51] For switching dc, use two outside switching poles.

[52] SCCR when using 60 Amp Max fuse.

Table 3.25: Crouse-Hinds 600 Vac Short Circuit Current Rating

Amperes	10 kAIR Fuses	100 kAIR Fuses	200 kAIR Fuses	14 kAIR Circuit Breaker	18kAIR Circuit Breaker
Fusible—3P, 600 Vac, 250 Vdc					
30	H, K	—	J, R	—	—
60	H, K	—	J, R	—	—
100	H, K	—	J, R	—	—
Non-Fusible—3P, 600 Vac, 250 Vdc					
30	H, K	J, R, T [53]	J, R, T	FA	FH
60	H, K	—	J, R, T	FA	FH
100	H, K	—	J, R, T	FA	FH

Hubbellok Receptacle

- UL Listed
- Available in 30 -100 A, 600 Vac/250 Vdc, fused or non-fused, Type 1, and Type 12/3R
- Suitable for use as service equipment
- Receptacles are zinc plated steel for Type 1 and 12 safety switches
- Short Circuit Current Rating for fusible switches is 10 kAIR maximum when used with Class H, K, J or R fuses
- Short Circuit Current Rating for non-fusible switches is 10 kAIR maximum when protected by Class H, K, J, R or T fuses

Table 3.26: Hubbellok Receptacle Safety Switch

Amperes	NEMA 1 Cat. No.	NEMA 12 Cat. No.	Use with Plug [54] Cat. No.	Horsepower Ratings—3Ø			
				480 Vac [55]		600 Vac [55]	
				Std.	Max.	Std.	Max.
Fusible—3P, 600 Vac							
60	H362WH	H362AWH	SD12781	15	30	15	50
Non-Fusible—3P, 600 Vac							
60	HU362WH	HU362AWH	SD12781	—	50	—	60

Square D by Schneider Electric brand heavy duty safety switches are UL listed for use with the following accessories:

Rainproof Bolt-On Hubs

- UL Listed for indoor or rainproof applications
- Suitable for use with conduit having ANSI standard taper pipe thread
- Type 3R switches with catalog number ending in RB have a bolt-on closing cap factory installed
 - Accepts 3/4 in. through 2-1/2 in. bolt-on hubs
 - No gaskets required
- Type 3R switches with R suffix have blank top endwalls
 - Accepts 3 in. through 4 in. bolt on hubs
 - Gaskets provided
 - Conduit entry holes must be cut in the field

Table 3.27: Rainproof Bolt-On Hubs [56]

Conduit Size	3/4	1	1-1/4	1-1/2	2	2-1/2	3	3-1/2	4	Closing Cap
Hub Cat. No.	B075	B100	B125	B150	B200	B250	B300	B350	B400	BCAP

Watertight Hubs

- UL Listed for dusttight and watertight applications
- Suitable for use with conduit having ANSI standard taper pipe thread
- Watertight hubs are field installed on Type 4/4X/5 stainless steel and Type 12/3R and 12K enclosures
- Watertight hubs are available in zinc or chrome plated finish
- Gaskets provided

Table 3.28: Watertight Hubs [57]

Conduit Size	1/2	3/4	1	1-1/4	1-1/2	2	2-1/2	3	3-1/2	4
Standard-Zinc Hub Cat. No.	H050	H075	H100	H125	H150	H200	H250	H300	H350	H400
Chrome Plated Hub Cat. No.	H050CP	H075CP	H100CP	H125CP	H150CP	H200CP	—	—	—	—



H362AWH Interlocked Receptacle Switch with Hubbell™ Hubbellok Receptacle



Watertight Hubs

[53] SCCR when using 60 Amp Max fuse.

[54] Hubbell plug is furnished with a Kellems grip for 1-1/2 in. to 1-21/64 in. cable diameter.

[55] Std.—Using fast acting one time fuses. Max.—Using dual element time delay fuses.

[56] Gaskets are provided on 3 in. and larger hubs.

[57] Gaskets are provided.

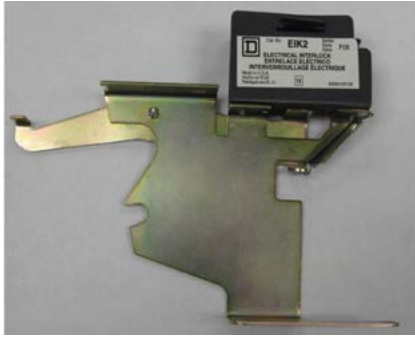

EIK2 Electrical Interlock Kit

Electrical Interlock Kits

Electrical interlocks for heavy duty safety switches 30 A through 1200 A are available factory installed or in kit form for field installation. A pivot arm operates from the switch mechanism, breaking the control circuit before the main switch blades break. For factory-installed electrical interlocks add EI (for one contact) or EI2 (for two contacts) suffix to catalog number. See Supplemental Digest Section 2 for electrical interlock contact ratings. UL Listed, factory or field installed.

Table 3.29: Electrical Interlock Kit [58] [59]

Switch's Amperes Rating	Series Number [60]	Electrical Interlock Kit Cat. No. [61]
30	F5-F6	EIK031
		EIK032
		EIK1
60 (600 V)	F5-F6	EIK2
		EIK031
60 (240 V)	F5-F6	EIK032
		EIK1
100-200	F5-F6	EIK2
		EIK1
30-100 Receptacle Switches	F5-F7	EIK1
		EIK2
30-200 4 and 6 Pole Switches	F5-F6	EIK1
		EIK2
400-1200	E4-E5	EIK40601
		EIK40602

Class R Fuse Kits

When installed, this kit rejects all but Class R fuses. Kits are available for field installation. One kit required for a three pole switch. For factory installation, add "CLR" suffix to catalog number.

Table 3.30: 240 Vac — Class R Fuse Kits [62]

Amperes	Series Number	Class R Fuse Kit Cat. No.
30	F5-F6	RFK03L
60	F5-F6	RFK03H
100	F5-F6	RFK10
200	F5-F6	HRK1020
400-600	E4-E5	HRK4060

Table 3.31: 600 Vac — Class R Fuse Kits [62] [63]

Amperes	Series Number	Class R Fuse Kit Cat. No.
30 [64]	F5-F6	RFK03H
30 A Receptacle Switches	F7	RFK06
30 A 4 Pole Switches	F5-F6	RFK06
60	F5-F7	RFK06H
100	F5-F7	RFK10
200	F5-F6	HRK1020
400-600	E4-E5	HRK4060

Internal Barrier Kits

Internal Barrier Kits provide an additional barrier that helps prevent accidental contact with live parts. Field-installed transparent barriers do not restrict visual inspection of the switch. Barriers provide IEC529 IP2X "finger safe" protection when door of enclosed disconnect switch is open. Convenient door allows use of test probes without accessing fuses and replacement of fuses without removing barrier. For use with 3 pole switches.

Table 3.32: Internal Barrier Kits

Cat. No.	Description	Safety Switch Application (F Series Only)
SS03	Interior Barrier for 30 A and 240 V 60 A Safety Switch [65]	240 / 600 Vac – 30 A 240 Vac – 60 A
SS06	Interior Barrier for 600 V, 60 A Safety Switch	600 Vac – 60 A
SS10	Interior Barrier for 240 / 600 V, 100 A Safety Switch	240 / 600 Vac – 100 A
SS20	Interior Barrier for 240 / 600 V, 200 A Safety Switch	240 / 600 Vac – 200 A

[58] For series not shown in table refer to the switch wiring diagram.

[59] Electrical interlocks for Type 4X fiberglass reinforced polyester and Krydon™ see Table 3.19 and Table 3.20 respectively.

[60] See page 3-19 and page 3-20 for safety switch series.

[61] Electrical interlock kit catalog numbers ending in 1 indicates one normally open and one normally closed contact. These kits use a 9007A01 industrial snap switch. Electrical interlock kit catalog numbers ending in 2 indicates two normally open and two normally closed contacts. These kits use a 9007C03 industrial snap switch.

[62] For series not shown in the table, refer to the switch wiring diagram.

[63] Class R Fuse Kits for Fiberglass Reinforced Polyester enclosures and Krydon™ enclosures see Table 3, page 3-10 and Table 5, page 3-11 respectively.

[64] H361-2, H361-2A, H361-2AWK and H361-2RB use RFK06.

[65] Requires arc shield on 240 V switches be changed to 600 V arc suppressor. Contact the Customer Care Center at 1-888-778-2733 for the arc suppressor part number.



Fuse Puller Kits

Fuse Puller Kits

Fuse Puller Kits are standard equipment on the following 30 A - 100 A switches: Type 12 and 12K, Type 4/4X/5 stainless steel, Type 4X fiberglass reinforced polyester and Krydon™.

Fuse Puller Kit available for field installation on Type 1 and Type 3R, 30 A – 100 A switches. One Fuse Puller Kit required for a 3 pole fusible 240 V or 600 V heavy duty switch. Fuse Puller Kits can be field installed on switches manufactured since February 1980.

Amperes	Series Number [66]	Fuse Puller Kit Cat. No.
30	F5-F7	FPK03 [67]
60	F5-F7 (600 V)	FPK0610
60	F5 (240 V)	FPK03
100	F5-F7	FPK0610

Solid Neutral Assembly Kits

Table 3.33: Solid Neutral Assembly Kits [66] [68] [69] [70]

Amperes	Series Number [71]	Standard Neutral Kit Cat. No.	Terminal Data AWG/kcmil	Optional Copper Only Neutral Kit Cat. No.	Terminal Data AWG/kcmil
30	F5-F6	SN03 [72]	(2) 14-3 Al/Cu plus (1) 14-3 Al/Cu Svc Ground	SN03C [72]	(2) 14-6 Cu plus (1) 14-6 Cu Svc Ground
60	F5-F6 (600 V)	SN0610	(2) 14-1/0 Al/Cu plus (2) 14-6 Al/Cu Svc Ground	SN0610C	(2) 14-1/0 Cu plus (2) 14-6 Cu Svc Ground
	F5-F6 (240 V)	SN03	(2) 14-3 Al/Cu plus (1) 14-3 Al/Cu Svc Ground	SN03C	(2) 14-1/0 Cu plus (2) 14-6 Cu Svc Ground
100	F5-F6	SN0610	(2) 14-1/0 Al/Cu plus (2) 14-6 Al/Cu Svc Ground	SN0610C	(2) 14-1/0 Cu plus (2) 14-6 Cu Svc Ground
200 [73]	F5-F6	SN20A	(2) 6-250 Al/Cu plus (1) 14-10 Al/Cu Svc Ground	SN20C	(2) 6-250 Cu plus (1) 14-1/0 Cu Svc Ground
400 and 600	E4-E5	H600SN	(4) 1-750 Al/Cu plus (1) 4-300 Al/Cu Svc Ground	H600SNC	(2) 1-600 Cu and (2) 4-350 Cu plus (2) 6-250 Cu Svc Ground
800	E4	H800SNE4	(6) 3/0-750 Al/Cu plus (2) 6-350 Al/Cu Svc Ground	—	—
1200	E4	H1200SNE4	(8) 3/0-750 Al/Cu plus (2) 6-350 Al/Cu Svc Ground	—	—

Equipment Grounding Kits

Equipment grounding kits are available for factory or field installation. For factory installation of equipment grounding kit, add suffix GL to standard Cat. No. (Example: H361GL).

Table 3.34: Equipment Grounding Kits and Terminal Data [74] [75]

Amperes	Series Number	Standard Cat. No.	Terminal Data AWG/kcmil	Optional Copper Only Cat. No.	Terminal Data AWG/kcmil
30	F5-F6	GTK03 [76]	(2) 14-4 Cu or (2) 12-4 Al or (4) 14-12 Cu or (4) 12-10 Al	GTK03C [76] [77]	(2) 14-6 Cu
60	F5-F6 (600 V)	GTK0610	(2) 14-1/0 Cu or (2) 12-1/0 Al and (2) 14-6 Cu or (2) 12-6 Al	GTK0610C	(2) 14-1/0 Cu and (2) 14-6 Cu
60	F5-F6 (240 V)	GTK03	(2) 14-4 Cu or (2) 12-4 Al or (4) 14-12 Cu or (4) 12-10 Al	GTK03C	(2) 14-6 Cu
100	F5-F6	GTK0610	(2) 14-1/0 Cu or (2) 12-1/0 Al and (2) 14-6 Cu or (2) 12-6 Al	GTK0610C	(2) 14-1/0 Cu and (2) 14-6 Cu
200	F5-F6	PKOGTA2	(2) 10-2/0 Cu or (2) 6-2/0 Al	PKOGTC2	(2) 14-4 Cu
400 and 600	E4-E5	PKOGTA2 [78]	(2) 10-2/0 Cu or (2) 6-2/0 Al	PKOGTC3	(4) 14-1/0 Cu
800	E4	PKOGTA7	(4) 4-350 Al/Cu	—	—
1200	E4	PKOGTA8	(8) 4-350 Al/Cu	—	—

[66] For series not shown in chart refer to the switch wiring diagram.
 [67] 30 A 4 pole, H361-2 and H361-2RB Series F5, H361WA and H361WC Series F6 use FPK0610.
 [68] For solid Neutral Assembly Kits for Krydon™ enclosure see Table 3.20.
 [69] For Solid Neutral Assembly Kits for Fiberglass Reinforced Ployester enclosures see Table 3.19.
 [70] Neutrals cannot be installed in 4 or 6 pole switches or receptacle switches.
 [71] See page 3-19 and page 3-20 for safety switch series.
 [72] The following 30 A Series F5-F6 switches use SN0610 or SN0610C: H3612, H3612RB, H3612A, H3612AWK, HU3612, HU3612RB, HU3612A and HU3612AWK.
 [73] For 200% neutral, order (2) SN20A Neutral Kits and (1) SN20NI Neutral Jumper Kit.
 [74] For series not shown in table refer to the switch wiring diagram.
 [75] Equipment Ground Kits (Al/Cu) are factory installed standard in 30-200 A Series F Type 4/4X/5 (stainless steel), 12 and 12K. Equipment Ground Kits are standard factory installed on all receptacle switches and all Series F 30-200 A, 4 and 6 pole switches.
 [76] H2212AWK accepts GTK03 or GTK03C. H3612A or AWK accepts GTK03C. H3612 and H3612RB accepts GTK0610 HU3612AWK accepts GTK03C. HU3612A accepts GTK0610C. HU3612RB accepts GTK0610 or GTK0610C.
 [77] Optional copper equipment grounding kit for the 4 and 6 pole 30 A F Series: H461DS, H461AWK, HU461DS, HU661DS and HU661AWK accepts GTK03C HU461AWK accepts GTK0610C.
 [78] Two required if equipment grounding conductors are run in parallel.

Special Paint and Touch-Up Paint

UL Listed heavy duty switches are available painted with special safety colors. To order safety colored switches, add suffixes from the Safety Colors table to the standard switch catalog number.

Not available on NEMA 4X Fiberglass, Krydon, NEMA 4/4X/5 Stainless Steel nor NEMA 7 and 9 switches.

All colors comply with OSHA Standard 1910.144 and ANSI Specification Z535.1 for marking physical hazards.

Table 3.35: Safety Colors [79]

Safety Color	Suffix	Safety Color	Suffix
Black	SP0	Blue	SP6
Red	SP2	Purple	SP7
Orange	SP3	Gray	SP8 [80]
Yellow	SP4	Gray ANSI 61	SP861
Green	SP5	White	SP9

Table 3.36: Square D Gray Touch-Up Paint

Description	Cat. No.
12 oz. Aerosol Paint Can, Square D ANSI-49 Gray Touch-Up Paint	PK49SP

NOTE: Minimum quantity of 6 required.

Lock-Off Guard Kits

 [81] [82]

Available factory- or field-installed the lock-off guard works by covering the lockout/tagout opening whenever the switch is in the ON position. This prevents a padlock from being inadvertently inserted into the switch lockplate. The device is designed to help prevent accidental misapplication of a lockout device. These kits are marked cURus (UL Component Recognized) for field or factory installation.

Table 3.37: Lock-Off Guard Kits

Switch Rating	Cat. No.
30 A	LOGK1
60 A 240 V	
60 A 600 V	
100 and 200 A	LOGK2



Optional Lock-OFF Guard Kit Installed



Key Interlock System

Key Interlock Systems

Factory-installed only on heavy duty safety switches and double throw safety switches.

Interlocks are used to prevent the authorized operator from making an unauthorized operation. Not available on NEMA 4X Fiberglass, Krydon or NEMA 7 and 9 switches.

The key interlock system is a simple and easy method of applying individual key interlock units and assemblies to the above equipment so as to require operation in a predetermined sequence. UL Listed.

Quoting: Contact Schneider Electric for catalog number, availability, and pricing prior to quoting a job. Detailed information is required before an order can be processed. Please see Supplemental Digest Section 2 for further information.

Use these suffixes on switch catalog numbers:

- KI = 1 lock per switch
- KI2 = 1 lock with 2 cylinders (2 keys) per switch
- KIKI = 2 separate locks per switch

Lock-ON Provisions

Lock-OFF provisions are standard on all heavy duty safety switches. Provision for one 3/8 inch hasp padlock is available factory-installed on 30–1200 A, NEMA 1, 3R, 4–4X-5 stainless steel 12 and 12K switches. Not available on NEMA 4X, Fiberglass, Krydon or NEMA 7 and 9 switches. This modification will allow the switch to be locked in the "ON" position. UL Listed.

To order, add suffix SPLO to standard catalog number. Example: H364-SPLO

[79] A minimum quantity of 10 is required.

[80] Standard Square D ANSI 49 grey paint, when selecting this suffix, switches will receive additional coat of paint.

[81] Available factory assembled or as a field installable kit on NEMA Type 1, 3R, 12 or 12K switches. Not available for use on NEMA Type 4X Fiberglass, Krydon, Type 4/4X/5 Stainless Steel nor Type 7 and 9 switches.

[82] For factory installation add suffix LOG to the standard switch catalog number.

Cover Viewing Window

Optional cover viewing window is positioned over the blades to allow visual verification of "ON-OFF" status. Available on 30 through 1200 A heavy duty switches, NEMA 1, 3R, 4/4X/5 Stainless Steel, 12 and 12K. (Not available on NEMA 4X, Fiberglass, Krydon or NEMA 7 and 9 switches). Add VW suffix to the catalog number for factory installation.

Voltage Monitors

Voltage monitors installed on safety switches indicate when voltage is present, helping to prevent arc-flash hazards and electric shocks during maintenance work. Voltage monitors can be combined with other safety features such as Key Interlock, Viewing Windows or Lock-ON provisions.

- UL Listed
- Factory installed only
- Order the voltage monitors by adding the appropriate suffix shown in the table below to the switch catalog number
- Not available on NEMA 7 and 9 and NEMA 4X Fiberglass and Krydon™ switches

Table 3.38: Voltage Monitors [83]

Description	Suffix [84]
Line Side Monitor	SI
Load Side Monitor	LI
Line and Load Side Monitors	LI2



Copper Lug Kits

Lug kits that accept only copper wire are available for field or factory installation:

- UL Listed
- UL Marine Listed
 - UL Marine listing is applicable ONLY to 30 - 200 A, Type 12/3R, Type 12K and Type 4/4X/5 stainless steel, safety switches
 - When copper only lugs kits are factory installed the switch will bear the UL Marine mark and be suitable for use on vessels over 65 feet long
 - When the copper only lugs kits are field installed the switch will not bear the UL Marine mark and would not be suitable for use on vessels over 65 feet long
- Not available for use on NEMA Type 4X Fiberglass, Krydon or Type 7 and 9 switches
- For field installation, order copper lug kits. See Table below
- For factory installation of copper lugs, add the suffix SLC to the standard catalog number

Table 3.39: Copper Lug Kits [85]

Amperes	Lug Kit Cat. No.	Lug Wire Range AWG/kcmil
30-60	CL0306F	(1) 14-8 Cu solid or 14-4 Cu stranded
100	CL10F	(1) 14-8 Cu solid or 14-1/0 Cu stranded
200	CL20F	(1) 6-250 Cu
400	CL40F	(1) 1-600 Cu plus (1) 6-250 Cu
600	CL60F	(1) 4-350 Cu
800	—	—
1200	—	—

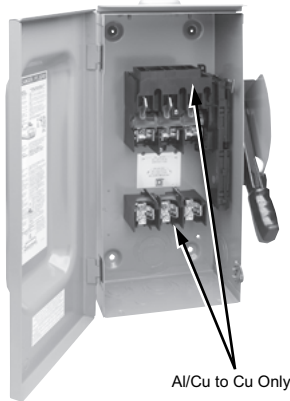

[83] Available on 30-1200 A Heavy Duty Safety Switches and 30-400 A Double Throw Safety Switches.

[84] In addition to the suffix shown in the table above, a 3 must be added to the switch catalog number for all 30 and 60 A switches, i.e. H361AWK becomes H361AWKLI. 30 and 60 A switches require 100 A enclosure accessories.

[85] One kit includes all phase line/load lugs for a 3-pole switch. CL0306F, CL10F and CL20F includes six lugs. CL40F and CL60F includes twelve lugs.

Double Lug Kits

200 A heavy duty F-series switches are supplied standard with lugs suitable for one wire per phase. For two wires per phase and neutral, order the Double Lug Kit.

Not UL Listed. Not listed on switch's wiring diagram as an accessory.

Table 3.40: Double Lug Kits

Amperes	Cat. No. [86]	Lug Wire Range per Phase and Neutral AWG/kcmil	Wire Range Wire Bending Space per NEC Table 312.6 AWG/kcmil
200	AL200DTF	(2) 6–300 Cu/Al	(2) 6–250 Cu/Al

Compression Lug Kits — 800 A and 1200 A Safety Switches

- UL Listed.
- Compression Lug Kits available for field installation
- Compression Lug Kits available for factory installation; Add suffix LK to standard catalog number
- Compression Lug Kits contain VCEL07512H1 Versa-Crimp™ compression lugs
- Order one Compression Lug Kit per switching pole and/or neutral (see Table below)

Table 3.41: Compression Lug Kits

Amperes	Lug Kit Cat. No.	Conductors per Phase	Lug Wire Range kcmil
800	H8LKE2	(3) Line and (3) Load	500-750 kcmil (Al) or 500 kcmil (CU)
1200	H12LKE2	(4) Line and (4) Load	500-750 kcmil (Al) or 500 kcmil (CU)

Table 3.42: Terminal Lug Data [87]

Rating (A)	Wires Per Phase and Neutral	Wire Range Wire Bending Space per NEC Table 312.6 AWG/kcmil	Lug Wire Range AWG/kcmil	Optional [88]/Compression Lug Field-Installed	Optional Copper Only [88] Compression Lug Field-Installed [89]
30	1	12–6 (Al) or 14–6 (Cu)	12–2 (Al) or 14–2 (Cu)	C10–14,[90] D8–14–SK, or E6–14	—
	2	12–10 (Al) or 14–10 (Cu)			
60 [91]	1	12–3 (Al) or 14–3 (Cu)	12–2 (Al) or 14–2 (Cu)	C10–14,[90] D8–14–SK, or E6–14	—
100 [92]	1	12–1/0 (Al) or 14–1/0 (Cu)	12–1/0 (Al) or 14–1/0 (Cu)	VCEL02114S1	VCEL02114S1
200 [93]	1	6–250 (Al/Cu)	6–300 (Al/Cu)	VCEL030516H1	VCEL030516H1
400 [94]	1 or 2	1/0–750 (Al/Cu) or 1/0–300 (Al/Cu)	1/0–750 (Al/Cu) or 1/0–300 (Al/Cu)	VCEL07512H1 or VCEL030516H1 [95] and VCEL05012H1	VCEL07512H1 or VCEL030516H1 [96] and VCEL05012H1
	600	2	3/0–500 (Al/Cu)	VCEL05012H1	VCEL05012H1
800	3	3/0–750 (Al/Cu)	3/0–750 (Al/Cu)	H8LKE2 [97]	—
1200	4	3/0–750 (Al/Cu)	3/0–750 (Al/Cu)	H12LKE2 [97]	—

Table 3.43: Conduit Provisions

Amperes	Top and Bottom Endwall	
	NEMA 4X Fiberglass Reinforced Polyester and Krydon [98]	NEMA 7 and 9 [99]
30	3/4 in.	—
60	1-1/4 in.	3/4 in.
100	2 in.	1-1/4 in.
200	2-1/2 in.	2-1/2 in.

[86] Kit contains 3 lugs. Order two kits for line and load lugs.

[87] 30–100 A switches suitable for 60°C or 75°C conductors. 200–1200 A switches suitable for 75°C conductors.

[88] Hubbell Versa-Crimp™ unless otherwise noted.

[89] For Type 1, 12/3R, 12K and 4/4X/5 stainless steel switches only.

[90] Order from Thomas and Betts.

[91] H60XFA and H60XFA1212 — use 75°C copper wire only. #6 AWG copper wire required for 60 A rating.

[92] H100XFA and H100XFA1212 — use 75°C copper wire only. #3 AWG copper wire required for 100 A rating.

[93] H225XJG and H225XJGAA — use 75°C copper wire only. Lug wire range is #3 AWG – 350 kcmil. Not UL Listed due to inadequate wire bending space (5" on ON end, 6" on OFF end).

[94] Maximum wire bending space allows for (1) 600 kcmil or (2) 300 kcmil Al/Cu on Type 4/4X/5 stainless steel and Type 12 switches.

[95] Order two PK516KN mounting kits when installing VCEL030516H1 lugs. Only one kit is required on 2 pole switches. PK516KN consists of (4) 5/16-18 Keps Nuts.

[96] Order two PK516KN mounting kits when installing VCEL030516H1 or VCEL030516H1 lugs. Only one kit is required on 2 pole switches. PK516KN consists of (4) 5/16-18 Keps Nuts.

[97] For 800 and 1200 A compression lug kits see Table 3.41 for additional information.

[98] Hubs and hub drilling templates are provided for field-installation.

[99] Threaded conduit opening.

NEMA Type 1 and 3R

See Table 3.42 Terminal Lug Data, page 3-18 for terminal lug data for the series switches listed in the dimension table below.

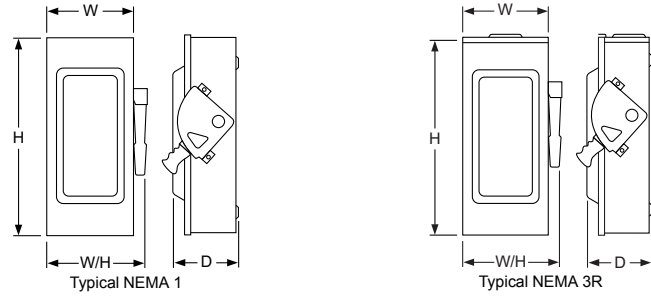

Table 3.44: Approximate Dimensions

Cat. No.	Series	H		W		D		W/H		Cat. No.	Series	H		W		D		W/H	
		in.	mm	in.	mm	in.	mm	in.	mm			in.	mm	in.	mm	in.	mm	in.	mm
H221N	F5	14.60	371	6.50	165	4.88	124	7.55	192	H364, N	F5	29.00	737	17.13	435	8.25	210	18.50	470
H221NRB	F5	14.88	378	6.63	168	4.88	124	7.55	192	H364RB, NRB	F5	29.25	743	17.25	438	8.50	216	18.63	473
H222N	F5	14.60	371	6.50	165	4.88	124	7.55	192	H365, N	E4	50.25	1276	27.63	702	10.13	257	27.63	702
H222NRB	F5	14.88	378	6.63	168	4.88	124	7.55	192	H365R, NR	E5	50.31	1278	27.76	705	9.53	242	27.88	708
H223N	F5	21.25	540	8.50	216	6.38	162	10.50	267	H366, N	E4	50.25	1276	27.63	702	10.13	257	27.63	702
H223NRB	F5	21.25	540	8.50	216	6.38	162	10.50	267	H366NR, R	E5	50.31	1278	27.76	705	9.53	242	27.88	708
H224N	F5	29.00	737	17.13	435	8.25	210	18.50	470	H367, N	E4	69.13	1756	36.62	930	17.75	451	36.62	930
H224NRB	F5	29.25	743	17.25	438	8.50	216	18.63	473	H367NR, R	E4	69.13	1756	36.62	930	17.75	451	36.62	930
H225, N	E4	50.25	1276	27.63	702	10.13	257	27.63	702	H368, N	E4	69.13	1756	36.62	930	17.75	451	36.62	930
H225NR, R	E5	50.31	1278	27.76	705	9.53	242	27.88	708	H368NR, R	E4	69.13	1756	36.62	930	17.75	451	36.62	930
H226, N	E4	50.25	1276	27.63	702	10.13	257	27.63	702	H461	F5	20.50	521	14.75	375	6.85	174	16.13	410
H226NR, R	E5	50.31	1278	27.76	705	9.53	242	27.88	708	H462	F5	20.50	521	14.75	375	6.85	174	16.13	410
H227, N	E4	69.13	1756	36.62	930	17.75	451	36.62	930	H463	F5	20.50	521	14.75	375	6.85	174	16.13	410
H227NR, R	E4	69.13	1756	36.62	930	17.75	451	36.62	930	H464	F5	29.00	737	23.25	591	8.75	222	24.88	632
H228, N	E4	69.13	1756	36.62	930	17.75	451	36.62	930	H465	E4	50.25	1276	33.88	861	10.13	257	33.88	861
H228NR, R	E4	69.13	1756	36.62	930	17.75	451	36.62	930	H466	E4	50.25	1276	33.88	861	10.13	257	33.88	861
H265	E4	50.25	1276	27.63	702	10.13	257	27.63	702	HU265	E4	50.25	1276	27.63	702	10.13	257	27.63	702
H265R	E5	50.31	1278	27.76	705	9.53	242	27.88	708	HU265R	E5	50.31	1278	27.76	705	9.53	242	27.88	708
H266	E4	50.25	1276	27.63	702	10.13	257	27.63	702	HU266	E4	50.25	1276	27.63	702	10.13	257	27.63	702
H266R	E5	50.31	1278	27.76	705	9.53	242	27.88	708	HU266R	E5	50.31	1278	27.76	705	9.53	242	27.88	708
H267	E4	69.13	1756	36.62	930	17.75	451	36.62	930	HU267	E4	69.13	1756	36.62	930	17.75	451	36.62	930
H267R	E4	69.13	1756	36.62	930	17.75	451	36.62	930	HU267R	E4	69.13	1756	36.62	930	17.75	451	36.62	930
H268	E4	69.13	1756	36.62	930	17.75	451	36.62	930	HU268	E4	69.13	1756	36.62	930	17.75	451	36.62	930
H268R	E4	69.13	1756	36.62	930	17.75	451	36.62	930	HU268R	E4	69.13	1756	36.62	930	17.75	451	36.62	930
H321N	F5	14.60	371	6.50	165	4.88	124	7.55	192	HU361	F5	14.60	371	6.50	165	4.88	124	7.55	192
H321NRB	F5	14.88	378	6.63	168	4.88	124	7.55	192	HU361RB	F5	14.88	378	6.63	168	4.88	124	7.55	192
H322N	F5	14.60	371	6.50	165	4.88	124	7.55	192	HU361WA	F6	18.19	462	9.00	229	6.81	173	10.50	267
H322NRB	F5	14.88	378	6.63	168	4.88	124	7.55	192	HU361WC	F6	18.19	462	9.00	229	6.81	173	10.50	267
H323N	F5	21.25	540	8.50	216	6.38	162	10.50	267	HU362	F5	17.50	445	9.00	229	6.38	162	10.50	267
H323NRB	F5	21.25	540	8.50	216	6.38	162	10.50	267	HU362RB	F5	17.50	445	9.00	229	6.38	162	10.50	267
H324N	F5	29.00	737	17.13	435	8.25	210	18.50	470	HU362WA	F6	18.19	462	9.00	229	6.81	173	10.50	267
H324NRB	F5	29.25	743	17.25	438	8.50	216	18.63	473	HU362WC	F6	16.75	425	9.00	229	7.00	178	10.50	267
H325, N	E4	50.25	1276	27.63	702	10.13	257	27.63	702	HU362WH	F5	18.19	462	9.00	229	6.81	173	10.50	267
H325NR, R	E5	50.31	1278	27.76	705	9.53	242	27.88	708	HU363	F5	21.25	540	8.50	216	6.38	162	10.50	267
H326, N	E4	50.25	1276	27.63	702	10.13	257	27.63	702	HU363RB	F5	21.25	540	8.50	216	6.38	162	10.50	267
H326NR, R	E5	50.31	1278	27.76	705	9.53	242	27.88	708	HU363WA	F6	21.85	462	9.00	229	6.81	173	10.50	267
H327, N	E4	69.13	1756	36.62	930	17.75	451	36.62	930	HU363WC	F6	21.85	555	9.00	229	6.81	173	10.50	267
H327R, NR	E4	69.13	1756	36.62	930	17.75	451	36.62	930	HU364	F5	29.00	737	17.13	435	8.25	210	18.50	470
H328, N	E4	69.13	1756	36.62	930	17.75	451	36.62	930	HU364RB	F5	29.25	743	17.25	438	8.50	216	18.63	473
H328R, NR	E4	69.13	1756	36.62	930	17.75	451	36.62	930	HU365	E4	50.25	1276	27.63	702	10.13	257	27.63	702
H361, N	F5	14.60	371	6.50	165	4.88	124	7.55	192	HU365R	E5	50.31	1278	27.76	705	9.53	242	27.88	708
H361-2	F5	17.50	445	9.00	229	6.38	162	10.50	267	HU366	E4	50.25	1276	27.63	702	10.13	257	27.63	702
H361NRB, RB	F5	14.88	378	6.63	168	4.88	124	7.55	192	HU366R	E5	50.31	1278	27.76	705	9.53	242	27.88	708
H361WA	F6	18.19	462	9.00	229	6.81	173	10.50	267	HU367	E4	69.13	1756	36.62	930	17.75	451	36.62	930
H361WC	F6	18.19	462	9.00	229	6.81	173	10.50	267	HU367R	E4	69.13	1756	36.62	930	17.75	451	36.62	930
H362, N	F5	17.50	445	9.00	229	6.38	162	10.50	267	HU368	E4	69.13	1756	36.62	930	17.75	451	36.62	930
H362NRB, RB	F5	17.50	445	9.00	229	6.38	162	10.50	267	HU368R	E4	69.13	1756	36.62	930	17.75	451	36.62	930
H362WA	F6	18.19	462	9.00	229	6.81	173	10.50	267	HU461	F5	20.50	521	14.75	375	6.85	174	16.13	410
H362WC	F6	16.75	425	9.00	229	7.00	178	10.50	267	HU462	F5	20.50	521	14.75	375	6.85	174	16.13	410
H362WH	F5	18.19	462	9.00	229	6.81	173	10.50	267	HU463	F5	20.50	521	14.75	375	6.85	174	16.13	410
H363, N	F5	21.25	540	8.50	216	6.38	162	10.50	267	HU464	F5	29.00	737	23.25	591	8.75	222	24.88	632
H363NRB, RB	F5	21.25	540	8.50	216	6.38	162	10.50	267	HU465	E4	50.25	1276	33.88	861	10.13	257	33.88	861
H363WA	F6	21.85	462	9.00	229	6.81	173	10.50	267	HU466	E4	50.25	1276	33.88	861	10.13	257	33.88	861
H363WC	F6	21.85	555	9.00	229	6.81	173	10.50	267										

NEMA Type 4, 4X, 5, 7, 9, and 12

See Table 3.42 Terminal Lug Data, page 3-18 for terminal lug data for the series switches listed in the dimension table below.

Table 3.45: Approximate Dimensions

Cat. No.	Series	H		W		D		W/H	
		in.	mm	in.	mm	in.	mm	in.	mm
H60XFA	E1	15.93	405	9.87	251	6.96	177	9.87	251
H100XFA	E1	15.93	405	9.87	251	6.96	177	9.87	251
H221AWK,A	F6	14.60	371	6.63	168	4.96	125	7.55	192
H221DS	F6	14.93	379	7.22	183	5.11	130	8.67	220
H221-2AWK	F6	16.50	419	9.00	229	7.00	178	10.50	267
H222AWK,A	F6	14.60	371	6.63	168	4.96	125	7.55	192
H222DS	F6	14.93	379	7.22	183	5.11	130	8.67	220
H223AWK,A	F6	20.50	521	9.00	229	7.00	178	10.50	267
H223DS	F6	20.82	529	9.36	238	6.97	177	11.25	286
H224A,AWK	F6	29.00	737	17.25	438	8.75	216	18.63	473
H224DS	F6	29.00	737	17.75	451	8.88	226	19.25	489
H225AWK,DS	E4	46.25	1175	26.25	667	10.13	259	26.25	667
H225NAWK,NDS	E4	46.25	1175	26.25	667	10.13	259	26.25	667
H225XJG	A1	22.56	573	10.88	276	7.75	197	10.88	276
H226AWK,DS	E5	46.25	1175	26.25	667	10.13	259	26.25	667
H226NAWK,NDS	E5	46.25	1175	26.25	667	10.13	259	26.25	667
H227AWK,NAWK	E4	69.13	1756	36.62	930	17.75	451	36.62	930
H228AWK,NAWK	E4	69.13	1756	36.62	930	17.75	451	36.62	930
H265AWK,DS	E5	46.25	1175	26.25	667	10.13	259	26.25	667
H266AWK,A,DS	E5	46.25	1175	26.25	667	10.13	259	26.25	667
H267AWK,NAWK	E4	69.13	1756	36.62	930	17.75	451	36.62	930
H268AWK,NAWK	E4	69.13	1756	36.62	930	17.75	451	36.62	930
H321AWK,A	F6	14.60	371	6.63	168	4.96	125	7.55	192
H321DS	F6	14.93	379	7.22	183	5.11	130	8.67	220
H322AWK,A	F6	14.60	371	6.63	168	4.96	125	7.55	192
H322DS	F6	14.93	379	7.22	183	5.11	130	8.67	220
H323AWK,A	F6	20.50	521	9.00	229	7.00	178	10.50	267
H323DS	F6	20.82	529	9.36	238	6.97	177	11.25	286
H324A,AWK	F6	29.00	737	17.25	438	8.75	216	18.63	473
H324DS	F6	29.00	737	17.75	451	8.88	226	19.25	489
H325AWK,DS	E5	46.25	1175	26.25	667	10.13	259	26.25	667
H325NAWK,NDS	E5	46.25	1175	26.25	667	10.13	259	26.25	667
H326AWK,DS	E5	46.25	1175	26.25	667	10.13	259	26.25	667
H326NAWK,NDS	E5	46.25	1175	26.25	667	10.13	259	26.25	667
H327AWK,NAWK	E4	69.13	1756	36.62	930	17.75	451	36.62	930
H328AWK,NAWK	E4	69.13	1756	36.62	930	17.75	451	36.62	930
H361AWA	F7	16.50	419	9.00	229	7.00	178	10.50	267
H361AWC	F7	16.50	419	9.00	229	7.00	178	10.50	267
H361AWK,A	F6	14.60	371	6.63	168	4.96	125	7.55	192
H361DS	F6	14.93	379	7.22	183	5.11	130	8.67	220
H361DSWA	F7	16.87	428	8.92	227	5.11	130	10.81	275
H361DSWC	F7	16.87	428	8.92	227	5.11	130	10.79	274
H361DF	F1	16.50	419	11.00	279	8.80	224	11.00	279
H361DX	F1	19.40	493	11.40	290	8.60	218	11.40	290
H361SS	F6	14.93	379	7.22	183	5.11	130	8.67	220
H361-2AWK,A	F6	16.50	419	9.00	229	7.00	178	10.50	267
H362AWA	F7	16.50	419	9.00	229	7.00	178	10.50	267
H362AWC	F7	16.50	419	9.00	229	7.00	178	10.50	267
H362AWH	F6	16.50	419	9.00	229	7.00	178	10.50	267
H362AWK,A	F6	16.50	419	9.00	229	7.00	178	10.50	267
H362DS	F6	16.87	428	8.92	227	6.97	177	10.81	275
H362DSWA	F7	16.87	428	8.92	227	5.11	130	10.81	275
H362DSWC	F7	16.87	428	8.92	227	5.11	130	10.79	274
H362DF	F1	16.50	419	11.00	279	8.80	224	11.00	279
H362DX	F1	19.40	493	11.40	290	8.60	218	11.40	290
H362SS	F6	16.87	428	8.92	227	6.97	177	10.81	275
H363AWA	F7	20.50	521	9.00	229	7.00	178	10.50	267
H363AWC	F7	20.50	521	9.00	229	7.00	178	10.50	267
H363AWK,A	F6	20.50	521	9.00	229	7.00	178	10.50	267
H363DS	F6	20.82	529	9.36	238	6.97	177	11.25	286
H363DSWA	F7	20.82	529	9.36	238	6.97	177	11.25	286
H363DSWC	F7	20.82	529	9.36	238	6.97	177	11.25	286
H363DF	F1	24.80	630	13.70	348	12.00	305	13.70	348
H363DX	F1	25.25	641	11.40	290	8.60	218	11.40	290
H363SS	F6	20.82	529	9.36	238	6.97	177	11.25	286
H364A,AWK	F6	29.00	737	17.25	438	8.75	216	18.63	473
H364DS,NDS	F6	29.00	737	17.75	451	8.88	226	19.25	489
H364NA,NAWK	F6	29.00	737	17.25	438	8.75	216	18.63	473
H364DF	E1	31.30	795	26.30	668	11.80	300	26.30	668
H364SS	F6	29.00	737	17.75	451	8.88	226	19.25	489
H365AWK,DS,SS	E5	46.25	1175	26.25	667	10.13	259	26.25	667
H365NAWK,NDS	E5	46.25	1175	26.25	667	10.13	259	26.25	667
H366AWK,DS	E5	46.25	1175	26.25	667	10.13	259	26.25	667
H366NAWK,NDS,SS	E5	46.25	1175	26.25	667	10.13	259	26.25	667
H367AWK,NAWK	E4	69.13	1756	36.62	930	17.75	451	36.62	930
H368AWK,NAWK	E4	69.13	1756	36.62	930	17.75	451	36.62	930
H461AWK	F6	20.50	521	14.75	375	6.80	173	16.13	410
H461DS	F6	20.82	529	15.08	383	6.97	177	16.85	428
H462AWK	F6	20.50	521	14.75	375	6.80	173	16.13	410
H462DS	F6	20.82	529	15.08	383	6.97	177	16.85	428
H463AWK	F6	20.50	521	14.75	375	6.80	173	16.13	410
H463DS	F6	20.82	529	15.08	383	6.97	177	16.85	428
H464AWK	F6	29.00	737	23.25	591	8.75	222	24.88	632
H464DS	F6	29.00	737	23.75	603	8.88	226	25.25	641
H465AWK	E5	46.25	1175	32.50	826	10.13	259	32.50	826
H663AWK	F6	20.50	521	14.75	375	6.80	173	16.13	410
H663DS	F6	20.82	529	15.08	383	6.97	177	16.85	428
H664AWK	F6	29.00	737	23.25	591	8.75	222	24.88	632
H664DS	F6	29.00	737	23.75	603	8.88	226	25.25	641
HU265AWK,DS	E5	46.25	1175	26.25	667	10.13	259	26.25	667
HU266AWK,DS	E5	46.25	1175	26.25	667	10.13	259	26.25	667
HU267AWK	E4	69.13	1756	36.62	930	17.75	451	36.62	930
HU268AWK	E4	69.13	1756	36.62	930	17.75	451	36.62	930
HU361AWA	F7	16.50	419	9.00	229	7.00	178	10.50	267
HU361AWC	F7	16.50	419	9.00	229	7.00	178	10.50	267
HU361AWK,A	F6	14.60	371	6.63	168	4.96	125	7.55	192
HU361DS	F6	14.93	379	7.22	183	5.11	130	8.67	220
HU361DSWA	F7	16.87	428	8.92	227	5.11	130	10.81	275
HU361DSWC	F7	16.87	428	8.92	227	5.11	130	10.79	274

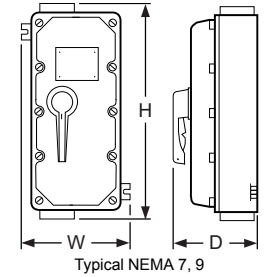
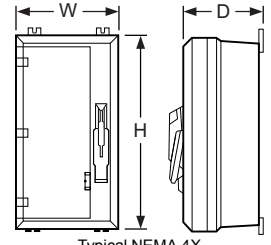
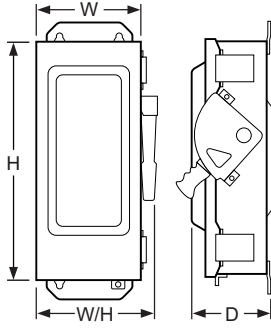

SAFETY SWITCHES

Table 3.45 Approximate Dimensions (cont'd.)

Cat. No.	Series	H		W		D		W/H	
		in.	mm	in.	mm	in.	mm	in.	mm
HU361DF	F1	16.50	419	11.00	279	8.80	224	11.00	279
HU361DX	F1	19.40	493	11.40	290	8.60	218	11.40	290
HU361SS	F6	14.93	379	7.22	183	5.11	130	8.67	220
HU362AWA	F7	16.50	419	9.00	229	7.00	178	10.50	267
HU362AWC	F7	16.50	419	9.00	229	7.00	178	10.50	267
HU362AWH	F6	16.50	419	9.00	229	7.00	178	10.50	267
HU362AWK,A	F6	16.50	419	9.00	229	7.00	178	10.50	267
HU362DS	F6	16.87	428	8.92	227	6.97	177	10.81	275
HU362DSWA	F7	16.87	428	8.92	227	5.11	130	10.81	275
HU362DSWC	F7	16.87	428	8.92	227	5.11	130	10.79	274
HU362DF	F1	16.50	419	11.00	279	8.80	224	11.00	279
HU362DX	F1	19.40	493	11.40	290	8.60	218	11.40	290
HU362SS	F6	16.87	428	8.92	227	6.97	177	10.81	275
HU363AWA	F7	20.50	521	9.00	229	7.00	178	10.50	267
HU363AWC	F7	20.50	521	9.00	229	7.00	178	10.50	267
HU363AWK,A	F6	20.50	521	9.00	229	7.00	178	10.50	267
HU363DS	F6	20.82	529	9.36	238	6.97	177	11.25	286
HU363DSWA	F7	20.82	529	9.36	238	6.97	177	11.25	286
HU363DSWC	F7	20.82	529	9.36	238	6.97	177	11.25	286
HU363DF	F1	24.80	630	13.70	348	12.00	305	13.70	348
HU363DX	F1	25.25	641	11.40	290	8.60	218	11.40	290
HU363SS	F6	20.82	529	9.36	238	6.97	177	11.25	286
HU364A,AWK	F6	29.00	737	17.25	438	8.75	216	18.63	473
HU364DF	E1	31.30	795	26.30	668	11.80	300	26.30	668
HU364DS	F6	29.00	737	17.75	451	8.88	226	19.25	489
HU364SS	F6	29.00	737	17.75	451	8.88	226	19.25	489
HU365AWK,DS,SS	E5	46.25	1175	26.25	667	10.13	259	26.25	667
HU366AWK,DS,SS	E5	46.25	1175	26.25	667	10.13	259	26.25	667
HU367AWK	E4	69.13	1756	36.62	930	17.75	451	36.62	930
HU368AWK	E4	69.13	1756	36.62	930	17.75	451	36.62	930
HU461AWK	F6	20.50	521	14.75	375	6.80	173	16.13	411
HU461DS	F6	20.82	529	15.08	383	6.97	177	16.85	428
HU462AWK	F6	21.25	540	16.13	410	6.80	173	16.13	410
HU462DS	F6	20.82	529	15.08	383	6.97	177	16.85	428
HU463AWK	F6	20.50	521	14.75	375	6.80	173	16.13	410
HU463DS	F6	20.82	529	15.08	383	6.97	177	16.85	428
HU464AWK	F6	29.00	737	23.25	591	8.75	222	24.88	632
HU464DS	F6	29.00	737	23.75	603	8.88	226	25.25	641
HU465AWK	E5	46.25	1175	32.50	826	10.13	259	32.50	826
HU661AWK	F6	20.50	521	14.75	375	6.80	173	16.13	410
HU661DS	F6	20.82	529	15.08	383	6.97	177	16.85	428
HU662AWK	F6	20.50	521	14.75	375	6.80	173	16.13	410
HU662DS	F6	20.82	529	15.08	383	6.97	177	16.85	428
HU663AWK	F6	20.50	521	14.75	375	6.80	173	16.13	410
HU663DS	F6	20.82	529	15.08	383	6.97	177	16.85	428
HU664AWK	F6	29.00	737	23.25	591	8.75	222	24.88	632
HU664DS	F6	29.00	737	23.75	603	8.88	226	25.25	641



30-100 A DT, DTU (Series F)
NEMA 1

30–100 A Types DT, DTU (Series F)

- Fusible (DT) and non-fusible (DTU) switches available
- Manually-operated switch suitable for use in accordance with article 702 of the NEC, ANSI/NFPA 70
- Standards: UL 98, NEMA KS1, CSA, and NOM
- Modular design—switch handle, lock-plate, switch mechanism; line and load bases are field replaceable
- UL Listed short circuit current ratings up to 200 kA (using with (fusible) or protected by (non-fusible) Class R, J, or T fuses—see table for rating)
- Load make/break rated
- Horsepower rated
- Dual cover interlock
- May be padlocked ON (I) or OFF (O)
- Lock-off accepts up to three padlocks
- Side-opening door
- Quick make / quick break mechanism
- Meets NEMA requirements as heavy duty switch
- Field-installed electrical interlock kits
- Field-installed neutral assembly kits (2P and 3P switches)
- UL Listed as suitable for use as service equipment
- Supplied as standard for switching one load between two power sources, and may be field-converted to switch one power source between two loads.



82,000 Line
NEMA 1

30 (Series T4), 200–600 A Types 82,000 and 200 A DTU (Series E, A)







- Non-fusible
- Designed for manual transfer of one load between two power sources
- UL Listed switches are suitable for use in accordance with Article 702 of the National Electrical Code, ANSI / NFPA 70
- All 82,000 and DTU double throw switches are continuous duty rated for their nameplate ampere rating
- The 82,000 and DTU (Series E, A) switches are load make/break rated
- UL Listed as suitable for use as service equipment
- Horsepower rated only as footnoted

Field-Installable Accessories

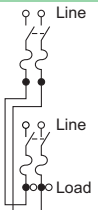
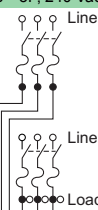
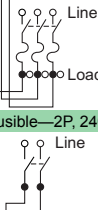
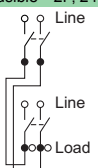
- Neutral
- Electrical Interlock
- Grounding Terminals

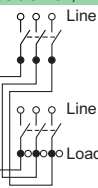
Double-Throw Safety Switches

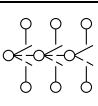
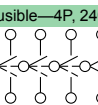
Table 3.46: 240 V Double Throw Safety Switches

System	Amperes	Current Series	NEMA 1	NEMA 3R	NEMA 4, 4X, 5 304 Stainless Steel	NEMA 12 Gasketed	Horsepower Ratings [1][2]				250 Vdc[3]	
							240 Vac					
							Std.		Max.			
Fusible—2P, 240 Vac—250 Vdc												
	100	F	DT223	DT223RB	—	—	7.5	15 [4]	15	30 [4]	20	
Fusible—3P, 240 Vac—250 Vdc												
	30	F	DT321	DT321RB	—	—	1.5 [5]	3 [4]	3 [5]	7.5 [4]	5	
	60	F	DT322	DT322RB	—	—	3 [5]	7.5 [4]	10 [5]	15 [4]	10	
	100	F	DT323	DT323RB	—	—	7.5 [5]	15 [4]	15 [5]	30 [4]	20	
	Non-Fusible—2P, 240 Vac—250 Vdc											
	60	F	DTU222	—	—	—	—	—	10	—	10 [6]	
	100	F	DTU223	DTU223RB	—	—	—	—	15	—	20 [6]	
	30	T4	92251 [7]	—	—	—	—	—	—	—	—	
	200	E	82254	DTU224NRB [7][8]	—	H82254	15	—	—	—	—	
	400	A	82255 [7]	82255R [7]	—	H82255 [7]	—	—	—	—	—	
Non-Fusible—3P, 240 Vac—250 Vdc												
	30	F	DTU321	—	—	—	—	3 [4]	5 [5]	10 [4]	5 [6]	
	60	F	DTU322	—	—	—	—	—	10 [5]	15 [4]	10 [6]	
	100	F	DTU323	DTU323RB	—	—	—	—	15 [5]	30 [4]	20 [6]	
		30	T4	92351 [7]	—	—	—	—	—	—	—	—
200		E	82354 [7]	—	—	H82354 [7]	15	—	—	—	—	
200		E	DTU324N [7][8]	DTU324NRB [7][8]	—	—	15	—	—	—	—	
400		A	82355 [7]	82355R [7]	—	H82355 [7]	—	—	—	—	—	
	600	A	DTU326	DTU326R	—	—	—	125	—	—	50	
	Non-Fusible—4P, 240 Vac											
		30	T4	92451	—	—	—	—	—	—	—	—
		200	E	82454 [9]	82454R [9]	—	H82454 [10]	15 [10]	—	—	—	—
400		A	82455	82455R	—	H82455	—	—	—	—	—	
600		A	DTU426	DTU426R	—	—	—	125	—	—	50	

600 V Double Throw: page 3-24
 Accessories: page 3-25
 Application Data: Application Data, page 3-27
 Dimensions, 30–100 A (Series F): page 3-29
 Dimensions, 30, 200–600 A (Series E, T4, A): page 3-30

[1] The starting current of motors or more than standard horsepower may require the use of fuses with appropriate time delay characteristics.
 [2] Std.—Using fast acting one time fuses. Max.—Using dual element time delay fuses.
 [3] For switching dc, use two switching poles.
 [4] If used on corner grounded delta systems, install neutral and use outer switching pole for ungrounded conductors. See data bulletin 2700DB0202 for additional information.
 [5] Use outer switching poles.
 [6] Maximum rating.
 [7] 240 Vac only. Not Vdc rated.
 [8] Neutral included with device.
 [9] 240 Vac, 250 Vdc.
 [10] Hp rating applies only to H82454.

Double Throw Safety Switches

Table 3.47: 600 V Double Throw Safety Switches

System	Amperes	Current Series	NEMA 1	NEMA 3R	NEMA 4, 4X, 5 304 Stainless Steel	NEMA 12 Gasketed	Horsepower Ratings [11][12]								
							240 Vac		480 Vac		600 Vac		Vdc [13]		
							Std	Max	Std	Max	Std	Max	250	600	
			Cat. No.	Cat. No.	Cat. No.	Cat. No.	3Ø	3Ø	3Ø [14]	3Ø [14]	3Ø	3Ø	250	600	
Fusible 3P, 600 Vac—600 Vdc															
	30	F	DT361	DT361RB	—	—	—	—	5 [15]	15 [15]	7.5	20	5	15 [16]	
	60	F	DT362	DT362RB	—	—	—	—	15 [17]	30 [17]	15	50	—	30 [18]	
	100	F	DT363	DT363RB	—	—	—	—	25 [19]	60 [19]	30	75	—	50 [20]	
								1Ø [13]	3Ø [14]	1Ø [13]	3Ø [14]	1Ø [13]	3Ø [21]		
Non-Fusible 3P, 600 Vac—600 Vdc															
	30	F	DTU361	DTU361RB	—	—	5	10	7.5	20	10	30	5	15	
	60	F	DTU362	DTU362RB	DTU362DS	DTU362AWK[22]	10	20[23]	25	50 [24]	30	60 [25]	10	30	
	100	F	DTU363	DTU363RB	DTU363DS	DTU363AWK[22]	20	40[26]	40	75[26]	40	100 [26]	20	50	
	200	E	82344 [27]	82344RB [27]	82344DS [27]	H82344 [27]	—	—	—	15 [29]	—	—	—	—	
	400	A	82345 [30]	82345R[30]	82345DS[30]	H82345[30]	—	—	—	—	—	—	—	—	
	600	A	DTU366[30]	DTU366R[30]	—	DTU366AWK[30]	—	125	—	250	—	350	50	—	
Non-Fusible 4P, 600 Vac—600 Vdc															
	60	F	DTU462[31]	Use NEMA 12	DTU462DS [31]	DTU462AWK[22]	20	20	40	50	50	60	10	30	
	100	F	DTU463 [31]		DTU463DS [31]	DTU463AWK[22]	30	40	50	75	50	100	20	50	
	200	E	82444[30]	82444R[30]	82444DS[30]	H82444 [22][31]	—	—	—	—	—	—	—	—	
	400	A	82445[30]	82445R[30]	—	H82445[30]	—	—	—	—	—	—	—	—	
	600	A	DTU466[30]	DTU466R[30]	—	—	—	125	—	250	—	350	50	—	
	Non-Fusible 6P, 600 Vac—600 Vdc														
	60	F	—	—	—	DTU662AWK[22]	—	20	—	50	—	60	10	30	
	100	F	—	—	—	DTU663AWK[22]	—	40	—	75	—	100	20	50	

240 V Double Throw: page 3-23
 Accessories: page 3-25
 Application Data: page 3-27
 Dimensions, 30–100 A (Series F): page 3-29
 Dimensions, 30, 200–600 A (Series E, T4, A): page 3-30

[11] The starting current of motors of more than standard horsepower may require the use of fuses with appropriate time delay characteristics.
 [12] Std.—Using fast acting one time fuses. Max.—Using dual element time delay fuses. (Non-fusible switches have max rating unless noted.)
 [13] Use outer switching poles.
 [14] If used on corner grounded delta systems, install neutral and use outer switching pole for ungrounded conductors. See data bulletin 2700DB0202 for additional information.
 [15] 480 Vac 1 Phase HP = 3 Std, 7.5 Max
 [16] 10 Std, 15 Max
 [17] 480 Vac 1 Phase HP = 5 Std, 20 Max
 [18] 25 Std, 30 Max
 [19] 480 Vac 1 Phase HP = 10 Std, 30 Max
 [20] 40 Std, 50 Max
 [21] Maximum HP
 [22] Complete rating on switch is NEMA 3R, 5 or 12. For 3R applications, remove drain screw from bottom endwall.
 [23] Maximum HP is 15 for corner grounded delta systems.
 [24] Maximum HP is 30 for corner grounded delta systems.
 [25] Use 75°C #4 Cu or #2 Al conductors only on DTU362 and DTU362RB.
 [26] Use 75°C #1 Cu conductors only.
 [27] 480 Vac, 250 Vdc maximum
 [28] Not UL Listed.
 [29] Standard Hp rating.
 [30] 250 Vdc maximum.
 [31] Not suitable for use as service equipment.
 [32] 480 Vac, 250 Vdc maximum.

SAFETY SWITCHES

Accessories

Table 3.48: Electrical Interlocks (For Electrical Interlock Contact Ratings, see Supplemental Digest Section 2)

Switch	Field-Installed Electrical Interlock Kit Cat. No. [33]
30–100 A Type DT, DTU (Series F)	EIK1, EIK2[34]/[35]
200 A Type 82000 and DTU (Series E) [36]	[37]
400 A Type 82000 (Series A)	EK400DTU2
600 A Type DTU (Series A)	DS200EK2D

Table 3.49: Neutral Assembly

Switch	Field-Installed Standard Neutral Kit Cat. No.	Terminal Data AWG/kcmil	Field-Installed Copper only Neutral Kit Cat. No.	Terminal Data AWG/kcmil
30–100 A Type DT, DTU (Series F) (2- and 3-pole switches only)	SN0310	(3) 14-1/0 Al/Cu plus (2) 14-6 Al/Cu Svc Ground	SN0310C	(3) 14-1/0 Cu plus (2) 14-6 Cu Svc Ground
30 A (Series T4) (2- and 3-pole switches only)	[38]	(3) 14-4 Al/Cu plus (2) 14-4 Al/Cu Svc Ground	—	—
200 A Type 82000 (Series E) (2 and 3 pole switches only) [39]	[38]	(3) 6-300 Al/Cu plus (1) 6-2/0 Al or 10-2/0 Cu Svc Ground	—	—
200A Type DTU (Series E)	Factory Installed	(3) 4-300 Al/Cu plus (1) 4-300 Al/Cu Svc Ground	—	—
400 A Type 82000 (Series A)	DT400N	(1) 1/0 - 600 Al/Cu or (2) 1/0 - 250 Al/Cu plus (2) 6-300 Al/Cu Svc Ground	—	—
600 A Type DTU (Series A)	DT600NKD	(6) 250-500 Al/Cu plus (1) 6-250 Al/Cu Svc Ground	—	—

Table 3.50: Service Grounding Kit—Required for service equipment use

Switch	Field-Installed Service Grounding Lug Kit Cat. No.	Terminal Data AWG/kcmil
30–60 A Type DT, DTU (Series F)	Included	(3) 14-2 Al/Cu or (6) 14-10 Al/Cu
100 A Type DT, DTU (Series F)	Included	(3) 14 - 1/0 Al/Cu
30 A Type 92,000 (Series T4)	DT30SG	(4) 14-4 Al/Cu
200 A Type 82000 and DTU (Series E)	DT100SG	(3) 14–1/0 Al/Cu
400 A Type 82000 (series A)	PKOGTA2 (2 required)	(4) 10–2/0 Cu or (4) 6–2/0 Al
600 A Type DTU (Series A)	DS468GKD	(2) 6–250 Al/Cu [40]

Table 3.51: Class R Fuse Kits

When properly installed, this kit rejects all but Class R fuses. Kits are available for field installation. For factory installation add suffix CLR to the switch catalog number.

Switch	Series Number	Class R Fuse Kit Cat. No.
Class R Fuse Kits—240 V (two kits per 3P switch)		
30 A	F5	RFK03
60 A	F5	RFK06
100 A	F5	RFK10
Class R Fuse Kits—600 V (two kits per 3P switch)		
30 A	F5	RFK06
60 A	F5	RFK06H
100 A	F5	RFK10

Viewing Windows: Accessory available on 30–100 A DTU switches only. Add the suffix VW to the catalog number.

Key Interlock Systems: For factory-installed key interlocks, refer to page 3-16.

Phenolic Legend Plate: For factory-installed phenolic legend plates, refer to Supplemental Digest section 2.

Lock-ON Provisions: Standard feature on 30–100 A type DT and DTU (Series F), 82,000 (400 A only) and type 92,000 switches.

Feature available as factory installed option for Type 82,000 (200 A only) and 200 A DTU (Series E) switches. Add the suffix SPLO to the catalog number.

[33] Electrical interlock kit catalog numbers with “1” suffix indicate one normally open and normally closed contact; “2” indicates two normally open and two normally closed contacts. See Table 3.29 Electrical Interlock Kit, page 3-14 for electrical interlock ratings.

[34] 30–100 A Type DT, DTU (Series F) switches contain (2) separate switching mechanisms. Each mechanism will accept an electrical interlock. Some applications may therefore require (2) electrical interlocks.

[35] Double throw switches 92251, 92351, and 92451 are not available with factory or field installed electrical interlocks.

[36] Electrical interlock EK400DTU2 can be added to 200 A, 4-pole Type 82000 switches in the field.

[37] Type 82000 and DTU switches are available with electrical interlock factory-installed only. Not UL listed. Electrical interlocks are furnished with 2 N.O./N.C. contacts and are installed in both “ON” positions. To order, add suffix EI to standard switch catalog number.

[38] For 200 A Type 82000 and 30 A Type 92000 switches, a neutral assembly is available factory installed on 2P and 3P switches. Not UL Listed. To order, add suffix N to the standard catalog number. Terminated data = (3) 4 - 250 Al / Cu plug, (1) 4 - 250 Al / Cu SVC ground.

[39] Neutral assembly catalog number DT200N can be added to 4P, 200 A, Type 82000 switches in the field.

[40] (3) 6-250 ground lugs are provided as standard. DS468GKD provides an additional (2) 6-250 ground lugs.

Rainproof Bolt-On Hubs



- UL Listed for indoor or rainproof applications
- Suitable for use with conduit having ANSI standard taper pipe thread
- Type 3R switches with catalog number ending in RB have a bolt-on closing cap factory installed
 - Accepts 3/4 in. through 2-1/2 in. bolt-on hubs
 - No gaskets required
- Type 3R switches with R suffix have blank top endwalls
 - Accepts 3 in. through 4 in. bolt on hubs
 - Gaskets provided
 - Conduit entry holes must be cut in the field

Table 3.52: Rainproof Bolt-On Hubs [41]

Conduit Size	3/4	1	1-1/4	1-1/2	2	2-1/2	3	3-1/2	4	Closing Cap
Hub Cat. No.	B075	B100	B125	B150	B200	B250	B300	B350	B400	BCAP

Watertight Hubs



Watertight Hubs

- UL Listed for dusttight and watertight applications
- Suitable for use with conduit having ANSI standard taper pipe thread
- Watertight hubs are field installed on Type 4/4X/5 stainless steel and Type 12/3R and 12K enclosures
- Watertight hubs are available in zinc or chrome plated finish
- Gaskets provided

Table 3.53: Watertight Hubs [42]

Conduit Size	1/2	3/4	1	1-1/4	1-1/2	2	2-1/2	3	3-1/2	4
Standard-Zinc Hub Cat. No.	H050	H075	H100	H125	H150	H200	H250	H300	H350	H400
Chrome Plated Hub Cat. No.	H050CP	H075CP	H100CP	H125CP	H150CP	H200CP	—	—	—	—

240 V Double Throw: [page 3-23](#)
 600 V Double Throw: [page 3-24](#)
 Application Data: [page 3-27](#)
 Dimensions, 30–100 A (Series F): [page 3-29](#)
 Dimensions, 30, 200–600 A (Series E, T4, A): [page 3-30](#)

[41] Gaskets are provided on 3 in. and larger hubs.

[42] Gaskets are provided.

Application Data for Double Throw Safety Switches
Situations Requiring Fuses

30–100 A Type DT (Series F):

Select DT switches from 240 Volt Double-Throw Safety Switches, page 3-23 and 600 Volt Double Throw Safety Switches, page 3-24 which have provisions for accepting fuses.

30 A, 200–600 A Type 82,000 (Series E, T4, A), all DTU devices:

Use the non-fusible double throw switches from 240 Volt Double-Throw Safety Switches, page 3-23 and 600 Volt Double Throw Safety Switches, page 3-24 in conjunction with standard fusible devices, and install them according to diagram 1 or 2, below.

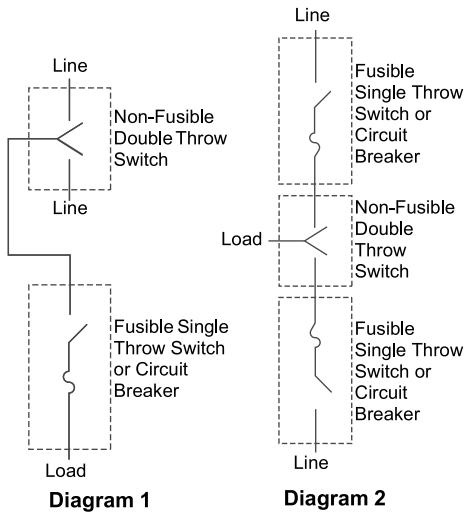

Table 3.54: UL Listed Short Circuit Current Ratings

Switch Type	Amperes	Voltage Rating	UL Listed Fuse Class	Short Circuit Current Rating [43] (A)
Type 92000	30 A	240 V	H, K	10,000 [44]
Type DT (Series F)	30–100 A	240 V or 600 V	H, K	10,000
			R, J	200,000
Type DTU [45] (Series F)	30–100 A	240 V or 600 V	H or K	10,000 [44]
			R, J or T	200,000
DTU224NRB and DTU324NRB (Series E)	200 A	240 V	H, K	10,000 [46]
DTU324N (Series E)	200 A	240 V	H, K	10,000 [46]
			R, J	100,000
Type 82,000	all	240 V	H, K	10,000 [46]
		600 V	R, J	100,000 [47]
Type DTU (A series)	600 A	240 V or 600 V	H, K	10,000
			R, J, T	100,000

[43] Rating applies to AC only. The UL Listed short circuit current rating for non-fusible switches is based on the switch being used in conjunction with the corresponding fuse type. Evaluation of non-fusible switches in conjunction with molded case circuit breakers has not been performed.

[44] Any brand of circuit breaker or fuse not exceeding the ampere rating of the switch may be used ahead of a non-fusible safety switch when there is up to 10 kA short circuit current available.

[45] The DTU361 and DTU361RB are also suitable for use on a circuit capable of delivering not more than (A) 18 kA, 600 Vac maximum when protected by Type FH circuit breaker rated 30 A maximum or (B) 14 kA, 600 Vac maximum when protected by Type FA circuit breaker rated 30 A maximum.

[46] Any brand of circuit breaker or fuse not exceeding the ampere rating of the switch may be used ahead of a non-fusible safety switch when there is up to 10 kA short circuit current available.

[47] 400 A 82,000 switch is only 10 kA.

Terminal Lug Data

Table 3.55: Terminal Lug Data for Type DT, DTU (Series F) Double Throw Safety Switches [48]

Switch Type	Wires per Phase	NEMA 1, 3R, 4, 4X, 12			Optional Copper Only Lug
		Wire Range Wire Bending Space Per NEC Table 373-6 AWG/kcmil	Standard Lug Wire Range AWG/kcmil	Optional Compression Lug Field-Installed	
30-60 A Type DT, DTU (Series F)	1	12-2 Al or 14-2 Cu	12-2 Al or 14-2 Cu	C10-14, D8-14-SK, or E6-14 [49]	See Table 3.39 Copper Lug Kits, page 3-17 and Double Lug Kits, page 3-18 for appropriate kit. Order two kits per switch.
100 A Type DT, DTU (Series F)	1	12-1/0 Al or 14-1/0 Cu	12-1/0 Al or 14-1/0 Cu	VCEL02114S1[50]	

Table 3.56: Terminal Lug Data for Types 82,000 and for A and E-Series DTU devices [48]

Amperes	Wires per Phase	Wire Range Wire Bending Space Per NEC Table 373-6 AWG/kcmil	Lug Wire Range AWG/kcmil	Optional Compression Lugs Field-Installed
30 A (Series T4)	1	14-8 Al/Cu	12-2 Al or 14-2 Cu	—
200	1	6-300 Al/Cu	6-300 Al/Cu	VCEL030516H1[50]
400	1	1/0-600 Al/Cu	1/0 - 750 Al/Cu	—
	2	1/0-300 Al/Cu	1/0 - 300 Al/Cu	
600	2	250-500 Al/Cu	250-500 Al/Cu	—

240 V Double Throw: page 3-23
 600 V Double Throw: page 3-24
 Accessories: page 3-25
 Dimensions, 30-100 A (Series F): page 3-29
 Dimensions, 30, 200-600 A (Series E, T4, A): page 3-30

[48] 30-100 A switches suitable for 60° C or 75° C conductors. 200-600 A switches suitable for 75° C conductors.
 [49] Order from Thomas and Betts
 [50] Hubbell Versa-Crimp™ catalog numbers.

Series F Devices 30–100 A

Table 3.57: 30–100 A Type DT, DTU (Series F)—Approximate Dimensions

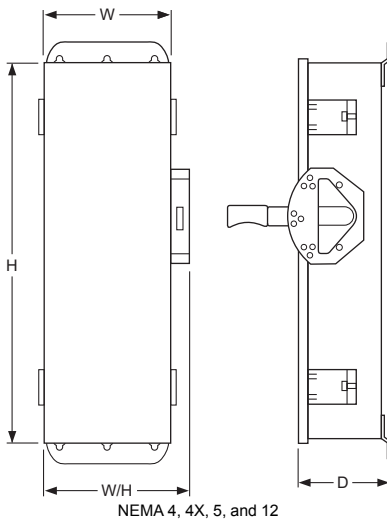
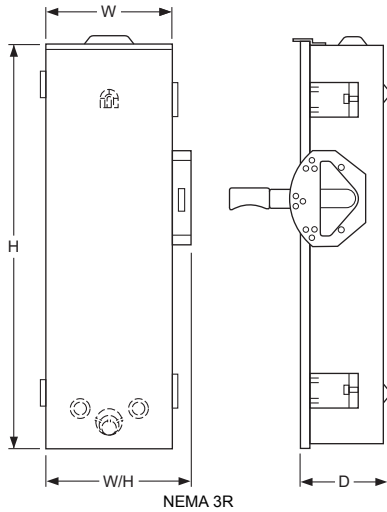
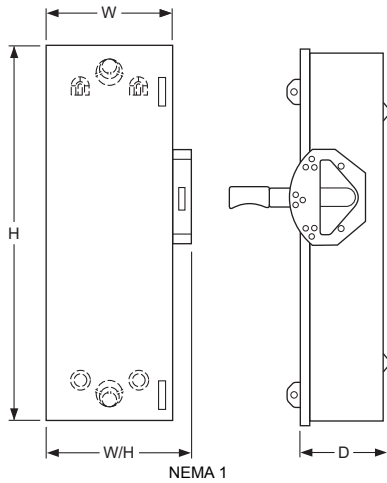

Cat. No.	Series	H		W		W/H		D	
		in.	mm	in.	mm	in.	mm	in.	mm
DT223	F5	38.00	965	9.88	251	11.13	283	6.75	171
DT223RB	F5	38.00	965	6.87	174	8.12	206	6.60	168
DT321	F5	38.00	965	10.25	260	11.50	292	6.75	171
DT321RB	F5	38.00	965	10.25	260	11.80	300	6.60	168
DT322	F5	38.00	965	10.25	260	11.50	292	6.75	171
DT322RB	F5	38.00	965	10.25	260	11.80	300	6.60	168
DT323	F5	38.00	965	9.88	251	11.13	283	6.75	171
DT323RB	F5	38.00	965	6.87	174	8.12	206	6.60	168
DT361	F5	38.00	965	10.25	260	11.50	292	6.75	171
DT361RB	F5	38.00	965	10.25	260	11.80	300	6.60	168
DT362	F5	38.00	965	10.25	260	11.50	292	6.75	171
DT362RB	F5	38.00	965	10.25	260	11.80	300	6.60	168
DT363	F5	38.00	965	9.88	251	11.13	283	6.75	171
DT363RB	F5	38.00	965	6.87	174	8.12	206	6.60	168
DTU222	F5	29.94	760	10.25	260	11.96	304	6.93	176
DTU223	F5	29.94	760	10.25	260	11.96	304	6.93	176
DTU223RB	F5	30.50	775	10.25	260	11.96	304	6.93	176
DTU321	F5	29.94	760	10.25	260	11.96	304	6.93	176
DTU322	F5	29.94	760	10.25	260	11.96	304	6.93	176
DTU323	F5	29.94	760	10.25	260	11.96	304	6.93	176
DTU323RB	F5	30.50	775	10.25	260	11.96	304	6.93	176
DTU361	F5	29.94	760	10.25	260	11.96	304	6.93	176
DTU361RB	F5	30.50	775	10.25	260	11.96	304	6.93	176
DTU362	F5	29.94	760	10.25	260	11.96	304	6.93	176
DTU362AWK	F6	29.94	760	10.25	260	11.96	304	6.93	176
DTU362DS	F6	30.26	769	10.25	260	11.50	292	7.12	181
DTU362RB	F5	30.50	775	10.25	260	11.96	304	6.93	176
DTU363	F5	29.94	760	10.25	260	11.96	304	6.93	176
DTU363AWK	F6	29.94	760	10.25	260	11.96	304	6.93	176
DTU363DS	F6	30.26	769	10.25	260	11.50	292	7.12	181
DTU363RB	F5	30.50	775	10.25	260	11.96	304	6.93	176
DTU462	F5	29.94	760	10.25	260	11.96	304	6.93	176
DTU462AWK	F6	30.26	769	15.50	394	16.75	425	7.12	181
DTU462DS	F6	30.26	769	15.50	394	16.75	425	7.12	181
DTU463	F5	29.94	760	10.25	260	11.96	304	6.93	176
DTU463AWK	F6	30.26	769	15.50	394	16.75	425	7.12	181
DTU463DS	F6	30.26	769	15.50	394	16.75	425	7.12	181
DTU662AWK	F6	30.26	769	15.50	394	16.75	425	7.12	181
DTU663AWK	F6	30.26	769	15.50	394	16.75	425	7.12	181

240 V Double Throw: [page 3-23](#)
 600 V Double Throw: [page 3-24](#)
 Accessories: [page 3-25](#)
 Application Data: [page 3-27](#)
 Dimensions, 30, 200–600 A (Series E, T4, A): [page 3-30](#)

Series A, E, and T4 Devices

Table 3.58: 200–600 A Types 82,000 and E-Series DTU and 30 A devices—
Approximate Dimensions

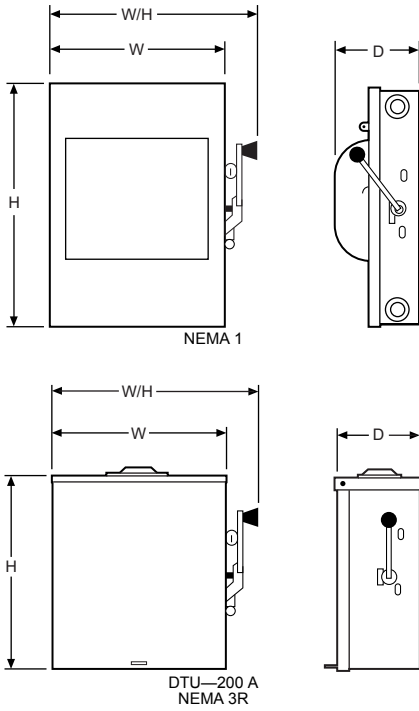

Cat. No.	Series	H		W		W/H		D	
		in.	mm	in.	mm	in.	mm	in.	mm
DTU224NRB	E1	32.50	826	20.63	524	24.00	610	10.63	270
82254	E1	30.88	784	15.75	400	19.63	499	9.75	248
82254NW	E1	30.88	784	20.00	508	23.88	607	11.75	298
82344	E2	30.88	784	20.00	508	23.88	607	11.75	298
82344RB	E1	32.50	826	20.63	524	24.00	610	10.63	270
82354	E1	30.88	784	20.00	508	23.88	607	11.75	298
92251	T4	10.00	254	8.00	203	9.75	248	4.75	121
82344DS	E1	30.88	784	20.00	508	23.88	607	11.75	298
DTU324N	E1	32.50	826	24.50	622	26.25	667	10.63	270
DTU324NRB	E1	32.50	826	24.50	622	26.25	667	10.63	270
H82344	E2	32.50	826	24.50	622	26.25	667	10.63	270
H82444	E2	32.50	826	30.21	767	33.61	854	10.63	270
H82454	E3	32.50	826	30.21	767	33.61	854	10.63	270
82454	E3	38.00	965	29.62	753	33.02	839	10.63	270
82444	E3	38.00	965	29.62	753	33.02	839	10.63	270
82454R	E3	38.00	965	29.62	753	33.02	839	10.63	270
82444R	E3	38.00	965	29.62	753	33.02	839	10.63	270
H82254	E3	32.50	826	24.50	622	26.25	667	10.63	270
H82354	E3	32.50	826	24.50	622	26.25	667	10.63	270
82444DS	E3	38.00	965	29.62	753	33.02	839	10.63	270
82255	A1	38.50	978	26.10	663	29.51	750	10.63	270
82255R	A1	39.00	991	26.62	676	30.02	763	10.63	270
82345	A1	38.50	978	26.10	663	29.51	750	10.63	270
82345DS	A1	39.00	991	26.62	676	30.02	763	10.63	270
82345R	A1	39.00	991	26.62	676	30.02	763	10.63	270
82355	A1	38.50	978	26.10	663	29.51	750	10.63	270
82355R	A1	39.00	991	26.62	676	30.02	763	10.63	270
82445	A1	38.50	978	30.10	765	33.50	851	10.63	270
82445R	A1	39.00	991	30.21	767	33.61	854	10.63	270
82455	A1	38.50	978	30.10	765	33.50	851	10.63	270
82455R	A1	39.00	991	30.21	767	33.61	854	10.63	270
H82255	A1	39.00	991	26.62	676	30.02	763	10.63	270
H82345	A1	39.00	991	26.62	676	30.02	763	10.63	270
H82355	A1	39.00	991	26.62	676	30.02	763	10.63	270
H82445	A1	39.00	991	30.21	767	33.61	854	10.63	270
H82455	A1	39.00	991	30.21	767	33.61	854	10.63	270
DTU326R	A1	63.76	1619	23.66	601	24.46	621	8.88	226
DTU426R	A1	63.76	1619	27.00	686	27.80	706	8.88	226
DTU366R	A1	63.76	1619	23.66	601	24.46	621	8.88	226
DTU466R	A1	63.76	1619	27.00	686	27.80	706	8.88	226
DTU366AWK	A1	63.76	1619	23.66	601	24.46	621	8.88	226

240 V Double Throw: page 3-23
 600 V Double Throw: page 3-24
 Accessories: page 3-25
 Application Data: page 3-27
 Dimensions, 30–100 A (Series F): page 3-29



1000 Vdc Photovoltaic Heavy Duty Disconnect Switch

Put over 100 years of Schneider Electric's experience as a global specialist in energy management to work on your photovoltaic (PV) project. The Square D 1000 Vdc disconnect switch is the perfect solution for your 1000 Vdc, PV disconnect applications. It is compact and available in both a 100 and 200 amp non-fusible versions. IEC 60947-1 and UL 98 certified (file E343341).

Extended Life Expectancy

- Exceeds IEC 60947-3 mechanical endurance requirements by factor of 18
- Exceeds IEC 60947-1 electrical endurance requirements by factor of 10
- Exceeds NEMA KS-1 mechanical endurance requirements by factor of 3.

Designed for Harsh PV Environments

- NEMA Type 3 and IP63 enclosure
- Resists windblown dirt/dust
- Exceeds NEMA Type 1, 3R and 12
- Operating range of -37°C to 50°C
- Specially designed PV paint reduces solar gain up to 35% over standard grey enclosures

Easy to Install

- Preconfigured solar solution
- Familiar enclosed safety switch design
- Suitable for both grounded and ungrounded PV

Table 3.59: 1000 Vdc Photovoltaic Heavy Duty Disconnect Switch Accessories [1]

System	NEMA 1, 3R, 12, 3 and IP63		Factory Installed Accessories							Height (in.)	Width (in.)	Depth (in.)
			Electrical Interlock Single Contact [2]	Electrical Interlock Two Contacts [3]	Viewing Windows	Terminal Blocks (Copper) [4]	3 Wire Ground Lug [5]	No. Suffix	No. Suffix			
	Amperes	Cat. No.	No. Suffix	No. Suffix	No. Suffix	No. Suffix	No. Suffix					
3 Pole Grounded [6]												
	100	REHU393IP	EI	EI2	VW	TBC	GL	22.13	18.63	8.75		
	200	REHU394IP	EI	EI2	VW	TBC	GL	22.13	18.63	8.75		
4 Pole Ungrounded												
	100	REHU493IP	EI	EI2	VW	—	GL	29.00	18.63	8.75		
	200	REHU494IP	EI	EI2	VW	—	GL	29.00	18.63	8.75		

[1] Kit consist of 3 line and 3 load and 2 neutral lugs as required for a 3 pole 400A or 600A General Duty Switch.
 [2] Order EIK1PV for single contact field-installed kit.
 [3] Order EIK2PV for double contact field-installed kit.
 [4] Accommodates (2) 250 max Cu or (1) 1/0 max Cu wiring; Order SN20CPV for field-installed kit.
 [5] Order REHGND KIT for field installable kit.
 [6] Terminal blocks standard with 3 pole switches; accommodates (2) 1/0 max Al/Cu or (2) 6 max Al/Cu wiring.

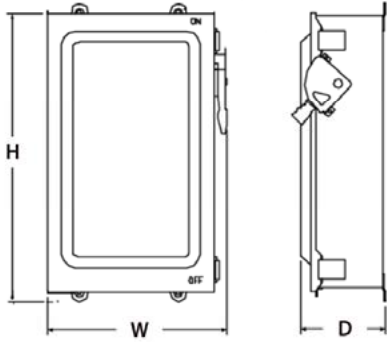

200 A Enclosed Switch Dimensions (inches)

Table 3.60: 200 A Enclosed Switch—Approximate Dimensions

Switch	H		W		D	
	in.	mm	in.	mm	in.	mm
100 A	21.75	552	18.86	479	8.75	197
200 A	29.00	737	18.86	479	8.75	197