

# Section 21



## Terminal Blocks



|  |              |
|--|--------------|
| <b>Selection Guide</b>   | <b>21-1</b>  |
| Terminal Block Selection Guide   | 21-1         |
| <b>IEC Style Terminal Blocks</b>                                       | <b>21-3</b>  |
| Spring Terminal Blocks   | 21-3         |
| Passthrough  | 21-3         |
| Grounding  | 21-4         |
| Double and Triple Deck, Grounding, Component Carriers, Blade Isolators | 21-5         |
| Miniature Spring Passthrough and Grounding                             | 21-6         |
| Screw Terminal Blocks  | 21-7         |
| Passthrough and Grounding  | 21-7         |
| Lug/Lug, Double and Triple Deck Passthrough, Grounding                 | 21-9         |
| Blade Isolators, Component Carriers, Fused, Measuring, Grounding       | 21-10        |
| Miniature Passthrough and Hybrid Passthrough                           | 21-11        |
| Push-in Terminal Blocks  | 21-12        |
| Passthrough and Grounding  | 21-13        |
| Double Deck Passthrough, Blade Isolators, Component Carriers           | 21-15        |
| Accessories  | 21-16        |
| Linergy Marking Accessories  | 21-16        |
| Linergy Labeling System  | 21-17        |
| Mounting Track and End Clamps  | 21-18        |
| <b>NEMA Style Terminal Blocks</b>                                      | <b>21-19</b> |
| Type G Terminal Blocks   | 21-19        |
| Selection Guide  | 21-19        |
| Terminal Block Assemblies  | 21-21        |
| Type G Terminal Block Accessories                                      | 21-22        |
| Mounting Track, End Clamps, Jumpers, Fanning Strips                    | 21-22        |
| Marking Accessories  | 21-23        |
| <b>Thermal-Magnetic Circuit Protectors</b>                             | <b>21-24</b> |
| Type GCB Circuit Protectors  | 21-24        |
| Type GB2 Circuit Protectors  | 21-25        |
| <b>Power Distribution Blocks</b>                                       | <b>21-26</b> |
| IEC NSYEB Power Distribution Blocks                                    | 21-26        |
| Enclosed Power Distribution Blocks                                     | 21-26        |
| NEMA Type LB Power Distribution Blocks                                 | 21-27        |
| LB Open Power Distribution Blocks                                      | 21-27        |
| <b>Fuseholders</b>   | <b>21-28</b> |
| Type FB Fuseholders  | 21-28        |
| TeSys DF Fuseholders   | 21-29        |
| <b>Cable Ends</b>  | <b>21-30</b> |
| DZ5 and AZ5 Cable Ends   | 21-30        |
| AR1 and AT1 Cable End Accessories                                      | 21-31        |
| <b>Advantys Telefast ABE 7 Pre-Wired System</b>                        | <b>21-32</b> |
| Prewired Connection System   | 21-32        |
| Telefast ABE 7 Pre-Wired Sub-Bases                                     | 21-32        |

Terminal Block Panorama

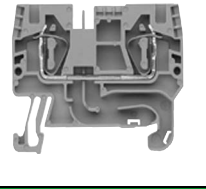
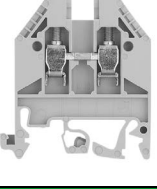
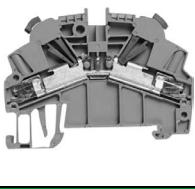
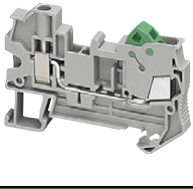
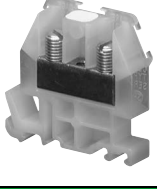









Table 21.1: Product Panorama

|                                  |                                  |  |  |  |    |
|----------------------------------|---|---|--|---|---|
| Product Family                   | NSYTRV  | NSYTRR  | NSYTRP   | NSYTRH  | 9080G   |
| Type of product                  | IEC screw technology  | IEC spring technology   | IEC push-in technology   | IEC hybrid (screw and insulation displacement connection)                           | NEMA screw technology   |
| Mounting                         | DIN 3   | DIN 3   | DIN 3  | DIN 3   | DIN 3 and Square D track [1]  |
| Maximum rated voltage (V)        | 600   | 600   | 600  | 600   | 600 [2]   |
| Maximum rated current per UL (A) | 285   | 85  | 30   | 15  | 255   |
| Ambient air temperature          | -40 to +266 °F (-40 to 130 °C)  |   |  |   |   |
| Approvals[3]                     |  UL File E87739<br>CCN XCFR2     | UL File E87739<br>CCN XCFR2   | UL File E87729<br>CCN XCFR2  | UL File E87729<br>CCN XCFR2   | UL File E60616<br>CCN XCFR2   |
|                                  |  CSA File 25644<br>Class 6228-01 | CSA File 25644<br>Class 6228-01   | CSA File 25644<br>Class 6228-01  | CSA File 25644<br>Class 6228-01   | CSA File 256444<br>Class 6228-01  |
| Color                            | Gray<br>Blue<br>Orange<br>Red<br>Green<br>White<br>Black<br>Yellow<br>Brown<br>Green/Yellow                       | Gray<br>Blue<br>Orange<br>Green/Yellow  | Gray<br>Blue<br>Orange<br>Green/Yellow   | Gray<br>Green/Yellow  | Natural (White)<br>Black<br>Blue<br>Green<br>Gray<br>Orange<br>Red<br>Yellow<br>Brown |
| Conforming to Standards          | RoHS<br>CE  | RoHS<br>CE  | RoHS<br>CE   | RoHS<br>CE  | RoHS<br>CE  |

[1] 9080GK6 can be mounted directly to a panel or on Square D track.  
[2] 9080GT6 is 120 V.  
[3] Refer to catalogs 9080CT1301 and 9080CT9601 for a complete list of certifications.

**Passthrough**

**Table 21.2: Spring Passthrough Blocks [1]**

| Description   | Maximum Voltage | Maximum Current | Block  |                |              | End Barrier[2] |                |              |
|---|-----------------|-----------------|--------|----------------|--------------|----------------|----------------|--------------|
|   |                 |                 | Color  | Catalog Number | Std. Pack[3] | Color          | Catalog Number | Std. Pack[3] |
| <br>5.2 mm (0.21 in.) wide<br>Two Terminals<br>Solid or Stranded Copper Wire<br>28–12 AWG    | 600 V           | 20 A            | Grey   | NSYTRR22       | 50           | Grey           | NSYTRACR22     | 50           |
|   |                 |                 | Blue   | NSYTRR22BL     |              | Blue           | NSYTRACR22BL   |              |
|   |                 |                 | Orange | NSYTRR22AR     |              | Grey           | NSYTRACR22     |              |
| <br>5.2 mm (0.21 in.) wide<br>Three Terminals<br>Solid or Stranded Copper Wire<br>28–12 AWG  | 600 V           | 20 A            | Grey   | NSYTRR23       | 50           | Grey           | NSYTRACR23     | 50           |
|   |                 |                 | Blue   | NSYTRR23BL     |              | Blue           | NSYTRACR23BL   |              |
|   |                 |                 | Orange | NSYTRR23AR     |              | Grey           | NSYTRACR23     |              |
| <br>5.2 mm (0.21 in.) wide<br>Four Terminals<br>Solid or Stranded Copper Wire<br>28–12 AWG   | 600 V           | 20 A            | Grey   | NSYTRR24       | 50           | Grey           | NSYTRACR24     | 50           |
|   |                 |                 | Blue   | NSYTRR24BL     |              | Blue           | NSYTRACR24BL   |              |
|   |                 |                 | Orange | NSYTRR24AR     |              | Grey           | NSYTRACR24     |              |
| <br>6.2 mm (0.24 in.) wide<br>Two Terminals<br>Solid or Stranded Copper Wire<br>28–10 AWG    | 600 V           | 30 A            | Grey   | NSYTRR42       | 50           | Grey           | NSYTRACR42     | 50           |
|   |                 |                 | Blue   | NSYTRR42BL     |              | Grey           | NSYTRACR42     |              |
|   |                 |                 | Orange | NSYTRR42AR     |              | Grey           | NSYTRACR42     |              |
| <br>6.2 mm (0.24 in.) wide<br>Three Terminals<br>Solid or Stranded Copper Wire<br>28–10 AWG  | 600 V           | 30 A            | Grey   | NSYTRR43       | 50           | Grey           | NSYTRACR43     | 50           |
|   |                 |                 | Blue   | NSYTRR43BL     |              | Grey           | NSYTRACR43     |              |
| <br>6.2 mm (0.24 in.) wide<br>Four Terminals<br>Solid or Stranded Copper Wire<br>28–10 AWG | 600 V           | 30 A            | Grey   | NSYTRR44       | 50           | Grey           | NSYTRACR44     | 50           |
|   |                 |                 | Blue   | NSYTRR44BL     |              | Grey           | NSYTRACR44     |              |
| <br>8.2 mm (0.32 in.) wide<br>Two Terminals<br>Solid or Stranded Copper Wire<br>28–8 AWG   | 600 V           | 50 A            | Grey   | NSYTRR62       | 50           | Grey           | NSYTRACR62     | 50           |
|   |                 |                 | Blue   | NSYTRR62BL     |              | Grey           | NSYTRACR62     |              |
| <br>8.2 mm (0.32 in.) wide<br>Three Terminals<br>Solid or Stranded Copper Wire<br>24–8 AWG | 600 V           | 50 A            | Grey   | NSYTRR63       | 50           | Grey           | NSYTRACR63     | 50           |
| <br>10.2 mm (0.40 in.) wide<br>Two Terminals<br>Solid or Stranded Copper Wire<br>16–6 AWG  | 600 V           | 66 A            | Grey   | NSYTRR102      | 50           | Grey           | NSYTRACRR102   | 50           |
|   |                 |                 | Blue   | NSYTRR102BL    |              | Grey           | NSYTRACRR102   |              |
| <br>12.2 mm (0.48 in.) wide<br>Two Terminals<br>Solid or Stranded Copper Wire<br>16–4 AWG  | 600 V           | 85 A            | Grey   | NSYTRR162      | 50           | Grey           | NSYTRACR162    | 50           |
|   |                 |                 | Blue   | NSYTRR162BL    |              | Grey           | NSYTRACR162    |              |

**NOTE:** For a complete listing of these products, see [Linergy TR Terminal Blocks](#) online or catalog **9080CT1301**.



File:  
E87739  
CCN:  
XCFR2



File:  
256444  
Class:  
6228-01



RoHS  
Compliant

For track and accessories, see [Mounting Track and End Clamps](#), page 21-18.

[1] Some products may be discontinued. Refer to [www.se.com/us](#) for the most current product information.  
 [2] One end-barrier is required for each assembly of like blocks.  
 [3] Orders must specify the standard package quantity (Std. Pack) or multiples of that quantity.

## Grounding

Table 21.3: Spring Grounding Blocks [4]

| Description  | Block          |                |               | End Barrier [5] |                |               |
|--|----------------|----------------|---------------|-----------------|----------------|---------------|
|  | Color          | Catalog Number | Std. Pack [6] | Color           | Catalog Number | Std. Pack [6] |
| <br>Grounding Block<br>Two Terminals<br>Solid or Stranded Copper Wire<br>28–12 AWG<br>5.2 mm (0.21 in.) wide    | Green / Yellow | NSYTRR22PE     | 50            | Grey            | NSYTRACR22     | 50            |
| <br>Grounding Block<br>Three Terminals<br>Solid or Stranded Copper Wire<br>28–12 AWG<br>5.2 mm (0.21 in.) wide  | Green / Yellow | NSYTRR23PE     | 50            | Grey            | NSYTRACR23     | 50            |
| <br>Grounding Block<br>Four Terminals<br>Solid or Stranded Copper Wire<br>28–12 AWG<br>5.2 mm (0.21 in.) wide   | Green / Yellow | NSYTRR24PE     | 50            | Grey            | NSYTRACR24     | 50            |
| <br>Grounding Block<br>Two Terminals<br>Solid or Stranded Copper Wire<br>28–10 AWG<br>6.2 mm (0.24 in.) wide    | Green / Yellow | NSYTRR42PE     | 50            | Grey            | NSYTRACR42     | 50            |
| <br>Grounding Block<br>Three Terminals<br>Solid or Stranded Copper Wire<br>28–10 AWG<br>6.2 mm (0.24 in.) wide | Green / Yellow | NSYTRR43PE     | 50            | Grey            | NSYTRACR43     | 50            |
| <br>Grounding Block<br>Four Terminals<br>Solid or Stranded Copper Wire<br>28–10 AWG<br>6.2 mm (0.24 in.) wide | Green / Yellow | NSYTRR44PE     | 50            | Grey            | NSYTRACR44     | 50            |
| <br>Grounding Block<br>Two Terminals<br>Solid or Stranded Copper Wire<br>24–8 AWG<br>8.2 mm (0.32 in.) wide   | Green / Yellow | NSYTRR62PE     | 50            | Grey            | NSYTRACR62     | 50            |
| <br>Grounding Block<br>Two Terminals<br>Solid or Stranded Copper Wire<br>16–6 AWG<br>10.2 mm (0.40 in.) wide  | Green / Yellow | NSYTRR102PE    | 50            | Grey            | NSYTRACR102    | 50            |
| <br>Grounding Block<br>Two Terminals<br>Solid or Stranded Copper Wire<br>16–4 AWG<br>12.2 mm (0.48 in.) wide  | Green / Yellow | NSYTRR162PE    | 50            | Grey            | NSYTRACR162    | 10            |

**NOTE:** For a complete listing of these products, see [Linergy TR Terminal Blocks](#) online or catalog 9080CT1301.



File:  
E87739  
CCN:  
XCFR2



File:  
256444  
Class:  
6228-01



RoHS  
Compliant

For track and accessories, see [Mounting Track and End Clamps](#), page 21-18.



[4] Some products may be discontinued. Refer to [www.se.com/us](#) for the most current product information.

[5] One end-barrier is required for each assembly of like blocks.

[6] Orders must specify the standard package quantity (Std. Pack) or multiples of that quantity.

**Double and Triple Deck, Grounding, Component Carriers, Blade Isolators**

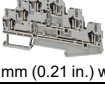

**Table 21.4: Spring Double and Triple Deck Passthrough [7]**

| Description   | Max. Voltage | Max. Current [8] | Block |                |                | End Barrier [9] |                |                |
|---|--------------|------------------|-------|----------------|----------------|-----------------|----------------|----------------|
|   |              |                  | Color | Catalog Number | Std. Pack [10] | Color           | Catalog Number | Std. Pack [10] |
| <br>5.2 mm (0.21 in.) wide | 600 V        | 20 A             | Grey  | NSYTRR24D      | 50             | Grey            | NSYTRACRE24    | 50             |
|   |              |                  | Blue  | NSYTRR24DBL    |                | Grey            | NSYTRACRE24    |                |
| <br>6.2 mm (0.24 in.) wide | 600 V        | 30 A             | Grey  | NSYTRR44D      | 50             | Grey            | NSYTRACRE44    | 50             |
|   |              |                  | Blue  | NSYTRR44DBL    |                | Grey            | NSYTRACRE44    |                |
| <br>5.2 mm (0.21 in.) wide | 600 V        | 20 A             | Grey  | NSYTRR26T      | 50             | Grey            | NSYTRACRE26    | 50             |
|   |              |                  | Blue  | NSYTRR26TBL    |                | Grey            | NSYTRACRE26    |                |

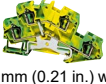
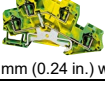
**Table 21.5: Spring Grounding Double Deck [7]**

| Description   | Block        |                |                | End Barrier [9] |                |                |
|---|--------------|----------------|----------------|-----------------|----------------|----------------|
|   | Color        | Catalog Number | Std. Pack [10] | Color           | Catalog Number | Std. Pack [10] |
| <br>5.2 mm (0.21 in.) wide | Green/Yellow | NSYTRR24DPE    | 50             | Grey            | NSYTRACRE24    | 50             |
| <br>6.2 mm (0.24 in.) wide | Green/Yellow | NSYTRR44DPE    | 50             | Grey            | NSYTRACRE44    | 50             |

**Table 21.6: Spring Component Carriers [7]**

| Description   | Max. Voltage | Max. Current [8] | Color | Catalog Number                | Std. Pack [10] | End Barrier [9] |                |                |              |    |
|---|--------------|------------------|-------|-------------------------------|----------------|-----------------|----------------|----------------|--------------|----|
|   |              |                  |       |                               |                | Color           | Catalog Number | Std. Pack [10] |              |    |
| <br>5.2 mm (0.21 in.) wide | 300 V        | 16 A             | Grey  | NSYTRR22TB                    | 50             | Grey            | NSYTRACR23     | 50             |              |    |
|   |              |                  |       | Depends on fuse or diode used | Black          |                 |                |                | NSYTRASF520  | 10 |
|   |              |                  |       |                               | Black          |                 |                |                | NSYTRASF520M | 10 |
|   |              |                  |       |                               | Black          |                 |                |                | NSYTRASF520B | 10 |
|   |              |                  |       | Grey                          | NSYTRASV1      |                 |                |                | 10           |    |
|   |              |                  |       | Grey                          | NSYTRASV2      |                 |                |                | 10           |    |
| <br>5.2 mm (0.21 in.) wide | 300 V        | 16 A             | Grey  | NSYTRR23TB                    | 50             | Grey            | NSYTRACR24     | 50             |              |    |
|   |              |                  |       | Depends on fuse or diode used | Black          |                 |                |                | NSYTRASF520  | 10 |
|   |              |                  |       |                               | Black          |                 |                |                | NSYTRASF520M | 10 |
|   |              |                  |       |                               | Black          |                 |                |                | NSYTRASF520B | 10 |
|   |              |                  |       | Grey                          | NSYTRASV1      |                 |                |                | 10           |    |
|   |              |                  |       | Grey                          | NSYTRASV2      |                 |                |                | 10           |    |

**Table 21.7: Spring Blade Isolators [7]**

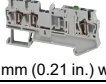
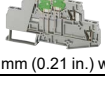
| Description   | Max. Voltage | Max. Current [8] | Block  |                |                | End Barrier [9]              |                |                |
|---|--------------|------------------|--------|----------------|----------------|------------------------------|----------------|----------------|
|   |              |                  | Color  | Catalog Number | Std. Pack [10] | Color                        | Catalog Number | Std. Pack [10] |
| <br>5.2 mm (0.21 in.) wide | 600 V        | 16 A             | Grey   | NSYTRR22SC     | 50             | Grey                         | NSYTRACR23     | 50             |
|   |              |                  | Orange | NSYTRR22SCAR   |                | Grey                         | NSYTACR23      |                |
| <br>5.2 mm (0.21 in.) wide | 600 V        | 16 A             | Grey   | NSYTRR23SC     | 50             | Grey                         | NSYTACR24      | 50             |
|   |              |                  | Orange | NSYTRR23SCAR   |                | Grey                         | NSYTACR24      |                |
| <br>5.2 mm (0.21 in.) wide | 300 V        | 10 A             | Grey   | NSYTRR24SCD    | 50             | Not required for this block. |                |                |

**NOTE:** For a complete listing of these products, see [Linergy TR Terminal Blocks](#) online or catalog **9080CT1301**.



File: E87739  
CCN: XCFR2



File: 256444  
Class: 6228-01



RoHS Compliant

For track and accessories, see [Mounting Track and End Clamps](#), page 21-18.

[7] Some products may be discontinued. Refer to [www.se.com/us](#) for the most current product information.

[8] These maximum current values assume the use of insulated copper conductors with 167 °F (75 °C) temperature rating and are calculated based on NEC Article 310, Table 310-16. In most cases this value is the maximum ampacity of the wire which has the greatest current carrying capacity. The actual allowable current for a particular application depends on the size, insulation class, and other characteristics of the wire used. The UL ratings are shown. The CSA rating may be higher or lower. Refer to the catalog for CSA ratings.

[9] One end-barrier is required for each assembly of like blocks.

[10] Orders must specify the standard package quantity (Std. Pack) or multiples of that quantity.

## Miniature Spring Passthrough and Grounding

Table 21.8: Miniature Spring Passthrough DIN Rail Mounting [11]



| Description   | Maximum Voltage | Maximum Current [12] | Block |                |                | End Barrier [13] |                |                |
|---|-----------------|----------------------|-------|----------------|----------------|------------------|----------------|----------------|
|   |                 |                      | Color | Catalog Number | Std. Pack [14] | Color            | Catalog Number | Std. Pack [14] |
| <br>5.2 mm (0.21 in.) wide<br>Two Terminals<br>Solid or Stranded Copper Wire<br>28–12 AWG<br>Mount on DIN Rail 15 x 7.2 mm   | 600 V           | 20 A                 | Grey  | NSYTRR22M      | 50             | Grey             | NSYTRACRM22    | 50             |
|   |                 |                      | Blue  | NSYTRR22MBL    |                | Grey             | NSYTRACRM22    |                |
| <br>10.4 mm (0.41 in.) wide<br>Four Terminals<br>Solid or Stranded Copper Wire<br>28–12 AWG<br>Mount on DIN Rail 15 x 7.2 mm | 600 V           | 20 A                 | Grey  | NSYTRR24M      | 50             | Grey             | NSYTRACRM22    | 50             |
|   |                 |                      | Blue  | NSYTRR24MBL    |                | Grey             | NSYTRACRM22    |                |

Table 21.9: Miniature Spring Grounding Type [11]

| Description   | Block        |                |                | End Barrier [13] |                |                |
|---|--------------|----------------|----------------|------------------|----------------|----------------|
|   | Color        | Catalog Number | Std. Pack [14] | Color            | Catalog Number | Std. Pack [14] |
| <br>5.2 mm (0.21 in.) wide<br>Grounding Block, Two Terminals,<br>Solid or Stranded Copper Wire<br>28–12 AWG<br>Mount on DIN Rail 15 x 7.2 mm | Green/Yellow | NSYTRR22MPE    | 50             | Grey             | NSYTRACRM22    | 50             |

Table 21.10: Miniature Spring Passthrough Direct Mounting and for Micro-Perforated Mounting Plates [11]

| Description  | Maximum Voltage | Maximum Current [12] | Block |                  |                | End Barrier [13] |                                  |                |
|--|-----------------|----------------------|-------|------------------|----------------|------------------|----------------------------------|----------------|
|  |                 |                      | Color | Catalog Number   | Std. Pack [14] | Color            | Catalog Number                   | Std. Pack [14] |
| <br>5.2 mm (0.21 in.) wide<br>Direct Mounting (Flange)<br>Two Terminals<br>Solid or Stranded Copper Wire<br>28–12 AWG                 | 600 V           | 20 A                 | Grey  | NSYTRR22MF       | 50             | Grey             | NSYTRACRM22                      | 50             |
|  |                 |                      | Blue  | NSYTRR22MFBL     |                | Grey             | NSYTRACRM22                      |                |
|  |                 |                      | Grey  | NSYTRR22MFF [15] |                | Grey             | NSYTRACRM22 or NSYTRACRMF22 [15] |                |
| <br>10.4 mm (0.41 in.) wide<br>Direct Mounting (Flange)<br>Four Terminals<br>Solid or Stranded Copper Wire<br>28–12 AWG             | 600 V           | 20 A                 | Grey  | NSYTRR24MF       | 50             | Grey             | NSYTRACRM22                      | 50             |
|  |                 |                      | Blue  | NSYTRR24MFBL     |                | Grey             | NSYTRACRM22                      |                |
|  |                 |                      | Grey  | NSYTRR24MFF [15] |                | Grey             | NSYTRACRM22 or NSYTRACRMF22 [15] |                |
| <br>5.2 mm (0.21 in.) wide<br>For Micro-Perforated Mounting Plates<br>Two Terminals<br>Solid or Stranded Copper Wire<br>28–12 AWG   | 600 V           | 20 A                 | Grey  | NSYTRR22MP       | 50             | Grey             | NSYTRACRM22                      | 50             |
|  |                 |                      | Blue  | NSYTRR22MPBL     |                | Grey             | NSYTRACRM22                      |                |
| <br>10.4 mm (0.41 in.) wide<br>For Micro-Perforated Mounting Plates<br>Four Terminals<br>Solid or Stranded Copper Wire<br>28–12 AWG | 600 V           | 20 A                 | Grey  | NSYTRR24MP       | 50             | Grey             | NSYTRACRM22                      | 50             |
|  |                 |                      | Blue  | NSYTRR24MBL      |                | Grey             | NSYTRACRM22                      |                |

**NOTE:** For a complete listing of these products, see [Linergy TR Terminal Blocks](#) online or catalog [9080CT1301](#).



File: E87739, CCN: XCFR2



File: 256444, Class: 6228-01

RoHS  
CompliantFor track and accessories, see [Mounting Track and End Clamps](#), page 21-18.

[11] Some products may be discontinued. Refer to [www.se.com/us](#) for the most current product information.

[12] These maximum current values assume the use of insulated copper conductors with 167 °F (75 °C) temperature rating and are calculated based on NEC Article 310, Table 310-16. In most cases this value is the maximum ampacity of the wire which has the greatest current carrying capacity. The actual allowable current for a particular application depends on the size, insulation class, and other characteristics of the wire used. The UL ratings are shown. The CSA rating may be higher or lower. Refer to the catalog for CSA ratings.

[13] One end-barrier is required for each assembly of like blocks.

[14] Orders must specify the standard package quantity (Std. Pack) or multiples of that quantity.

[15] With flange. Can only be used at the end of a group of terminals.

**Passthrough and Grounding**

**Table 21.11: Screw Type Passthrough Blocks [16]**

| Description  | Maximum Voltage | Maximum Current [17] | Block  |                |                | End Barrier [18]               |                |                |
|--|-----------------|----------------------|--------|----------------|----------------|--------------------------------|----------------|----------------|
|  |                 |                      | Color  | Catalog Number | Std. Pack [19] | Color                          | Catalog Number | Std. Pack [19] |
| <br>5.2 mm (0.21 in.) wide<br>Two Terminals<br>Solid or Stranded Copper Wire<br>26–12 AWG | 600 V           | 20 A                 | Grey   | NSYTRV22       | 50             | Grey                           | NSYTRAC22      | 50             |
|  |                 |                      | Blue   | NSYTRV22BL     |                | Blue                           | NSYTRAC22BL    |                |
|  |                 |                      | Orange | NSYTRV22AR     |                | Grey                           | NSYTRAC22      |                |
|  |                 |                      | Red    | NSYTRV22RD     |                | Grey                           | NSYTRAC22      |                |
|  |                 |                      | White  | NSYTRV22WH     |                | Grey                           | NSYTRAC22      |                |
| <br>6.2 mm (0.24 in.) wide<br>Two Terminals<br>Solid or Stranded Copper Wire<br>26–10 AWG | 600 V           | 00 A                 | Grey   | NSYTRV42       | 50             | Grey                           | NSYTRAC22      | 50             |
|  |                 |                      | Blue   | NSYTRV42BL     |                | Blue                           | NSYTRAC22BL    |                |
|  |                 |                      | Orange | NSYTRV42AR     |                | Grey                           | NSYTRAC22      |                |
|  |                 |                      | Red    | NSYTRV42RD     |                | Grey                           | NSYTRAC22      |                |
|  |                 |                      | Green  | NSYTRV42GN     |                | Grey                           | NSYTRAC22      |                |
|  |                 |                      | White  | NSYTRV42WH     |                | Grey                           | NSYTRAC22      |                |
|  |                 |                      | Black  | NSYTRV42BK     |                | Grey                           | NSYTRAC22      |                |
|  |                 |                      | Brown  | NSYTRV42BR     |                | Grey                           | NSYTRAC22      |                |
|  |                 |                      | Yellow | NSYTRV42YE     |                | Grey                           | NSYTRAC22      |                |
| <br>8.2 mm (0.32 in.) wide<br>Two Terminals<br>Solid or Stranded Copper Wire<br>24–8 AWG  | 600 V           | 50 A                 | Grey   | NSYTRV62       | 50             | Grey                           | NSYTRAC22      | 50             |
|  |                 |                      | Blue   | NSYTRV62BL     |                | Blue                           | NSYTRAC22BL    |                |
| <br>10.2 mm (0.40 in.) wide<br>Two Terminals<br>Solid or Stranded Copper Wire<br>20–6 AWG | 600 V           | 65 A                 | Grey   | NSYTRV102      | 50             | Grey                           | NSYTRAC22      | 50             |
|  |                 |                      | Blue   | NSYTRV102BL    |                | Blue                           | NSYTRAC22BL    |                |
| <br>12.2 mm (0.48 in.) wide<br>Two Terminals<br>Solid or Stranded Copper Wire<br>16–4 AWG | 600 V           | 85 A                 | Grey   | NSYTRV162      | 50             | Grey                           | NSYTRAC162     | 50             |
|  |                 |                      | Blue   | NSYTRV162BL    |                | Grey                           | NSYTRAC162     |                |
| <br>16 mm (0.63 in.) wide<br>Two Terminals<br>Solid or Stranded Copper Wire<br>14–1/0 AWG | 600 V           | 150 A                | Grey   | NSYTRV352      | 50             | Not required for these blocks. |                |                |
|  |                 |                      | Blue   | NSYTRV352BL    |                |                                |                |                |
| <br>20 mm (0.79 in.) wide<br>Two Terminals<br>Solid or Stranded Copper Wire<br>6–1/0 AWG | 600 V           | 150 A                | Grey   | NSYTRV502      | 50             | Not required for these blocks. |                |                |
|  |                 |                      | Blue   | NSYTRV502BL    |                |                                |                |                |

**NOTE:** For a complete listing of these products, see catalog [9080CT1301](#).



File: E87739; CCN: XCFR2



File: 256444; Class: 6228-01



RoHS Compliant

For track and accessories, see [page 21-18](#).

[16] Some products may be discontinued. Refer to [www.se.com/us](#) for the most current product information.

[17] These maximum current values assume the use of insulated copper conductors with 167 °F (75 °C) temperature rating and are calculated based on NEC Article 310, Table 310-16. In most cases this value is the maximum ampacity of the wire which has the greatest current carrying capacity. The actual allowable current for a particular application depends on the size, insulation class, and other characteristics of the wire used. The UL ratings are shown. The CSA rating may be higher or lower. Refer to the catalog for CSA ratings.

[18] One end-barrier is required for each assembly of like blocks.

[19] Orders must specify the standard package quantity (Std. Pack) or multiples of that quantity.

Table 21.12: Screw Type Grounding Blocks [20]

| Description   |  | Block        |                |                | End Barrier [21]             |                |                |
|---|--|--------------|----------------|----------------|------------------------------|----------------|----------------|
|   |  | Color        | Catalog Number | Std. Pack [22] | Color                        | Catalog Number | Std. Pack [22] |
|  | Two Terminals, Solid or Stranded Copper Wire, 26–12 AWG<br>5.2 mm (0.21 in.) wide                  | Green/Yellow | NSYTRV22PE     | 50             | Grey                         | NSYTRAC22      | 50             |
|  | Two Terminals, Solid or Stranded Copper Wire, 26–10 AWG<br>6.2 mm (0.24 in.) wide                  | Green/Yellow | NSYTRV42PE     | 50             | Grey                         | NSYTRAC22      | 50             |
|  | Two Terminals, Solid or Stranded Copper Wire, 24–8 AWG<br>8.2 mm (0.32 in.) wide                   | Green/Yellow | NSYTRV62PE     | 50             | Grey                         | NSYTRAC22      | 50             |
|  | Two Terminals, Solid or Stranded Copper Wire, 20–6 AWG<br>10.2 mm (0.40 in.) wide                  | Green/Yellow | NSYTRV102PE    | 50             | Grey                         | NSYTRAC22      | 50             |
|  | Grounding Block, Two Terminals, Solid or Stranded Copper Wire, 16–4 AWG<br>12.2 mm (0.48 in.) wide | Green/Yellow | NSYTRV162PE    | 50             | Grey                         | NSYTRAC162     | 50             |
|  | Two Terminals, Solid or Stranded Copper Wire, 14–1/0 AWG<br>16 mm (0.63 in.) wide                  | Green/Yellow | NSYTRV352PE    | 50             | Not required for this block. |                |                |
|  | Two Terminals, Solid or Stranded Copper Wire, 6–1/0 AWG<br>20 mm (0.79 in.) wide                   | Green/Yellow | NSYTRV502PE    | 50             | Not required for this block. |                |                |

**NOTE:** For a complete listing of these products, see [Linergy TR Terminal Blocks](#) online or catalog [9080CT1301](#).



File: E87739; CCN: XCFR2



File: 256444; Class: 6228-01



RoHS Compliant

For track and accessories, see page 21-18.

[20] Some products may be discontinued. Refer to [www.se.com/us](#) for the most current product information.





[21] One end-barrier is required for each assembly of like blocks.

[22] Orders must specify the standard package quantity (Std. Pack) or multiples of that quantity.







**Lug/Lug, Double and Triple Deck Passthrough, Grounding**





**Table 21.13: Passthrough, Lug/Lug, and Lug/Clamp [23]**

| Description   | Block                           |       |                |                           | Partition Cover              |                |                           |
|---|---------------------------------|-------|----------------|---------------------------|------------------------------|----------------|---------------------------|
|   | Maximum Current <sup>[24]</sup> | Color | Catalog Number | Std. Pack <sup>[25]</sup> | Color                        | Catalog Number | Std. Pack <sup>[25]</sup> |
| <br>20.3 mm (0.80 in.) wide<br>Passthrough Solid or Stranded Copper Wire 4–3/0 AWG<br>Screw thread M8<br>Maximum Voltage–600 V     | 192 A                           | Grey  | NSYTRV702      | 10                        | Not required for this block. |                |                           |
| <br>40 mm (1.58 in.) wide<br>Lug to Lug Solid or Stranded Copper Wire 2–4/0 AWG<br>Screw thread M12<br>Maximum Voltage–600 V       | 230 A                           | Grey  | NSYTRV952BB    | 10                        | Grey                         | NSYTRAC952     | 10                        |
| <br>40 mm (1.58 in.) wide<br>Solid or Stranded Copper Wire 2–4/0 AWG<br>Screw thread M12<br>Maximum Voltage–600 V                  | 230 A                           | Grey  | NSYTRV952BC    | 10                        | Grey                         | NSYTRAC952     | 10                        |
| <br>46 mm (1.81 in.) wide<br>Lug to Lug Solid or Stranded Copper Wire 2–300 AWG/kcmil<br>Screw thread M12<br>Maximum Voltage–600 V | 285 A                           | Grey  | NSYTRV1502BB   | 10                        | Grey                         | NSYTRAC952     | 10                        |

**Table 21.14: Screw Type Double and Triple Deck Passthrough [23]**

| Description  | Maximum Voltage | Maximum Current <sup>[24]</sup> | Block |                |                           | End Barrier <sup>[26]</sup> |                |                           |
|--|-----------------|---------------------------------|-------|----------------|---------------------------|-----------------------------|----------------|---------------------------|
|  |                 |                                 | Color | Catalog Number | Std. Pack <sup>[25]</sup> | Color                       | Catalog Number | Std. Pack <sup>[25]</sup> |
| <br>6.2 mm (0.24 in.) wide<br>Double Deck, One Pole, Three Terminals Solid or Stranded Copper Wire 26–10 AWG    | 150 V           | 30 A                            | Grey  | NSYTRV43       | 50                        | Grey                        | NSYTRAC23      | 50                        |
|  |                 |                                 | Blue  | NSYTRV43BL     |                           | Grey                        | NSYTRAC23      |                           |
| <br>6.2 mm (0.24 in.) wide<br>Double Deck, One Pole, Four Terminals Solid or Stranded Copper Wire 26–10 AWG     | 150 V           | 30 A                            | Grey  | NSYTRV44       | 50                        | Grey                        | NSYTRAC24      | 50                        |
|  |                 |                                 | Blue  | NSYTRV44BL     |                           | Grey                        | NSYTRAC24      |                           |
| <br>5.2 mm (0.21 in.) wide<br>Double Deck, Two Poles, Four Terminals Solid or Stranded Copper Wire 26–12 AWG   | 600 V           | 20 A                            | Grey  | NSYTRV24D      | 50                        | Grey                        | NSYTRACE24     | 50                        |
|  |                 |                                 | Blue  | NSYTRV24DBL    |                           | Grey                        | NSYTRACE24     |                           |
| <br>6.2 mm (0.24 in.) wide<br>Double Deck, Two Poles, Four Terminals Solid or Stranded Copper Wire 26–10 AWG  | 600 V           | 30 A                            | Grey  | NSYTRV44D      | 50                        | Grey                        | NSYTRACE24     | 50                        |
|  |                 |                                 | Blue  | NSYTRV44DBL    |                           | Grey                        | NSYTRACE24     |                           |
| <br>5.2 mm (0.21 in.) wide<br>Triple Deck, Three Poles, Six Terminals Solid or Stranded Copper Wire 26–10 AWG | 600 V           | 20 A                            | Grey  | NSYTRV26T      | 50                        | Grey                        | NSYTRACE26     | 50                        |

**Table 21.15: Screw Type Grounding Double Deck [23]**

| Description   | Block        |                |                           | End Barrier <sup>[26]</sup> |                |                           |
|---|--------------|----------------|---------------------------|-----------------------------|----------------|---------------------------|
|   | Color        | Catalog Number | Std. Pack <sup>[25]</sup> | Color                       | Catalog Number | Std. Pack <sup>[25]</sup> |
| <br>6.2 mm (0.24 in.) wide<br>Grounding Block, One Pole, Three Terminals Solid or Stranded Copper Wire 26–12 AWG | Green/Yellow | NSYTRV43PE     | 50                        | Grey                        | NSYTRAC23      | 50                        |
| <br>6.2 mm (0.24 in.) wide<br>Grounding Block, One Pole, Four Terminals Solid or Stranded Copper Wire 26–12 AWG  | Green/Yellow | NSYTRV44PE     | 50                        | Grey                        | NSYTRAC24      | 50                        |
| <br>5.2 mm (0.21 in.) wide<br>Grounding Block, One Pole, Four Terminals Solid or Stranded Copper Wire 26–12 AWG  | Green/Yellow | NSYTRV24DPE    | 50                        | Grey                        | NSYTRACE24     | 50                        |
| <br>6.2 mm (0.24 in.) wide<br>Grounding Block, One Pole, Four Terminals Solid or Stranded Copper Wire 26–10 AWG  | Green/Yellow | NSYTRV44DPE    | 50                        | Grey                        | NSYTRACE24     | 50                        |

**NOTE:** For a complete listing of these products, see [Linergy TR Terminal Blocks](#) online.



File: E87739  
CCN: XCFR2



File: 256444  
Class: 6228-01



RoHS Compliant

For track and accessories, see [page 21-18](#).

[23] Some products may be discontinued. Refer to [www.se.com/us](#) for the most current product information.

[24] These maximum current values assume the use of insulated copper conductors with 167 °F (75 °C) temperature rating and are calculated based on NEC Article 310, Table 310-16. In most cases this value is the maximum ampacity of the wire which has the greatest current carrying capacity. The actual allowable current for a particular application depends on the size, insulation class, and other characteristics of the wire used. The UL ratings are shown. The CSA rating may be higher or lower. Refer to the catalog for CSA ratings.

[25] Orders must specify the standard package quantity (Std. Pack) or multiples of that quantity.

[26] One end-barrier is required for each assembly of like blocks.

Blade Isolators, Component Carriers, Fused, Measuring,  
Grounding

Table 21.16: Screw Type Blade Isolators [27]



| Description  | Maximum Voltage | Maximum Current [28] | Block                   |                |                | End Barrier [29]             |                |                |
|--|-----------------|----------------------|-------------------------|----------------|----------------|------------------------------|----------------|----------------|
|  |                 |                      | Color                   | Catalog Number | Std. Pack [30] | Color                        | Catalog Number | Std. Pack [30] |
| <br>6.2 mm (0.24 in.) wide<br>Blade Isolator Two Terminals<br>Solid or Stranded Copper Wire<br>26–10 AWG              | 600 V           | 16 A                 | Grey                    | NSYTRV42SC     | 50             | Not required for this block. |                |                |
|  |                 |                      | Grey with Test Points   | NSYTRV42ST     |                |                              |                |                |
|  |                 |                      | Orange with Test Points | NSYTRV42STAR   |                |                              |                |                |
| <br>6.2 mm (0.24 in.) wide<br>Blade Isolator Double Deck Four Terminals<br>Solid or Stranded Copper Wire<br>26–10 AWG | 300 V           | 30 A                 | Grey                    | NSYTRV42SCD    | 50             | Grey                         | NSYTRACE24     | 50             |

Table 21.17: Screw Type Component Carrier [27]







| Description   | Maximum Voltage               | Maximum Current [28] | Color | Catalog Number | Std. Pack [30] | End Barrier [29] |
|---|-------------------------------|----------------------|-------|----------------|----------------|------------------|
|   |                               |                      |       |                |                |                  |
| <br>6.2 mm (0.24 in.) wide<br>For fuse 5 x 20 mm<br>For fuse 5 x 20 mm 110–250 V LED<br>For fuse 5 x 20 mm 12–30 V LED<br>For component<br>With 1N4007 diode | Depends on fuse or diode used |                      | Black | NSYTRASF520    | 10             | Not required     |
|   |                               |                      |       | NSYTRASF520M   | 10             |                  |
|   |                               |                      |       | NSYTRASF520B   | 10             |                  |
|   |                               |                      |       | NSYTRASV1      | 10             |                  |
|   |                               |                      |       | NSYTRASV2      | 10             |                  |

Table 21.18: Fused Terminal Blocks [27]

| Description   | Color                                      | Catalog Number | Std. Pack [30] | End Barrier [29] |                              |                |
|---|--|----------------|----------------|------------------|------------------------------|----------------|
|   |  |                |                | Color            | Catalog Number               | Std. Pack [30] |
| <br>12 mm (0.47 in.) wide<br>Fuse Block<br>For G-fuse cartridge 5x20 mm<br>Solid or Stranded Copper Wire 24–6 AWG<br>Maximum Voltage 300 V<br>Maximum Current 20 A [28]            | Without Indicator Lamp                     | Black          | NSYTRV162SF    | 50               | Not required for this block. |                |
| <br>8.2 mm (0.32 in.) wide<br>Lever-Type Fuse<br>For G-fuse cartridge 5x20 mm<br>Solid or Stranded Copper Wire 26–10 AWG<br>Maximum Voltage 600 V<br>Maximum Current 12 A [28]   | Without Indicator Lamp                     | Black          | NSYTRV42SF5    | 50               | Not required for this block. |                |
|   | With Light Indicator, 12–30 V AC/DC [31]   | Black          | NSYTRV42SF5LD  | 50               |                              |                |
| <br>10.2 mm (0.40 in.) wide<br>Lever-Type Fuse<br>For G-fuse cartridge 6.3x32 mm<br>Solid or Stranded Copper Wire 26–8 AWG<br>Maximum Voltage 600 V<br>Maximum Current 10 A [28] | Without Indicator Lamp                     | Black          | NSYTRV42SF6    | 50               | Not required for this block. |                |
|   | With Light Indicator, 12–30 V AC/DC [31]   | Black          | NSYTRV42SF6LD  | 50               |                              |                |
|   | With Light Indicator, 110–250 V AC/DC [31] | Black          | NSYTRV42SF6LA  | 50               |                              |                |

These measuring transducer terminal blocks with screw connection technology are characterized by easy operation and clarity. All switching statuses are clearly visible. The extensive range of flexible accessories saves cost and time when executing transducer test circuit tasks.

Table 21.19: Measuring and Grounding Terminal Blocks [27]

| Description   | Maximum Voltage | Maximum Current [28] | Block            |                |                | End Barrier [29] |                |                |
|---|-----------------|----------------------|------------------|----------------|----------------|------------------|----------------|----------------|
|   |                 |                      | Color            | Catalog Number | Std. Pack [30] | Color            | Catalog Number | Std. Pack [30] |
| <br>8.2 mm (0.32 in.) wide<br>Blade Isolator Double Deck<br>Solid or Stranded Copper Wire<br>24–8 AWG    | 600 V           | 30 A                 | Grey             | NSYTRV62TTD    | 50             | Grey             | NSYTRACT22     | 50             |
| <br>8.2 mm (0.32 in.) wide<br>Passthrough Two Terminals<br>Solid or Stranded Copper Wire<br>24–8 AWG     | 600 V           | 30 A                 | Grey             | NSYTRV62TT     | 50             |                  |                |                |
| <br>8.2 mm (0.32 in.) wide<br>Grounding Block Two Terminals<br>Solid or Stranded Copper Wire<br>24–8 AWG | N/A             | N/A                  | Green/<br>Yellow | NSYTRV62TTPE   | 50             |                  |                |                |

NOTE: For a complete listing of these products, see [Linergy TR Terminal Blocks](#) online or catalog 9080CT1301.

[27] Some products may be discontinued. Refer to [www.se.com/us](#) for the most current product information.

[28] These maximum current values assume the use of insulated copper conductors with 167 °F (75 °C) temperature rating and are calculated based on NEC Article 310, Table 310-16. In most cases this value is the maximum ampacity of the wire which has the greatest current carrying capacity. The actual allowable current for a particular application depends on the size, insulation class, and other characteristics of the wire used. The UL ratings are shown. The CSA ratings may be higher or lower. Refer to the catalog for CSA ratings.

[29] One end-barrier is required for each assembly of like blocks.



[30] Orders must specify the standard package quantity (Std. Pack) or multiples of that quantity.

[31] When voltage is applied within the minimum and maximum limits, the LED will illuminate.





**Miniature Passthrough and Hybrid Passthrough**

**Table 21.20: Screw Type Miniature Passthrough** [32]

| Description   | Maximum Voltage | Maximum Current [33] | Block |                |                | End Barrier [34] |                |                |
|---|-----------------|----------------------|-------|----------------|----------------|------------------|----------------|----------------|
|   |                 |                      | Color | Catalog Number | Std. Pack [35] | Color            | Catalog Number | Std. Pack [35] |
| <br>Two Terminals<br>Solid or Stranded Copper Wire<br>24–12 AWG<br>Mount on DIN rail, 5 x 5 mm<br>5.2 mm (0.21 in.) wide | 600 V           | 20 A                 | Grey  | NSYTRV22M      | 50             | Grey             | NSYTRACM22     | 50             |
|   |                 |                      | Blue  | NSYTRV22MBL    |                | Grey             | NSYTRACM22     |                |
| <br>Two Terminals<br>Solid or Stranded Copper Wire<br>24–10 AWG<br>Mount on DIN rail, 5 x 5 mm<br>6.2 mm (0.24 in.) wide | 600 V           | 30 A                 | Grey  | NSYTRV42M      | 50             | Grey             | NSYTRACM22     | 50             |
|   |                 |                      | Blue  | NSYTRV42MBL    |                | Grey             | NSYTRACM22     |                |

**Table 21.21: Screw Type Miniature Grounding Blocks** [32]

| Description  | Block        |                |                | End Barrier [34] |                |                |
|--|--------------|----------------|----------------|------------------|----------------|----------------|
|  | Color        | Catalog Number | Std. Pack [35] | Color            | Catalog Number | Std. Pack [35] |
| <br>Grounding Block<br>Two Terminals<br>Solid or Stranded Copper Wire<br>24–12 AWG<br>Mount on DIN rail, 5 x 5 mm<br>5.2 mm (0.21 in.) wide | Green/Yellow | NSYTRV22MPE    | 50             | Grey             | NSYTRACM22     | 50             |
| <br>Grounding Block<br>Two Terminals<br>Solid or Stranded Copper Wire<br>24–10 AWG<br>Mount on DIN rail, 5 x 5 mm<br>6.2 mm (0.24 in.) wide | Green/Yellow | NSYTRV42MPE    | 50             | Grey             | NSYTRACM22     | 50             |

**NOTE:** For a complete listing of these products, see [Linergy TR Terminal Blocks](#) online or catalog **9080CT1301**.



[32] Some products may be discontinued. Refer to [www.se.com/us](#) for the most current product information.

[33] These maximum current values assume the use of insulated copper conductors with 167 °F (75 °C) temperature rating and are calculated based on NEC Article 310, Table 310-16. In most cases this value is the maximum ampacity of the wire which has the greatest current carrying capacity. The actual allowable current for a particular application depends on the size, insulation class, and other characteristics of the wire used. The UL ratings are shown. The CSA rating may be higher or lower. Refer to the catalog for CSA ratings.

[34] One end-barrier is required for each assembly of like blocks.

[35] Orders must specify the standard package quantity (Std. Pack) or multiples of that quantity.

Table 21.22: Hybrid Blocks—Screw and Insulation Displacement Connection (IDC) Passthrough [36]





| Description  | Maximum Voltage | Maximum Current [37] | Block |                |                | End Barrier [38] |                |                |
|--|-----------------|----------------------|-------|----------------|----------------|------------------|----------------|----------------|
|  |                 |                      | Color | Catalog Number | Std. Pack [39] | Color            | Catalog Number | Std. Pack [39] |
| <br>Two Terminals<br>Solid or Stranded Copper Wire<br>24–16 AWG<br>5.2 mm (0.21 in.) wide   | 600 V           | 10 A                 | Grey  | NSYTRH12       | 50             | Grey             | NSYTRACH12     | 50             |
| <br>Three Terminals<br>Solid or Stranded Copper Wire<br>24–16 AWG<br>5.2 mm (0.21 in.) wide | 600 V           | 10 A                 | Grey  | NSYTRH13       | 50             | Grey             | NSYTRACH13     | 50             |
| <br>Three Terminals<br>Solid or Stranded Copper Wire<br>20–14 AWG<br>6.2 mm (0.24 in.) wide | 600 V           | 15 A                 | Grey  | NSYTRH22       | 50             | Grey             | NSYTRACH22     | 50             |

Table 21.23: Hybrid Grounding Block—Screw and Insulation Displacement Connection (IDC) Passthrough [36]

| Description   | Block        |                |                | End Barrier [38] |                |                |
|---|--------------|----------------|----------------|------------------|----------------|----------------|
|   | Color        | Catalog Number | Std. Pack [39] | Color            | Catalog Number | Std. Pack [39] |
| <br>Grounding Block<br>Two Terminals<br>Solid or Stranded Copper Wire<br>24–16 AWG<br>5.2 mm (0.21 in.) wide | Green/Yellow | NSYTRH12PE     | 50             | Grey             | NSYTRACH12     | 50             |

NOTE: For a complete listing of these products, see [Linergy TR Terminal Blocks](#) online or catalog 9080CT1301.



File:  
E87739  
CCN:  
XCFR2



File:  
256444  
Class:  
6228-01



RoHS  
Compliant

For track and accessories, see [Mounting Track and End Clamps](#), page 21-18.

[36] Some products may be discontinued. Refer to [www.se.com/us](#) for the most current product information.

[37] These maximum current values assume the use of insulated copper conductors with 167 °F (75 °C) temperature rating and are calculated based on NEC Article 310, Table 310-16. In most cases this value is the maximum ampacity of the wire which has the greatest current carrying capacity. The actual allowable current for a particular application depends on the size, insulation class, and other characteristics of the wire used. The UL ratings are shown. The CSA rating may be higher or lower. Refer to the catalog for CSA ratings.







[38] One end-barrier is required for each assembly of like blocks.

[39] Orders must specify the standard package quantity (Std. Pack) or multiples of that quantity.

**Passthrough and Grounding**

Push-in technology terminal blocks feature simple handling and direct, tool-free connections. When pushing in solid wires or wires with ferrules, the contact spring is automatically opened and ensures the required pressure force against the current bar.

**Table 21.24: Push-in Passthrough Blocks** [40]

| Description  | Maximum Voltage | Maximum Current [41] | Block  |                |                | End Barrier [42] |                |                |
|--|-----------------|----------------------|--------|----------------|----------------|------------------|----------------|----------------|
|  |                 |                      | Color  | Catalog Number | Std. Pack [43] | Color            | Catalog Number | Std. Pack [43] |
| <br>Two Terminals<br>Solid or Stranded Copper Wire<br>24–12 AWG<br>5.2 mm (0.21 in.) wide   | 600 V           | 20 A                 | Grey   | NSYTRP22       | 50             | Grey             | NSYTRACR22     | 50             |
|  |                 |                      | Blue   | NSYTRP22BL     |                | Blue             | NSYTRACR22BL   |                |
|  |                 |                      | Orange | NSYTRP22AR     |                | Grey             | NSYTRACR22     |                |
| <br>Three Terminals<br>Solid or Stranded Copper Wire<br>24–12 AWG<br>5.2 mm (0.21 in.) wide | 600 V           | 20 A                 | Grey   | NSYTRP23       | 50             | Grey             | NSYTRACR23     | 50             |
|  |                 |                      | Blue   | NSYTRP23BL     |                | Blue             | NSYTRACR23BL   |                |
|  |                 |                      | Orange | NSYTRP23AR     |                | Grey             | NSYTRACR23     |                |
| <br>Four Terminals<br>Solid or Stranded Copper Wire<br>24–12 AWG<br>5.2 mm (0.21 in.) wide  | 600 V           | 20 A                 | Grey   | NSYTRP24       | 50             | Grey             | NSYTRACR24     | 50             |
|  |                 |                      | Blue   | NSYTRP24BL     |                | Blue             | NSYTRACR24BL   |                |
| <br>Two Terminals<br>Solid or Stranded Copper Wire<br>24–10 AWG<br>6.2 mm (0.24 in.) wide   | 600 V           | 30 A                 | Grey   | NSYTRP42       | 50             | Grey             | NSYTRACR42     | 50             |
|  |                 |                      | Blue   | NSYTRP42BL     |                | Grey             | NSYTRACR42     |                |
| <br>Three Terminals<br>Solid or Stranded Copper Wire<br>24–10 AWG<br>6.2 mm (0.24 in.) wide | 600 V           | 30 A                 | Grey   | NSYTRP43       | 50             | Grey             | NSYTRACP43     | 50             |
|  |                 |                      | Blue   | NSYTRP43BL     |                | Grey             | NSYTRACP43     |                |
| <br>Four Terminals<br>Solid or Stranded Copper Wire<br>24–10 AWG<br>6.2 mm (0.24 in.) wide  | 600 V           | 30 A                 | Grey   | NSYTRP44       | 50             | Grey             | NSYTRACP44     | 50             |
|  |                 |                      | Blue   | NSYTRP44BL     |                | Grey             | NSYTRACP44     |                |

**NOTE:** For a complete listing of these products, see catalog [9080CT1301](#).



File:  
E87739  
CCN:  
XCFR2



File:  
256444  
Class:  
6228-01



RoHS  
Compliant

For track and accessories, see [Mounting Track and End Clamps](#), page 21-18.







[40] Some products may be discontinued. Refer to [www.se.com/us](#) for the most current product information.

[41] These maximum current values assume the use of insulated copper conductors with 167 °F (75 °C) temperature rating and are calculated based on NEC Article 310, Table 310-16. In most cases this value is the maximum ampacity of the wire which has the greatest current carrying capacity. The actual allowable current for a particular application depends on the size, insulation class, and other characteristics of the wire used. The UL ratings are shown. The CSA rating may be higher or lower. Refer to the catalog for CSA ratings.

[42] One end-barrier is required for each assembly of like blocks.

[43] Orders must specify the standard package quantity (Std. Pack) or multiples of that quantity.

Table 21.25: Push-in Grounding Blocks [44]

| Description  | Block        |                |                | End Barrier [45] |                |                |
|--|--------------|----------------|----------------|------------------|----------------|----------------|
|  | Color        | Catalog Number | Std. Pack [46] | Color            | Catalog Number | Std. Pack [46] |
| <br>5.2 mm (0.21 in.) wide<br>Grounding Block<br>Two Terminals<br>Solid or Stranded Copper Wire 24–12 AWG   | Green/Yellow | NSYTRP22PE     | 50             | Grey             | NSYTRACR22     | 50             |
| <br>5.2 mm (0.21 in.) wide<br>Grounding Block<br>Three Terminals<br>Solid or Stranded Copper Wire 24–12 AWG | Green/Yellow | NSYTRP23PE     | 50             | Grey             | NSYTRACR23     | 50             |
| <br>5.2 mm (0.21 in.) wide<br>Grounding Block<br>Four Terminals<br>Solid or Stranded Copper Wire 24–12 AWG  | Green/Yellow | NSYTRP24PE     | 50             | Grey             | NSYTRACR24     | 50             |
| <br>6.2 mm (0.24 in.) wide<br>Grounding Block<br>Two Terminals<br>Solid or Stranded Copper Wire 24–10 AWG   | Green/Yellow | NSYTRP42PE     | 50             | Grey             | NSYTRACR42     | 50             |
| <br>6.2 mm (0.24 in.) wide<br>Grounding Block<br>Three Terminals<br>Solid or Stranded Copper Wire 24–10 AWG | Green/Yellow | NSYTRP43PE     | 50             | Grey             | NSYTRACP43     | 50             |
| <br>6.2 mm (0.24 in.) wide<br>Grounding Block<br>Four Terminals<br>Solid or Stranded Copper Wire 24–10 AWG  | Green/Yellow | NSYTRP44PE     | 50             | Grey             | NSYTRACP44     | 50             |

NOTE: For a complete listing of these products, see [Linergy TR Terminal Blocks](#) online or catalog 9080CT1301.



File:  
E87739  
CCN:  
XCFR2



File:  
702070  
Class:  
6228-01



RoHS  
Compliant

For track and accessories, see [Mounting Track and End Clamps](#), page 21-18.



[44] Some products may be discontinued. Refer to [www.se.com/us](#) for the most current product information.

[45] One end-barrier is required for each assembly of like blocks.

[46] Orders must specify the standard package quantity (Std. Pack) or multiples of that quantity.

**Double Deck Passthrough, Blade Isolators, Component Carriers**



**Table 21.26: Push-in Double Deck Passthrough and Grounding Terminal Blocks [47]**

| Description  | Maximum Voltage | Maximum Current [48] | Block        |                |                | End Barrier [49] |                |                |
|--|-----------------|----------------------|--------------|----------------|----------------|------------------|----------------|----------------|
|  |                 |                      | Color        | Catalog Number | Std. Pack [50] | Color            | Catalog Number | Std. Pack [50] |
| <br>Double Deck Passthrough Four Terminals<br>Solid or Stranded Copper Wire 26–12 AWG<br>5.2 mm (0.21 in.) wide     | 600 V           | 20 A                 | Grey         | NSYTRP24D      | 50             | Grey             | NSYTRACRE24    | 50             |
|  |                 |                      | Blue         | NSYTRP24DBL    |                | Grey             | NSYTRACRE24    |                |
| <br>Double Deck Grounding Block Four Terminals<br>Solid or Stranded Copper Wire 26–12 AWG<br>5.2 mm (0.21 in.) wide | N/A             | N/A                  | Green/Yellow | NSYTRP24DPE    | 50             | Grey             | NSYTRACRE24    | 50             |

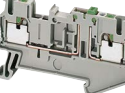
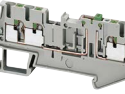
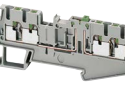
**Table 21.27: Push-in Blade Isolators [47]**

| Description   | Maximum Voltage | Maximum Current [51] | Block |                |                | End Barrier [49] |                |                |
|---|-----------------|----------------------|-------|----------------|----------------|------------------|----------------|----------------|
|   |                 |                      | Color | Catalog Number | Std. Pack [50] | Color            | Catalog Number | Std. Pack [50] |
| <br>Blade Isolator Two Terminals<br>Solid or Stranded Copper Wire 26–12 AWG<br>5.2 mm (0.21 in.) wide    | 300 V           | 20 A                 | Grey  | NSYTRP22SC     | 50             | Grey             | NSYTRACPK22    | 50             |
| <br>Blade Isolator Three Terminals<br>Solid or Stranded Copper Wire 26–12 AWG<br>5.2 mm (0.21 in.) wide  | 300 V           | 20 A                 | Grey  | NSYTRP23SC     | 50             | Grey             | NSYTRACPK23    | 50             |
| <br>Blade Isolator Four Terminals<br>Solid or Stranded Copper Wire 26–12 AWG<br>5.2 mm (0.21 in.) wide | 300 V           | 20 A                 | Grey  | NSYTRP24SC     | 50             | Grey             | NSYTRACPK24    | 50             |

**Table 21.28: Push-In Type Component Carriers [47]**

| Description   | Maximum Voltage | Maximum Current [51] | Color | Catalog Number | Std. Pack [50] | End Barrier [49] |                |                |              |
|---|-----------------|----------------------|-------|----------------|----------------|------------------|----------------|----------------|--------------|
|   |                 |                      |       |                |                | Color            | Catalog Number | Std. Pack [50] |              |
| <br>Component Carrier Two Terminals Solid or Stranded Copper Wire 26–12 AWG<br>5.2 mm (0.21 in.) wide<br>For fuse 5 x 20 mm<br>For fuse 5 x 20 mm 110–250 V LED<br>For fuse 5 x 20 mm 12–30 V LED<br>For component With 1N4007 diode | 300 A           | 20 A                 | Grey  | NSYTRP22TB     | 50             | Grey             | NSYTRACPK22    | 50             |              |
|   |                 |                      | Black | NSYTRASF520    | 10             |                  |                |                | Not required |
|   |                 |                      |       | NSYTRASF520M   | 10             |                  |                |                |              |
|   |                 |                      |       | NSYTRASF520B   | 10             |                  |                |                |              |
|   |                 |                      | Grey  | NSYTRASV1      | 10             |                  |                |                |              |
| NSYTRASV2   | 10              |                      |       |                |                |                  |                |                |              |
| <br>Component Carrier Two Terminals Solid or Stranded Copper Wire 24–12 AWG<br>6.2 mm (0.24 in.) wide<br>For fuse 5 x 20 mm<br>For fuse 5 x 20 mm 110–250 V LED<br>For fuse 5 x 20 mm 12–30 V LED<br>For component With 1N4007 diode | 300 A           | 20 A                 | Grey  | NSYTRP42TB     | 50             | Grey             | NSYTRACR42     | 50             |              |
|   |                 |                      | Black | NSYTRASF520    | 10             |                  |                |                | Not required |
|   |                 |                      |       | NSYTRASF520M   | 10             |                  |                |                |              |
|   |                 |                      |       | NSYTRASF520B   | 10             |                  |                |                |              |
|   |                 |                      | Grey  | NSYTRASV1      | 10             |                  |                |                |              |
| NSYTRASV2   | 10              |                      |       |                |                |                  |                |                |              |

**NOTE:** For a complete listing of these products, see [Linergy TR Terminal Blocks](#) online or catalog **9080CT1301**.

[47] Some products may be discontinued. Refer to [www.se.com/us](#) for the most current product information.

[48] These maximum current values assume the use of insulated copper conductors with 167 °F (75 °C) temperature rating and are calculated based on NEC Article 310, Table 310-16. In most cases this value is the maximum ampacity of the wire which has the greatest current carrying capacity. The actual allowable current for a particular application depends on the size, insulation class, and other characteristics of the wire used. The UL ratings are shown. The CSA rating may be higher or lower. Refer to the catalog for CSA ratings.

[49] One end-barrier is required for each assembly of like blocks.

[50] Orders must specify the standard package quantity (Std. Pack) or multiples of that quantity.

[51] These maximum current values assume the use of insulated copper conductors with 167 °F (75 °C) temperature rating and are calculated based on NEC Article 310, Table 310-16. In most cases this value is the maximum ampacity of the wire which has the greatest current carrying capacity. The actual allowable current for a particular application depends on the size, insulation class, and other characteristics of the wire used. The UL ratings are shown. The CSA rating may be higher or lower. Refer to the catalog for CSA ratings.



File:  
E87739  
CCN:  
XCFR2



File:  
256444  
Class:  
6228-01









RoHS  
Compliant

For track and accessories, see Mounting Track and End Clamps, page 21-18.

Linery Marking Accessories

Table 21.29: Markers [52]

| Description   | Marking  | Catalog Number | Std Pack[53] |    |
|---|--|----------------|--------------|----|
|  <p>Black horizontal markings on white background<br/>For 5.2 mm (0.21 in.) wide blocks<br/>Lateral sides for NSYTRV terminal blocks<br/>Central shaft for NSYTRR / NSYTRP / NSYTRH terminal blocks</p>                    | 1 to 10  | NSYTRAB510     | 10           |    |
|   | 11 to 20   | NSYTRAB520     | 10           |    |
|   | 21 to 30   | NSYTRAB530     | 10           |    |
|   | 31 to 40   | NSYTRAB540     | 10           |    |
|   | 41 to 50   | NSYTRAB550     | 10           |    |
|   | 51 to 60   | NSYTRAB560     | 10           |    |
|   | 61 to 70   | NSYTRAB570     | 10           |    |
|   | 71 to 80   | NSYTRAB580     | 10           |    |
|   | 81 to 90   | NSYTRAB590     | 10           |    |
|   | 91 to 100  | NSYTRAB5100    | 10           |    |
|   | 1 to 100   | NSYTRAB51100   | 1            |    |
|   | L1, L2, L3, N, PE  | NSYTRAB5L1N    | 10           |    |
|   |  <p>Black horizontal markings on white background<br/>For 6.2 mm (0.24 in.) wide blocks<br/>Lateral sides for NSYTRV terminal blocks<br/>Central shaft for NSYTRR / NSYTRP / NSYTRH terminal blocks</p>                   | 1 to 10        | NSYTRAB610   | 10 |
|   |  | 11 to 20       | NSYTRAB620   | 10 |
|   |  | 21 to 30       | NSYTRAB630   | 10 |
| 31 to 40  |  | NSYTRAB640     | 10           |    |
| 41 to 50  |  | NSYTRAB650     | 10           |    |
| 51 to 60  |  | NSYTRAB660     | 10           |    |
| 61 to 70  |  | NSYTRAB670     | 10           |    |
| 71 to 80  |  | NSYTRAB680     | 10           |    |
| 81 to 90  |  | NSYTRAB690     | 10           |    |
| 91 to 100   |  | NSYTRAB6100    | 10           |    |
| 1 to 100  |  | NSYTRAB61100   | 1            |    |
| L1, L2, L3, N, PE   |  | NSYTRAB6L1N    | 10           |    |
|  <p>Black horizontal markings on white background<br/>For 8.2 mm (0.32 in.) wide blocks<br/>Lateral sides for NSYTRV terminal blocks<br/>Central shaft for NSYTRR / NSYTRP / NSYTRH terminal blocks</p>                    |  | 1 to 10        | NSYTRAB810   | 10 |
|   |  | 11 to 20       | NSYTRAB820   | 10 |
|   |  | 21 to 30       | NSYTRAB830   | 10 |
|   | 31 to 40   | NSYTRAB840     | 10           |    |
|   | 41 to 50   | NSYTRAB850     | 10           |    |
|   | 51 to 60   | NSYTRAB860     | 10           |    |
|   | 61 to 70   | NSYTRAB870     | 10           |    |
|   | 71 to 80   | NSYTRAB880     | 10           |    |
|   | 81 to 90   | NSYTRAB890     | 10           |    |
|   | 91 to 100  | NSYTRAB8100    | 10           |    |
|   | 1 to 100   | —              | —            |    |
|   | L1, L2, L3, N, PE  | —              | —            |    |
|   |  <p>Flat markers<br/>Black horizontal markings on white background<br/>Lateral sides for NSYTRV terminal blocks<br/>Central shaft for NSYTRR / NSYTRP / NSYTRH terminal block</p>                                       | 1 to 10        | NSYTRAB1010  | 10 |
|   |  | 11 to 20       | NSYTRAB1020  | 10 |
|   |  | 21 to 30       | NSYTRAB1030  | 10 |
| 31 to 40  |  | NSYTRAB1040    | 10           |    |
| 41 to 50  |  | NSYTRAB1050    | 10           |    |
| 51 to 60  |  | NSYTRAB1060    | 10           |    |
| 61 to 70  |  | NSYTRAB1070    | 10           |    |
| 71 to 80  |  | NSYTRAB1080    | 10           |    |
| 81 to 90  |  | NSYTRAB1090    | 10           |    |
| 91 to 100   |  | NSYTRAB10100   | 10           |    |
| 1 to 100  |  | —              | —            |    |
| L1, L2, L3, N, PE   |  | —              | —            |    |
|  <p>Flat markers<br/>Black horizontal markings on white background<br/>For 5.2 mm (0.21 in.) wide blocks<br/>Lateral sides for NSYTRV terminal blocks<br/>Central shaft for NSYTRR / NSYTRP / NSYTRH terminal blocks</p> |  | 1 to 10        | NSYTRABF510  | 10 |
|   |  | 11 to 20       | NSYTRABF520  | 10 |
|   |  | 21 to 30       | NSYTRABF530  | 10 |
|   | 31 to 40   | NSYTRABF540    | 10           |    |
|   | 41 to 50   | NSYTRABF550    | 10           |    |
|   | 51 to 60   | —              | —            |    |
|   | 61 to 70   | —              | —            |    |
|   | 71 to 80   | —              | —            |    |
|   | 81 to 90   | —              | —            |    |
|   | 91 to 100  | —              | —            |    |
|   | 1 to 100   | —              | —            |    |
|   | L1, L2, L3, N, PE  | —              | —            |    |
|   |  <p>Flat markers<br/>Black horizontal markings on white background<br/>For 6.2 mm (0.24 in.) wide blocks<br/>Lateral sides for NSYTRV terminal blocks<br/>Central shaft for NSYTRR / NSYTRP / NSYTRH terminal block</p> | 1 to 10        | NSYTRABF610  | 10 |
|   |  | 11 to 20       | NSYTRABF620  | 10 |
|   |  | 21 to 30       | NSYTRABF630  | 10 |
| 31 to 40  |  | NSYTRABF640    | 10           |    |
| 41 to 50  |  | NSYTRABF650    | 10           |    |
| 51 to 60  |  | —              | —            |    |
| 61 to 70  |  | —              | —            |    |
| 71 to 80  |  | —              | —            |    |
| 81 to 90  |  | —              | —            |    |
| 91 to 100   |  | —              | —            |    |
| 1 to 100  |  | —              | —            |    |
| L1, L2, L3, N, PE   |  | —              | —            |    |





NOTE: Refer to catalog 9080CT1301 for additional labeling options.

[52] Some products may be discontinued. Refer to www.se.com/us for the most current product information.  
[53] For blocks 12.2 mm (0.48 in.) or wider, the strip must be broken and the individual marking characters used.



**Lineray Labeling System**

**Table 21.30: Blank Markers** [54]

| Description   |                                   | Catalog Number | Std. Pack |
|---|-----------------------------------|----------------|-----------|
| <br>Blank marking cards for 5.2 mm (0.21 in.) wide blocks        | 72 characters (6 strips)          | NSYTRABPV5     | 10        |
|   | Plotter adapter for marking cards | NSYTRABMP1     | 1         |
| <br>Blank marking cards for 6.2 mm (0.24 in.) wide blocks        | 60 characters (6 strips)          | NSYTRABPV6     | 10        |
|   | Plotter adapter for marking cards | NSYTRABMP1     | 1         |
| <br>Blank marking cards for 8.2 mm (0.32 in.) wide blocks        | 42 characters (6 strips)          | NSYTRABPV8     | 10        |
|   | Plotter adapter for marking cards | NSYTRABMP1     | 1         |
| <br>Blank flat marking cards for 5.2 mm (0.21 in.) wide blocks  | 72 characters (6 strips)          | NSYTRABFPV5    | 10        |
|   | Plotter adapter for marking cards | NSYTRABMP2     | 1         |
| <br>Blank flat marking cards for 6.2 mm (0.24 in.) wide blocks | 60 characters (6 strips)          | NSYTRABFPV6    | 10        |
|   | Plotter adapter for marking cards | NSYTRABMP2     | 1         |

RoHS Compliant





**NOTE:** Refer to catalog **9080CT1301** for additional labeling options.

[54] Some products may be discontinued. Refer to www.se.com/us for the most current product information.

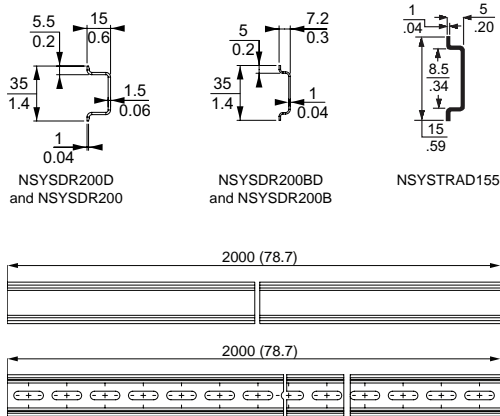
Mounting Track and End Clamps

Table 21.31: DIN 3 Track—78.74 inches (2 meter) length [1]



| Description   | Length |      | Catalog Number | Std. Pack [2] |
|---|--------|------|----------------|---------------|
|   | In.    | mm   |                |               |
| <b>DIN 3</b>  |        |      |                |               |
| Symmetrical rail 35x15 mm depth, 1.5 mm thick galvanized steel, Prepunched  | 78.74  | 2000 | NSYSR200D      | 20            |
| Symmetrical rail 35x15 mm depth, 1.5 mm thick galvanized steel, No mounting holes   | 78.74  | 2000 | NSYSR200       | 20            |
| Symmetrical rail 35x7.2 mm depth, 1 mm thick galvanized steel, Prepunched   | 78.74  | 2000 | NSYSR200BD     | 20            |
| Symmetrical rail 35x7.2 mm depth, 1 mm thick galvanized steel, No mounting holes  | 78.74  | 2000 | NSYSR200B      | 20            |
| <b>DIN 2</b>  |        |      |                |               |
| Symmetrical rail 15x5 mm depth, 1 mm thick galvanized steel, Prepunched   | 78.74  | 2000 | NSYTRAD155     | 5             |
| <b>End Clamps</b>   |        |      |                |               |
| <br>Plastic clip-on end clamp for 35 mm DIN 3 track            | 0.21   | 5.2  | NSYTRAAB35     | 50            |
| <br>Plastic clip-on end clamp with screw for 35 mm DIN 3 track | 0.37   | 9.5  | NSYTRAABV35    | 50            |
| <br>Plastic clip-on end clamp for 15 mm DIN 2 track            | 0.21   | 5.2  | NSYTRAAB15     | 50            |
| <br>Polycarbonate end clamp for 35 mm DIN 3 track             | 0.31   | 8    | 9080MHA10      | 50            |
| RoHS Compliant  |        |      |                |               |

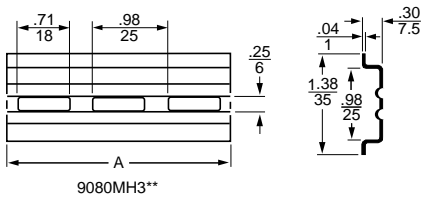
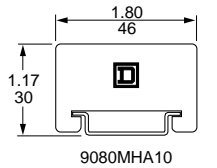





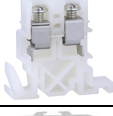

Table 21.32: DIN 3 Track – Various Lengths [1]



| Description                         | Length  |       | Class 9080 Type | Std. [2] Pack |           |
|-------------------------------------|---|-------|-----------------|---------------|-----------|
|                                     | In.   | mm    |                 |               |           |
| Galvanized steel, no mounting holes | 3   | 0.08  | 9080MH203       | 10            |           |
|                                     | 6   | 0.15  | 9080MH206       |               |           |
|                                     | 7   | 0.18  | 9080MH207       |               |           |
|                                     | 8   | 0.20  | 9080MH208       |               |           |
|                                     | 12  | 0.30  | 9080MH212       |               |           |
|                                     | 16  | 0.41  | 9080MH216       |               |           |
|                                     | 19.68   | 500   | 9080MH220       |               |           |
|                                     | 39.37   | 1000  | 9080MH239       |               |           |
|                                     | 78.74   | 2000  | 9080MH279       |               |           |
|                                     | Symmetrical rail 35 x 7.5 mm (1.38 in. x 0.295 in.) in compliance with EN 50022 standard (DIN 46277-3). | 3     | 0.08            |               | 9080MH303 |
| 4                                   |   | 0.10  | 9080MH304       |               |           |
| 5                                   |   | 0.13  | 9080MH305       |               |           |
| 6                                   |   | 0.15  | 9080MH306       |               |           |
| 7                                   |   | 0.18  | 9080MH307       |               |           |
| 8                                   |   | 0.20  | 9080MH308       |               |           |
| 9                                   |   | 0.23  | 9080MH309       |               |           |
| 10                                  |   | 0.25  | 9080MH310       |               |           |
| 11                                  |   | 0.28  | 9080MH311       |               |           |
| 12                                  |   | 0.30  | 9080MH312       |               |           |
| 13                                  |   | 0.33  | 9080MH313       |               |           |
| 14                                  |   | 0.36  | 9080MH314       |               |           |
| 15                                  |   | 0.38  | 9080MH315       |               |           |
| 16                                  |   | 0.41  | 9080MH316       |               |           |
| 17                                  |   | 0.43  | 9080MH317       |               |           |
| 18                                  |   | 0.46  | 9080MH318       |               |           |
| 19.68                               |   | 500   | 9080MH320       |               |           |
| 39.37                               |   | 1000  | 9080MH339       |               |           |
| 78.74                               |   | 2000  | 9080MH379       |               |           |
| High rise track                     | Aluminum  | 39.37 | 1000            | 9080MH439     | 2         |

[1] Some products may be discontinued. Refer to www.se.com/us for the most current product information.  
[2] Orders must specify the standard package quantity (Std. Pack) or multiples of that quantity.

**Selection Guide**

**Table 21.33: Type G Selection Guide [1]**

| Description   | Max. Voltage | Max. Current [2] | Blocks     |          |               | End Barriers [3] |               | Blocks per ft. | Maximum Wire Combinations              |   |                              |
|---|--------------|------------------|------------|----------|---------------|------------------|---------------|----------------|--|---|------------------------------|
|   |              |                  | Color      | Type     | Std. Pack [4] | Type             | Std. Pack [4] |                | Copper Wire (stranded or solid)        |   |                              |
|  <p>Solderless Box Lug for #22 to #8 AWG wire. Mounts on standard 9080GH track or 35 mm DIN 3 track. Fingersafe per DIN 60529.</p>               | 600 V        | 60 A             | Natural    | 9080GR6  | 50            | 9080GM6B         | 10            | 34             | 1 #8                                   | 1-4 #16<br>1-5 #18<br>1-8 #20<br>1-10 #22 |                              |
|   |              |                  | Black      | 9080GRB6 |               | 9080GMB6B        |               |                |  |   |                              |
|   |              |                  | Blue [1]   | 9080GRL6 |               | 9080GML6B        |               |                |  |   |                              |
|   |              |                  | Green [1]  | 9080GRG6 |               | 9080GMG6B        |               |                |  |   |                              |
|   |              |                  | Gray       | 9080GRE6 |               | 9080GME6B        |               |                |  |   |                              |
|   |              |                  | Orange [1] | 9080GRS6 |               | 9080GMS6B        |               |                |  |   |                              |
|   |              |                  | Red        | 9080GRR6 |               | 9080GMR6B        |               |                |  |   |                              |
|   |              |                  | Yellow [1] | 9080GRY6 |               | 9080GMY6B        |               |                |  |   |                              |
|   |              |                  | Brown [1]  | 9080GRN6 |               | 9080GMN6B        |               |                |  |   |                              |
|  <p>Solderless Box Lug for #22 to #10 AWG wire. Can be mounted directly to a panel or can be mounted on 9080GH track.</p>                        | 600 V        | 40 A             | Natural    | 9080GK6  | 50            | 9080GK6B         | 50            | 34             | 1-4 #16<br>1 #10<br>1-2 #12<br>1-2 #14 | 1-4 #16<br>1-5 #18<br>1-8 #20<br>1-10 #22 |                              |
|   |              |                  | Black      | 9080GKB6 |               |                  |               |                |  |   |                              |
|   |              |                  | Blue       | 9080GKL6 |               |                  |               |                |  |   |                              |
|   |              |                  | Green      | 9080GKG6 |               |                  |               |                |  |   |                              |
|   |              |                  | Gray [1]   | 9080GKE6 |               |                  |               |                |  |   |                              |
|   |              |                  | Orange     | 9080GKS6 |               |                  |               |                |  |   |                              |
|   |              |                  | Red        | 9080GKR6 |               |                  |               |                |  |   |                              |
| Yellow [1]  | 9080GKY6     |                  |            |          |               |                  |               |                |  |   |                              |
|  <p>High Density Solderless Box Lug for #22 to #10 AWG wire. Mounts on standard 9080GH track or 35 mm DIN 3 track. Fingersafe per DIN 60529.</p> | 600 V        | 30 A             | Natural    | 9080GM6  | 50            | 9080GM6B         | 10            | 51             | 1 #10<br>1 #12<br>1 #14<br>1-2 #16     | 1-2 #18<br>1-5 #20<br>1-8 #22<br>1-2 #16  |                              |
|   |              |                  | Black      | 9080GMB6 |               | 9080GMB6B        |               |                |  |   |                              |
|   |              |                  | Blue [1]   | 9080GML6 |               | 9080GML6B        |               |                |  |   |                              |
|   |              |                  | Green [1]  | 9080GMG6 |               | 9080GMG6B        |               |                |  |   |                              |
|   |              |                  | Gray       | 9080GME6 |               | 9080GME6B        |               |                |  |   |                              |
|   |              |                  | Orange [1] | 9080GMS6 |               | 9080GMS6B        |               |                |  |   |                              |
|   |              |                  | Red        | 9080GMR6 |               | 9080GMR6B        |               |                |  |   |                              |
|   |              |                  | Yellow [1] | 9080GMY6 |               | 9080GMY6B        |               |                |  |   |                              |
|   |              |                  | Brown [1]  | 9080GMN6 |               | 9080GMN6B        |               |                |  |   |                              |
|  <p>Solderless Box Lug for #18 to #4 AWG wire. Mounts on standard 9080GH track or 35 mm DIN 3 track.</p>   | 600 V        | 85 A             | Natural    | 9080GC6  | 50            | 9080GC6B         | 10            | 28             | 1 #4<br>1 #6<br>1-2 #8<br>1-4 #10      | 1-5 #12<br>1-6 #14<br>1-6 #16<br>1-8 #18  |                              |
|  <p>Solderless Box Lug for #12 to #1/0 AWG wire. Mounts on standard 9080GH track or 35 mm DIN 3 track.</p>                                     | 600 V        | 170 A            | Natural    | 9080GD6  | 10            | 9080GD6B         | 10            | 17             | 1 1/0<br>1 #1<br>1 #2<br>1-2 #4        | 1-3 #6<br>1-5 #8<br>1-6 #10<br>1-7 #12    |                              |
|  <p>Solderless Box Lug for #6 AWG to 250 kcmil wire. [5] Mounts on standard 9080GH track or 35 mm DIN 3 track.</p>                             | 600 V        | 255 A            | Natural    | 9080GE6  | 10            | None Required    | 10            | 10             | 1 250 kcmil [5]                        |   |                              |
|   |              |                  |            |          |               |                  |               |                |  | 1 4/0<br>1 3/0<br>1 2/0<br>1 1/0          | 1 #1<br>1 #2<br>1 #4<br>1 #6 |

 File: E60616  
 CCN: XCFR2  
 File: 062144  
 Class:3211-07  
 RoHS Compliant

For standard or custom assemblies, see [Terminal Block Assemblies, page 21-21](#).  
 For mounting track and accessories, see [Mounting Track, End Clamps, Jumpers, Fanning Strips, page 21-22](#).  
 For DIN 3 track and end clamps, see [Mounting Track and End Clamps, page 21-18](#).





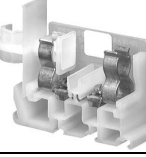

**Table 21.34: How to Order**

| To Order Specify | Catalog Number |      |
|------------------|----------------|------|
| • Class Number   | Class          | Type |
| • Type Number    | 9080           | GR6  |

[1] Some products may be discontinued. Refer to www.se.com/us for the most current product information.  
 [2] These maximum current values assume the use of insulated copper conductors with 75 °C (167 °F) temperature rating, temperature rating, and are calculated based on NEC Article 310, Table 310-16. In most cases this value is the maximum ampacity of that wire or combination of wires (as listed in the above table) which has the greatest current carrying capacity. The actual allowable current for a particular application depends on the number, size, insulation class, and other characteristics of the wires used. The lower of the UL and CSA ratings are shown.  
 [3] One end-barrier is required for each assembly of like blocks.  
 [4] Orders must specify standard package quantity or multiples of that quantity.  
 [5] Terminals are tin plated, making them suitable for use with either copper or aluminum wire.

Selection Guide

Table 21.35: Type G Selection Guide [6]

| Description  | Max. Voltage | Max. Current [7] | Blocks      |               | End Barriers [8] |                | Bloc-ks per ft. | Maximum Wire Combinations              |  |
|--|--------------|------------------|-------------|---------------|------------------|----------------|-----------------|--|--|
|  |              |                  | Type        | Std. Pack [9] | Type             | Std. Pack [10] |                 | Copper Wire (stranded or solid)        |  |
|  Self-Lifting Pressure Wire Connector for #18 to #12 AWG wire. Mounts on standard 9080GH track or 35 mm DIN 3 track.  | 600 V        | 40 A             | 9080GP6     | 50            | 9080GP6B         | 10             | 32              | 1 or 2<br>1 or 2<br>1 or 2<br>1 or 2   | #12<br>#14<br>#16<br>#18               |
|  Flat Terminal Connector for #22 to #12 AWG wire. Screws are #6-32 x 5/16 in. for ring or spade lugs, 5/16 in. wide maximum. Mounts on standard 9080GH track or 35 mm DIN 3 track. Fingersafe per DIN 60529.                                | 600 V        | 40 A             | 9080GA6     | 50            | 9080GP6B         | 10             | 32              | 1 or 2 Conductors Per Screw #12–22     |  |
|  Circuit Isolating Switch [11] with self-lifting pressure connectors for #18 to #10 AWG wire. Mounts on standard 9080GH track or 35 mm DIN 3 track.   | 600 V        | 30 A             | 9080GG6 [6] | 10            | 9080GF6B         | 10             | 16              | 1<br>1<br>1<br>1-4<br>1-4              | #10<br>#12<br>#14<br>#16<br>#18        |
|  Slip-on Connectors for #22 to #12 AWG wire. Tabs accept 0.250 x 0.032 in. slip-on connectors. Mounts on standard 9080GH track or 35 mm DIN 3 track.  | 600 V        | 20 A             | 9080GS6     | 10            | 9080GF6B         | 10             | 16              | 1-2<br>1-2<br>1-2<br>1-2<br>1-2<br>1-2 | #12<br>#14<br>#16<br>#18<br>#20<br>#22 |
|  Fuse Block for 13/32 in. Dia. x 1-1/2 in. ferrule fuse with self-lifting pressure connectors. Fuse puller is included as standard. Fuses are not included. Mounts on standard 9080GH track or 35 mm DIN 3 track. Fingersafe per DIN 60529. | 600 V        | 30 A             | 9080GF6     | 10            | 9080GF6B         | 10             | 16              | 1<br>1<br>1<br>1-4<br>1-4              | #10<br>#12<br>#14<br>#16<br>#18        |
|  Fuse Puller [12]   | —            | —                | 9080GH63    | 50            | N/A              |                | N/A             | N/A                                    |  |
|  Blown Fuse Indicator/ Pullers are neon pilot lights which plug on to the fuse in a standard Type GF6 fuse block.   | 120–240 V    | —                | 9080GLP3    | 10            | N/A              |                | N/A             | N/A                                    |  |
|  | 277–600 V    | —                | 9080GLP6    | 10            | N/A              |                | N/A             |  |  |

For standard or custom assemblies, see [Terminal Block Assemblies, page 21-21](#).  
For mounting track and accessories, see [Mounting Track, End Clamps, Jumpers, Fanning Strips, page 21-22](#).  
For DIN 3 track and end clamps, see [Mounting Track and End Clamps, page 21-18](#).

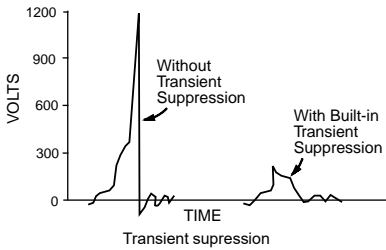

Table 21.36: How to Order

| To Order Specify | Catalog Number |      |
|------------------|----------------|------|
| • Class Number   | Class          | Type |
| • Type Number    | 9080           | GP6  |

Terminal Blocks:



File: E60616  
CCN: XCFR2



File: 062144  
Class: 3211-07



RoHS Compliant

Blown Fuse Indicator:



File: E63698  
CCN: JDV5



File: 025490  
Class: 3211-07

RoHS Compliant

[6] Some products may be discontinued. Refer to www.se.com/us for the most current product information.  
[7] These maximum current values assume the use of insulated copper conductors with 75 °C (167 °F) temperature rating, and are calculated based on NEC Article 310, Table 310-16. In most cases this value is the maximum ampacity of that wire or combination of wires (as listed in the above table) which has the greatest current carrying capacity. The actual allowable current for a particular application depends on the number, size, insulation class, and other characteristics of the wires used. The lower of the UL and CSA ratings are shown.  
[8] One end-barrier is required for each assembly of like sections.  
[9] Orders must specify standard package quantity or multiples of that quantity.  
[10] Orders must specify standard package quantity or multiples of that quantity.  
[11] Not intended to make or break a live circuit. Power must be disconnected from the circuit before operation of the switch.  
[12] Fuse puller is supplied as standard with Class 9080 Type GF6 fuse block. The 9080GH63 is a replacement fuse puller.

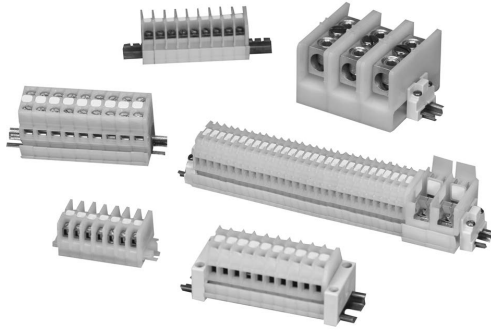

**Terminal Block Assemblies**  
**Custom Terminal Block Assemblies**

Order an assembly built as required for the application. As standard, custom assemblies use 9080GH mounting track with screw on end clamps. Other options are available from the table below.

**One terminal block type:** The number of blocks in the assembly is added to the end of the catalog number of the desired block. Example: an assembly of **25** 9080GR6 blocks would be **9080GR625**.

**More than one terminal block type in an assembly:** A detailed drawing or sketch of the desired assembly must accompany the order.

**Table 21.37: Custom Terminal Block Assembly Options [13]**

| Option   | Suffix     | Example          |
|--|------------|------------------|
| Substitute slip-in end clamps                      | <b>C</b>   | 9080GR625C       |
| Substitute snap-off channel                        | <b>B</b>   | 9080GR625BC [14] |
| For direct mount assembly of 9080GK6 blocks        | <b>D</b>   | 9080GK67D        |
| Add a blank vinyl marking strip                    | <b>M</b>   | 9080GR625M       |
| Add pre-marked (1–25 only) marking strip           | <b>MPO</b> | 9080GR625MPO     |
| Mount on 35 mm DIN 3 track instead of 9080GH track | <b>T</b>   | 9080GR625T       |

**Table 21.38: How to Order**

| To Order Specify  | Catalog Number |       |
|---|----------------|-------|
| <ul style="list-style-type: none"> <li>• Class Number</li> <li>• Type Number</li> </ul> | Class          | Type  |
|   | 9080           | GA612 |

[13] Some products may be discontinued. Refer to www.se.com/us for the most current product information.

[14] The 9080GH10 screw-on end clamp is **not** recommended for use with snap-off channel. It is recommended that the 9080GH11 slip-in end clamp be used. Therefore, when the suffix **B** is used, it should be followed by the suffix **C**.

Mounting Track, End Clamps, Jumpers, Fanning Strips

Table 21.39: 3/4 in. Mounting Track [15]

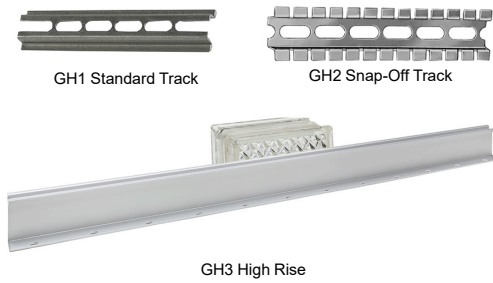

| Style          | Length (in.) | Type      | Std. Pack [16] |
|----------------|--------------|-----------|----------------|
| Standard Track | 3            | 9080GH103 | 5              |
|                | 4            | 9080GH104 | 5              |
|                | 5            | 9080GH105 | 5              |
|                | 6            | 9080GH106 | 5              |
|                | 7            | 9080GH107 | 5              |
|                | 8            | 9080GH108 | 5              |
|                | 9            | 9080GH109 | 5              |
|                | 10           | 9080GH110 | 5              |
|                | 12           | 9080GH112 | 5              |
|                | 13           | 9080GH113 | 5              |
|                | 14           | 9080GH114 | 5              |
|                | 15           | 9080GH115 | 5              |
|                | 16           | 9080GH116 | 5              |
|                | 18           | 9080GH118 | 5              |
|                | 24           | 9080GH124 | 5              |
| Snap-Off Track | 36           | 9080GH136 | 5              |
|                | 48           | 9080GH148 | 5              |
|                | 72           | 9080GH172 | 5              |
| High Rise      | 36           | 9080GH236 | 20             |
|                | 48           | 9080GH248 | 20             |
|                | 72           | 9080GH272 | 20             |
|                | 36           | 9080GH336 | 2              |

NOTE: For additional track and appropriate end clamps, see Mounting Track and End Clamps, page 21-18.

Table 21.40: End Clamps, Jumpers, and Fanning Strips [15]







| Description  | Type      | Std. Pack [16] |
|--|-----------|----------------|
| <b>End Clamps</b>  |           |                |
| Screw-on End Clamp (Not recommended for use on snap-off mounting track)  | 9080GH10  | 50             |
| (Discontinued) Slip-in End Clamp (Not for use with 9080 GE6, GK6 blocks) | 9080GH11  | 50             |
| <b>Jumpers</b>   |           |                |
| (Discontinued) 2-pole jumper for GM6                                     | 9080GH700 | 20             |
| 6-pole jumper for GM6  | 9080GH710 | 10             |
| 6-pole jumper for GK6, GR6   | 9080GH73  | 10             |
| 2-pole jumper for GC6  | 9080GH74  | 10             |
| 6-pole jumper for GC6  | 9080GH75  | 10             |
| 2-pole jumper for GD6  | 9080GH76  | 10             |
| 2-pole jumper for GA6, GP6   | 9080GH78  | 10             |
| (Discontinued) 6-pole jumper for GA6, GP6                                | 9080GH79  | 10             |
| <b>Fanning Strips</b>  |           |                |
| (Discontinued) Snap-together fanning strip section for GK6, GR6 blocks   | 9080GH52  | 10             |

[15] Some products may be discontinued. Refer to www.se.com/us for the most current product information.

[16] Orders must specify the standard package quantity (Std. Pack) or multiples of that quantity.

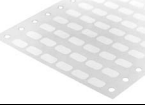
### Marking Accessories

**Table 21.41: Marking and Additional Accessories [17]**

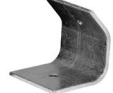
| Description  | Type         | Std. Pack [18] |   |
|--|--------------|----------------|---|
| <br>25 ft blank vinyl marking strip   | 9080GH220    | 1              |   |
| Vinyl marking strip numbered 1-25<br>   | For GK6, GR6 | 9080GH21       | 5 |
|  | For GA6, GP6 | 9080GH22       | 5 |
|  | For GM6      | 9080GH230      | 5 |
| <br>Blank pin-feed marking tabs—6 x 20 (total 120) marking tabs for GD6, GR6, and GT6 blocks  | 9080GH200    | 20             |   |
| <br>Pre-marked 01 to 50 (2 sets) plus 20 various marking tabs (total 120 marking tabs) for GD6, GR6, and GT6 blocks   | 9080GH210    | 5              |   |
| <br>Marking strip end plug for GK6, GR6, GM6, GA6, GP6, GC6, GD6, GE6, and GT6 blocks   | 9080GH60     | 50             |   |
| <br>Transition barrier between GK6 and all other G blocks   | 9080GH61     | 50             |   |
| <br>Cover for GR6 or GR6T blocks  | 9080GH62     | 50             |   |
| <br>(Discontinued)<br>Angle bracket kit—for mounting 9080GH or MH track to panel at 45° angle. Includes 2 brackets and hardware for mounting the track to the brackets | 9080MH82     | 1              |   |

**Table 21.42: How to Order**

| To Order Specify  | Catalog Number |      |
|---|----------------|------|
| <ul style="list-style-type: none"> <li>• Class Number</li> <li>• Type Number</li> </ul> | Class          | Type |
|   | 9080 (prefix)  | GH10 |

[17] Some products may be discontinued. Refer to [www.se.com/us](http://www.se.com/us) for the most current product information.

[18] Orders must specify the standard package quantity (Std. Pack) or multiples of that quantity.



GCB100

GCB Thermal-Magnetic Circuit Protectors

Table 21.43: 9080GCB Thermal-Magnetic Circuit Protectors [1]

| Maximum Current [2] | Internal Resistance Ω | Maximum Voltage   | Catalog Number    |            |
|---------------------|-----------------------|-------------------|-------------------|------------|
| 0.1                 | 133                   | 250 Vac<br>65 Vdc | 9080GCB01         |            |
| 0.5                 | 6.6                   |                   | 9080GCB05         |            |
| 0.8                 | 2.55                  |                   | 9080GCB08         |            |
| 1.0                 | 1.97                  |                   | 9080GCB10         |            |
| 1.2                 | 1.22                  |                   | 9080GCB12         |            |
| 1.5                 | 0.86                  |                   | 9080GCB15         |            |
| 2.0                 | 0.49                  |                   | 9080GCB20         |            |
| 2.5                 | 0.31                  |                   | 9080GCB25         |            |
| 3.0                 | 0.20                  |                   | 9080GCB30         |            |
| 4.0                 | 0.10                  |                   | 9080GCB40         |            |
| 5.0                 | 0.08                  |                   | 9080GCB50         |            |
| 7.0                 | 0.03                  |                   | 9080GCB70         |            |
| 10.0                | <0.02                 |                   | 125 Vac<br>65 Vdc | 9080GCB100 |
| 15.0                | <0.02                 |                   |                   | 9080GCB150 |

Table 21.44: Inrush Ratio Correction Table

NOTE: For resistive loads, use inrush correction factor of 1.0.

| Inrush Ratio | 1:1 to 1:4 | 1:5 | 1:6 | 1:7 | 1:8 |
|--------------|------------|-----|-----|-----|-----|
| Factor       | 1.3        | 1.4 | 1.5 | 1.6 | 1.7 |

Table 21.45: Ambient Temperature Correction Table

| Ambient Temperature | 70 °F<br>(21.1 °C) | 100 °F<br>(37.8 °C) | 120 °F<br>(48.9 °C) | 140 °F<br>(60 °C) | 160 °F<br>(71.1 °C) | 180 °F<br>(82.2 °C) | 200 °F<br>(93.3 °C) |
|---------------------|--------------------|---------------------|---------------------|-------------------|---------------------|---------------------|---------------------|
| Factor              | 1.0                | 1.1                 | 1.2                 | 1.3               | 1.4                 | 1.5                 | 1.6                 |

Table 21.46: Tripping Times in Seconds at 70 °F (21.1 °C)

NOTE: When several protectors are channel mounted adjacent to each other, the "no trip" current will be 80% of rated current at 70 °F.

| Percent Rated Current | 100%    | 200%  | 300% | 400%  | 500%  | 600%    | 1000%   | 2000% and greater |
|-----------------------|---------|-------|------|-------|-------|---------|---------|-------------------|
| Tripping Time (s)     | no trip | 10–40 | 38   | 1.5–9 | 0.8–6 | 0.003–4 | 0.003–2 | Max. 0.02         |

Selection

To properly select a Class 9080 Type GCB circuit protector, follow these steps:

- Determine the inrush correction factor from Table 21.44.
- Determine the temperature correction factor from Table 21.45.
- Determine the sealed current of the load that is being protected.
- Multiply the sealed current by the two correction factors and choose the closest circuit protector.

NOTE: Choosing a circuit protector with a value lower than the calculated value might cause nuisance tripping, while choosing the larger might provide a protector that will not properly protect the load .



File: E233026  
CCN:QVNU2



File: 025490  
Class: 3211-07



Example: Solenoid with sealed current of 0.75 A, an inrush ratio of 1:6, and in an ambient temperature of 85°F: 0.75 x 1.5 x 1.05 = 1.18. Choose the 1.2 A protector.

Tripping Time: Tripping time of the circuit protector is determined from Table 21.46. Divide the circuit protector value by the temperature correction factor from Table 21.45 to determine actual rated current referenced in Table 21.46.

Table 21.47: How to Order

| To Order Specify | Catalog Number |      |
|------------------|----------------|------|
| • Class Number   | Class          | Type |
| • Type Number    | 9080           | GH10 |

[1] Some products may be discontinued. Refer to www.se.com/us for the most current product information.

[2] These maximum current values assume the use of insulated copper conductors with 167 °F (75 °C) temperature rating and are calculated based on NEC Article 310, Table 310-16. In most cases this value is the maximum ampacity of the wire which has the greatest current carrying capacity. The actual allowable current for a particular application depends on the size, insulation class, and other characteristics of the wire used. The UL ratings are shown. The CSA rating may be higher or lower. Refer to the catalog for CSA ratings.



**GB2 Thermal-Magnetic Circuit Protectors**

**Table 21.48: GB2CB One Pole Thermal-Magnetic Circuit Protectors [1]**



1-Pole GB2CB

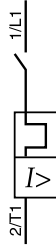

| Description                                 | Max. Voltage | Thermal Rating | Catalog Number [2] |
|---|--------------|----------------|--------------------|
| One pole Thermal Magnetic Circuit Protector | 300 Vac      | 0.5 A          | GB2CB05            |
|   |              | 1 A            | GB2CB06            |
|   |              | 2 A            | GB2CB07            |
|   |              | 3 A            | GB2CB08            |
|   |              | 4 A            | GB2CB09            |
|   |              | 5 A            | GB2CB10            |
|   |              | 6 A            | GB2CB12            |
|   |              | 8 A            | GB2CB14            |
|   |              | 10 A           | GB2CB16            |
|   |              | 12 A           | GB2CB20            |



File: 081630  
Class: 3215-30



IEC 157-1  
VDE 0660

**Table 21.49: GB2CD Two Pole Thermal-Magnetic Circuit Protectors [1]**



2-Pole GB2CD

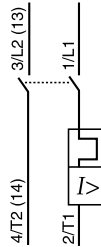

| Description                                 | Max. Voltage | Thermal Rating | Catalog Number [2] |
|---|--------------|----------------|--------------------|
| Two pole Thermal Magnetic Circuit Protector | 300 Vac      | 0.5 A          | GB2CD05            |
|   |              | 1 A            | GB2CD06            |
|   |              | 2 A            | GB2CD07            |
|   |              | 3 A            | GB2CD08            |
|   |              | 4 A            | GB2CD09            |
|   |              | 5 A            | GB2CD10            |
|   |              | 6 A            | GB2CD12            |
|   |              | 8 A            | GB2CD14            |
|   |              | 10 A           | GB2CD16            |
|   |              | 12 A           | GB2CD20            |



File: 081630  
Class: 3215-30



IEC 157-1  
VDE 0660

[1] Some products may be discontinued. Refer to www.se.com/us for the most current product information.  
[2] Must order in multiples of 6.

Enclosed Power Distribution Blocks

- Finger safe from the front, for isolation of live parts
- Up to 760 A, to meet a wide range of application needs
- Short-Circuit Current Rating up to 100 kA with fuses, not limited by the 10 kA default
- Panel or 35 mm DIN rail mount, for application flexibility
- Gangable to create multipole configurations
- Flexible stranded wire compliant, expands usability
- The UL Listed blocks meet feeder circuit spacing requirements.
- For the short-circuit current ratings, wire classes, tightening torques, dimensions, and more, see catalog 9080CT9603.

Table 21.50: Power Distribution Blocks with AL Lugs (accepts CU or AL conductors) [1]



| Wire Range  |  | Mounting                      | Current Rating       | Type         |
|---|--|-------------------------------|----------------------|--------------|
| Line Side   | Load Side  |                               |                      |              |
| CU (1) 14-2 AWG (2.5-35 mm <sup>2</sup> )   | CU (4) 14-10 AWG (2.5-6 mm <sup>2</sup> )                                  | 35 mm DIN rail or panel mount | CU 115A              | NSYEBAD11614 |
| CU (1) 14 AWG-3/0 (2.5-70 mm <sup>2</sup> )<br>AL (1) 6 AWG-3/0   | CU (1) 14 AWG-3/0 (2.5-70 mm <sup>2</sup> )<br>AL (1) 6 AWG-3/0            | Panel mount                   | CU 200 A<br>AL 155 A | NSYEBAP12611 |
| CU (1) 14 AWG-3/0 (2.5-70 mm <sup>2</sup> )<br>AL (1) 6 AWG-3/0   | CU (4) 14-2 AWG (2.5-35 mm <sup>2</sup> )<br>AL (4) 6-2 AWG                | 35 mm DIN rail                | CU 200 A<br>AL 155 A | NSYEBAD12614 |
| CU (1) 14 AWG-3/0 (2.5-70 mm <sup>2</sup> )<br>AL (1) 6 AWG-3/0   | CU (4) 14-2 AWG (2.5-35 mm <sup>2</sup> )<br>AL (4) 6-2 AWG                | Panel mount                   | CU 200 A<br>AL 155 A | NSYEBAP12614 |
| CU (1) 6 AWG-400 kcmil (16-185 mm <sup>2</sup> )<br>CU (1) 14 AWG-3/0 (2.5-70 mm <sup>2</sup> )<br>AL (1) 6 AWG-400 kcmil<br>AL (1) 6 AWG-3/0 | CU (8) 14-2 AWG (2.5-35 mm <sup>2</sup> )<br>AL (8) 6-2 AWG                | 35 mm DIN rail                | CU 335 A<br>AL 270 A | NSYEBAD13618 |
| CU (1) 6 AWG-400 kcmil (16-185 mm <sup>2</sup> )<br>CU (1) 14 AWG-3/0 (2.5-70 mm <sup>2</sup> )<br>AL (1) 6 AWG-400 kcmil<br>AL (1) 6 AWG-3/0 | CU (8) 14-2 AWG (2.5-35 mm <sup>2</sup> )<br>AL (8) 6-2 AWG                | Panel mount                   | CU 335 A<br>AL 270 A | NSYEBAP13618 |
| CU (2) 6 AWG-250 kcmil (16-120 mm <sup>2</sup> )<br>AL (2) 6 AWG-250 kcmil  | CU (2) 6 AWG-250 kcmil (16-120 mm <sup>2</sup> )<br>AL (2) 6 AWG-250 kcmil | Panel mount                   | CU 510 A<br>AL 410 A | NSYEBAP25622 |
| CU (2) 4 AWG-500 kcmil (25-240 mm <sup>2</sup> )<br>AL (2) 4 AWG-500 kcmil  | CU (8) 14 AWG-2/0 (2.5-50 mm <sup>2</sup> )<br>AL (8) 6 AWG-2/0 kcmil      | Panel mount                   | CU 760 A<br>AL 620 A | NSYEBAP27628 |

Table 21.51: Power Distribution Blocks with CU Lugs (accepts only CU conductors)



| Wire Range  |  | Mounting       | Current Rating | Type         |
|---|--|----------------|----------------|--------------|
| Line Side   | Load Side  |                |                |              |
| CU (1) 14 AWG-3/0 (2.5-70 mm <sup>2</sup> )   | CU (4) 14-2 AWG (2.5-35 mm <sup>2</sup> )        | 35 mm DIN rail | CU 200 A       | NSYEBCD12614 |
| CU (1) 14 AWG-3/0 (2.5-70 mm <sup>2</sup> )   | CU (4) 14-2 AWG (2.5-35 mm <sup>2</sup> )        | Panel mount    | CU 200 A       | NSYEBCP12614 |
| CU (1) 6 AWG-400 kcmil (16-185 mm <sup>2</sup> )<br>CU (1) 14 AWG-3/0 (2.5-70 mm <sup>2</sup> ) | CU (8) 14-2 AWG (2.5-35 mm <sup>2</sup> )        | Panel mount    | CU 335 A       | NSYEBCP13618 |
| CU (2) 6 AWG-250 kcmil (16-120 mm <sup>2</sup> )  | CU (2) 6 AWG-250 kcmil (16-120 mm <sup>2</sup> ) | Panel mount    | CU 510 A       | NSYEBCP25622 |
| CU (2) 4 AWG-500 kcmil (25-240 mm <sup>2</sup> )  | CU (8) 14 AWG-2/0 (2.5-50 mm <sup>2</sup> )      | Panel mount    | CU 760 A       | NSYEBCP27628 |

Table 21.52: Terminal Plugs (for plugging unused openings)



| Plug Size | For use with               | Type      |
|-----------|----------------------------|-----------|
| 2 AWG     | NSYEB**13618               | NSYEBP2   |
| 2/0 AWG   | NSYEB**13618, NSYEB**27628 | NSYEBP20  |
| 250 kcmil | NSYEB**25622               | NSYEBP250 |
| 400 kcmil | NSYEB**13618               | NSYEBP400 |
| 500 kcmil | NSYEBAP27622, NSYEB**27628 | NSYEBP500 |



UL E323110 QPQS  
All except  
NSYEB\*\*13618 and  
NSYEB\*\*25622



File: 70361  
Class: 6228-01

RoHS  
Compliant



UL E60616 XCFR2  
NSYEB\*\*13618  
NSYEB\*\*25622



CE Marked

UL 94V-0 flammability rating

[1] Some products may be discontinued. Refer to www.se.com/us for the most current product information.

**LB Open Power Distribution Blocks**

**Table 21.53: Aluminum Power Distribution Blocks [2]**

| Lug Wire Range [3] |                  | Aluminum [4]   |                |                 |
|--------------------|------------------|----------------|----------------|-----------------|
| Main               | Branch           | One Pole Type  | Two Pole Type  | Three Pole Type |
| (1) #14-2/0        | (1) #14-2/0      | 9080LBA162101  | 9080LBA262101  | 9080LBA362101   |
| (1) #6-350 kcmil   | (1) #6-350 kcmil | 9080LBA163101  | 9080LBA263101  | 9080LBA363101   |
| (1) #4-600 kcmil   | (1) #4-600 kcmil | 9080LBA164101  | N/A            | 9080LBA364101   |
| (2) #4-350 kcmil   | (2) #4-350 kcmil | 9080LBA165202  | 9080LBA265202  | 9080LBA365202   |
| (2) #6-500 kcmil   | (2) #4-500 kcmil | 9080LBA1652021 | 9080LBA2652021 | 9080LBA3652021  |
| (1) #14-2/0        | (4) #14-4        | 9080LBA162104  | 9080LBA262104  | 9080LBA362104   |
| (1) #14-2/0        | (6) #14-4        | N/A            | N/A            | 9080LBA362106   |
| (1) #6-400 kcmil   | (4) #14-2        | 9080LBA163104  | 9080LBA263104  | 9080LBA363104   |
| (1) #6-400 kcmil   | (6) #14-2        | 9080LBA163106  | 9080LBA263106  | 9080LBA363106   |
| (1) #6-400 kcmil   | (8) #14-2        | 9080LBA164108  | 9080LBA264108  | 9080LBA364108   |
| (1) #4-500 kcmil   | (6) #14-2/0      | 9080LBA165106  | 9080LBA265106  | 9080LBA365106   |
| (1) #4-500 kcmil   | (12) #14-2       | 9080LBA165112  | 9080LBA265112  | 9080LBA365112   |
| (2) #14-2/0        | (6) #14-4        | 9080LBA163206  | 9080LBA263206  | 9080LBA363206   |
| (2) #6-500 kcmil   | (8) #14-2/0      | 9080LBA165208  | 9080LBA265208  | 9080LBA365208   |
| (2) #6-500 kcmil   | (12) #14-4       | 9080LBA165212  | 9080LBA265212  | 9080LBA365212   |



**Table 21.54: Miniature Aluminum Power Distribution Blocks [2]**

| Lug Wire Range [3] |            | Aluminum [4]  |               |                 |
|--------------------|------------|---------------|---------------|-----------------|
| Main               | Branch     | One Pole Type | Two Pole Type | Three Pole Type |
| (1) #14-2          | (1) #14-2  | 9080LBA161101 | N/A           | 9080LBA361101   |
| (1) #14-2          | (4) #18-10 | 9080LBA161104 | 9080LBA261104 | 9080LBA361104   |



**Table 21.55: Copper Power Distribution Blocks [2]**

| Lug Wire Range [3] |                  | Copper [5]    |               |                 |
|--------------------|------------------|---------------|---------------|-----------------|
| Main               | Branch           | One Pole Type | Two Pole Type | Three Pole Type |
| (1) #18-1/0        | (1) #18-1/0      | 9080LBC162101 | N/A           | 9080LBC362101   |
| (1) #6-250 kcmil   | (1) #6-250 kcmil | 9080LBC163101 | N/A           | 9080LBC363101   |
| (1) #14-2/0        | (4) #14-4        | 9080LBC162104 | 9080LBC262104 | 9080LBC362104   |
| (1) #4-500 kcmil   | (6) #14-2        | 9080LBC163106 | 9080LBC263106 | 9080LBC363106   |
| (2) #14-2/0        | (6) #14-4        | 9080LBC163206 | 9080LBC263206 | 9080LBC363206   |
| (2) #4-500 kcmil   | (8) #14-2/0      | 9080LBC165208 | N/A           | 9080LBC365208   |
| (2) #6-500 kcmil   | (12) #14-2       | 9080LBC165212 | N/A           | 9080LBC365212   |

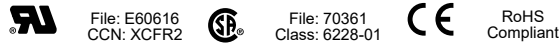

**Table 21.56: Clear Plastic Covers (0.045 in. thick) [2]**

| For LBA Type[6]       | Type     | Dim. A | Dim. B |
|-----------------------|----------|--------|--------|
| LBA161...             | 9080LB11 | 0.824  | 2.31   |
| LBA261...             | 9080LB12 | 1.459  | 2.31   |
| LBA361                | 9080LB13 | 2.094  | 2.31   |
| LBA162..., LBC162     | 9080LB21 | 1.062  | 2.750  |
| LBA262..., LBC262     | 9080LB22 | 1.875  | 2.750  |
| LBA362..., LBC362 [7] | 9080LB23 | 2.688  | 2.750  |
| LBA163..., LBC163     | 9080LB31 | 1.782  | 3.813  |
| LBA263..., LBC263     | 9080LB32 | 3.313  | 3.813  |
| LBA363... LBC363      | 9080LB33 | 4.844  | 3.813  |
| LBA164...             | 9080LB41 | 2.125  | 4.563  |
| LBA264...             | 9080LB42 | 4.000  | 4.563  |
| LBA364...             | 9080LB43 | 5.875  | 4.563  |
| LBA165..., LBC165     | 9080LB51 | 2.719  | 5.313  |
| LBA265..., LBC265     | 9080LB52 | 5.656  | 5.313  |
| LBA365..., LBC365     | 9080LB53 | 8.375  | 5.313  |

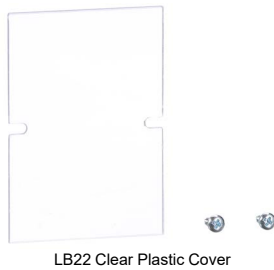

**Table 21.57: How to Order**

| To Order Specify        | Catalog Number |
|-------------------------|----------------|
| • Class Number (prefix) | 9080           |
| • Type Number           | LBA162101      |

**Application Information**

Voltage Rating-Class B and C-600 V

Blocks are rated based on NEC Table 310-16 using 167 °F (75 °C) wire. Aluminum blocks are tin-plated high conductive aluminum. Copper blocks are tin-plated high conductive copper.

Housing material:

- Miniature Blocks are made from high impact thermoplastic rated at 257 °F (125 °C) max. and -40 °F (-40 °C) min.
- Full Size Blocks are made from general purpose phenolic rated at 302 °F (150 °C) max. and -40 °F (-40 °C) min.

[2] Some products may be discontinued. Refer to www.se.com/us for the most current product information.  
 [3] Lugs suitable for use with 75 °C (167 °F) conductors.  
 [4] Aluminum blocks will accept either aluminum or copper conductors.  
 [5] Copper blocks will accept copper conductors only.  
 [6] These covers must be ordered in multiples of 5. Each cover comes with two self-tapping screws.  
 [7] Will not work on a 9080LBA362106 block.

All blocks have a flammability rating of UL 94V-0.  
For the short-circuit current ratings and dimensions, see catalog 9080CT9603.

**Fuseholders and Track Adapter**

**Table 21.58: 250 V—Classes H and R [1]**

| Rating (A) [2] | No. of Poles | Class H    | Class R [3][4] | Lug Wire Range    |
|----------------|--------------|------------|----------------|-------------------|
|                |              | Type       | Type           |                   |
| 30[5]          | 1            | 9080FB1211 | 9080FB1211R    | #14–10<br>Cu      |
|                | 2            | 9080FB2211 | 9080FB2211R    |                   |
|                | 3            | 9080FB3211 | 9080FB3211R    |                   |
| 60[5]          | 1            |            | 9080FB1221R    | #14–2<br>Cu or Al |
|                | 2            |            | 9080FB2221R    |                   |



FB3211

FB3211R

**Application Information [1]**

Clip material:

- All 30 and 60 A fuse clips are copper alloy tin plated.
- All 100 and 200 A fuse clips are one piece aluminum with copper spring tin plated.
- All Class H, R and J fuses are standard with reinforced fuse clips.

Lug termination:

- All 30 A blocks have pressure wire connectors.
- All 60, 100 and 200 A blocks have box lug connectors.

**Table 21.59: 600 V—Classes H and R [1]**

| Rating (A) [2] | No. of Poles | Class H    | Class R [3][4] | Lug Wire Range     |
|----------------|--------------|------------|----------------|--------------------|
|                |              | Type       | Type           |                    |
| 30[6]          | 1            | 9080FB1611 |                | #14–10<br>Cu       |
|                | 2            | 9080FB2611 |                |                    |
|                | 3            | 9080FB3611 | 9080FB3611R    |                    |
| 60[6]          | 1            |            | 9080FB1621R    | #14–2<br>Cu or Al  |
|                | 3            |            | 9080FB3621R    |                    |
| 100[6]         | 3            |            | 9080FB3631R    | #6–2/0<br>Cu or Al |

**Table 21.60: 600 V Series—Miniature Fuse Dimension (13/32 x 1-1/2 in.) [1]**

| Rating (A) [2] | No. of Poles | Type M      | Class CC [3][4] | Lug Wire Range |
|----------------|--------------|-------------|-----------------|----------------|
|                |              | Type        | Type            |                |
| 30[5]          | 1            | 9080FB1611M | 9080FB1611CC    | #14–10<br>Cu   |
|                | 2            | 9080FB2611M | 9080FB2611CC    |                |
|                | 3            | 9080FB3611M | 9080FB3611CC    |                |

**Table 21.61: 600 V—Class H Only (Copper Only) [1]**

| Rating (A) [2] | No. of Poles | Class H     | Lug Wire Range |
|----------------|--------------|-------------|----------------|
|                |              | Type        |                |
| 30[6]          | 1            | 9080FB1611  | #14–10<br>Cu   |
|                | 2            | 9080FB2611  |                |
|                | 3            | 9080FB3611  |                |
| 100[6]         | 3            | 9080FB3631C | #6–2/0<br>Cu   |

**Table 21.62: 600 V—Class J [1]**



| Rating (A) [2] | No. of Poles | Class J [3] | Lug Wire Range     |
|----------------|--------------|-------------|--------------------|
|                |              | Type        |                    |
| 30[6]          | 2            | 9080FB2611J | #2–14 AWG<br>Cu–Al |
|                | 3            | 9080FB3611J |                    |
|                | 3            | 9080FB3621J |                    |

**Table 21.63: Track Adapter [1]**

| Description   | Type       | Std. Pack [7] |
|---|------------|---------------|
|  35 mm DIN 3 Track Adapter For 9080 FB*211, FB*211R, FB*611M, and FB*611CC Fuseholders | 9080FBDIN3 | 100           |

**Table 21.64: Fuse Sizes—(Diameter x Length)**

| A   | Class of Fuse     |                    |                   |                    |
|-----|-------------------|--------------------|-------------------|--------------------|
|     | Class H/R—300 V   | Class H/R—600 V    | Class M/CC—600 V  | Class J—600 V      |
| 30  | 9/16 x 2 in.      | 13/16 x 5 in.      | 13/32 x 1-1/2 in. | 13/16 x 2-1/4 in.  |
| 60  | 13/16 x 3 in.     | 1-1/16 x 5-1/2 in. | N/A               | 1-1/16 x 2-3/8 in. |
| 100 | 1 x 7-7/8 in.     | 1 x 7-7/8 in.      | N/A               | N/A                |
| 200 | 1-1/2 x 7-1/8 in. | 1-3/4 x 9-5/8 in.  | N/A               | N/A                |

|   |                               |                       |
|---|-------------------------------|-----------------------|
|  | File: E40747 CCN: IZLT2       | Type M fuseholders    |
|  | File: E40747 CCN: IZLT        | Types H, R, J, and CC |
|  | File: 70360<br>Class: 6225–01 |                       |
| Flammability rating of all FB fuse blocks is UL 94V-0. RoHS Compliant               |                               |                       |

[1] Some products may be discontinued. Refer to www.se.com/us for the most current product information.  
 [2] Specified wire ranges are based on 167 °F (75 °C) wire. Wires with temperature ratings other than 167 °F (75 °C) are approved while observing NEC Article 310 wire tables for allowable ampacities of insulated conductors.  
 [3] Class R, J and CC fuse blocks are tested and approved for 200,000 AIC in accordance with UL 512.  
 [4] Class R and CC fuseholders accept current limiting Class R & CC fuses only.  
 [5] Base is high impact thermoplastic—maximum operating temperature 257 °F (125 °C).  
 [6] Base is general purpose phenolic—maximum operating temperature 302 °F (150 °C).  
 [7] Orders must specify the standard package quantity (Std. Pack) or multiples of that quantity.

**Table 21.65: How to Order**

| To Order Specify | Catalog Number |
|------------------|----------------|
| • Class Number   | 9080           |
| • Type Number    | FB1211         |

**Modular Fuseholders**

**Table 21.66: Modular Fuse Holders, TeSys DF [1]**

| Rated Thermal Current | Type of Fuse | Composition | Blown Fuse Indicator | Standard Pack Quantity | Catalog Number         |
|-----------------------|--------------|-------------|----------------------|------------------------|------------------------|
| 30 A                  | Class CC     | 1 Pole      | No                   | 1 Pole                 | <a href="#">DFCC1</a>  |
|                       |              |             | Yes                  |                        | <a href="#">DFCC1V</a> |
|                       |              | 2 Pole      | No                   | 2 Pole                 | <a href="#">DFCC2</a>  |
|                       |              |             | Yes                  |                        | <a href="#">DFCC2V</a> |
|                       |              | 3 Pole      | No                   | 3 Pole                 | <a href="#">DFCC3</a>  |
|                       |              |             | Yes                  |                        | <a href="#">DFCC3V</a> |

 File: E310269, CCN: IZLT

Also see [TeSys DF and LS1 Fuse Carriers](#) on [www.se.com/us](#)



DFCC1



DFCC2V

[1] For additional fuse holders and information, refer to Catalog [9080CT0801](#).

With and Without Marking Flags, Dual Wire

Conform to NF C 63-023 Standard  
Mark and terminate wires simultaneously

Strip the wire, insert it into the cable end and crimp it.  
Up to 7 markers can be used.

Table 21.67: Without Marking Flag

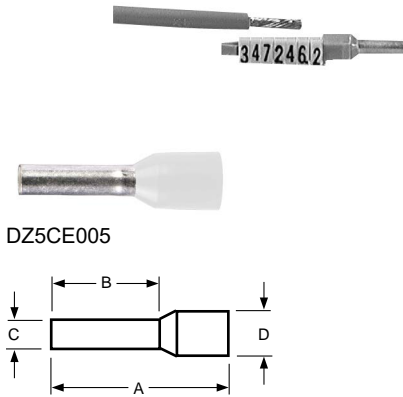

| Wire Size |                 | Sleeve color | Dimensions (mm) |      |      |     | Catalog Number [1][2] | Std. Pack [3] |
|-----------|-----------------|--------------|-----------------|------|------|-----|-----------------------|---------------|
| AWG       | mm <sup>2</sup> |              | A               | B    | C    | D   |                       |               |
| 26        | 0.25            | Yellow       | 11              | 6.2  | 1.2  | 2.2 | DZ5CE002L6            |               |
|           |                 |              | 13              | 8.2  |      |     |                       |               |
| 24        | 0.34            | Green        | 11              | 6.2  | 1.2  | 2.2 | DZ5CE003L6            |               |
|           |                 |              | 13              | 8.2  |      |     |                       |               |
| 22        | 0.50            | White        | 11              | 6.2  | 1.4  | 3   | DZ5CE005L6[4]         |               |
|           |                 |              | 13              | 8.2  |      |     | DZ5CE005[4]           |               |
|           |                 |              | 16.8            | 12   |      |     | DZ5CE005L12           |               |
| 20        | 0.75            | Blue         | 11              | 6.2  | 1.6  | 3.1 | DZ5CE007L6[4]         |               |
|           |                 |              | 13              | 8.2  |      |     | DZ5CE007[4]           |               |
| 18        | 1.00            | Red          | 11.5            | 6.2  | 1.8  | 3.4 | DZ5CE010L6[4]         |               |
|           |                 |              | 13.5            | 8.2  |      |     | DZ5CE010[4]           |               |
|           |                 |              | 16.8            | 12   |      |     | DZ5CE010L12           |               |
| 16        | 1.50            | Black        | 11.5            | 6.2  | 2.1  | 4   | DZ5CE015L6[4]         |               |
|           |                 |              | 13.5            | 8.2  |      |     | DZ5CE015[4]           |               |
|           |                 |              | 22.8            | 17.7 |      |     | DZ5CE0153[4]          |               |
| 14        | 2.00            | Yellow       | 14.5            | 8.2  | 2.35 | 4.2 | DZ5CE020              |               |
|           |                 |              | 14.5            | 8.2  |      |     | DZ5CE025[4]           |               |
| 14        | 2.50            | Gray         | 24              | 17.7 | 2.7  | 4.6 | DZ5CE0253[4]          |               |
|           |                 |              | 17.3            | 9.8  |      |     | DZ5CE042[4]           |               |
| 12        | 4.00            | Orange       | 25.5            | 17.5 | 3.3  | 5.5 | DZ5CE043[4]           |               |
|           |                 |              | 20              | 11.5 |      |     | 3.95                  | 7             |
| 10        | 6.00            | Green        | 26              | 17.5 | 3.95 | 7   |                       |               |

Table 21.68: With Marking Flag

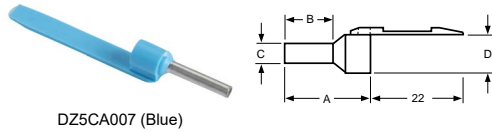

|    |      |        |      |     |     |     |             |      |
|----|------|--------|------|-----|-----|-----|-------------|------|
| 26 | 0.25 | Yellow | 13   | 8.2 | 1.2 | 2.2 | DZ5CA002    | 1000 |
| 24 | 0.34 | Green  |      |     |     |     | DZ5CA003    |      |
| 22 | 0.50 | White  |      |     |     |     | DZ5CA005[4] |      |
| 20 | 0.75 | Blue   | 13.5 | 8.2 | 1.6 | 3.1 | DZ5CA007[4] | 1000 |
| 18 | 1.00 | Red    |      |     |     |     | DZ5CA010[4] |      |
| 16 | 1.50 | Black  |      |     |     |     | DZ5CA015[4] |      |
| 14 | 2.50 | Gray   | 14.5 |     | 2.7 | 4.6 | DZ5CA025[4] |      |

Table 21.69: Marking Flag Optional [5]

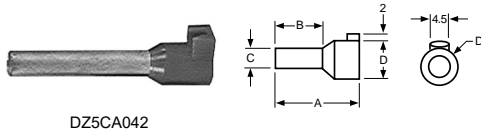

|    |       |        |      |      |      |      |             |      |
|----|-------|--------|------|------|------|------|-------------|------|
| 12 | 4.00  | Orange | 19.5 | 11.5 | 3.3  | 5.5  | DZ5CA042[4] | 1000 |
|    |       |        | 25.5 | 17.5 | 3.3  | 5.5  | DZ5CA043[4] |      |
| 10 | 6.00  | Green  | 20   | 11.5 | 3.95 | 7    | DZ5CA062    | 100  |
|    |       |        | 26   | 17.5 | 3.95 | 7    | DZ5CA063    |      |
| 8  | 10.00 | Brown  | 21.5 | 12   | 4.95 | 8.4  | DZ5CA102    | 100  |
|    |       |        | 27   | 17.5 | 4.95 | 8.4  | DZ5CA103    |      |
|    |       |        | 23.5 | 12   | 6.35 | 9.8  | DZ5CA162    |      |
| 6  | 16.00 | White  | 29   | 17.5 | 6.35 | 9.8  | DZ5CA163    | 100  |
|    |       |        | 30   | 17.5 | 8.15 | 12   | DZ5CA253    |      |
| 4  | 25.00 | Black  | 30   | 16   | 9    | 13.5 | DZ5CA352    | 20   |
|    |       |        | 39   | 25   | 9    | 13.5 | DZ5CA353    |      |
| 2  | 35.00 | Red    | 36   | 20   | 11   | 15.7 | DZ5CA502    | 20   |
|    |       |        | 41   | 25   | 11   | 15.7 | DZ5CA503    |      |

Table 21.70: Dual Wire Cable Ends

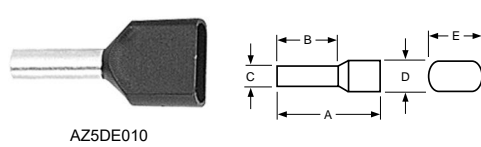

| Wire Size | Sleeve color | A   | B  | C   | D   | E        | Catalog Number | Std. Pack |
|-----------|--------------|-----|----|-----|-----|----------|----------------|-----------|
| 22        | White        | 13  | 8  | 1.4 | 2.5 | 4.7      | AZ5DE005       | 500       |
| 20        | Blue         |     |    | 1.6 | 2.8 | 5.0      | AZ5DE007       |           |
| 18        | Red          | 1.8 |    | 3.4 | 5.4 | AZ5DE010 |                |           |
| 16        | Black        | 2.1 |    | 3.6 | 6.6 | AZ5DE015 |                |           |
| 14        | Gray         | 24  | 10 | 2.7 | 4.2 | 7.8      | AZ5DE025       | 250       |

RoHS Compliant

[1] Bold faced catalog numbers are stocked in the United States.  
 [2] CE Marked.  
 [3] Orders must specify the standard package quantity (Std. Pack) or multiples of that quantity.  
 [4] These catalog numbers are UL Component Recognized (File E164872 CCN ZMMT2) provided the AT1PA crimping tool is used to crimp the cable end.  
 [5] Will accept an AR1SC03 cable marker.

**Cable End Markers and Tools**

**Table 21.71: Cable End Markers & Accessories**

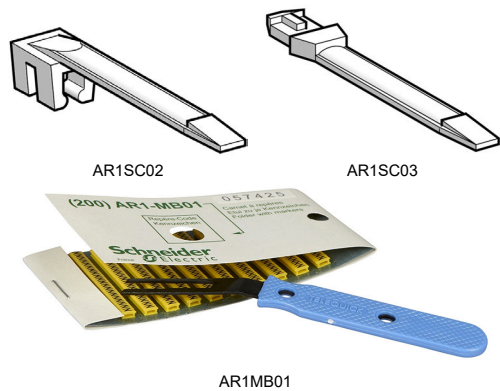

| Style   | Catalog Number | Std. Pack [6] |
|---|----------------|---------------|
| Adjustable collar type marker holder for #14 to #2 wire   | AR1SC01        | 100           |
| Clip-on marker holder for #18 to #16 wire (7 markers max.)  | AR1SC02        |               |
| Cable end marker tags for DZ5CA042 to DZ5CA253  | AR1SC03        |               |
| Card of 200 yellow markers with black numeral 0 thru 9  | AR1MA01[7]     | 1             |
| Card of 200 yellow markers with black letters A thru Z  | AR1MB01 [7]    | 1             |
| Card of 200 black markers with a white 0 marked on them   | AR1MC010       | 200           |
| Card of 200 brown markers with a white 1 marked on them   | AR1MC011       | 200           |
| Card of 200 red markers with a black 2 marked on them   | AR1MC012       | 200           |
| Card of 200 orange markers with a black 3 marked on them  | AR1MC013       | 200           |
| Card of 200 yellow markers with a black 4 marked on them  | AR1MC014       | 200           |
| Card of 200 green markers with a black 5 marked on them   | AR1MC015       | 200           |
| Card of 200 blue markers with a black 6 marked on them  | AR1MC016       | 200           |
| Card of 200 violet markers with a black 7 marked on them  | AR1MC017       | 200           |
| Card of 200 gray markers with a black 8 marked on them  | AR1MC018       | 200           |
| Card of 200 white markers with a black 9 marked on them   | AR1MC019       | 200           |
| Card of 200 blank yellow markers  | AR1MA0196      | 1             |
| Card of 200 blank green markers   | AR1MA0197      | 1             |
| Card of 200 yellow markers with a black + marked on them  | AR1MA0198      | 1             |
| Card of 200 yellow markers with a black—marked on them  | AR1MA0199      | 1             |
| Complete set of numeral markers 0 thru 9, plus one card each of the "+", "-", yellow blanks, and green blanks/one AT1PA1 positioning tool. Each kit has 200 of each item. | AR1MA01        | 1             |
| Complete set of letter markers A thru Z, plus one card each of the "+", "-", yellow blanks, and green blanks/one AT1PA1 positioning tool. Each kit has 200 of each item.  | AR1MB01        | 1             |

**Table 21.72: Cable End Tools**

| Description  | Catalog Number |
|--|----------------|
| Cable end marker positioning tool  | AT1PA1         |
| Automatic stripping and cutting tool for 0.8 mm to 4 mm cable, adjustable stripping length | AT1PA7         |
| Crimping tool for cable ends 0.5 mm <sup>2</sup> to 16 mm <sup>2</sup>                     | AT1PA2         |
| Crimping tool for cable ends 10 mm <sup>2</sup> to 35 mm <sup>2</sup>                      | AT1PA4         |
| Organizing case for cable ends—holds stripping tool and cable ends (not supplied)          | AT1HB2         |



[6] Orders must specify the standard package quantity (Std. Pack) or multiples of that quantity.  
 [7] Complete the catalog number by adding the number or letter desired.  
 Examples: AR1 MA015 is a card of 200 yellow markers with a black 5 marked on them.  
 R1 MB01T is a card of 200 yellow markers with a black T marked on them.



### Telefast ABE 7 Pre-Wired Sub-Bases

Telefast is a substitution of traditional screw terminal blocks for a fast connection of high-density I/O modules to operative parts. It offers protection, distribution, visualization, and adaptation of the signals.

#### Features:

- A selection of most used and qualified Telefast sub-bases for rapid connection of I/O modules (discrete, analog, and counter) to sensors or actuator
- A substitute for the terminal block, remotely locating and partly eliminating the single-wire connection
- Provide relay and connection functions, with or without polarity distribution, reduce wiring time, and eliminate the risk of error Functions
- Adapting I/O current/voltage for PLCs
- Distributing signals, commons ( 24 or 0V ) and earth for connecting 1/2/3 wire signals
- Channel isolation, protection, and LED diagnostics
- Various relay contact combinations 1N/O, 1C/O, 2C/O
- Prewiring cabinets
- Easy wiring suitable for PLC high-density I/O modules

Visit [Telefast ABE 7](http://www.se.com/us) on [www.se.com/us](http://www.se.com/us) for the latest product information.