

Unlock the full potential of your automation architecture.

Plant  Etruxure™

Automation control solutions
based on Modicon Quantum Ethernet I/O



Make the most of your energySM

Schneider
 Electric™



Quality at the heart of your system

Modicon Quantum™ Ethernet I/O (QEIO) is an automation control solution designed specifically for industrial automation and process applications.

It supports remote I/O architectures and adapts to your current system requirements, remaining open to future modifications as your installation evolves.

The Modicon X80 drop is a cost-effective solution based on the Modicon M340™ form factor, enabling you to develop a compact and robust architecture.

PlantStruxure™

QEIO is an integral part of the PlantStruxure™ solution, a collaborative architecture that allows industrial and infrastructure companies to meet their automation needs and, at the same time, deliver on growing energy management requirements.

In a single environment, measured energy and process data can be analyzed and used to yield a holistically optimized plant. The PlantStruxure architecture is easy to engineer and maintain, delivering a clear picture of what is happening in your process and helping you drive increased return on assets.

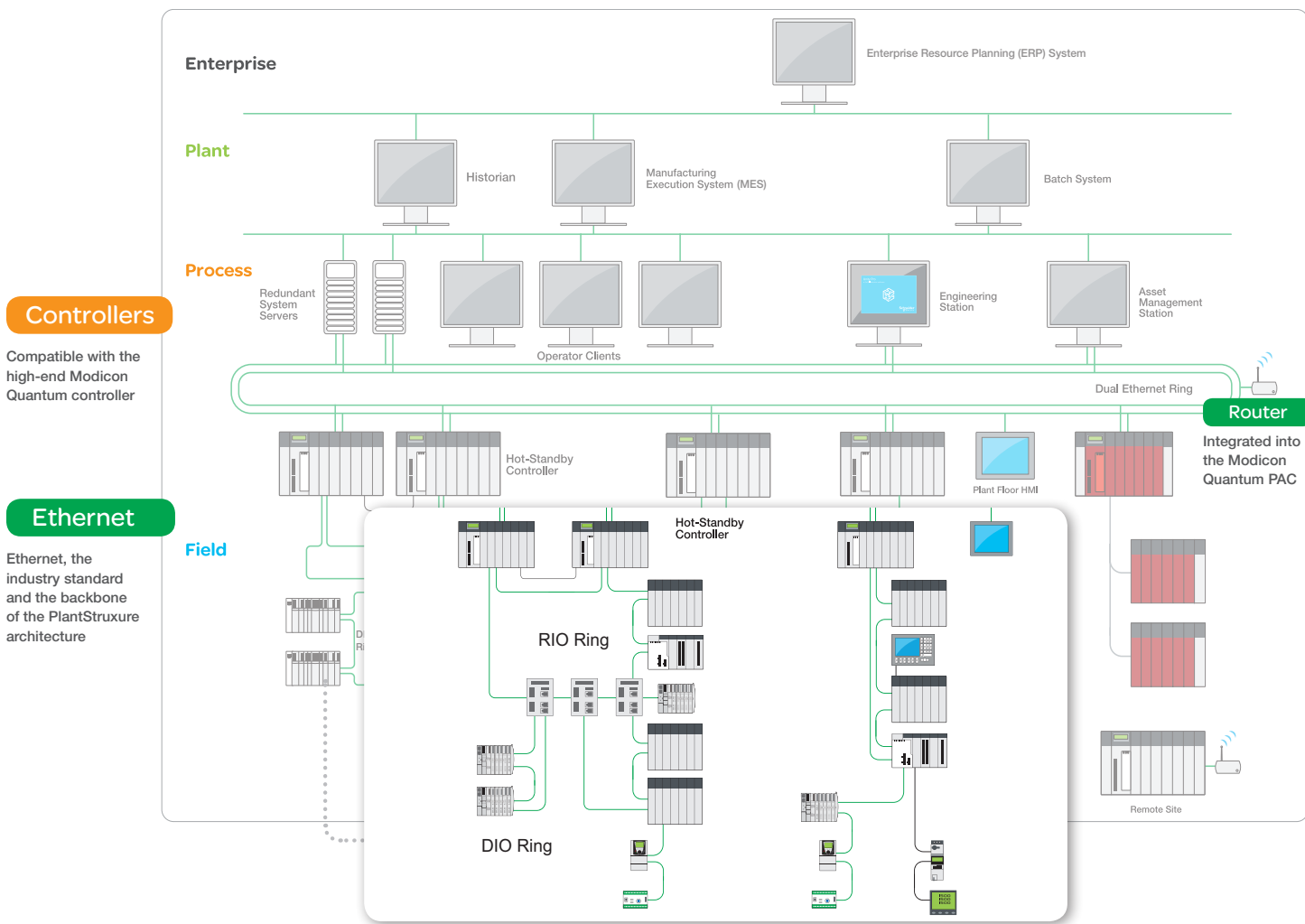

Remote I/O

Ethernet remote I/O and Ethernet distributed I/O on the same cable
Modicon X80 drop

Distributed I/O

Separated, Ethernet distributed I/O and Ethernet remote I/O

- RIO: Remote I/O (based on EtherNet/IP™)
- DIO: Distributed I/O (based on Modbus TCP)
- QEIO: Quantum Ethernet I/O (including Ethernet DIO and RIO)
- QERIO: Quantum Ethernet Remote I/O
- PAC: Programmable Automation Controller
- DRS: Dual Ring Switch
- SCADA: Supervisory Control and Data Acquisition



Standard

QEIO is based on EtherNet/IP which is promoted by Open DeviceNet™ Vendor Association (ODVA). Standard network infrastructure devices, tools, and network analyzers help simplify maintenance and training.

Available

High process availability is a key requirement for many systems. If a connection is lost at a single device, QEIO keeps your process running with minimal disruption.

Scalable

As your application evolves, our solution can be adapted without making extensive modifications. The versatility of QEIO makes it easier to add sensors/actuators and other devices.

Simple

QEIO simplifies management of your I/O. They can be accessed and adjusted through a single configuration software, Unity™ Pro.

Long-term

Modicon X80 is modern, compact, and robust. By offering an extensive catalog of I/O and communication modules, it helps you achieve and maintain long-term system optimization.

Modicon Quantum Ethernet RIO



Head-end adaptor
140 CRP 31200

- Front display for diagnostics in compliance with the ODVA standard
- Port linking to Ethernet module allowing mix of DIO and RIO on the same cable
- Service port to connect PC, local HMI, or DIO devices
- Two ports support self-healing daisy chain loop

Dual ring switch



ConneXium™ extended manageable ConneXium Network Manager

- Supports managed and unmanaged network devices
- Draws a topology map showing interconnections between devices
- Developed for configuration and supervision of industrial networks
- Can be used to supervise devices from any manufacturer
- Provides interfaces to SCADA system



Drop adaptor
140 CRA 31200



Drop adaptor
BMX CRA 31200 or 31210

- Rotary switches to configure drop address
- Service port* to connect a PC, local HMI, or DIO cloud
- Two ports support self-healing daisy chain loop

*Not available on BMX CRA 31200

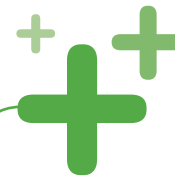

Extend your existing installed base

QEIO uses the same standard I/O modules as the existing Quantum S908 architecture. To simplify the upgrade of your installation and reduce the cost, you can mix the new Ethernet RIO with your Quantum S908 bus on the same controller.

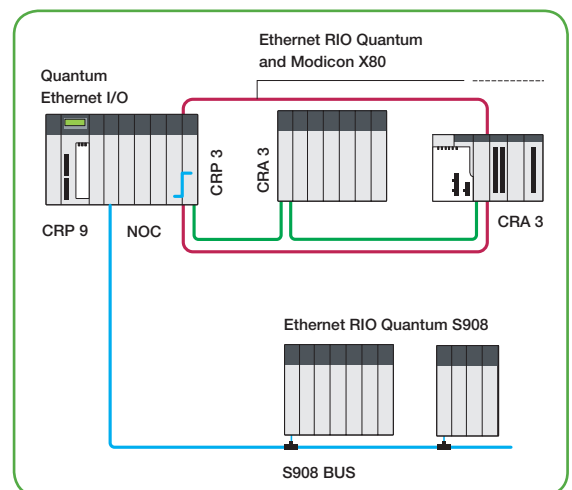

More flexibility and higher performance for your architecture



With a rack-mounted X80 fiber optic converter, you can expand your architecture over a long distance.

The QEIO solution is based on our current Modicon Quantum offer, using the same I/O modules. This flexible system enables the design of efficient I/O architectures that meet the requirements of many control applications.

Choose an I/O bus architecture based on Ethernet to remove the limitations of traditional, proprietary network topologies and access increased network flexibility and high-level performance.

Flexible

> You didn't plan a future extension of DIO?

No need to add cables! Just connect your new DIO island to the existing QEIO network via a service port of CRA module without extra cost of cabling.

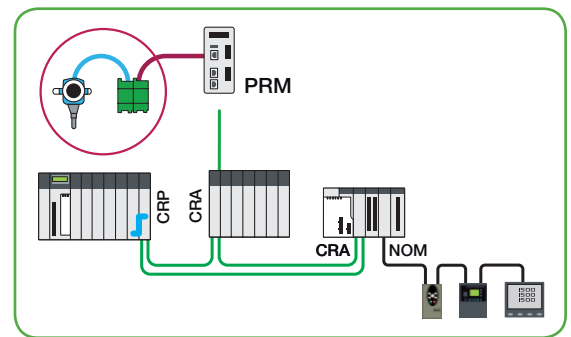
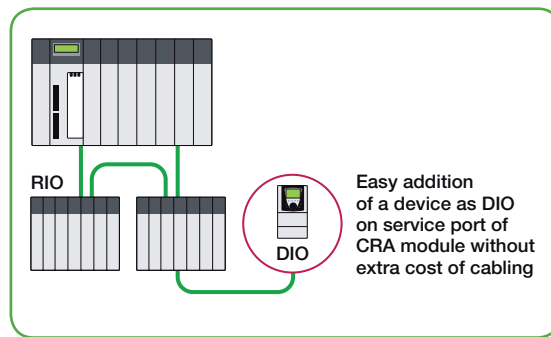

> Expand your architecture

Up to 31 drops of QEIO. Each drop can be one or two racks, each rack four to 16 slots. This evolution of QEIO allows Modicon X80 to be used as I/O drops for more flexibility.

> For connecting your devices

Easy addition of instrumentation using FDT/DTM technology.

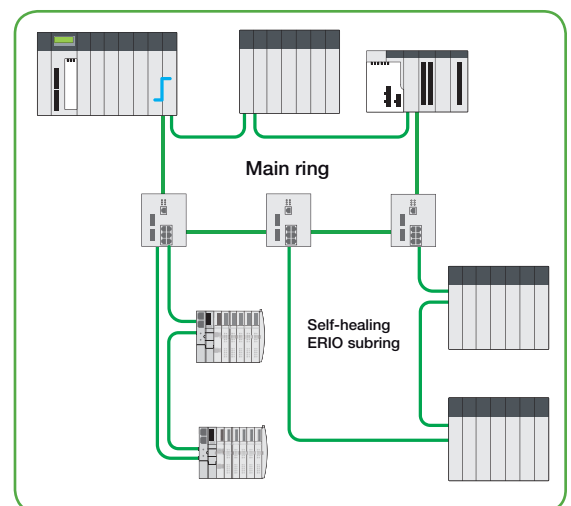
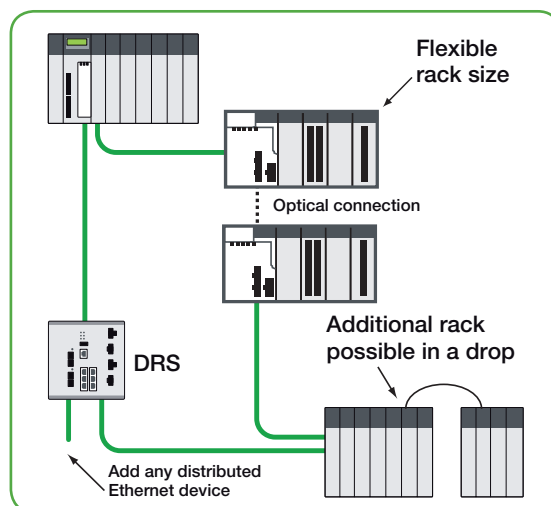

> For the online modification of your installation

Add an I/O module or a new Ethernet drop without stopping your process using the Change Configuration on the Fly (CCOTF) function of Unity Pro software. Benefit from the continuity of communication with your SCADA system due to the OPC Factory Server during the online changes. Adding a drop in RUN is only available on 140CPU6x2xx processors.

Performance

- The Quality of Service (QoS) function allows deterministic operation of QEI/O
- For large I/O configurations, performance level is higher than many proprietary RIO buses
- The OPC Factory Server improves communication between SCADA systems and Modicon Quantum PAC

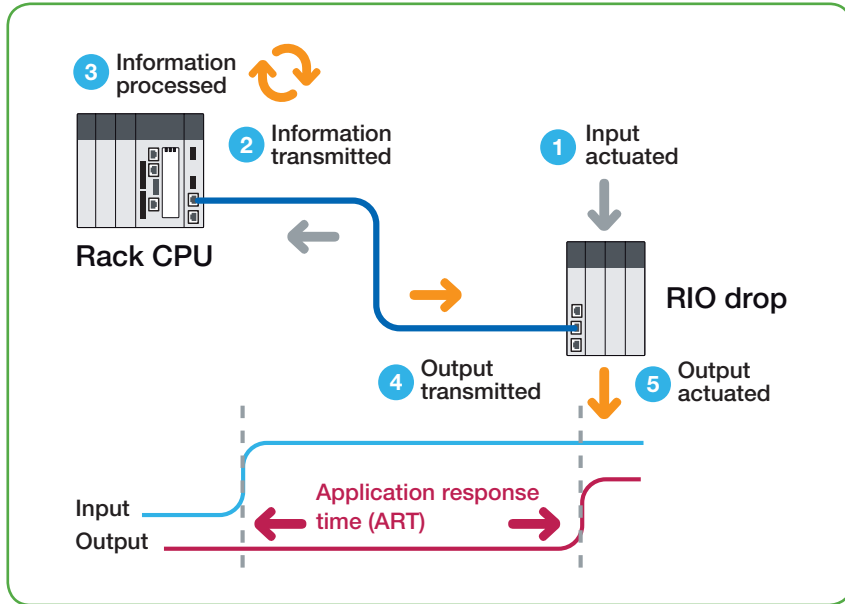

Predictable application response time

More freedom

> Stay connected everywhere via the embedded service ports on the CRA/CRP modules

- Unity Pro software: maintenance or modification of application
- HMI: no extra design cost to add an HMI
- DIO cloud: connect your I/O devices without additional hardware

> Simplified design

- No limit to the number of analog modules per drop

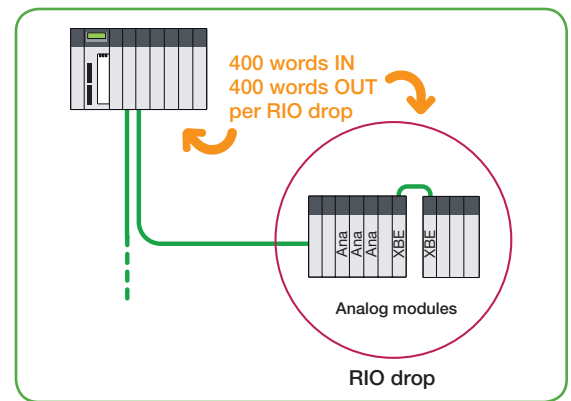

Efficiency

- With the new Modicon X80 time-stamping module, you can easily manage your sequence of events from I/O to SCADA without any specific development

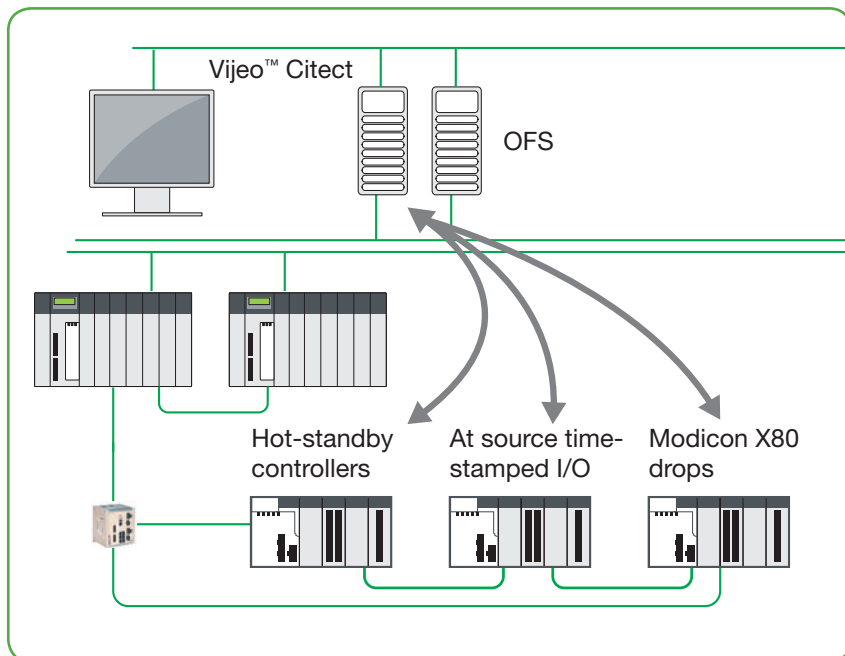

x6
 More I/O capacity per remote I/O drop

x12
 Increased bandwidth between SCADA and PAC for a solution on OPC

High availability

> With hot-standby CPU

Choose the Modicon Quantum HSBY CPU compatible with the QEIO solution

> With RIO self-healing daisy chain loop

RIO communication modules include a dual Ethernet port. These two copper ports provide RIO communications with the capability to recover rapidly from a break in the communication cable

> With redundant DRS switch

Improve the availability of your Ethernet RIO sub loop

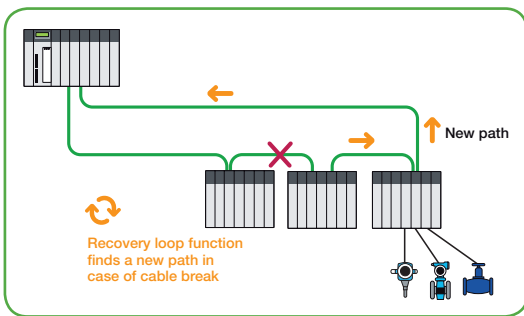

Loop recovery in 50 ms or less with 31 RIO drops

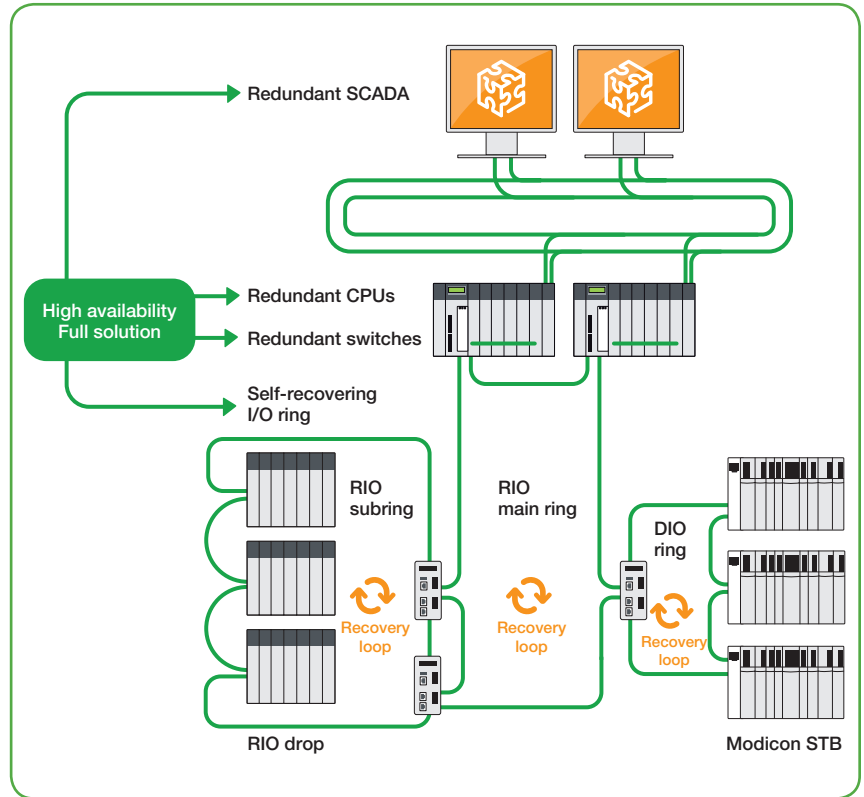

Long-term benefits

- Integrated with PlantStruxure architecture
- Modicon solution
- Based on Ethernet
- Compatible with the existing Modicon X80 solution (RIO or DIO)

Easy access

- Web page view of RIO network
- Program viewer via FactoryCast



Benefit from remote access and stay connected from wherever you are



> Quantum ERIO statistics available

- Easy to monitor health of Quantum Ethernet RIO via browser
- Both CRA and CRP statistics available
- Rack viewer function for Quantum available on Ethernet module

See what your automation architecture can do!

With PlantStruxure Quantum Ethernet solutions, you improve the productivity of your process and build a balanced automation control application.



- > Cost-effective solution with copper to fiber transceiver in rack
- > Ethernet topology: daisy chain loop, ring, star, bus
- > Copper or fiber optic: EMC and distance
- > ConneXium dual ring switch, up to two levels of rings and up to 15 independent subrings
- > Unity Pro software
 - 5 IEC languages (Ladder Logic, Derived Function Block, Structured Text, Sequential Function Chart, and Instruction List)
 - LL984 language (classic 984 Ladder Logic editor)
 - Simulation



- > Continuity of communication with SCADA (OFS)
- > Transparent access: Web view of RIO in Ethernet modules and web pages through in-rack router module
- > Services port: access from anywhere or on CRA/CRP for local HMI*, Unity Pro software*, ConneXium
- > High-availability solutions

*Via Ethernet module



- > Optimally sized modular drops
- > Greater number of analog modules per Quantum drop: I/O drop increased (400 words in, 400 words out)
- > Data exchange 1.5 MB HSBY CPU
- > Predictable ART (application response time)
- > 12x bandwidth SCADA and embedded routing functionality in the controller



- > Monitor your network using ConneXium Network Manager software
- > Web RIO vision via the rack viewer function in Ethernet module
- > Program viewer
- > Access to standard Unity Pro software maintenance key values (for example, diagnostics)
- > Standard Ethernet tools for maintenance: Wireshark



- > With CCOTF (change configuration on the fly), you can add a complete drop online without stopping the process*
- > Flexible architecture — you can extend new Ethernet RIO on existing Quantum PAC with S908 RIO by adding Ethernet CRA/CRP
- > QEIO uses the same I/O modules as Quantum S908, so your existing systems can be upgraded by changing only CRA/CRP modules and wiring CRA/CRP

*Only available on 140CPU6x2xx

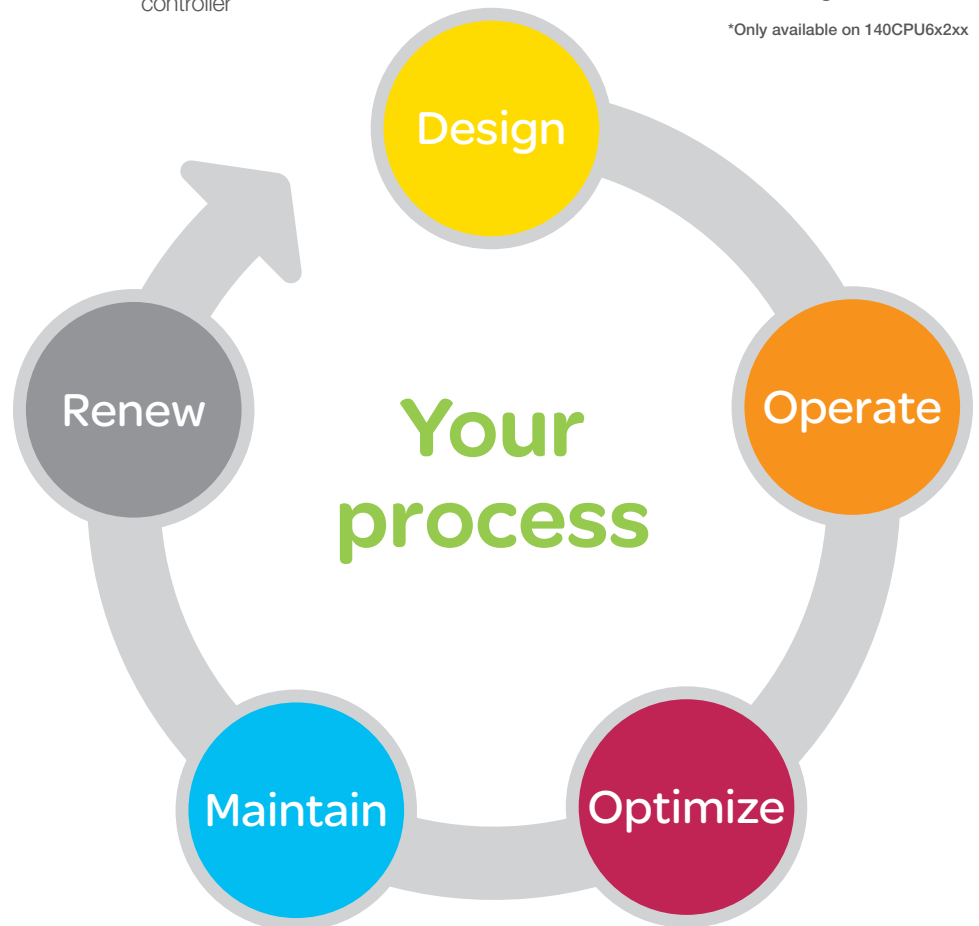



Unlock the potential of your automation control system.

Discover the new Modicon
Quantum Ethernet I/O.



PlantStruxure, the optimized and scalable architecture

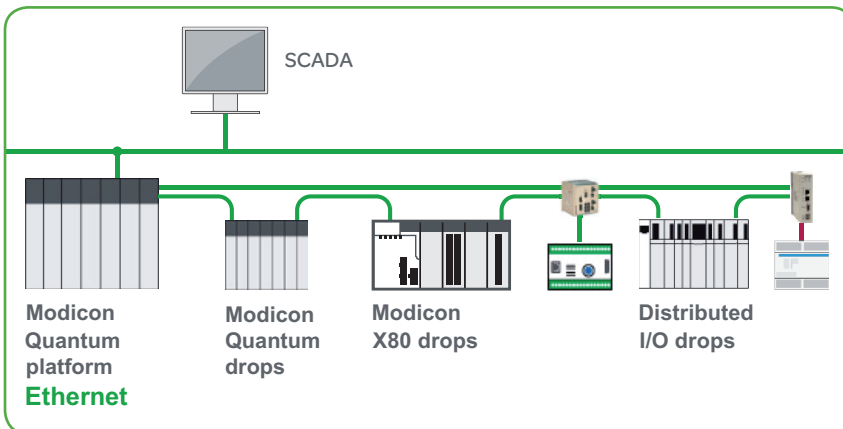

Ethernet everywhere

- Deterministic
- Mixing RIO and DIO
- High availability:
 - Dual port
 - Provides interfaces to SCADA system
 - Rings, subrings with 50 ms recovery time
 - Hot-standby PAC

Fieldbus connectivity

- Based on remote masters and FDT/DTM

Modicon X80, the new RIO solution

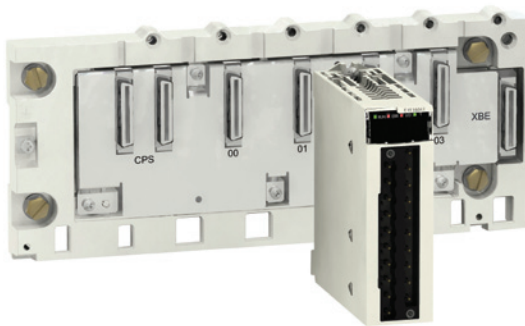

Latest I/O technology

- Innovative I/O
- International certifications (including marine)
- Hot swap
- Large I/O catalog: existing modules are supported, except AS-I, NOR, SSI
- One drop can support two racks along 30 m
- Maximum number of supported X80 drops: 16 for 140CPU6x1xx and 31 for 140CPU6x2xx

New functionalities

- Modbus serial link in your drop
- Sequence of event time-stamped at source in a solution mode

High-level services

- Through Unity Pro software
- With structured data (Device DDT), simplifying diagnostics
- Bit forcing to simplify simulation

	Modicon X80	vs	IEC
Mechanical resistance			IEC 60068-2
Shock [27 Ea]	30G	x2	15G
Vibration [6 Fc]	3G	x3	1G
Electrical resistance			IEC 61000-4
Radiated field	15V/m	+50%	10V/m
Electrostatic discharge	8 kV	+30%	6 kV
Environmental resistance			IEC 61000-4
Temperature	0 ... 55 °C	+5 °C	0 ... 50 °C
Robust offer M34OH	-25 ... 70 °C		
Altitude	4,000 m	x2	2,000 m

Selection guide

	Modicon X80	QERIO drop	QS908 drop
Compact	✓		
Certification	✓	✓	✓
Robustness	✓✓*	✓	✓
Modbus serial module	✓		
Time stamping 1 ms (ERT)	✓	✓	✓
Time stamping 10 ms (CRA)	✓		
Time stamping solution mode	✓		
Redundant/summable power supply		✓	✓
Dual port**	✓	✓	✓
Embedded optical converter	✓		
I/O services (DDT, forcing)	✓		
Easy wiring for remote I/O bus	✓	✓	
Openness to partner's modules (CAPP)		✓	✓
Broken wire detection		✓	✓

*More than standard

**X80 and QERIO support self-healing daisy chain loop

	Modicon X80 drop standard	Modicon X80 drop performance
Change configuration on the fly		x
Expert modules		NOM*, ERT, EHC (up to 36 expert channels)
Maximum analog I/O	16	256
Maximum digital I/O	128	1,024
Service port		x

*Max number of NOM per drop: two

QERIO drop: Less limit for the number of I/O per drop

NOM: Module including two serial ports

ERT: Time-stamping module

EHC: Counting module

CAPP: Collaborative Automation Partner Program

For more information, visit
www.schneider-electric.com/us
 and enter key code **t978v**.

Enter key code

> OK



Schneider Electric USA

Automation and Control Center of Excellence
 8001 Knightdale Blvd.
 Knightdale, NC 27545
 Tel: 919-266-3671
www.schneider-electric.com/us

Document Number 8000BR1267

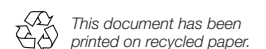

February 2013