

# NF Circuit Breaker Panelboards

## Class 1670

### Catalog

1670CT0701  
R08/21



# Legal Information

The Schneider Electric brand and any trademarks of Schneider Electric SE and its subsidiaries referred to in this guide are the property of Schneider Electric SE or its subsidiaries. All other brands may be trademarks of their respective owners.

This guide and its content are protected under applicable copyright laws and furnished for informational use only. No part of this guide may be reproduced or transmitted in any form or by any means (electronic, mechanical, photocopying, recording, or otherwise), for any purpose, without the prior written permission of Schneider Electric.

Schneider Electric does not grant any right or license for commercial use of the guide or its content, except for a non-exclusive and personal license to consult it on an "as is" basis. Schneider Electric products and equipment should be installed, operated, serviced, and maintained only by qualified personnel.

As standards, specifications, and designs change from time to time, information contained in this guide may be subject to change without notice.

To the extent permitted by applicable law, no responsibility or liability is assumed by Schneider Electric and its subsidiaries for any errors or omissions in the informational content of this material or consequences arising out of or resulting from the use of the information contained herein.

# Table of Contents

Standards and Ratings .....	5
Standards .....	5
Ratings .....	5
Main Lug Interiors .....	7
Main Circuit Breakers .....	8
Circuit Breaker Kits and Accessories .....	8
Branch Circuit Breakers (Bolt-on).....	9
Interiors.....	10
Main Circuit Breaker Interiors .....	10
Options for Main Lug Interiors .....	11
Neutrals .....	14
Neutral Assembly .....	14
200% Neutral Kits.....	14
Oversized Neutral Lugs.....	15
Neutral Bonding Provisions .....	15
Ground Bar Kits.....	16
Ground Bar Insulator Kits .....	17
Surge Protection .....	18
Split Bus and Separated Distribution Panelboards.....	20
Power and Energy Management Options .....	21
Enclosures .....	22
Enclosure Types.....	22
Indoor Enclosures (Types 1 and 2).....	22
Rainproof (Type 3R) Dust tight (Type 5 and 12).....	24
Corrosion-Resistant Fiberglass-Reinforced Polyester (Type 4X) .....	26
Stainless Steel (Type 4 and 4x) .....	26
Single Row (Column-Width) Panelboards .....	27
Application Data .....	27
Cable Trough .....	28
Pull Box (catalog number MPX81542).....	28
Terminal Data .....	29
Main Lugs Terminal Data.....	29
Main Circuit Breaker Terminal Data .....	29
Typical Wiring Diagrams .....	30



# Standards and Ratings

NF circuit breaker panelboards are for use on AC systems. They are UL® Listed under File E33139 and marked cULus. NF circuit breaker panelboards accept EDB, EGB, and EJB branch circuit breakers.

## Standards

NF circuit breaker panelboards are designed, manufactured, and tested to comply with the following standards:

- UL 67—Standard for Panelboards
- UL 50—Enclosures for Electrical Equipment
- UL Listed Class CTL panelboard
- CSA C22.2, No. 29—Panelboards and Enclosed Panelboards
- CSA C22.2, No. 94—Special Purpose Enclosures
- NEMA PB 1—Panelboards
- NFPA 70—National Electrical Code® (NEC®)
- Federal Specification W-P-115C Type I Class 1—Circuit Breaker Panelboards
- ASCE, IBC2015, IBC2018, CBC2016, CBC 2019, NBCC Seismic Qualification, and OSHPD Special Seismic Certification Pre-approval: OSP-0016-10
- ABS Type Certified

## Ratings

- Main lugs: 125–800 A
- Main circuit breaker: 125–800 A

**Table 1 - North American Voltage System**

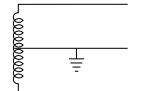
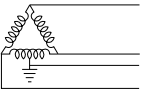
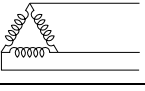
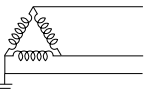
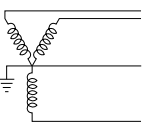
Voltage	System	System Diagram
120/240 Vac	1Ø3W	
480Y/277 Vac		
240/120 Vac	3Ø4W Delta	
240 Vac	3Ø3W Delta	
240 Vac	3Ø3W Grounded BØ Delta	
208Y/120 Vac	3Ø4W	
480Y/277 Vac		
600Y/347 Vac		

**Table 2 - International Voltage Systems**

220Y/110 Vac	3Ø4W	50/60 Hz
220Y/127 Vac		
230/115 Vac	3Ø4W	50/60 Hz
380Y/220 Vac		
400Y/230 Vac	3Ø4W	50/60 Hz
415Y/240 Vac		
480Y/277 Vac		

# Main Lug Interiors

## 250 A Maximum Main Lugs Interior (Deadfront Installed)



- Accepts bolt-on branch circuit breakers
- Top or bottom feed
- 65,000 A Short Circuit Current Rating (SCCR) maximum branch circuit breakers at 480Y/277 Vac.
- 100,000 A Short Circuit Current Rating maximum branch circuit breakers at 240 Vac.
- 25,000 A SCCR maximum branch circuit breakers at 600Y/347 Vac.
- Series rated to 200,000 A SCCR maximum when supplied by PowerPacT™ circuit breaker or remote Class J or T Fuse.
- 125 and 250 A interiors are suitable for use as cULus service entrance with back-fed EDB, EGB, or EJB circuit breakers.<sup>1</sup>
- Factory-installed main lugs on all interiors
- 125–600 A main lug interiors are convertible to main circuit breaker interiors by adding a main circuit breaker adapter kit and a main circuit breaker.
- 125 A, 250 A, 400 A, 600 A and 800 A interiors may be suitable for cULus service entrance with vertical main breakers and applicable service entrance barriers.
- 800 A interiors are fully assembled into a 8.75 in. (222 mm) deep NEMA Type 1, 3R, 5, or 12 enclosure.
- Several bus options:
  - Silver/Tin-plated copper or tin-plated aluminum bus (aluminum is standard)
  - Tin-plated copper bus and silver-plated copper bus are also available
  - 600 and 800 A only available with copper
- Branch connector fingers are tin-plated copper:
  - Silver-plated branch connector fingers are optional
- Line lugs are suitable for 75°C copper or aluminum wire

1. An EDBS UL Service Entrance barrier is required on each pole of a back-fed main breaker in jurisdictions that have adopted the 2017 National Electric Code.

# Main Circuit Breakers

HDL



- 125 A maximum field-installable EDB, EGB, or EJB (100 A max at 600Y/347 Vac)
- 125 A maximum field-installable HD, HG, HJ, HL, or HR
- 250 A maximum field-installable JD, JG, JJ, JL, or JR
- 400 A maximum field-installable LA, LH, LG, LJ, LL, or LR<sup>2</sup>
- 600 A maximum field-installable LG, LJ, LL, or LR<sup>2</sup>
- 800 A maximum factory installed MG, PG, PJ, or PL

## Circuit Breaker Kits and Accessories

LAL Circuit Breaker



PowerPacT™ H-, J-, and L-frame circuit breakers are available with shunt trip, ground fault shunt trip, undervoltage trip, time delay, auxiliary switches, and alarm switches.

Field-installable undervoltage release, alarm switch, shunt trip, and auxiliary contacts are available for LA, and LH main circuit breaker interiors.

**NOTE:** See Supplemental Digest for additional accessories.

**Table 3 - Main Circuit Breaker Adapter Kits (Circuit Breaker Not Included)**

Adapter Kit Catalog Number	Ampere Rating	Main Circuit Breaker <sup>3</sup>
N150MH <sup>4</sup>	15–125 A <sup>5</sup>	HD, HG, HJ, HL, HR
N250MJ	150–250 A	JD, JG, JJ, JL, JR
N400M	125–400 A	LA, LH
N600MPPL <sup>2</sup>	400–600 A	LG, LJ, LL or LR

**NOTE:** See Main Circuit Breaker Terminal Data, page 29.

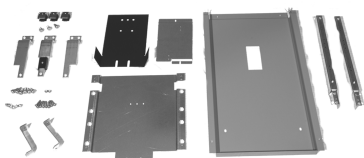

**N250MJ Main Circuit Breaker Kit**

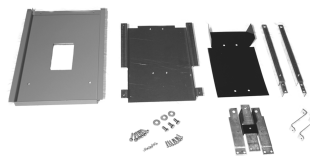

**N400M Main Circuit Breaker Kit**



**N600MPPL Main Circuit Breaker Kit**

2. PowerPacT L circuit breakers require 8.75" deep enclosures and three point latch trim fronts.  
 3. Main circuit breakers are not included in the adapter kits. Order them separately.  
 4. For single phase applications of HDL and HGL, select a 3-pole main circuit breaker. For single phase applications of HJL and HLL, select a 2-pole main circuit breaker.  
 5. RTI kit accepts maximum 125 A H-frame circuit breaker.



# Branch Circuit Breakers (Bolt-on)

## EDB Branch Circuit Breakers



**Table 4 - Standard Branches, 600Y/347 Vac Maximum**

Branch Prefix	Availability			Short Circuit Current Rating <sup>6</sup>		
	1-Pole	2-Pole	3-Pole	at 240/120 Vac	at 480Y/277 Vac	at 600Y/347 Vac
EDB	15–70 A	15–125 A <sup>7</sup>	15–125 A <sup>7</sup>	25,000 A <sup>8</sup>	18,000 A	14,000 A
EGB	15–70 A	15–125 A <sup>7</sup>	15–125 A <sup>7</sup>	65,000 A <sup>9</sup>	35,000 A	18,000 A
EJB	15–70 A	15–125 A <sup>7</sup>	15–125 A <sup>7</sup>	100,000 A <sup>10</sup>	65,000 A	25,000 A

**Table 5 - EPD Branches—30 mA Ground Fault Equipment Protection Devices, 277 Vac 60 Hz**

Branch Prefix	Availability 1-Pole <sup>11</sup>	Short Circuit Current Rating <sup>12</sup> at 277 Vac
EDB-EPD	15–70 A	18,000 A
EGB-EPD	15–70 A	35,000 A
EJB-EPD	15–70 A	65,000 A



**Table 6 - Standard and EPD Branches—Terminal Lug Data**

Branch Circuit Breaker Prefix	Ampere Rating	Wire Size	
		Aluminum	Copper
EDB, EGB, EJB, EDB-EPD, EGB-EPD, EJB-EPD	15–30 A	#12–#6	#14–#6
	35–125 A	#12–2/0	#14–2/0



6. Series ratings are also available. See Switchboard/Panelboard Short Circuit Current Ratings (Data Bulletin #2700DB9901) or Digest 178.  
 7. 600Y/347 Vac is 100 A maximum.  
 8. 18,000 A for 1 pole EDB @ 240 Vac.  
 9. 35,000 A for 1 pole EGB @ 240 Vac.  
 10. 65,000 A for 1 pole EJB @ 240 Vac.  
 11. EPD branches are single-pole only, and require two pole spaces in the panelboard.  
 12. Higher available fault current applications may be served via Series Ratings.

# Interiors

## Main Circuit Breaker Interiors

**400 A LA  
Main Circuit  
Breaker Interior**



**800 A MG  
Main Breaker  
Panelboard**

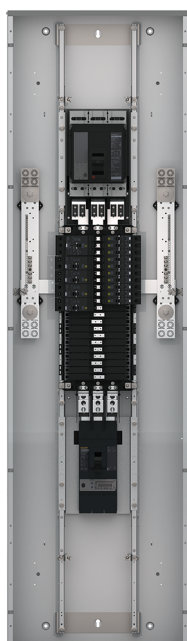

- May be assembled from merchandised main lug interiors, main breaker, and main breaker kits
- Accepts bolt-on branch circuit breakers
- May be top or bottom feed.
- May be suitable for use as UL service entrance (with US Service Entrance Barrier Kit installed); (Canadian service entrance available factory-assembled).
- Barriers must be installed in jurisdictions that have adopted the 2017 National Electric Code.

**Table 7 - US Service Entrance Barrier Kits<sup>13</sup>**

UL Service Entrance Barrier	Description	Applicable Main Breakers
HJQLLC	H/J/Q Line Lug Cover	PowerPacT™ H, J
LALLC	LA/LH Line Lug Cover	LA/LH
PPLLC	PowerPacT™ L Line Lug Cover	PowerPacT™ L
PPPLLC	PowerPacT™ P Line Lug Cover	PG, PJ, PL
EDBS	E Frame Line Lug Cover	EDG, EGB, EJB

- 65 k AIR<sup>14</sup> maximum branch circuit breakers at 480Y/277 Vac
- 25 k AIR maximum branch circuit breakers at 600Y/347 Vac
- Series rated up to 200 k AIR maximum when supplied by PowerPacT™ circuit breaker
- Available with silver-plated copper or tin-plated aluminum bus (aluminum is standard). Tin-plated copper bus and thick silver-plated copper bus are available as an option; 600 and 800 A only available with copper.
- Branch connector fingers are tin-plated copper; silver-plated branch connector fingers are optional.
- 125 A at 480Y/277 Vac (100 A at 600Y/347 Vac) main circuit breaker interiors may contain branch mounted EDB, EGB, or EJB main circuit breakers
- 125–250 A main circuit breaker panelboards may be assembled from:
  - Standard main lug interiors
  - Main circuit breaker adapter kit (N150MH, N250MJ)
  - Appropriate PowerPacT™ H- or J-Frame circuit breakers
  - Line lugs suitable for 75°C copper or aluminum wire
- Merchandised 400 to 600 A main circuit breaker panelboard consists of:
  - 400 or 600 A 3-phase or single phase main lug interior
  - N400M main circuit breaker adapter kit and
    - appropriate LA or LH (400 A max.) circuit breaker, or
  - N600MPPL main circuit breaker adapter kit
    - appropriate 400 or 600 A max. LG, LJ, LL, or LR circuit breaker<sup>15</sup>

13. Main circuit breaker panels are supplied with US or Canadian service entrance barriers if UL or CSA Service Entrance is selected as a requirement in SE Advantage.

14. AIR = Ampere Interrupting Rating.

15. PowerPacT L-frame Main Breaker requires 8.75 in. deep (D9) enclosures and three point latch trim front.

**N600MPPL Main Breaker Kit**



- Factory assembled 400 A main circuit breaker interiors are available with LA, LH, LG, LJ, LL, or LR circuit breakers.
- Factory assembled 600 A main circuit breaker interiors are available with LG, LJ, LL, or LR circuit breakers.
- Factory assembled 800 A main circuit breaker interiors are available with MG, PG, PJ, or PL circuit breakers.

**400 A Main Lugs Interior with 400 A Main Circuit Breaker and Adapter Kit**

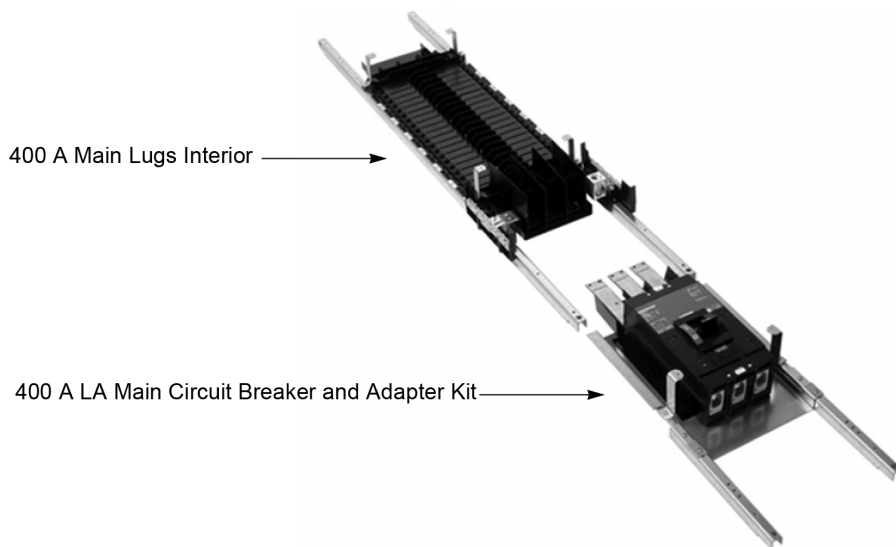

**Options for Main Lug Interiors**

**NFCUV4 400 A Lug Kit**



**Optional Main Lugs**

Compression lugs, or copper mechanical lugs, are available for 125–800 A main lug interiors.

**Table 8 - Main Lug Kits**

Ampacity	Al Compression Lug Kit	Cu Mechanical Lug Kit	Cu Compression Lug Kit
	Catalog Number	Catalog Number	Catalog Number
125 A	NFALV1	NFCUM1	NFCUV1
250 A	NFALV2	NFCUM2	NFCUV2
400 A	NFALV4	NFCUM4	NFCUV4
600 A	NFALV6	NFCUM6	NFCUV6
800 A	Factory Assembled Only		

**400 A Main Lug Interior with Sub-Feed Lugs**



**Front View**



**Bottom View**

**Sub-Feed Lugs (on the Mains)**

**NOTE:**

- Copper mechanical lugs available on 125–800 A main lug interiors
- Copper compression lugs available on 125–400 A main lug interiors

**NF400SFL Sub-Feed Lug Kit**



**Table 9 - Sub-Feed Lug Kits (Aluminum Mechanical)**

Amperes	Catalog Number
125 A	NF125SFL
250 A	NF250SFL
400 A	NF400SFL
600 A	Factory Assembled Only

**NF400FTL  
(400 A Feed-Through Lug Kit)**



**Feed-Through Lugs (end opposite the Mains)**

**NOTE:** Mechanical or compression lugs available on 1Ø or 3Ø, 125–800 A main lug or 100–600 A main circuit breaker interiors.

- Aluminum or Copper lugs available for interiors rated to 800 A

**Table 10 - Field-Installable Feed-Through Lugs**

Mains Rating	Added Length <sup>16</sup>	Catalog No.
125 A	6 Inches	NF125FTL
250 A	12 Inches	NF250FTL
400 A	6 Inches <sup>17</sup>	NF400FTL <sup>17</sup>
600 A	6 Inches <sup>17</sup>	Factory Assembled Only

**NF250FBJ Sub-Feed Breaker Kit**

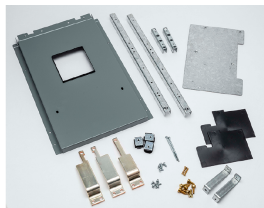

**Sub-Feed Circuit Breakers**

**NOTE:** Available on 1Ø or 3Ø, 125–800 A main lug or 250–800 A main circuit breaker interiors.

Catalog Number	Interior Amperes	Breaker Frame / Max. Amps	Number of SFBs
NF250SFBH	250	PowerPacT H / 150	1
NF250SFBJ	250	PowerPacT J / 250	1
NF600SFBH	400, 600	PowerPacT H / 150	2
NF600SFBJ	400, 600	PowerPacT J / 250	2
N600MPPL	600	PowerPacT L / 400	1
NF600SFBPPL	600	PowerPacT L / 600	1

- One sub-feed PowerPacT L (up to 600 A), or one factory assembled LA or LH circuit breaker (up to 400 A), or one or two PowerPacT™ H or J frame sub-feed circuit breakers may be installed in 400–800 A panelboards.

**Lighting Contactors**

ASCO brand Lighting Contactors are available as an option in factory-assembled panelboards. 2-pole and 3-pole contactors are available for 30, 60, 75, 100, 150, 200, or 225 A branch applications. For more information please explore ASCO 920 Lighting Contactors at [www.ascopower.com](http://www.ascopower.com).

16. Increase in enclosure length to add kit.

17. Feed thru lugs are only available Factory Assembled for NF Panelboards with PowerPacT L frame circuit breakers. No added length is required, beyond that required for the PowerPacT L circuit breakers.

# Neutrals

## Neutral Assembly

**NFN6CR Condo Riser Neutral Assembly**



- All lugs are suitable for copper or aluminum wire.
- 125–250 A interiors have a split neutral located on the same end as the mains.
- 400–800 A interior neutrals can be located on either end depending on the configuration.
- Neutral may be bonded for use as a UL service entrance.
- Branch terminals are suitable for #14-2/0 copper or aluminum and #14-#6 copper or aluminum.
- Provisions for larger branch terminal lug kits are available as options.
- All unused neutral terminals may be used to terminate equipment grounding conductors when the panelboard is used as UL service equipment.
- 100% rated neutrals are standard; one neutral termination provided per circuit in the panelboard.
- 200% rated neutrals are optional.

### Gutter Mounted Neutral Assemblies

- available factory installed on 400, 600, or 800 A interiors
- up to 36 AWG #14-2/0 and 36 AWG #4-#14 terminations
- available for 100% or 200% neutral assemblies
- requires 26" wide enclosure

**Table 11 - Copper 100% Neutral Kits for Use with Single or Three Phase 125–600 A Interiors**

Amperage	125 A	250 A	400 A	600 A	800 A
Catalog Number	NFN1CU	NFN2CU	NFN6CU	NFN6CU <sup>18</sup>	Kit not available, Factory-assembled only

## 200% Neutral Kits

**NFNL2**



**Table 12 - 200% Neutral Kits**

Amperage	125 A	250 A	400 A	600 A	800 A
Catalog Number	NFNL1	NFNL2	NFNL4 <sup>19</sup>	Kit not available, Factory-assembled only	

18. Not to be used with SFL, FTL or SFB. These combinations are factory-assembled only.  
 19. Not to be used with SFL, FTL or SFB. These combinations are factory-assembled only.

## Oversized Neutral Lugs

NFALMN6

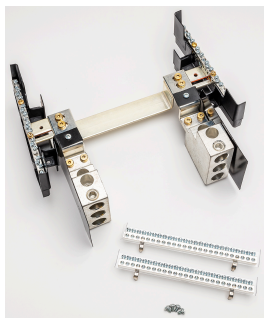

Neutral assemblies with oversized lugs are available. For 125, 250, or 400 A interiors, select the next larger ampere interior to obtain larger neutral lugs. 600 A panelboards may be ordered with new oversized neutral assemblies capable of landing six AWG 4/0 to 500 kcmil Aluminum or Copper conductors. These require an 8.75" deep enclosure.

## Neutral Bonding Provisions

The bonding strap may be field installed for UL service equipment requirements on 125–800 A interiors. Not applicable for CSA service entrance panels in Canada.

Mains Rating	Neutral Bonding Kit
125 A, 250 A	NFBOND12
400 A, 600 A, 800 A	NFBOND468
400 A, 600 A Condo Riser	NFNQCRBOND46
400 A, 600 A, 800 A Gutter Mount	NFBONDGUTTER
800 A Main Breaker	NFCRBOND8

# Ground Bar Kits

## Ground Bar Kit

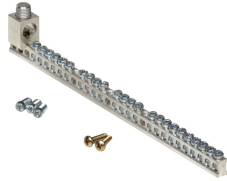

- Field installable in all panelboards
- Wire size of terminals (refer to the technical information below)
- Order enough ground bar kits to accommodate all the ground conductors used in the panel.

**Table 13 - Ground Bar Kits**

Catalog Number	Number of Terminal	Terminal		Approx. Overall Length In. (mm)
		Quantity Available for Each Size		
		Material	I/II	
PK12GTA	12	Al	12/0	4.700 (119)
PK18GTA	18	Al	18/0	6.560 (167)
PK23GTA	24	Al	23/1	9.125 (232)
PK27GTA	27	Al	24/1	9.125 (232)
PK27GTACU	27	Cu	27/0	9.125 (232)

**Figure 1 - Distance Between Mounting Holes (in Ground Bar Kits) —In (mm)**

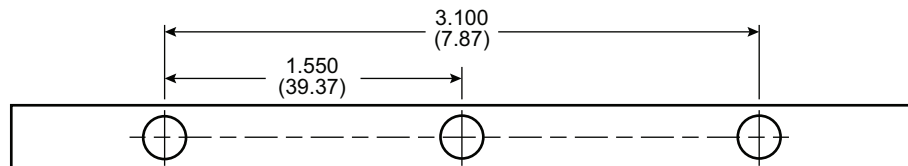

**Table 14 - Wire Range**

Size	Cu	Al
I	(1) #14 to #4 or (2) #14 or #12	(1) #12 to #4 or (2) #12 or #10
II	(1) #14 to #1	(1) #6 to 2/0

**Table 15 - Optional Ground Bar / Neutral Bar Lugs**

Part Number	Conductor Wire Range (AWG)	Branch Amperage
QO70AN	#12–#2 Al or #14–#4 Cu lug	70 A
Q1100AN	#4–#1/0 Al/Cu lug	80–100 A



## Ground Bar Insulator Kits

### Ground Bar with Insulator Kit

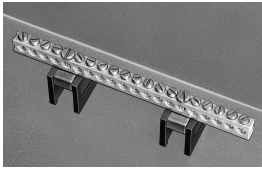

- The PKGTAB insulator kit isolates the standard panelboard ground bar from the panelboard.
- The insulator kit is field installable, and NEMA 1 and 2 enclosures have ground bar mounting provisions in all four corners.

### PKGTAB Insulated Ground Bar Kit



All PK equipment grounding kits are supplied with mounting screws, installation instructions, and an "Equipment Grounding Terminal" self-adhesive label.

# Surge Protection

**NF Main Lugs Panelboard with Integral SPD**

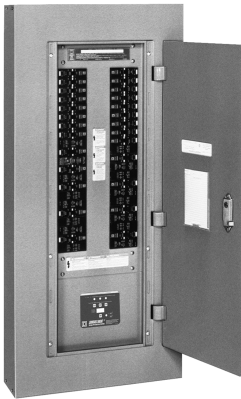

The Surgelogic™ IMA series surge protective device is a modular parallel surge protective device (SPD). The IMA device is a multi-stage suppression circuit consisting of field-proven, fast-acting, 34 mm metal oxide varistors (MOVs).

A surge suppression path is provided for each mode, line-to-neutral (L-N), line-to-line (L-L), line-to-ground (L-G), and neutral-to-ground (N-G). Each surge suppression mode is individually fused and uses circuitry with thermal cutouts to isolate the SPD and ensure shutdown in the event of MOV damage during severe overvoltages, even when operated on high fault current power systems.

The suppression elements are encapsulated in a UL recognized potting material—another performance element that provides additional protection. A filter provides a high level of EMI/RFI noise attenuation. On-line diagnostics continuously monitor the device status, and LEDs signal loss of a suppression circuit. An audible alarm with an enable/disable feature and dry contacts are included in the standard diagnostic package.

**NF442L2TVS416C**



**Table 16 - Ready to Install NF Interiors with SPD**

Mains Rating	Max Circuit Breaker Spaces	SPD Rating		Interior Catalog Number <sup>20</sup>	Components for Adding a Vertical Main Circuit Breaker	
		Voltage (Vac)	Surge Current Rating (kA)		Main Circuit Breaker Kit	Main Circuit Breaker Frames
250 A	42	480Y/277 Vac	160	NF442L2TVS416C	N150MH <sup>21</sup>	HD, HG, HJ, HL, or HR
		600Y/347 Vac	120	NF442L2TVS812C	N250MJ	JD, JG, JJ, JL, or JR
400 A	42	480Y/277 Vac	160	NF442L4TVS416C	N400M	LAL, LHL
		600Y/347 Vac	120	NF442L4TVS812C		

20. These interiors are available as catalog numbered devices. SPDs are not available as a field-installable kit.  
 21. RTI kit accepts maximum 125 A H-frame circuit breaker.

**Table 17 - IMA Series Voltage Specifications**

Service Voltage <sup>22</sup>	UL Suppression Voltage Rating (SVR)				
	L-N	L-G	N-G	L-L	MCOV <sup>23</sup>
120/240 Vac, 1-phase	400	400	400	800	150
208Y/120 Vac, 3-phase, 4-wire	400	400	400	800	150
240/120 Vac, 3-phase, high-leg delta	800/400	800/400	400	1500/800	275/150
480Y/277 Vac, 3-phase, 4-wire	800	800	800	1600	320
600Y/347 Vac, 3-phase, 4-wire	1200	1200	1200	2000	420

**Table 18 - Performance Features**

Surge Capacity	L-N	L-G	N-G (3-Phase Rating)
100 kA / phase	50 kA	50 kA	100 kA
120 kA / phase	60 kA	60 kA	120 kA
160 kA / phase	80 kA	80 kA	120 kA
200 kA / phase	100 kA	100 kA	200 kA
240 kA / phase	120 kA	120 kA	120 kA

**Design Features**

- Individually fused suppression modules
- Thermal cutout
- Inline, copper bus bar connection
- Solid state bi-directional
- Push-to-Test on-line diagnostic display
- Audible alarm with enable/disable switch, provides audible indication that there is a loss of protection
- LED indicators indicate loss of protection, or fully operational circuit
- High-energy parallel design for IEEE C62.41 category A, B, and C3 applications
- Available in main circuit breaker and main lug only panelboards with sub-feed circuit breakers, feed-through lugs, or sub-feed lugs.
- AC tracking filter with EMI/RFI filtering up to -50 dB from 100 kHz to 100 MHz
- Dry Contacts provide remote indication of the SPD device's operating status to a computer interface board or emergency management system.

**Table 19 - Options**

Option	Description
Surge Counter	Displays the combined total number of transient voltage surges detected from L-G, L-L, L-N, and N-G since the counter was last reset.
Remote Monitor	Displays the alarm status of the surge protective device up to 1,000 ft. (305 m) away from the unit. This option uses the dry contacts.

22. For additional information, refer to Document Number 9990-0116.

23. MCOV: maximum continuous operating voltage.

# Split Bus and Separated Distribution Panelboards

Square D™ NF Separated Distribution and Split Bus Panelboards come Factory Assembled with copper bus, with or without an integral Main Circuit Breaker. Multiple branch section configurations (pole spaces per section): Split Bus: 18–30; 30–18; 30–30; 30–18–18. Separated Distribution: 30–18–18; 18–18–18. Up to 250 A main rating.

**Table 20 - Split Bus and Separated Distribution Interiors**

Interior Type (3Ø Only) <sup>24</sup>	Spaces (Poles per Section) <sup>25</sup>	Split Amps <sup>26</sup>	
		Cabled Splits	Backfed Mains
Split Bus	18–30	NA	125 A
	30–18		
	30–30		
	30–18–18		
Separated Distribution	30–18–18	250 A	NA
	18–18–18		

24. Please refer to Document Number 1600HO1701.  
 25. Pole Spaces: Main-Split; or Main-Split1–Split2.  
 26. Maximum split ampere cannot exceed mains rating for cabled splits.

# Power and Energy Management Options

Several Power Meters and Circuit Monitors are available factory-assembled in most NF panelboards. Basic Energy Metering at the Mains is possible with PowerLogic™ EM3500 series circuit monitors. Power Quality Monitoring is available with the selection of PM5563 or PM8244 power meters. These are typically installed with an LCD display in a 7 inch (178 mm) wide side gutter. Communications from these meters is available via Ethernet Modbus TCP/IP.

# Enclosures

## Enclosure Types

**NEMA Type 1 Enclosure with Mono-Flat™ Cover for 125–250 A Interiors**



NEMA Type	Environment	Protects Against
NEMA Type 1	Indoor	Contact with the enclosed equipment, falling dirt
NEMA Type 2	Indoor	Type 1, plus <ul style="list-style-type: none"> <li>Dripping and light splashing of non-corrosive liquids</li> </ul>
NEMA Type 3R	Indoor/Outdoor	Type 2, plus <ul style="list-style-type: none"> <li>Rain, snow, and sleet</li> </ul>
NEMA Type 4	Indoor/Outdoor	Type 3R, plus <ul style="list-style-type: none"> <li>Will be undamaged by the external formation of ice on the enclosure</li> <li>Circulating dust, lint, fibers and flyings</li> <li>Settling airborne dust, lint, fibers and flyings</li> <li>Windblown dust</li> <li>Hosedown and splashing water</li> </ul>
NEMA Type 4X	Indoor/outdoor	Type 4, plus <ul style="list-style-type: none"> <li>Corrosive agents</li> </ul>
NEMA Type 5	Indoor	Type 2, plus <ul style="list-style-type: none"> <li>Settling airborne dust, lint, fibers, and flyings</li> </ul>
NEMA Type 12	Indoor	Type 2, plus <ul style="list-style-type: none"> <li>Circulating dust, lint, fibers, and flyings</li> <li>Settling airborne dust, lint, fibers, and flyings</li> <li>Oil and coolant seepage</li> </ul>

## Indoor Enclosures (Types 1 and 2)

**NEMA Type 1 Enclosure for 400–800 A Interior with Vented Mono-Flat Cover**



### MH type Box

- Standard enclosures are 20 in. (508 mm) wide by 5.75 in. (148 mm) deep. (26 in. (1887 mm) wide enclosures available for Factory Assembled panelboards).
- Boxes are galvanized steel with removable endwalls. On standard depth boxes, one endwall is provided with knockouts, and the other endwall is blank. On deeper boxes, both are blank. Endwalls are removable and interchangeable.
- 8.75 in. (222 mm) deep by 20 in. wide enclosures (required for NF interiors with PowerPacT™ L-frame circuit breakers) have blank endwalls and are also available from stock.
- Factory assembled panelboards may be ordered with enclosures that are 26 in. (1887 mm) wide enclosures and 5.75 in. or 8.75 in. deep (222 mm).
- Enclosure and interior mounting instructions are included in the documentation shipped with the interior.
- Keyhole slots are located in the box backwall to ease installation.
  - NOTE:** Interiors mount directly to studs in MH boxes. No interior mounting brackets are required.
  - NOTE:** 800 A interiors and interiors that have PowerPacT™ L main circuit breakers require elevating brackets, which are included in 8.75 in. (223 mm) deep boxes.
- Type 2 boxes include a drip hood (available with surface mounted trim only).
- Double (tub) Type 1 enclosures are available in 20 in. (508 mm) and 26 in. (1887 mm) widths from 38 in. (965 mm) to 92 in. (2337 mm) high.

#### Type 1 and 2 Trim Fronts

- Finished with gray-baked enamel over cleaned, phosphatized steel (ANSI 49).
- May be ordered flush or surface mounted.
- Door with flush lock; uses NSR-251 key.
- Directory card located on the inside of the door.
- Mono-Flat™ trim fronts on 100–250 A interiors mount to the deadfront with trim screws. Both trim mounting screws and door hinges are concealed; fronts are not removable with the door closed and locked.
- Trim fronts for 400–800 A interiors are ventilated and mount to the enclosure with trim screws; door hinges are concealed.
- Trim fronts 56 in. (1422 mm) high or more on 250 A interiors or 68 in. (1880 mm) high or more on 400 A, 600 A and 800 A interiors have two flush locks.
- Trim fronts on interiors with PowerPacT™ L, M, or P circuit breakers use 3-point latching.

**Key NSR-251  
(Catalog No. LP9618)**



**Standard Flush Lock  
(Catalog No. PK4FL)**



**Concealed Hinge for 125–800 A  
Trim Fronts**



**Interiors Mount Directly to  
Enclosure Studs**



**NF NEMA 1 Three Point Latch  
Trim Front**



**MH Box**



## Rainproof (Type 3R) Dust tight (Type 5 and 12)

- Finished with gray baked enamel over cleaned, phosphatized galvanized steel (ANSI 49).
- Gasketed door with lockable vault handle (PK4NVL); uses NSR-251 key
- Directory card located on the inside of the door
- No knockouts in endwalls
- Trim kit included for end and side gutters
- Provisions for two ground bars
- 125 A, 250 A, 400 A main lug and main circuit breaker interiors
- 600 and 800 A main lug only



**Type 3R, 5, and 12 Enclosures****Vault Handle with Lock  
(Catalog No. PK4NLV)****New Vented NEMA  
Type 3R Enclosure****New Vented NEMA Type 3R Enclosure**

- 26" wide
- 8.75" deep
- Finished with gray baked enamel over cleaned, phosphatized galvanized steel (ANSI 49).
- Gasketed door with dual lockable vault handles (PK4NLV)
- Quarter-turn fasteners work with outer door handle to provide multiple latch points
- Directory card located on the inside of the door
- No knockouts in endwalls
- Provisions for two ground bars
- Supports main lug and main circuit breaker interiors up to 600 A

## Corrosion-Resistant Fiberglass-Reinforced Polyester (Type 4X)

**Type 4X Enclosure**



- Watertight and dust-resistant
- Gasketed door with trunk latches
- Directory card located on the inside of the door

## Stainless Steel (Type 4 and 4x)

- Water and dust-resistant
- Gasketed door
- Directory card located on inside of door
- Type 304 is standard. Type 316 is also available.

# Single Row (Column-Width) Panelboards

## Application Data

### Column-Width Panelboard



### NF Column Width 225 A Main Breaker 3-Phase, 42 circuit Panelboard, without Trim Cover



#### Ratings

- Main lugs: 125 A, 225 A
- Main circuit breaker: 100 A, 225 A.

#### Interiors

- 60 A maximum branch circuit breaker
- Bolt-on EDB/EGB/EJB circuit breakers. See Standard Branches, 600Y/347 Vac Maximum, page 9 and EPD Branches—30 mA Ground Fault Equipment Protection Devices, 277 Vac 60 Hz, page 9
- Solid neutral opposite mains

#### Enclosures

- 9.44 in. (240 mm) wide by 5-5/8 in. (143 mm) deep for 10 in. (254 mm) H- or I-beam
- Galvanized steel
- Removable endwalls

#### Trim Fronts

- Screw mounted
- Door with two flush latches
- Finish: gray baked enamel over cleaned, phosphatized steel

#### Line Lugs

- All lugs are suitable for 75°C copper or aluminum wire.

## Cable Trough

### Single Row (Column-Width) Panelboard

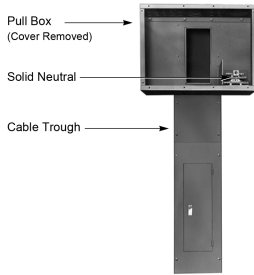

- Cable trough is stackable.
- 8-5/8 in. (219 mm) wide by 5-5/8 in. (143 mm) deep for 10 in. (254 mm) I-beam or H-beam
- Galvanized steel trough uses enclosure endwall
- Screw-mounted two-piece front
  - 15 in. (381 mm) long top piece of front removable for pull box mounting
  - Finish: gray- baked enamel over cleaned, phosphatized steel

**Table 21 - Column-Width Cable Trough**

Length of Cable Trough	Catalog No.
36 in. (914 mm)	NTX836
48 in. (1219 mm)	NTX848
56 in. (1422 mm)	NTX856
66 in. (1676 mm)	NTX866

### Cable Trough Top View with I-Beam

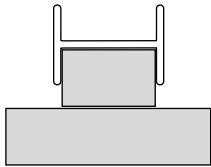

## Pull Box (catalog number MPX81542)

- Mounts on cable trough
- 20 in. (508 mm) wide by 5-3/4 in. (146 mm) deep by 15 in. (381 mm) high
- Screw-mounted front
- Finish: gray baked enamel over cleaned, phosphatized steel
- Removable top endwall with knockouts
- Solid neutral included

# Terminal Data

## Main Lugs Terminal Data

**Table 22 - Standard Aluminum and Copper Lug Kits**

Amperes	Aluminum				Copper			
	Aluminum Mechanical		Aluminum Compression		Copper Mechanical		Copper Compression	
	Cat. No.	Lug Wire Range	Cat. No.	Lug Wire Range	Cat. No.	Lug Wire Range	Cat. No.	Lug Wire Range
125	NFALM1	(1) #6–2/0 <sup>27</sup>	NFALV1	(1) #4–300 kcmil	NFCUM1	(1) #6 - 2/0 AWG	NFCUV1	(1) #6–1/0
250	NFALM2	(1) #6–350 kcmil	NFALV2	(1) 250–350 kcmil	NFCUM2	(1) #6–250 kcmil	NFCUV2	(1) 2/0–300 kcmil
400	NFALM4	(1) 1/0–750 kcmil or (2) 1/0–350 kcmil	NFALV4	(2) 2/0–500 kcmil	NFCUM4	(1) 1/0–750 kcmil or (2) 1/0–350 kcmil	NFCUV4	(1) 400–750 kcmil
600	NFALM6	(2) 1/0–750 kcmil	NFALV6	(2) 2/0–500 kcmil	NFCUM6	(2) 1/0–750 kcmil	NFCUV6	(2) 250–500 kcmil
800	FA <sup>28</sup> only	(3) 4/0–500 kcmil	FA <sup>28</sup> only	(3) 2/0–500 kcmil	FA <sup>28</sup> only	(3) 4/0–500 kcmil	FA <sup>28</sup> only	(3) 250–500 kcmil

## Main Circuit Breaker Terminal Data

See Digest 178 for copper lugs.

**Table 23 - Standard Aluminum Mechanical Lugs Kits**

Panelboard Type <sup>29</sup>	Ampere Rating	Circuit Breaker Type	Lug Wire Range
NF	125 A <sup>30</sup>	EDB, EGB, EJB	(1) #14–2/0 Al/Cu
	150 A	HD, HG, HJ, HL, HR	(1) #14–3/0 Al/Cu
	250 A	JD, JG, JJ, JL, JR	(1) 3/0–350 kcmil Al/Cu
	400 A	LA, LH	(1) #1–600 kcmil Al/Cu or (2) #1–250 kcmil Al/Cu <sup>31</sup>
	600 A	LG, LJ, LL, LR	(2) 2/0 - 500 kcmil Al / Cu
	800 A	MG, PG, PL, PJ	(3) 3/0 - 500 kcmil Al/Cu

**Table 24 - Aluminum Compression Lugs Kits**

Panelboard Type <sup>29</sup>	Ampere Rating	Circuit Breaker Type	Catalog No.	Lug Wire Range
NF	125 A	ED, EG, EJ	VC100FD	(1) #8–1/0 Al/Cu
	150 A	HD, HG, HJ, HL	YA150HD	(1) #1/0–4/0 Al/Cu
	250 A	JD, JG, JJ, JL	YA250J35	(1) 3/0–350 kcmil Al/Cu
	400 A	LA, LH	VC400LA5 <sup>32</sup>	(1) 2/0–500 kcmil Al/Cu
	600 A	LG, LJ, LL, LR	Factory Assembled Only	(1) 2/0–500 kcmil Al/Cu
	800 A		Factory Assembled Only	

27. Neutral accepts #6-2/0 Al/Cu.

28. FA - Factory Assembled - Contact the Technical Applications Group (TAG) (888–272–6841).

29. See Digest 178, Section 7 for copper lugs.

30. 100 A maximum at 600Y/347 Vac.

31. Other lug sizes available, reference Instruction Bulletin 48040–896–03.

32. Other lug sizes available, reference Instruction Bulletin 48040–699–03.

# Typical Wiring Diagrams

## 1-Phase, 3-Wire

125–250 A Main Lugs

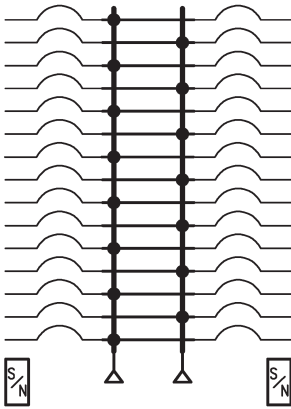

125 A Max. Branch Mounted Main Circuit Breaker

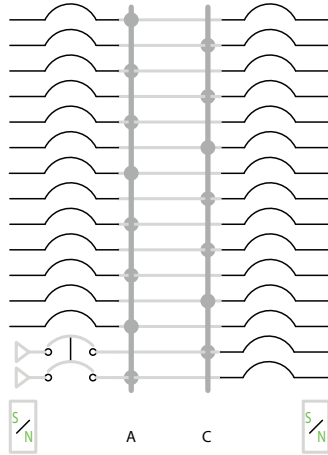

15–250 A Main Circuit Breaker Types H-, or J-Frame

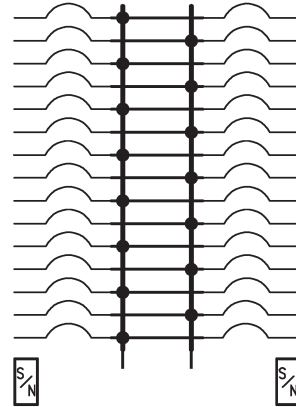

400–600 A Main Lugs

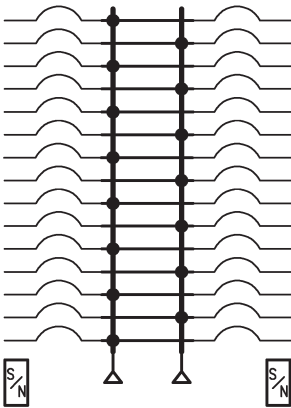

400 A Max. Main Circuit Breaker Type LA/ LH Frame

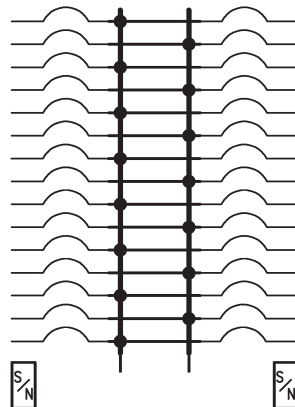

400 A or 600 A PowerPacT L-Frame Main Circuit Breaker with Feed-Thru Lugs

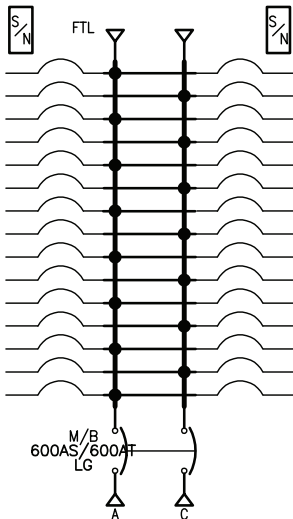

400 A or 600 A PowerPacT L-Frame Main Circuit Breaker with Sub-feed Circuit Breaker

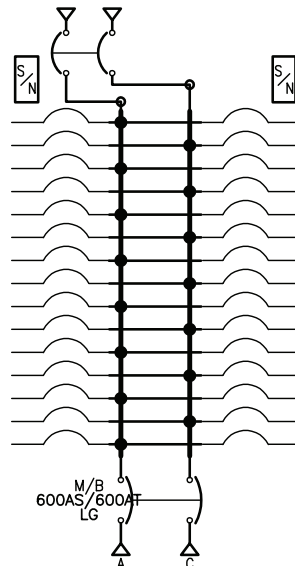

**NF 800 A Main Lugs**

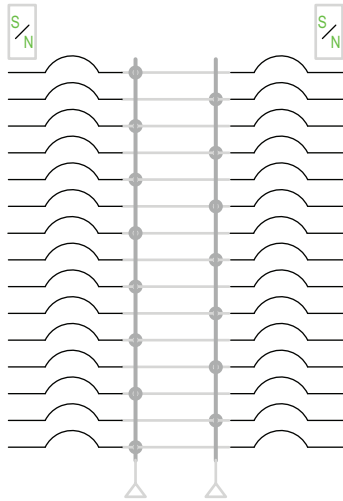

**NF 800 A Max. Main Circuit Breaker—(M- or P-Frame)**

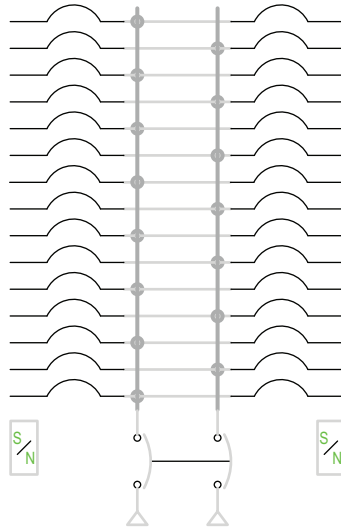

**3-Phase, 4-Wire**

**125–250 A Main Lugs**

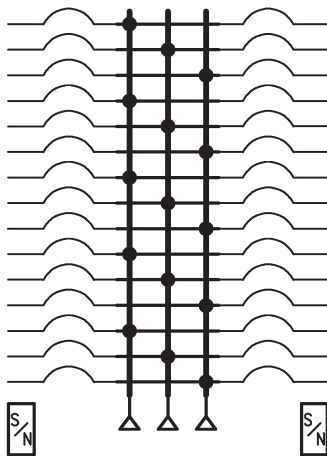

**125 A Max. Branch Mounted Main Circuit Breaker**

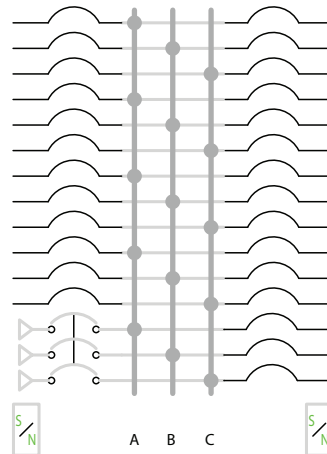

**15–250 A Main Circuit Breaker Types H-, or J-Frame**

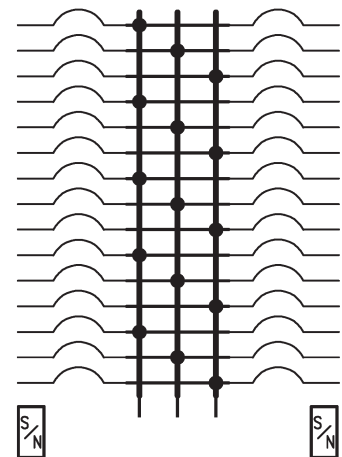

**400–600 A Main Lugs**

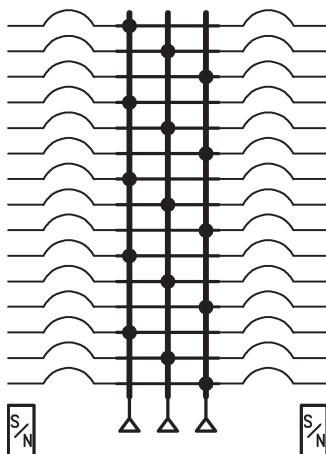

**400 A Max. Main Circuit Breaker Type LA/LH Frame**

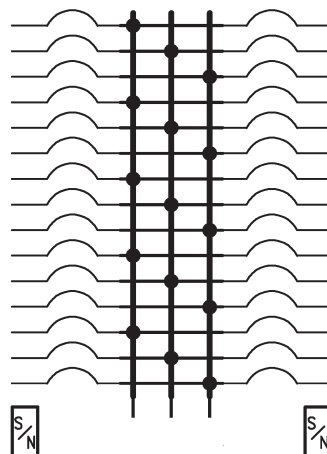

**400 A or 600 A PowerPacT  
L-Frame Main Circuit Breaker  
with Feed-Thru Lugs**

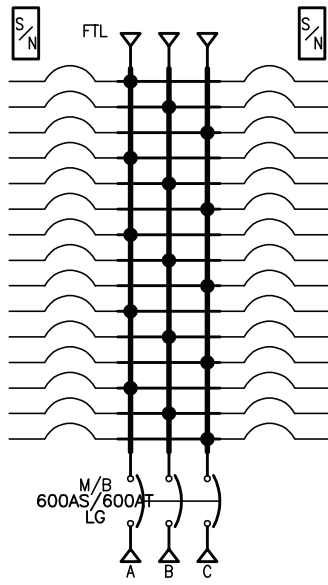

**400 A or 600 A PowerPacT  
L-Frame Main Circuit Breaker  
with Sub-feed Circuit Breaker**

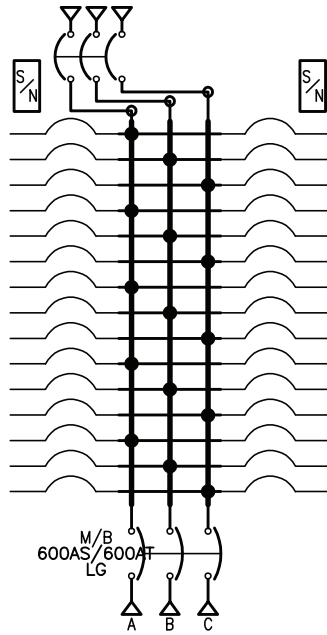

**NF 800 A MLO—3PH, 4W**

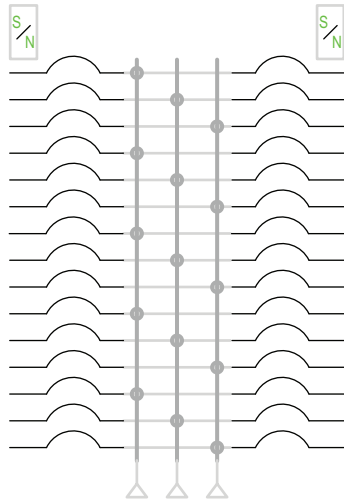

**800 A Max. Main Circuit Breaker  
(M- or P-Frame)**

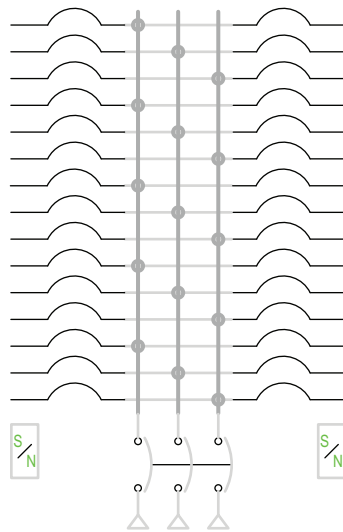





Schneider Electric  
800 Federal Street  
Andover, MA 01810  
USA

888-778-2733

[www.schneider-electric.com](http://www.schneider-electric.com)

As standards, specifications, and design change from time to time,  
please ask for confirmation of the information given in this publication.

© 2008 – 2021 Schneider Electric. All rights reserved.

1670CT0701