



**Commercial**



**Utility**



**Telecom**

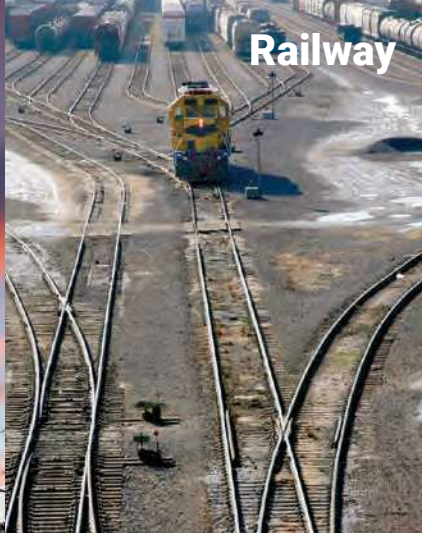

**Railway**



**Industrial**

**CONNECT AND PROTECT**

# Grounding & Bonding for Electrical Systems



**ERICO**

# Training & Expertise

With more than 100 years of industry experience, including research, testing and product manufacturing, nVent ERICO employs an engineered approach when working with customers on grounding and bonding applications, ranging from small installations to multi-billion dollar, turnkey projects anywhere in the world.

Our team of design and engineering specialists is here to help you build a reliable, comprehensive electrical grounding system, offering a variety of training to prepare you for your next project.

**In-Person Training:** nVent ERICO offers in-person grounding and protection training events across the country focused on commercial, telecommunications and utility applications.



## Webinars



### Grounding and Bonding Courses

View our Grounding and Bonding training course catalog for live webinar trainings eligible for PDHs. Topics include:

- Fundamentals of Grounding and Bonding, 1.5 PDHs
- IEEE 80 Substation System Design (Substation Grounding), 1.5 PDHs
- nVent ERICO Cadweld training webinars
- More topics added periodically



### Surge Protection Courses

View our Surge Protection training course catalog for live webinar trainings eligible for PDHs. Topics include:

- Introduction to Surge Protection and UL 1449, 1 PDH
- NEC 2020: Surge & Grounding, 1 PDH
- More topics added periodically



### Lightning Protection Courses

View our Lightning Protection training course catalog for live webinar trainings eligible for PDHs. Topics include:

- Principles of Lightning Protection, 1 PDH
- Lightning Protection for Utility Substations, 1 PDH
- More topics added periodically

# Table of Contents

Facility Electrical Protection for the 21st Century .....	4	Bonds .....	78
nVent ERICO Cadweld .....	7	Welders and Molds.....	82
Grounding, Bonding & Connectivity Products.....	8	Weld Metal .....	82
Electrical Protection from the Grounding Up .....	10	Tools and Materials.....	83
Grounding, Bonding & Protection of Water Treatment Plant .....	12	Technical Information.....	86
Grounding, Bonding & Protection of Industrial Facility .....	16	Cross Reference .....	88
Grounding, Bonding & Protection of Oil & Gas Facility .....	20	Cadweld Applications .....	90
nVent ERICO Outdoor Grounding and Protection Arrangement .....	24	<b>EQUIPOTENTIAL BONDING .....</b>	<b>91</b>
The outdoor arrangement of a grounding system at a typical telecommunication radio site .....	24	Ground Plates.....	92
Grounding Principles .....	26	Ground Bar.....	97
<b>GROUNDING SYSTEM COMPONENTS.....</b>	<b>33</b>	Telecom Ground Bars.....	101
Ground Conductors .....	34	Perimeter Grounding Bus Bars.....	103
Ground Rod Selection .....	36	Equipment Ground Plates.....	105
Copper-Bonded Ground Rods .....	39	Equipment Ground Plate Assemblies .....	106
Ground Rods and Couplers.....	40	Aircraft Grounding Receptacles.....	107
Ground Clamps and Connectors .....	42	Signal Reference Grid (SRG) .....	108
Chemical Ground Electrodes .....	50	Equipotential Mesh and Mats.....	110
Ground Enhancement Material .....	53	Bonding Devices.....	114
nVent ERICO Quickfill .....	55	Fence Clamp Assemblies.....	116
Ground Enhancement Material .....	56	Static Grounding and Bonding.....	119
Grounding Accessories.....	58	<b>GROUND RESISTANCE TESTERS.....</b>	<b>121</b>
<b>NVENT ERICO CADWELD .....</b>	<b>59</b>	Ground Resistance Testers .....	122
nVent ERICO Cadweld .....	60	<b>TECHNICAL INFORMATION.....</b>	<b>124</b>
Cable to Cable.....	62	Technical Information.....	125
Cable to Cable • Cable to Ground Rod .....	63		
Cable to Ground Rod .....	64		
Cable to Bus / Lug.....	65		
Cable to Steel Surface.....	66		
Cable to Rebar.....	67		
Materials, Tools & Accessories.....	68		
nVent ERICO Cadweld Connections for Cathodic Protection....	69		
Connections to Steel.....	70		
Connections to Steel .....	71		
Connections to Steel .....	72		
Connections to Cast Iron.....	73		
Connections to Cast Iron.....	74		
Connections to Ground Rods .....	75		
Connections of Cable to Cable .....	76		
Connections of Cable to Cable .....	77		
Connections for Steel Anode Wire .....	77		

# Facility Electrical Protection for the 21st Century

Lightning strikes and the dangerous over-voltage surges caused by lightning and man-made events represent a direct threat to people, buildings and sensitive electronic equipment.

Today, the consequences of an unexpected lightning strike or power surge can be catastrophic for a company. Proper protection can save thousands of dollars in damage, operational downtime and lost business opportunities.

Because lightning protection, grounding, equipotential bonding and surge protection are all interdependent technologies, reliable protection of structures and operations demands an integrated system approach.

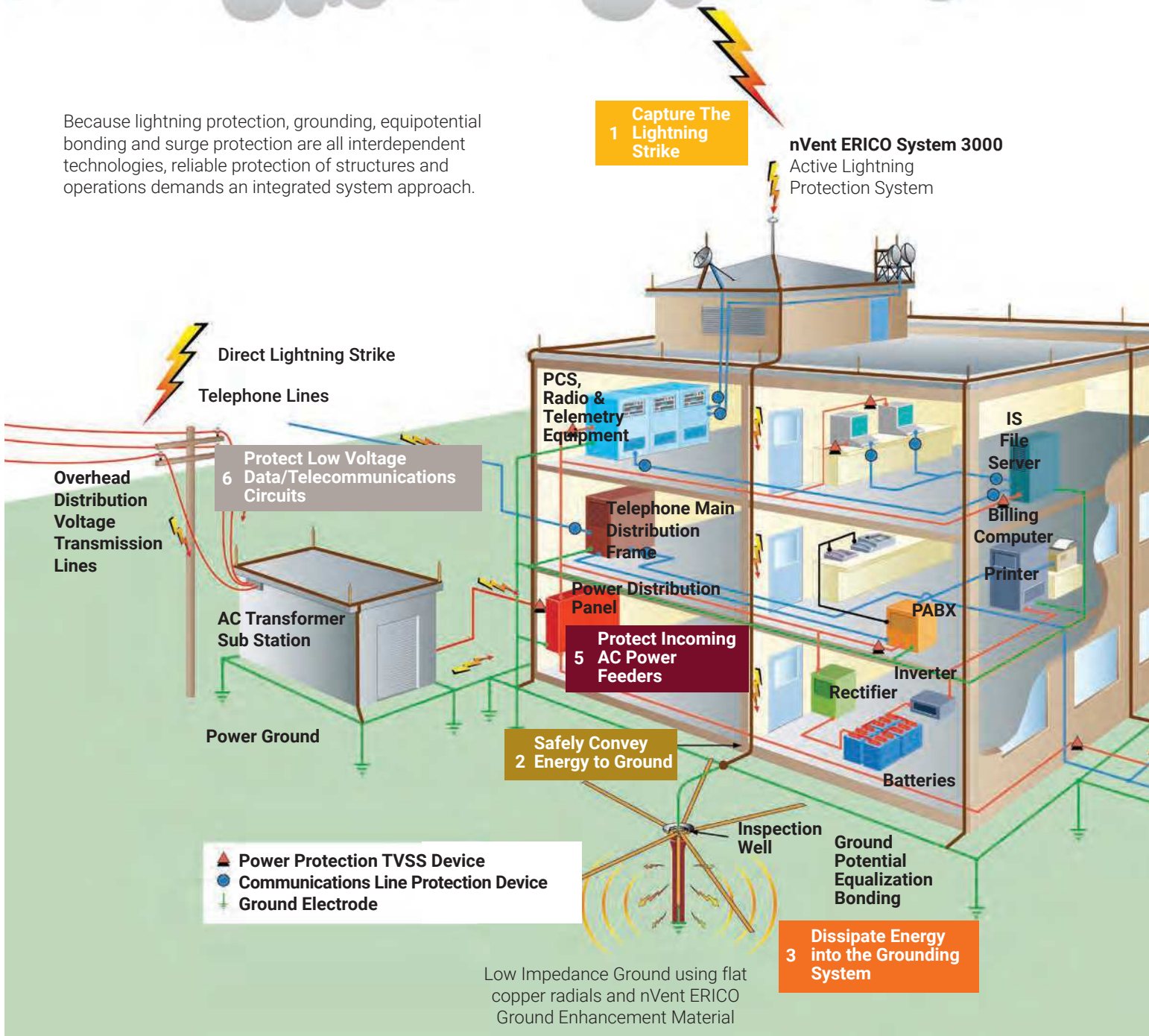

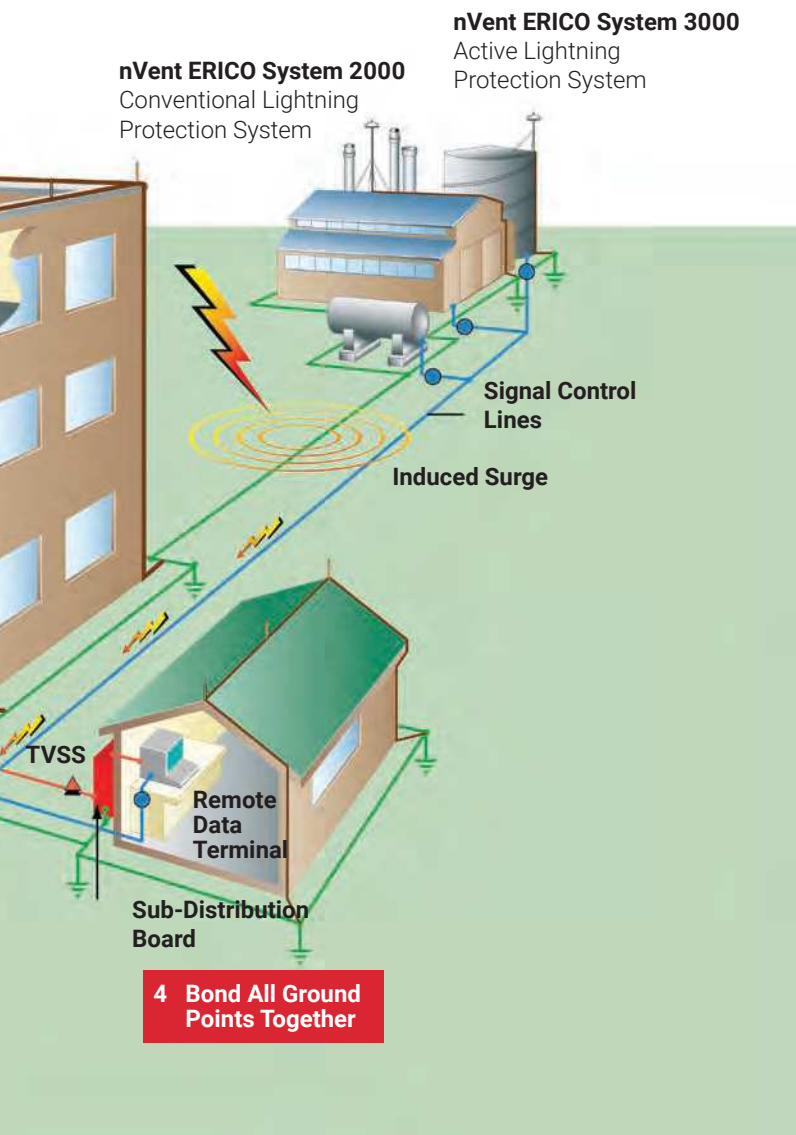

## TOTAL FACILITY PROTECTION

The consequences of an unexpected lightning strike or power surge can be catastrophic for a facility:

- Personnel are at risk.
- Critical equipment may be damaged or destroyed.
- Data can be corrupted.
- The costs of operational downtime and lost revenue can be very substantial.

As industries become more dependent on increasingly sensitive equipment, proper protection from lightning and dangerous over-voltage transients is necessary.

With over 60 years of research, testing and product development, nVent ERICO has acknowledged that no single technology can totally eliminate vulnerability to lightning and surges.

The nVent ERICO Six Point Plan of Protection is designed to provide total facility protection by integrating several concepts.

The Six Point Plan will minimize the risk of damage to facilities through:

- Direct Strike Protection
- Grounding and Bonding
- Surge and Over-voltage Transient Protection

## THE SIX POINT PLAN OF PROTECTION

### 1 Capture the lightning strike.

Capture the lightning strike to a known and preferred attachment point using a purpose-designed air terminal system.

### 2 Convey this energy to ground.

Conduct the energy to the ground via a purpose-designed downconductor.

### 3 Dissipate energy into the grounding system.

Dissipate energy into a low impedance grounding system.

### 4 Bond all ground points together.

Bond all ground points to eliminate ground loops and create an equipotential plane.

### 5 Protect incoming AC power feeders.

Protect equipment from surges and transients on incoming power lines to prevent equipment damage and costly operational downtime.

### 6 Protect low voltage data/telecommunications circuits.

Protect equipment from surges and transients on incoming telecommunications and signal lines to prevent equipment damage and costly operational downtime.

# Facility Electrical Protection for the 21st Century

## DIRECT STRIKE PROTECTION

nVent ERICO's innovative technology provides two systems for capturing lightning energy: nVent ERICO System 2000 and nVent ERICO System 3000. System 2000 provides conventional air terminal technology to meet traditional needs.

An alternative approach to lightning protection is the System 3000, which utilizes the collection volume method to determine the effective placement of lightning protection to ensure the safe conveyance and dissipation of the lightning energy into the ground. Over 7000 facilities worldwide, including some of the tallest and most vulnerable buildings, are protected by System 3000.

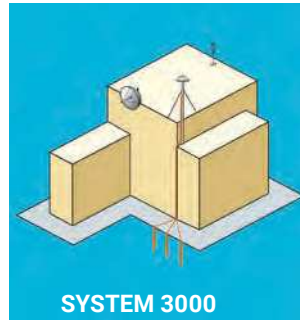
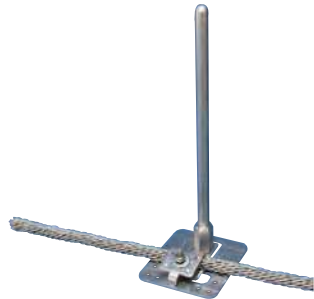
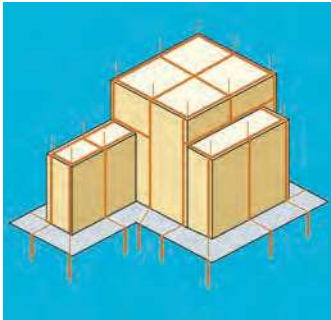

SYSTEM 3000



- Well known technology of passive rods or air terminals, familiar to installers
- Air terminals available in aluminum, copper and stainless
- IEC®, B.S., and U.S. Standard Compliant
- Precision manufacturing helps ensure easy assembly and installation
- Computer-aided design to IEC62305, NFPA®-780, AS/NZS1768



- Advanced lightning protection system based on latest lightning research and technology
- Enhanced area of protection, fewer air terminals needed
- Economical and easy to install
- Fewer downconductors are required
- Designed to protect all types of structures and "open areas"
- Computer-aided design using Collection Volume method

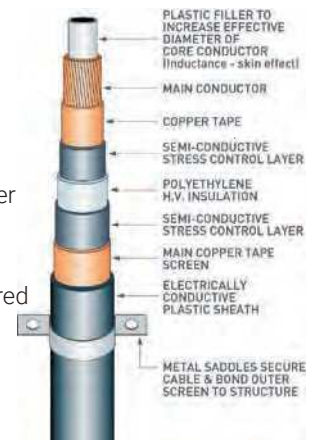

## GROUNDING AND BONDING

For the efficient performance of a lightning protection system, it is essential that a low impedance ground be provided to facilitate the dissipation of the lightning energy into the earth mass.

Because soil conditions and seasonal patterns vary from site to site, the methods of grounding need to be considered on an individual basis.

As a grounding specialist, nVent ERICO provides a range of grounding systems to suit any application.



### nVent ERICO Cadweld Plus

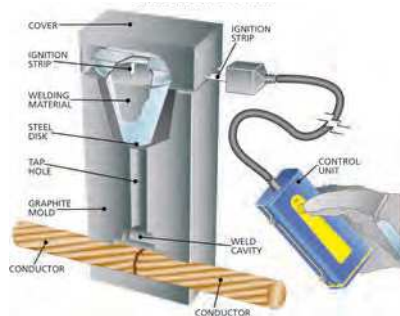

Connections are often the most critical element of grounding systems, so the preferred method of connection is the nVent ERICO Cadweld exothermic welding process.

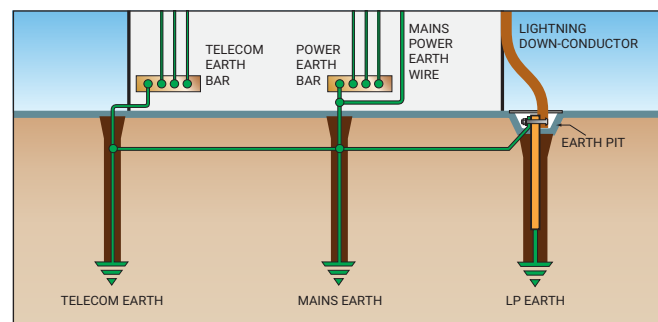

nVent ERICO offers a variety of products, such as ground bars, signal reference grids, ground plates and potential equalization clamps, which are designed to create an equipotential plane and help protect personnel and valuable equipment. nVent ERICO copper-bonded or stainless steel earth rods and nVent ERICO GEM facilitate the transfer of surges and fault currents into the earth, and provide a very long service life due to superior construction and quality.

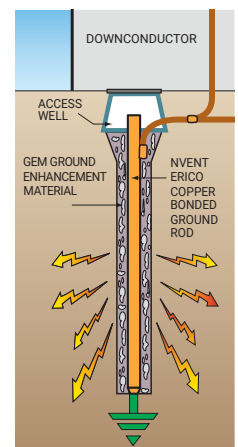

# nVent ERICO Cadweld

**NVENT ERICO CADWELD PERMANENT GROUNDING CONNECTIONS MEET THE REQUIREMENTS OF IEEE STD. 837-2014**



nVent is constantly investing, improving and verifying the performance of our products.

As the original inventor of exothermic welding for electrical connections, nVent ERICO continues to have the most comprehensive test program for compliance of Cadweld exothermically welded connections to IEEE Standard 837 2014 "Standard for Qualifying Permanent Connections Used in Substation Grounding." nVent tested connections using AWG 4/0 copper conductors, 4/0 equivalent copper-bonded steel, and 19/#8 40% DSA copper clad steel conductors (all of which qualified smaller conductors of the same connection family). All of the submitted connections passed the Mechanical (EMF) and Sequential (Current Cycling, Freeze Thaw, Corrosion Salt, Acid Corrosion and Fault-Current) test requirements of IEEE Standard 837-2014.

nVent has recently completed additional mechanical (EMF) testing for 350 kcmil and 500 kcmil copper conductors. The EMF test is very demanding, with test currents of 65kA and 75kA respectively (175kA and 202kA 1st cycle positive peak current) that result in exposing the connections to severe heat and mechanical energy.

Cadweld products are held to the highest standards to ensure a secure connection in even the most extreme applications.

Cadweld is an exothermic welding system for developing permanent welded electrical connections that will never loosen, corrode or increase in resistance. High-quality Cadweld connections are an integral part of the grounding and bonding process. Contact an nVent ERICO representative today to request additional information on Cadweld.

# Grounding, Bonding & Connectivity Products

## nVent ERICO Facility Electrical Protection

nVent ERICO offers a full range of grounding, bonding and connectivity products for data centers and other datacom applications worldwide. nVent ERICO's product offerings include grounding and bonding accessories, surge protection and lightning protection products, and welded electrical connections.

### Grounding and Bonding

nVent ERICO offers an extensive line of grounding and bonding products, which includes ground rods and accessories, signal reference grids, chemical ground rods, GEM ground enhancement material, couplers, clamps, inspection wells, grounding and perimeter bus bars and ground test instruments.

### Surge Protection

nVent ERICO surge protection products are designed to protect against damaging electrical surges on power and communications lines caused by lightning, building systems and other switching events.

### Lightning Protection

Direct and indirect lightning strikes can pose many risks to businesses, including damaging buildings and critical equipment. nVent ERICO lightning protection products offer a variety of solutions to help protect valuable equipment and personnel and to avoid disruption and downtime.

### Welded Electrical Connections

Cadweld welded electrical connections are used to connect the grounding and bonding conductors to each other and to the ground electrode system, including ground rod electrodes, building steel and rebar. Cadweld connections provide a permanent, low-resistance connection needed to create a long-lasting, reliable bonding network. Cadweld connections will not deteriorate, cannot loosen and are made with inexpensive, lightweight and portable equipment. Cadweld Exolon is a filtered, smokeless connection system designed for making connections indoors.

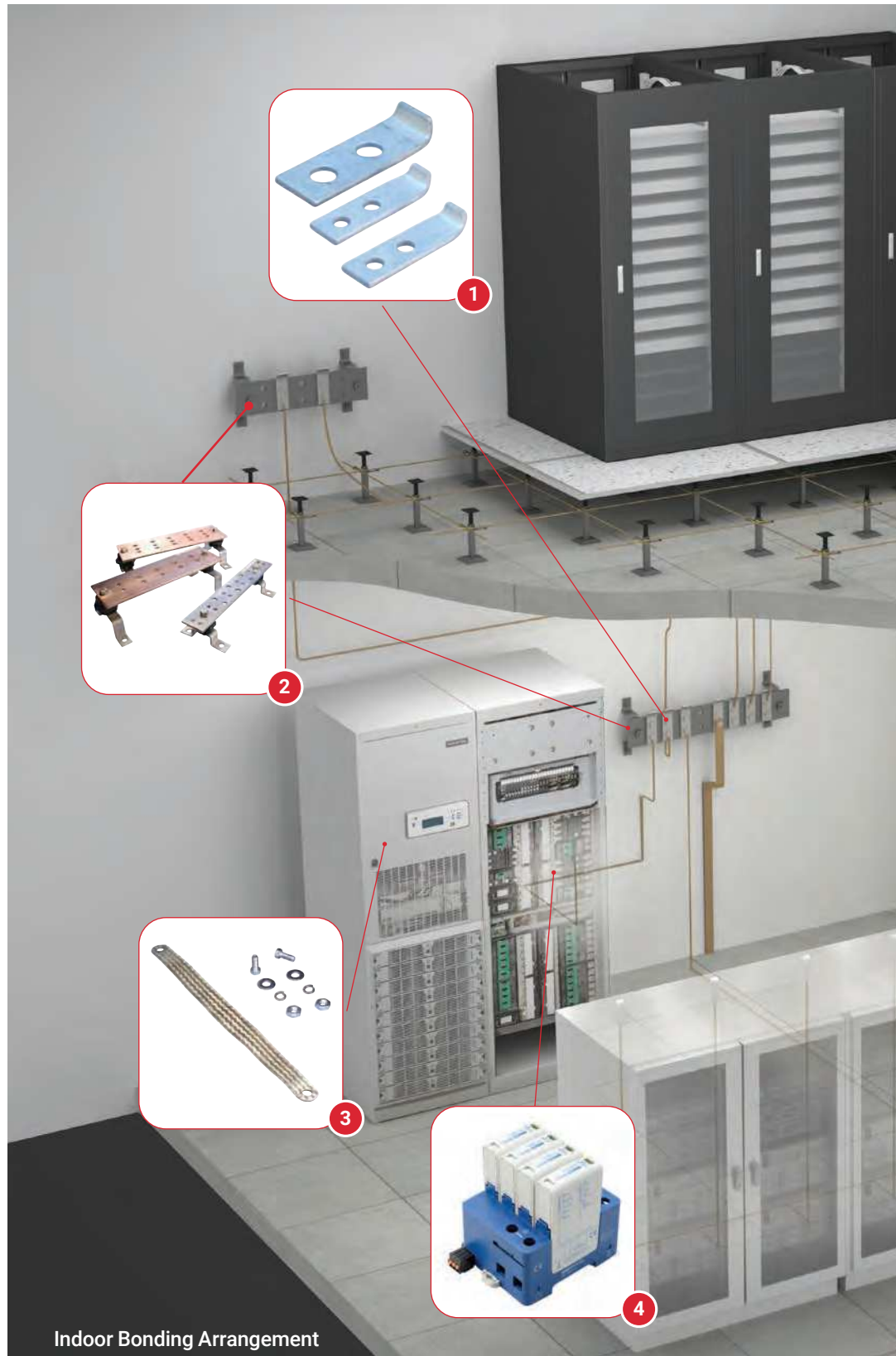

Indoor Bonding Arrangement

- 1 Bonding Lugs
- 2 Equipotential Ground Bar
- 3 Ground Bonding Braids
- 4 AC Power Surge Protection





5 Network Surge Protector

6 Signal Reference Grid

### Prefabricated Signal Reference Grid (SRG)

The SRG is an integrated high-frequency, low-impedance signal reference grid structure, which consists of a network of flat copper strips welded at the crossovers in accordance with recommendations found in IEEE® 1100 “IEEE Recommended Practice for Powering and Grounding Electronic Equipment.” The SRG is also referred to as a “Supplementary Bonding Grid” (SBG) per TIA® 607.

The SRG lies directly on the sub-floor under the raised-floor structure and is used to interconnect metal frames, racks, enclosures, common terminals for signal level power and the electrical distribution grounding system. The SRG is used as a ground reference system for IT equipment by creating an equipotential ground reference plane over a large range of frequencies from DC through the Megahertz range. At high frequencies, flat strip conductors have considerably lower inductive reactance than concentric stranded or solid conductors and the configuration of the SRG results in a lower impedance system, which limits potential differences between data systems and other systems during voltage transients or other power system disturbances. The following graph from IEEE 1100 shows the impedance of an SRG system versus a wire-only grounding system.

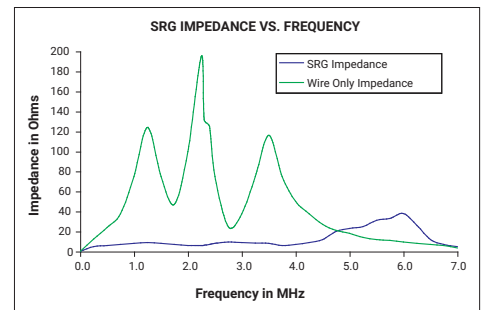

### SRG Features and Benefits

- Economical and maintenance-free
- Recommended in IEEE® 1100
- Reduces common-mode noise
- Increases noise immunity to electric fields
- Reduces capacitive coupled interference
- Compliant with Information Technology Industry Council Information Letter “Guidelines For Grounding Information Technology Equipment (ITE)” and the National Electrical Code.

IEEE is a registered trademark of The Institute of Electrical and Electronics Engineers, Incorporated.  
TIA is a copyright of Telecommunications Industry Association

NOTE: Cadweld connections shown are typical. Connections for any configuration and conductor are available to meet specific application requirements.

# Electrical Protection from the Grounding Up

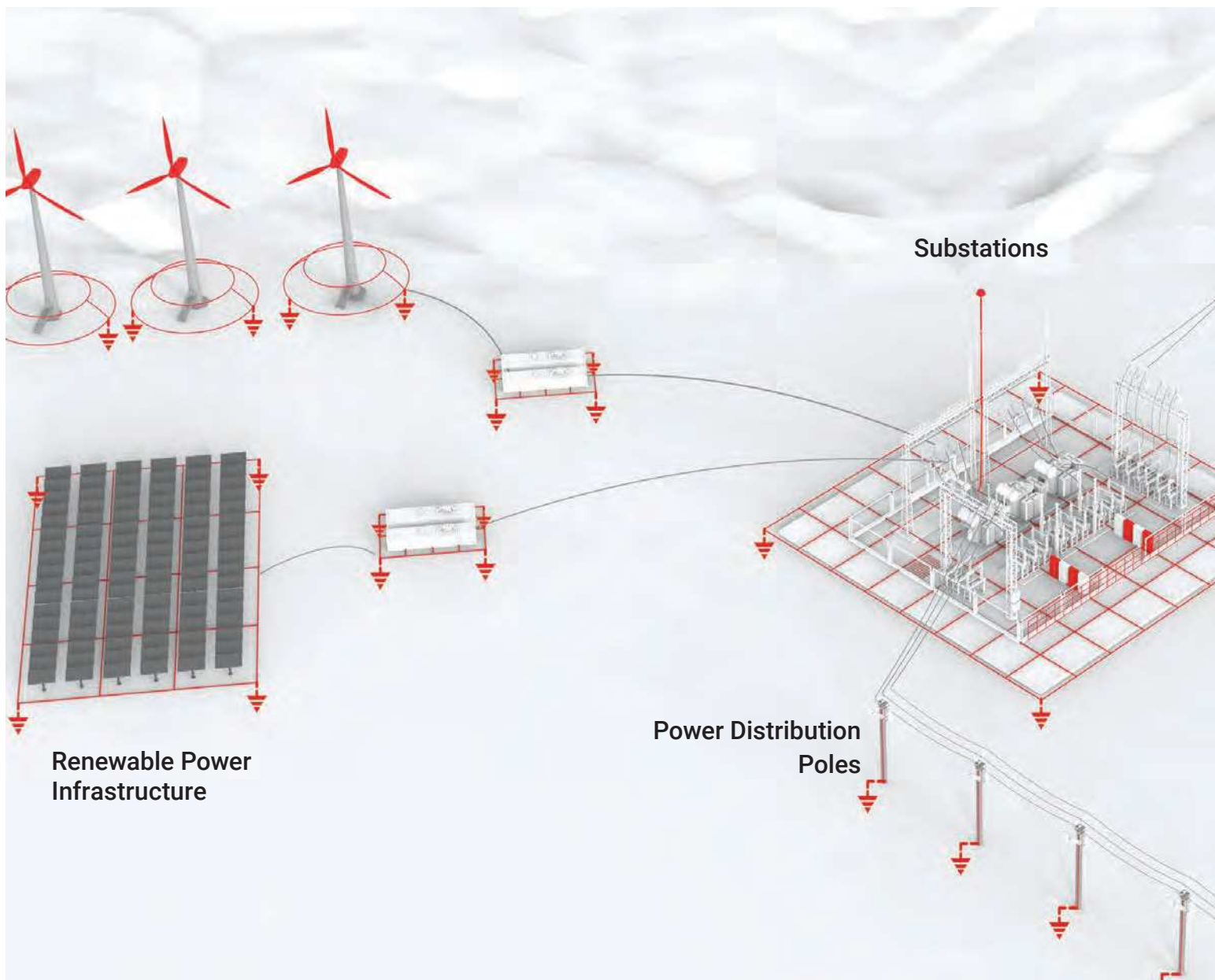

## Grounding

Ground Rods, Mats and Mesh

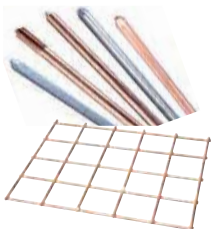

Specialized Ground Plates and Theft Deterrent Conductors



Ground Enhancement Material



## Exothermic Connections

nVent ERICO Cadweld Plus and Cadweld Plus One Shot



## High Voltage Transmission Lines



### Every red highlight in the environment above depicts essential nVent ERICO electrical protection applications:

- Each **red arrows** represents a ground which includes nVent ERICO ground rods.
- nVent ERICO ground grids and ground rings (**highlighted in red**) are installed underground beneath all of the infrastructure.
- nVent ERICO direct strike lightning protection (**depicted as red masts**) is shown protecting substation and traditional power generation infrastructure.
- nVent ERICO Surge Protective Devices are represented in the red enclosures within the substation but are applicable wherever electrical and electronic equipment is present within the environment.

## Traditional Power Infrastructure

### Lightning Protection

#### nVent ERICO System 3000 and System 2000



### Surge Protective Devices

- Primary and secondary power protection
- Equipment inputs and outputs
- Data and signal line protection



# Grounding, Bonding & Protection of Water Treatment Plant

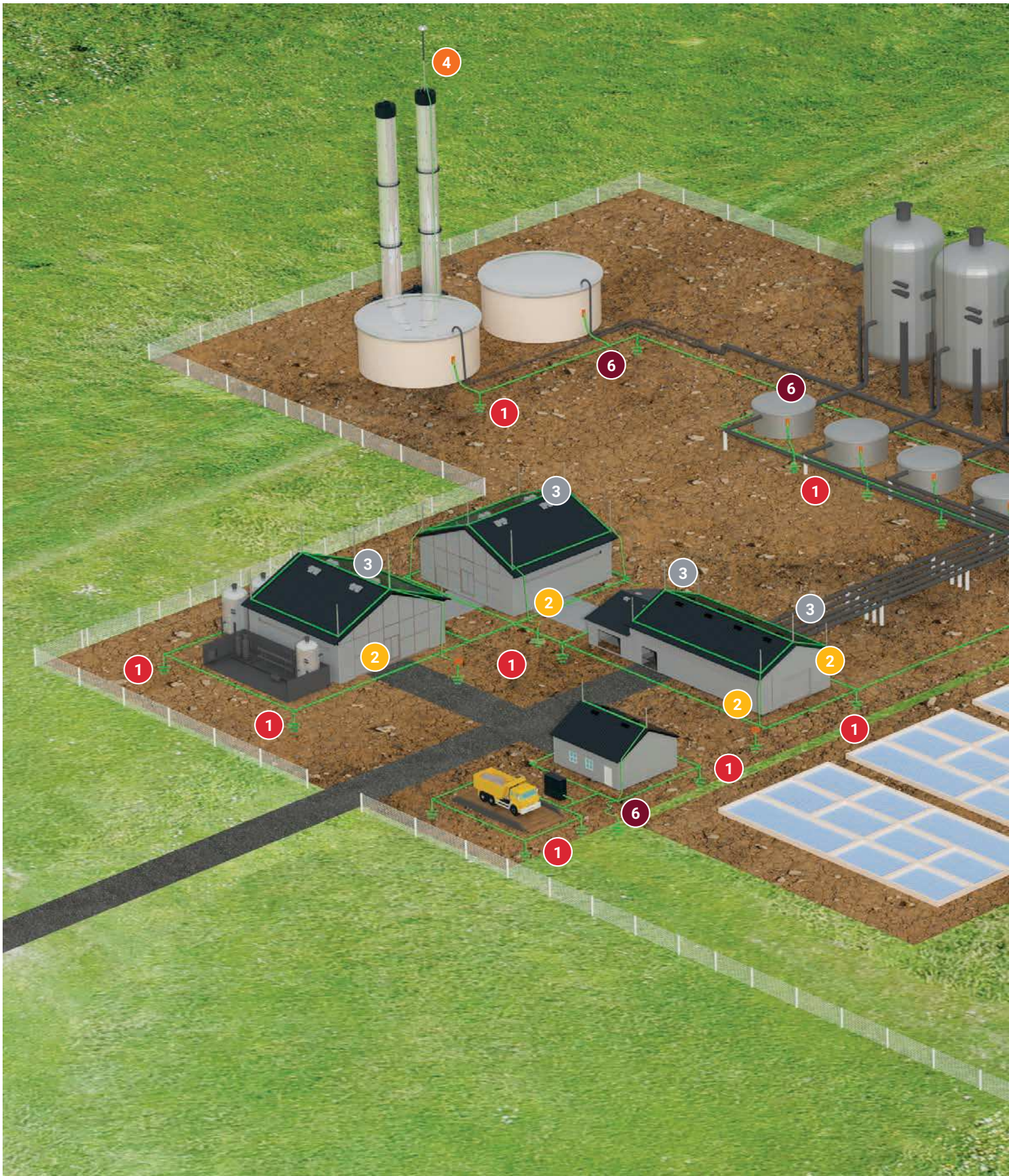

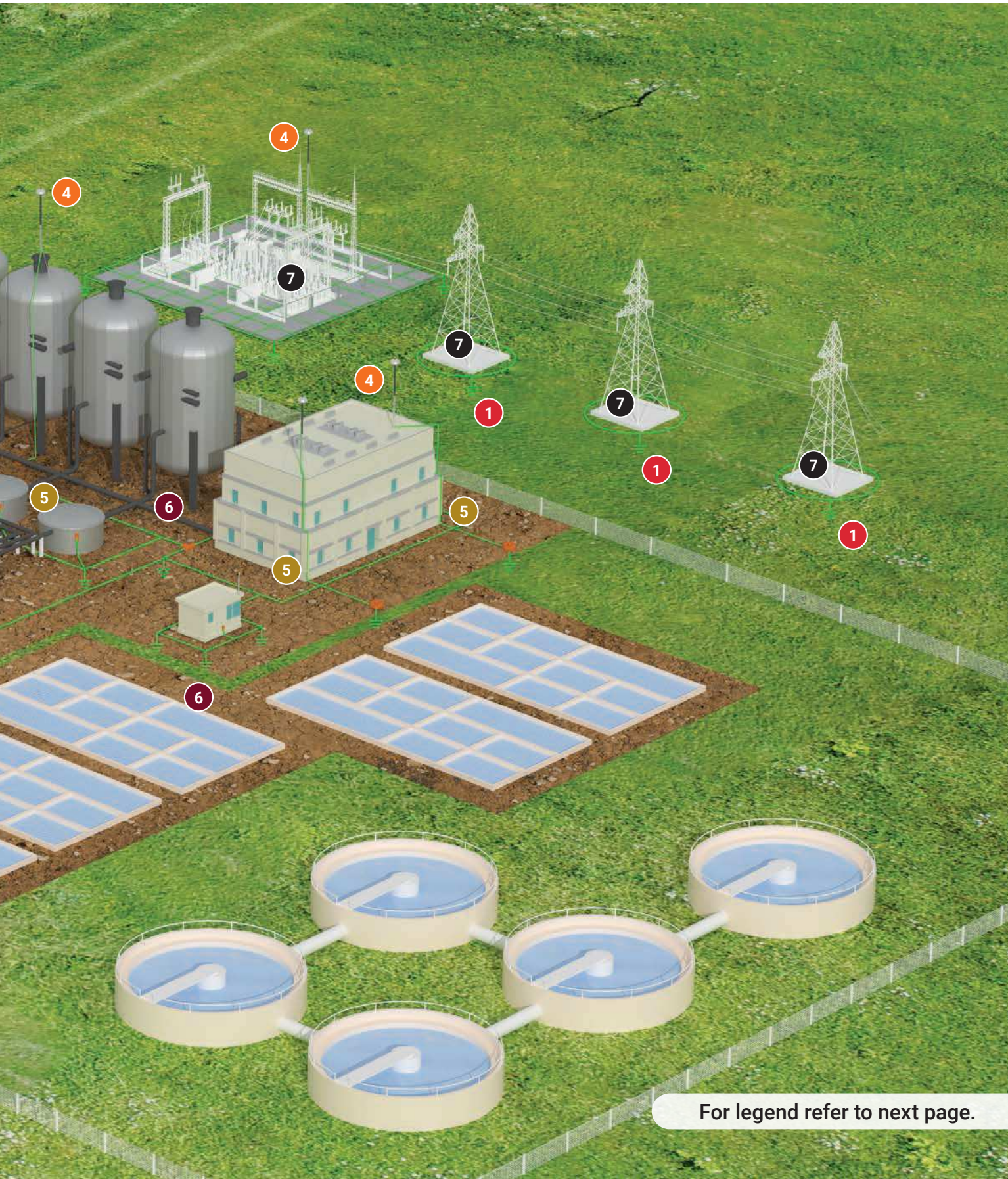

For legend refer to next page.

# Grounding, Bonding & Protection of Water Treatment Plant

## Component 1

**Cadweld GY Connection**



**Hammerlock**



**Cadweld GR Mold**



**Cadweld LQ Mold**



**Ground Rod Clamp**



**Ground Rods  
614300, 615880, 615850**



## Component 2

**Lightning Downconductor LPC122, LPA100, LPC124**



**Lightning Downconductor 25 x 3 mm Cu or Al Tape**



## Component 3

**Air Termination**



**Air Terminal Base**

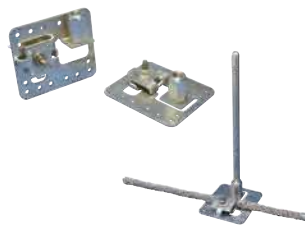

**Connectors**



**Connectors**



## Component 4

**System 3000**

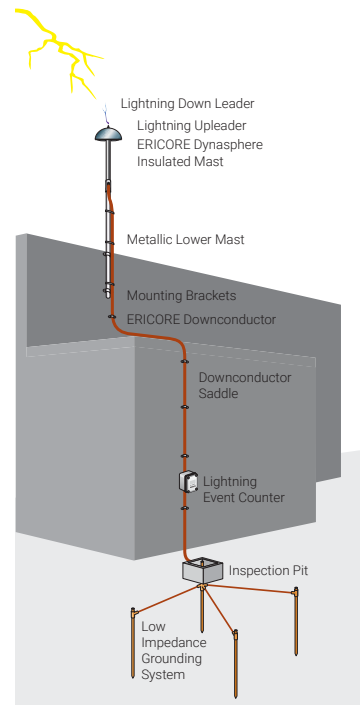

# Grounding, Bonding & Protection of Water Treatment Plant

## Component 5

### System 3000 Grounding

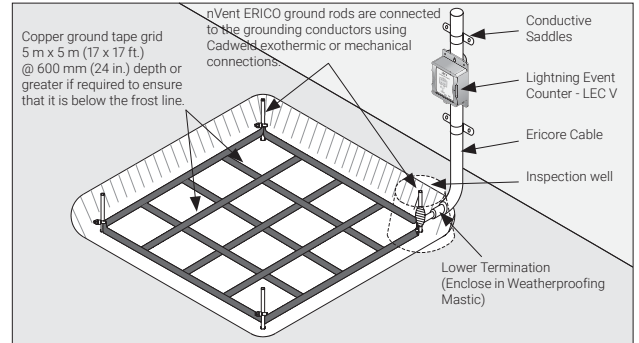
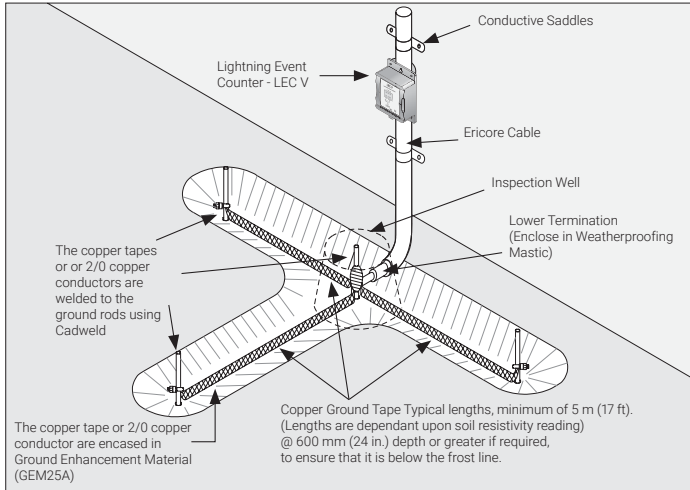

## Component 6

### TAC Cadweld

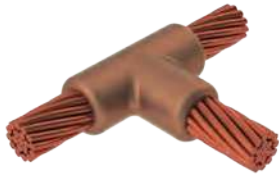

### PTC Cadweld

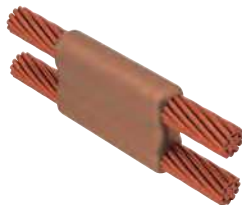

### XB Cadweld

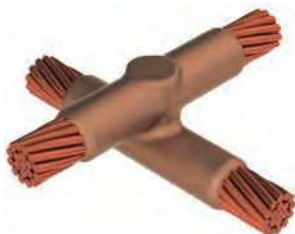

## Component 7

### HA Cadweld

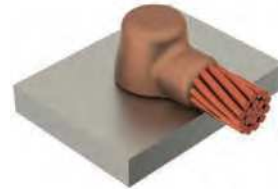

### VB Cadweld

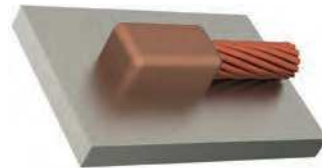

### VS Cadweld



# Grounding, Bonding & Protection of Industrial Facility

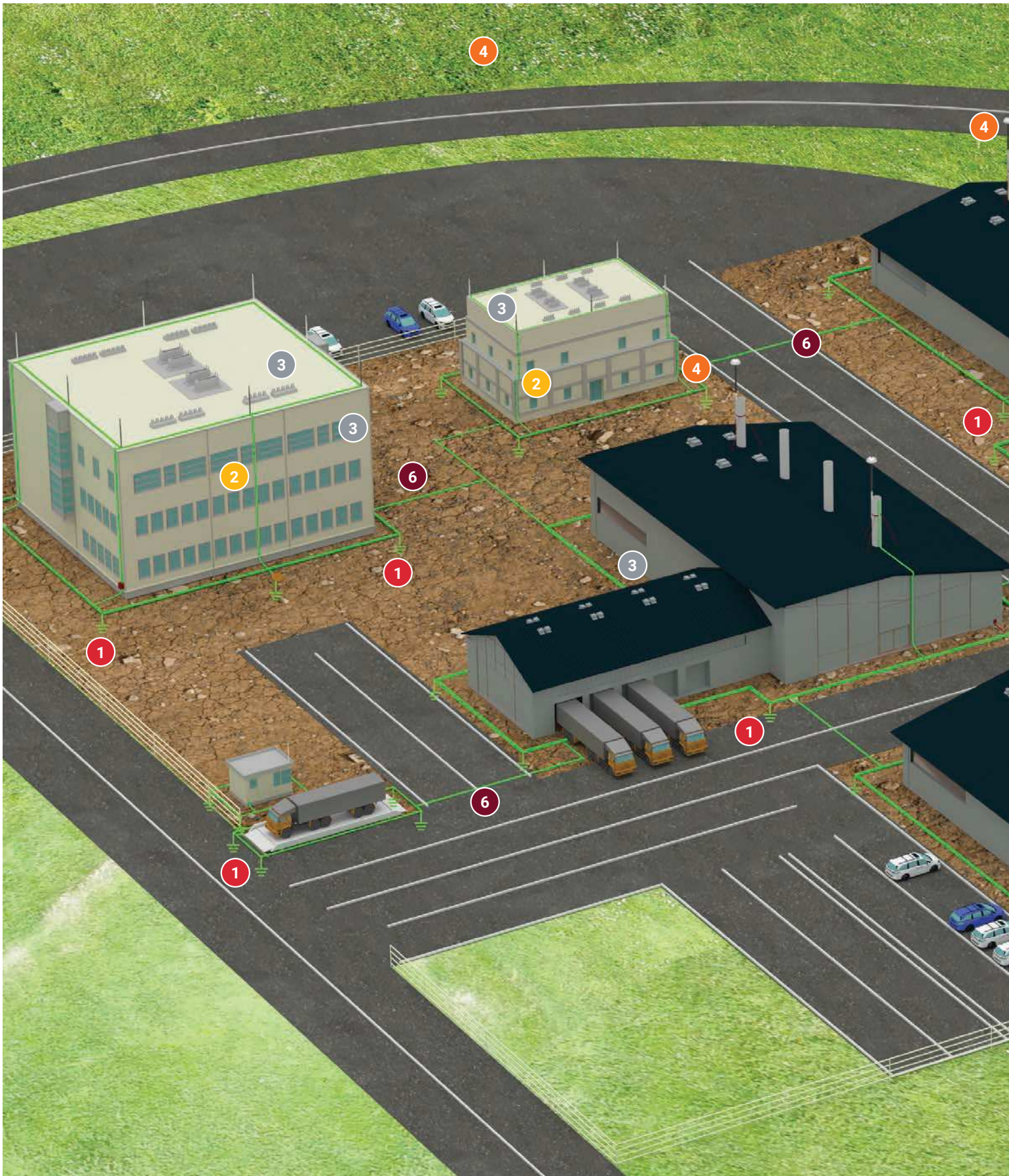



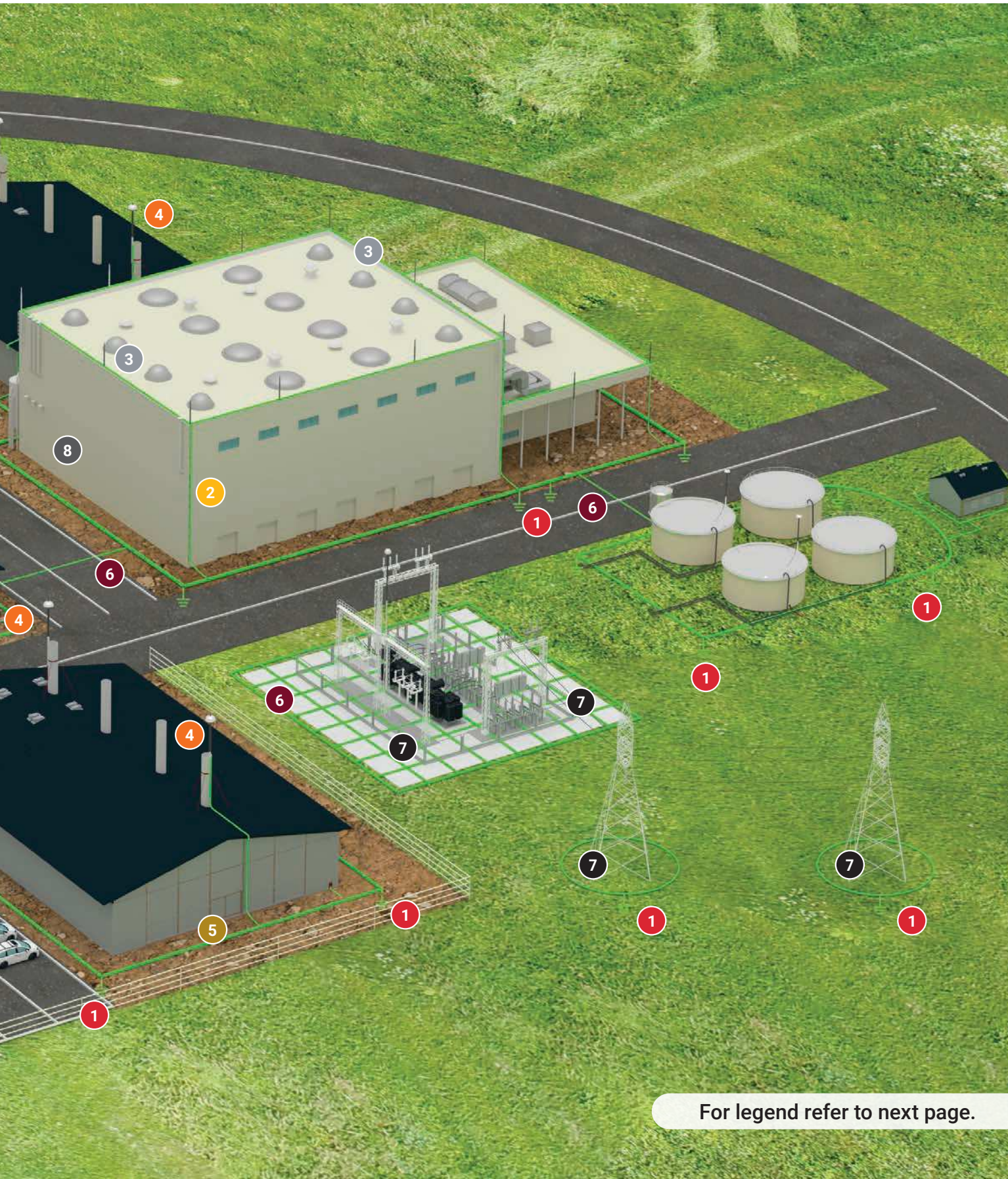

For legend refer to next page.

# Grounding, Bonding & Protection of Industrial Facility

## Component 1

**Cadweld GY Connection**



**Hammerlock**



**Cadweld GR Mold**



**Cadweld LQ Mold**



**Ground Rod Clamp**



**Ground Rods  
614300, 615880, 615850**



## Component 2

**Lightning Downconductor LPC122, LPA100, LPC124**



**Lightning Downconductor 25 x 3 mm Cu or Al Tape**



## Component 3

**Air Termination**



**Air Terminal Base**

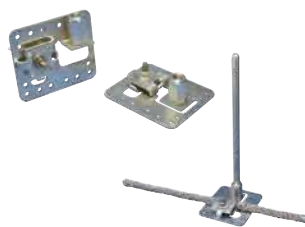

**Connectors**



**Connectors**



## Component 4

**System 3000**

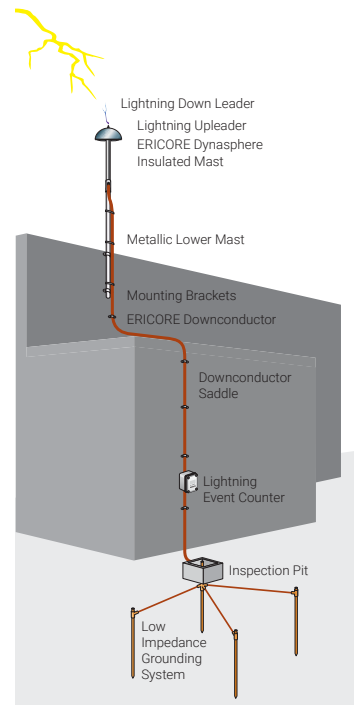

# Grounding, Bonding & Protection of Industrial Facility

## Component 5

### System 3000 Grounding

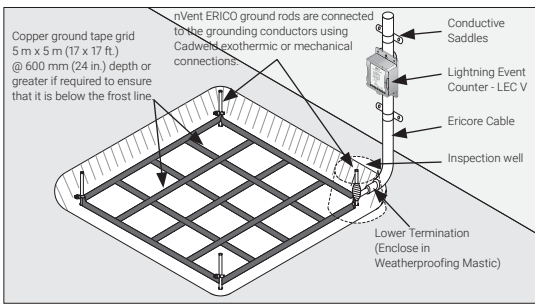
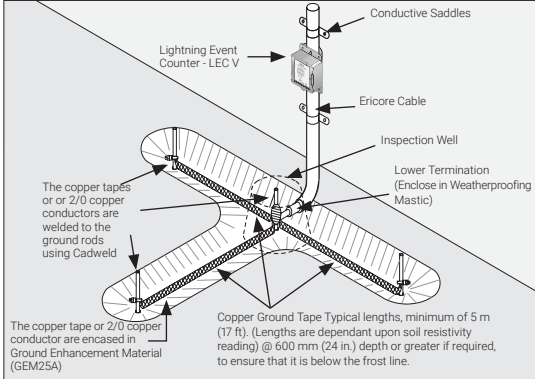

## Component 6

### TAC Cadweld

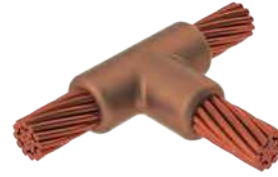

### PTC Cadweld

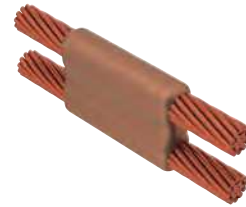

### XB Cadweld



## Component 7

### HA Cadweld

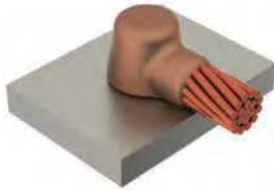

### VB Cadweld

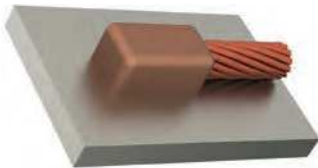

### VS Cadweld



## Component 8

### Data Room



### Mechanical Mesh Bonding

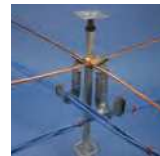

### Equipotential Ground Bar



### Signal Reference Grid



### Bonding Lugs



# Grounding, Bonding & Protection of Oil & Gas Facility





For legend refer to next page.

# Grounding, Bonding & Protection of Oil & Gas Facility

## Component 1

Cadweld GY Connection



Hammerlock



Cadweld GR Mold



Cadweld LQ Mold



Ground Rod Clamp



Ground Rods  
614300, 615880, 615850



## Component 2

Lightning Downconductor LPC122, LPA100, LPC124



Lightning Downconductor 25 x 3 mm Cu or Al Tape



## Component 3

Air Termination



Air Terminal Base

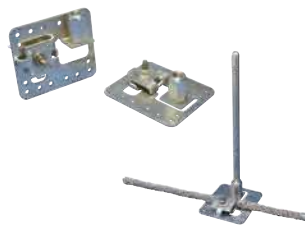

Connectors



Connectors



## Component 4

System 3000

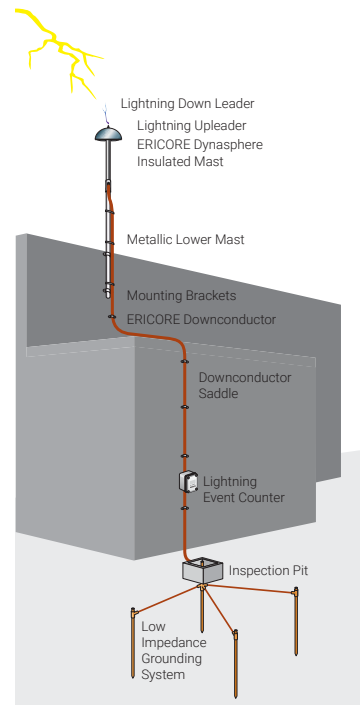

# Grounding, Bonding & Protection of Oil & Gas Facility

## Component 5

### System 3000 Grounding

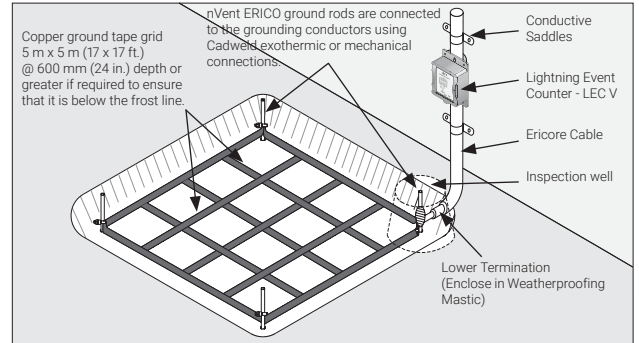
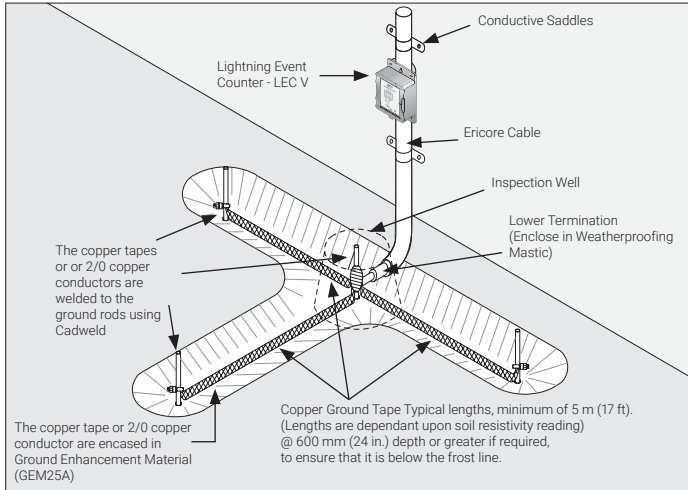

## Component 6

### TAC Cadweld

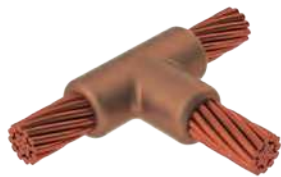

### PTC Cadweld

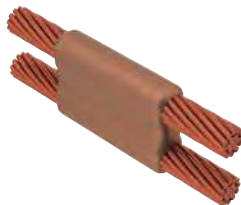

### XB Cadweld

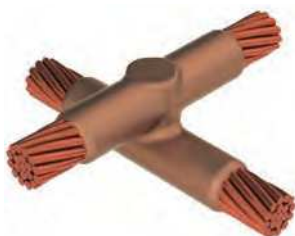

## Component 7

### HA Cadweld

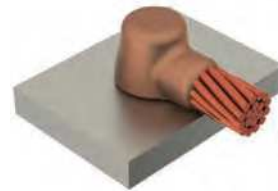

### VB Cadweld

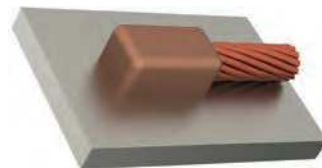

### VS Cadweld



# nVent ERICO Outdoor Grounding and Protection Arrangement

The outdoor arrangement of a grounding system at a typical telecommunication radio site



1. Theft deterrent composite cable



2. Ground enhancement material, GEM or Quickfill

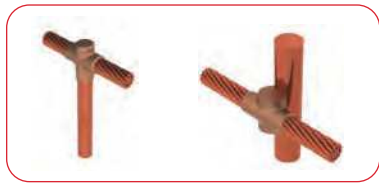

3. Cadweld connections



3. Ground rod



3. Mechanical connector, REC16120



3. Mechanical connector, GUV16070



3. nVent ERICO Hammerlock



3. Mechanical connector, SP58



4. Cadweld tower bond

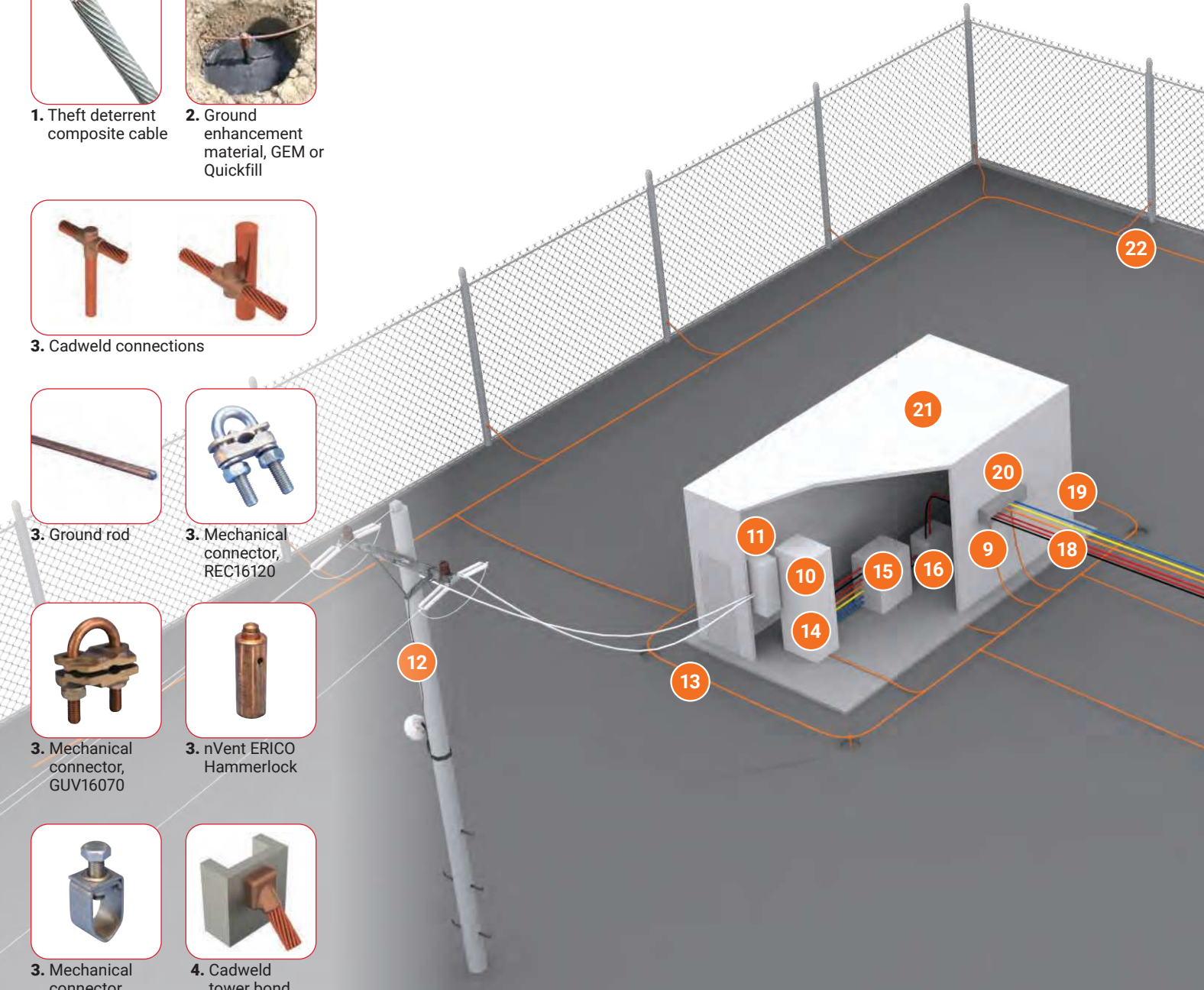

12. AC power line

13. Telecom ground electrode

14. AC main switch board & Surge protection

15. Rectifier

16. DC surge protection remote radio feed

17. Tower ground electrode



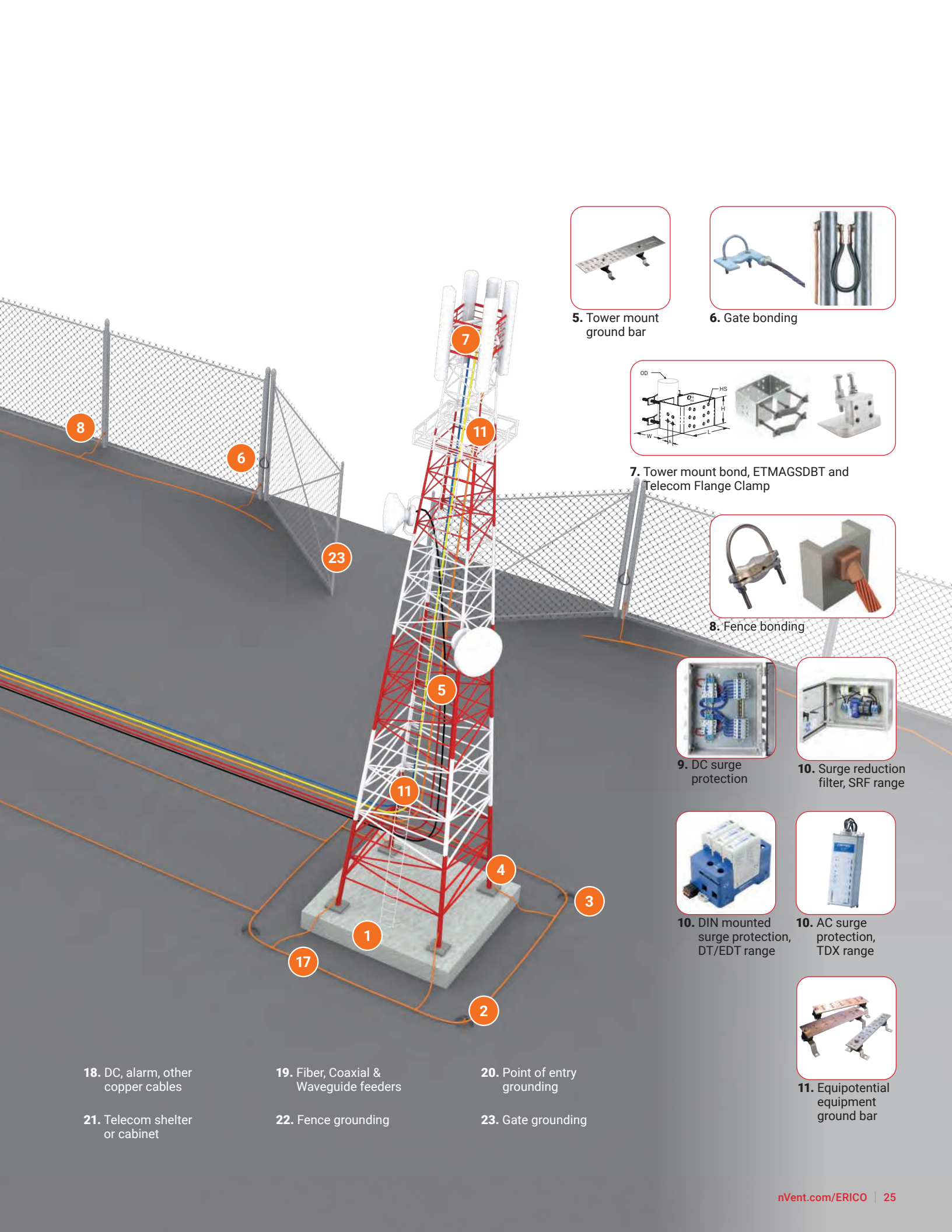

5. Tower mount ground bar



6. Gate bonding

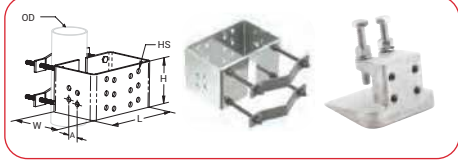

7. Tower mount bond, ETMAGSDBT and Telecom Flange Clamp



8. Fence bonding



9. DC surge protection



10. Surge reduction filter, SRF range



10. DIN mounted surge protection, DT/EDT range



10. AC surge protection, TDX range



11. Equipotential equipment ground bar

18. DC, alarm, other copper cables

19. Fiber, Coaxial & Waveguide feeders

20. Point of entry grounding

21. Telecom shelter or cabinet

22. Fence grounding

23. Gate grounding

# Grounding Principles



## INTRODUCTION

Grounding and bonding are an integral part of any modern electrical protection system design. An effective, low-impedance ground system is a key element of this system.

It is crucial to help provide personnel safety, as well as reliable protection for vital equipment and to minimize interruptions of service and costly downtime.

With over a century of experience in the design and manufacture of bonding and grounding products, nVent ERICO, a single source provider, offers what we believe is the best range of long lasting and cost-effective grounding products available.

## BASIC DEFINITIONS

**Ground:** A conducting connection, whether intentional or accidental, between an electrical circuit or equipment and the ground, or to some conducting body that serves in place of the ground.

**Bonding:** The permanent joining of metallic parts to form an electrically conductive path that will ensure electrical continuity and the capacity to conduct any current likely to be imposed.

## THE NEED FOR GROUNDING!

There are important reasons why a grounding system should be installed.

1. The most important reason is to help protect people!
2. For protection and safety in the event of unintentional contact with live conductors.
3. To help support maximum safety from electrical system faults and lightning.

It is a fundamental fact that current always flows to the point of lowest potential. The goal of any properly designed Grounding system is to ensure that current generated by electrical faults or lightning events flows to this point. A good grounding system results in minimum voltage drop providing maximum safety to people while maintaining the reliability of equipment.

## GROUNDING CODES AND STANDARDS

Grounding systems vary according to application. For example, the Grounding requirements for power systems vary from lightning protection systems or telecommunication systems.

Proper installation of appropriate Grounding systems requires knowledge of the needs and layout of the facility. Soil characteristics, grounding conductor materials grounding connections and terminations, are significant factors determining the design of a grounding system. Applicable standards and codes must be followed.

While many codes and standards contain minimum grounding and bonding requirements, the design and installation of electrical grounding systems is one of the most important aspects of any electrical distribution system. However, grounding systems can be misunderstood and therefore improperly designed and installed.

# Grounding Principles

## WHY IS GROUNDING IMPORTANT?

The transient nature of lightning with its associated fast rise times and large magnitude currents mean that special consideration needs to be given to Grounding, for lightning protection to be effective. Many factors such as soil resistivity variations, installation accessibility, layout and existing physical features are all site specific and tend to affect decisions on Grounding methods. The primary goal of an Grounding system for direct strike lightning protection is to:

- Efficiently dissipate lightning energy into the ground
- Help protect equipment and personnel
- Provide equipotential control

## GROUNDING PRINCIPLES

Low impedance is the key to lightning protection. All grounding conductors should be as short and direct as possible to minimize inductance and reduce peak voltages induced in the system. The ground electrode system must efficiently dissipate lightning surges into the ground by minimizing the impedance of the electrode to ground.

## SOIL RESISTIVITY

Soil resistivity is an important design consideration. The resistivity varies markedly for different soil types, moisture content and temperatures and gives rise to variations in ground impedances.

## SHORT, DIRECT GROUND CONNECTIONS

The voltage generated by a lightning discharge depends primarily on the risetime of the current and the impedance (primarily inductance) of the path to ground. Extremely fast rise times result in significant voltage rises due to any series inductance resulting from long, indirect paths, or sharp bends in the routing of ground conductors. This is why short, direct ground connections are important.

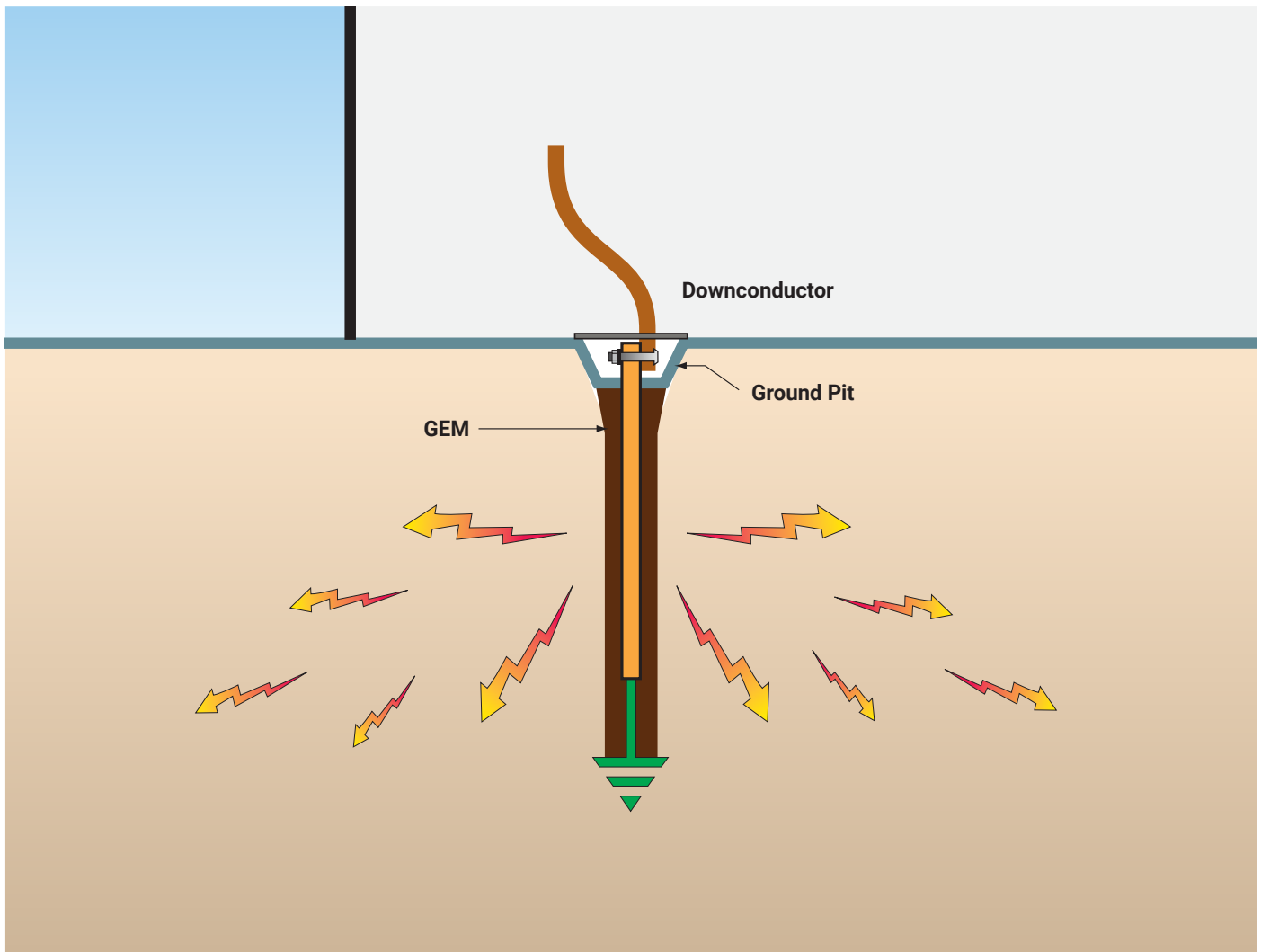

# Grounding Principles

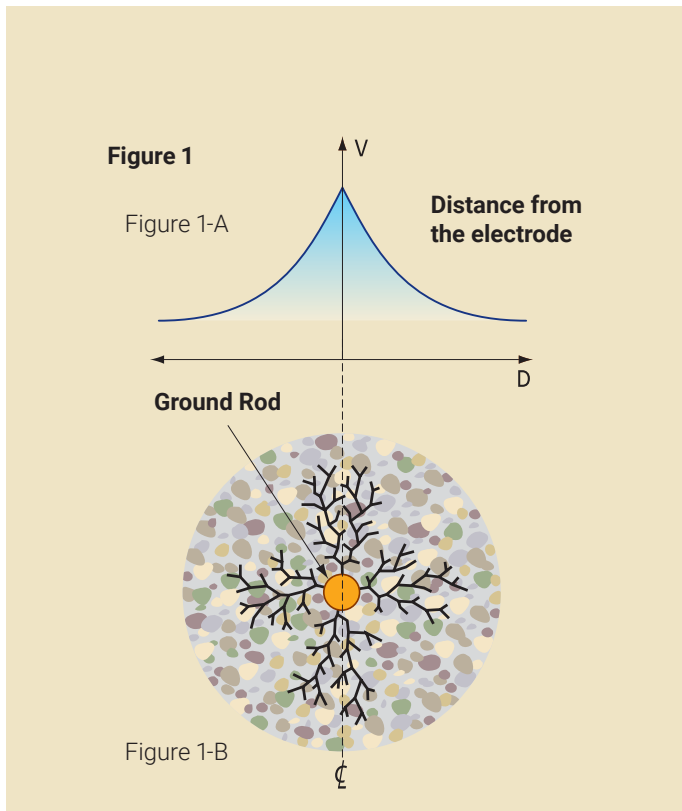

**Figure 1:** illustrates current flow from a single ground electrode. The current paths are shown in Figure 1-B. Figure 1-A illustrates the voltage gradient that is produced as a result of this current flow. This gradient levels off at some distance from the ground electrode. The voltage gradients are determined by the ground electrode impedance and the soil resistivity.

## Characteristics of good Grounding systems include:

- **High electrical conductivity**
- **Long life – robust and capable of withstanding fault and lightning currents**
- **Low ground resistance and impedance**

High electrical conductivity helps minimize system impedance and reduces potential differences between bonded metallic water services, power systems, telecommunication systems and the ground reference point. High electrical conductivity also minimizes step and touch potential in substation Grounding applications.

## LONG LIFE

The ground electrode system should be corrosion resistant, and compatible with other conductors that are buried and bonded to the Grounding system. Copper is commonly used for Grounding conductors. When accessible, some form of maintenance or inspection procedure should be adopted to ensure the long-term effectiveness of an Grounding system.

Mechanical connectors are sometimes used to join Grounding conductors, however they are more susceptible to corrosion, especially when dissimilar metals are used. In addition to mechanical strength, Cadweld connections provide excellent low impedance, long life electrical connections with excellent corrosion resistance.

## GROUND RESISTANCE

When current flows from an ground electrode into the surrounding soil, it can be described as flowing through a series of concentric shells of increasing diameter.

Each successive shell has a greater area for current flow and consequently, lower resistance. At some point distant from the ground conductor the current dissipation becomes so large and current density so small, that the resistance becomes negligible.

The equations for systems of electrodes are very complex and often expressed only as approximations. For example uniform ground (or soil) resistivity is assumed, although this is seldom the case in nature. The most commonly used formula for single ground electrode systems, developed by Professor H.R. Dwight of the Massachusetts Institute of Technology, is the following:

$$R = P \frac{\rho}{2\pi L} \left\{ \ln \frac{4L}{r} - 1 \right\}$$

R = resistance in ohms of the ground rod to the ground (or soil)

L = grounding electrode length

r = grounding electrode radius

$\rho$  = average resistivity in ohms-cm.

# Grounding Principles

## CONDITIONS INFLUENCING SOIL RESISTIVITY

The resistance of the ground itself (soil resistivity) can significantly impact the overall impedance of the grounding system. Several factors, such as soil composition, moisture content, mineral content, contaminants, etc., determine the overall resistivity of the ground.

SOIL TYPE	Resistivity ohm-cm		
	Average	Min.	Max.
Fills – ashes, cinders, brine wastes	2,370	590	7,000
Clay, shale, gumbo, loam	4,060	340	16,300
Clay, shale, gumbo, loam with varying proportions of sand and gravel	15,800	1,020	135,000
Gravel, sand, stones, with little clay or loam	94,000	59,000	458,000

U.S. Bureau of Standards Technical Report 108

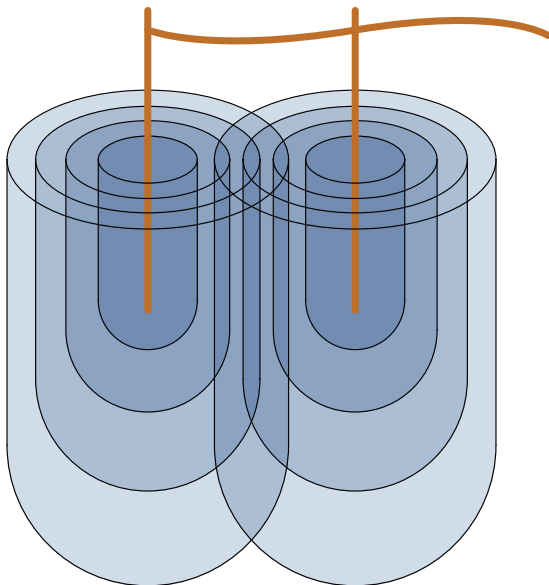

Sphere of Influence - parallel ground electrodes need to be properly spaced to minimize ground resistance due to sphere of influence. The distance between ground electrodes should be greater than or equal to the length of the electrodes.

## SOIL RESISTIVITY TESTING

To properly design a grounding system, it is essential to test soil resistivity. There are a few methods that can be used to measure ground resistivity. The four point method is the most common and accurate and the one that nVent recommends.

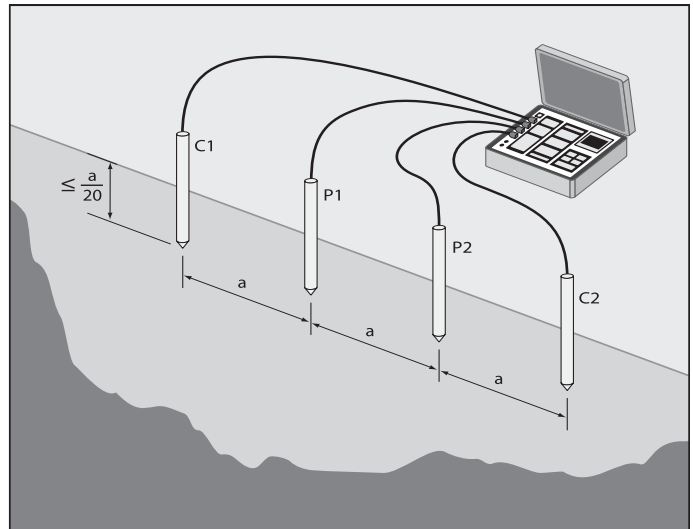

### THE FOUR-POINT METHOD (EQUALLY SPACED OR WENNER METHOD)

- Four test stakes are positioned in a straight line an equal distance apart and are installed into the ground as shown in Figure 2.
- A resistance tester is connected as shown in Figure 2. A test current is passed between the outer probes, C1 and C2, and the voltage is measured between the two inner probes, P1 and P2.
- With this arrangement the apparent resistivity is determined using the following equation:

R = the resistance value in ohms, measured from the test instrument

$$\rho = \frac{4\pi aR}{\frac{1+2a}{\sqrt{a^2+4b^2}} - \frac{2a}{\sqrt{a^2+4b^2}}}$$

Where:

a = distance between the electrodes in centimeters

b = electrode depth in centimeters

If  $a > 20b$ , the formula can be simplified to:

$$\rho = 2\pi aR \text{ (with } a \text{ in cm)}$$

$\rho$  = Soil resistivity (ohm-cm)

This value is average resistivity of the ground at a depth equivalent to the distance "a" between two electrodes.

# Grounding Principles



Avoid hazardous Step and Touch Potentials (shock) or even death by low impedance grounding and bonding between metallic equipment, chassis, piping, and other conductive objects so that currents, due to faults, do not result in hazardous voltage rise.

## STEP AND TOUCH POTENTIAL

### Step Potential

Step potential is the voltage difference between a person's feet caused by the dissipation gradient of a fault entering the ground.

### Touch Potential

Touch potential is similar to "Step potential" except that the fault current passes through the person's arm and torso on the way to the ground.

With proper installation of grounding systems these step and touch potentials can be minimized to a safe level.

See IEEE Std 80, IEEE Guide for Safety in AC Substation Grounding.

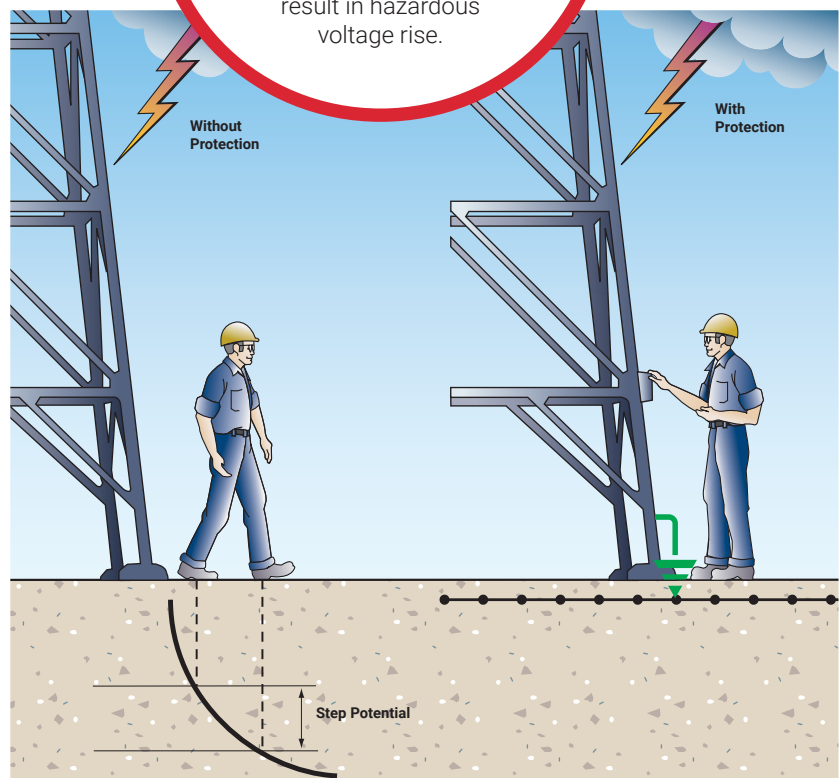

# Grounding Principles

## **GROUNDING/GROUNDING SYSTEM DESIGN**

Grounding systems are important. It is far more economical to design and install an appropriate Grounding system during initial construction than it is to expand, augment or replace an Grounding system after the facility is in service. Care should be taken to design a system that is appropriate both for clearing ground faults and dissipating lightning energy. The system must have a long performance life, meet applicable codes/standards for safety, and have sufficient bonding points to make it easy to expand the Grounding system for future growth.

### **Design considerations include:**

- Purpose of facility
- Design life of facility
- Soil resistivity
- Corrosive nature of soil
- Shape and available area of facility site
- Existing structures and their grounding systems
- Seasonal variations in moisture and temperature for facility site
- Public access & personnel use
- Adjacent facilities and electrical systems
- Future uses, additions, equipment for facility

For proper operation of overcurrent devices it is important to have a low impedance path for the return current.

For dissipation of direct or indirect lightning currents, it is better to have many horizontal ground conductors in the soil, preferably in a radial array. This provides a low impedance path of dissipation to the high frequency component of the lightning energy.

For personnel, particularly where equipment operators will be located or where accessible by the public, it is important to have a grid system or other equipotential plane to reduce “step potential” and have equipment and metal structures bonded to the ground system to reduce “touch potential”.

A proper facility Grounding system incorporates these necessities in the most cost-effective manner that will last for the design life of the facility.

nVent is a manufacturer and marketer of Grounding, bonding, lightning protection and surge protection products and systems under the nVent ERICO sub-brand. nVent ERICO has many knowledgeable and experienced engineers on staff with the training and the tools (including some of the latest design software) to design appropriate Grounding systems. These engineers can assist facility owners, engineers and contractors in designing the most appropriate system for the facility in question.

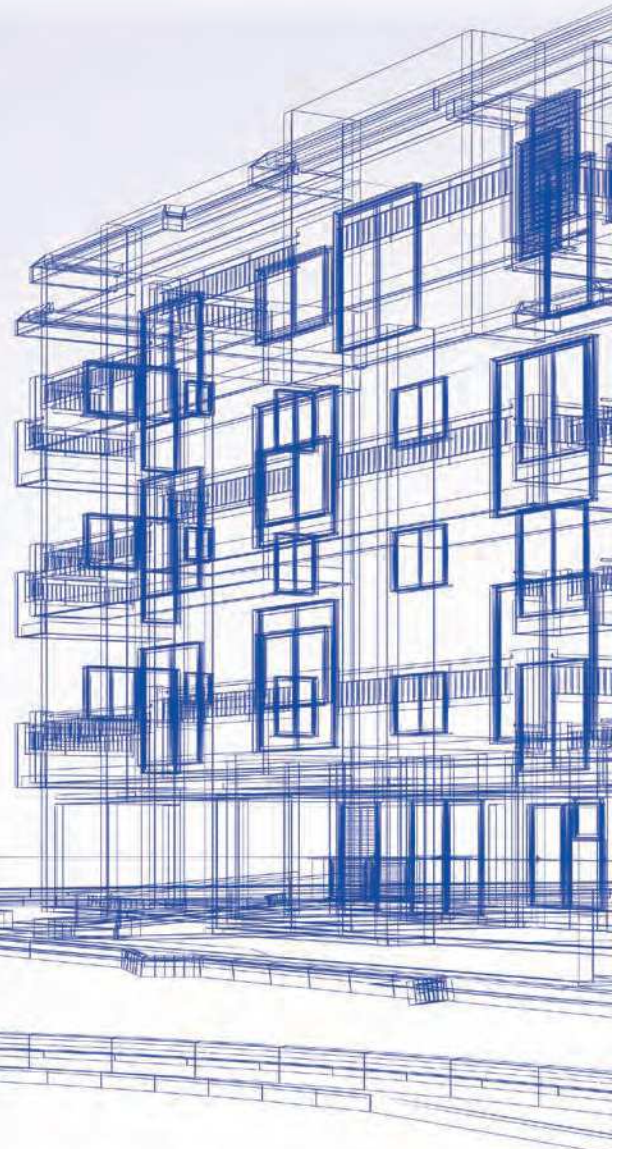

# Grounding Principles

## THE GROUNDING CHAIN

The performance of the Grounding system is determined by the quality of the following five components all of which are of equal importance.

1. The Grounding Electrode Conductor. Commonly made from copper or copper-bonded steel, the Grounding electrode conductor must be large enough to withstand the maximum available fault current over the maximum clearing time.
2. The Grounding Connections. Often overlooked, the Grounding connections are used to tie the elements of the electrode system together. Exothermically welded connections provide a molecular bond that will never loosen or corrode. Mechanical connectors, such as crimp, bolted, and wedge type, rely on physical point-to-point surface contact to maintain the integrity of the electrical connection. IEEE® Standard 837-2014 provides detailed information on the application and testing of permanent grounding connections. nVent ERICO can provide an independent, third-party test report evaluating the performance of these connectors in accordance with the testing procedures set forth in IEEE Standard 837-2014, Standard for Qualifying Permanent Substation Grounding Connections.
3. The Grounding Electrode. The Grounding electrode provides the physical connection to the ground and is used to dissipate current into it. There are two main types of electrodes. "Natural" electrodes are intrinsic to the facility and include metal underground water pipe, the metal frame of the building, and reinforcing steel in concrete foundations. "Made" electrodes are installed specifically to improve the performance of the Grounding system and include wire meshes, metallic plates, buried conductor and rods or pipes driven into the ground. The ground rod is the most widely used electrode.
4. Electrode to Soil Resistance. Rod surface area, depth and placement are the controlling factors. Doubling diameter reduces resistance by only 10% and is not cost effective. Doubling rod length, however, theoretically reduces resistance up to 40%. The most common solution is proper placement of multiple rods that are driven to the required depths.
5. The Soil. The soil resistivity, measured in ohm-centimeters or ohm-meters, plays the most significant role in determining the overall performance of the grounding system and must be known before a proper grounding system can be engineered.



The Grounding system will carry little or no current for long periods of time until a fault or lightning strike occurs. When this happens the components will conduct a large amount of current and should be expected to perform like new. Most of the Grounding system is concealed below grade, making inspection of the grounding components difficult or impossible. The underground environment is a harsh one. The initial selection of the components used in the grounding system is of critical importance to its long-term effectiveness.

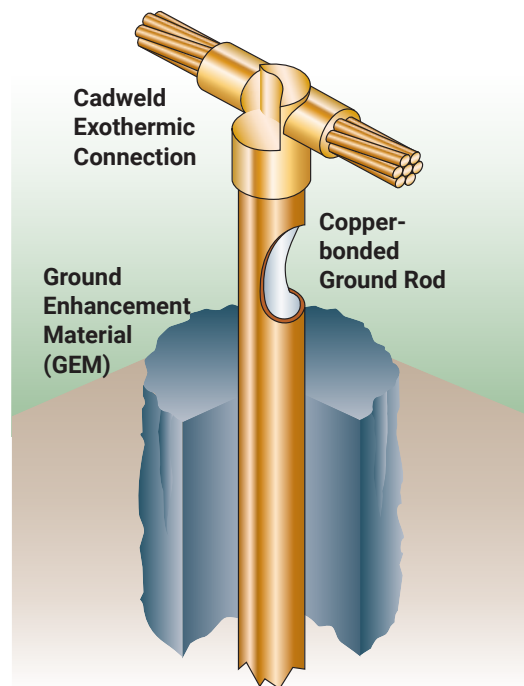



# Grounding System Components



**Ground Rods**  
**Pgs 36-41**

**Compression Coupler**  
**Pg 39**

**Ground Rod Clamps**  
**Pg 44**

**Fence Clamp**  
**Pg 47**

# Ground Conductors

## Conductors

There are two basic criteria for grounding conductor selection:

1. The physical characteristics of the conductor must be of a robust nature, sufficient for the environment.
2. The cross sectional area of the conductor must be of sufficient size, so that it shall successfully conduct the maximum fault current for a period, which allows the operation of protection equipment (or the dissipation of this energy).

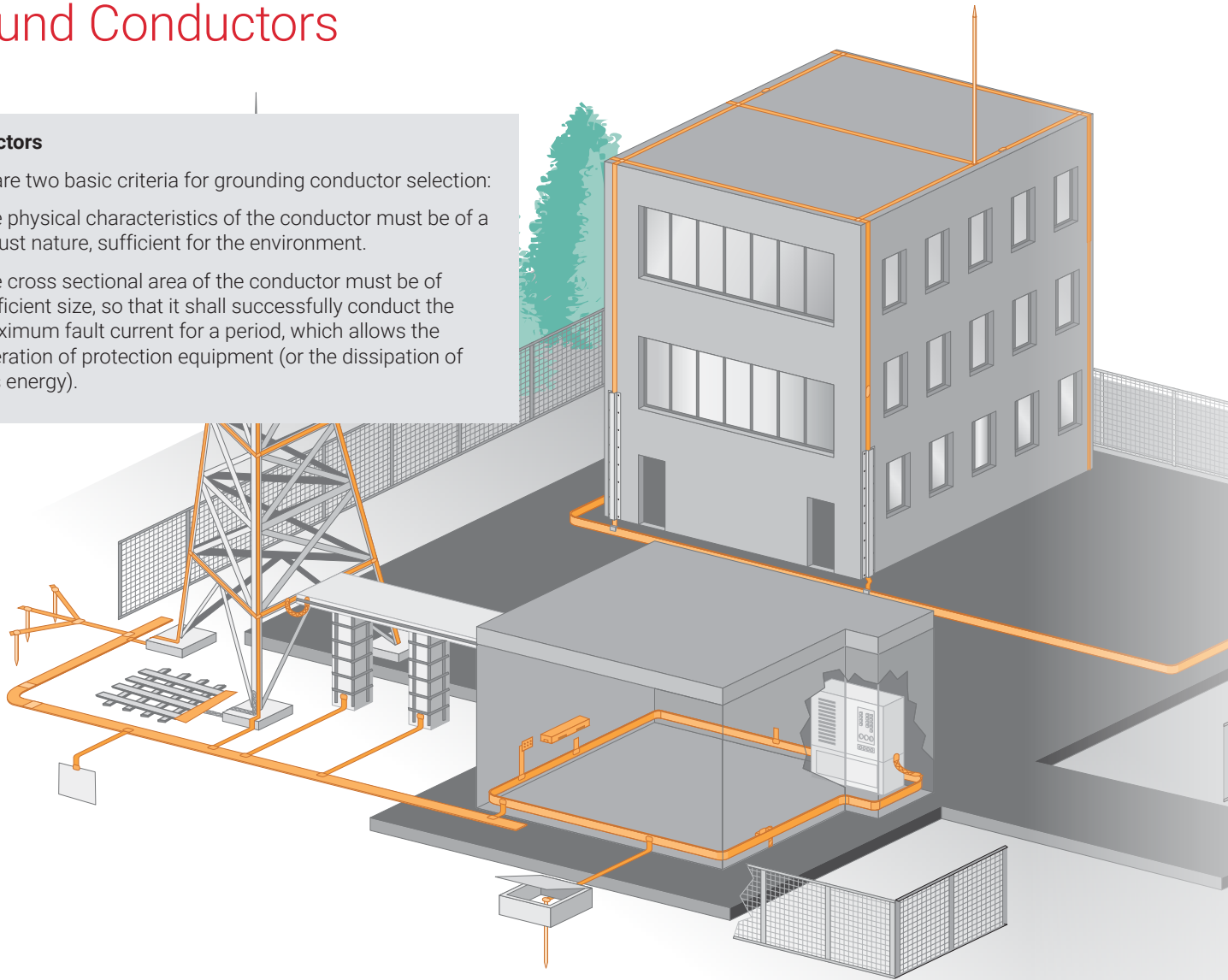

## Physical Characteristics

The most common ground conductor is a soft drawn, stranded copper conductor. Flat copper strip / tape is also popular because it offers a large surface area, resulting in lower impedance.

In some circumstances, the maximum fault current for the installation is small. While a conductor of correspondingly small size could be used, a minimum cross section, often set by the governing authority or applicable standards body (to minimize potential damage likely to occur from any future excavation on the site), is applied.

## Maximum Fault Current

Where higher fault conditions exist, the conductor size is determined by considering the circumstances required to avoid fusing (melting) the conductor. The accepted industry standard is IEEE® 80, Guide for Safety in Substation Grounding.

## Bare Copper & Tinned Copper

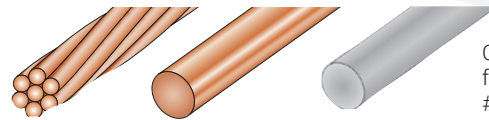

Contact nVent ERICO for available sizes #8 AWG and up.

## Insulated Cables

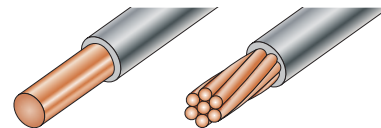

Contact nVent ERICO for available sizes #8 AWG and up.

## Flat Strip Ground Conductor

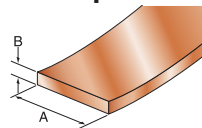

- Pure electrolytic copper
- Low impedance
- Lower impedance than equivalent sized round conductor

Contact nVent ERICO for available sizes minimum thickness of 26 gauge (0.159 in)

## Copper-Bonded Steel Conductor



Contact nVent ERICO for more information.

# Ground Conductors

## Theft Deterrent Composite Cable

nVent ERICO Cu-Bond is a bare concentric stranded conductor that consists of peripheral tinned copper plated steel which protects and conceals the internal copper stranding. This conductor is ideal for exposed electrical grounding applications where copper theft may occur due to its tinned outer strands. The conductor is difficult to cut with hand tools, but the

copper core makes it easier to install than other theft deterrent conductors. The outer stranding is magnetic, which further deters thieves looking for copper. The CC5A05CB (19 strand) is electrically equivalent to a 4 AWG (25 mm<sup>2</sup>), the CC5A20CB is electrically equivalent to a 2/0 AWG (70 mm<sup>2</sup>) and the CC5A40CB is electrically equivalent to a 4/0 AWG (120 mm<sup>2</sup>)

CC5A05CB

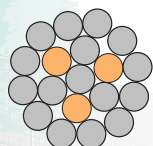

CC5A20CB

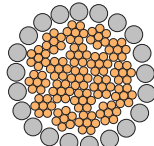

CC5A40CB

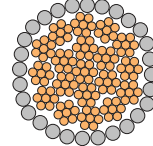

Part Number	Stranding	Resistance	Fusing Capacity Equivalency	Cable Diameter	Cable Length	Conductor Code	nVent ERICO Hammerlock	Unit Weight
CC5A05CB	(19) Strands: (3) Tinned Copper, (16) Tin Plated Copper-Bonded Steel	0.374 Ω/1000'	#4	0.320"	250'	S1	EHL58C2G, EHL34C2G	61 lb
CC5A20CB	(154) Strands: (133) Tinned Copper, (21) Tin Plated Copper-Bonded Steel	0.087 Ω/1000'	2/0	0.524"	200'	S5	–	113 lb
CC5A40CB	(161) Strands: (133) Tinned Copper, (27) Tinned Copper-Bonded Steel	0.056 Ω/1000'	4/0	0.651"	200'	S7	–	174 lb

### nVent ERICO CADWELD Connections for nVent ERICO CU-BOND Composite Cable

Part Number	nVent ERICO CU-BOND Composite Cable	nVent ERICO CADWELD Welding Material	nVent ERICO CADWELD PLUS Welding Material	nVent ERICO CADWELD Connection Type	Connects To	Handle Clamp
SSCS1	CC5A05CB	32	32PLUSF20	SS	T1 Cable	L160
SSCS5	CC5A20CB	90	90PLUSF20	SS	T2 Cable	L160
SSCS7	CC5A40CB	150	150PLUSF20	SS	T3 Cable	L160
GRC16S1	CC5A05CB	65	65PLUSF20	GR	5/8" Copper-Bonded Ground Rod	L160
GRC16S5	CC5A20CB	90	90PLUSF20	GR	5/8" Copper-Bonded Ground Rod	L160
GRC16S7	CC5A40CB	115	115PLUSF20	GR	5/8" Copper-Bonded Ground Rod	L160
GRC18S1	CC5A05CB	90	90PLUSF20	GR	3/4" Copper-Bonded Ground Rod	L160
GRC18S5	CC5A20CB	90	90PLUSF20	GR	3/4" Copper-Bonded Ground Rod	L160
GRC18S7	CC5A40CB	115	115PLUSF20	GR	3/4" Copper-Bonded Ground Rod	L160
GLCCES1	CC5A05CB	32	32PLUSF20	GL	B121CE or B122CE Lug	L160
GLCCES5	CC5A20CB	45	45PLUSF20	GL	B121CE or B122CE Lug	L160
GLCCES7	CC5A40CB	65	65PLUSF20	GL	B121DE or B122DE Lug	L160
GTC16S1	CC5A05CB	90	90PLUSF20	GT	5/8" Copper-Bonded Ground Rod	L160
GTC16S5	CC5A20CB	115	115PLUSF20	GT	5/8" Copper-Bonded Ground Rod	L160
GTC16S7	CC5A40CB	200	200PLUSF20	GT	5/8" Copper-Bonded Ground Rod	L160
GTC18S1	CC5A05CB	90	90PLUSF20	GT	3/4" Copper-Bonded Ground Rod	L160
GTC18S5	CC5A20CB	115	115PLUSF20	GT	3/4" Copper-Bonded Ground Rod	L160
GTC18S7	CC5A40CB	200	200PLUSF20	GT	3/4" Copper-Bonded Ground Rod	L160
LACS1CE	CC5A05CB	45	45PLUSF20	LA	B101CEOL or B102CEOL Lug	L160
LACS5CE	CC5A20CB	65	65PLUSF20	LA	B101CEOL or B102CEOL Lug	L160
LACS7DE	CC5A40CB	90	90PLUSF20	LA	B101DEOL or B102DEOL Lug	L160

# Ground Rod Selection



## GROUND RODS

### Ground Rod Diameter and Length

Ground rod diameter must also be considered. Although larger diameter rods are more rigid and less prone to whip or bending, they may have a greater drag than smaller diameter rods when being driven. It must also be noted that increasing the ground rod diameter has relatively small impact on grounding system resistance when compared to length. Standards nominate a minimum diameter or periphery and thickness if not cylindrical, mainly based on mechanical strength.



In general, lightning protection standards recommend copper-bonded electrodes of specified diameter. Standard UL 467 requires a minimum rod length of 8' with a minimum diameter of 0.50" and 10 mils of copper.

Other standards may nominate a specific resistance for the installation. If space is limited, the contractor may be required to install electrodes to a depth that achieves the required value.

## GROUND ELECTRODES

### Ground Rod Accessories and Application

nVent ERICO, a leading manufacturer of UL® listed copper-bonded ground rods, offers a complete range of rods, driving sleeves and studs, rod coupling methods and connections for reliable grounding in nearly any application.

## DRIVING SLEEVES

The driving sleeve fits over the pointed ground rod to protect the rod end from "mushrooming" as the ground rod is driven into earth.



## COMPRESSION COUPLING

Couplings enable ground rods to be driven quickly and easily without the risk of rod separation. They are generally tapered so when the rod is driven into the coupling, the two parts compress to form a conductive connection.



## THREADED COUPLING

Threaded couplings allow for full contact of the rod point with the butt end of the preceding rod.

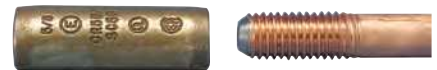

# Ground Rod Selection

## Ground Electrodes

The ground electrode is a critical component of the grounding system. Many different types of electrodes are available, some “natural” and some “made”. The natural types include metal underground water pipe, the metal frame of a building (if effectively grounded), a copper wire or reinforcing bar in a concrete foundation or underground structures or systems. Consideration should be given to bonding of natural earths to ensure electrical continuity with a facility’s other “earths”.

“Made” electrodes are specifically installed to improve the system grounding or earthing. These earth electrodes must ideally penetrate into the moisture level below the ground level to reduce resistance. They must also consist of metal conductors (or a combination of metal conductor types), which do not corrode excessively for the period of time they are expected to serve. Made electrodes include rods or pipes driven into the earth, metallic plates buried in the earth or a copper wire ring encircling the structure. Underground gas piping or aluminum electrodes are NOT permitted for use as ground electrodes.

## Ground Rods - Which ground rod should be used?

Ground rods are often selected on the basis of their resistance to corrosion. The other major factor is cost. All too often, the cost of a product is seen as the initial up front price, but the real cost is determined by the serviceable life of the ground rod.

Galvanized steel rods are one of the cheapest electrodes available. However, they are not the most cost effective since they have a relatively short service life. Solid copper and stainless steel rods have a long service life. However, they are considerably more expensive than galvanized steel rods. In addition to this, solid copper rods are not suited to deep driving or even driving short lengths into hard ground, without bending.

Ask for the nVent ERICO White Paper on Ground Rods – Copper-bonded vs. Galvanized.

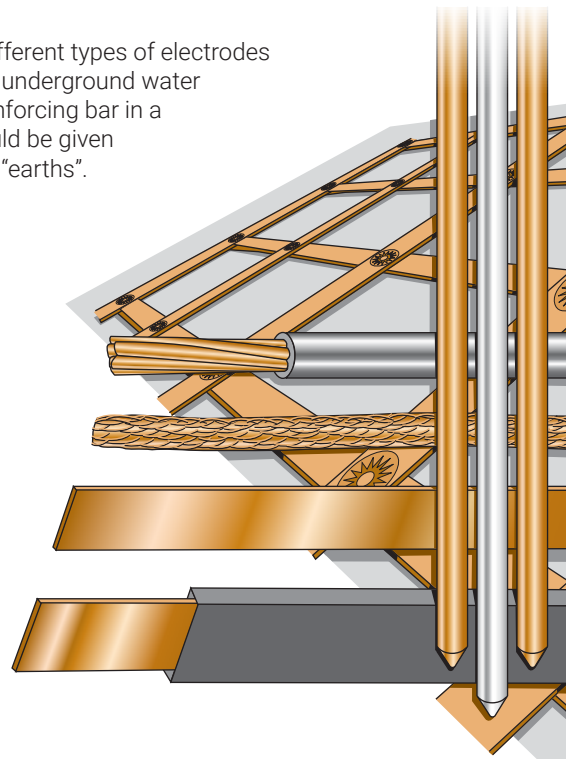

The photo shows two ground rods subjected to the same pressure load test. The nVent ERICO copper-bonded ground rod, shown on the left, will bend without tears, cracks or folds, to the outer sheath. The inferior copperclad rod shown on the right, has developed cracks and creases to the outer sheath, which will significantly reduce its serviceable life and put the integrity of the entire electrode at risk.

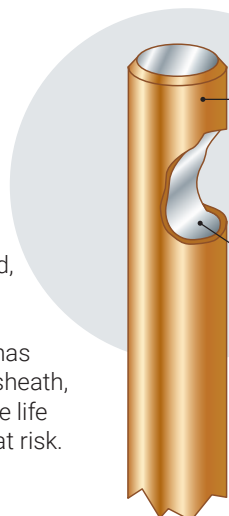

Copper-Bonded Ground Rod	Galvanized Ground Rod
<ul style="list-style-type: none"> <li>• <b>Cost-effective long service life</b></li> </ul>	<ul style="list-style-type: none"> <li>• <b>Lower purchase price – not as cost-effective over the expected life as Copper-bonded</b></li> </ul>
<p><b>Copper-bonded coating:</b></p> <ul style="list-style-type: none"> <li>• Permanent molecular bond</li> <li>• Low resistance performance</li> <li>• High fault current capacity (IEEE® Std 80)                             <ul style="list-style-type: none"> <li>• Will not slip or tear when driven</li> <li>• Will not crack if rod is bent</li> </ul> </li> <li>• Copper coating may vary to meet required standards</li> <li>• 10 mil (254 micron) minimum coating on rods listed to UL® 467</li> </ul>	<p><b>Galvanized coating:</b></p> <ul style="list-style-type: none"> <li>• Relatively short service life</li> <li>• May crack if rod is bent</li> </ul>
<p><b>Carbon Steel core and tip*:</b></p> <ul style="list-style-type: none"> <li>• Greater tensile strength</li> <li>• Deep driving capability</li> </ul>	<p><b>3.9 mil (99 micron) minimum coating per ASTM® 123</b></p>
<p><small>* nVent ERICO copper-bonded and galvanized rods</small></p>	

# Ground Rod Selection



## Copper-Bonded Ground Rod

The copper-bonded ground rod has an electrolytic coating of copper deposited over a layer of nickel. This process ensures a long lasting, molecular bond between the copper layer and the steel core. nVent ERICO recommends copper-bonded ground rods because the copper coating will not slip or tear when driven, nor will it crack if the rod is bent. The tough, carbon steel core has good characteristics for deep driving. Copper-bonded ground rods have a high resistance to corrosion and provide a low resistance path to ground.

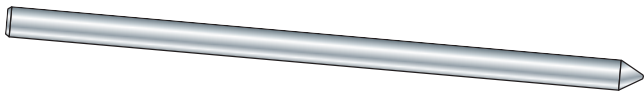

## The Stainless Steel Ground Rod Option

It is important to note that certain soils and land fill areas may not be compatible with copper. In these situations, stainless steel is a better proposition. Stainless steel may also be an alternative, where structures or components, such as steel towers, poles or lead sheathed cables are in close proximity to an array of ground electrodes. In these circumstances, consideration must be given to the consequence of galvanic corrosion. The high cost of stainless steel rods prohibits their widespread use.

## NEGRP

The photo on the left shows two ground rods that were driven into the soil vertically at the Pecos testing site in Las Vegas, NV in December of 1992. The top ground rod is galvanized steel, 3/4" x 10'. Bottom ground rod is copper-bonded, 5/8" x 8'. Both ground rods were exhumed from the site in April of 2004. The loss of zinc resulted in excessive corrosion of the steel. The copper-bonded steel ground rods showed minimal corrosion.



Excavated after 12 years.



Excavated after 11 years.

The photo on the right shows a galvanized steel ground rod driven vertically into the ground at the Pawnee testing site in Las Vegas, NV. One area is reduced from a 3/4" diameter to approximately a 1/4" diameter due to extensive corrosion. The eventual failure would result in a potentially catastrophic loss of ground.

## Ground Rod Life Expectancy

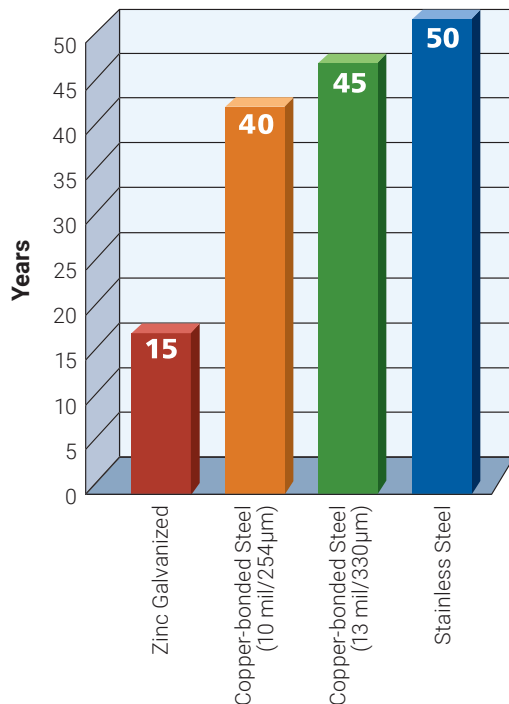

## Ground Rod Annual Cost

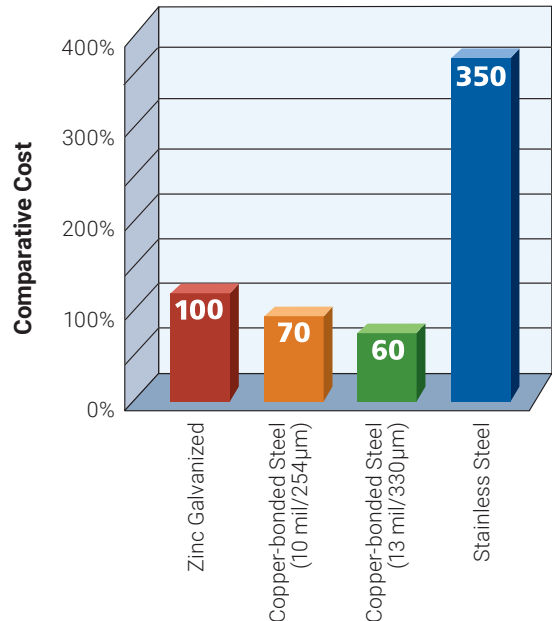

# Copper-Bonded Ground Rods

## POINTED RODS

- 99.9% pure electrolytic copper coating
- Molecular bond to nickel-sealed high strength steel core
- Rods have a high carbon steel core and tip that provide superior strength when driving
- Copper coating will not crack when bent or tear when driven
- Minimum copper coating of 10 mils on rods listed to UL® 467
- nVent ERICO name, length, diameter and part number is roll-stamped within 12" of chamfered end
- UL logo and control number where applicable stamped on each rod for easy inspection after installation

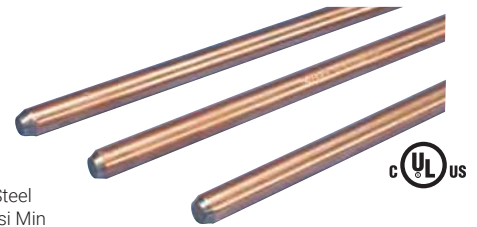

Material: Copper-Bonded Steel  
Tensile Strength: 80,000 psi Min

Part Number	Ground Rod Diameter, Nominal	Ground Rod Diameter, Actual (Ø)	Length	Plating Thickness	Unit Weight
613840**	3/8"	0.358"	4.0'	10 mil	1,300 lb
611350**	1/2"	0.505"	5.0'	10 mil	3,500 lb
611380	1/2"	0.505"	8.0'	10 mil	5,500 lb
611300	1/2"	0.505"	10.0'	10 mil	6,900 lb
615840**	5/8"	0.560"	4.0'	10 mil	3,400 lb
615850**	5/8"	0.560"	5.0'	10 mil	4,200 lb
615860**	5/8"	0.560"	6.0'	10 mil	5,100 lb
615880	5/8"	0.560"	8.0'	10 mil	6,800 lb

Part Number	Ground Rod Diameter, Nominal	Ground Rod Diameter, Actual (Ø)	Length	Plating Thickness	Unit Weight
615800	5/8"	0.560"	10.0'	10 mil	8,500 lb
615812	5/8"	0.560"	12.0'	10 mil	10,000 lb
615815	5/8"	0.560"	15.0'	10 mil	12,800 lb
615883	5/8"	0.561"	8.0'	13 mil	6,800 lb
615803	5/8"	0.561"	10.0'	13 mil	8,400 lb
613440**	3/4"	0.681"	4.0'	10 mil	5,600 lb
613480	3/4"	0.681"	8.0'	10 mil	10,100 lb
613400	3/4"	0.681"	10.0'	10 mil	12,600 lb
613403	3/4"	0.681"	10.0'	13 mil	12,400 lb
613412	3/4"	0.681"	12.0'	10 mil	14,900 lb
613415	3/4"	0.681"	15.0'	10 mil	18,500 lb
614400	1"	0.911"	10.0'	10 mil	22,000 lb

\*\* Non-UL listed rods  
† Additional lengths available

## STEEL DRIVING SLEEVES FOR POINTED RODS\*

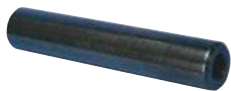

- Slides on top of ground rod to prevent mushrooming while driving into ground

Part Number	Ground Rod Size (Unthreaded)
B13714	1/2" Copper-Bonded or Steel rod
B13716	5/8" Copper-Bonded rod (.563" diameter)
B13731	5/8" Steel rod (.625" diameter)
B13718	3/4" Copper-Bonded rod (.682" diameter)
B13733	3/4" Steel rod (.750" diameter)
B13722	1" Copper-Bonded rod (.914" diameter)

\*For unthreaded ground rods only.

## ECONOMICAL SLEEVES FOR 5/8" COPPER-BONDED, POINTED RODS



Part Number	Ground Rod Size
EDS58	5/8" Copper-Bonded Rods (.563" diameter)

## DRIVING HEADS FOR COPPER-BONDED POINTED RODS



- For use in power assisted ground rod drivers

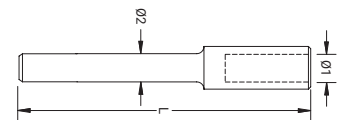

Part Number	Ground Rod Size	Ø1	Ø2	L
DH58	5/8" Copper-Bonded Rods (.563" diameter)	0.58"	0.85"	7"
DH34	3/4" Copper-Bonded Rods (.682" diameter)	0.78"	0.85"	7"

## THREADLESS COMPRESSION COUPLERS FOR COPPER-BONDED POINTED RODS



- Made of high-strength silicon bronze
- Tapered so when rod is driven into coupling, parts compress to form a conductive connection



Part Number	Nominal Rod Diameter (in)	Unit Weight (lbs)	Standard Package
CC12F	1/2 (full)	0.240	25
CC58	5/8	0.300	25
CC34	3/4	0.450	25

# Ground Rods and Couplers

## COPPER-BONDED GROUND RODS

### Sectional, Threaded Rods



- Cold-rolled threads with continuous, unbroken grain flows preserve copper coating and are stronger than cut threads
- 99.9% pure electrolytic copper coating
- Molecular bond to nickel-sealed high strength steel core

- Rods have a high carbon steel core and tip that provide superior strength when driving
- Copper coating will not crack when bent or tear when driven
- Minimum copper coating of 10 mils on rods listed to UL® 467
- nVent ERICO name, length, diameter and part number is roll-stamped within 12" of chamfered end
- UL logo and control number where applicable stamped on each rod for easy inspection after installation

Part Number	Ground Rod Diameter, Nominal	Ground Rod Diameter, Actual(Ø)	Thread Size TS	Length L	Plating Thickness	Unit Weight
631380	1/2"	0.504"	9/16 UNC	8.0'	10 mil	5.400 lb
631300	1/2"	0.504"	9/16 UNC	10.0'	10 mil	6.900 lb
635830	5/8"	0.560"	5/8 UNC	3.0'	10 mil	2.600 lb
635850	5/8"	0.560"	5/8 UNC	5.0'	10 mil	4.200 lb
635860	5/8"	0.560"	5/8 UNC	6.0'	10 mil	5.000 lb
635880	5/8"	0.560"	5/8 UNC	8.0'	10 mil	6.700 lb
635800	5/8"	0.560"	5/8 UNC	10.0'	10 mil	8.400 lb
635883	5/8"	0.561"	5/8 UNC	8.0'	13 mil	6.700 lb
635803	5/8"	0.561"	5/8 UNC	10.0'	13 mil	8.500 lb
633430	3/4"	0.680"	3/4 UNC	3.0'	10 mil	3.800 lb
633480	3/4"	0.680"	3/4 UNC	8.0'	10 mil	9.600 lb
633400	3/4"	0.680"	3/4 UNC	10.0'	10 mil	12.500 lb
633463	3/4"	0.681"	3/4 UNC	6.0'	13 mil	7.100 lb
634400	1"	0.912"	1 UNC	10.0'	10 mil	22.100 lb

For rods to be listed to UL® 467, they must be at least 8' (2.44 m) in length.

## DRIVING STUD FOR THREADED RODS



Part Number	Ground Rod Diameter, Nominal	Thread Size TS
DS12S	1/2"	9/16 UNC
DS58	5/8"	5/8 UNC
DS34	3/4"	3/4 UNC
DS1	1"	1 UNC

## COUPLERS FOR THREADED RODS



- High-strength couplings are threaded bronze and chamfered at both ends for easy driving
- Corrosion-resistant couplings ensure permanent, low-resistance copper-to-copper connections
- UL® & CSA® Listed

Part Number	Nominal Rod Diameter (in)	Standard Package
CR12S	1/2 (full)	25
CR58	5/8	25
CR34	3/4	25
CR100	1	10

## COUPLERS FOR THREADED STAINLESS STEEL GROUND RODS

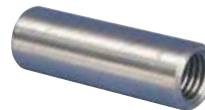

- Corrosion-resistant couplings ensure permanent, low-resistance connections between ground rods

Material: Stainless Steel 304 (EN 1.4301)



Part Number	Rod Diameter (in)	Stainless Steel Type
CR58SS	5/8 (full)	304
CR34SS	3/4 (full)	304

## COMPRESSION COUPLERS FOR THREADLESS STAINLESS STEEL GROUND RODS

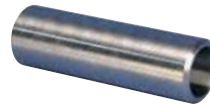

Part Number	Rod Diameter (in)	Stainless Steel Type
CC58SS	5/8 (full)	304
CC34SS	3/4 (full)	304

## GALVANIZED STEEL COMPRESSION COUPLER



Part Number	Rod Diameter (in)
GCC58F	5/8 (full)
GCC34	3/4 (.727-.738)



# Ground Rods and Couplers



## GALVANIZED POINTED GROUND RODS

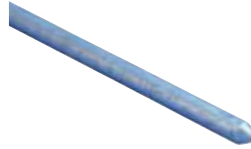

- Meets ANSI®/NEMA® GR1
- Zinc-coated exteriors are hot-dip galvanized for solid protection against corrosion, in accordance with ASTM® specification A123
- Surfaces are rigidly inspected to eliminate seams, slivers and other defects

## GROUND ROD DRIVER

- Usable on all types of round ground rods: copper-bonded, galvanized, stainless steel
- 5/8" and 3/4" inserts are interchangeable with standard driver body
- The driver will not deform the end of the rod, making connection of the ground conductor quick and easy

Part Number	Description	Weight (lbs)
EGRD58	5' Driver body with insert for up to 5/8" ground rods	23
EGRD58   *	Replacement insert for 5/8" copper-bonded ground rods	6
EGRD34	5' Driver body with insert for up to 3/4" ground rods	23
EGRD34   *	Replacement insert for 3/4" copper-bonded ground rods and 5/8" galvanized ground rods	6

\*Both 5/8" and 3/4" inserts fit standard driver body.

## STAINLESS STEEL GROUND RODS



- Sectional rods utilize a cut thread for highly corrosive soil

Part Number	Actual Diameter (in)	Ground Rod Diameter, Actual (Ø)	Length (ft)	Stainless Steel Type	Standard Bundle
<b>Rod Type: Pointed</b>					
681300	1/2	0.500"	10	302 - 304	5
683400	3/4	0.750"	10	302 - 304	5
683450	3/4	0.750"	5	302 - 304	5
683480	3/4	0.750"	8	302 - 304	5
685800	5/8	0.625"	10	302 - 304	5
685880	5/8	0.625"	8	302 - 304	5
<b>Rod Type: Sectional</b>					
681300S	1/2		10	302 - 304	5
683400S	3/4		10	302 - 304	5
683450S	3/4		5	302 - 304	5
685800S	5/8		10	302 - 304	5
685880S	5/8		8	302 - 304	5

## CONVENIENT GROUND ELECTRODE (CGE) KITS

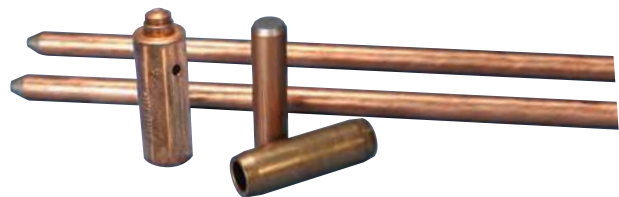

- The UL®-Listed, NEC®-Compliant Eritech CGE kit allows for installation from ground level and is much easier to transport than eight-foot ground rods.
- The nVent ERICO CGE kits are designed for #6 and #4 solid copper conductor applications.

Material: Copper-Bonded Steel; Bronze



Part Number	nVent ERICO Ground Rods	Clamp	nVent ERICO Drive Sleeve	Conductor Size
CGE5CP	615840	CP58	EDS58	#8 Solid - #2 Stranded, 10 mm² Solid - 35 mm² Stranded

# Ground Clamps and Connectors



Hammerlock is machined from highly conductive copper.



It is easy to see why acorn clamps are more susceptible to corrosion than any other type of grounding connection.

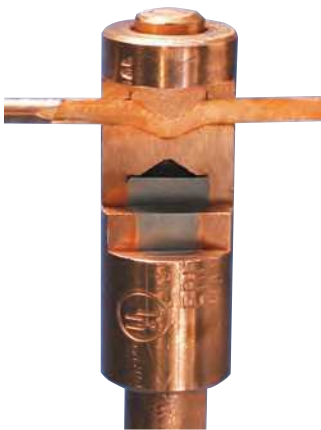

Hammerlock cutaway.

## HIGH QUALITY CONNECTIONS

The patented nVent ERICO Hammerlock grounding connector from nVent ERICO connects the grounding conductor to the ground rod. Machined from highly conductive copper, the state-of-the-art Hammerlock provides a low-resistance connection designed to withstand ground fault currents and lightning transients. The Hammerlock connector's mechanically rugged design will help ensure that the highest level of performance is maintained for many years after the connection has been buried in the harsh underground environment. The Hammerlock is one of the quickest and easiest grounding connectors to install and requires no special tools or training. It has been engineered to be user-friendly, cost-effective, and provides a high level of protection for people and expensive equipment.

### Features Include:

- Machined from 100% high-conductivity copper
- Excellent mechanical strength
- Irreversible connection
- Fast and simple installation requires only a hammer
- No training required
- Provides a visual indication of completed connection
- Allows for "T" or pass-through connections
- UL® Listed (#2, 4 and 6 solid to 5/8" copper or galvanized rod)

### The Importance of Grounding Connections

Electrical utilities and other industries are discovering significant cost benefits when high-quality electrical grounding systems are installed. Many are specifying low-resistance grounds along their transmission and distribution networks. These low-resistance electrodes limit neutral-to-ground voltage, improve safety and provide better protection against lightning damage. In fact, the savings realized from reduced equipment damage and the decrease in service interruptions have prompted many utilities to undertake large-scale grounding improvement programs.

The three main components of the grounding system are the grounding connector, grounding conductor and ground rod. They are all equally important to the performance of the system. A loose or corroded connection will render the grounding system ineffective. While acorn clamps are still the connector of choice, many installers recognize the serious deficiency in their performance and the risks associated with poor-quality connections. Many acorn clamps are loose the day they are installed.

In order to install an acorn clamp effectively, it is necessary to know the proper torque level for the bolt. Since acorn clamps don't come with instructions and most crews don't have or wouldn't use a torque wrench, many are broken or installed incorrectly. The cost of replacing damaged equipment, and the labor associated with doing so, quickly puts the cost of using inferior connectors into perspective.

### Installation Costs

The actual cost of the grounding connector represents only a small fraction of the total installed expense when the labor rate of the installation crew, equipment overhead costs, ground rod and conductor costs are considered. Installation costs increase significantly when deep-driven rods are used — a common practice in grounding improvement programs.

Therefore, investing in the best-performing, longest-lasting grounding connector is a wise choice. Initially paying more for a quality connector will actually save money in the long run, by reducing downtime and eliminating the need for crews to return to the site for repairs.

# Ground Clamps and Connectors

## Hammerlock Is The Answer!

Acorn clamps are utilized because they are inexpensive. They were developed before the proliferation of expensive electronics, at a time when the demand for electric power was lower and before power quality was a serious consideration. The Hammerlock, on the other hand, was designed to meet the needs of today's modern grounding programs. Therefore, an upgraded or perhaps more aptly stated, updated, grounding program specification should require a quality connector and exclude the acorn clamp.

## How the Hammerlock works



The ground wire is placed through the connector body and then the body is placed on the top of the ground rod. As the connector is struck with a hammer, Hammerlock is connected to the ground rod using the same compression technology used in the nVent ERICO threadless couplers that connect deep-driven rods together.

At the same time, the ground wire is locked in place as the connector plug enters the body.

## Ease of Installation

Installing the Hammerlock is as easy as swinging a hammer. Its intuitive design requires no special tools or training. When the large diameter on the Hammerlock plug is flush or below the round body, the connection is complete and irreversible. The Hammerlock can be installed three to five times faster than an acorn clamp and is easier to install in a trench.

The Hammerlock provides a high-quality grounding connection that is easy to use and cost-effective — withstanding 100% of the current carrying capacity of the conductor. Given the important function of today's grounding system, the Hammerlock provides excellent connector value.

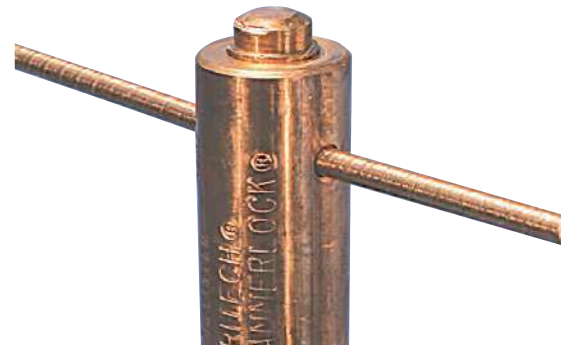

## Hammerlock Specification

Cable to ground rod connectors shall be made from a round, high conductivity copper alloy bar stock, with a minimum of 90% IACS. The connector shall provide a high quality, irreversible, compression connection area for the conductor and a taper fit compression connection area for the ground rod. The connector shall be able to withstand 100% of the current carrying capacity of the conductor. The connector shall not rely on bolts or screws to maintain the integrity of the connection. Each connector shall be clearly marked with the catalog number and clear description of the conductor and ground rod to be connected and packaged with installation instructions.

A hammer shall be required for the connector installation. The connector shall provide a positive visual means of verifying a successfully completed connection. The connector shall be the Hammerlock as manufactured by nVent ERICO or approved equal. Silicon bronze connectors are not acceptable.

# Ground Clamps and Connectors



## NVENT ERICO HAMMERLOCK

- Low resistance connection
- Irreversible connection with excellent mechanical strength
- Fast and simple installation
- cULus Listed



Material: Copper

Part Number	Ground Rod Diameter, Nominal	Ground Rod Diameter, Actual Ø	Conductor Size	Number of Conductors	Certifications
<b>Ground Rod Type: Copper-bonded</b>					
EHL12FC1K	1/2"	0.50"	#6 Solid - #4 Solid, 16 mm <sup>2</sup> Stranded	1	cULus
EHL12FC1V	1/2"	0.50"	#4 Stranded - #2 Stranded, 25 mm <sup>2</sup> Stranded	1	cULus
EHL12FC2G	1/2"	0.50"	1/0 Stranded - 2/0 Stranded	1	cULus
EHL58C1K	5/8"	0.56"	#6 Solid - #4 Solid, 16 mm <sup>2</sup> Stranded	1	cULus
EHL58C1V	5/8"	0.56"	#4 Stranded - #2 Stranded, 25 mm <sup>2</sup> Stranded	1	cULus
EHL58C1V1V	5/8"	0.56"	#2 Solid - #2 Stranded	2	-
EHL58C2G	5/8"	0.56"	1/0 Stranded - 2/0 Stranded	1	cULus
EHL58C2Q	5/8"	0.56"	3/0 Stranded - 4/0 Stranded	1	cULus
EHL34C1K	3/4"	0.68"	#6 Solid - #4 Solid, 16 mm <sup>2</sup> Stranded	1	cULus
EHL34C1V	3/4"	0.68"	#4 Stranded - #2 Stranded, 25 mm <sup>2</sup> Stranded	1	cULus
EHL34C2G	3/4"	0.68"	1/0 Stranded - 2/0 Stranded	1	cULus
EHL34C2Q	3/4"	0.68"	3/0 Stranded - 4/0 Stranded	1	cULus
<b>Ground Rod Type: Galvanized</b>					
EHL58G1K	5/8"	0.63"	#6 Solid - #4 Solid, 16 mm <sup>2</sup> Stranded	1	cULus
EHL58G1V	5/8"	0.63"	#4 Stranded - #2 Stranded, 25 mm <sup>2</sup> Stranded	1	cULus
EHL58G2G	5/8"	0.63"	1/0 Stranded - 2/0 Stranded, #2 Solid	1	cULus
EHL34G1K	3/4"	0.73"	#6 Solid - #4 Solid, 16 mm <sup>2</sup> Stranded, #2 Solid	1	cULus
EHL34G1V	3/4"	0.73"	#4 Stranded - #2 Stranded, 25 mm <sup>2</sup> Stranded, #2 Solid	1	cULus

## NVENT ERICO HAMMERLOCK FOR 2 CONDUCTORS



Part Number	Ground Rod Diameter, Nominal	Ground Rod Diameter, Actual Ø	Conductor Size	Number of Conductors	Certifications
<b>Ground Rod Type: Copper-bonded</b>					
EHL12FC1K1K	1/2"	0.50"	#6 Solid - #4 Solid, 16 mm <sup>2</sup> Stranded	2	-
EHL58C1K1K	5/8"	0.56"	#6 Solid - #4 Solid, 16 mm <sup>2</sup> Stranded	2	-
<b>Ground Rod Type: Galvanized</b>					
EHL58G1K1K	5/8"	0.63"	#6 Solid - #4 Solid, 16 mm <sup>2</sup> Stranded	2	-

## BRONZE GROUND ROD CLAMPS

- High-strength silicon bronze
- For use with copper-bonded ground rods
- Suitable for direct burial
- UL Listed for direct burial in earth or concrete
- CSA Listed



Part Number	Ground Rod Diameter, Nominal	Ground Rod Diameter, Actual Ø	Conductor Size	Wrench Size	Complies With	Torque TQ	Certifications
CP38	3/8"	0.38"	#10 Solid - #2 Stranded, 6 mm <sup>2</sup> Solid - 25 mm <sup>2</sup> Stranded	3/8"	-	150 in lb	UL
HDC12	1/2"	0.50"	#10 Solid - #2 Stranded, 6 mm <sup>2</sup> Solid - 25 mm <sup>2</sup> Stranded	1/2"	-	150 in lb	CSA, cULus
CP58	1/2" - 5/8"	0.50" - 0.56"	#10 Solid - #2 Stranded, 6 mm <sup>2</sup> Solid - 25 mm <sup>2</sup> Stranded	1/2"	IEC® EN 62561-1	150 in lb	CSA, cULus
HDC58R	5/8"	0.56"	#8 Solid - 1/0 Stranded, 10 mm <sup>2</sup> Solid - 50 mm <sup>2</sup> Stranded	1/2"	-	150 in lb	CSA, cULus
HDC58	5/8"	0.56"	#8 Solid - 1/0 Stranded, 10 mm <sup>2</sup> Solid - 50 mm <sup>2</sup> Stranded	9/16"	-	150 in lb	CSA, cULus
HDC34	3/4"	0.68"	#8 Solid - 1/0 Stranded, 10 mm <sup>2</sup> Solid - 50 mm <sup>2</sup> Stranded	9/16"	-	150 in lb	CSA, cULus
HDC34SP	3/4"	0.68"	#8 Solid - 3/0 Stranded, 10 mm <sup>2</sup> Solid - 70 mm <sup>2</sup> Stranded	9/16"	-	200 in lb	CSA
HDC1	1"	1.00"	#8 Solid - 4/0 Stranded, 10 mm <sup>2</sup> Solid - 95 mm <sup>2</sup> Stranded	9/16"	-	200 in lb	cULus
CP34	1/2" - 3/4"	0.50" - 0.68"	#10 Solid - 1/0 Stranded, 6 mm <sup>2</sup> Solid - 50 mm <sup>2</sup> Stranded	1/2"	IEC® EN 62561-1	150 in lb	CSA, cULus

# Ground Clamps and Connectors

## SP58 STAINLESS STEEL GROUND CLAMP



- Unique stamped body design will not crack with excessive torque values
- Provides a greater surface area contact to allow improved performance of the connector
- Compatible with copper, copper-bonded, galvanized, stainless steel, rebar and plain steel ground rods and electrodes
- cULus® Listed; RUS Approved

Part Number	Rod Diameter (in)	Conductor Range (AWG)	Minimum Torque	Rebar Size
SP58*	1/2, 5/8	10 solid – 2 stranded	300 in – lbs	#4
SP58 B916 <sup>A</sup>	1/2, 5/8	10 solid – 2 stranded	300 in – lbs	#4

\* With 9/16" bolt head

<sup>A</sup> UL Listed for direct burial in earth or concrete.

## TINNED BRONZE GROUND CLAMPS



- Made of high copper-content alloy
- Theft-deterrent appearance
- Stainless steel nuts, bolts and washer included
- For use on 5/8" - 3/4" rods

Part Number	Conductor Range (AWG)	Standard Package
GC064	4 Solid - 2/0 Stranded	50
GC065	2/0 Solid - 250 MCM Stranded	50

## DIRECT BURIAL GROUND CLAMPS



- Universal use for rebar, rods or pipes
- Lay-in feature cuts installation time
- Bronze alloy construction with bronze screws
- Approved for direct burial in earth and concrete
- cULus Listed

EK16: Parallel connection

Part Number	Conductor Range (AWG)	Conductor Range (metric)	Rebar Size (imperial)	Rebar Size (metric)
EK16	10 solid - 2 solid	5.5 mm <sup>2</sup> – 25 mm <sup>2</sup>	#4 – #8	10 – 25 mm

## REBAR GROUNDING CLAMP, PERPENDICULAR



- Universal use for rebar, rods or pipes
- Lay-in feature cuts installation time
- Bronze alloy construction with Stainless Steel 304 screws
- Approved for direct burial in earth and concrete

Part Number	Ground Rod Diameter, Actual Ø	Water Pipe Size Ø	Rebar Size, Metric	Rebar Size, US	Rebar Size, Canada
EK17	0.5" – 1.0"	1/2" – 1"	12 – 25 mm	#4 – #8	10M – 25M

## SPLIT BOLTS



Silicon Bronze



Tin-Plated Silicon Bronze

- High strength
- Silicon bronze for copper to copper connections.
- Tin plated, high strength copper alloy split bolt with spacer separates dissimilar conductors which allow you to connect: copper to copper; copper to aluminum; aluminum to aluminum. (Oxide inhibitor recommended when used on aluminum conductor.)
- UL® Listed

Part Number	Conductor Size	Torque TQ	Certifications
<b>Silicon Bronze</b>			
ESB8	#16 Stranded - #8 Stranded, 1.5 mm <sup>2</sup> Stranded - 6 mm <sup>2</sup> Stranded	165 in lb	cULus
ESB6	#10 Solid - #6 Stranded, 6 mm <sup>2</sup> Stranded - 10 mm <sup>2</sup> Stranded	165 in lb	cULus
ESB4	#8 Solid - #4 Solid, 10 mm <sup>2</sup> Stranded - 16 mm <sup>2</sup> Stranded	165 in lb	cULus
ESB2	#6 Solid - #2 Stranded, 16 mm <sup>2</sup> Stranded - 25 mm <sup>2</sup> Stranded	275 in lb	cULus
ESB2/0	#2 Solid - 2/0 Stranded, 35 mm <sup>2</sup> Stranded - 50 mm <sup>2</sup> Stranded	385 in lb	UL
ESB4/0	1/0 Solid - 250 kcmil Stranded, 70 mm <sup>2</sup> Stranded - 120 mm <sup>2</sup> Stranded	650 in lb	–
<b>Tin-Plated Silicon Bronze</b>			
ESBP8	#14 Stranded - #8 Stranded, 2.5 mm <sup>2</sup> Stranded - 6 mm <sup>2</sup> Stranded	165 in lb	UL
ESBP6	#10 Stranded - #6 Stranded, 6 mm <sup>2</sup> Stranded - 10 mm <sup>2</sup> Stranded	165 in lb	UL
ESBP2	#8 Solid - #2 Stranded, 10 mm <sup>2</sup> Stranded - 25 mm <sup>2</sup> Stranded	275 in lb	UL
ESBP2/0	#8 Solid - 2/0 Stranded, 10 mm <sup>2</sup> Stranded - 50 mm <sup>2</sup> Stranded	385 in lb	UL
ESBP1/0	#6 Solid - 1/0 Stranded, 16 mm <sup>2</sup> Stranded - 50 mm <sup>2</sup> Stranded	385 in lb	UL
ESBP4/0	#4 Stranded - 250 kcmil Stranded, 25 mm <sup>2</sup> Stranded - 120 mm <sup>2</sup> Stranded	650 in lb	–
ESBP350	3/0 Stranded - 350 kcmil Stranded, 95 mm <sup>2</sup> Stranded - 150 mm <sup>2</sup> Stranded	650 in lb	–

Oxide inhibitor recommended when used on aluminum conductor.

# Ground Clamps and Connectors

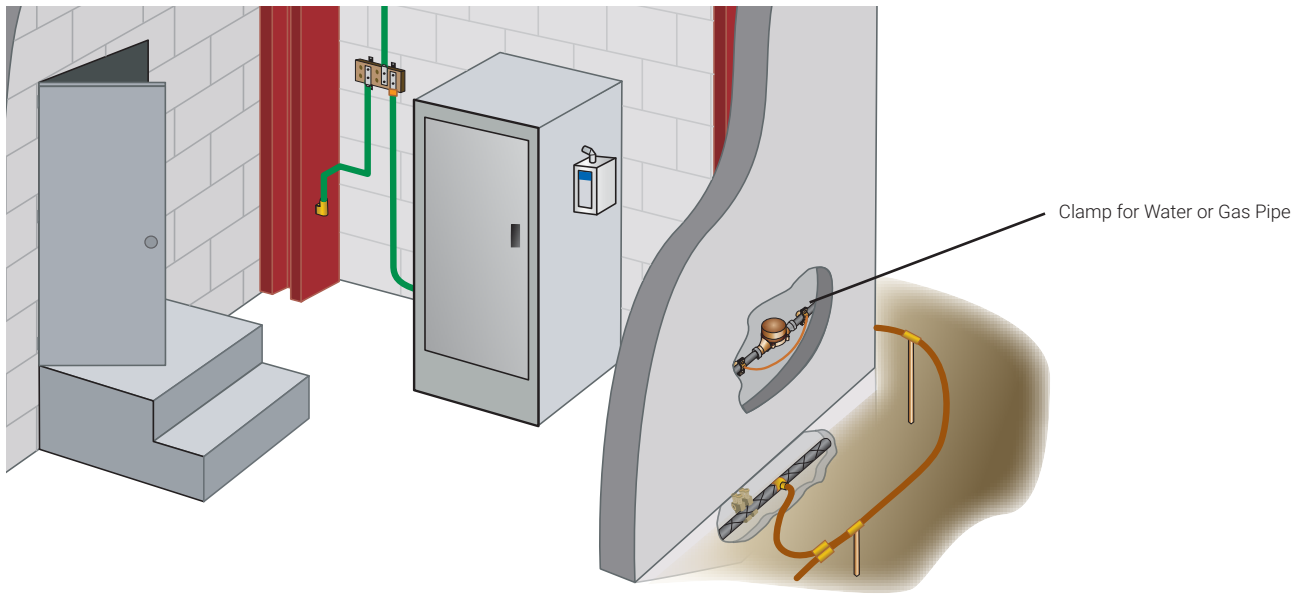

## BRONZE CLAMPS FOR WATER OR GAS PIPE (INCLUDING BRASS HEX FITTINGS)

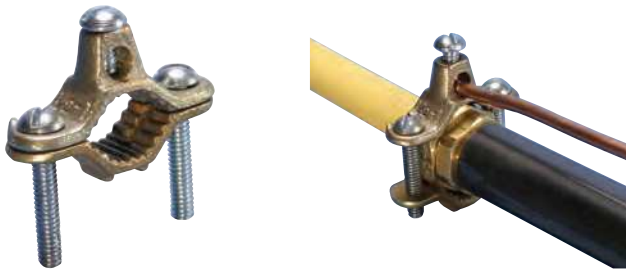

- High-strength silicone bronze
- Used for connecting copper conductors to metallic water pipe, ground rods, or flexible gas pipe (CSST) with brass hex fittings
- Conform to the requirements of the 2009 edition of NFPA® 54, NFGC® (National Fuel Gas Code) and NEC® (National Electric Code) for bonding corrugated stainless steel tubing (CSST) gas piping systems to the grounding conductor of the building's electrical system
- SH version for outdoor applications
- cULus Listed

## BRONZE CLAMPS FOR WATER PIPE



CWP1JU\*

CWP2JU\*

- High-strength silicone bronze
- Used for connecting copper conductors to metallic water pipe or ground rods
- CSA® Listed

Part Number	Water Pipe Size (in)	Conductor Range (AWG)
CWP1JJ†	.5 – 1	10 solid – 4 stranded
CWP1JU**	.5 – 1	10 solid – 2 stranded
CWP2JU**	1.25 – 2	10 solid – 2 stranded
CWP6J	4.25 – 6	10 solid – 4 stranded
CWP4J**	2.5 – 4	10 solid – 4 stranded

\* With copper screw for use in direct burial applications

\*\* UL® Listed

† Not CSA Listed

Part Number	Water Pipe Size (in)	Conductor Range (AWG)	Hex Nut Size (in)
CWP1J	.5 – 1	10 solid – 2 solid	1 – 1.25
CWP2J	1.25 – 2	10 solid – 2 stranded	1.5 – 2.125
CWP3J	2.5 – 4	10 solid – 4 stranded	2.5 – 3.125
CWP1JSH	.5 – 1	10 solid – 2 solid	1 – 1.25
CWP2JSH	1.25 – 2	10 solid – 2 stranded	1.5 – 2.125
CWP3JSH	2.5 – 4	10 solid – 4 stranded	2.5 – 3.125

Note CWP1J and CWP2J are CSA Listed.

## ZINC CLAMP FOR WATER PIPE



- Zinc die cast
- cULus Listed

Part Number	Water Pipe Size (in)	Conductor Range (AWG)
ZWP1J	.5 – 1	10 solid – 6 solid

# Ground Clamps and Connectors



## BRONZE PIPE CLAMP TO RIGID CONDUIT



- For use in grounding rigid conduit systems to metallic water pipe

Part Number	Water Pipe Size (in)	Conductor Range (AWG)	Conduit Size (in)
CWP1JH12	.5 - 1	10 solid - 6 solid	.5
CWP1JH34	.5 - 1	10 solid - 2/0 stranded	.75
CWP2JH34	1.25 - 2	10 solid - 2/0 stranded	.75
CWP4JH34	2.5 - 4	10 solid - 2/0 stranded	.75
CWP2JH44	1.25 - 2	10 solid - 3/0 stranded	1

## TINNED BRONZE FENCE CLAMPS



- Made from high copper-content alloy
- Theft-deterrent appearance
- Stainless steel nuts, bolts and washers included

Part Number	Pipe Size (in)	Conductor Size (AWG)
<b>Single Hole</b>		
FC073	1-1/2	4 Solid - 2/0 Stranded
FC074	1-1/2	2/0 Solid - 250 MCM Stranded
FC075	2	4 Solid - 2/0 Stranded
FC076	2	2/0 Solid - 250 MCM Stranded
FC078	2-1/2	2/0 Solid - 250 MCM Stranded
FC079	3	4 Solid - 2/0 Stranded
FC080	3	2/0 Solid - 250 MCM Stranded
FC082	3-1/2	2/0 solid - 250 komil Stranded
<b>Dual Hole</b>		
FC076 DH	2	2 x 2/0 Solid - 250 MCM Stranded
FC078 DH	2-1/2	2 x 2/0 Solid - 250 MCM Stranded
FC082 DH	3-1/2	2 x 2/0 Solid - 250 MCM Stranded

# Ground Clamps and Connectors



## TRANSFORMER TANK GROUNDING CONNECTORS



TGC2/0



CC207

- Cast of high conductivity bronze and 1/2" – 13 stud
- Fit all EEI-NEMA distribution transformers
- No special tools required – use regular lineman's wrench
- RUS Approved

Part Number	Conductor Range (AWG)	Stud Thread Size
TGC2/0*	10 solid – 2/0 stranded	1/2" – 13
CC207	6 solid – 1/0 stranded	1/2" – 13
CC2074/0	2/0 stranded – 4/0 stranded	1/2" – 13

\* Eye bolt rotates to accommodate cable in either vertical or horizontal direction.

## TIN-PLATED, SILICON BRONZE JUMPER CLAMP

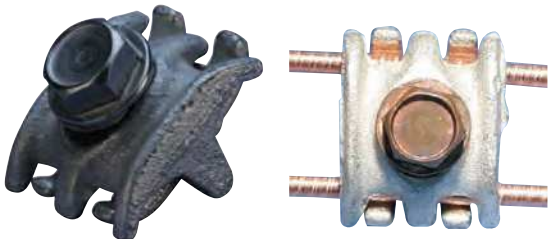

- For use in telecom applications
- UL® Listed

Part Number	Conductor Range (AWG)
KUL	6 solid



## HEAVY DUTY REBAR CLAMPS



- Provides two connection points to concrete encased electrodes (rebar) for states where the Authority Having Jurisdiction (AHJ) requires it.
- Meets 2005 NEC® standard requirement for bonding to rebar into the grounding system
- Has high-strength bronze alloy construction
- Easy to install
- UL Listed

## COPPER LUG MECHANICAL CONNECTOR



Part Number	Conductor Range (AWG)	Stud Thread Size
EL4	14 solid – 4 stranded	5/16-24 UNF-2B

Part Number	Conductor Range (AWG)	Conductor Range (metric)	Rebar Size (imperial)	Rebar Size (metric)
RC70	8 solid – 2/0 stranded	10 – 70 mm <sup>2</sup>	#3 – #6	8 – 18 mm
RC100	8 solid – 4/0 stranded	10 – 100 mm <sup>2</sup>	#6 – #11	18 – 36 mm



# Ground Clamps and Connectors



## INTERSYSTEM BONDING TERMINATION BAR (IBTB)



- Interconnects and terminates grounding conductors from electrical power service, telephone, CATV, radio and TV antennas
- Ideal for residential and small commercial applications
- Meets requirements of 2008 NEC Article 250.94
- cULus® Listed

Part Number	Conductor Range
IBTB	(5) 14 Solid - 6 Stranded; (1) 6 Solid - 2 Stranded; (5) 1.5 - 25 mm <sup>2</sup> ; (1) 16 - 35 mm <sup>2</sup>

## POTENTIAL EQUALIZATION CLAMP - PEC100



- High peak current capability - long service life
- Weatherproof enclosure - suitable for direct burial
- ATEX approved

The PEC is an equipotential bonding device that can be used to minimize damage in applications where separated ground systems are required. The PEC is ATEX approved, making the device suitable for use in explosion hazard areas such as the protection of pipeline insulated joints.

# Chemical Ground Electrodes

Chemical ground electrodes, part of the Eritech® line of Facility Electrical Protection products from nVent ERICO, provide a low impedance ground in locations of high soil resistivity and dry soil conditions. Used in conjunction with a bentonite backfill and nVent ERICO's unique GEM material, the Eritech brand of chemical ground electrode system provides a method to improve soil resistivity directly surrounding the electrode, and can replace multiple conventional ground rods. It maintains a low ground resistance, maintenance-free installation that dissipates lightning energy and other dangerous electrical fault currents, even in sandy or rocky soil conditions. The chemical ground electrode is useful for providing an effective earth in poor soil conditions where space for electrodes is limited. Market applications include telecommunications, power generation and distribution, commercial and industrial, manufacturing, transportation (rail and aviation), lightning protection, recreational facilities, and defense.

Eritech brand of chemical ground electrodes are most effective when installed as part of a total system that includes high conductivity backfill materials, access/inspection wells, and permanent, reliable Cadweld connections. They may be installed either vertically or horizontally.

## Features

- Contain natural electrolytic salts, which permeate into the surrounding soil to condition the soil and increase its conductivity
- Low impedance to effectively dissipate lightning and electrical fault currents
- Easy connection to ground electrode conductor using the factory provided pigtail (up or down orientation)
- Provides decades of reliable services due to rugged construction, and high quality metals with a 30-year minimum service life
- 2-1/8" outside diameter, Type K copper pipe, 0.083" wall contains natural electrolytic salts that permeate into the surrounding soil, improving electrode to soil connection
- Available in continuous sections up to 10 feet in length; longer rods can be field assembled using 5- or 10-foot extensions
- Optional factory attached radial strips are available to reduce impedance to high-frequency lightning energy and to control the direction of the dissipation
- L-shaped rods are available for horizontal installation applications where it is impractical to auger deep vertical holes
- Access segment on horizontal (L-shaped) chemical ground electrodes is 32" deep
- Over 100 configurations available

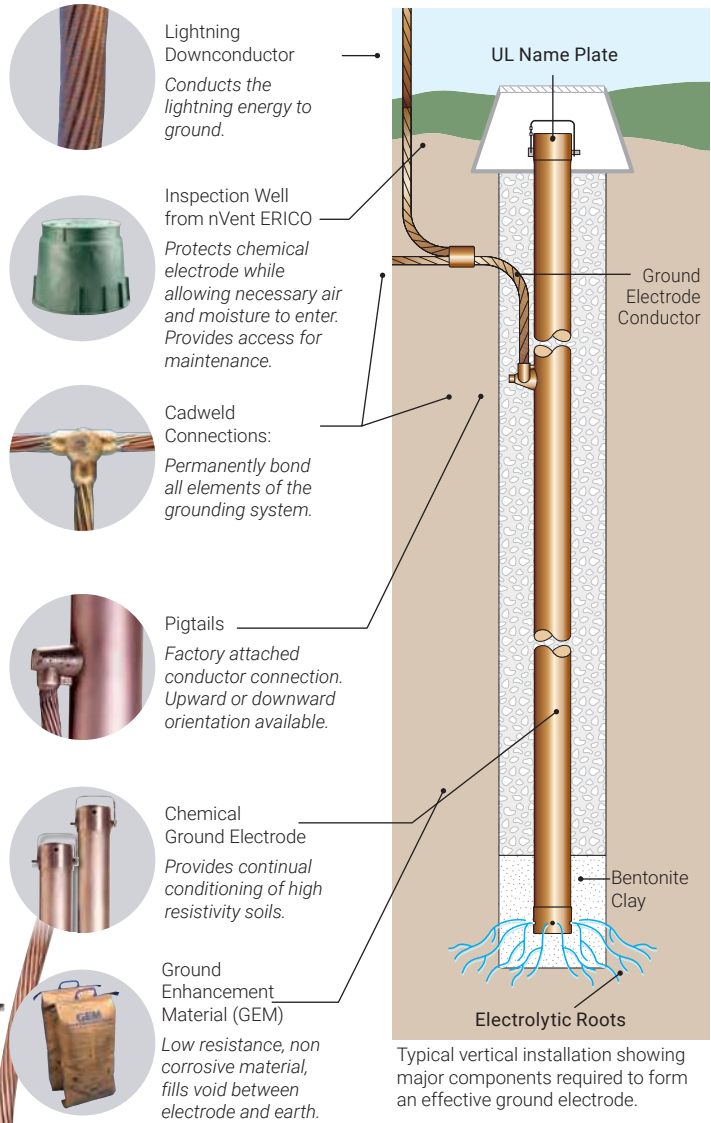

Typical vertical installation showing major components required to form an effective ground electrode.

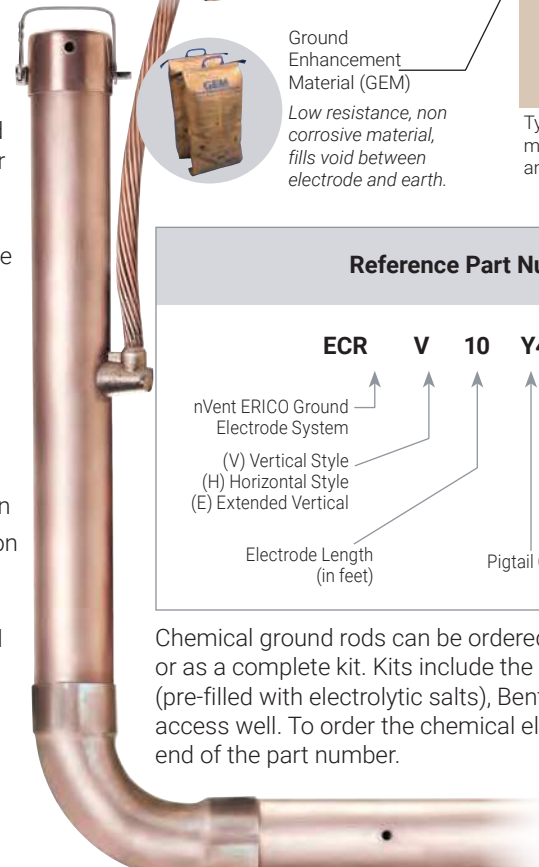

Reference Part Number Code						
ECR	V	10	Y4	4	U	B
nVent ERICO Ground Electrode System	(V) Vertical Style (H) Horizontal Style (E) Extended Vertical	Electrode Length (in feet)	Pigtail Cable Code	Pigtail Length (in feet)	Pigtail Orientation (D) Down (U) Up	Add (B) for rod assembly only

Chemical ground rods can be ordered as individual components or as a complete kit. Kits include the chemical electrode (pre-filled with electrolytic salts), Bentonite, GEM backfill, and an access well. To order the chemical electrode only, add "B" to the end of the part number.

# Chemical Ground Electrodes

Part Number	Electrode Length	Pigtail Length	Depth	Conductor Size
<b>Installation: Horizontal with Pigtail Up</b>				
ECRH081T4UB	8'	4'	32"	#2 Solid
ECRH081T4U	8'	4'	32"	#2 Solid
ECRH082C4U	8'	4'	32"	1/0 Stranded
ECRH081T5U	8'	5'	32"	#2 Solid
ECRH102Q2U	10'	2'	32"	4/0 Stranded
ECRH101T4UB	10'	4'	32"	#2 Solid
ECRH101T4U	10'	4'	32"	#2 Solid
ECRH101V4U	10'	4'	32"	#2 Stranded
ECRH102C4U	10'	4'	32"	1/0 Stranded
ECRH102G4U	10'	4'	32"	2/0 Stranded
ECRH102Q4UB	10'	4'	32"	4/0 Stranded
ECRH102Q4U	10'	4'	32"	4/0 Stranded
ECRH102V4UB	10'	4'	32"	250 kcmil Stranded
ECRH102V4U	10'	4'	32"	250 kcmil Stranded
ECRH103Q4U	10'	4'	32"	500 kcmil Stranded
ECRH104L4U	10'	4'	32"	750 kcmil Stranded
ECRH101T5U	10'	5'	32"	#2 Solid
ECRH102Q6U	10'	6'	32"	4/0 Stranded
ECRH101T10U	10'	10'	32"	#2 Solid
ECRH101T15U	10'	15'	32"	#2 Solid
ECRH101T20U	10'	20'	32"	#2 Solid
ECRH121T4U	12'	4'	32"	#2 Solid
ECRH122Q4U	12'	4'	32"	4/0 Stranded
ECRH122V4U	12'	4'	32"	250 kcmil Stranded
ECRH122Q5U	12'	5'	32"	4/0 Stranded
ECRH121T6U	12'	6'	32"	#2 Solid
ECRHE151G4U	15'	4'	32"	#6 Solid
ECRHE152Q4U	15'	4'	32"	4/0 Stranded
ECRHE201T4U	20'	4'	32"	#2 Solid
ECRHE202G4U	20'	4'	32"	2/0 Stranded
ECRHE202Q4U	20'	4'	32"	4/0 Stranded
ECRHE201L5U	20'	5'	32"	#4 Stranded
ECRHE202C20U	20'	20'	32"	1/0 Stranded
<b>Installation: Horizontal with Pigtail Down</b>				
ECRH081T4D	8'	4'	32"	#2 Solid
ECRH101T3D	10'	3'	32"	#2 Solid
ECRH101T4DB	10'	4'	32"	#2 Solid
ECRH101T4D	10'	4'	32"	#2 Solid
ECRH101V4D	10'	4'	32"	#2 Stranded
ECRH102C4D	10'	4'	32"	1/0 Stranded
ECRH102G4DB	10'	4'	32"	2/0 Stranded
ECRH102G4D	10'	4'	32"	2/0 Stranded
ECRH102Q4DB	10'	4'	32"	4/0 Stranded
ECRH102Q4D	10'	4'	32"	4/0 Stranded
ECRH102V4D	10'	4'	32"	250 kcmil Stranded
ECRH103Q4D	10'	4'	32"	500 kcmil Stranded
ECRH102G5D	10'	5'	32"	2/0 Stranded
ECRH102Q6DB	10'	6'	32"	4/0 Stranded
ECRH102G10D	10'	10'	32"	2/0 Stranded
ECRH102Q10D	10'	10'	32"	4/0 Stranded
ECRH122C4D	12'	4'	32"	1/0 Stranded
ECRH122G4D	12'	4'	32"	2/0 Stranded
ECRH122Q4DB	12'	4'	32"	4/0 Stranded
ECRH122Q4D	12'	4'	32"	4/0 Stranded
ECRHE152Q4D	15'	4'	32"	4/0 Stranded
ECRHE201T4D	20'	4'	32"	#2 Solid
ECRHE202G4D	20'	4'	32"	2/0 Stranded
ECRHE202Q4D	20'	4'	32"	4/0 Stranded
ECRHE203D4D	20'	4'	32"	350 kcmil Stranded

Part Number	Electrode Length	Pigtail Length	Depth	Conductor Size
<b>Installation: Vertical with Pigtail Up</b>				
ECRV081T4U	8'	4'	–	#2 Solid
ECRV081V4U	8'	4'	–	#2 Stranded
ECRV082Q4UB	8'	4'	–	4/0 Stranded
ECRV082Q4U	8'	4'	–	4/0 Stranded
ECRV081T5U	8'	5'	–	#2 Solid
ECRV081T6U	8'	6'	–	#2 Solid
ECRV081T20U	8'	20'	–	#2 Solid
ECRV101T2U	10'	2'	–	#2 Solid
ECRV102Q3U	10'	3'	–	4/0 Stranded
ECRV101T4U	10'	4'	–	#2 Solid
ECRV101V4U	10'	4'	–	#2 Stranded
ECRV102C4UB	10'	4'	–	1/0 Stranded
ECRV102C4U	10'	4'	–	1/0 Stranded
ECRV102G4UB	10'	4'	–	2/0 Stranded
ECRV102G4U	10'	4'	–	2/0 Stranded
ECRV102L4U	10'	4'	–	3/0 Stranded
ECRV102Q4UB	10'	4'	–	4/0 Stranded
ECRV102Q4U	10'	4'	–	4/0 Stranded
ECRV102V4U	10'	4'	–	250 kcmil Stranded
ECRV103Q4U	10'	4'	–	500 kcmil Stranded
ECRV101T5U	10'	5'	–	#2 Solid
ECRV102Q5UB	10'	5'	–	4/0 Stranded
ECRV102Q5U	10'	5'	–	4/0 Stranded
ECRV101T6U	10'	6'	–	#2 Solid
ECRV102G6U	10'	6'	–	2/0 Stranded
ECRV102Q6U	10'	6'	–	4/0 Stranded
ECRV102C8U	10'	8'	–	1/0 Stranded
ECRV102C10U	10'	10'	–	1/0 Stranded
ECRV102Q10UB	10'	10'	–	4/0 Stranded
ECRV102Q10U	10'	10'	–	4/0 Stranded
ECRV102C15U	10'	15'	–	1/0 Stranded
ECRV101T16U	10'	16'	–	#2 Solid
ECRV102Q20U	10'	20'	–	4/0 Stranded
ECRV121T4UB	12'	4'	–	#2 Solid
ECRV121T4U	12'	4'	–	#2 Solid
ECRV122C4U	12'	4'	–	1/0 Stranded
ECRV122Q4U	12'	4'	–	4/0 Stranded
ECRV122V4U	12'	4'	–	250 kcmil Stranded
ECRV123Q4U	12'	4'	–	500 kcmil Stranded
ECRV122G6UB	12'	6'	–	2/0 Stranded
ECRV122G10U	12'	10'	–	2/0 Stranded
ECRV122Q10U	12'	10'	–	4/0 Stranded
ECRE152Q4UB	15'	4'	–	4/0 Stranded
ECRE152Q4U	15'	4'	–	4/0 Stranded
ECRE153Q4U	15'	4'	–	500 kcmil Stranded
ECRE152Q6U	15'	6'	–	4/0 Stranded
ECRE152Q10UB	15'	10'	–	4/0 Stranded
ECRE152Q10U	15'	10'	–	4/0 Stranded
ECRE201T4UB	20'	4'	–	#2 Solid
ECRE201T4U	20'	4'	–	#2 Solid
ECRE201V4U	20'	4'	–	#2 Stranded
ECRE202G4U	20'	4'	–	2/0 Stranded
ECRE202Q4UB	20'	4'	–	4/0 Stranded
ECRE202Q4U	20'	4'	–	4/0 Stranded
ECRE203Q4U	20'	4'	–	500 kcmil Stranded
ECRE202V5U	20'	5'	–	250 kcmil Stranded
ECRE352L1UB	35'	1'	–	3/0 Stranded
ECRE402Q4UB	40'	4'	–	4/0 Stranded
ECRE402Q4U	40'	4'	–	4/0 Stranded

# Chemical Ground Electrodes

Part Number	Electrode Length	Pigtail Length	Depth	Conductor Size
<b>Installation: Vertical with Pigtail Down</b>				
ECRV082Q4DB	8'	4'	-	4/0 Stranded
ECRV082Q4D	8'	4'	-	4/0 Stranded
ECRV102Q2D	10'	2'	-	4/0 Stranded
ECRV101L4D	10'	4'	-	#4 Stranded
ECRV101T4DB	10'	4'	-	#2 Solid
ECRV101T4D	10'	4'	-	#2 Solid
ECRV101V4D	10'	4'	-	#2 Stranded
ECRV102C4DB	10'	4'	-	1/0 Stranded
ECRV102C4D	10'	4'	-	1/0 Stranded
ECRV102G4D	10'	4'	-	2/0 Stranded
ECRV102L4D	10'	4'	-	3/0 Stranded
ECRE102Q4DB	10'	4'	-	4/0 Stranded
ECRV102Q4DB	10'	4'	-	4/0 Stranded
ECRE102Q4D	10'	4'	-	4/0 Stranded
ECRV102Q4D	10'	4'	-	4/0 Stranded
ECRV102V4D	10'	4'	-	250 kcmil Stranded
ECRV103Q4D	10'	4'	-	500 kcmil Stranded
ECRV101T6D	10'	6'	-	#2 Solid
ECRV102C6D	10'	6'	-	1/0 Stranded
ECRV101V10D	10'	10'	-	#2 Stranded
ECRV103Q65D	10'	65'	-	500 kcmil Stranded
ECRV122G4D	12'	4'	-	2/0 Stranded
ECRV122L4D	12'	4'	-	3/0 Stranded
ECRV122Q4D	12'	4'	-	4/0 Stranded
ECRV122V4D	12'	4'	-	250 kcmil Stranded
ECRV123Q4D	12'	4'	-	500 kcmil Stranded
ECRE152Q4DB	15'	4'	-	4/0 Stranded
ECRE202C4DB	20'	4'	-	1/0 Stranded
ECRE202C4D	20'	4'	-	1/0 Stranded
ECRE202G4D	20'	4'	-	2/0 Stranded
ECRE202Q4DB	20'	4'	-	4/0 Stranded
ECRE202Q4D	20'	4'	-	4/0 Stranded
ECRE203Q4DB	20'	4'	-	500 kcmil Stranded
ECRE201T6DB	20'	6'	-	#2 Solid
ECRE202Q10D	20'	10'	-	4/0 Stranded
ECRE203Q10D	20'	10'	-	500 kcmil Stranded
ECRE202Q15D	20'	15'	-	4/0 Stranded
ECRE302Q4DB	30'	4'	-	4/0 Stranded
ECRE401T4D	40'	4'	-	#2 Solid
ECRE402G4D	40'	4'	-	2/0 Stranded
ECRE402Q4DB	40'	4'	-	4/0 Stranded
ECRE402Q4D	40'	4'	-	4/0 Stranded

Chemical ground rods can be ordered as individual components or as a complete kit. Kits include the chemical electrode (pre-filled with electrolytic salts), GEM, bentonite, and a high-density polyethylene inspection well.

## KIT COMPONENTS

Part Number	Description
GEM25A	25 lb (11.36 kg) bag of GEM – Ground Enhancement Material
BENTFILL	50 lb (22.68 kg) bag of Bentonite backfill
T416B	High-density polyethylene inspection well for no traffic areas

## COPPER PIGTAIL CABLE CODES

Conductor Code	Conductor Size (AWG)	Conductor Code	Conductor Size (AWG)
1T	#2 Solid Tinned	2Q	4/0 Stranded
2C	1/0 Stranded	2V	250 MCM Stranded
2G	2/0 Stranded	3Q	500 MCM Stranded

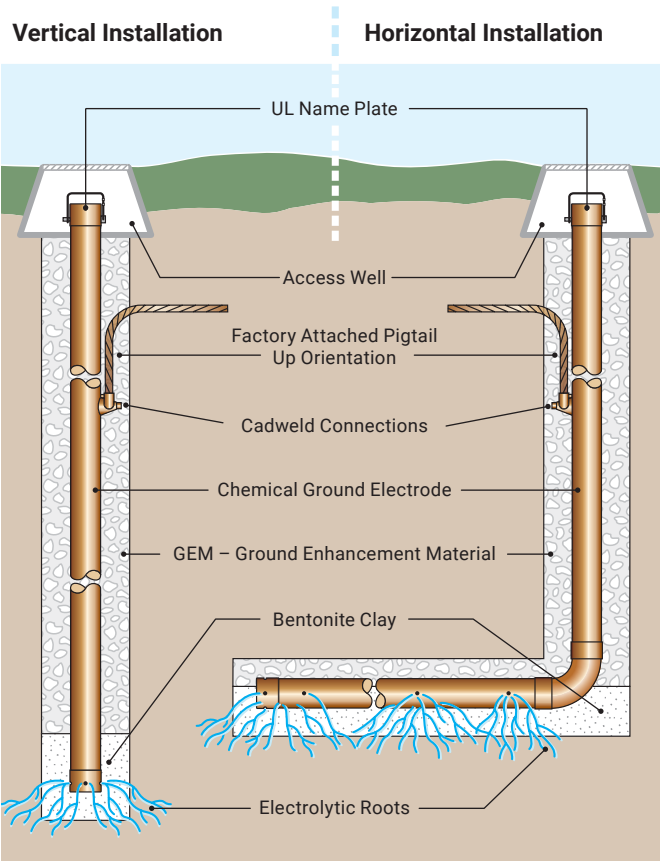

Chemical Ground Electrodes can be installed either vertically or horizontally. Chemical electrodes are available in a range of standard and custom configurations. They can be purchased individually or part of a complete kit.



Vertical Installation



Chemical Ground Electrodes can be extended using threaded couplers.

## SALT MIX

Part Number	Description
ECRCHM15LB	Chemical Ground Rod Salt Mix, 15-lb package (6.8 kg)

# Ground Enhancement Material



## Ground Enhancement Material (GEM)

Developed in 1992, Ground Enhancement Material (GEM) is a superior conductive material that solves your toughest grounding problems. It is the ideal material to use in areas of poor conductivity, such as rocky ground, mountain tops and sandy soil. GEM is also the answer in situations where ground rods can't be driven or where limited land area makes adequate grounding difficult with conventional methods. Only rarely do grounding system designers and contractors get to work on a site with good grounding conditions. Even under ideal circumstances, soil structure can vary and make it difficult to achieve uniform, low levels of resistivity across a wide area. Under almost all soil conditions, the use of a ground enhancement material will improve grounding effectiveness. Some are permanent and require no maintenance. When selecting a ground enhancement material

be sure it is compatible with the ground rod, conductor and connection material.

To improve the conductivity of a grounding system, nVent ERICO recommends using Ground Enhancement Material (GEM).

GEM is a low-resistance, non-corrosive, carbon dust based material that helps improve grounding effectiveness, especially in areas of poor conductivity. GEM contains cement, which hardens when set to provide a permanent, maintenance-free, low-resistant grounding system that never leaches or washes away. GEM does not adversely affect soil and will not leach ions or contaminate ground water. It meets all EPA requirements for landfill (USA). A Material Safety Data Sheet (MSDS) is available on request.

# Ground Enhancement Material

## Features and Benefits

GEM helps reduce earthing resistance and maintains low resistance permanently. GEM helps provide conductivity for the life of the grounding system.

## GEM is effective

- Dramatically reduces earth resistance and impedance measurements
- Maintains constant resistance for the life of the system once in its set form
- Performs in all soil conditions even during dry spells

## GEM is easy to use

- Easy-to-handle 25 lb (11.36 kg) bags or 25 lb bucket (GEM25ABKT)
- Requires one person to install
- Can be easily mixed into a slurry
- Solidifies into a conductive cement in three days
- May reduce the size of the grounding system where conventional methods are unsatisfactory
- Reduces vandalism (ground rods cannot be easily removed when set in concrete)

## GEM is permanent

- Does not dissolve, decompose or leach out with time
- Does not require periodic charging treatments or replacements
- Does not require maintenance
- Does not require the continuous presence of water to maintain its conductivity



nVent ERICO provides 25 lbs of Ground Enhancement Material (GEM) in a convenient, easy to handle bucket container. Just pour the required amount of clean-potable water into the bucket and mix to create a slurry form. Then proceed to pour the slurry mixture into the hole or trench.

Part Number	Description
GEM25A	25-lb. (11.36 kg) bag with handles
GEM25ABKT	25-lb. (11.36 kg) plastic bucket with locking lid

For more information, contact your local nVent ERICO sales representative for a quote. You can reference the GEM part numbers.

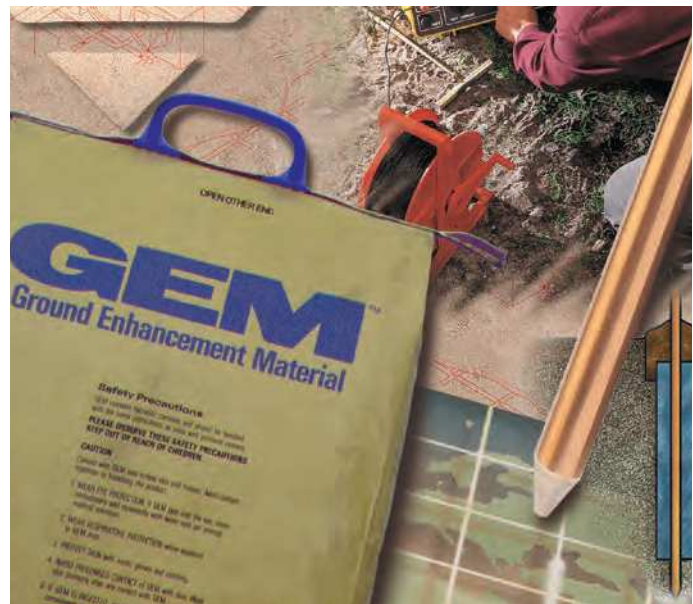

# nVent ERICO Quickfill

## Features and Benefits

- Lowers system resistance to ground
- Low-dust formulation
- Water not needed to install or perform
- Fast installation with no mixing or cure time required
- Can be installed in below-freezing temperatures
- Does not dissolve, decompose, or leach out with time
- Corrosion-resistant
- Sulfur content below 2% per IEC 62561-7
- Easy-to-handle 25 lb (11.3 kg) bags
- Requires only one person to install
- Resistance measurements can be taken immediately after installation
- Complies to the U.S. Environmental Protection Agency (EPA) Toxicity Characteristic Leaching Procedure (TCLP), EPA test method 1311
- Complies to EN 12457-2 Characterization of Waste Leaching Procedure, ENV 12506 and ENV 13370



nVent ERICO Quickfill is a no-mix ground-enhancing backfill that reduces resistance to ground and enables convenient installations. Quickfill is designed to minimize dust and eliminate mixing. It is the ideal material to use in areas of poor conductivity such as rocky ground, mountain tops, and sandy soil. Once installed, Quickfill is maintenance-free, not requiring periodic charging. Dry ground enhancement materials are more sensitive to seasonal variability than cement-based materials.

Unit Weight: 25 lb

Part Number
QF25



# Ground Enhancement Material

## GEM & Quickfill Trench Installation:

- GEM:** Premix GEM into a slurry form. Use 1.5 to 2 gallons of clean-potable water per bag or bucket of GEM. To mix GEM into a slurry form, use a standard cement mixer or mix in a mixing box, wheelbarrow, etc. Do not mix GEM with salt water.
- GEM:** Spread out enough GEM to uniformly cover bottom of trench—about 1 inch deep. (See Table 1)  
**Quickfill:** Pour nVent ERICO Quickfill uniformly into the trench to one-half of the Total Thickness of Quickfill, 1/2 h. (see Table 2)
- Place conductor on top of **GEM** (See Note 1) or **Quickfill** (See Note 2)
- GEM:** Spread more GEM on top of conductor to completely cover conductor – about 1 inch deep. Allow GEM to harden. Wait 30 minutes to one hour before filling the trench with soil backfill.  
**Quickfill:** Pour Quickfill on top of conductor to the Total Thickness of Quickfill, h. (see Table 2)
- GEM:** Carefully cover GEM with soil to a depth of about 4 inches, making sure not to expose the conductor  
**Quickfill:** Carefully cover the Quickfill with soil to a depth of about 4 inches, making sure not to expose the conductor.
- Tamp down the soil, then fill the trench.

**Note 1:** Wait for the GEM to harden, about 15 to 20 minutes, before placing the conductor on top of the GEM. You must apply 4 inches of insulating material to the conductors and ground rods exiting the GEM, starting 2 inches inside the GEM. (See Figure 1)

**Note 2:** You must apply 4 in of insulating material to the conductors and ground rods exiting the Quickfill, starting 2 in inside the Quickfill. (See Figure 1)

**Note 3:** For GEM installations, excess standing water must be removed from the trench.

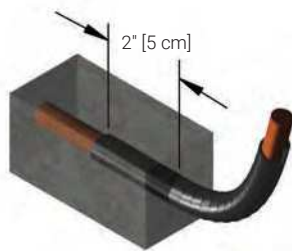
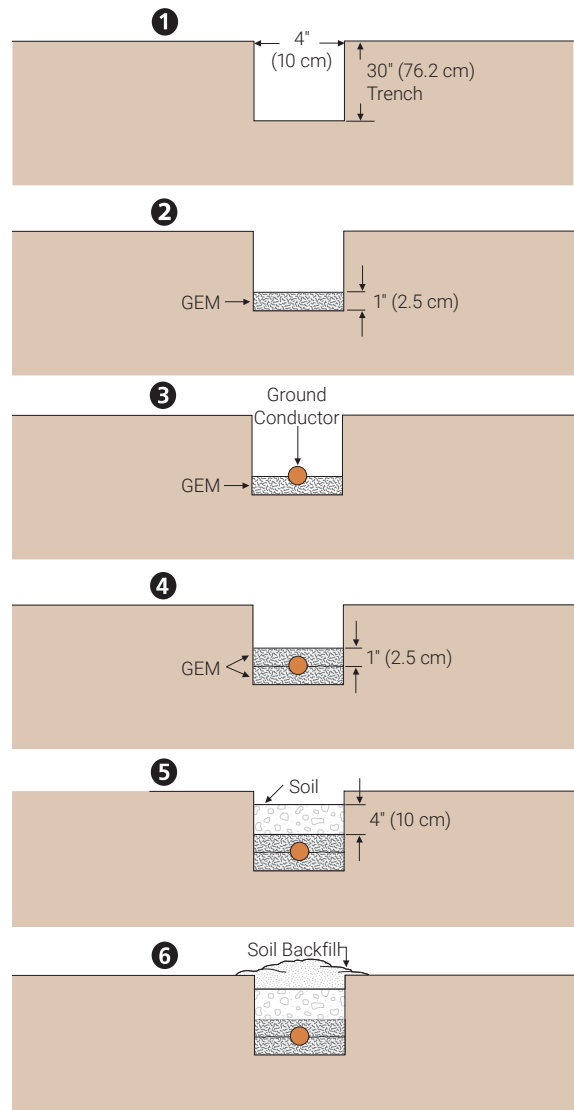

Figure 1



**TABLE 1: ESTIMATED TRENCH LENGTH PER BAG OF GEM**

Trench Width	Estimated Linear Feet of Ground Conductor Covering with Each Bag of GEM		
	Total Thickness of GEM		
	4"	5"	6"
4"	3.5'	2.8'	2.3'
6"	2.3'	1.8'	1.5'
8"	1.8'	1.4'	1.1'
10"	1.4'	1.1'	0.9'
12"	1.2'	0.9'	0.7'

A 25-pound bag of GEM will cover 7 linear feet (2.1 m) of conductor length for a 4-inch-wide (10 cm), 2-inch-thick (5 cm) covering 1 inch (2.5 cm) below and 1 inch (2.5 cm) above conductor) based on a density of 63.5 lb/cu.ft.

**TABLE 2: ESTIMATED TRENCH LENGTH PER BAG OF QUICKFILL**

Trench Width	Estimated Trench Length per Bag of Quickfill		
	Total Thickness of Quickfill		
	4"	5"	6"
4"	3.6'	2.9'	2.4'
6"	2.4'	1.9'	1.6'
8"	1.8'	1.4'	1.2'
10"	1.4'	1.1'	0.9'
12"	1.2'	0.9'	0.8'

A 25 lb. bag of Quickfill will cover 3.6 linear ft (1.1 m) of conductor length for a 4-inch-wide (10 cm), 4 inch-thick (10 cm) covering (2 in [5 cm] below conductor, and 2 in [5 cm] above conductor). Density: 62 lb/ft<sup>3</sup> (993 kg/m<sup>3</sup>) \*Dry ground enhancement materials are more sensitive to seasonal variability than cement-based materials.



# Ground Enhancement Material

## Ground Rod Backfill Installation for GEM & Quickfill:

1. Auger a 3" or larger diameter hole to a depth of 6" shorter than the length of the ground rod.
2. Place ground rod into augered hole and drive 1 ft, if possible, into the bottom of the hole. The top of the ground rod will be approximately 6" below grade. At this time, make any connections to ground rod using nVent ERICO Cadweld connections. (See Note 1)
3. **GEM:** Premix GEM into a slurry form. Use 1.5 to 2 gallons of clean-potable water per bag or bucket of GEM.

**Quickfill:** Skip to Step 4

4. **GEM:** Pour the appropriate amount of GEM (see Table 3) around the ground rod to ensure the GEM material completely fills the hole. Tamp around the ground rod with a pole. Wait 30 minutes to 1 hour before filling the hole with soil backfill.

**Quickfill:** Pour the appropriate amount of Quickfill (see Table 4) around the ground rod. Ground rod must be completely encased in Quickfill and not exposed to native soil.

5. Fill remainder of augered hole with soil removed during augering. For various augered-hole diameters and depths, see the Table 3 for **GEM** and Table 4 for **Quickfill** below.

**Note 1:** You must apply 4" of insulating material to the conductors and ground rods exiting the GEM or Quickfill, starting 2" inside the GEM or Quickfill (See Fig. 2)

**Note 2:** For **GEM** installations excess standing water must be removed from the hole.

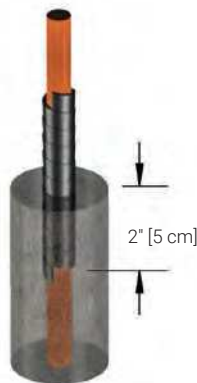
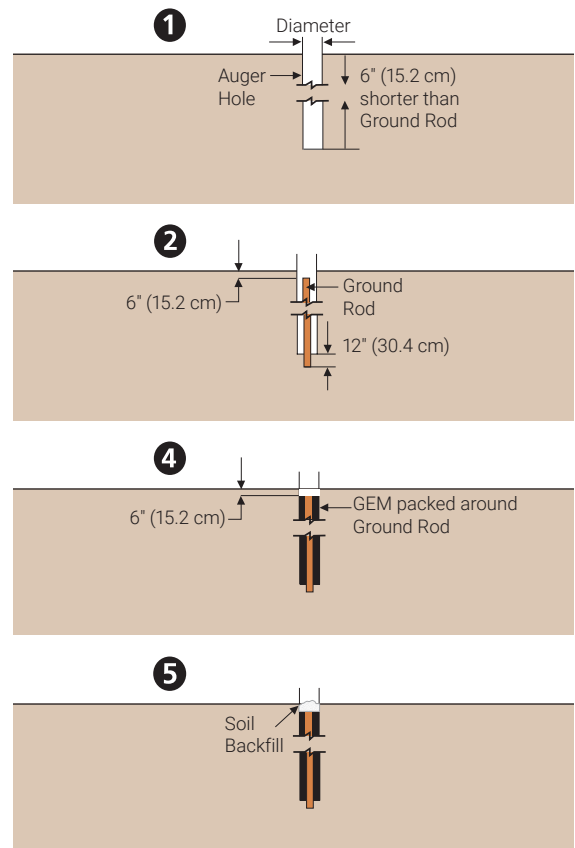

Figure 2



**TABLE 3: ESTIMATED BAGS OF GEM FOR BACKFILLING AROUND GROUND RODS**

Estimated Bags of GEM for Backfilling Around Ground Rods to a Density of 63.5 lb/ft <sup>3</sup> (1,017 kg/m <sup>3</sup> )						
Diameter of Hole Inches	Total Thickness of GEM					
	5 ft	6 ft	8 ft	10 ft	15 ft	20 ft
4"	2	2	2	3	4	5
6"	3	3	4	5	8	10
8"	5	6	8	9	14	18
10"	7	9	12	14	21	28
12"	10	12	16	20	30	40

\*8-ft (2.44 m) minimum rod length required to be in contact with the soil (or GEM), per NEC® 250-83-C

**Note:** to mix GEM into a slurry form, use a standard cement mixer or mix in a mixing box, wheelbarrow, etc. Use 1.5 to 2 gallons of clean potable water per bag of GEM. Do not mix GEM with salt water. For storage and safety precautions, see product packaging.

**TABLE 4: ESTIMATED BAGS OF QUICKFILL FOR BACKFILLING AROUND GROUND RODS**

Estimated Bsgs of Quickfill for Backfilling Around Ground Rods						
Diameter Inches	Total Thickness of GEM					
	5 ft	6 ft	8 ft	10 ft	15 ft	20 ft
4"	1.1	1.3	1.8	2.2	3.3	4.4
6"	2.5	3.0	3.9	4.9	7.4	9.8
8"	4.4	5.2	7.0	8.7	13.0	17.4
10"	6.8	8.2	10.9	13.6	20.3	27.1
12"	9.8	11.7	15.6	19.5	29.3	39.0

E.g. 1.1 25 lb. bags of Quickfill will fill a 4 in (10 cm) diameter, 5 ft (1.5 m) deep hole.

Density: 62 lb/ft<sup>3</sup> (993 kg/m<sup>3</sup>)

\* 8-ft (2.44 m) minimum rod length required to be in contact with the soil (or Quickfill), per NEC 250-83-C.

# Grounding Accessories

## LIGHT WEIGHT POLYMER CONCRETE INSPECTION WELLS

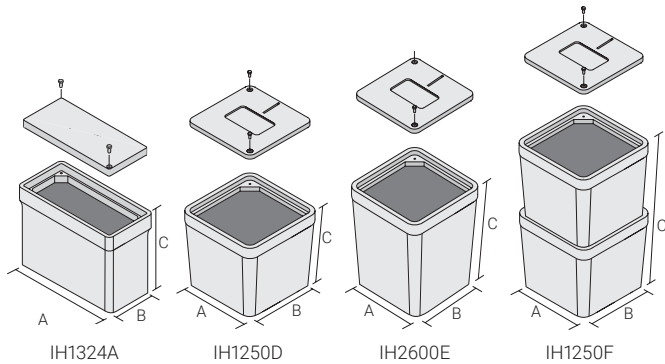

Part Number	Height	Length	Width	Unit Weight
IH1250D	12"	12"	12"	12.3 lb
IH1250F	23"	12"	12"	38.1 lb
IH1324A	18"	24"	13"	25.9 lb
IH2600E	18"	12"	12"	16.9 lb



IH1250F



T416BH

## HIGH DENSITY POLYETHYLENE INSPECTION WELLS (HDPE)

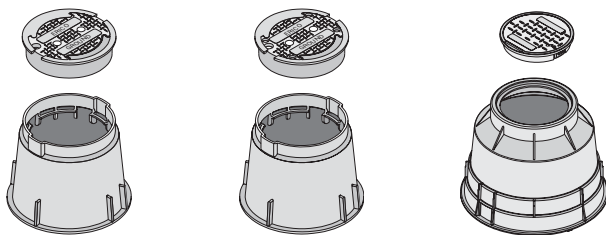

T416B

T416BH

T416C

Material: High Density Polyethylene (HDPE)  
Color: Green, Load Rating: 300 psf

Part Number	Diameter, Grade Level	Outer Diameter	Height	Unit Weight
T416B	10 1/4"	13.1"	10"	4.5 lb
T416BH	10 1/4"	13.1"	10"	4.5 lb

Material: High Density Polyethylene (HDPE)  
Color: Black, Load Rating: 300 psf

Part Number	Diameter, Grade Level	Outer Diameter	Height	Hole Size	Unit Weight
T416C	14 1/4"	24.38"	18 1/4"	2 3/4"	16.2 lb



## INSPECTION HOUSING, LIGHTWEIGHT POLYMER CONCRETE



T422A

- Tier 22 Design Load of 22,500 lbs (10,206 kg) with a test load of 34,720 lbs (15,749 kg)
- Non-slip cover suitable for non-deliberate, incidental traffic
- Cuts with a standard hole saw, no concrete tools required
- Includes the words "GROUND" on the cover

Part Number	Height	Length	Width	Unit Weight
T422A	18"	25"	15 1/2"	118 lb

# nVent ERICO Cadweld



Cadweld is an exothermic welding system for developing permanent welded electrical connections that will never loosen, corrode or increase in resistance. High-quality Cadweld connections are an integral part of the grounding and bonding process. Contact an nVent ERICO representative today to request additional information on Cadweld.

# nVent ERICO Cadweld

## NVENT ERICO CADWELD PLUS IMPULSE EXOTHERMIC WELDING CONTROL UNIT

Our latest innovation, the **nVent ERICO Cadweld Plus Impulse Exothermic Welding Control Unit**, brings you the highest level of flexibility and ease of use of any of our ignition systems. Precision engineered, the control unit lets you choose your power source: from off-the-shelf AA-batteries to the rechargeable Lithium-Ion packs you have on your job site.

Why should you choose our latest ignition system? Safety, power and ease-of-use.

### Safety

- Self-closing trigger guard prevents accidental ignition, providing added safety
- LED ignition counter provides instant feedback on the timing of the ignition and is visible in sunny outdoor conditions
- Five second delay in ignition is a safety feature to allow the user to stop ignition, if necessary

### Power

- Battery life indicator integrated into the unit for real-time updates on battery life; compatible with both AA and rechargeable batteries
- Includes AA alkaline batteries to power approximately 600 connections
- Rechargeable batteries from Milwaukee® or DEWALT® can be used to power approximately 1500 connections using a 4Ah battery
- Battery adapters available for use with either Milwaukee® or DEWALT® rechargeable batteries (sold separately)

### Ease-of-Use

- High temperature lead with single molded insert into the control unit keeps the most-often replaced component of ignition systems more securely attached and reliable
- Easy-to-use alligator clip design of the termination clearly shows a positive connection in the viewing window
- Enhanced power tool style grip is ergonomic and easy to hold



Part Number	Cable Length	Batteries	Working Temperature
PLUSCU2L6	6'	8 Standard AA Batteries	0 – 130°F
PLUSCU2L15	15'	8 Standard AA Batteries	0 – 130°F

# nVent ERICO Cadweld

## WHAT'S INCLUDED

Part Number	Item Description	Control Unit	Leads	AA Batteries	Battery Adapter	Bag
PLUSCU2L6	Control Unit with 6' Lead	Base Control Unit	6' length	8 Alkaline	For AA batteries	
PLUSCU2L15	Control Unit with 15' Lead	Base Control Unit	15' length	8 Alkaline	For AA batteries	
PLUSCU2RLD6	Replacement Lead, 6'		6' length			
PLUSCU2RLD15	Replacement Lead, 15'		15' length			
PLUSCU2BAA	AA Battery Adapter				For AA batteries	
PLUSCU2BM	Milwaukee® Battery Adapter				For Milwaukee® 18V rechargeable batteries	
PLUSCU2BD	DEWALT® Battery Adapter				For DEWALT® 20V rechargeable batteries	
PLUSCU2BMKIT	Control Unit with 6' Lead, Milwaukee® Battery Adapter and Bag	Base Control Unit	6' length	8 Alkaline	For AA batteries and for Milwaukee® 18V rechargeable batteries	Cadweld bag
PLUSCU2BDKIT	Control Unit with 6' Lead, DEWALT® Battery Adapter and Bag	Base Control Unit	6' length	8 Alkaline	For AA batteries and for DEWALT® 20V rechargeable batterie	Cadweld bag

The control unit is part of the nVent ERICO Cadweld family, which includes:

1. Standard and custom exothermic mold configurations
2. Welding material
3. Tools and accessories



For more information, visit [cadweld.com](http://cadweld.com) or contact your sales representative.

Include business contact information here.

# nVent ERICO Cadweld

## Cable to Cable

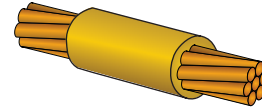
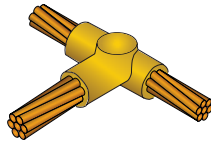

### TA – HORIZONTAL TEE

Conductor		Mold	Welding Material (Qty) P/N	Cadweld Plus Welding Material P/N
Run	Tap			
4	6	TAC1L1H	32	32PLUSF20
	4	TAC1L1L	32	32PLUSF20
2 SOL	2 SOL	TAC1T1T	45	45PLUSF20
2	4	TAC1V1L	45	45PLUSF20
	2	TAC1V1V	45	45PLUSF20
	4	TAC2C1L	45	45PLUSF20
	2	TAC2C1V	45	45PLUSF20
1/0	1/0	TAC2C2C	90	90PLUSF20
	4/0	TAC2C2Q	115	115PLUSF20
	4	TAC2G1L	45	45PLUSF20
	2	TAC2G1V	45	45PLUSF20
2/0	1/0	TAC2G2C	90	90PLUSF20
	2/0	TAC2G2G	90	90PLUSF20
	4/0	TAC2G2Q	115	115PLUSF20
	2	TAC2L1V	45	45PLUSF20
	1/0	TAC2L2C	90	90PLUSF20
	2/0	TAC2L2G	90	90PLUSF20
	3/0	TAC2L2L	115	115PLUSF20
4/0 SOL	4/0 SOL	TAC2P2P	150	150PLUSF20
	4	TAC2Q1L	90	90PLUSF20
	2	TAC2Q1V	90	90PLUSF20
	1/0	TAC2Q2C	90	90PLUSF20
	2/0	TAC2Q2G	90	90PLUSF20
	3/0	TAC2Q2L	115	115PLUSF20
	4/0	TAC2Q2Q	150	150PLUSF20
	350	TAC2Q3A	150	150PLUSF20
	500	TAC2Q3Q	150	150PLUSF20
	2/0	TAC2V2G	90	90PLUSF20
250	4/0	TAC2V2Q	150	150PLUSF20
	250	TAC2V2V	150	150PLUSF20
	4/0	TAC3D2Q	150	150PLUSF20
350	350	TAC3D3D	200	200PLUSF20

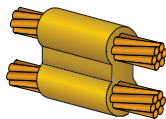

### PT – PARALLEL HORIZONTAL TEE

**Pro tip:** The PT connection is the most versatile mold in the Cadweld line. Mold can be used to make a parallel through or a splice or a "T" or "X" by bending cable.

Conductor		Mold	Welding Material (Qty) P/N	Cadweld Plus Welding Material P/N
Run	Tap			
2 SOL	2 SOL	PTC1T1T	65	65PLUSF20
2	2	PTC1V1V	65	65PLUSF20
1/0	1/0	PTC2C2C	90	90PLUSF20
	4/0	PTC2C2Q	150	150PLUSF20
	2 SOL	PTC2G1T	90	90PLUSF20
	2	PTC2G1V	90	90PLUSF20
2/0	1/0	PTC2G2C	115	115PLUSF20
	2/0	PTC2G2G	115	115PLUSF20
	4/0	PTC2G2Q	150	150PLUSF20
	1/0	PTC2L2C	115	115PLUSF20
3/0	3/0	PTC2L2L	150	150PLUSF20
	1/0	PTC2Q2C	150	150PLUSF20
	2/0	PTC2Q2G	150	150PLUSF20
	3/0	PTC2Q2L	200	200PLUSF20
	4/0	PTC2Q2Q	200	200PLUSF20

### SS – HORIZONTAL SPLICE

Conductor	Mold	Welding Material (Qty) P/N	Cadweld Plus Welding Material P/N
4	SST1L	25	25PLUSF20
2 SOL	SST1T	32	32PLUSF20
2	SST1V	32	32PLUSF20
1/0	SSC2C	45	45PLUSF20
2/0	SSC2G	65	65PLUSF20
3/0	SSC2L	90	90PLUSF20
4/0	SSC2Q	90	90PLUSF20
250	SSC2V	115	115PLUSF20

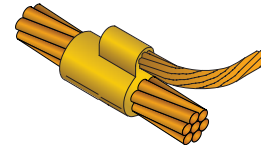

### PC – PARALLEL TAP

Conductor		Mold	Welding Material (Qty) P/N	Cadweld Plus Welding Material P/N
Run	Tap			
6 SOL	6 SOL	PCC1G1G	25	25PLUSF20
6	6	PCC1H1H	25	25PLUSF20
2 SOL	2 SOL	PCC1T1T	65	65PLUSF20
2	2	PCC1V1V	65	65PLUSF20
	6	PCC1T1G	32	32PLUSF20
1/0	6	PCC2C1H	45	45PLUSF20
	6 SOL	PCC2G1G	65	65PLUSF20
2/0	6	PCC2G1H	65	65PLUSF20
	2	PCC2G1V	90	90PLUSF20
3/0	6	PCC2L1H	90	90PLUSF20
	6 SOL	PCC2Q1G	90	90PLUSF20
	6	PCC2Q1H	90	90PLUSF20
4/0	2 SOL	PCC2Q1T	115	115PLUSF20
	2	PCC2Q1V	115	115PLUSF20
	4	PCC2Q1L	90	90PLUSF20
	4/0	PCC2Q2Q	150	150PLUSF20

Handle Clamp / Frame (See Page 10)

Price Key	Notes
C	REQUIRES L160 HANDLE CLAMP

Visit [Cadweld.com](http://Cadweld.com) for additional products.

# nVent ERICO Cadweld

## Cable to Cable • Cable to Ground Rod

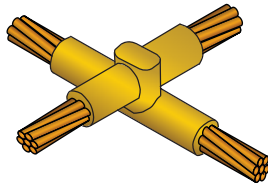

### XB – LAPPED HORIZONTAL SPLICE

Conductor		Mold	Welding Material (Qty) P/N	Cadweld Plus Welding Material P/N
Run	Tap			
6 SOL	6 SOL	XBP1G1G	32	32PLUSF20
4	4	XBC1L1L	65	65PLUSF20
2	2	XBC1V1V	90	90PLUSF20
1/0	1/0	XBQ2C2C	150	150PLUSF20
2/0	2/0	XBQ2G2G	200	200PLUSF20
4/0	2/0	XBQ2Q2G	200	200PLUSF20
	4/0	XBQ2Q2Q	250	250PLUSF20
250	250	XBQ2V2V	(2) 150	300PLUSF20
350	350	XBZ3D3D	500	500PLUSF20
500	500	XBZ3Q3Q	(3) 250	750PLUSF20

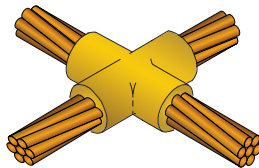

### XA – HORIZONTAL SPLICE

**Pro tip:** XB molds are preferred over XA molds, as they do not require cutting and gapping the secondary conductor.

Conductor		Mold	Welding Material (Qty) P/N	Cadweld Plus Welding Material P/N
Run	Tap			
4	4	XAC1L1L	45	65PLUSF20
2	2	XAC1V1V	65	65PLUSF20
1/0	1/0	XAC2C2C	90	90PLUSF20
2/0	2/0	XAC2G2G	115	115PLUSF20
3/0	3/0	XAC2L2L	150	150PLUSF20
4/0	2/0	XAC2Q2G	150	150PLUSF20
	4/0	XAC2Q2Q	200	200PLUSF20
250	4/0	XAC2V2Q	200	200PLUSF20
	250	XAC2V2V	200	200PLUSF20
350	350	XAC3D3D	250	250PLUSF20
500	4/0	XAD3Q2Q	(2) 150	300PLUSF20
	500	XAD3Q3Q	500	500PLUSF20

Handle Clamp / Frame (See Page 10)	
Price Key	Notes
C	REQUIRES L160 HANDLE CLAMP
P	INCLUDES B399C FRAME
T	INCLUDES B399A FRAME
D	REQUIRES L159 HANDLE CLAMP
Q	REQUIRES L160 HANDLE CLAMP
Z	REQUIRES L159 HANDLE CLAMP

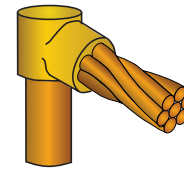

### GR – CABLE TO GROUND ROD

Ground Rod Size	Cable Size	Mold	Welding Material (Qty) P/N	Cadweld Plus Welding Material P/N	
5/8" Copperbonded Sectional (threaded) or Plain	6 SOL	GRT161G	32	32PLUSF20	
	6	GRT161H	32	32PLUSF20	
	4 SOL	GRT161K	32	32PLUSF20	
	4	GRT161L	32	32PLUSF20	
	2 SOL	GRC161T	65	65PLUSF20	
	2	GRC161V	65	65PLUSF20	
	1/0	GRC162C	90	90PLUSF20	
	2/0	GRC162G	90	90PLUSF20	
	3/0	GRC162L	90	90PLUSF20	
	4/0	GRC162Q	90	90PLUSF20	
	250	GRC162V	90	90PLUSF20	
	500	GRC163Q	115	115PLUSF20	
	3/4" Copperbonded Sectional (threaded) or Plain	6 SOL	GRT181G	32	32PLUSF20
		6	GRT181H	32	32PLUSF20
4 SOL		GRP181K	45	45PLUSF20	
4		GRP181L	45	45PLUSF20	
2 SOL		GRC181T	90	90PLUSF20	
2		GRC181V	90	90PLUSF20	
1/0		GRC182C	90	90PLUSF20	
2/0		GRC182G	90	90PLUSF20	
3/0		GRC182L	90	90PLUSF20	
4/0		GRC182Q	90	90PLUSF20	
250		GRC182V	90	90PLUSF20	
500		GRC183Q	150	150PLUSF20	

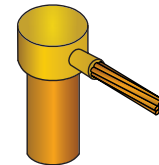

### GR ONE SHOT – CABLE TO GROUND ROD

**Pro tip:** nVent ERICO Cadweld One Shot comes in a convenient, single-use package to make a connection without a graphite mold. No need to preheat mold and the mold is range-taking for conductors.

Earth Rod Size	Cable Size, Solid	Cable Size, Stranded	Cadweld One Shot P/N	Cadweld Plus One Shot P/N
5/8" Copperbonded Sectional (threaded) or Plain	#4, #3	#6, #4	GR1161L	GR1161LPLUS
	#2, #1	#3, #2	GR1161V	GR1161VPLUS
	1/0, 2/0	#1, 1/0	GR1162C	GR1162CPLUS
	–	2/0	GR1162G	GR1162GPLUS
	–	3/0, 4/0	GR1162Q	GR1162QPLUS
3/4" Copperbonded Sectional (threaded) or Plain	#4, #3	#6, #4	GR1181L	GR1181LPLUS
	#2, #1	#3, #2	GR1181V	GR1181VPLUS
	1/0, 2/0	#1, 1/0	GR1182C	GR1182CPLUS
	–	2/0	GR1182G	GR1182GPLUS
	–	3/0, 4/0	GR1182Q	GR1182QPLUS

Weld material included with One Shot. Sleeves not optional, must use the sleeves that come with the One Shot ordered.

**Additional nVent ERICO Cadweld One Shot connections to ground rods available on Cadweld.com.**

Visit [Cadweld.com](http://Cadweld.com) for additional products.

# nVent ERICO Cadweld

## Cable to Ground Rod

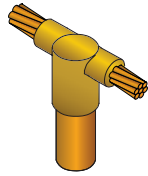

### GT – THROUGH CABLE TO TOP OF GROUND ROD

**Pro tip:** A GT mold can also be used to make a GR connection by stopping the cable at the outside edge of the mold.

Ground Rod Size	Cable Size	Mold	Welding Material (Qty) P/N	Cadweld Plus Welding Material P/N
5/8" Copperbonded Sectional (threaded) or Plain	6	GTT161G	32	32PLUSF20
	4	GTT161L	32	32PLUSF20
	2 SOL	GTC161T	90	90PLUSF20
	2	GTC161V	90	90PLUSF20
	1/0	GTC162C	90	90PLUSF20
	2/0	GTC162G	115	115PLUSF20
	3/0	GTC162L	115	115PLUSF20
	4/0	GTC162Q	115	115PLUSF20
	250	GTC162V	150	150PLUSF20
	500	GTC163Q	250	250PLUSF20
3/4" Copperbonded Sectional (threaded) or Plain	6 SOL	GTP181G	45	45PLUSF20
	6	GTP181H	45	45PLUSF20
	2 SOL	GTC181T	90	90PLUSF20
	2	GTC181V	90	90PLUSF20
	1/0	GTC182C	115	115PLUSF20
	2/0	GTC182G	115	115PLUSF20
	3/0	GTC182L	115	115PLUSF20
	4/0	GTC182Q	115	115PLUSF20
	250	GTC182V	150	150PLUSF20
	500	GTC183Q	250	200PLUSF20

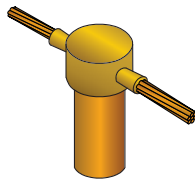

### GT ONE SHOT – CABLE TO GROUND ROD

**Pro tip:** nVent ERICO Cadweld One Shot comes in a convenient, single-use package to make a connection without a graphite mold. No need to preheat mold and the mold is range-taking for conductors.

Earth Rod Size	Cable Size, Solid	Cable Size, Stranded	Cadweld One Shot P/N	Cadweld Plus One Shot P/N
5/8" Copperbonded Sectional (threaded) or Plain	#4, #3	#6, #4	GT1161L	GT1161LPLUS
	#2, #1	#3, #2	GT1161V	GT1161VPLUS
	1/0, 2/0	#1, 1/0	GT1162C	GT1162CPLUS
	-	2/0	GT1162G	GT1162GPLUS
	-	3/0, 4/0	GT1162Q	GT1162QPLUS
	3/4" Copperbonded Sectional (threaded) or Plain	#4, #3	#6, #4	GT1181L
#2, #1		#3, #2	GT1181V	GT1181VPLUS
1/0, 2/0		#1, 1/0	GT1182C	GT1182CPLUS
-		2/0	GT1182G	GT1182GPLUS
-		3/0, 4/0	GT1182Q	GT1182QPLUS

Weld material included with One Shot. Sleeves not optional, must use the sleeves that come with the One Shot ordered.

Additional nVent ERICO Cadweld One Shot connections to ground rods available on Cadweld.com.

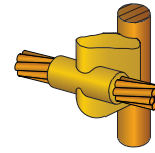

### GY – THROUGH CABLE TO SIDE OF GROUND ROD

**Pro tip:** The GY connection allows you to make a connection and then finish driving the ground rod.

Ground Rod Size	Cable Size	Mold	Welding Material (Qty) P/N	Cadweld Plus Welding Material P/N
5/8" Copperbonded Sectional (threaded) or Plain	2 SOL	GYR161T	90	90PLUSF20
	2	GYR161V	90	90PLUSF20
	1/0	GYR162C	115	115PLUSF20
	2/0	GYR162G	115	115PLUSF20
	3/0	GYR162L	150	150PLUSF20
	4/0	GYR162Q	150	150PLUSF20
	250	GYR162V	150	150PLUSF20
	350	GYR163D	250	250PLUSF20
	500	GYF163Q	400	400PLUSF20
	3/4" Copperbonded Sectional (threaded) or Plain	2 SOL	GYR181T	90
2		GYR181V	90	90PLUSF20
1/0		GYR182C	115	115PLUSF20
2/0		GYR182G	115	115PLUSF20
3/0		GYR182L	150	150PLUSF20
4/0		GYR182Q	150	150PLUSF20
250		GYR182V	200	200PLUSF20
350		GYR283D	300	300PLUSF20
500		GYF183Q	500	500PLUSF20

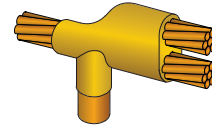

### NC – THROUGH CABLE / TAP TO GROUND ROD

**Pro tip:** An NC mold can be used to make a "T" to top of rod by bending the tap cable.

Ground Rod Size	Cable Size	Mold	Welding Material (Qty) P/N	Cadweld Plus Welding Material P/N
5/8" Copperbonded Sectional (threaded) or Plain	2 SOL	NCR161T	115	115PLUSF20
	2	NCR161V	115	115PLUSF20
	1/0	NCR162C	150	150PLUSF20
	2/0	NCR162G	200	200PLUSF20
	3/0	NCR162L	250	250PLUSF20
3/4" Copperbonded Sectional (threaded) or Plain	4/0	NCR162Q	250	250PLUSF20
	6	NCR181H	90	90PLUSF20
	2 SOL	NCR181T	115	115PLUSF20
	2	NCR181V	115	115PLUSF20
	1/0	NCR182C	150	150PLUSF20
	2/0	NCR182G	200	200PLUSF20
	3/0	NCR182L	250	250PLUSF20
	4/0	NCR182Q	250	250PLUSF20

### Handle Clamp / Frame (See Page 10)

Price Key	Notes
C	REQUIRES L160 HANDLE CLAMP
R	REQUIRES L160 HANDLE CLAMP
T	INCLUDES B399A FRAME
F	REQUIRES L159 HANDLE CLAMP

Visit [Cadweld.com](http://Cadweld.com) for additional products.



# nVent ERICO Cadweld

## Cable to Bus / Lug

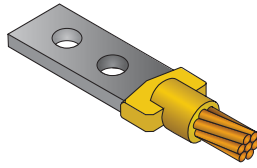

### LA – CABLE TO LUG

Bus Or Lug Size	Cable Size	Mold	Welding Material (Qty) P/N	Cadweld Plus Welding Material P/N
1/8" x 1" Lug / Bus	2 SOL	LAC1TCE	45	45PLUSF20
	2	LAC1VCE	45	45PLUSF20
	1/0	LAC2CCE	45	45PLUSF20
	2/0	LAC2GCE	65	65PLUSF20
	3/0	LAC2LCE	65	65PLUSF20
1/4" x 1" Lug / Bus	4/0	LAC2QCE	65	65PLUSF20
	1/0	LAC2CEE	65	65PLUSF20
	2/0	LAC2GEE	65	65PLUSF20
	4/0 SOL	LAC2PEE	90	90PLUSF20
	4/0	LAC2QEE	90	90PLUSF20
1/4" x 1-1/2" Lug/Bus	300	LAC3AEE	90	90PLUSF20
	350	LAC3DEE	115	115PLUSF20
	4/0	LAC2QEG	90	90PLUSF20
	250	LAC2VEG	90	90PLUSF20
	350	LAC3DEG	115	115PLUSF20
	500	LAC3QEG	200	200PLUSF20

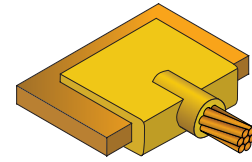

### LJ – CABLE TO BUSBAR

**Pro tip:** The LJ connection is the easiest, simplest connection to make to busbar.

Bus Or Lug Size	Cable Size	Mold	Welding Material (Qty) P/N	Cadweld Plus Welding Material P/N
1/4" x 1-1/2" & Wider Lug/Bus	6	LJCEG1H	65	65PLUSF20
	2 SOL	LJCEG1T	65	65PLUSF20
	2	LJCEG1V	65	65PLUSF20
	1/0	LJCEG2C	90	90PLUSF20
	2/0	LJCEG2G	90	90PLUSF20
	3/0	LJCEG2L	90	90PLUSF20
	4/0	LJCEG2Q	90	90PLUSF20
	500	LJCEG3Q	200	200PLUSF20

#### Handle Clamp / Frame (See Page 10)

Price Key	Notes
C	REQUIRES L160 HANDLE CLAMP

Visit [Cadweld.com](http://Cadweld.com) for additional products.

# nVent ERICO Cadweld

## Cable to Steel Surface

**Pro tip:** Make sure that the steel surface is cleaned according to the Cadweld mold instructions and use tools that do not leave residue on the surface.

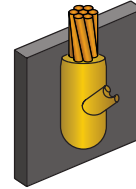
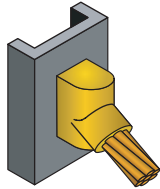

### VS – CABLE TO VERTICAL STEEL

Surface	Cable Size	Mold	Welding Material (Qty) P/N	Cadweld Plus Welding Material P/N
Flat Surface	6	VSC1H	45	45PLUSF20
	4	VSC1L	45	45PLUSF20
	2 SOL	VSC1T	45	45PLUSF20
		VSC1V	45	45PLUSF20
	1/0	VSC2C	90	90PLUSF20
	2/0	VSC2G	90	90PLUSF20
	3/0	VSC2L	115	115PLUSF20
	4/0	VSC2Q	115	115PLUSF20
	500	VSC3Q	200	200PLUSF20
1-1/4" to 4" Pipe	2 SOL	VSC1VV3C	45	45PLUSF20
1-1/2" to 4" Pipe	4	VSC1LV3C	45	45PLUSF20
	2	VSC1TV3C	45	45PLUSF20
2" to 4" Pipe	2/0	VSC2GV3C	90	90PLUSF20
	4/0	VSC2QV3C	115	115PLUSF20
4" to 6" Pipe	2 SOL	VSC1TV5C	45	45PLUSF20
	4/0	VSC2QV5C	115	115PLUSF20

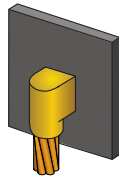

### VB – CABLE TO VERTICAL STEEL

Surface	Cable Size	Mold	Welding Material (Qty) P/N	Cadweld Plus Welding Material P/N
Flat Surface	4	VBC1L	65	65PLUSF20
	2 SOL	VBC1T	65	65PLUSF20
		VBC1V	65	65PLUSF20
	1/0	VBC2C	115	115PLUSF20
	2/0	VBC2G	115	115PLUSF20
	3/0	VBC2L	150	150PLUSF20
	4/0 SOL	VBC2P	150	150PLUSF20
	4/0	VBC2Q	150	150PLUSF20
	500	VBC3Q	(2) 150	300PLUSF20
1-1/4" to 3-1/2" Pipe	4/0	VBC2QV3C	150	150PLUSF20
	2 SOL	VBC1TV3C	65	65PLUSF20
	4 SOL	VBC1KV3C	65	65PLUSF20
	2	VBC1V3C	65	65PLUSF20

Handle Clamp / Frame (See Page 10)	
Price Key	Notes
A	INCLUDES FRAME WITH HANDLE
C	REQUIRES L160 HANDLE CLAMP
R	REQUIRES L160 HANDLE CLAMP

**Pro tip:** B396 magnetic handle clamp can be used for flat vertical steel, and B160V can be used for vertical steel pipes up to 4".

### VF – CABLE TO VERTICAL STEEL

Surface	Cable Size	Mold	Welding Material (Qty) P/N	Cadweld Plus Welding Material P/N
Flat Surface	4	VFC1L	65	65PLUSF20
	2 SOL	VFC1T	65	65PLUSF20
		VFC1V	65	65PLUSF20
	2/0	VFC2G	150	150PLUSF20
	3/0	VFR2L	200	200PLUSF20
	4/0	VFR2Q	200	200PLUSF20
2" to 4" Pipe	2 SOL	VFC1TV3C	65	65PLUSF20

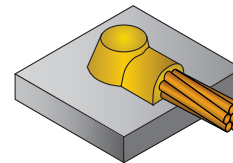

### HA – CABLE TO HORIZONTAL STEEL

Cable Size	Mold	Welding Material (Qty) P/N	Cadweld Plus Welding Material P/N
6 SOL	HAA1G	45	45PLUSF20
6	HAA1H	45	45PLUSF20
4	HAA1L	45	45PLUSF20
2 SOL	HAA1T	45	45PLUSF20
2	HAA1V	45	45PLUSF20

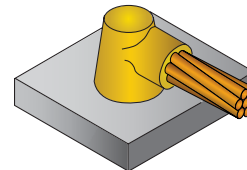

### HS – CABLE TO HORIZONTAL STEEL

Cable Size	Mold	Welding Material (Qty) P/N	Cadweld Plus Welding Material P/N
1/0	HSC2C	90	90PLUSF20
2/0	HSC2G	90	90PLUSF20
3/0	HSC2L	115	115PLUSF20
4/0	HSC2Q	115	115PLUSF20
250	HSC2V	115	115PLUSF20
350	HSC3D	200	200PLUSF20
500	HSC3Q	200	200PLUSF20

Visit [Cadweld.com](http://Cadweld.com) for additional products.

# nVent ERICO Cadweld

## Cable to Rebar

**Pro tip:** Packing of some sort is required for most rebar connections, and one is required for each weld. The packing is not optional.

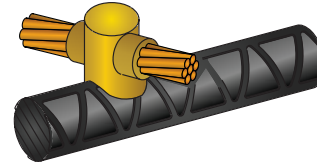
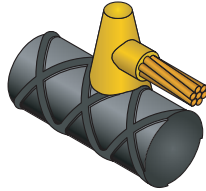

### RR – CABLE TO REBAR

Rebar Size	Cable Size	Mold	Welding Material (Qty) P/N	Cadweld Plus Welding Material P/N	Packing P/N
#4	1/0	RRC522C	90	90PLUSF20	B141A
	2/0	RRC522G	90	90PLUSF20	B141A
	3/0	RRC522L	115	115PLUSF20	B141A
	4/0	RRC522Q	115	115PLUSF20	B141A
#5	4	RRA531L	32	32PLUSF20	B143A
	2	RRA531V	45	45PLUSF20	B143A
	1/0	RRC532C	90	90PLUSF20	B141A
	2/0	RRC532G	90	90PLUSF20	B141A
#6	3/0	RRC532L	115	115PLUSF20	B141A
	4/0	RRC532Q	115	115PLUSF20	B141A
	4	RRA541L	32	32PLUSF20	B143B
	2	RRA541V	45	45PLUSF20	B143B
#6	1/0	RRH542C	90	90PLUSF20	B144C
	2/0	RRH542G	90	90PLUSF20	B144C
	3/0	RRH542L	115	115PLUSF20	B144C
	4/0	RRH542Q	115	115PLUSF20	B144C

### RD – CABLE TO REBAR

Rebar Size	Cable Size	Mold	Welding Material (Qty) P/N	Cadweld Plus Welding Material P/N	Packing P/N
#4	4	RDC521L	65	65PLUSF20	B141A
	2 SOL	RDC521T	65	65PLUSF20	B141A
	2	RDC521V	90	90PLUSF20	B141A
	1/0	RDM522C	115	115PLUSF20	B141A
#5	2/0	RDM522G	115	115PLUSF20	B141A
	3/0	RDM522L	150	150PLUSF20	B141A
	4/0	RDM522Q	150	150PLUSF20	B141A
	4	RDC531L	65	65PLUSF20	B141A
#5	2	RDC531V	90	90PLUSF20	B141A
	2/0	RDM532G	115	115PLUSF20	B141A
	3/0	RDM532L	150	150PLUSF20	B141A
	4/0	RDM532Q	150	150PLUSF20	B141A
#6	4	RDH541L	65	65PLUSF20	B144C
	2	RDH541V	90	90PLUSF20	B144C
	2/0	RDH542G	115	115PLUSF20	B144C
	3/0	RDH542L	150	150PLUSF20	B144A
#6	4/0	RDH542Q	150	150PLUSF20	B144A
	2/0	RDH562G	115	115PLUSF20	B144C
	3/0	RDH562L	150	150PLUSF20	B144A
	4/0	RDH562Q	150	150PLUSF20	B144A
#8	250	RDH562V	150	150PLUSF20	B144A

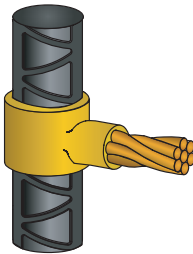

### RJ – CABLE TO REBAR

Rebar Size	Cable Size	Mold	Welding Material (Qty) P/N	Cadweld Plus Welding Material P/N	Packing P/N
#4	6	RJC521H	45	45PLUSF20	B140A
	4	RJC521L	65	65PLUSF20	B140A
	2	RJC521V	65	65PLUSF20	B140A
	1/0	RJC522C	115	115PLUSF20	B140A
	2/0	RJC522G	115	115PLUSF20	B140A
	3/0	RJC522L	150	150PLUSF20	B140A
	4/0	RJC522Q	150	150PLUSF20	B140A
#5	1/0	RJC532C	115	115PLUSF20	B140A
	2/0	RJC532G	115	115PLUSF20	B140A
	3/0	RJC532L	150	150PLUSF20	B140A
	4/0	RJC532Q	150	150PLUSF20	B140A
#6	1/0	RJC542C	115	115PLUSF20	B140B
	2/0	RJC542G	115	115PLUSF20	B140B
	3/0	RJC542L	150	150PLUSF20	B140B
	4/0	RJC542Q	150	150PLUSF20	B140B

### Rebar Packing

P/N	Description	Qty. Per Carton
B140A	Copper Shim, 0.13" x 3" x 1.5"	50
B140B	Copper Shim, 0.013" x 3" x 2.5"	50
B141A*	Copper Shim, 0.13" x 3" x 1.5"	50
B143A	Ceramic Packing, 0.25" x 1.75" x 1.77"	20
B143B	Ceramic Packing, 0.25" x 2" x 1.75"	20
B144A	Ceramic Packing, 0.25" x 3" x 3"	20
B144C	Ceramic Packing, 0.25" x 3" x 3"	20

\*Each piece of B141A includes 2 copper shims as required per rebar connection

### Handle Clamp / Frame (See Page 10)

Price Key	Notes
A	INCLUDES FRAME WITH HANDLE
C	REQUIRES L160 HANDLE CLAMP
H	INCLUDES TOGGLE FRAME WITH HANDLE
M	INCLUDES FRAME WITH HANDLE

Visit [Cadweld.com](http://Cadweld.com) for additional products.

# nVent ERICO Cadweld

## Materials, Tools & Accessories



Traditional Cadweld



Cadweld Plus

Cadweld Welding Material		
Traditional	Cadweld Plus	Qty. Per Carton
15	15PLUSF20	20
25	25PLUSF20	20
32	32PLUSF20	20
45	45PLUSF20	20
65	65PLUSF20	20
90	90PLUSF20	10
115	115PLUSF20	10
150	150PLUSF20	10
200	200PLUSF20	10
250	250PLUSF20	10
(2) 150	300PLUSF20	10
(2) 200	400PLUSF20	10
500	500PLUSF20	10

### ADAPTING MOLDS TO FIT CONDUCTORS

Cables smaller than indicated on mold tag can be welded by using either Wrap Sleeves or Adapter Sleeves

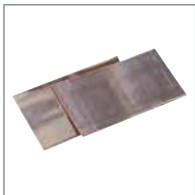

#### nVent ERICO Cadweld Wrap Sleeve B140A

Cadweld Wrap Sleeve is wrapped around the cable until the diameter is about the same as the cable opening in the mold.



#### nVent ERICO Cadweld Adapter Sleeves

Cadweld Adapter Sleeves are used to adapt a limited range of smaller size cables to a larger size Cadweld mold.

### CADWELD ADAPTER SLEEVES

Cable Size			
Concentric Strand	Solid	Adapter Sleeve Part Number	Use in Mold for Stranded
#12, 14	#10, 12, 14	B1331H	#6
#7, 8, 10	#6, 8	B1331L	#4
#6	#5	B112	#2
#4, 5	#3, 4	B1331V	#2
#3, 4	#2	B1331Y	#1
#2	#1	B1332C	1/0
#1	1/0	B1332G	2/0
1/0, 1	2/0	B1332L	3/0
2/0, 1/0	3/0	B1332Q	4/0

Cadweld Accessories can be of U.S. or non-U.S. origin.



**L160**  
Handle Clamps



**T313**  
Card Cleaning Brush



**T314**  
Cable Cleaning Brush



**T321**  
Rasp



**T394**  
Mold Cleaning Brush



**T403**  
Mold Sealer



**T320**  
Flint Ignitor



**PLUSCU2L6**  
nVent ERICO Cadweld Plus Impulse Exothermic Welding Control Unit



**T111**  
Surefire™ Torch Head



**B160V**  
Chain Support Clamp



**B396**  
Magnetic Handle Clamp



**B265**  
Cable Clamp

# nVent ERICO Cadweld

## THE NVENT ERICO CADWELD PROCESS

Cadweld connections are the accepted method of attaching Cathodic Protection leads to pipes (steel or cast iron), tanks and structures.

Cadweld connections weld the conductors and the structure to be protected so no galvanic corrosion can occur at the interface. The Cadweld process is specifically formulated to provide minimum heat effect on steel, which is especially important on thin-wall, high-stress pipes.

Cadweld connections are also used for header cable taps, conductor splices and terminations, and ground rod connections.

## NVENT FACTS

A Cadweld Connection . . .

- Has current carrying capacity equal to that of the conductor.
- Is permanent with a low resistance connection that cannot loosen or corrode.
- Uses lightweight, inexpensive equipment.
- Requires no external source of power or heat.
- Requires no special skills.
- Can be easily checked for quality.

**nVent is the pioneer of the Cadweld Exothermic Welding Process for permanent Cathodic Protection connections. Specifying the Cadweld Process in your construction plans will dramatically extend the lifespan of infrastructure systems.**

Cadweld connections are made with a semi-permanent graphite mold, which holds the conductors to be welded. Weld metal (a mixture of copper oxide and aluminum) is dumped into the top of the mold. The mold is covered and the weld metal ignited. The exothermic reaction produces molten copper, which results in a permanent, high conductivity connection.

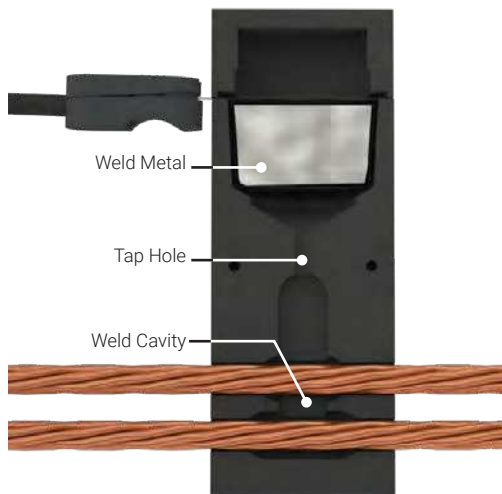

Cadweld Plus

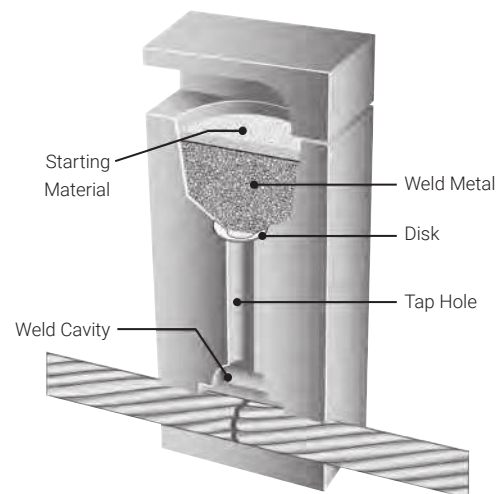

Traditional Cadweld

# nVent ERICO Cadweld Connections for Cathodic Protection

## Connections to Steel

### TYPE CAHA

Tap conductor to top of horizontal STEEL pipe or flat surface.

Note: For DUCTILE IRON, see page 20.

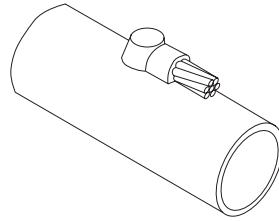

CAHA - Cable to Horizontal Steel Pipe

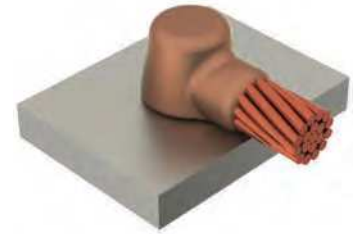

CAHA - Cable on surface

Conductor Size	Surface	Mold Part Number <sup>†</sup>	Mold Price Key	Traditional Cadweld Weld Metal	Cadweld Plus Weld Metal
#14 to #10 Solid (use sleeve CAB1331H)* or #8 Solid or Stranded, or #6 Solid	Flat (4" & larger pipe) 3/4" to 3-1/2" pipe	CAHAA1G	CAA	CA15	CA15PLUSF33
		CAHAA1GA	CAA	CA15	CA15PLUSF33
6 Stranded	Flat (4" & larger pipe) 3/4" to 3-1/2" pipe	CAHAA1H	CAA	CA15	CA15PLUSF33
		CAHAA1HA	CAA	CA15	CA15PLUSF33
4 Solid	Flat (6" & larger pipe) 3/4" to 3-1/2" pipe 4" to 5" pipe	CAHAA1K	CAA	CA15	CA15PLUSF33
		CAHAA1KA	CAA	CA15	CA15PLUSF33
		CAHAA1KB	CAA	CA15	CA15PLUSF33
4 Stranded	Flat (6" & larger pipe) 3/4" to 3-1/2" pipe 4" to 5" pipe	CAHAA1L	CAA	CA15	CA15PLUSF33
		CAHAA1LA	CAA	CA15	CA15PLUSF33
		CAHAA1LB	CAA	CA15	CA15PLUSF33
2 Solid	Flat (10" & larger pipe) 1" to 3-1/2" pipe 4" to 8" pipe	CAHAA1T	CAA	CA25	CA25PLUSF33
		CAHAA1TA	CAA	CA25	CA25PLUSF33
		CAHAA1TB	CAA	CA25	CA25PLUSF33
2 Stranded	Flat (16" & larger pipe) 1" to 3-1/2" pipe 4" to 8" pipe 10" to 14" pipe	CAHAA1V	CAA	CA32	CA32PLUSF33
		CAHAA1VA	CAA	CA32	CA32PLUSF33
		CAHAA1VB	CAA	CA32	CA32PLUSF33
		CAHAA1VC	CAA	CA32	CA32PLUSF33
1 Stranded	Flat (16" & larger pipe) 1-1/2" to 3-1/2" pipe 4" to 8" pipe 10" to 14" pipe	CAHAA1Y	CAA	CA45	CA45PLUSF33
		CAHAA1YA	CAA	CA45	CA45PLUSF33
		CAHAA1YB	CAA	CA45	CA45PLUSF33
		CAHAA1YC	CAA	CA45	CA45PLUSF33
1/0 Stranded	Flat (20" & larger pipe) 2-1/2" to 3-1/2" pipe 4" to 8" pipe 10" to 18" pipe	CAHAA2C	CAA	CA65	CA65PLUSF33
		CAHAA2CA	CAA	CA65	CA65PLUSF33
		CAHAA2CB	CAA	CA65	CA65PLUSF33
		CAHAA2CC	CAA	CA65	CA65PLUSF33
2/0 Stranded	Flat (20" & larger pipe) 2-1/2" to 3-1/2" pipe 4" to 8" pipe 10" to 18" pipe	CAHAA2G	CAA	CA65	CA65PLUSF33
		CAHAA2GA	CAA	CA65	CA65PLUSF33
		CAHAA2GB	CAA	CA65	CA65PLUSF33
		CAHAA2GC	CAA	CA65	CA65PLUSF33

\* 1 sleeve per connection.

<sup>†</sup> Mold part number includes mold frame.

# nVent ERICO Cadweld Connections for Cathodic Protection

## Connections to Steel

### TYPE CAHC

Through conductor to top of horizontal STEEL pipe or flat surface.

NOTE: For DUCTILE IRON, see page 20.



CAHC – Cable on surface

Conductor Size	Surface	Mold Part Number†	Mold Price Key	Traditional Cadweld Weld Metal	Cadweld Plus Weld Metal
#14 to #10 Solid (use sleeve CAB1331H)* or #8 Solid or Stranded or #6 Solid	Flat (12" & larger pipe) 3/4" to 2" pipe 2-1/2" to 5" pipe 6" to 10" pipe	CAHCA1G	CAA	CA25	CA25PLUSF33
		CAHCA1GA	CAA	CA25	CA25PLUSF33
		CAHCA1GB	CAA	CA25	CA25PLUSF33
		CAHCA1GC	CAA	CA25	CA25PLUSF33
6 Stranded	Flat (12" & larger pipe) 3/4" to 2" pipe 2-1/2" to 5" pipe 6" to 10" pipe	CAHCA1H	CAA	CA25	CA25PLUSF33
		CAHCA1HA	CAA	CA25	CA25PLUSF33
		CAHCA1HB	CAA	CA25	CA25PLUSF33
		CAHCA1HC	CAA	CA25	CA25PLUSF33
4 Solid	Flat (12" & larger pipe) 3/4" to 2" pipe 2-1/2" to 5" pipe 6" to 10" pipe	CAHCA1K	CAA	CA25	CA25PLUSF33
		CAHCA1KA	CAA	CA25	CA25PLUSF33
		CAHCA1KB	CAA	CA25	CA25PLUSF33
		CAHCA1KC	CAA	CA25	CA25PLUSF33
4 Stranded	Flat (12" & larger pipe) 3/4" to 2" pipe 2-1/2" to 5" pipe 6" to 10" pipe	CAHCA1L	CAA	CA25	CA25PLUSF33
		CAHCA1LA	CAA	CA25	CA25PLUSF33
		CAHCA1LB	CAA	CA25	CA25PLUSF33
		CAHCA1LC	CAA	CA25	CA25PLUSF33
2 Solid	Flat (14" & larger pipe) 2" to 3-1/2" pipe 4" to 6" pipe 8" to 10" pipe	CAHCA1T	CAA	CA32	CA32PLUSF33
		CAHCA1TA	CAA	CA32	CA32PLUSF33
		CAHCA1TB	CAA	CA32	CA32PLUSF33
		CAHCA1TC	CAA	CA32	CA32PLUSF33
2 Stranded	Flat (18" & larger pipe) 2" to 3-1/2" pipe 4" to 8" pipe 10" to 16" pipe	CAHCA1V	CAA	CA45	CA45PLUSF33
		CAHCA1VA	CAA	CA45	CA45PLUSF33
		CAHCA1VB	CAA	CA45	CA45PLUSF33
		CAHCA1VC	CAA	CA45	CA45PLUSF33
1 Stranded	Flat (18" & larger pipe) 2" to 3-1/2" pipe 4" to 8" pipe 10" to 16" pipe	CAHCA1Y	CAA	CA45	CA45PLUSF33
		CAHCA1YA	CAA	CA45	CA45PLUSF33
		CAHCA1YB	CAA	CA45	CA45PLUSF33
		CAHCA1YC	CAA	CA45	CA45PLUSF33
1/0 Stranded	Flat (30" & larger pipe) 3" to 4" pipe 5" to 6" pipe 8" to 10" pipe 12" to 28" pipe	CAHCA2C	CAA	CA65	CA65PLUSF33
		CAHCA2CA	CAA	CA65	CA65PLUSF33
		CAHCA2CB	CAA	CA65	CA65PLUSF33
		CAHCA2CC	CAA	CA65	CA65PLUSF33
		CAHCA2CD	CAA	CA65	CA65PLUSF33
2/0 Stranded	Flat (30" & larger pipe) 3" to 4" pipe 5" to 6" pipe 8" to 10" pipe 12" to 28" pipe	CAHCA2G	CAA	CA65	CA65PLUSF33
		CAHCA2GA	CAA	CA65	CA65PLUSF33
		CAHCA2GB	CAA	CA65	CA65PLUSF33
		CAHCA2GC	CAA	CA65	CA65PLUSF33
		CAHCA2GD	CAA	CA65	CA65PLUSF33

\* 2 sleeves per connection.

† Mold part number includes mold frame.

# nVent ERICO Cadweld Connections for Cathodic Protection

## Connections to Steel

### TYPE CAVS

Tap conductor to vertical STEEL pipe or flat surface.  
NOTE: For DUCTILE IRON, see page 20.

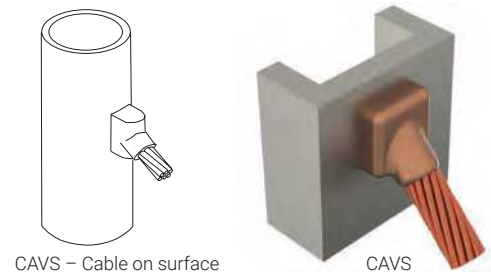

Conductor Size	Surface	Mold Part Number†	Mold Price Key	Traditional Cadweld Weld Metal	Cadweld Plus Weld Metal
#14 to #10 Solid (use sleeve CAB1331H)* or #8 Solid or Stranded, or #6 Solid	Flat (12" & larger pipe) 3/4" to 3-1/2" pipe 4" to 10" pipe	CAVST1G CAVST1GA CAVST1GB	CAT CAT CAT	CA15 CA15 CA15	CA15PLUSF33 CA15PLUSF33 CA15PLUSF33
6 Stranded	Flat (12" & larger pipe) 3/4" to 3-1/2" pipe 4" to 10" pipe	CAVST1H CAVST1HA CAVST1HB	CAT CAT CAT	CA15 CA15 CA15	CA15PLUSF33 CA15PLUSF33 CA15 PLUSF33
4 Solid	Flat (12" & larger pipe) 3/4" to 1-1/2" pipe 2" to 4" pipe 5" to 10" pipe	CAVST1K CAVST1KA CAVST1KB CAVST1KC	CAT CAT CAT CAT	CA25 CA25 CA25 CA25	CA25PLUSF33 CA25PLUSF33 CA25PLUSF33 CA25PLUSF33
4 Stranded	Flat (12" & larger pipe) 3/4" to 1-1/2" pipe 2" to 4" pipe 5" to 10" pipe	CAVST1L CAVST1LA CAVST1LB CAVST1LC	CAT CAT CAT CAT	CA25 CA25 CA25 CA25	CA25PLUSF33 CA25PLUSF33 CA25PLUSF33 CA25PLUSF33
2 Solid	Flat (14" & larger pipe) 1" to 1-1/2" pipe 2" to 4" pipe 5" to 12" pipe	CAVST1T CAVST1TA CAVST1TB CAVST1TC	CAT CAT CAT CAT	CA25 CA25 CA25 CA25	CA25PLUSF33 CA25PLUSF33 CA25PLUSF33 CA25PLUSF33
2 Stranded	Flat (14" & larger pipe) 1" to 1-1/2" pipe 2" to 3" pipe 4" to 8" pipe 8" to 12" pipe	CAVST1V CAVST1VA CAVST1VB CAVST1VC CAVST1VD	CAT CAT CAT CAT CAT	CA32 CA32 CA32 CA32 CA32	CA32PLUSF33 CA32PLUSF33 CA32PLUSF33 CA32PLUSF33 CA32PLUSF33
1 Stranded	Flat (18" & larger pipe) 1-1/2" to 2-1/2" pipe 3" to 4" pipe 5" to 10" pipe 12" to 16" pipe	CAVSP1Y CAVSP1YA CAVSP1YB CAVSP1YC CAVSP1YD	CAP CAP CAP CAP CAP	CA45 CA45 CA45 CA45 CA45	CA45PLUSF33 CA45PLUSF33 CA45PLUSF33 CA45PLUSF33 CA45PLUSF33
1/0 Stranded	Flat (18" & larger pipe) 2-1/2" to 4" pipe 5" to 10" pipe 12" to 16" pipe	CAVSP2C CAVSP2CA CAVSP2CB CAVSP2CC	CAP CAP CAP CAP	CA65 CA65 CA65 CA65	CA65PLUSF33 CA65PLUSF33 CA65PLUSF33 CA65PLUSF33
2/0 Stranded	Flat (18" & larger pipe) 3" to 4" pipe 5" to 10" pipe 12" to 16" pipe	CAVSP2G CAVSP2GA CAVSP2GB CAVSP2GC	CAP CAP CAP CAP	CA65 CA65 CA65 CA65	CA65PLUSF33 CA65PLUSF33 CA65PLUSF33 CA65PLUSF33

\* 1 sleeve per connection.

† Mold part number includes mold frame.



# nVent ERICO Cadweld Connections for Cathodic Protection

## Connections to Cast Iron

### TYPE CAVH

Type CAVH Tap conductor to vertical CAST IRON pipe or flat surface.

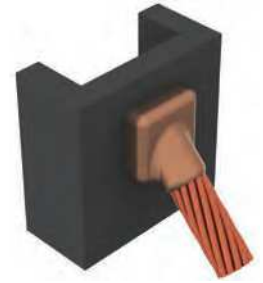

CAVH

Conductor Size	Surface	Mold Part Number†	Mold Price Key	Traditional Cadweld Weld Metal	Cadweld Plus Weld Metal
#14 to #10 Solid (use sleeve CAB1331H)** or #8 Solid or Stranded, or #6 Solid	Flat (30" & larger pipe) 4" to 24" pipe	CAVHT1G CAVHT1GPS.*	CAT CAT	CA25XF19 CA25XF19	CA25PLUSXF19 CA25PLUSXF19
6 Stranded	Flat (30" & larger pipe) 4" to 24" pipe	CAVHT1H CAVHT1HPS.*	CAT CAT	CA25XF19 CA25XF19	CA25PLUSXF19 CA25PLUSXF19
4 Solid	Flat (30" & larger pipe) 4" to 24" pipe	CAVHT1K CAVHT1KPS.*	CAT CAT	CA32XF19 CA32XF19	CA32PLUSXF19 CA32PLUSXF19
4 Stranded	Flat (30" & larger pipe) 4" to 24" pipe	CAVHT1L CAVHT1LPS.*	CAT CAT	CA32XF19 CA32XF19	CA32PLUSXF19 CA32PLUSXF19
2 Solid	Flat (30" & larger pipe) 4" to 24" pipe	CAVHP1T CAVHP1TPS.*	CAP CAP	CA45XF19 CA45XF19	CA45PLUSXF19 CA45PLUSXF19
2 Stranded	Flat (30" & larger pipe) 4" to 24" pipe	CAVHP1V CAVHP1VPS.*	CAP CAP	CA45XF19 CA45XF19	CA45PLUSXF19 CA45PLUSXF19
1 Stranded	Flat (36" & larger pipe) 4" to 30" pipe	CAVHP1Y CAVHP1YPS.*	CAP CAP	CA65XF19 CA65XF19	CA65PLUSXF19 CA65PLUSXF19

\* Specify pipe size. Example: For #2 stranded to 6" pipe, CAVHP1V6.

\*\* 1 sleeve per connection.

† Mold part number includes mold frame.

# nVent ERICO Cadweld Connections for Cathodic Protection

## Connections to Cast Iron

### TYPE CAHB

Type CAHB Tap conductor to top of horizontal CAST IRON pipe or flat surface.

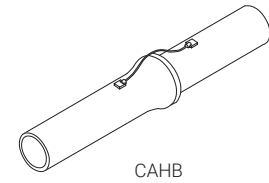

CAHB

Conductor Size	Surface	Mold Part Number <sup>†</sup>	Mold Price Key	Traditional Cadweld Weld Metal	Cadweld Plus Weld Metal
#14 to #10 Solid (use sleeve CAB1331H)** or #8 Solid or Stranded, or #6 Solid	Flat (30" & larger pipe) 4" to 24" pipe	CAHBA1G	CAA	CA25XF19	CA25PLUSXF19
		CAHBA1GPS.*	CAA	CA25XF19	CA25PLUSXF19
6 Stranded	Flat (30" & larger pipe) 4" to 24" pipe	CAHBA1H	CAA	CA25XF19	CA25PLUSXF19
		CAHBA1HPS.*	CAA	CA25XF19	CA25PLUSXF19
4 Solid	Flat (30" & larger pipe) 4" to 24" pipe	CAHBA1K	CAA	CA45XF19	CA45PLUSXF19
		CAHBA1KPS.*	CAA	CA45XF19	CA45PLUSXF19
4 Stranded	Flat (30" & larger pipe) 4" to 24" pipe	CAHBA1L	CAA	CA45XF19	CA45PLUSXF19
		CAHBA1LPS.*	CAA	CA45XF19	CA45PLUSXF19
2 Solid	Flat (30" & larger pipe) 4" to 24" pipe	CAHBA1T	CAA	CA45XF19	CA45PLUSXF19
		CAHBA1TPS.*	CAA	CA45XF19	CA45PLUSXF19
2 Stranded	Flat (30" & larger pipe) 4" to 24" pipe	CAHBA1V	CAA	CA45XF19	CA45PLUSXF19
		CAHBA1VPS.*	CAA	CA45XF19	CA45PLUSXF19
1 Stranded	Flat (30" & larger pipe) 4" to 24" pipe	CAHBA1Y	CAA	CA65XF19	CA65PLUSXF19
		CAHBA1YPS.*	CAA	CA65XF19	CA65PLUSXF19

\* Specify pipe size. Example: For #2 stranded to 6" pipe. (Type CAHB) CAHBA1V6, (Type CAHE) CAHEA1V6.

\*\* 1 Sleeve per connection for Type CAHB. 2 Sleeves per connection for Type CAHE.

† Mold part number includes mold frame.

### TYPE CAHE

Type CAHE Through conductor to top of horizontal CAST IRON pipe or flat surface.



CAHE

Conductor Size	Surface	Mold Part Number <sup>†</sup>	Mold Price Key	Traditional Cadweld Weld Metal	Cadweld Plus Weld Metal
#14 to #10 Solid (use sleeve CAB1331H)** or #8 Solid or Stranded, or #6 Solid	Flat (30" & larger pipe) 4" to 24" pipe	CAHEA1G	CAA	CA32XF19	CA32PLUSXF19
		CAHEA1GPS.*	CAA	CA32XF19	CA32PLUSXF19
6 Stranded	Flat (30" & larger pipe) 4" to 24" pipe	CAHEA1H	CAA	CA32XF19	CA32PLUSXF19
		CAHEA1HPS.*	CAA	CA32XF19	CA32PLUSXF19
4 Solid	Flat (30" & larger pipe) 4" to 24" pipe	CAHEA1K	CAA	CA45XF19	CA45PLUSXF19
		CAHEA1KPS.*	CAA	CA45XF19	CA45PLUSXF19
4 Stranded	Flat (30" & larger pipe) 4" to 24" pipe	CAHEA1L	CAA	CA45XF19	CA45PLUSXF19
		CAHEA1LPS.*	CAA	CA45XF19	CA45PLUSXF19
2 Solid	Flat (30" & larger pipe) 4" to 24" pipe	CAHEA1T	CAA	CA45XF19	CA45PLUSXF19
		CAHEA1TPS.*	CAA	CA45XF19	CA45PLUSXF19
2 Stranded	Flat (30" & larger pipe) 4" to 24" pipe	CAHEA1V	CAA	CA45XF19	CA45PLUSXF19
		CAHEA1VPS.*	CAA	CA45XF19	CA45PLUSXF19
1 Stranded	Flat (30" & larger pipe) 4" to 24" pipe	CAHEA1Y	CAA	CA65XF19	CA65PLUSXF19
		CAHEA1YPS.*	CAA	CA65XF19	CA65PLUSXF19

\* Specify pipe size. Example: For #2 stranded to 6" pipe. (Type CAHB) CAHBA1V6, (Type CAHE) CAHEA1V6.

\*\* 1 Sleeve per connection for Type CAHB. 2 Sleeves per connection for Type CAHE.

† Mold part number includes mold frame.

Do not use Types CAHB, CAHE, or CAVH on soil pipe (ASTM A74-82)

A test weld should be made on a section of the pipe being used to determine possibility of detrimental metallurgical effects. For DUCTILE IRON, see page 20.

# nVent ERICO Cadweld Connections for Cathodic Protection

## Connections to Ground Rods

### TYPE CAGR & CAGT



Ground Rod Size <sup>1</sup>	Conductor Size	STYLE GR				STYLE GT			
		Mold Part Number <sup>†</sup>	Mold Price Key	Traditional Cadweld Weld Metal	Cadweld Plus Weld Metal	Mold Part Number <sup>†</sup>	Mold Price Key	Traditional Cadweld Weld Metal	Cadweld Plus Weld Metal
Nominal 1/2" (Actual .475 Dia.)	#14 to #10 Solid (use sleeve CAB1331H)* or #8 Solid or Stranded, or #6 Solid	CAGRT151G	CAT	CA25	CA25PLUSF33	CAGTT151G	CAT	CA32	CA32PLUSF33
	6 Stranded	CAGRT151H	CAT	CA25	CA25PLUSF33	CAGTT151H	CAT	CA32	CA32PLUSF33
	4 Solid	CAGRT151K	CAT	CA25	CA25PLUSF33	CAGTT151K	CAT	CA32	CA32PLUSF33
	4 Stranded	CAGRT151L	CAT	CA25	CA25PLUSF33	CAGTT151L	CAT	CA32	CA32PLUSF33
	2 Solid	CAGRT151T	CAT	CA32	CA32PLUSF33	CAGTP151T	CAP	CA45	CA45PLUSF33
	2 Stranded	CAGRT151V	CAT	CA32	CA32PLUSF33	CAGTP151V	CAP	CA45	CA45PLUSF33
	1 Stranded	CAGRP151Y	CAP	CA45	CA45PLUSF33	CAGTP151Y	CAP	CA65	CA65PLUSF33
	1/0 Stranded	CAGRP152C	CAP	CA65	CA65PLUSF33	CAGTP152C	CAP	CA65	CA65PLUSF33
	2/0 Stranded	CAGRP152G	CAP	CA65	CA65PLUSF33	CAGTP152G	CAP	CA65	CA65PLUSF33
Nominal 5/8" (Actual .563 Dia.)	#14 to #10 Solid (use sleeve CAB1331H)* or #8 Solid or Stranded, or #6 Solid	CAGRT161G	CAT	CA32	CA32PLUSF33	CAGTP161G	CAP	CA45	CA45PLUSF33
	6 Stranded	CAGRT161H	CAT	CA32	CA32PLUSF33	CAGTP161H	CAP	CA45	CA45PLUSF33
	4 Solid	CAGRT161K	CAT	CA32	CA32PLUSF33	CAGTP161K	CAP	CA65	CA65PLUSF33
	4 Stranded	CAGRT161L	CAT	CA32	CA32PLUSF33	CAGTP161L	CAP	CA65	CA65PLUSF33
	2 Solid	CAGRP161T	CAP	CA45	CA45PLUSF33	CAGTP161T	CAP	CA65	CA65PLUSF33
	2 Stranded	CAGRP161V	CAP	CA45	CA45PLUSF33	CAGTP161V	CAP	CA65	CA65PLUSF33
	1 Stranded	CAGRP161Y	CAP	CA45	CA45PLUSF33	CAGTP161Y	CAP	CA65	CA65PLUSF33
	1/0 Stranded	CAGRP162C	CAP	CA65	CA65PLUSF33	CAGTN162C	CAN	2-CA45	N/A
	2/0 Stranded	CAGRP162G	CAP	CA65	CA65PLUSF33	CAGTN162G	CAN	2-CA45	N/A
Nominal 3/4" (Actual .682 Dia.)	#14 to #10 Solid (use sleeve CAB1331H)* or #8 Solid or Stranded, or #6 Solid	CAGRT181G	CAT	CA32	CA32PLUSF33	CAGTP181G	CAP	CA45	CA45PLUSF33
	6 Stranded	CAGRT181H	CAT	CA32	CA32PLUSF33	CAGTP181H	CAP	CA45	CA45PLUSF33
	4 Solid	CAGRP181K	CAP	CA45	CA45PLUSF33	CAGTP181K	CAP	CA65	CA65PLUSF33
	4 Stranded	CAGRP181L	CAP	CA45	CA45PLUSF33	CAGTP181L	CAP	CA65	CA65PLUSF33
	2 Solid	CAGRP181T	CAP	CA45	CA45PLUSF33	CAGTP181T	CAP	CA65	CA65PLUSF33
	2 Stranded	CAGRP181V	CAP	CA45	CA45PLUSF33	CAGTP181V	CAP	CA65	CA65PLUSF33
	1 Stranded	CAGRP181Y	CAP	CA45	CA45PLUSF33	CAGTP181Y	CAP	CA65	CA65PLUSF33
	1/0 Stranded	CAGRP182C	CAP	CA65	CA65PLUSF33	CAGTN182C	CAN	2-CA45	N/A
	2/0 Stranded	CAGRP182G	CAP	CA65	CA65PLUSF33	CAGTN182G	CAN	2-CA45	N/A

<sup>1</sup> For plain (unthreaded) copper-clad ground rods only. For threaded copper-clad rods or for steel rods, contact nVent for part number.

<sup>†</sup> Mold part number includes mold frame.

\* 1 sleeve per GR connection. 2 sleeves per GT connection.

# nVent ERICO Cadweld Connections for Cathodic Protection

## Connections of Cable to Cable

### TYPE CAPC



Type CAPC  
Tap cable to a through cable.  
Also see Type CATA, page 10

Conductor Size*		Mold Part Number†	Mold Price Key	Traditional Cadweld Weld Metal	Cadweld Plus Weld Metal
Run	Tap				
6 Stranded	6 Stranded	CAPCT1H1H	CAT	CA25	CA25PLUSF33
	6 Solid	CAPCT1H1G	CAT	CA25	CA25PLUSF33
	8 Stranded	CAPCT1H1E	CAT	CA25	CA25PLUSF33
	8 Solid	CAPCT1H1D	CAT	CA25	CA25PLUSF33
4 Stranded	4 Stranded	CAPCT1L1L	CAT	CA32	CA32PLUSF33
	6 Stranded	CAPCT1L1H	CAT	CA32	CA32PLUSF33
	6 Solid	CAPCT1L1G	CAT	CA32	CA32PLUSF33
	8 Stranded	CAPCT1L1E	CAT	CA32	CA32PLUSF33
	8 Solid	CAPCT1L1D	CAT	CA32	CA32PLUSF33
2 Stranded	2 Stranded	CAPCP1V1V	CAP	CA65	CA65PLUSF33
	4 Stranded	CAPCP1V1L	CAP	CA45	CA45PLUSF33
	6 Stranded	CAPCT1V1H	CAT	CA32	CA32PLUSF33
	6 Solid	CAPCT1V1G	CAT	CA32	CA32PLUSF33
	8 Stranded	CAPCT1V1E	CAT	CA32	CA32PLUSF33
	8 Solid	CAPCT1V1D	CAT	CA32	CA32PLUSF33
1 Stranded	2 Stranded	CAPCP1Y1V	CAP	CA65	CA65PLUSF33
	4 Stranded	CAPCP1Y1L	CAP	CA45	CA45PLUSF33
	6 Stranded	CAPCP1Y1H	CAP	CA45	CA45PLUSF33
	6 Solid	CAPCP1Y1G	CAP	CA45	CA45PLUSF33
	8 Stranded	CAPCP1Y1E	CAP	CA45	CA45PLUSF33
	8 Solid	CAPCP1Y1D	CAP	CA45	CA45PLUSF33
1/0 Stranded	2 Stranded	CAPCP2C1V	CAP	CA65	CA65PLUSF33
	4 Stranded	CAPCP2C1L	CAP	CA65	CA65PLUSF33
	6 Stranded	CAPCP2C1H	CAP	CA45	CA45PLUSF33
	6 Solid	CAPCP2C1G	CAP	CA45	CA45PLUSF33
	8 Stranded	CAPCP2C1E	CAP	CA45	CA45PLUSF33
	8 Solid	CAPCP2C1D	CAP	CA45	CA45PLUSF33
2/0 Stranded	2 Stranded	CAPCN2G1V	CAN	2-CA45	N/A
	4 Stranded	CAPCP2G1L	CAP	CA65	CA65PLUSF33
	6 Stranded	CAPCP2G1H	CAP	CA65	CA65PLUSF33
	6 Solid	CAPCP2G1G	CAP	CA65	CA65PLUSF33
	8 Stranded	CAPCP2G1E	CAP	CA65	CA65PLUSF33
	8 Solid	CAPCP2G1D	CAP	CA65	CA65PLUSF33

\* For #10 Solid through #14 Tap, use sleeve CAB1331H on wire in welder for #6 Stranded Tap.

† Mold part number includes mold frame.

### TYPE CASS

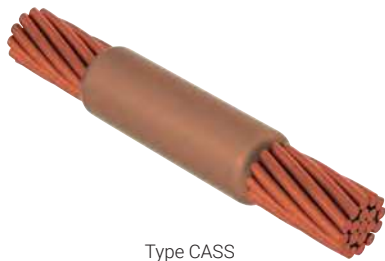

Type CASS  
Splice of conductors.

Conductor Size	Mold Part Number†	Mold Price Key	Traditional Cadweld Weld Metal	Cadweld Plus Weld Metal
12 Solid	CASST001	CAT	CA15	CA15PLUSF33
10 Solid	CASST1A	CAT	CA15	CA15PLUSF33
8 Solid	CASST1D	CAT	CA15	CA15PLUSF33
6 Solid	CASST1G	CAT	CA25	CA25PLUSF33
6 Stranded	CASST1H	CAT	CA25	CA25PLUSF33
4 Solid	CASST1K	CAT	CA25	CA25PLUSF33
4 Stranded	CASST1L	CAT	CA25	CA25PLUSF33
2 Solid	CASST1T	CAT	CA32	CA32PLUSF33
2 Stranded	CASST1V	CAT	CA32	CA32PLUSF33
1 Stranded	CASST1Y	CAT	CA32	CA32PLUSF33
1/0 Stranded	CASSP2C	CAP	CA45	CA45PLUSF33
2/0 Stranded	CASSP2G	CAP	CA65	CA65PLUSF33

† Mold part number includes mold frame.

# nVent ERICO Cadweld Connections for Cathodic Protection

## Connections of Cable to Cable

### TYPE CATA

Type CATA connections are available for any combination of run and tap conductor sizes. For small size taps, the Type CAPC is recommended. Contact your local distributor or nVent for additional information.

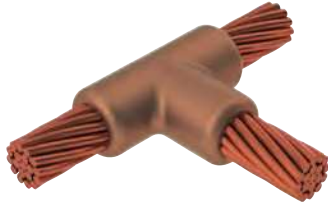

### Concentric Strand Copper Cable

Cable Size		Mold Part Number	Mold Price Key	Traditional Cadweld Weld Metal	Cadweld Plus Weld Metal
Run	Tap				
2	2	CATAN1VIV	CAN	CA45	CA45PLUSF33
	4	CATAN1V1L	CAN	CA45	CA45PLUSF33
1	1	CATAN1Y1Y	CAN	CA45	CA45PLUSF33
	2	CATAN1Y1V	CAN	CA45	CA45PLUSF33
	4	CATAN1Y1L	CAN	CA45	CA45PLUSF33
1/0	1	CATAN2C1Y	CAN	CA45	CA45PLUSF33
	2	CATAN2C1V	CAN	CA45	CA45PLUSF33
	4	CATAN2C1L	CAN	CA45	CA45PLUSF33
2/0	1	CATAN2G1Y	CAN	CA45	CA45PLUSF33
	2	CATAN2G1V	CAN	CA45	CA45PLUSF33
	4	CATAN2G1L	CAN	CA45	CA45PLUSF33

## Connections for Steel Anode Wire

Cadweld molds for use with steel anode wire available.

### CASS



Mold Part Number	Run	Tap	Mold Price Key	Traditional Cadweld Welding Material	Cadweld Plus Welding Material
CASSP2G135	2/0 concentric	.135 diameter steel wire	CAP	CA45	CA45PLUSF33
CASST007	.135 diameter steel wire	.135 diameter steel wire	CAT	CA15	CA15PLUSF33
CASST1V002	#2 Stranded wire	.130 diameter steel wire	CAT	CA25	CA25PLUSF33
CASST1V001	#2 Stranded wire	.185 diameter steel wire	CAT	CA25	CA25PLUSF33
CASST1351A	.135 diameter steel wire	#10 solid/#12 stranded with two CAB1331H	CAT	CA25	CA25PLUSF33
CASST1351H	.135 diameter steel wire	#6 stranded wire	CAT	CA25	CA25PLUSF33

### CAPG

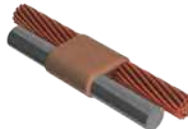

Mold Part Number	Run	Tap	Mold Price Key	Traditional Cadweld Welding Material	Cadweld Plus Welding Material
CAPGT1E003	#8 stranded wire	.135 diameter steel wire	CAT	CA25	CA25PLUSF33

### CAPT

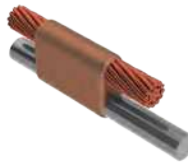

Mold Part Number	Run	Tap	Mold Price Key	Traditional Cadweld Welding Material	Cadweld Plus Welding Material
CAPTT002	.115 diameter steel wire	#8 stranded wire	CAT	CA25	CA25PLUSF33
CAPTT.1351E	.135 diameter steel wire	#8 stranded wire	CAT	CA25	CA25PLUSF33
CAPTC001	.135 diameter steel wire	#2 stranded wire	CAT	CA45	CA45PLUSF33

### CATA

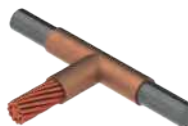

Mold Part Number	Run	Tap	Mold Price Key	Traditional Cadweld Welding Material	Cadweld Plus Welding Material
CATAP008	.130 diameter steel wire	.130 diameter steel wire	CAP	CA45	CA45PLUSF33
CATAP002	.135 diameter steel wire	.135 diameter steel wire	CAP	CA25	CA25PLUSF33

# nVent ERICO Cadweld Connections for Cathodic Protection

## Bonds

### BONDING STRAPS FOR PIPE THAWING

In colder climates, water distribution pipes occasionally freeze in the winter. To thaw the ice, a high current (for example, from a welding machine) is applied to heat the pipe and thaw the ice. To accomplish this, each pipe joint must be efficiently bonded to control the electrical path and to prevent burning the pipe gaskets. 3/4" wide copper bonding straps, welded to the pipe with Cadweld connections, provide the necessary bond or current path across the pipe joints. The bonding strips have been tested at over 500 amperes.

The straps may also be used to provide continuity for Cathodic protection or grounding systems.

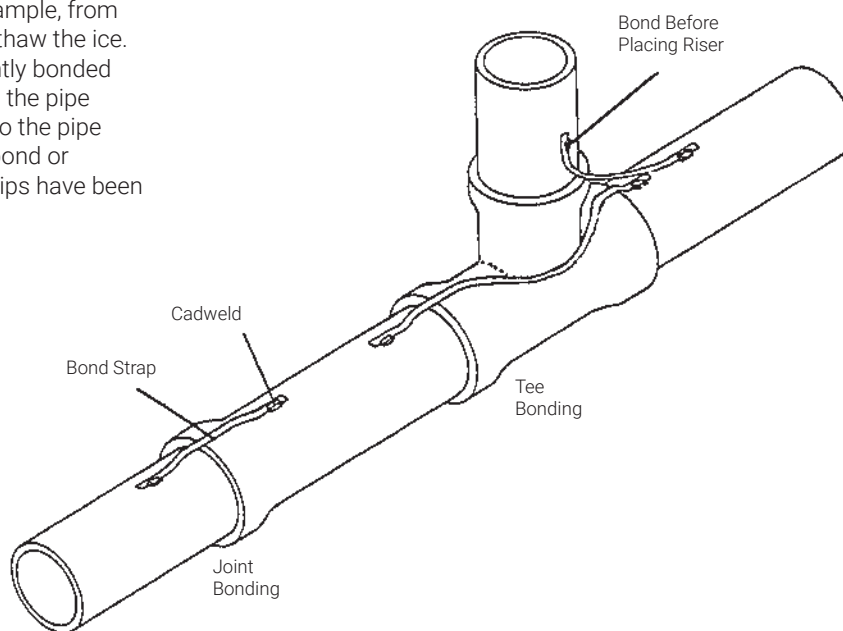

### Straps

Size	Part Number
1/16" x 3/4"	CAA817A - "L"
1/16" x 1"	CAA817B - "L"

L = Length in inches

### To Cast Iron or Ductile Iron Pipe

Pipe Size	1/16" x 3/4" Strap Mold Part Number <sup>†</sup>	1/16" x 1" Strap and Wider Mold Part Number <sup>†</sup>	Mold Price Key	Traditional Cadweld Weld Metal	Cadweld Plus Weld Metal
4" - 12"	CACHAADCA	CACHAAECA	CAA	CA32XF19	CA32PLUSXF19
14" - 30"	CACHAADCB	CACHAAECB	CAA	CA32XF19	CA32PLUSXF19
Over 30"	CACHAADC	CACHAAEC	CAA	CA32XF19	CA32PLUSXF19
As Specified #	CACHAADC(PS)*	CACHAAEC(PS)*	CAA	CA32XF19	CA32PLUSXF19

### To Steel Pipe

Pipe Size	1/16" x 3/4" Strap Mold Part Number <sup>†</sup>	1/16" x 1" Strap and Wider Mold Part Number <sup>†</sup>	Mold Price Key	Traditional Cadweld Weld Metal	Cadweld Plus Weld Metal
4" - 12"	CACHAADSA	CACHAAESA	CAA	CA32	CA32PLUSF33
14" - 30"	CACHAADSB	CACHAAESB	CAA	CA32	CA32PLUSF33
Over 30"	CACHAADS	CACHAAES	CAA	CA32	CA32PLUSF33
As Specified #	CACHAADS(PS)*	CACHAAES(PS)*	CAA	CA32	CA32PLUSF33

<sup>†</sup> Mold part number includes mold frame.

<sup>#</sup> When only one pipe size is involved, order mold to fit that pipe size.

\* Add pipe size (PS).

# nVent ERICO Cadweld Connections for Cathodic Protection

## Bonds

### "PUNCHED STRAP" BOND FOR STEEL PIPE

The Cadweld "Punched Strap" Bond allows bonding across joints of steel pipe with a bond of approximately 1/0 AWG size using a CA15 Weld Metal. This allows larger size bonds on steel pressure pipe covered by ANSI/ASME B31. (See page 19).

The Punched Strap bond is fabricated from 1/16" x 1-1/4" soft copper, allowing easy hand forming over the pipe coupling.

The 5-hole model is used on "Dresser Type" pipe couplings with two welds to the pipe and three to the coupling, made through the holes.

A 2-hole model (the 'B' dimensions are zero) is used across standard mechanical joints or across "Dresser Type" joints when the coupling does not have to be bonded.



### Cathodic Bonding Strap, 5 Holes

Part Number	Length L	Width W	Thickness T	Hole Size HS	A	B	C
CAB496A15B25	22"	1 1/4"	1/16"	1/2"	3 3/4"	6 1/4"	1"
CAB496A16B16	18"	1 1/4"	1/16"	1/2"	4"	4"	1"
CAB496A24B12	20"	1 1/4"	1/16"	1/2"	6"	3"	1"

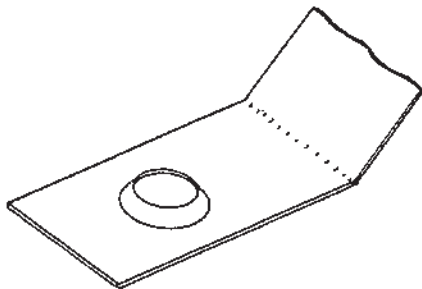
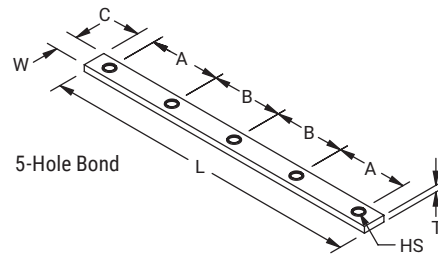

### Cathodic Bonding Strap, 2 Holes

Part Number	Length L	Width W	Thickness T	Hole Size HS	A	B
CAB496A32B0	10"	1 1/4"	1/16"	1/2"	8"	1"
CAB496A36B0	11"	1 1/4"	1/16"	1/2"	9"	1"
CAB496A44B0	13"	1 1/4"	1/16"	1/2"	11"	1"
CAB496A64B0	18"	1 1/4"	1/16"	1/2"	16"	1"

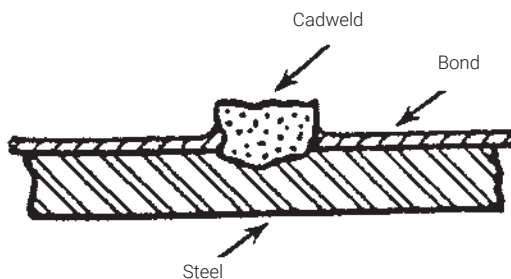
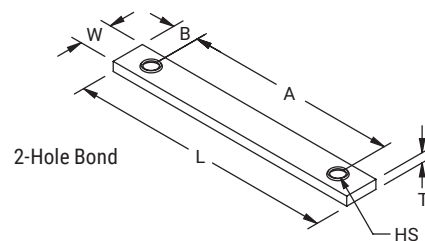

### Ordering Information

- A. BOND; CAB496A B  
 "B" dimension } in fourths } 1-3/8"  
 "A" dimension } of an inch } min.
- Example: a) 5-hole bond  
 A = 3-3/4" (15 fourths); B = 6-1/4" (25 fourths)  
 P/N CAB496A15B25  
 b) 2-hole bond  
 A = 16" (64 fourths); B = 0" (0 fourths)  
 P/N CAB496A64B0
- B. Cadweld Bond;  
 a) Mold with frame/Handle P/N CAHAAAF  
 b) Replacement Mold ONLY P/N CAHAAAFM
- C. Cadweld Weld Metal;  
 CA15

# nVent ERICO Cadweld Connections for Cathodic Protection

## Bonds

### FORMED TERMINAL

#### Factory made bonds

Bonds with terminals formed on the ends are often used for bonding pipe joints and fittings. The formed terminal allows a smaller weld metal size to be used.

Conductor Size	Insulated Bond Part Number	Bare Bond Part Number
#2	CAF11V – length in inches	CAF21V – length in inches
1/0	CAF12C – length in inches	CAF22C – length in inches
2/0	CAF12G – length in inches	CAF22G – length in inches

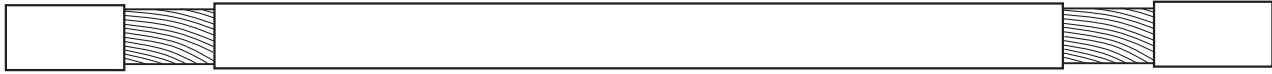

#### Field made bonds

Formed Terminal Bonds may be made in the field using sleeves (one per conductor end) and forming them in the hammer dies listed.

Conductor Size	Sleeve Part Number	Hammer Die Part Number
#4	CAS20F	JD11
#2	CAS09F	JD09
1/0	CAS05F	JD05
2/0	CAS03F	JD03

### WELDERS FOR FORMED TERMINAL BONDS

#### Type CAFS Welders for Steel Pipe.

For DUCTILE IRON, see page 20.

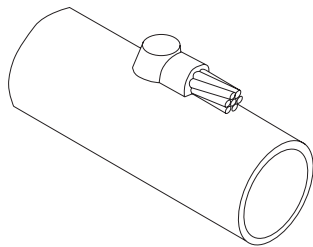

Conductor Size	Surface	Mold Part Number†	Mold Price Key	Traditional Cadweld Weld Metal	Cadweld Plus Weld Metal
#4	Flat (10" & larger pipe)	CAFSA1L	CAA	CA25	CA25PLUSF33
	4" pipe	CAFSA1LA	CAA	CA25	CA25PLUSF33
	6 to 8" pipe	CAFSA1LB	CAA	CA25	CA25PLUSF33
#2	Flat (10" & larger pipe)	CAFSA1V	CAA	CA25	CA25PLUSF33
	4" pipe	CAFSA1VA	CAA	CA25	CA25PLUSF33
	6 to 8" pipe	CAFSA1VB	CAA	CA25	CA25PLUSF33
1/0	Flat (12" & larger pipe)	CAFSA2C	CAA	CA32	CA32PLUSF33
	4" pipe	CAFSA2CA	CAA	CA32	CA32PLUSF33
	6 to 10" pipe	CAFSA2CB	CAA	CA32	CA32PLUSF33
2/0	Flat (12" & larger pipe)	CAFSA2G	CAA	CA45	CA45PLUSF33
	4" pipe	CAFSA2GA	CAA	CA45	CA45PLUSF33
	6 to 10" pipe	CAFSA2GB	CAA	CA45	CA45PLUSF33

\* Indicate pipe size.

† Mold part number includes mold frame.

#### Type CAFC Welders for Cast Iron Pipe.

Do not use on soil pipe. (ASTM A74-82).

A test weld should be made on a section of the pipe being used to determine possibility of detrimental metallurgical effects.

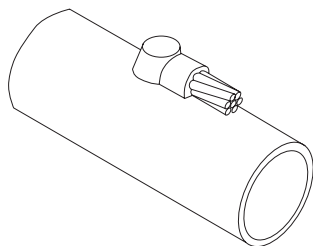

Conductor Size	Surface	Mold Part Number†	Mold Price Key	Traditional Cadweld Weld Metal	Cadweld Plus Weld Metal
#4	Flat (30" & larger pipe)	CAFCA1L	CAA	CA32XF19	CA32PLUSXF19
	4" to 24" pipe	CAFCA1LPS*	CAA	CA32XF19	CA32PLUSXF19
#2	Flat (30" & larger pipe)	CAFCA1V	CAA	CA32XF19	CA32PLUSXF19
	4" to 24" pipe	CAFCA1VPS*	CAA	CA32XF19	CA32PLUSXF19
1/0	Flat (30" & larger pipe)	CAFCA2C	CAA	CA45XF19	CA45PLUSXF19
	4" to 24" pipe	CAFCA2CPS*	CAA	CA45XF19	CA45PLUSXF19
2/0	Flat (36" & larger pipe)	CAFCA2G	CAA	CA65XF19	CA65PLUSXF19
	4" to 30" pipe	CAFCA2GPS*	CAA	CA65XF19	CA65PLUSXF19

\* Indicate pipe size.

† Mold part number includes mold frame.



# nVent ERICO Cadweld Connections for Cathodic Protection

## Bonds

### FORMED TERMINAL WITH PIGTAILS

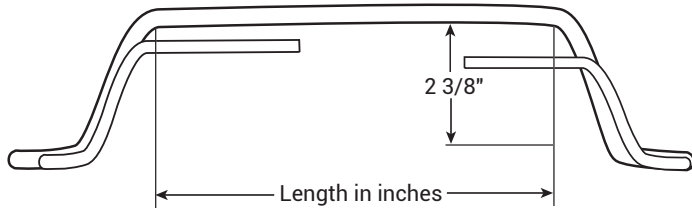

#### FACTORY MADE BONDS with Pigtails for "Dresser Type" Pipe Couplings

Insulated, formed terminal bonds with insulated pigtails are used to bond across the joint and to bond both the middle ring and follower ring of Dresser Type Couplings.

Conductor Size	Pigtail Size	Bond Part Number
#2	#12 Solid	CAD11V-length in inches
1/0	8 Solid	CAD12C-length in inches

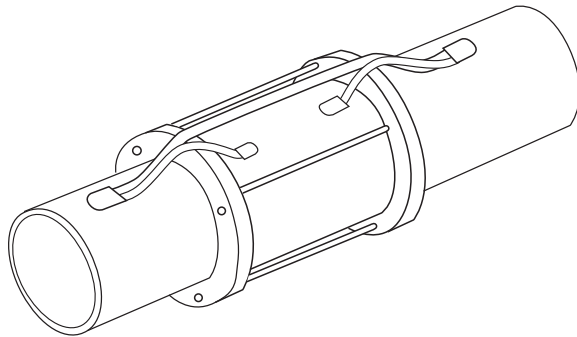

Type CADS Welders for Steel Pipe

#### Type DC Welders for CAST IRON Pipe

Do not use on soil pipe. (ASTM A-74-82).

A test weld should be made on a section of the pipe being used to determine possibility of detrimental metallurgical effects.

For DUCTILE IRON, See page 20.

Bond <sup>1</sup>	Pipe Size	Terminal Welder			Pigtail Welder			
		Mold Part Number <sup>†</sup>	Traditional Cadweld Weld Metal	Cadweld Plus Weld Metal	Mold Part Number <sup>†</sup>	Traditional Cadweld Weld Metal	Cadweld Plus Weld Metal	
<b>TYPE CADS WELDERS FOR STEEL PIPE</b>								
CAD11V (#2)	4" pipe	CADSA1VA	CA25	}	CA25PLUSF33	CAHAA1G	CA15	CA15PLUSF33
	6" to 8" pipe	CADSA1VB	CA25		CA25PLUSF33			
	10" & larger pipe	CADSA1V	CA25		CA25PLUSF33			
CAD12C (1/0)	4" pipe	CADSA2CA	CA32	}	CA32PLUSF33	CAHAA1D	CA15	CA15PLUSF33
	6" to 10" pipe	CADSA2CB	CA32		CA32PLUSF33			
	12" & larger pipe	CADSA2C	CA32		CA32PLUSF33			
<b>TYPE CADS WELDERS FOR CAST IRON PIPE</b>								
CAD11V (#2)	4 to 24" pipe	CADCA1VARP.*	CA32XF19	CA32PLUSXF19	CAHBA1GPS.*	CA25XF19	CA25PLUSXF19	
	30" & larger pipe	CADCA1V	CA32XF19	CA32PLUSXF19	CAHBA1G	CA25XF19	CA25PLUSXF19	
CAD12C (1/0)	4 to 24" pipe	CADCA2CPS.*	CA45XF19	CA45PLUSXF19	CAHBA1DPS.*	CA25XF19	CA25PLUSXF19	
	30" & larger pipe	CADCA2C	CA45XF19	CA45PLUSXF19	CAHBA1D	CA25XF19	CA25PLUSXF19	

\* Add pipe size. Example: CADCA1V12 for 12" pipe.

<sup>†</sup> Mold part number includes mold frame.

<sup>1</sup> For factory made bonds listed above.

# nVent ERICO Cadweld Connections for Cathodic Protection

## Welders and Molds

### Cadweld Welders And Molds

When making a Cadweld connection, an accurate control of the Cadweld process is accomplished by using a semi-permanent graphite mold. Control is exercised over the direction and speed of the molten Cadweld weld metal flow and final shape. The graphite used in a Cadweld mold is a high temperature type that lasts for an average of 50 to 100 Cadweld connections under normal usage.

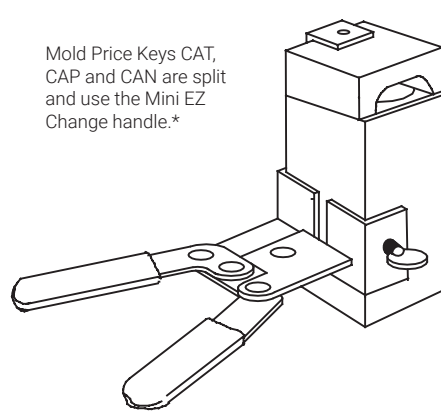

Mold Price Keys CAT, CAP and CAN are split and use the Mini EZ Change handle.\*

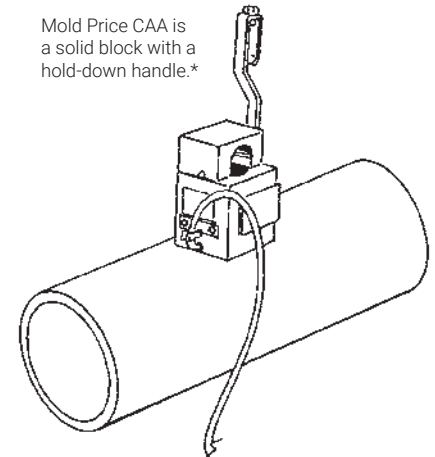

Mold Price CAA is a solid block with a hold-down handle.\*

\* Mold part number includes mold frame.

## Weld Metal

### Cadweld Weld Metal

Mixture consists mainly of copper oxide and aluminum. Specifically used in cathodic protection applications on cable to steel or stainless steel. Color coding by size for easy identification.

Two types of Cadweld weld metal are used for Cathodic protection connections:

1. F33 alloy is used for all connections of cable to cable and cable to steel or stainless steel pipe. The F33 weld metal containers have green caps.
2. XF19 alloy is used for all connections to cast iron. XF19 weld metal containers have orange caps.

NOTE: For DUCTILE IRON, see page 20.

### Cadweld Plus Welding Material



### Traditional Cadweld Welding Material



Cadweld Plus Welding Material	Box	Standard Pack
CA15PLUSF33	20	100
CA25PLUSF33	20	100
CA32PLUSF33	20	100
CA45PLUSF33	20	100
CA65PLUSF33	20	100
CA25PLUSXF19	20	100
CA32PLUSXF19	20	100
CA45PLUSXF19	20	100
CA65PLUSXF19	20	100

Traditional Cadweld Welding Material*	Box	Standard Pack
CA15	20	100
CA25	20	100
CA32	20	100
CA45	20	100
CA65	20	100
CA25XF19	20	100
CA32XF19	20	100
CA45XF19	20	100
CA65XF19	20	100

\* Disks are included.

# nVent ERICO Cadweld Connections for Cathodic Protection

## Tools and Materials



### Mold Cleaner B136A

Mold Cleaners are useful for removing the slag from CAA molds after making a Cadweld connection.

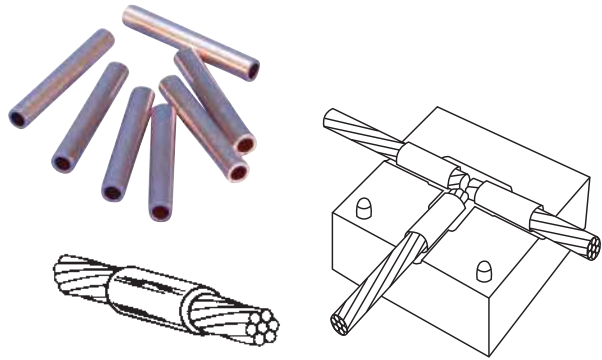

### Adapter Sleeves

Small conductors may be built up to fit the opening of larger size welders using either adapter sleeves or shim stock.

Cable Size		Use Adapter Sleeve Part Number	Use in Mold for Conductor Size	
Stranded	Solid		Stranded	Solid
#12, 14	#10, 12, 14	CAB1331H	#6	#6
10	8, 10	CAB1331K	--	4
7, 8, 10	6, 8	CAB1331L	4	--
6	5	CAB112	2	--

Adapter sleeves can be used when a limited number of connections are to be made with a smaller conductor in a larger welder.



### Torch Head T111

Self-igniting propane torch head. Squeeze the control knob for an instant flame. Release and it's out. No flame adjusting. And, the burn tip remains cool during normal use. Operates on its side or upside down. Can withstand 60-MPH winds without flareout. Saves fuel. Safer to use. Fits all standard 14 and 16 oz. propane cylinders.



### Magnetic Assembly B323N2

Powerful welding magnet securely positions the mold during the connection process to a flat steel surface or steel pipe. Helps with mold stability to reduce the chance of welding material leakage. Quickly and easily attaches to hold down "A" Price Key molds.

# nVent ERICO Cadweld Connections for Cathodic Protection

## Tools and Materials

Extension Flint Ignitor

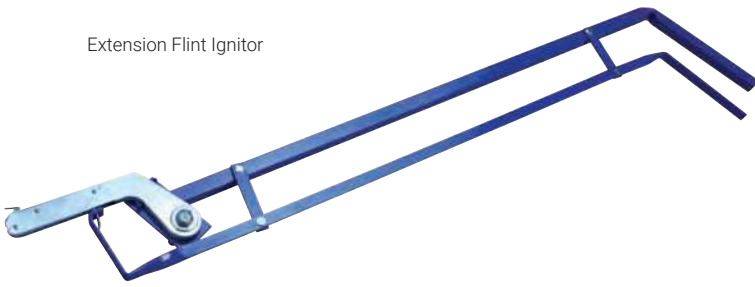

Lead Holding Clip

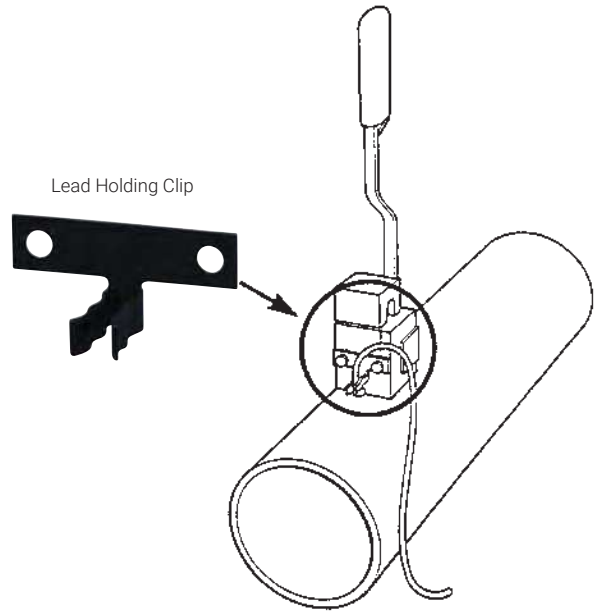

Cat. No.	Description
B32130	Extension including Flint Ignitor (30 inches long)
T320	Replacement Flint Ignitor Only
T320A	Replacement Flints
B322	Lead Holding Clip - Fits all CAA Price Welders

### B319 Vertical Pipe Clamp

Holds the welder to a vertical pipe while the Cadweld connection is made. Fits all CAN, CAP or CAT price welders and pipes to 6 inches.



### B320 Horizontal Pipe Clamp

Holds the welder to a horizontal pipe while the Cadweld connection is made. Fits all CAA price welders and pipes to 6 inches.

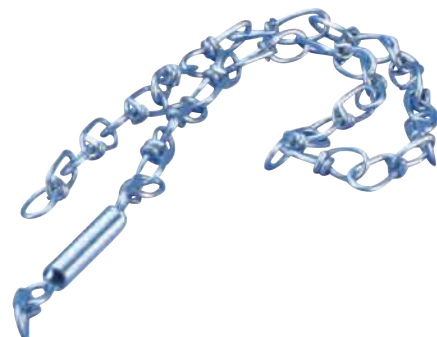

# nVent ERICO Cadweld Connections for Cathodic Protection

## Tools and Materials

### Tool Boxes And Tools

Item	Part Number
Cadweld Plus Impulse Exothermic Welding Control Unit	PLUSCU2L6
Tool boxes only	T396
Complete kit box and tools	T343 <sup>1</sup>
RASP	T321
Replacement blade for Rasp	T321A
Flint Ignitor	T320
Screw Driver	T305
Crimping Tool	T335
Disk Container	T328
Card Cloth Brush	T313
File and Handle	T329
Mold Sealer	T403

Tools also available separately.

<sup>1</sup>Uses tool box T396



PLUSCU2L6



T396



Brush

The **T313** Card Cloth Brush is used to clean all types of copper conductors. Its short stiff bristles provide for easy removal of oxides.



T321



T329



T320



T305



T328



T335



Mold Sealer

Mold Sealer is required around the cable on outside of the Cadweld mold for Types CAHA, CAHB, CAHC, and CAHE.

**T403** - 2# Package

# nVent ERICO Cadweld Connections for Cathodic Protection

## Technical Information

### PIPING CODE

#### Cadweld CONNECTIONS TO PIPELINES

1. The American Society of Mechanical Engineers\* (ASME) publishes codes relating to the design and installation of pressure piping systems:
  - 1.1. ANSI/ASME B31.8- 2018, GAS TRANSMISSION AND DISTRIBUTION PIPING SYSTEMS.
  - 1.2. ANSI/ASME B31.4- 1998, LIQUID TRANSPORTATION SYSTEMS FOR HYDROCARBONS, LIQUID PETROLEUM GAS, ANHYDROUS AMMONIA, AND ALCOHOLS.
2. In both, under Corrosion Control, the standard allows the attachment of electrical leads using exothermic welding but limits the size of the weld metal used to:
  - 2.1. CA15 for steel pipe.<sup>†</sup>
  - 2.2. CA32XF19 for cast, wrought and ductile iron pipe.
3. These restrictions allow for the welding of #4 AWG and smaller wire to steel pipe using Cadweld Cathodic Type CAHA connections and #6 AWG and smaller to cast, wrought, and ductile iron using Type CAHB connections.

When larger sized conductors must be attached to pressure piping systems covered by these codes, several alternative solutions are available:

- 3.1. Using a Formed Terminal Bond (page 13), a #2 AWG can be welded to cast, wrought and ductile iron with a CA32XF19.
- 3.2. Using a Cadweld Bonding Strap (page 11), a 1/6" x 1" copper strip (equivalent to slightly smaller than a #1 AWG) can be welded to a cast, wrought and ductile iron pipe with a CA32XF19.
- 3.3. The "Punched Strap" Bond (page 12) (1/16" x 1-1/4" copper, equivalent to slightly less than a 1/0 AWG) can be welded to steel pipe using a CA15. The 5-hole model is used for "Dresser Type" couplings and the 2-hole model for standard joints.
- 3.4. The strands of a larger 7 strand conductor can be spread and each strand welded separately (figure 1) as noted in the following table:

\* Available from: The American Society of Mechanical Engineers  
United Engineering Center, 345 East 47th Street, New York, NY 10017.

<sup>†</sup> Ref. ANSI/ASME B31.8 2018.

Figure 1  
Thermite welding of larger  
7-STRAND cable to pipeline

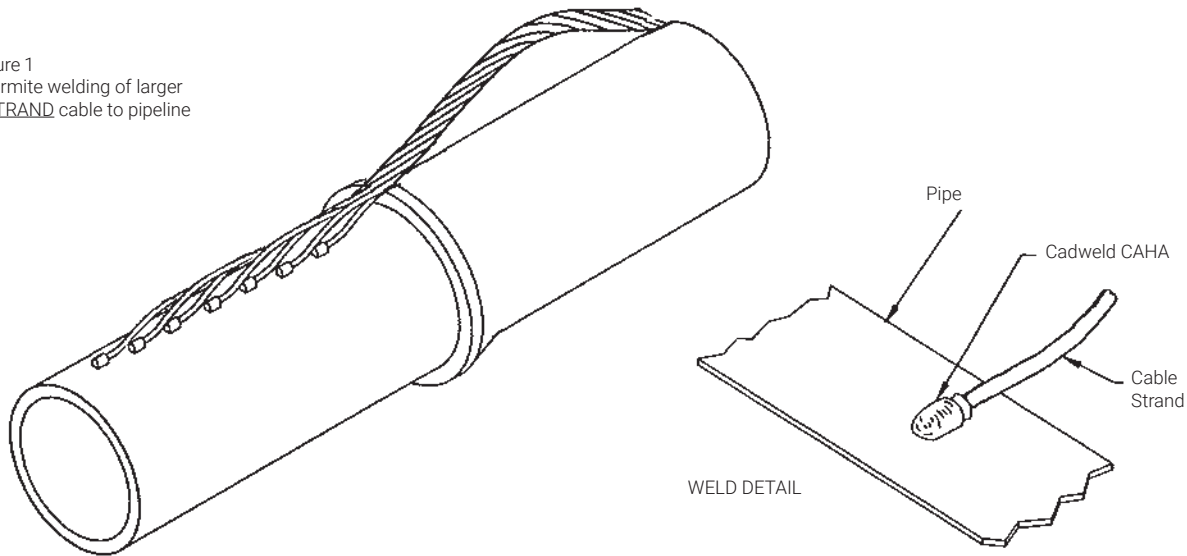

Conductor 7 Strand	Welder For Each Strand For Steel Pipe	Traditional Cadweld Weld Metal	Cadweld Plus Weld Metal
4/0	CAHAA1H	CA15	CA15PLUSF33
3/0 to #1	CAHAA1G	CA15	CA15PLUSF33
#2 to #4	CAHAA1G with sleeve CAB1331H	CA15	CA15PLUSF33

# nVent ERICO Cadweld Connections for Cathodic Protection

## Technical Information

### CADWELD CONNECTIONS AND PIPE WALL THICKNESS

The following is a discussion of the minimum pipe size required for safe installation of Cadweld Cathodic Connections considering of the service conditions and without special factory testing. Several things must be considered as outlined below.

For a particular wall thickness:

- The hoop stress in the pipe will increase as the pipe diameter increases.
- The heat dissipation will be affected by the thermal characteristics of the material in the pipe.
- The heat dissipation will be affected by the rate of flow of the material through the pipe while making the weld.
- The pipe strength will be affected by the temperature of the pipe (material temperature).
- Any internal coating of the pipe must be checked to find if the temperature of the pipe directly under the weld will adversely affect it.

Based on a minimum wall thickness of 0.109 inches\* (2.769 mm) and using a CA15 Weld Metal (the maximum allowed to oil or gas piping systems per ANSI/ASME B31.4 and B31.8), the minimum recommended pipe size and schedule is:

Nominal Pipe Size	Schedule	Wall Thickness (inches)	Wall Thickness (mm)
1/2 inch	40	0.109	2.8
3/4 inch	40	0.113	2.9
1 to 2 inches	10	0.109	2.8
2 1/2 to 4 inch	10	0.120	3.0
5 to 8 inch	5	0.109	2.8
10 inch and larger	5	0.134 and above	3.4 and above

Tests made by operating gas companies indicate no damage to a 4" Grade 52 pipe having a 0.109" wall when making a weld to the pipe at 500 psig using a CA15. Welds made to a steel plate 0.109" thick had a maximum copper penetration depth of less than 0.010". Other tests on tubes with a 0.125" or 0.150" wall showed a copper penetration of 0.005" maximum.

### DUCTILE IRON

Tests by nVent indicate that connections to DUCTILE IRON pipe can be made using the Cadweld molds and weld metal designated to be used on steel pipe.

However, some reports from the field suggest that all ductile iron is not the same. In some cases the material for steel will not work. In such cases, the molds and weld material for cast iron do work.

We therefore, suggest:

- Whenever possible, make tests on the ductile iron pipe being used to determine if the material for steel can be used.

**-OR-**

- Use the material for cast iron. It will make satisfactory connections on all ductile iron.

# nVent ERICO Cadweld Connections for Cathodic Protection

## Cross Reference

Thermoweld Part Number	Cadweld Part Number
M100	CAHAA1G
M101	CAHAA1GA
M102	CAHAA1H
M103	CAHAA1HA
M104	CAHAA1K
M105	Call nVent
M106	CAHAA1L
M107	CAHAA1LA
M108	Call nVent
M109	CAHAA1T
M110	CAHAA1TA
M111	Call nVent
M112	CAHAA1V
M113	CAHAA1VA
M114	CAHAA1VA
M115	CAHAA1VB
M116	CAHAA1Y
M117	CAHAA1YA
M118	Call nVent
M119	Call nVent
M120	CAHAA2C
M121	CAHAA2CA
M122	Call nVent
M123	CAHAA2CC
M124	CAHAA2G
M125	Call nVent
M126	CAHAA2GB
M127	CAHAA2GC
M142	CAVST1G
M150	CAVST1GA
M151	CAVST1GB
M144	CAVST1H
M152	CAVST1HA
M153	CAVST1HB
M145	CAVST1K
M186	CAVST1KA
M187	CAVST1KB
M188	CAVST1KC

Thermoweld Part Number	Cadweld Part Number
M146	CAVST1L
M189	CAVST1LA
M190	CAVST1LB
M191	CAVST1LC
M147	CAVST1T
M192	CAVST1TA
M193	CAVST1TB
M194	CAVST1TC
M148	CAVST1V
M195	CAVST1VA
M196	CAVST1VB
M197	CAVST1VC
M198	CAVST1VD
M2586	CAVSP2C
M2587	CAVSP2CA
M2588	CAVSP2CB
M2589	CAVSP2CC
M2590	CAVSP2G
M2591	CAVSP2GA
M2592	CAVSP2GB
M2593	CAVSP2GC
M156	CAHBA1G
M157	CAHBA1H
M158	CAHBA1K
M159	CAHBA1L
M160	CAHBA1T
M161	CAHBA1V
M162	Call nVent
M163	CAHBA1Y
M164	Call nVent
M165	Call nVent
M2594S	CAVHT1G
M2594	CAVHT1H
M2595S	CAVHT1K
M2595	CAVHT1L
M2596S	CAVHP1T
M2596	CAVHP1V
M2597S	Call nVent

Thermoweld Part Number	Cadweld Part Number
M2597	CAVHP1Y
M2598	Call nVent
M2599	Call nVent
M1960	CAGRT151H
M1961	CAGRT151L
M1962	CAGRT151V
M1963	CAGRT151Y
M1964	CAGRT152C
M1965	CAGRT152G
M1968	CAGRT161H
M1969	CAGRT161L
M1970	CAGRP161V
M1971	CAGRP161Y
M1972	CAGRP162C
M1973	CAGRP162G
M1974	CAGRT181G
M1975	CAGRT181G
M1976	CAGRT181H
M1977	CAGRP181L
M1978	CAGRP181V
M1979	CAGRP181Y
M1980	CAGRP182C
M1981	CAGRP182G
M1982	CAGTT151G
M1983	CAGTT151G
M1984	CAGTT151H
M1985	CAGTT151L
M1986	CAGTP151V
M1987	CAGTP151Y
M1988	CAGTP152C
M1989	CAGTP152G
M1990	CAGTP161G
M1991	CAGTP161G
M1992	CAGTP161H
M1993	CAGTP161L
M1994	CAGTP161V
M1995	CAGTP161Y
M1996	CAGTN162C



# nVent ERICO Cadweld Connections for Cathodic Protection

## Cross Reference

Thermoweld Part Number	Cadweld Part Number
M1997	CAGTN162G
M1998	CAGTP181G
M1999	CAGTP181G
M2000	CAGTP181H
M2001	CAGTP181L
M2002	CAGTP181V
M2003	CAGTP181Y
M2004	CAGTN182C
M2005	CAGTN182G
M1927	CAPGT12CU
M1928	CAPGT10CU
M1929	CAPGT08CU
M1930	CAPGT06CU
M1931	CAPGT1G1D
M1932	CAPGT06CU
M1933	CAPGT1G1D
M1934	CAPGT1H1H
M1935	CAPGT1L1E
M1936	CAPGT1L1H
M1937	CAPGT1L1L
M1938	CAPGT1V1E
M1939	CAPGT1V1H
M1940	CAPGP1V1L
M1941	CAPGP1V1V
M1942	CAPGP1Y1E
M1943	CAPGP1Y1H
M1944	CAPGP1Y1L
M1945	CAPGP1Y1Y
M1946	CAPGP2C1E
M1947	CAPGP2C1H
M1948	CAPGP2C1L
M1949	CAPGP2C2C
M1950	CAPGP2G1E
M1951	CAPGP2G1H
M1952	CAPGP2G1L
M1953	CAPGN2G2G
15P	CA15
15PS	CA15S

Thermoweld Part Number	Cadweld Part Number
25P	CA25
32P	CA32
45P	CA45
65P	CA65
15PCI	CA15XF19
25PCI	CA25XF19
32PCI	CA32XF19
45PCI	CA45XF19
65PCI	CA65XF19
A200	CAB1331H
A201	CAB1331L
A202	CAB112
A203	B1332C
A204	B1332L
A205	B1332Q
A206	B1332G
A304	CAT329
A305	CAT336
A306	CAT313
A309P	CAT320
A309PI	T320A
A320	B117A
B101	CAT321
B101P	CAT321A

# nVent ERICO Cadweld Connections for Cathodic Protection

## Cadweld Applications

### **Buried Cast or Ductile Iron Pipelines**

Secure your investment by specifying the Cadweld Process for Cathodic Protection connections. The Cadweld exothermic welding process produces a molecular bond to the surface of the pipe. Cadweld connections are permanent and ensure the highest degree of electrical continuity, eliminating the potential for corrosion problems.

### **Vertical Steel Applications**

nVent makes Cathodic Protection easy for even the most difficult vertical steel applications. We offer a comprehensive line of magnetic clamps, attachments and tools specifically engineered for the challenges of vertical steel.

### **Reinforced Concrete Protection**

Chloride contamination of reinforcing steel in concrete structures plagues many cold climate communities. To arrest corrosion, engineers specify Cathodic Protection systems for concrete road bridges and parking structures. Cadweld connections can be easily made to uneven surfaces of reinforcing steel rods for lasting protection.

### **Copper Cable Connections**

Mechanical connections for electrical cable loosen and deteriorate with age. For superior performance, specify Cadweld exothermic connections to assure a permanent, molecular bond between connecting cables for full conductivity.

# Equipotential Bonding

**Equipment Ground Plates**  
**Pg 105**



**Ground Bars**  
**Pgs 97-102**



**Ground Plates**  
**Pgs 92-96**

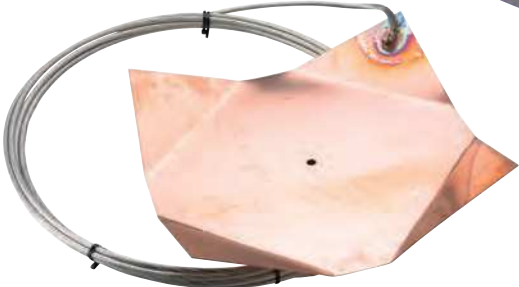

**Fence Assembly**  
**Pgs 116-118**



**SRG**  
**Pgs 108**

# Ground Plates

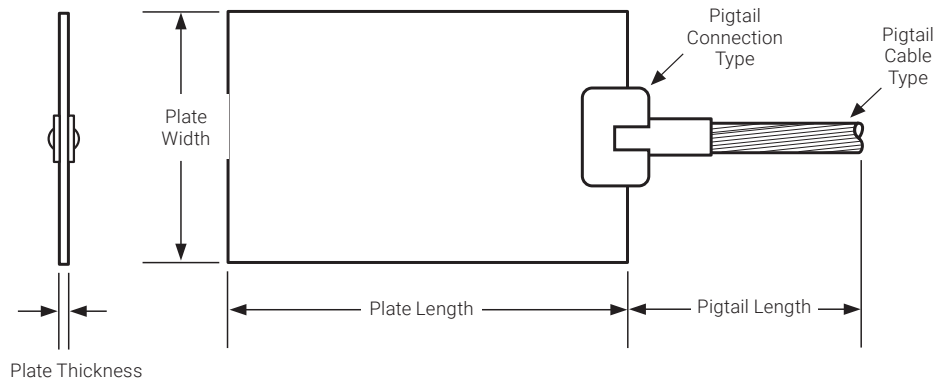

## Terminated Pigtails

**Part Number:** G P E C E A H 0 2 4 1 L 0 2 4 (T)

Ground Plate Electrode → G  
 Material → P  
 Pigtail Connection Type → E  
 Plate Thickness Code (Stock Tolerance) → A  
 Plate Width Code → H  
 Plate Length Code (inches) (3 digits required) → 024  
 Pigtail Cable Type (nVent ERICO Cable Code) → 1L  
 Pigtail Length (inches) → 024  
 T = Tinned → (T)

**Example: GPECEAH0241L024**

Pigtail Connection Type	
C	Continuous (2 x "L J" nVent ERICO Conn.)
E	End ("L J" nVent ERICO Conn. Style)
N	No Pigtail

Plate Thickness Code	
A	1/32" (Min. for Lightning – Cu)
B	1/16" (Min. for Power – Cu)
C	3/32"
D	1/8"
E	1/4" (Min. for Power – Stl.)
F	3/8"
G	1/2"
H	1/64" (26 Gauge)
J	3/16"

### CADWELD CABLE CODES – BARE, CONCENTRIC STRANDED COPPER CONDUCTOR

2Q	4/0 Stranded	1Y	#1 Stranded	1H	#6 Stranded
2L	3/0 Stranded	1V	#2 Stranded	1E	#8 Stranded
2G	2/0 Stranded	1Q	#3 Stranded	1B	#10 Stranded
2C	1/0 Stranded	1L	#4 Stranded		

### CADWELD CABLE CODES – BARE, SOLID COPPER CONDUCTOR

2P	4/0 Solid	1X	#1 Solid	1G	#6 Solid
2K	3/0 Solid	1T	#2 Solid	1D	#8 Solid
2F	2/0 Solid	1P	#3 Solid	1A	#10 Solid
2B	1/0 Solid	1K	#4 Solid		

# Ground Plates

## COPPER GROUND PLATES WITHOUT PIGTAILS



Part Number	Thickness (in)	Width (in)	Length (in)
GPECNEK024	1/4	24	24
GPECNBH024	1/16	12	24
GPECNDM036T	1/8	36	36
GPECNEB024	1/4	2	24
GPECNDK024T	1/8	24	24
GPECNAK024	1/32	24	24
GPECNDF006	1/8	6	6
GPECNEB024	1/4	2	24
GPECNEK024	1/4	24	24
GPECNEM040	1/4	36	40

## COPPER GROUND PLATES WITH TERMINATED, WELDED PIGTAILS

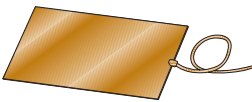

Part Number	Thickness (in)	Width (in)	Length (in)	Cable Code	Cable Size	Pigtail Length (in)
GPECEEK0242Q008	1/4"	24"	24"	2Q	4/0 Stranded	8"
GPECEEK0242Q120	1/4"	24"	24"	2Q	4/0 Stranded	120"
GPECEEK0361T024	1/4"	24"	36"	1T	#2 Solid	24"
GPECEDK0242Q036	1/8"	24"	24"	2Q	4/0 Stranded	36"
GPECEAH0241L024	1/32	12	24	1L	#4 Stranded	24
GPECEAH0241T024	1/32	12	24	1T	#2 Solid	24
GPECEAH0242Q024	1/32	12	24	2Q	4/0 Stranded	24
GPECEAJ0181G024	1/32	18	18	1G	#6 Solid	24
GPECEAJ0182Q024	1/32	18	18	2Q	4/0 Stranded	24
GPECEAJ0241G024	1/32	18	24	1G	#6 Solid	24
GPECEAK0241G024	1/32	24	24	1G	#6 Solid	24
GPECEAK0241H024	1/32	24	24	1H	#6 Stranded	24
GPECEAK0241T024	1/32	24	24	1T	#2 Solid	24
GPECEAK0241V024	1/32	24	24	1V	#2 Stranded	24
GPECEAK0241Y024	1/32	24	24	1Y	#1 Stranded	24
GPECEAK0242G024	1/32	24	24	2G	2/0 Stranded	24
GPECEAK0242Q024	1/32	24	24	2Q	4/0 Stranded	24
GPECEAK0242V024	1/32	24	24	2V	250 MCM Stranded	24
GPECEAM0362Q024	1/32	36	36	2Q	4/0 Stranded	24
GPECEAP0481H024	1/32	48	48	1H	#6 Stranded	24
GPECEBH0121V024	1/16	12	12	1V	#2 Stranded	24
GPECEBH0122G024	1/16	12	12	2G	2/0 Stranded	24
GPECEBH0241K024	1/16	12	24	1K	#4 Solid	24
GPECEBH0242G024	1/16	12	24	2G	2/0 Stranded	24
GPECEBH0242L024	1/16	12	24	2L	3/0 Stranded	24
GPECEEK0242Q060	1/4	24	24	2Q	4/0 Stranded	60
GPECEEK0361T024	1/4	24	36	1T	#2 Solid	24

Contact nVent ERICO for additional product configurations.

# Ground Plates

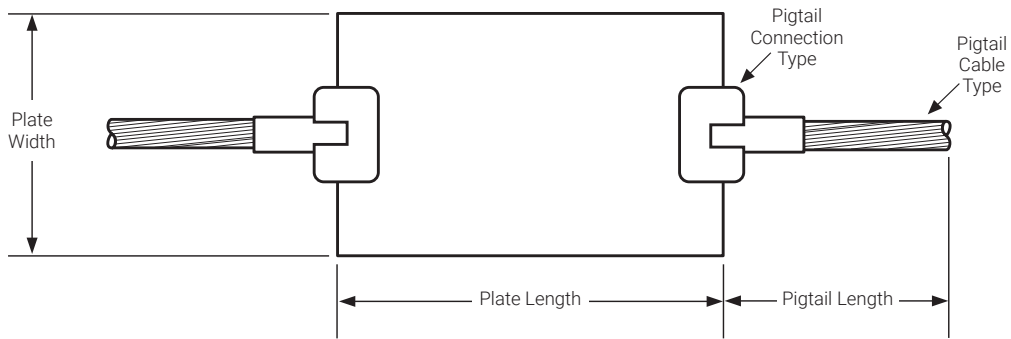

## Through Pigtail

**Part Number:** G P E C E A H 0 2 4 1 L 0 2 4 ( T )

Ground Plate Electrode → G  
 Material → P  
 Pigtail Connection Type → E  
 Plate Thickness Code (Stock Tolerance) → C  
 Plate Width Code → E  
 Plate Length Code (inches) (3 digits required) → A  
 Pigtail Cable Type (nVent ERICO Cable Code) → H  
 Pigtail Length (inches) → 0  
 T = Tinned → 2

**Example: GPECEAH0241L024**

Pigtail Connection Type	
C	Continuous (2 x "L J" nVent ERICO Conn.)
E	End ("L J" nVent ERICO Conn. Style)
N	No Pigtail

Plate Thickness Code	
A	1/32" (Min. for Lightning – Cu)
B	1/16" (Min. for Power – Cu)
C	3/32"
D	1/8"
E	1/4" (Min. for Power – Stl.)
F	3/8"
G	1/2"
H	1/64" (26 Gauge)
J	3/16"

### CADWELD CABLE CODES – BARE, CONCENTRIC STRANDED COPPER CONDUCTOR

2Q	4/0 Stranded	1Y	#1 Stranded	1H	#6 Stranded
2L	3/0 Stranded	1V	#2 Stranded	1E	#8 Stranded
2G	2/0 Stranded	1Q	#3 Stranded	1B	#10 Stranded
2C	1/0 Stranded	1L	#4 Stranded		

### CADWELD CABLE CODES – BARE, SOLID COPPER CONDUCTOR

2P	4/0 Solid	1X	#1 Solid	1G	#6 Solid
2K	3/0 Solid	1T	#2 Solid	1D	#8 Solid
2F	2/0 Solid	1P	#3 Solid	1A	#10 Solid
2B	1/0 Solid	1K	#4 Solid		

# Ground Plates

## COPPER GROUND PLATES WITH WELDED, THROUGH PIGTAILS

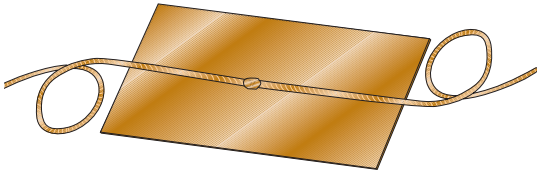

Part Number	Thickness (in)	Width (in)	Length (in)	Cable Code	Cable Size	Pigtail Length (in)
GPECCBJ0181T060	1/16	18	18	1T	#2 Solid	60
GPECCA0242Q024	1/32	12	24	2Q	4/0 Stranded	24
GPECCA0181V024	1/32	18	18	1V	#2 Stranded	24
GPECCA0242Q024	1/32	18	24	2Q	4/0 Stranded	24
GPECCAJ0361L024	1/32	18	36	1L	#4 Stranded	24
GPECCAK0241L024	1/32	24	24	1L	#4 Stranded	24
GPECCAK0241T024	1/32	24	24	1T	#2 Solid	24
GPECCAM0362C024	1/32	36	36	2C	1/0 Stranded	24
GPECCAM0362Q024	1/32	36	36	2Q	4/0 Stranded	24
GPECCBH0122Q024	1/16	12	12	2Q	4/0 Stranded	24
GPECCBH0242G024	1/16	12	24	2G	2/0 Stranded	24
GPECCBK0242C036	1/4	24	24	2C	1/0 Stranded	36

## COPPER UTILITY POLE BOTTOM PLATES



EGP100

Part Number	Description	Thickness (in)	Diameter (in)	Conductor Size Range
EGP100	Utility Pole-Bottom Plate with Lug*	.025	7.5	#14 Solid – #4 Stranded

\* RUS Approved

## COPPER GROUND PLATE WITH BENT CORNERS AND WELDED PIGTAIL



Part Number	Thickness (in)	Width (in)	Length (in)	Cable Size	Pigtail Length (ft)
GPECEHX1T	0.064	17	17	#6 Solid	10
GPECEHX3	0.064	17	17	#2 Concentric	10
GPECEHX4	0.064	17	17	#4 Concentric	35

GPECEHX4 has nVent ERICO Cu-bond Composite Conductor for theft deterrence

# Ground Plates

## COPPER UTILITY GROUND PLATES

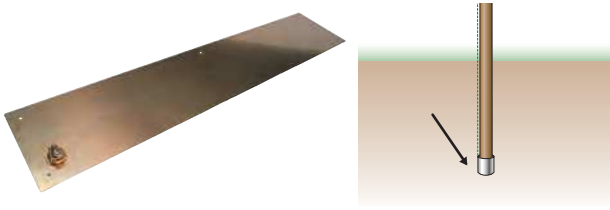

Part Number	Description	Thickness (in)	Width (in)	Length (in)
UGP719	Utility Ground Plate with SRGC46 Connector*	1/16	7.5	19.25
UGP719BP5	Utility Ground Plate with Connector, quantity of 5 per package	1/16	7.5	19.25
UGP719SBP5	Utility Ground Plate with ESB2 Split Bolt	1/16	7.5	19.25
UGP738	Utility Ground Plate with SRGC46 Connector*	1/16	7.5	38.5
UGP738P5	Utility Ground Plate with SRGC46 Connector, quantity of 5*	1/16	7.5	38.5
UGP738SBP5	Utility Ground Plate with ESB2 Split Bolt	1/16	7.5	38.5

\*SRGC46 Connector (for Signal Reference Grids) can be used for #4 solid – #6 stranded AWG.

## STEEL GROUND PLATES



- CSA Listed for Canada and US

Part Number	Description	Thickness (in)	Width (in)	Length (in)
EGGP	Galvanized Steel Ground Plate, without Connector	1/4	10	16
EGGPC	Galvanized Steel Ground Plate, with HDC58 Connector	1/4	10	16



# Ground Bar

Proper bonding is essential to create an equipotential plane between service grounds and equipment during fault and transient conditions. This equipotential plane provides a near zero voltage differential and serves to protect people and equipment during these events. The most popular bonding product in use today is the ground bar or bonding bar. Ground bars provide a convenient, single-point grounding and bonding location. Conductors are welded to the bar using a Cadweld exothermic connection or are mechanically fastened by using lugs.

nVent ERICO can design and manufacture custom bars. In addition, the breadth of the product offering includes TMGB bars, which meet the requirements of TIA®/EIA® 607 and conform to BICSI® recommendations. Our perimeter bus system allows for fast and easy field installation of halo and other perimeter grounding schemes.

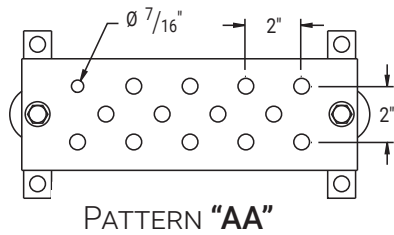

PATTERN "AA"

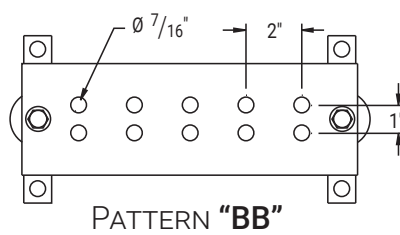

PATTERN "BB"

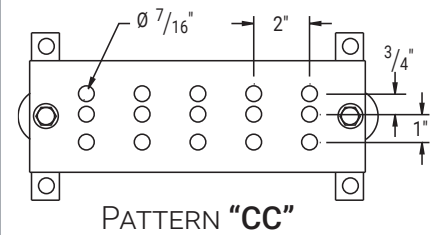

PATTERN "CC"

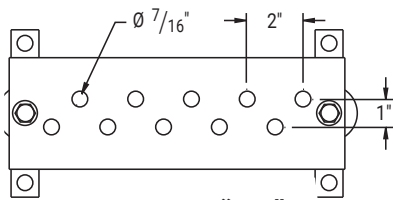

PATTERN "DD"

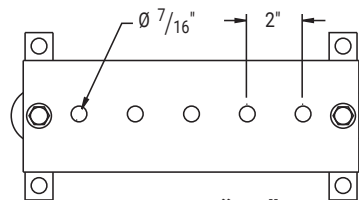

PATTERN "EE"

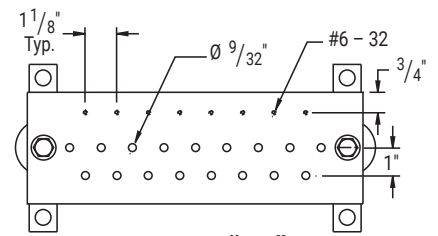

PATTERN "FF"

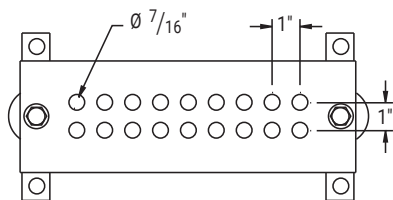

PATTERN "GG"

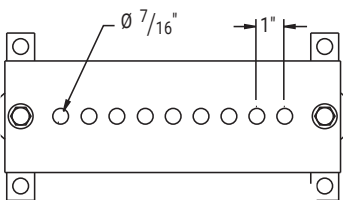

PATTERN "HH"

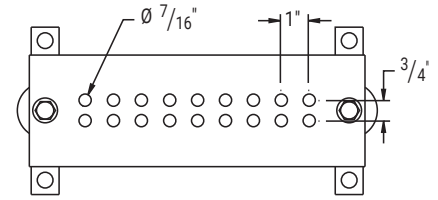

PATTERN "JJ"

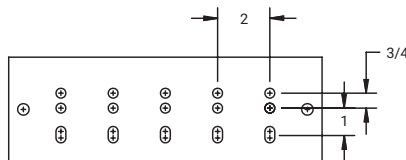

PATTERN "KK"

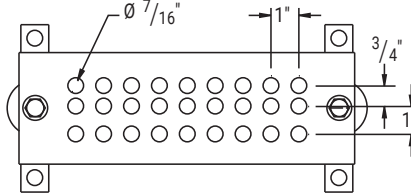

PATTERN "LL"

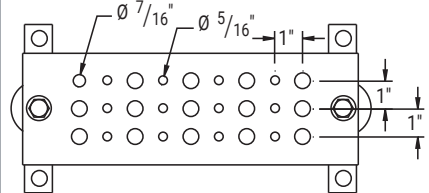

PATTERN "MM"

# Ground Bar

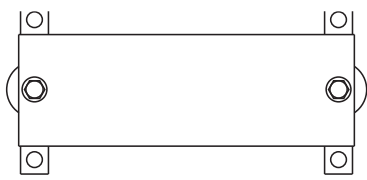
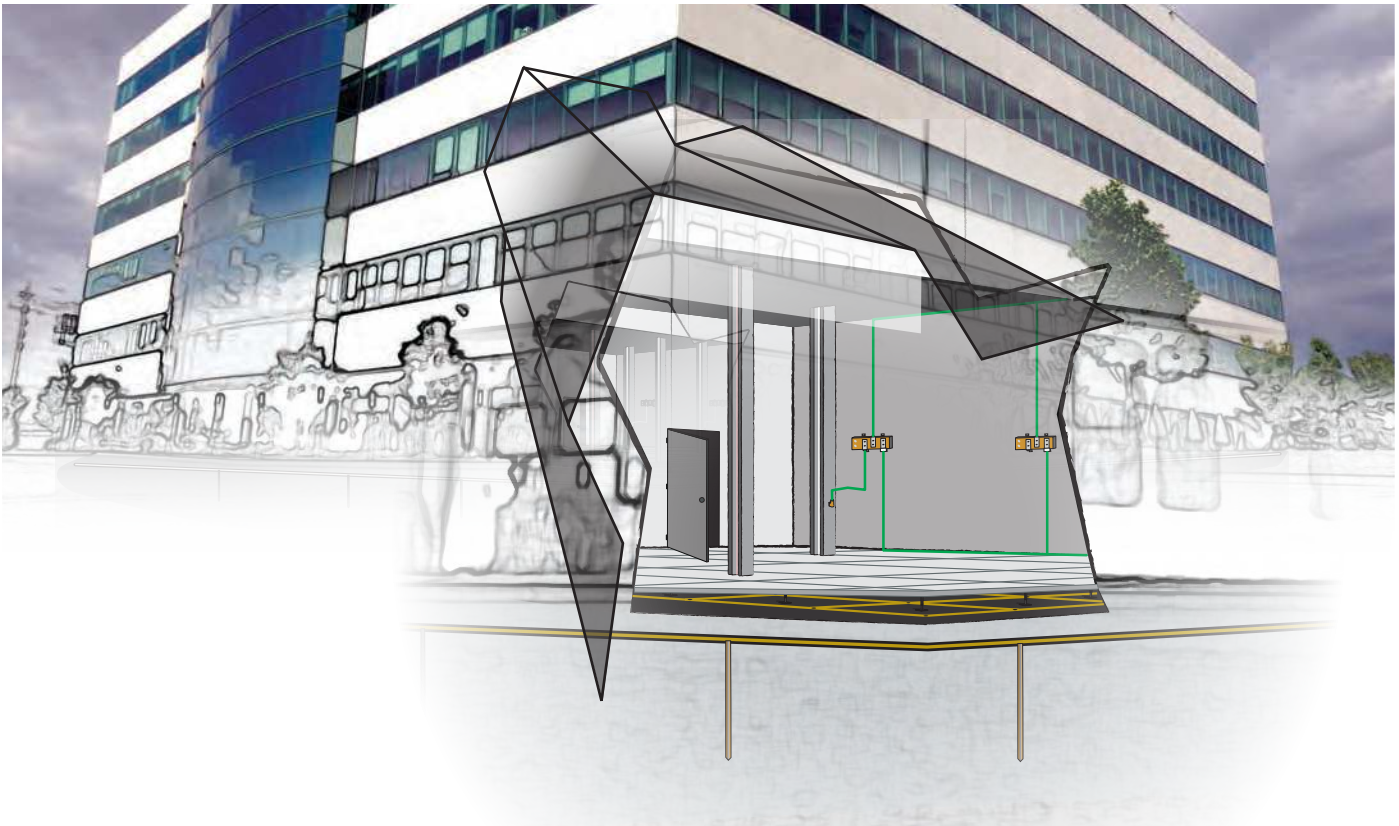

PATTERN "NN"

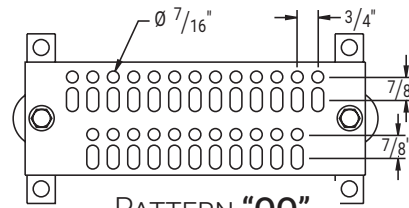

PATTERN "QQ"

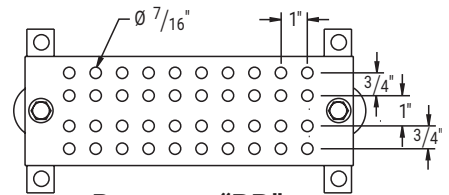

PATTERN "RR"

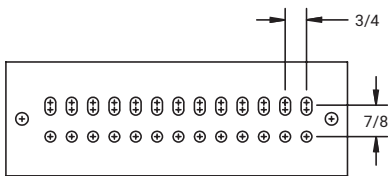

PATTERN "SS"

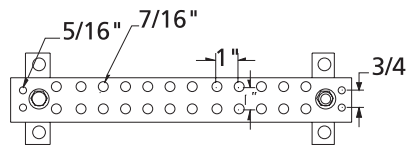

PATTERN "TES"

# Ground Bars

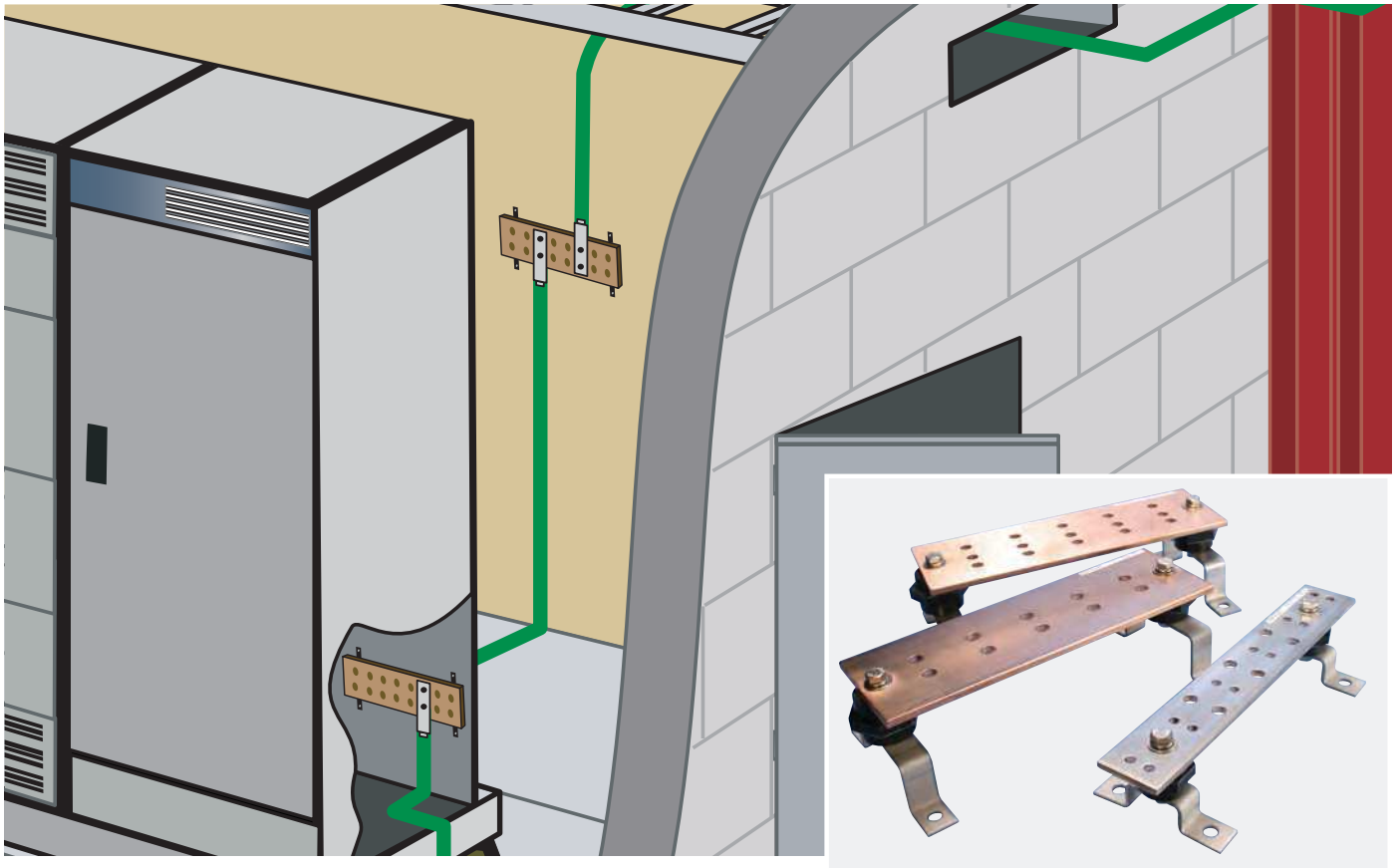

**E G B A 1 4 4 1 2 C C**

nVent ERICO  
Ground Bar  
Designation

**Configuration**

A = Insul & Brkt    C = None (Bar only)  
B = Brkt only        D = Insul only  
F = Insul, Brkt, Cover & Hdw

**Thickness**

14 = 1/4"    38 = 3/8"    12 = 1/2"

**Width**

1 = 1"    4 = 4"  
2 = 2"    5 = 5"  
3 = 3"    6 = 6"

**Pig Tail Length Ft.** (Empty if none)

A = 1    E = 5    J = 9    N = 16    S = 24    W = 32  
B = 2    F = 6    K = 10    O = 17    T = 25    X = 34  
C = 3    G = 7    L = 11    P = 18    U = 26    Y = 36  
D = 4    H = 8    M = 12    Q = 19    V = 27    Z = 38

**nVent ERICO Cable Code** (Empty if none)

1K = #4 Sol Tin    2C = 1/0    2V = 250 KCM  
1T = #2 Sol Tin    SG = 2/0    3D = 350 KCM  
                          2L = 3/0    3Q = 500 KCM  
                          2Q = 4/0    4L = 750 KCM

**Tin Plating**  
(Empty if none)

T = Tinned

**Hole Pattern**

**Length** (rounded to the nearest inch, up to 96 inch max.)

# Ground Bars

## COMMONLY STOCKED COPPER GROUNDING BUS BARS\* WITH INSULATORS & BRACKETS

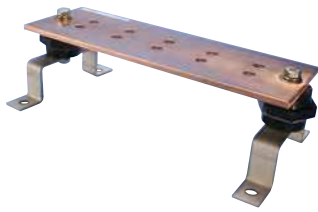

Part Number	Thickness (in)	Width (in)	Length (in)	Hole Pattern
<b>2" wide bar</b>				
EGBA14212BB	1/4	2	12	BB
EGBA14212EE	1/4	2	12	EE
EGBA14212GG	1/4	2	12	GG
EGBA14212HH	1/4	2	12	HH
EGBA14215JJ	1/4	2	15	JJ
<b>4" wide bar</b>				
EGBA14410FF	1/4	4	10	FF
EGBA14412AA	1/4	4	12	AA
EGBA14412BB	1/4	4	12	BB
EGBA14412CC	1/4	4	12	CC
EGBA14412GG	1/4	4	12	GG
EGBA14412LL	1/4	4	12	LL
EGBA14418CC	1/4	4	18	CC
EGBA14420CC	1/4	4	20	CC
EGBA14424CC	1/4	4	24	CC
EGBA14424GG	1/4	4	24	GG
EGBA14424LL	1/4	4	24	LL
EGBA14424MM	1/4	4	24	MM

\* Also available using pre-tinned copper bar. Add "T" to the part number.

## QQ PATTERN, COPPER AND TINNED COPPER GROUNDING BUS BARS WITH INSULATORS & BRACKETS

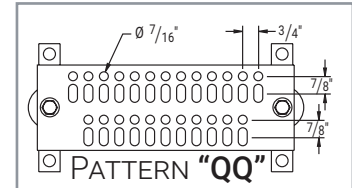
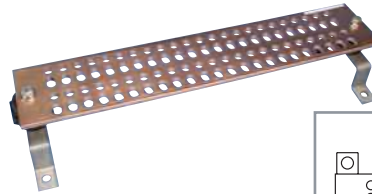

Part Number	Thickness (in)	Width (in)	Length (in)	Hole Pattern	Plating
EGBA14412QQT	1/4	4	12	QQ	Tinned
EGBA14420QQ	1/4	4	20	QQ	Copper
EGBA14420QQT	1/4	4	20	QQ	Tinned
EGBA14424QQ	1/4	4	24	QQ	Copper
EGBA14424QQT	1/4	4	24	QQ	Tinned

### Field Fabrication Ground Bars

Part Number	Thickness (in)	Width (in)	Length (in)
ECB14212	1/4	2	12
ECB14224	1/4	2	24
ECB14412	1/4	4	12
ECB14424	1/4	4	24
ECB142144	1/4	2	144
ECB144144	1/4	4	144

\*non-UL listed, bare copper bars, no holes

### Ground Bars with Plexiglass Covers

Part Number	Thickness (in)	Width (in)	Length (in)	Finish	Cover
EGBF14406LL	1/4	4	6	N	Y
EGBF14412LL	1/4	4	12	N	Y
EGBF14416LL	1/4	4	16	N	Y
EGBF14424CC	1/4	4	24	N	Y
EGBF14436CC	1/4	4	36	N	Y
EGBF14448CC	1/4	4	48	N	Y

## MOUNTING KITS



- Include stainless steel hardware, 3/8" fasteners, insulators and brackets
- cULus® listed

Part Number	Description
B548A39	Mounting kit for steel beam
B548A41	Mounting kit for 1" & 2" wide bars
B548A42	Mounting kit for 3" & 4" wide bars

## GROUND BAR INSULATORS



- UL Recognized for Canada and US
- Fiberglass reinforced thermoset polyester

Part Number	Height (in)	Diameter (in) (A)	Thread Size
559600	1	1-1/8	1/4 - 20 x 5/16
559620	1-1/4	1-5/8	1/4 - 20 x 5/16
559660	1-1/2	2	3/8 - 16 x 3/8
559685	2-1/8	2-1/2	5/8 - 11 x 5/8
559686	2-1/4	2-1/2	1/2 - 13 x 5/8
559687	2-1/4	2-1/2	3/8 - 16 x 5/8

# Telecom Ground Bars

## TGB & TMGB Telecom Ground Bars

- UL® listed; meet TIA®/EIA® 607 and conform to BICSI® recommendations
- Comply with NEMA® Standards
- 1/4" thick copper bars
- Type 304 stainless steel brackets and insulators included with ground bar kits
- Electro-tin plating available (add "T" to ground bar part number)
- All bars contain 2 mounting holes (7/16")

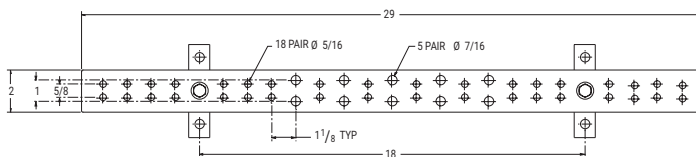
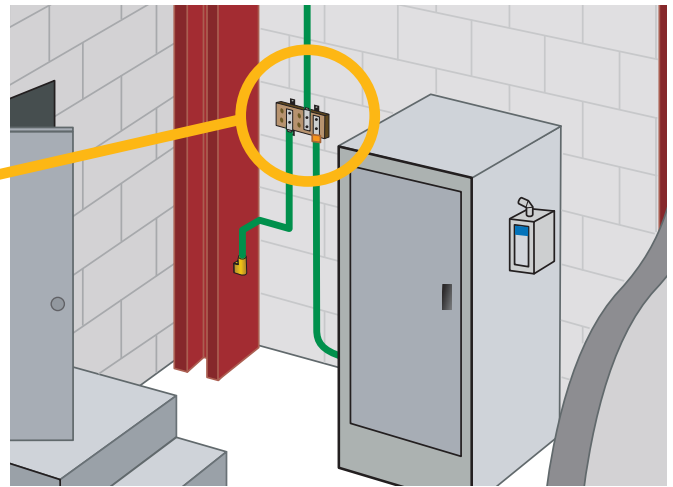

TGBA29L18PT

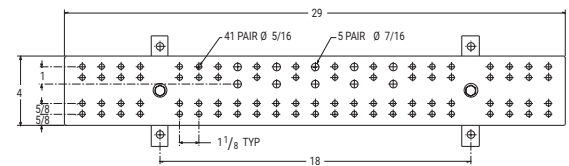

TMGBA29L41PT

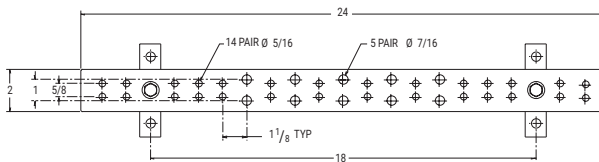

TGBA24L14PT

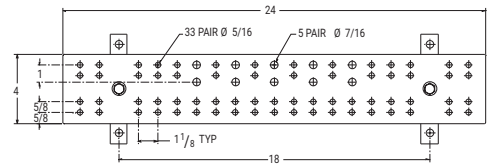

TMGBA24L33PT

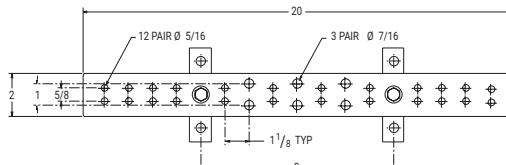

TGBA20L12PT

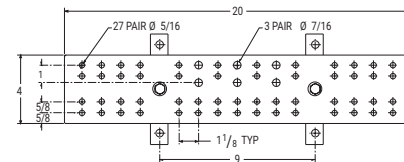

TMGBA20L27PT

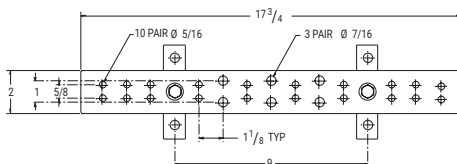

TGBA18L10PT

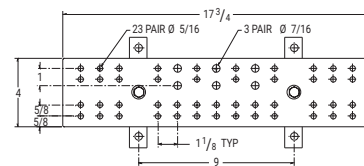

TMGBA18L23PT

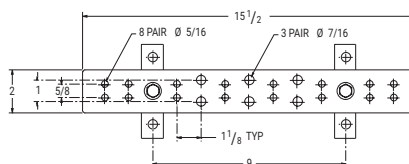

TGBA16L08PT

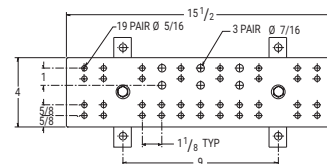

TMGBA16L19PT

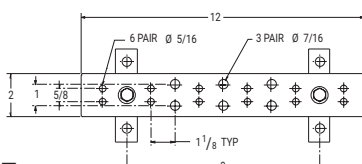

TGBA12L06PT

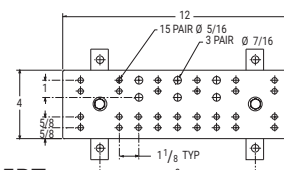

TMGBA12L15PT

# Telecom Ground Bars

## TGB TELECOM GROUND BARS WITH INSULATORS & BRACKETS

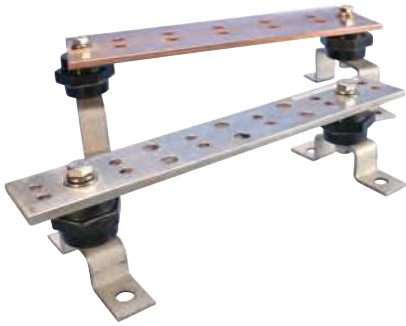

Part Number	Thickness (in)	Width (in)	Length (in)	Plating
TGBA06L02P	1/4	2	6	
TGBA06L02PT	1/4	2	6	Tin
TGBA10L04P	1/4	2	10	
TGBA10L04PT	1/4	2	10	Tin
TGBA12L06P	1/4	2	12	
TGBA12L06PT	1/4	2	12	Tin
TGBA16L08P	1/4	2	15.5	
TGBA16L08PT	1/4	2	15.5	Tin
TGBA18L10P	1/4	2	17.75	
TGBA18L10PT	1/4	2	17.75	Tin
TGBA20L12P	1/4	2	20	
TGBA20L12PT	1/4	2	20	Tin
TGBA24L14P	1/4	2	24	
TGBA24L14PT	1/4	2	24	Tin
TGBA29L18P	1/4	2	29	
TGBA29L18PT	1/4	2	29	Tin

## TMGB TELECOM MAIN GROUND BARS WITH INSULATORS & BRACKETS



Part Number	Thickness (in)	Width (in)	Length (in)	Finish
TMGBA12L15P	1/4	4	12	-
TMGBA12L15PT	1/4	4	12	Tinned
TMGBA16L19P	1/4	4	15.5	-
TMGBA16L19PT	1/4	4	15.5	Tinned
TMGBA18L23P	1/4	4	17.75	-
TMGBA18L23PT	1/4	4	17.75	Tinned
TMGBA20L27P	1/4	4	20	-
TMGBA20L27PT	1/4	4	20	Tinned
TMGBA24L33P	1/4	4	24	-
TMGBA24L33PT	1/4	4	24	Tinned
TMGBA29L41P	1/4	4	29	-
TMGBA29L41PT	1/4	4	29	Tinned

## TGB & TMGB TELECOM GROUND BAR SPLICE KITS

- Includes 2 tinned copper splice plates and stainless steel fasteners

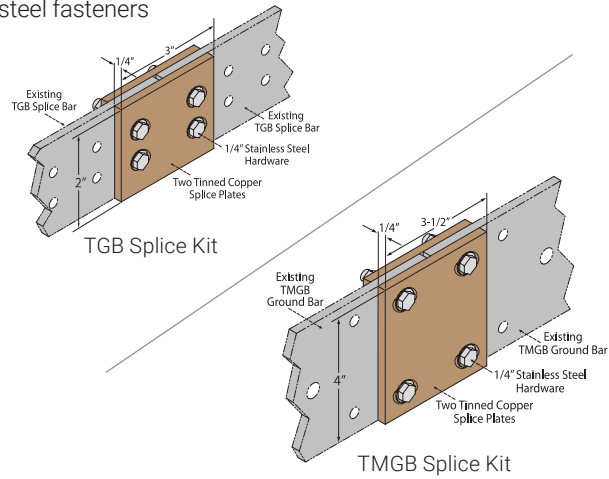

Part Number	Width (in)	Length (in)	Material
TGBSPICEKIT	1/4	2	Tinned Copper
TMGBSPICEKIT	1/4	4	Tinned Copper

## Theft Deterrent Telecom Ground Bars



Part Number	Thickness (in)	Width (in)	Length (in)	Finish	Pigtails
EGGBC14412QQ	1/4	4	12	Galvanized	0
EGGBC14424QQ	1/4	4	24	Galvanized	0
EGGBC14436QQ	1/4	4	36	Galvanized	0
EGGBC14412QQS2	1/4	4	12	Galvanized	2
EGGBC14424QQS2	1/4	4	24	Galvanized	2
EGGBC14436QQS2	1/4	4	36	Galvanized	2

## Telecom Ground Bars with Covers

Part Number	Thickness (in)	Width (in)	Length (in)	Finish	Cover
TGBF06L02P	1/4	2	6	-	Y
TGBF06L02PT	1/4	2	6	Tinned	Y
TGBF10L04P	1/4	2	10	-	Y
TGBF10L04PT	1/4	2	10	Tinned	Y
TGBF12L06P	1/4	2	12	-	Y
TGBF12L06PT	1/4	2	12	Tinned	Y

# Perimeter Grounding Bus Bars

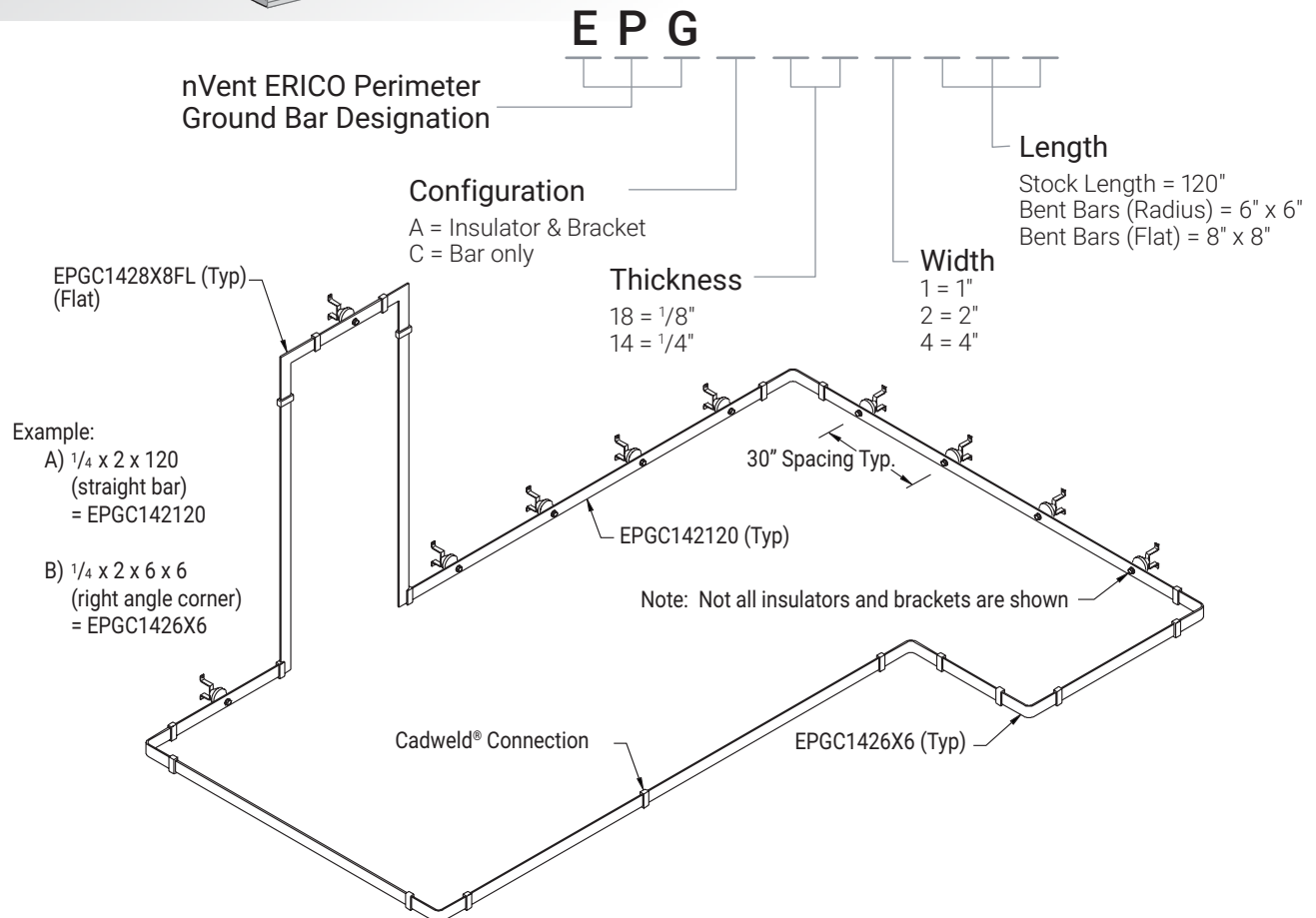
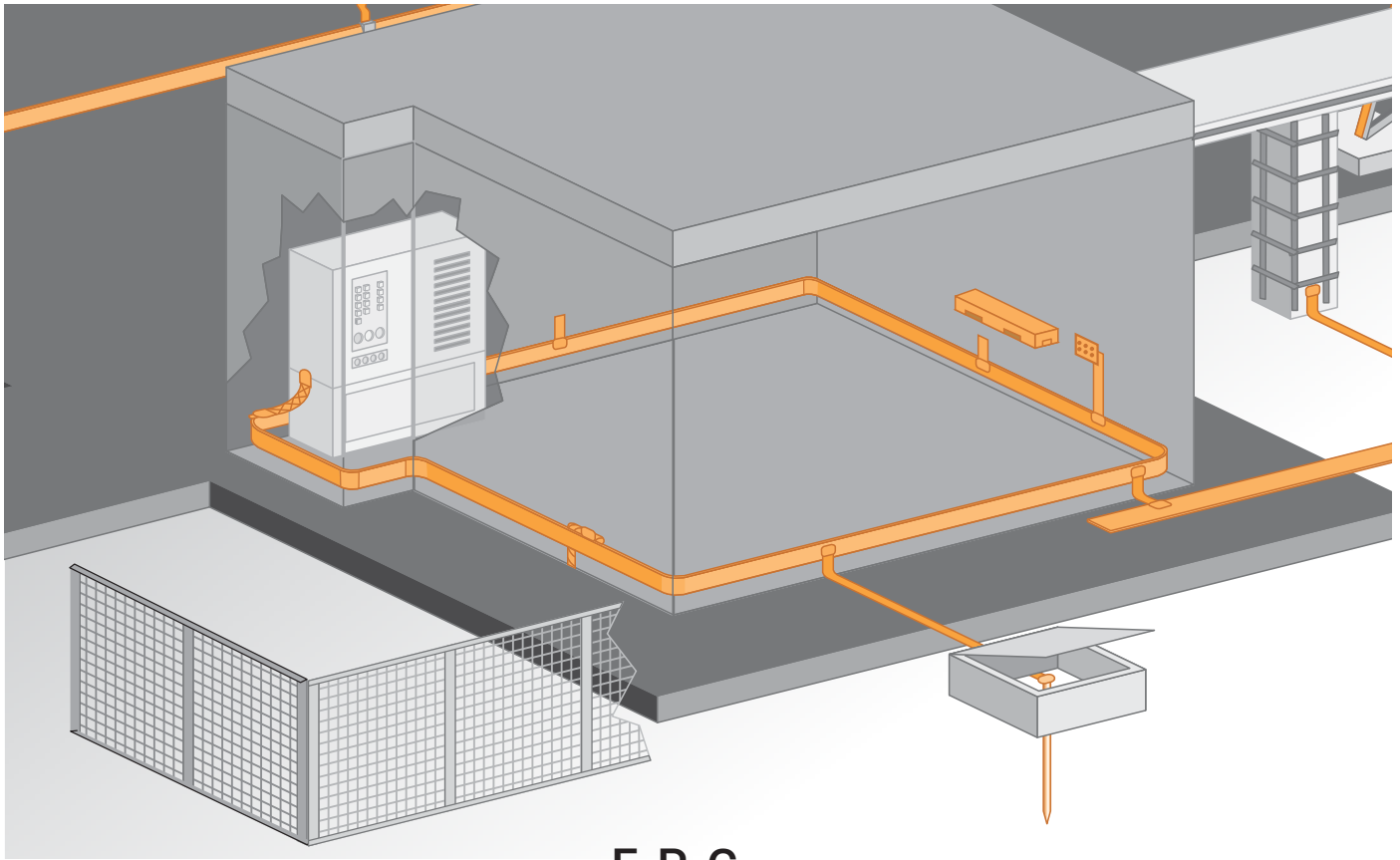

# Perimeter Grounding Bus Bars

## STRAIGHT PERIMETER BARS WITH 7/16" HOLES ON 30" CENTERS

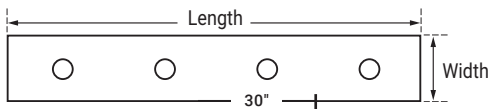

Part Number	Thickness (in)	Width (in)	Length (in)
EPGC141120	1/4	1	120
EPGC142120	1/4	2	120
EPGC142144	1/4	2	144
EPGC143120	1/4	3	120
EPGC144120	1/4	4	120
EPGC181120	1/4	1	120
EPGC182120	1/8	2	120

## BUS BARS WITH FLAT 90-DEGREE ANGLE FOR DOORS (8" X 8")

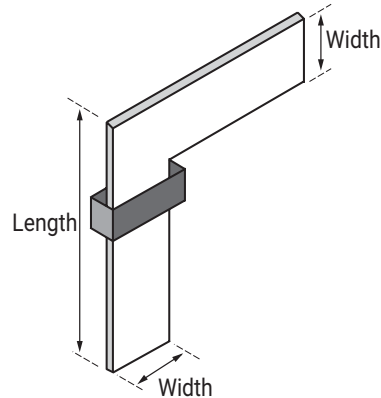

Part Number	Thickness (in)	Width (in)	Length (in)
EPGC1418X8FL	1/4	1	8
EPGC1428X8FL	1/4	2	8
EPGC1448X8FL	1/4	4	8
EPGC1828X8FL	1/8	2	8

## BENT BUS BARS WITH 90-DEGREE ANGLE FOR CORNERS (6" X 6")

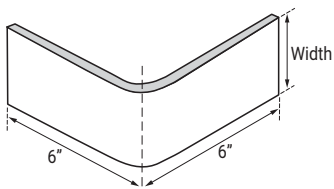

Part Number	Thickness (in)	Width (in)	Length (in)
EPGC1236X6	1/2	3	6
EPGC1416X6	1/4	1	6
EPGC1426X6	1/4	2	6
EPGC1428X8	1/4	2	8
EPGC1436X6	1/4	3	6
EPGC1446X6	1/4	4	6
EPGC1446X6T*	1/4	4	6

\* Tinned copper bar

## CADWELD TYPE BA CONNECTIONS



Mold Part Number	Bar Thickness (in)	Bar Width (in)	Welding Material
BACCE	1/8	1	45
BACCH	1/8	2	90
BACCK	1/8	3	200
BADCM	1/8	4	250
BACEE	1/4	1	90
BACEH	1/4	2	200
BADEK	1/4	3	200 (2)
BADEM	1/4	4	500



# Equipment Ground Plates

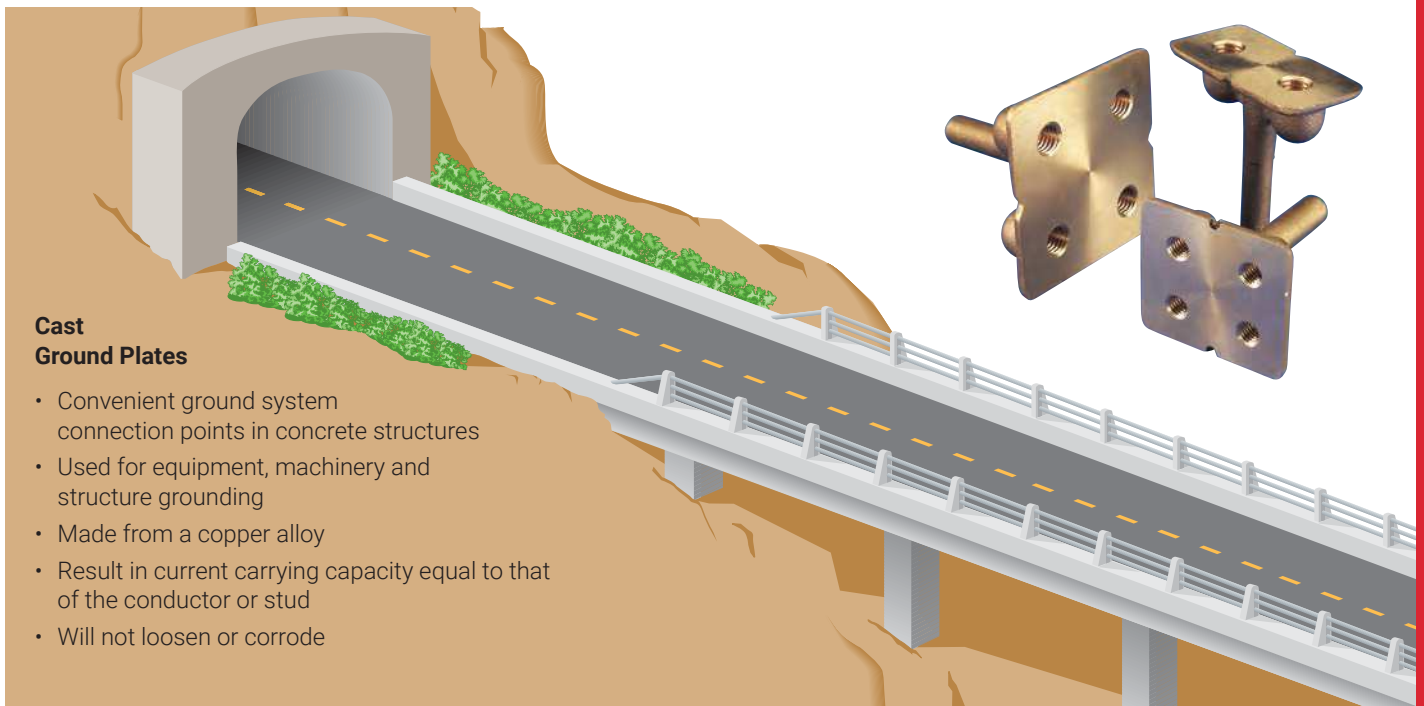

Use a Cadweld mold (Type TA or Type SS) when connecting the Eritech® brand of cast ground plate to the ground conductor. The cast ground plate stud size noted above fits the mold opening for a cable of the same size. Reference Cadweld catalog (A1A) for more information.

### Examples:

- Tee connection of 250 cable to B1642Q (4/0 stud size), use mold TAC2V2Q.
- Splice connection of 250 cable to B1642Q, use mold SSC2Q2V.

### Clamp Style Ground Plate

- Cast bronze grounding plate
- Dimensions similar to B164 Series
- Cable connection under bolt tension

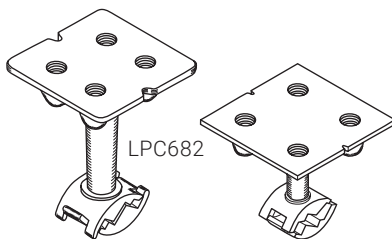

### DB Series

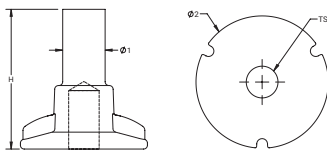

Reference Code	φA	φB (mm)	φD (mm)	F (mm)
DB-12A	M12	16	50	55
DB-16A	M16	16	50	55

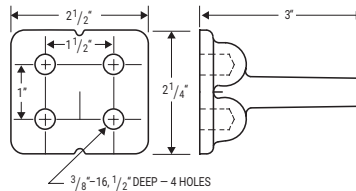

Part Number	Description
B1612Q	Cast ground plate with 4/0 stud
B1613Q	Cast ground plate with 500 MCM stud

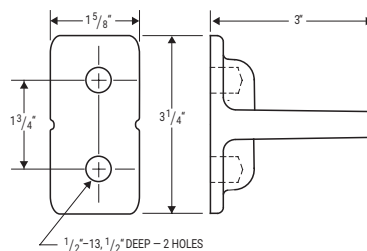

Part Number	Description
B1622Q	Cast ground plate with 4/0 stud

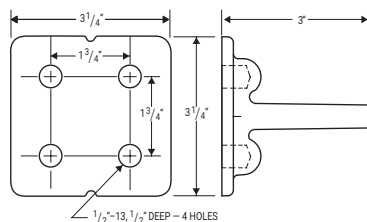

Part Number	Description
B1642Q	Cast ground plate with 4/0 stud
B1643Q	Cast ground plate with 500 MCM stud



# Equipment Ground Plate Assemblies

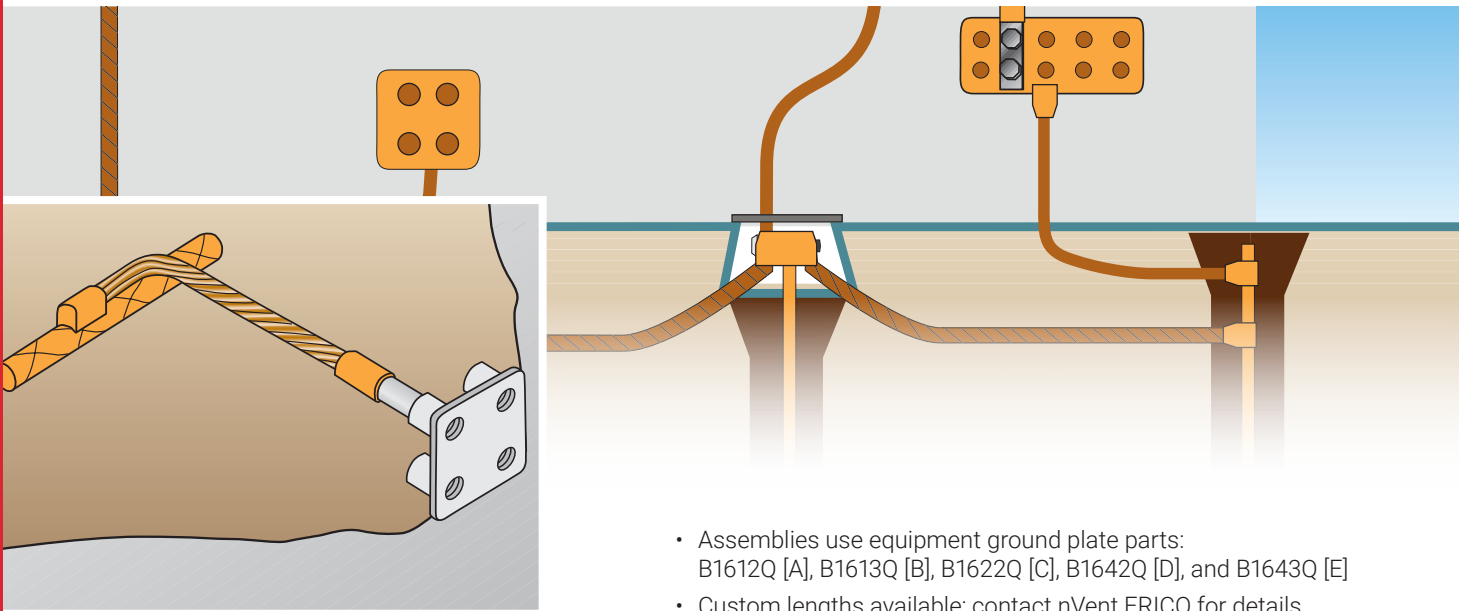

- Assemblies use equipment ground plate parts: B1612Q [A], B1613Q [B], B1622Q [C], B1642Q [D], and B1643Q [E]
- Custom lengths available; contact nVent ERICO for details

## B530 A 2Q 72

### Ground Plate Configuration

RA = "B530"  
 RB = "B531"  
 SS = "B532"  
 TA = "B533"

### Ground Plate Part Number

B1612Q = "A"  
 B1613Q = "B"  
 B1622Q = "C"  
 B1642Q = "D"  
 B1643Q = "E"

### Cable Code

#6 Solid = 1G	1/0 Stranded = 2C	250 MCM Stranded = 2V
#4 Stranded = 1L	2/0 Stranded = 2G	350 MCM Stranded = 3D
#2 Stranded = 1V	4/0 Stranded = 2Q	500 MCM Stranded = 3Q

### Cable Length (inches)

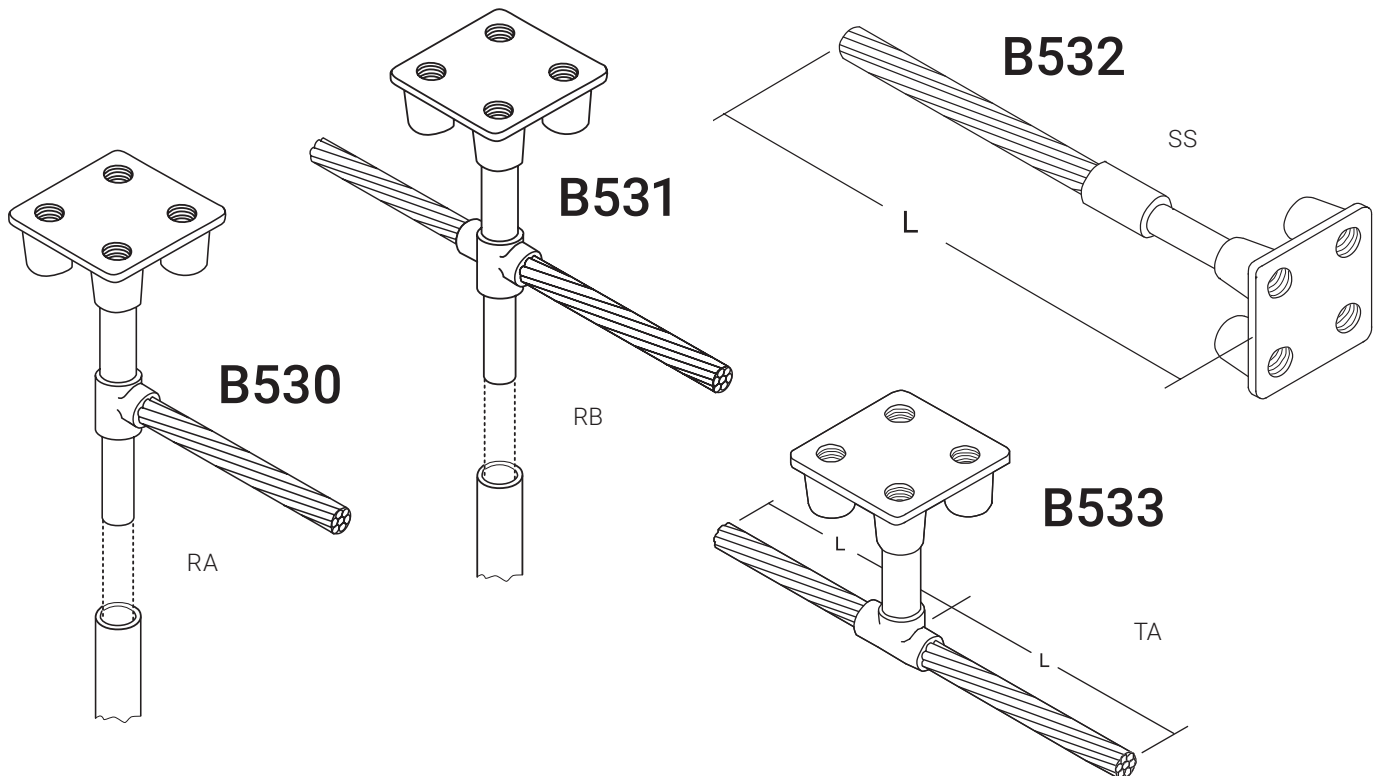

# Aircraft Grounding Receptacles

- Copper alloy castings for use in static grounding systems of aircraft refueling areas
- Easily connected to grounding system conductor and/or ground rods
- Designed for simple installation with flush paved surfaces
- Compatible with Cadweld connections

## GROUNDING RECEPTACLES WITH BALL STUD

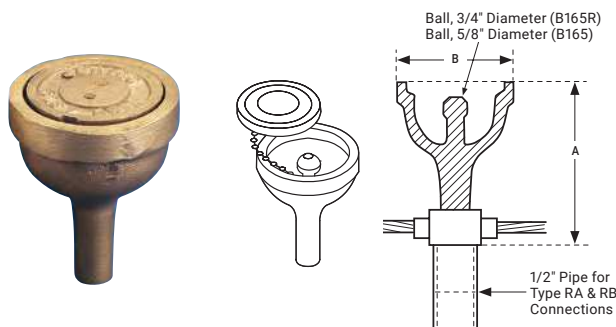

Part Number	Attachment Point	Depth (in) (A)	Diameter (in) at Grade Level (B)	Standard Packaging Quantity
B165*	3/4" Ball Stud	4-1/2	2-3/4	1
B165B	(Cover for B165, included)	—	2-3/4	1
B165R*	Removable 3/4" Ball Stud	4-1/2	2-3/4	1
B165RS*	Removable 3/4" Ball Stud	4-1/2	2-3/4	1

## COPPER-BONDED AIRCRAFT TIE DOWN RODS

Specifications	
663400	Nominal 3/4" diameter x 10' length

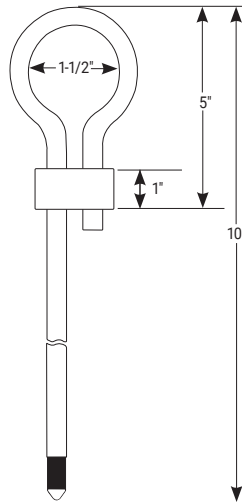

## DEPRESSION MOLD DM5834

Plastic for making 3" x 6" x 2.5" deep depression in concrete pour around rod in aircraft tie-down.

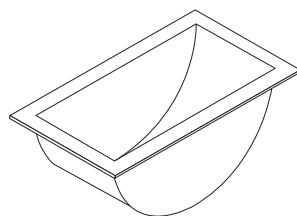

## GROUNDING RECEPTACLES WITH BAR ATTACHMENT POINT

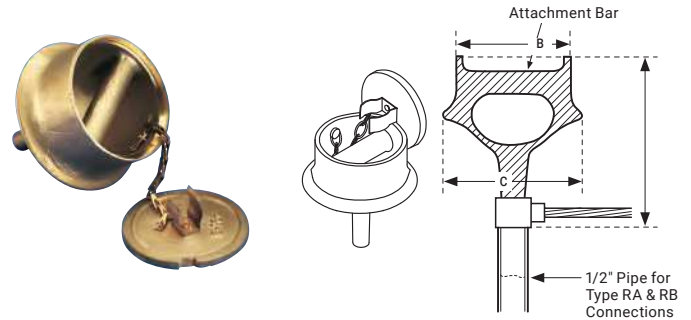

Part No.	Attachment Point	Depth (in) (A)	Diameter (in) at Grade Level (B)	Maximum Diameter (in) (C)	Standard Packaging Quantity
B166*	3/4" Diameter Bar	6-1/4	3-7/8	4-3/4	1
B166B	(Cover for B166, included)	—	3-7/8	—	1
B167	1.5" Diameter Bar	7-1/4	4-3/4	6-1/2	1
B167B	(Cover for B167, included)	—	4-3/4	—	1

\* Aircraft static grounding clamp B2617A can be used to connect to the B165, B165R, and B166.

## GROUNDING RECEPTACLES FOR SECTIONAL GROUND RODS

- Copper alloy castings for use in static grounding systems of aircraft refueling areas
- Easily connected to grounding system conductor and/or ground rods
- Designed for simple installation with flush paved surfaces
- Standard pin connection
- Chain-retained cover plate
- Couple directly to 3/4" sectional or extension rod

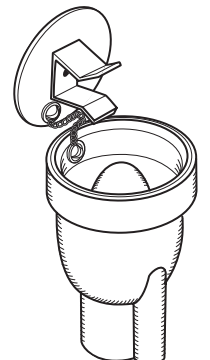
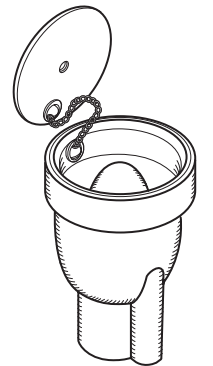

Part Number	Standard Packaging Quantity
LPC680	1
LPC681**	1

\*\* Spring clip included to secure cover plate.

# Signal Reference Grid (SRG)

The Signal Reference Grid (SRG) is a pre-fabricated, low impedance network of conductors established to create an equipotential plane for high frequency, low voltage digital signals in such applications as intensive computer, telemetry and telecommunications installations.

Digital signal line voltages are typically low. Their sensitivity to transient noise is very high (typically 1 volt for some digital systems). The SRG complies with IEEE® Standard 1100-1992 for grounding practices in sensitive electronic environments.

Proper grounding and bonding of sensitive electronic systems, including computer installations, requires careful consideration of all frequencies from DC to over 100 megahertz. The local requirements for electrical fault current and lightning protection must also be met.

The safety grounding system required by code does not address the special requirements of noise immunity. An additional "grounding" system called the Signal Reference Grid (SRG) is needed for trouble-free equipment performance.

## SRG Part Numbering

**SRG**

**Grid Spacing**

B=24"  
C=48"  
F=12"  
G=36"

**Width**

A = 4'  
B = 6'  
C = 8'  
D = 10'

E = 12'  
F = 14'  
G = 16'  
H = 2'

**Length in Feet**  
(3 digits)

J = 3'  
K = 5'  
L = 7'  
M = 9'

Part Number	Grid Spacing (in)	Width (ft)	Length (ft)
SRGBD100	24 x 24	10	100
SRGBE100	24 x 24	12	100
SRGBG100	24 x 24	16	100

## How to Specify

The Signal Reference Grid shall be manufactured from 2" wide by 26 gauge (0.0159 inch thick) copper strips on 2', 600 mm or 1200 mm centers. All crossovers shall be joined by welding. The SRG shall be furnished 4' to 16' wide. The sections shall be rolled on tubes with the outside of the roll protected for shipment. These sections shall be bonded to each other in the field with Cadweld connections.

### Note:

1. Other strip sizes are available
2. Other spacing is available
3. Roll weight usually limited to about 200 lbs. gross weight for convenience (1200 sq. ft.)

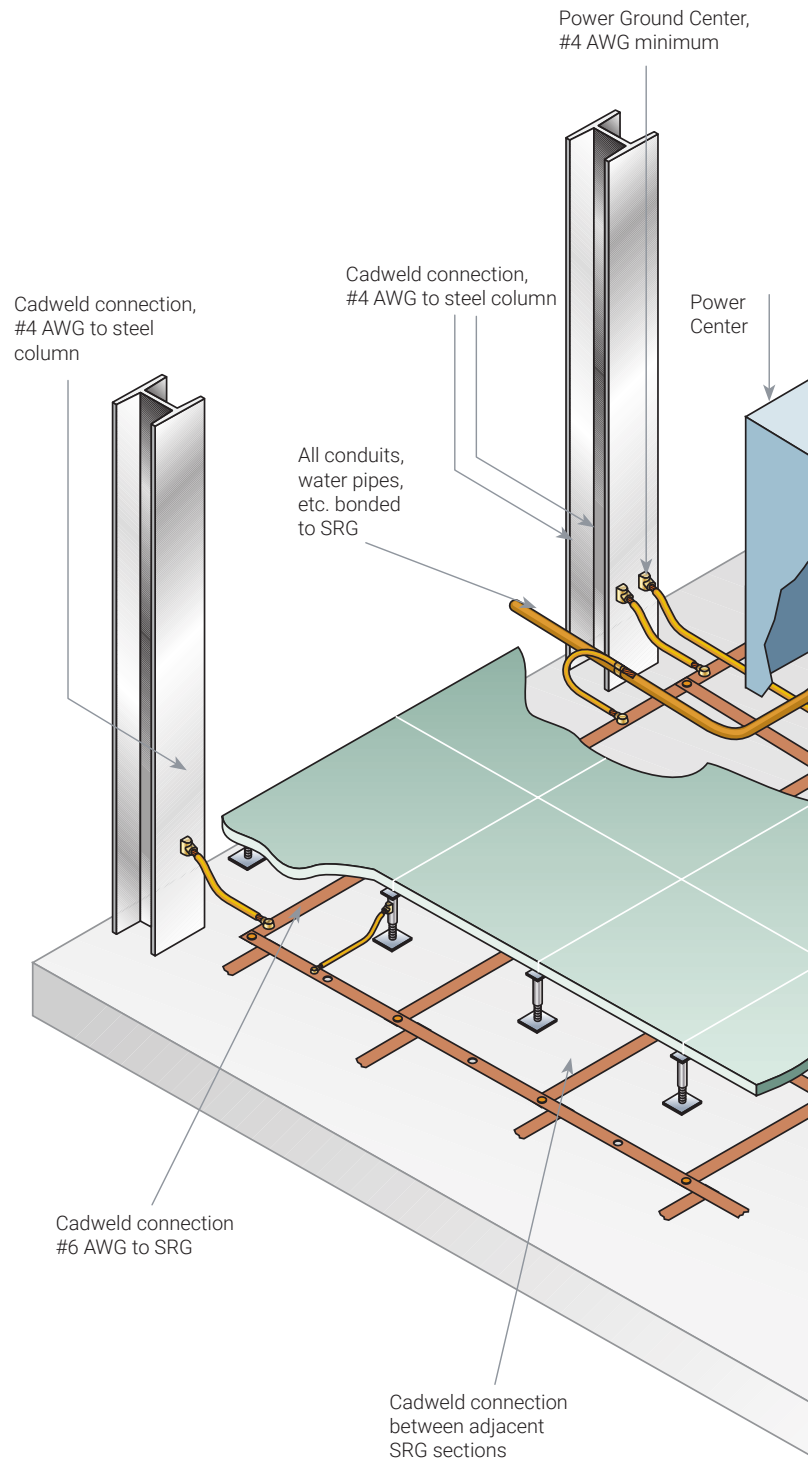

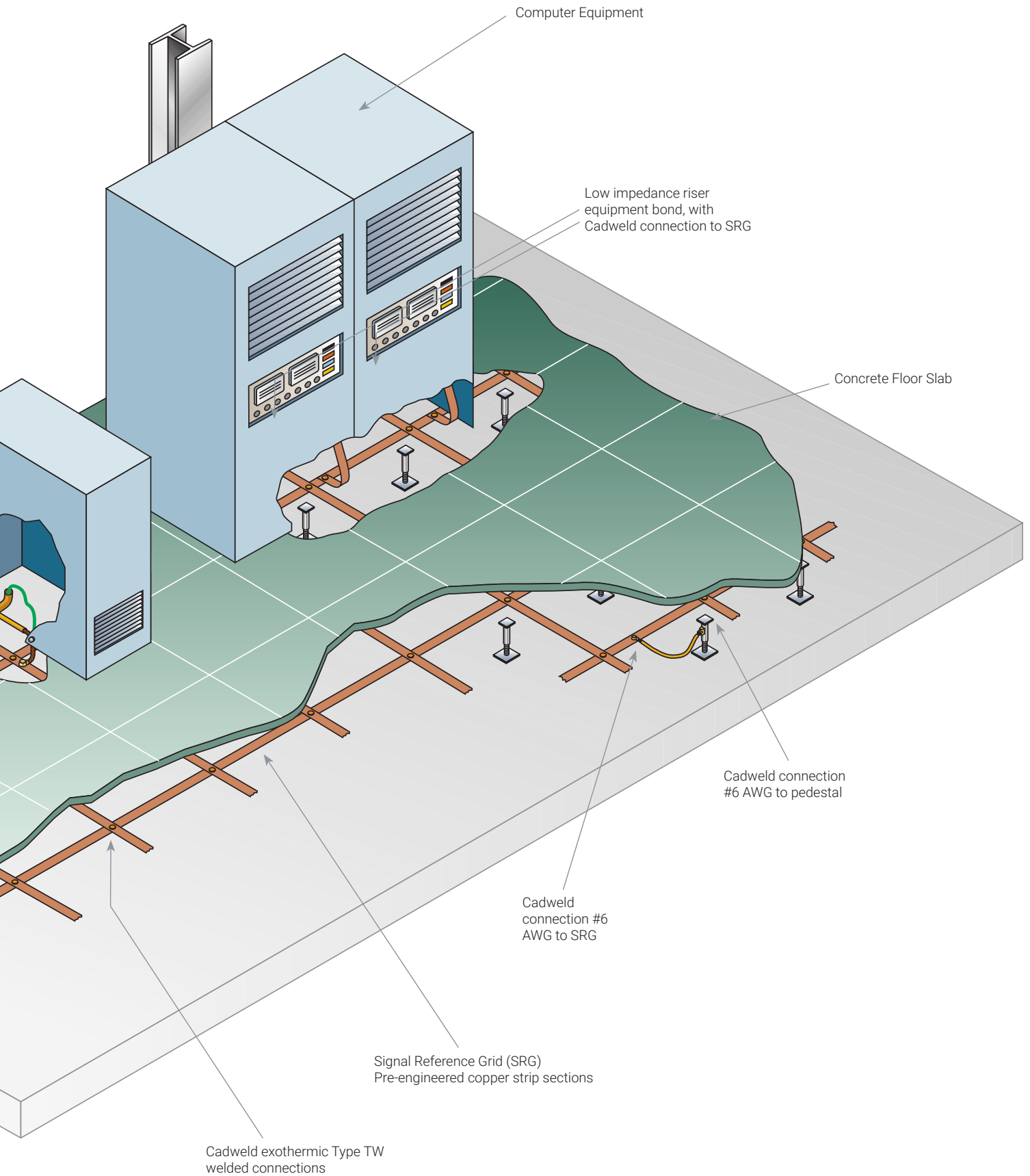

# Equipotential Mesh and Mats

## Prefabricated Wire Mesh

nVent ERICO brand of prefabricated wire mesh from nVent ERICO is a convenient, efficient and economical means of improving grounding systems at facilities with high-voltage installations and wherever large area grounds are required. Equipotential mesh reduces step potentials at power plants and substations, and effectively minimizes ground plane fluctuations at communications antenna sites. Wire mesh is also an excellent ground screen, reflector and electronic shield for large facilities.

Personnel safety mats, made of prefabricated wire mesh, are ideal for systems designed to protect operators against "touch potentials" at manually operated disconnect switches.

## Equipotential Mesh Features

- Silver brazed joints provide strength to resist separation during installation and bear the traffic of heavy vehicles
- Furnished in rolls up to 20' wide
- 500 lbs. maximum weight
- Conductor spacing in many rectangular configurations up to 24" x 48" in 2" increments
- Normally supplied in sections with standard overhang for interconnecting (1/2 conductor spacing + 2")

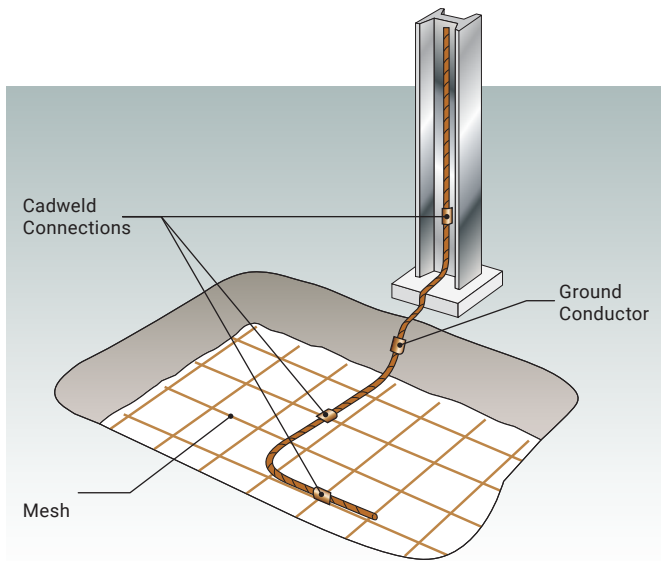

## AVAILABLE WIRE SIZES AND CONDUCTIVITY

Wire Size (AWG)	Material	Conductivity
#6	pure copper	100%
#6	copper-clad steel	30% or 40%
#8	pure copper	100%
#8	copper-clad steel	30% or 40%
#10	pure copper	100%

## Overhang Configurations

M = Conductor Spacing  
L = Total Length  
W = Total Width

### Standard overhang for interconnecting sections of mesh

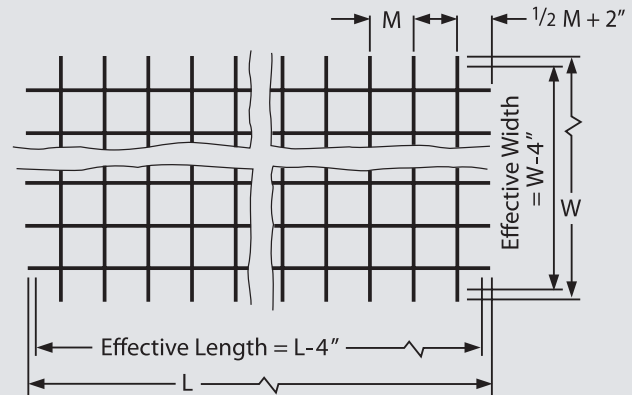

### No overhang

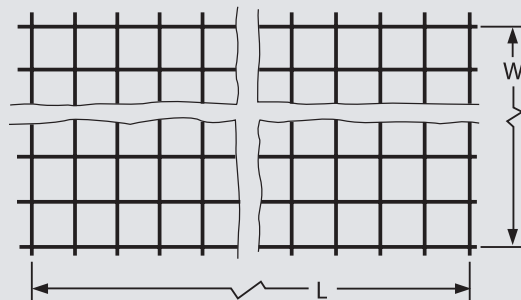

### Half-spacing overhang

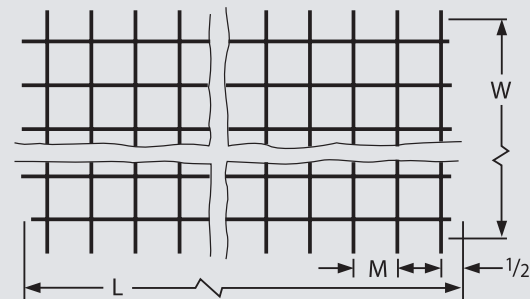

# Equipotential Mesh and Mats

## Easy Installation

- No digging or trenching required
- Unroll over the ground
- Interconnect by welding to adjacent sections of mesh using Cadweld
- Weld to the main ground grid in substations or welded to ground rods
- May be covered with a layer of earth or crushed stone depending on the application

## Interconnecting

- The Cadweld process provides a rapid and economical method of interconnecting mesh in the field
- Resulting weld is permanent and corrosion resistant
- Current carrying capacity equal to that of the conductor

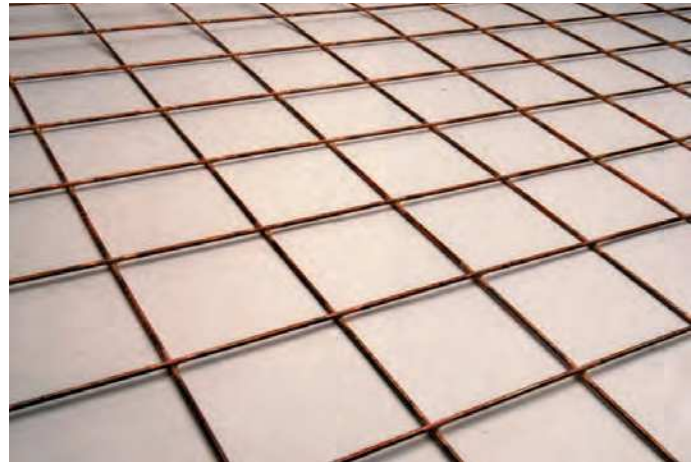

## WEIGHT OF MESH

### Net Weight (lbs) per 100 Square Feet Δ

Conductor Spacing (in)	Copper-clad Steel Wire (AWG)			Solid Copper Wire (AWG)		
	#6	#8	#10	#6	#8	#10
2 x 2	888	558	351	974	609	383
4 x 4	443	279	175	487	305	192
6 x 6	295	186	117	325	203	128
8 x 8	222	139	88	243	153	96
12 x 12	148	93	59	163	102	64
24 x 24	74	47	29	81	51	32
48 x 48	56	35	23	62	38	24

Δ Add 75 lbs per roll for approximate shipping weight.

## CADWELD CONNECTIONS JOINING ADJACENT SECTIONS OF WIRE MESH OR SAFETY MATS

Solid Wire Sizes (AWG)	Cadweld Mold Part Number*	Welding Material
#6 solid copper	PGT-06CU	25
#6 copper-clad steel	PGT-06CS	15
#8 solid copper	PGT-08CU	15
#8 copper-clad steel	PGT-08CS	15
#10 solid copper	PGT-10CU	15
#10 copper-clad steel	PGT-10CS	15

\* Includes mold handles.

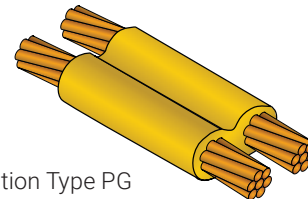

Connection Type PG

## CADWELD CONNECTIONS OF CENTER WIRE TO MESH OR SAFETY MATS

Mat Wire (AWG)	Center Wire Size (AWG)	Cadweld Mold Part Number**	Welding Material
#6 Solid	1/0	PTC1G2C	65
	2/0	PTC1G2G	65
	4/0	PTC1G2Q	90
#8 Solid	1/0	PTC1D2C	65
	2/0	PTC1D2G	65
	4/0	PTC1D2Q	90
#10 Solid	1/0	PTC1A2C	65
	2/0	PTC1A2G	65
	4/0	PTC1A2Q	90

\*\* Molds require L160 handle clamps sold separately.

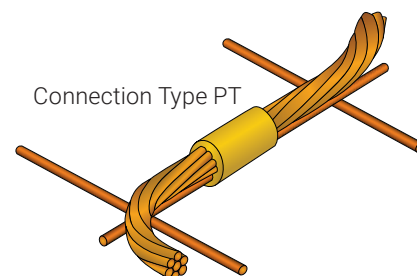

Connection Type PT

## Suggested Specifications

Prefabricated wire mesh shall be manufactured using (a)\* AWG bare, solid (b)\* wire on a (c)\* inch x (c)\* inch conductor spacing with all cross connections silver brazed using a 35% silver alloy brazing material and a non-corrosive flux. It shall be (d)\* feet, (d)\* inches wide by (e)\* feet, (e)\* inches long with (f)\* inches overhang on both sides and both ends, and shall be wound on a fiber tube with the outside of the roll protected by wood strips interconnected with steel wire.

- \* (a) Wire size, #6, #8, #10, or #12 AWG.
- (b) 30% or 40% conductivity copper-clad or pure copper.
- (c) 2" x 2" minimum to 48" x 24" maximum (in 2" increments).
- (d) 20', 4" maximum.
- (e) Maximum length determined by weight, with a 500 lbs. maximum net weight.
- (f) No overhang, an overhang equal to one-half conductor spacing or an overhang equal to one-half conductor spacing plus 2" (for interconnecting).

# Equipotential Mesh and Mats

## PERSONNEL SAFETY MATS

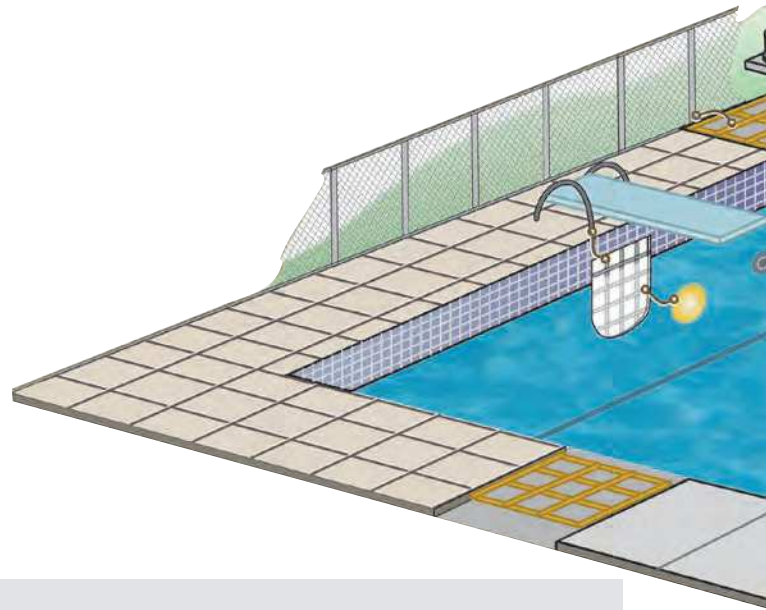
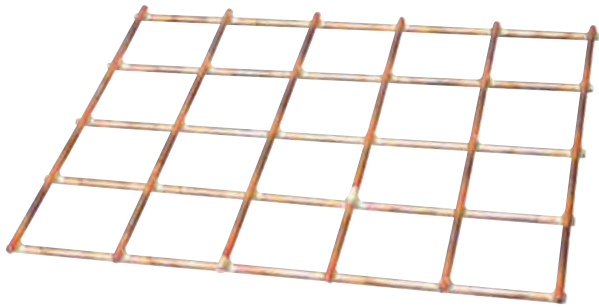

## AVAILABLE MAT WIRE SIZES AND MATERIALS

Wire Size (AWG)	Material	Conductivity
#4	pure copper	100%
#6	pure copper	100%
#6	copper-clad steel	30% or 40%
#8	pure copper	100%
#8	copper-clad steel	30% or 40%

Standard Mat Sizes (ft)
4 x 4
4 x 6
6 x 8

Conductor Spacing (in)
2 x 2
4 x 4
6 x 6
8 x 8
12 x 12

## SUGGESTED SPECIFICATIONS

### Standard Personnel Safety Mats:

Prefabricated personnel safety mats shall be manufactured using (a)\* AWG bare, solid (b)\* wire on (c)\* inches x (c)\* inches conductor spacing. All cross connections shall be silver brazed using a 35% silver brazing alloy and a non-corrosive flux. Overall mat size shall be (d)\* feet x (d)\* feet.

### Mats With Center Wire:

Prefabricated personnel safety mats shall be manufactured using (a)\* AWG bare, solid (b)\* wire on (c)\* inches x (c)\* inches conductor spacing with (e)\* diameter solid copper center wire through the (f)\* length overhanging each end (g)\* inches. All cross connections shall be silver brazed using a 35% silver brazing alloy and a non-corrosive flux. Overall mat size shall be (d)\* feet x (d)\* feet.

- \* (a) #4, #6 or #8 AWG (see chart above).
- (b) 30% or 40% conductivity copper-clad or pure copper (#4 available only in pure copper).
- (c) Minimum of 2 inches, maximum of 12 inches in 2-inch increments (not available in 10-inch increments).
- (d) Standard sizes are 4 feet x 4 feet and 4 feet x 6 feet with maximum 6 feet x 8 feet.
- (e) 5/16 inch (1/0 solid) or 3/8 inch (2/0 solid). Stranded cable is also available (see chart above).
- (f) Longest or shortest.
- (g) Center wire is either flush (0-inch overhang) or with a 6-inch overhang.

### Standard

### Configurations

M = Conductor Spacing in Inches

L = Length in Feet (not including overhang)

W = Width in Feet

### Standard Safety Mat

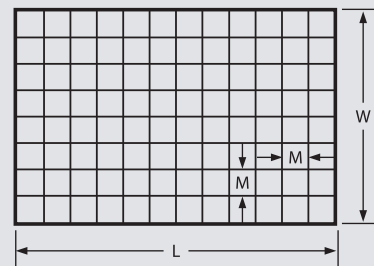

### Safety Mat with Center Wire\*

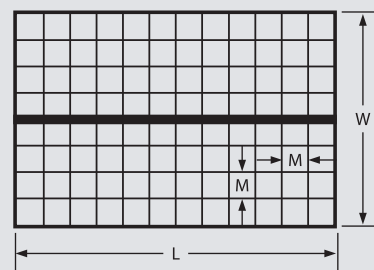

### Safety Mat with Overhanging Center Wire\*

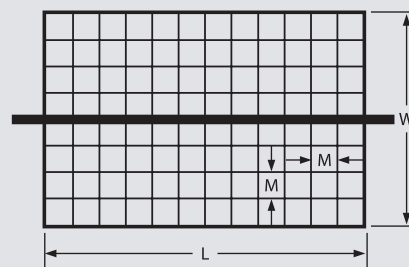



# Equipotential Mesh and Mats

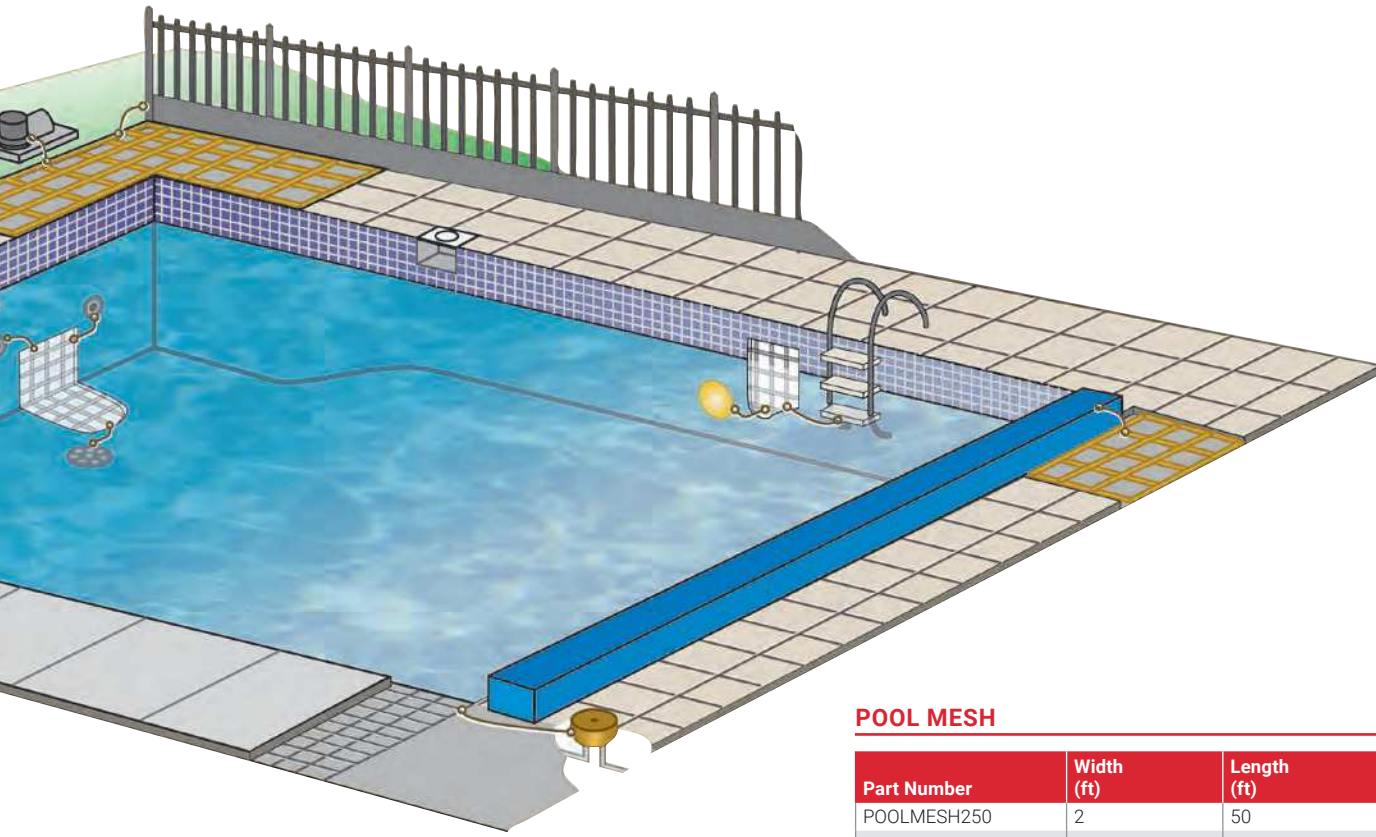

## POOL MESH

Part Number	Width (ft)	Length (ft)	Conductor (AWG)
POOLMESH250	2	50	8 Solid
POOLMESH2100	2	100	8 Solid
POOLMESH350	3	50	8 Solid
POOLMESH3100	3	100	8 Solid

Wire Size (AWG)	
1/0	Solid or Stranded
2/0	Solid or Stranded
4/0	Stranded
250	MCM Stranded
300	MCM Stranded
350	MCM Stranded
500	MCM Stranded

\* Standard Center Wire (length-wise or width-wise)

## EXPANDED METAL MESH

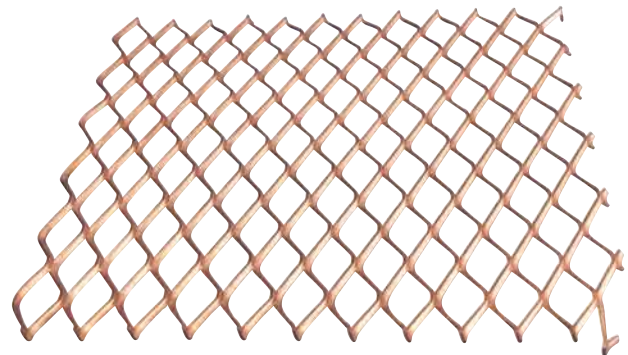

## NET WEIGHT (LBS) PER STANDARD MAT\*

	Conductor Spacing (in)									
	2 x 2		4 x 4		6 x 6		8 x 8		12 x 12	
	Standard Mat Size (sq ft)									
Wire Size	4 x 4	4 x 6	4 x 4	4 x 6	4 x 4	4 x 6	4 x 4	4 x 6	4 x 4	4 x 6
#6 Copper-clad steel wire	14.6	21.7	7.6	11.2	5.3	7.7	4.1	6.0	2.9	4.2
#8 Copper-clad steel wire	9.2	13.7	4.8	7.1	3.3	4.9	2.6	3.8	1.9	2.7

\* Weights are for copper-clad wire. Add 10% for approximate weight of solid copper wire. Safety mats are palletized for shipment. Add 50 pounds per pallet for gross weight. Maximum of 100 mats per pallet.

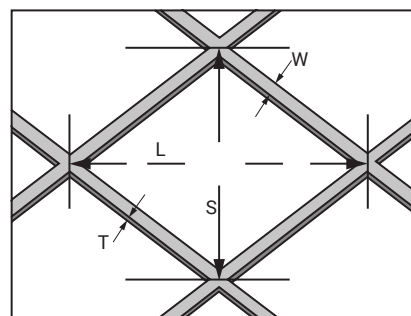

L = Long dimension  
S = Short dimension  
W = Strand width  
T = Thickness

Contact nVent ERICO for more information.

# Bonding Devices

## B21-Series Prefabricated Lug Bonds

Prefabricated lug bonds are custom made to specifications. Common usage includes cable tray bonding and grounding, structure bonds, surge arrester leads and power jumpers.

- Made with bare annealed copper cable
- Tinned copper NEMA® lugs welded to the cable with Cadweld connections

## Part Number Coding

**B21 2 1L "X"**

B-21 Lug Bond Assembly

Lug Configuration

Bond Length in inches  
(from outer-most hole center)

Cable Code

- #4 Stranded = 1L      1/0 Stranded = 2C
- #2 Stranded = 1V      2/0 Stranded = 2G
- #1 Stranded = 1Y      4/0 Stranded = 2Q
- 250 MCM Stranded = 2V

- Double-Lug Bond, 1-Hole each on Straight Lugs = "2" (see image A)
- Double-Lug Bond, 2-Holes each on Straight Lugs = "3" (see image B)
- Double-Lug Bond, 1-Hole each on 45° Lugs = "4" (see image C)
- Double-Lug Bond, 2-Holes each on 45° Lugs = "5" (see image D)
- Single-Lug Bond Stub, 1-Hole on Straight Lug = "6" (see image E)
- Single-Lug Bond Stub, 2-Holes on Straight Lug = "7" (see image F)
- Single-Lug Bond Stub, 1-Hole on 45° Lug = "8" (see image G)
- Single-Lug Bond Stub, 2-Holes on 45° Lug = "9" (see image H)

Double-Lug Bond with 1-Hole NEMA Lugs (Straight)

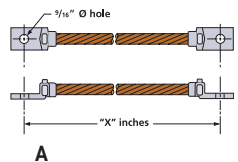

Double-Lug Bond with 2-Hole NEMA Lugs (Straight)

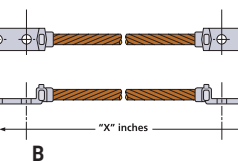

Double-Lug Bond with 1-Hole NEMA Lugs (45° Angle)

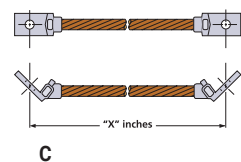

Double-Lug Bond with 2-Hole NEMA Lugs (45° Angle)

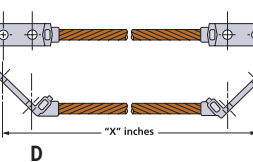

Cable Size (AWG)	Stranding	Lug Size (in)	Double-Lug Bond Part Number*			
			B212-parts One Hole	B213-parts Two Hole	B214-parts One Hole 45°	B215-parts Two Hole 45°
#4	7-strand	1/8 x 1	B2121L -"X"	B2131L -"X"	B2141L -"X"	B2151L -"X"
#2	7-strand	1/8 x 1	B2121V -"X"	B2131V -"X"	B2141V -"X"	B2151V -"X"
#1	7-strand	1/8 x 1	B2121Y -"X"	B2131Y -"X"	B2141Y -"X"	B2151Y -"X"
1/0	7-strand	1/8 x 1	B2122C -"X"	B2132C -"X"	B2142C -"X"	B2152C -"X"
2/0	7-strand	1/8 x 1	B2122G -"X"	B2132G -"X"	B2142G -"X"	B2152G -"X"
4/0	7-strand	3/16 x 1	B2122Q -"X"	B2132Q -"X"	B2142Q -"X"	B2152Q -"X"
250 MCM	19-strand	3/16 x 1	B2122V -"X"	B2132V -"X"	B2142V -"X"	B2152V -"X"

\* "X" indicates total bond length in inches.

Single-Lug Bond Stub with 1-Hole NEMA Lug (Straight)

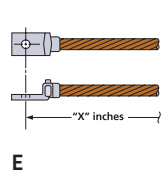

Single-Lug Bond Stub with 2-Hole NEMA Lug (Straight)

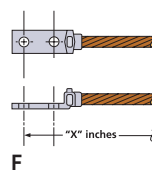

Single-Lug Bond Stub with 1-Hole NEMA Lug (45° Angle)

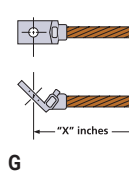

Single-Lug Bond Stub with 2-Hole NEMA Lug (45° Angle)

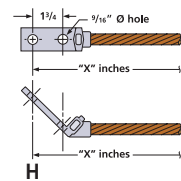

Cable Size (AWG)	Stranding	Lug Size (in)	Single-Lug Bond Stub Part Number*			
			B216-parts One Hole	B217-parts Two Hole	B218-parts One Hole 45°	B219-parts Two Hole 45°
4	7-strand	1/8 x 1	B2161L -"X"	B2171L -"X"	B2181L -"X"	B2191L -"X"
2	7-strand	1/8 x 1	B2161V -"X"	B2171V -"X"	B2181V -"X"	B2191V -"X"
1	7-strand	1/8 x 1	B2161Y -"X"	B2171Y -"X"	B2181Y -"X"	B2191Y -"X"
1/0	7-strand	1/8 x 1	B2162C -"X"	B2172C -"X"	B2182C -"X"	B2192C -"X"
2/0	7-strand	1/8 x 1	B2162G -"X"	B2172G -"X"	B2182G -"X"	B2192G -"X"
4/0	7-strand	3/16 x 1	B2162Q -"X"	B2172Q -"X"	B2182Q -"X"	B2192Q -"X"
250 MCM	19-strand	3/16 x 1	B2162V -"X"	B2172V -"X"	B2182V -"X"	B2192V -"X"

\* "X" indicates total bond length in inches.

# Bonding Devices

## Arc Weldable Bonds

Arc weldable bonds are 4-ft pieces of concentric cable (19-strand) which are flash-welded to steel rod for a bonding connection to structural steel and to rebar. Arc weldable bonds are an economical alternative to exothermic welding when only a few connections need to be made and an arc welder is available on site. The rod is sized to match the ampacity of the cable for fault currents. Complete instructions are provided.

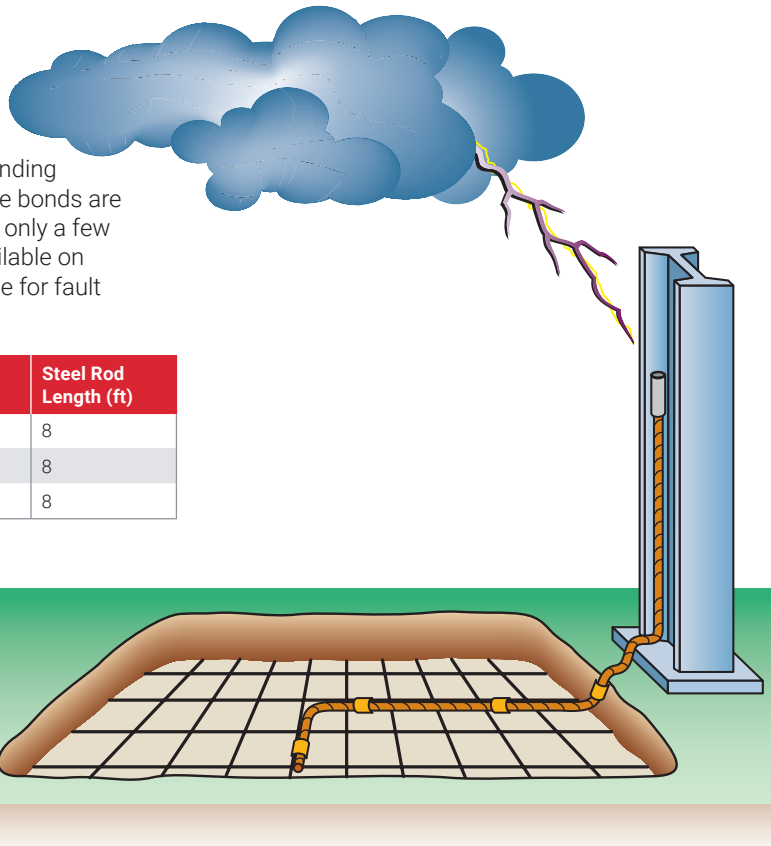

Part Number	Cable Size (AWG)	Cable Length (ft)	Steel Rod Diameter (in)	Steel Rod Length (ft)
EWB2G9164	2/0 Stranded	4	9/16	8
EWB2L584	3/0 Stranded	4	5/8	8
EWB2Q344	4/0 Stranded	4	3/4	8

All cable is 19 strand concentric.

### Welding to Rebar

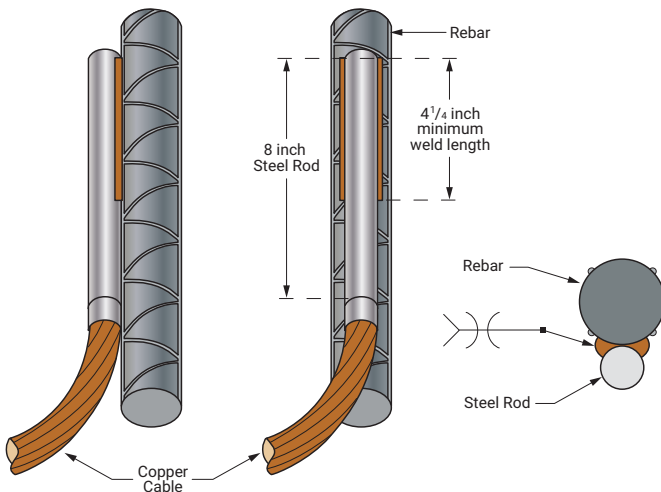

### Welding to Building Steel

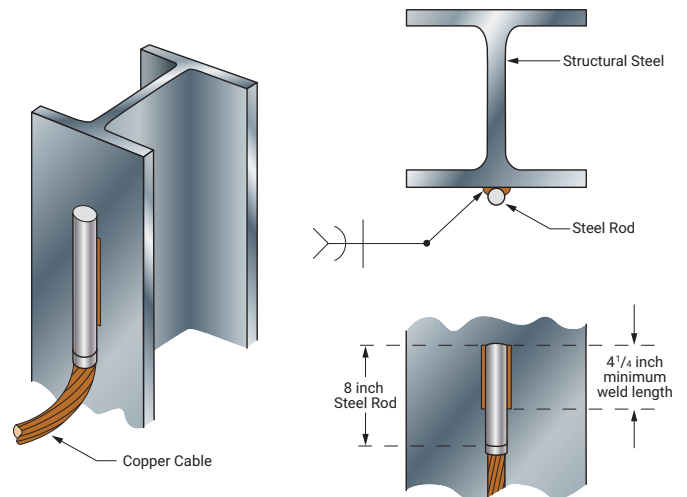

# Fence Clamp Assemblies

## Flexible Jumpers for Fence and Gate Grounding

Made from welding cable, flexible jumpers provide both conductor flexibility and strand protection, and are used to bond gates, switch operating handles and any other item where movement or vibration requires a flexible grounding jumper.

The connections are made with Cadweld exothermic connections using the same mold required for other fence post connections.

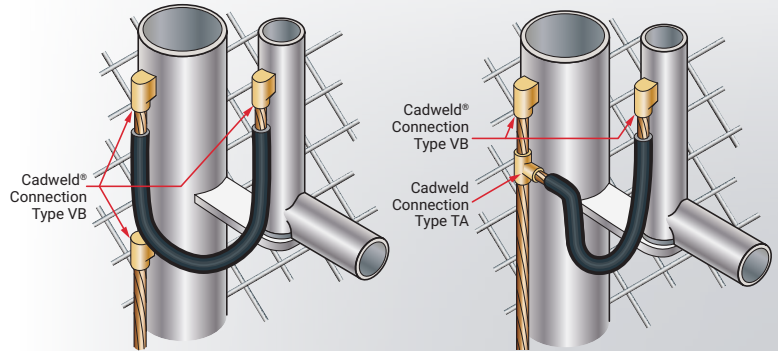

## Part Number Coding

Example: **FJ 2Q 24**

Flexible Jumper | Cable Code | Length of Jumper (inches)

#2 Solid = 1T  
2/0 Stranded = 2G  
4/0 Stranded = 2Q

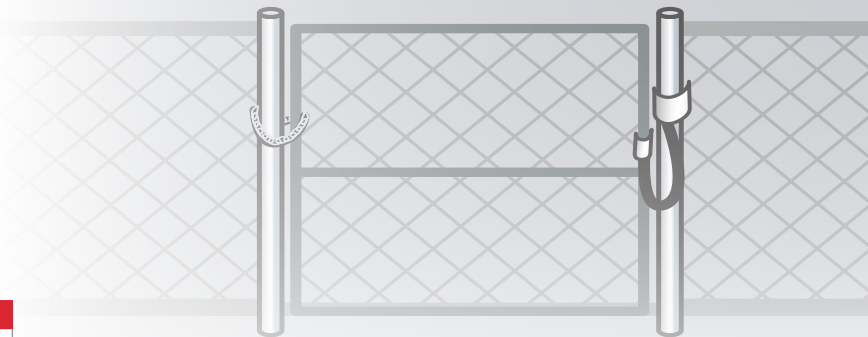

Part Number	Cable Code	Cable Size (AWG)	Length (in)
FJ1T18	1T	#2 Stranded	18
FJ1T24	1T	#2 Stranded	24
FJ1T96	1T	#2 Stranded	96
FJ2G12	2G	2/0 Stranded	12
FJ2G16	2G	2/0 Stranded	16
FJ2G18	2G	2/0 Stranded	18
FJ2G24	2G	2/0 Stranded	24
FJ2G36	2G	2/0 Stranded	36
FJ2G48	2G	2/0 Stranded	48
FJ2G72	2G	2/0 Stranded	72
FJ2G84	2G	2/0 Stranded	84
FJ2G96	2G	2/0 Stranded	96
FJ2G120	2G	2/0 Stranded	120
FJ2G144	2G	2/0 Stranded	144
FJ2G156	2G	2/0 Stranded	156
FJ2G192	2G	2/0 Stranded	192
FJ2G240	2G	2/0 Stranded	240
FJ2G300	2G	2/0 Stranded	300
FJ2G360	2G	2/0 Stranded	360
FJ2Q12	2Q	4/0 Stranded	12
FJ2Q16	2Q	4/0 Stranded	16
FJ2Q18	2Q	4/0 Stranded	18
FJ2Q24	2Q	4/0 Stranded	24
FJ2Q36	2Q	4/0 Stranded	36
FJ2Q48	2Q	4/0 Stranded	48
FJ2Q60	2Q	4/0 Stranded	60
FJ2Q96	2Q	4/0 Stranded	96
FJ2Q120	2Q	4/0 Stranded	120
FJ2Q144	2Q	4/0 Stranded	144
FJ2Q156	2Q	4/0 Stranded	156
FJ2Q180	2Q	4/0 Stranded	180
FJ2Q192	2Q	4/0 Stranded	192
FJ2Q240	2Q	4/0 Stranded	240
FJ2Q252	2Q	4/0 Stranded	252

Conductor Size (AWG)	Pipe Size (in)	Cadweld Mold Part Number	Welding Material Size
2/0	*	VBC2G008V*	90
	1-1/4 – 3-1/2	VBC2G009	90
4/0	*	VBC2Q006V*	115
	1-1/4 – 3-1/2	VBC-2Q-003	115

\* Made to exact pipe size. Add nominal pipe size mold to part number.



## Example for Cadweld Mold Part Numbering:

- A 4" outside-diameter pipe is a 3 1/2" nominal pipe size. The mold part number for a 4/0 concentric conductor to this pipe would be:

**VSC2Q V 3.50**

Base number (for flat surface) | For vertical pipe | 3 1/2" nominal pipe size

- A nominal 2 x 2 1/4" H section uses mold code PH2. A 4/0 Type VB weld to this post would be VBC2QPH2.

# Fence Clamp Assemblies

## Fence & Gate Clamp Assemblies



- Ideal for when Cadweld connections cannot be made to aluminum pipe or thin-wall steel tube
- Made of tinned, electrolytic copper
- Stainless steel hardware
- Available for field-welding or with pre-fabricated cable and ground leads

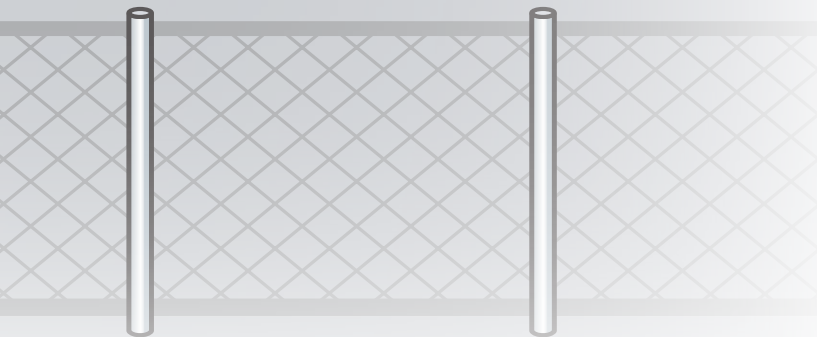

## A235 Pre-fabricated Fence Clamp Assemblies with Single Ground Lead

### Part Number Coding

Example: **A235 B 2C 3 LH**

Nominal pipe size (inches) | Cable Code (AWG) | Left Hand (LH) or Right Hand (RH) | Ground Lead Length (feet)

B = 1-1/4" F = 3"  
 C = 1-1/2" G = 3-1/2"  
 D = 2" H = 4"  
 E = 2-1/2"

Cable Code (AWG)  
 2C = 1/0 Stranded  
 2G = 2/0 Stranded  
 2Q = 4/0 Stranded

Part Number	Nominal Pipe Size (in)	Cable Size (AWG)	Ground Lead Length (ft)
A235B2C3LH	1-1/4	1/0 Stranded	3
A235C2C1LH	1-1/2	1/0 Stranded	1
A235C2C1RH	1-1/2	1/0 Stranded	1
A235C2G2LH	1-1/2	2/0 Stranded	2
A235D2C1RH	2	1/0 Stranded	1
A235D2G2LH	2	2/0 Stranded	2
A235D2Q4RH	2	4/0 Stranded	4
A235E2C3RH	2-1/2	1/0 Stranded	3
A235E2G4LH	2-1/2	2/0 Stranded	4
A235E2Q2RH	2-1/2	4/0 Stranded	2
A235F2G2LH	3	2/0 Stranded	2
A235F2Q10RH	3	4/0 Stranded	10
A235F2Q5RH	3	4/0 Stranded	5
A235G2Q2RH	3-1/2	4/0 Stranded	2
A235G2Q4RH	3-1/2	4/0 Stranded	4
A235H2C4RH	4	1/0 Stranded	4
A235H2Q2LH	4	4/0 Stranded	2
A235H2Q2RH	4	4/0 Stranded	2

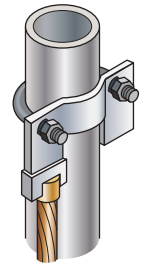

Left hand shown

## B522 Fence Clamps for Field-Welded Connections

Part No.	Nominal Pipe Size (in)
B522B	1-1/4
B522C	1-1/2
B522D	2
B522E	2-1/2
B522F	3
B522G	3-1/2
B522H	4
B522K	6

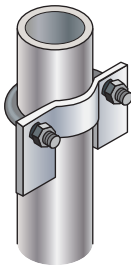

Cable Size (AWG)	Cadweld Mold Part Number	Welding Material
1/0	LAC2C002	65
2/0	LAC2G002	65
4/0	LAC2Q002	90



## A237 Pre-fabricated Fence Clamp Assemblies with Double Ground Leads

### Part Number Coding

Example: **A237 C 2Q 8**

Nominal pipe size (inches) | Cable Code (AWG) | Length of each Ground Lead (feet)

B = 1-1/4" F = 3"  
 C = 1-1/2" G = 3-1/2"  
 D = 2" H = 4"  
 E = 2-1/2"

Cable Code (AWG)  
 2C = 1/0 Stranded  
 2G = 2/0 Stranded  
 2Q = 4/0 Stranded

Part Number	Nominal Pipe Size (in)	Cable Size (AWG)	Length of Each Ground Lead (ft)
A237C2Q8	1-1/2	4/0 Stranded	8
A237D2G1	2	2/0 Stranded	1
A237D2G2	2	2/0 Stranded	2
A237D2Q4	2	4/0 Stranded	4
A237E2Q1	2-1/2	4/0 Stranded	1
A237E2Q4	2-1/2	4/0 Stranded	4
A237F2C6	3	1/0 Stranded	6
A237F2Q4	3	4/0 Stranded	4
A237H2C1	4	1/0 Stranded	1
A237H2C4	4	1/0 Stranded	4
A237H2Q4	4	4/0 Stranded	4

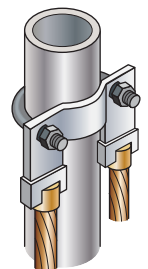

# Fence Clamp Assemblies

## A238 Pre-fabricated Gate Jumper Assemblies

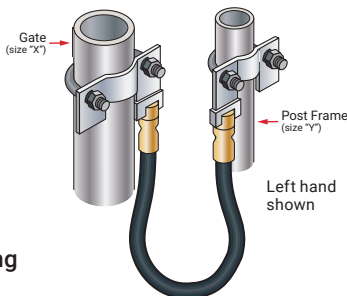

### Part Number Coding

Example:

**A238 "XY" 2S 12 LH**

Nominal Gate Size (in) "X"	Nominal Post Frame Size (in) "Y"	Clamp Codes "XY"	4/0 AWG Flexible Jumper Designation	Jumper Length (inches)	Left Hand (LH) or Right Hand (RH)
2 1/2	1 1/4	EB	4/0 AWG Flexible Jumper Designation	12	Left Hand (LH) or Right Hand (RH)
	1 1/2	EC			
3	1 1/4	FB			
	1 1/2	FC			
3 1/2	1 1/4	GB			
	1 1/2	GC			
4	1 1/4	HB		24	Left Hand (LH) or Right Hand (RH)
	1 1/2	HC			

Part Number	Nominal Gate Size (in)	Nominal Post Frame Size (in)	Jumper Cable Size (AWG)	Jumper Length (in)
A238EB2S12LH	2 1/2	1 1/4	4/0 Stranded	12
A238EB2S12RH	2 1/2	1 1/4	4/0 Stranded	12
A238EB2S18RH	2 1/2	1 1/4	4/0 Stranded	18
A238EC2S12LH	2 1/2	1 1/2	4/0 Stranded	12
A238EC2S24RH	2 1/2	1 1/2	4/0 Stranded	24
A238EC2S8LH	2 1/2	1 1/2	4/0 Stranded	8
A238FB2S24LH	3	1 1/4	4/0 Stranded	24
A238FC2S12LH	3	1 1/2	4/0 Stranded	12
A238FC2S18RH	3	1 1/2	4/0 Stranded	18
A238FC2S24LH	3	1 1/2	4/0 Stranded	24
A238GC2S12LH	3 1/2	1 1/2	4/0 Stranded	12
A238GC2S18RH	3 1/2	1 1/2	4/0 Stranded	18
A238GC2S24LH	3 1/2	1 1/2	4/0 Stranded	24
A238HB2S18LH	4	1 1/4	4/0 Stranded	18
A238HB2S18RH	4	1 1/4	4/0 Stranded	18
A238HC2S12LH	4	1 1/2	4/0 Stranded	12
A238HC2S15RH	4	1 1/2	4/0 Stranded	15
A238HC2S24LH	4	1 1/2	4/0 Stranded	24

## STEEL PIPE SIZES (SCHEDULE 40)

Nominal Steel Pipe Size (in)	Outside Diameter (in)	Outside Diameter to Nearest Fraction (in)
1	1.315	1 5/16
1 1/4	1.660	1 5/8
1 1/2	1.900	1 7/8
2	2.375	2 3/8
2 1/2	2.875	2 7/8
3	3.500	3 1/2
3 1/2	4.000	4
4	4.500	4 1/2



## A239 Pre-fabricated Gate Jumper Assemblies with Ground Lead

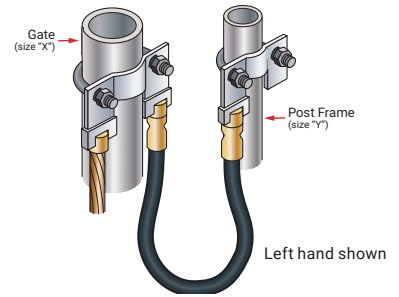

### Part Number Coding

Example:

**A239 "XY" 2S 24 2Q 3 LH**

Nominal Gate Size (in) "X"	Nominal Post Frame Size (in) "Y"	Clamp Codes "XY"	4/0 AWG Flexible Jumper Designation	Jumper Length (inches)	Ground Lead Length (feet)	Left Hand (LH) or Right Hand (RH)
2 1/2	1 1/4	EB	4/0 AWG Flexible Jumper Designation	24	3	Left Hand (LH) or Right Hand (RH)
	1 1/2	EC				
3	1 1/4	FB				
	1 1/2	FC				
3 1/2	1 1/4	GB				
	1 1/2	GC				
4	1 1/4	HB		2	2	Left Hand (LH) or Right Hand (RH)
	1 1/2	HC				

Part Number	Nominal Gate Size (in)	Nominal Post Frame Size (in)	Jumper Cable Size (AWG)	Jumper Length (in)	Ground Lead Cable Size (AWG)	Ground Lead Length (ft)
A239EB2S242Q3LH	2 1/2	1 1/4	4/0 Stranded	24	4/0 Stranded	3
A239EB2S242Q3RH	2 1/2	1 1/4	4/0 Stranded	24	4/0 Stranded	3
A239EB2S242Q4LH	2 1/2	1 1/4	4/0 Stranded	24	4/0 Stranded	4
A239EC2S182Q6LH	2 1/2	1 1/2	4/0 Stranded	18	4/0 Stranded	6
A239EC2S242C8RH	2 1/2	1 1/2	4/0 Stranded	24	1/0 Stranded	8
A239EC2S242G4LH	2 1/2	1 1/2	4/0 Stranded	24	2/0 Stranded	4
A239EC2S249F6LH	2 1/2	1 1/2	4/0 Stranded	24	#9, 19-Strand	6
A239EC2S249F6RH	2 1/2	1 1/2	4/0 Stranded	24	#9, 19-Strand	6
A239FC2S142C2RH	3	1 1/2	4/0 Stranded	14	1/0 Stranded	2
A239FC2S242C6LH	3	1 1/2	4/0 Stranded	24	1/0 Stranded	6
A239FC2S242G4RH	3	1 1/2	4/0 Stranded	24	2/0 Stranded	4
A239FC2S242Q10R	3	1 1/2	4/0 Stranded	24	4/0 Stranded	10
A239GB2S242Q4LH	3 1/2	1 1/4	4/0 Stranded	24	4/0 Stranded	4
A239GB2S242Q4RH	3 1/2	1 1/4	4/0 Stranded	24	4/0 Stranded	4
A239GC2S122Q2RH	3 1/2	1 1/2	4/0 Stranded	12	4/0 Stranded	2
A239GC2S242Q4LH	3 1/2	1 1/2	4/0 Stranded	24	4/0 Stranded	4
A239GC2S242Q4RH	3 1/2	1 1/2	4/0 Stranded	24	4/0 Stranded	4
A239HB2S122Q4LH	4	1 1/4	4/0 Stranded	12	4/0 Stranded	4
A239HB2S242Q1RH	4	1 1/4	4/0 Stranded	24	4/0 Stranded	1
A239HB2S242Q4LH	4	1 1/4	4/0 Stranded	24	4/0 Stranded	4
A239HC2S142C2RH	4	1 1/2	4/0 Stranded	14	1/0 Stranded	2
A239HC2S182Q6LH	4	1 1/2	4/0 Stranded	18	4/0 Stranded	6
A239HC2S189F1RH	4	1 1/2	4/0 Stranded	18	#9, 19-Strand	1
A239HC2S242C10L	4	1 1/2	4/0 Stranded	24	1/0 Stranded	10
A239HC2S242G2RH	4	1 1/2	4/0 Stranded	24	2/0 Stranded	2

# Static Grounding and Bonding



## CABLES

### A805A01F Series

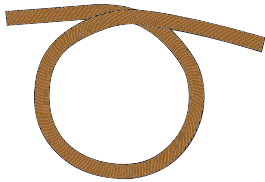

- Bare bronze cable
- Extra flexible
- 3/16" diameter

Part Number	Length (ft)
A805A01F-5	5
A805A01F-10	10
A805A01F-20	20

### A806A3F Series

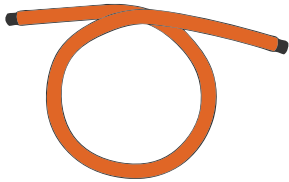

- Orange insulated bronze cable
- Extra flexible
- 3/16" diameter

Part Number	Length (ft)
A806A03F-5	5
A806A03F-10	10
A806A03F-20	20

### A822SAS Series

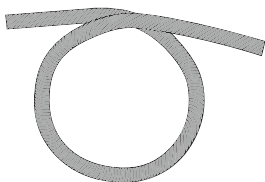

- Bare stainless steel cable
- Extra flexible
- 1/8" diameter

Part Number	Length (ft)
A822SAS-5	5
A822SAS-10	10
A822SAS-20	20

## CABLE REELS AND COILS

### A822SA111C & A822SB11C Series



- Galvanized steel
- 1/8" Orange insulated coiled cable

Part Number	Length (ft)
A822SA111C-5	5
A822SA111C-10	10
A822SA111C-20	20
A822SB111C20	20

### 20' Cable Reel B2618A\*



- Cable length: 20'
- Cable size: 3/32" diameter bare stainless steel
- Bare bronze cable
- Extra flexible

#### Features

Two 1/4" bolt holes to affix  
Uses only one cable terminator.  
Other end of cable is grounded through metal reel case.  
Plated bolting surfaces and base.

\*Static Ground Clamps Sold Separately

### 50' Cable Reel B2618B\*



- Cable length: 50'
- Cable size: 3/32" diameter bare stainless steel

#### Features

Two 1/2" bolt holes to affix  
Uses only one cable terminator.  
Other end of cable is grounded through metal reel case.  
Plated bolting surfaces and base.

\*Static Ground Clamps Sold Separately

# Static Grounding and Bonding

## STATIC GROUNDING CLAMPS

### B2610A Spring Clamp



- Bare bronze cable
- Extra flexible

#### Features

Die Cast Aluminum  
 Max Jaw Opening: 1"  
 Throat Depth: 1"  
 Max Cable Size: 1/8"  
 Contact Points: 2 ea., Stainless Steel  
 Release Harness: Not Available

### B2611A Spring Clamp



#### Features

Die Cast Aluminum  
 Max Jaw Opening: 1-1/2"  
 Throat Depth: 2"  
 Max Cable Size: 3/16"  
 Contact Points: 3 ea., Stainless Steel  
 Release Harness: Included

### B2614A Spring Clamp



#### Features

Bronze  
 Max Jaw Opening: 1"  
 Throat Depth: 2-1/2"  
 Max Cable Size: 3/16"  
 Length: 9-1/2"  
 Contact Points: 3 ea., Stainless Steel  
 Release Harness: Included

### B2617A Aircraft Grounding Clamp



#### Features

Die Cast Aluminum  
 Max Jaw Opening: 3/4"  
 Throat Depth: 5/32"  
 Max Cable Size: 3/16"  
 Contact Points: Plated Steel  
 Release Harness: Not Available  
 Fits rods up to 3/4" and Cadweld Aircraft Grounding Receptacles B165 and B166

## "C" CLAMPS

### "C" Clamp B2615B



#### Features

Bronze  
 Max Jaw Opening: 1-1/4"  
 Throat Depth: 1-1/2"  
 Max Cable Size: 3/16"  
 Length: 2-1/2"  
 Contact Point: Bronze, Includes Crimp Lug

## STATIC GROUNDING COMPONENTS

### B750A Static Grab Bar

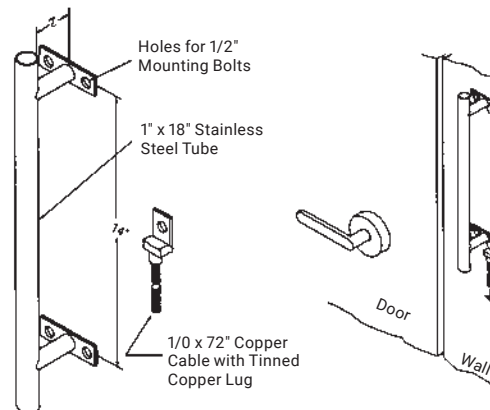

- Stainless Steel
- Length: 18"
- Furnished with 6' of 1/0 AWG copper conductor with a tinned copper lug
- Cadweld lug attached for connecting to the ground system

Application – Touch before entry into static controlled assembly area.



# Ground Resistance Testers

**Resistance Tester**  
Pg 123



**Ground Tester Kits**  
Pg 122



**Cable Reels**  
Pg 123

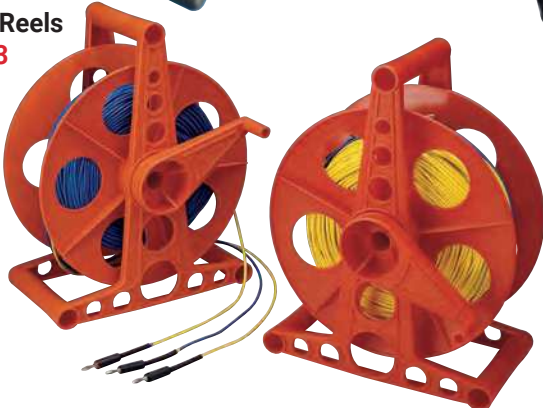

**Clamp on Probe**  
Pg 123



# Ground Resistance Testers

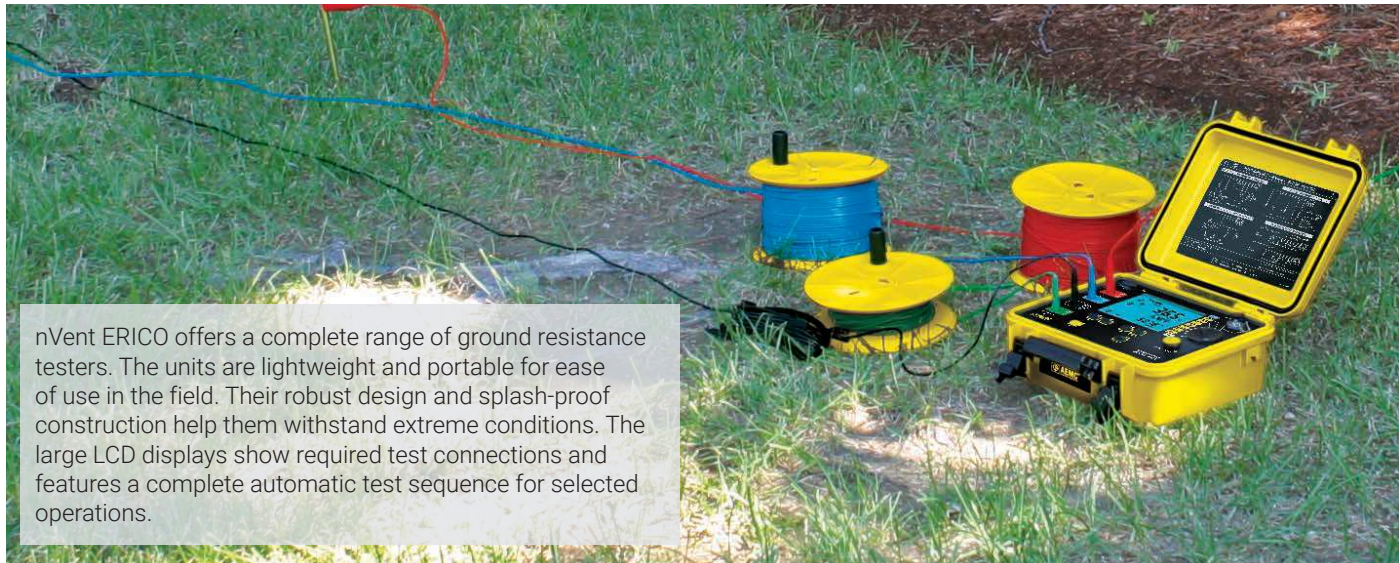

nVent ERICO offers a complete range of ground resistance testers. The units are lightweight and portable for ease of use in the field. Their robust design and splash-proof construction help them withstand extreme conditions. The large LCD displays show required test connections and features a complete automatic test sequence for selected operations.

## Ground Tester Kits



Part Number	Description	Unit Weight (lbs)
EST4620	2-, 3- and 4-Point Ground Tester Kit	35.07
	<ul style="list-style-type: none"> <li>Measures ground resistance (2- and 3-Point) and soil resistivity (4-Point)</li> <li>Step voltage tests and touch potential measurements</li> <li>Battery powered</li> </ul>	
EST4630	2-, 3- and 4-Point Ground Tester Kit	35.01
	<ul style="list-style-type: none"> <li>Measures ground resistance (2- and 3-Point) and soil resistivity (4-Point)</li> <li>Step voltage tests and touch potential measurements</li> <li>AC powered with rechargeable NiMH batteries</li> </ul>	
EST6472	2-, 3- and 4-Point Ground Tester Kit (**)	37.08
	<ul style="list-style-type: none"> <li>3-Point Fall-of-Potential measurement with manual or automatic frequency selection and automatic lead compensation</li> <li>4-Point soil resistivity measurement with automatic calculation of Rho and user selection of Wenner or Schlumberger test method</li> <li>Earth coupling testing (3-Point earth coupling measurement)</li> <li>Manual or automatic frequency scan from 40 to 513Hz for test accuracy in electrically noisy environments</li> <li>Selectable test voltage 16 or 32V up to 250mA test current</li> <li>2- and 4-Wire DC resistance measurement (Bond testing) with automatic polarity reversal</li> <li>Ground resistance with 2 clamps (no auxiliary rods)</li> <li>Includes DataView® software for data storage, real-time display, analysis, report generation and system configuration</li> <li>Auto-off power management</li> <li>Automatic recognition of all electrode connections and their resistance value</li> <li>Stores up to 512 complete test results in internal memory</li> <li>Optically isolated USB communication</li> <li>AC powered with rechargeable NiMH batteries from wall charger or vehicle power</li> </ul>	

- Fall-of-Potential method
- Auto-ranging: automatically selects the optimum range
- Designed to reject high levels of noise and interference
- Extremely simple to operate: connect – press – read
- LED on faceplate informs operator of high input noise, high auxiliary rod resistance and fault connections
- May also be used for continuity tests on bonding
- Rugged dustproof and rainproof field case
- Color-coded terminals
- CE Mark

### \* Kits include:

- Two 300' color-coded leads on spools (red and blue)
- Two 100' color-coded leads (green and black)
- Four 14.5" T-shaped auxiliary ground electrodes
- One set of five spaded lugs
- 100' tape measure
- Carrying bag

\*\* Clamp-on probe sold separately for use with EST6472

# Ground Resistance Testers

## Handheld Ground Resistance Tester



Part Number	Description
EST401	Handheld Ground Resistance Tester



## Cable Reels

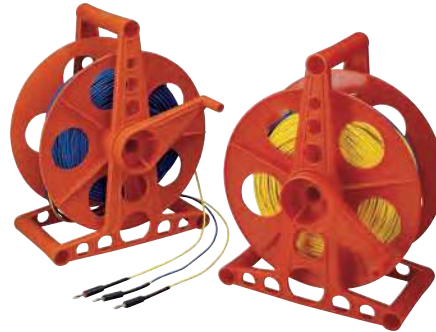

- 2 Heavy duty insulated thermoplastic 11" diameter reels with integral carrying handle, rugged base, and cranks for fast test lead retrieval
- Test leads are marked every 25' for easy auxiliary ground test stake positioning
- 500' of #18 silicone rubber insulated wire on each reel, two different colors for easy stake identification
- The far end of test lead remains attached to reel base, which eliminates tangling and speeds up the process of test stake deployment. A jack built into the reel base connects the test lead to the test stake with an included jumper

## GROUND RESISTANCE TESTER MODEL COMPARISON

Models	EST3640	EST4610	EST4630
Type of Measurements	2 & 3 Point	2, 3, & 4 Point	2, 3, & 4 Point
Soil Resistivity Test	No	Yes	Yes
Range	20 $\Omega$	200 $\Omega$	2000 $\Omega$
Measurement Ranges	0.00 to 19.99 $\Omega$	20.0 to 199.9 $\Omega$	200 to 1999 $\Omega$
Resolution	10 m $\Omega$	100 m $\Omega$	1 $\Omega$
Test Current	10 mA	1 mA	0.1 mA
Open Voltage	<42V Peak		
Operating Frequency	128 Hz Square Wave		
Accuracy	+/- 2% of Reading +/- 1 ct		+/- 3% of Reading +/- 3 ct
Fuse Protection	0.1 A, >250 V, 0.25 x 1.25"; 30 kA Interrupt Capacity	High breaking capacity, 0.1 A, >250 V	
	Low Battery Indication		
Test Kit Included	Yes	Yes	Yes

## Clamp-on Probe



Part Number	Description	Unit Weight (lbs)
ESR182	Clamp-on Probe for use with EST6472 ***	3.0

Part Number	Description	Unit Weight (lbs)
ESTREELKIT500	500 ft. Cable Reels	17.0

# Technical Information

## CONCENTRIC STRANDED CONDUCTOR SIZES

Size (AWG/MCM/mm <sup>2</sup> )	Circular Mils	Stranding	Nominal O.D. of Strand	Approx. O.D. (inches)	Approx. O.D. (mm)	Weight (lbs/mft)	Cadweld Cable Code
8 AWG	16,510	Solid	–	0.1285	3.26	50.0	1D
8 AWG	16,510	7/.0486"	0.0486	0.1460	3.71	50.1	1E
6 AWG	26,240	Solid	–	0.1620	4.11	79.5	1G
6 AWG	26,240	7/.0612"	0.0612	0.1840	4.67	81.1	1H
16 mm <sup>2</sup>	31,600	7/1.17	0.0461	0.2010	5.11	96.1	W3
4 AWG	41,740	Solid	–	0.2043	5.19	126.3	1K
4 AWG	41,740	7/.0772"	0.0772	0.2320	5.89	129.0	1L
4 AWG	41,740	19/.0469"	0.0469	0.2350	5.97	129.0	1L
25 mm <sup>2</sup>	49,300	7/2.14 mm	0.0843	0.2530	6.43	152.5	Y1
25 mm <sup>2</sup>	49,300	19/1.35	0.0531	0.2660	6.76	152.5	Y1
2 AWG	66,360	Solid	–	0.2576	6.54	200.9	1T
2 AWG	66,360	7/.0974"	0.0974	0.2920	7.42	204.9	1V
2 AWG	66,360	19/.0591"	0.0591	0.2920	7.42	205.0	1V
35 mm <sup>2</sup>	66,360	19/1.53 mm	0.0602	0.3010	7.65	211.0	Y2
50 mm <sup>2</sup>	98,500	19/1.78 mm	0.0701	0.3500	8.89	287.6	Y3
1/0 AWG	105,600	Solid	–	0.3249	8.25	319.5	2B
1/0 AWG	105,600	7/.1228"	0.1228	0.3690	9.37	326.0	2C
1/0 AWG	105,600	19/.0745"	0.0745	0.3730	9.47	326.0	2C
2/0 AWG	133,100	Solid	–	0.3648	9.27	402.8	2F
2/0 AWG	133,100	7/.1379"	0.1379	0.4140	10.52	410.9	2G
2/0 AWG	133,100	19/.0837"	0.0837	0.4190	10.64	410.9	2G
70 mm <sup>2</sup>	138,000	19/2.14 mm	0.0843	0.4210	10.69	415.3	Y4
3/0 AWG	167,800	Solid	–	0.4096	10.40	507.8	2K
3/0 AWG	167,800	7/.1548"	0.1548	0.4650	11.81	518.0	2L
3/0 AWG	167,800	19/.0940"	0.0940	0.4700	11.94	518.0	2L
95 mm <sup>2</sup>	187,000	37/1.78 mm	0.0700	0.4910	12.47	576.5	Y5
95 mm <sup>2</sup>	187,000	19/2.52	0.0992	0.4960	12.60	576.5	Y5
4/0 AWG	211,600	Solid	–	0.4600	11.68	610.5	2P
4/0 AWG	211,600	7/.1739"	0.1739	0.5220	13.26	653.0	2Q
4/0 AWG	211,600	19/.1055"	0.1055	0.5280	13.41	653.0	2Q
120 mm <sup>2</sup>	237,000	37/2.03 mm	0.0799	0.5600	14.22	737.1	Y6
250 MCM	250,000	19/.1147"	0.1147	0.5750	14.61	771.0	2V
250 MCM	250,000	37/.0822"	0.0822	0.5750	14.61	771.0	2V
150 mm <sup>2</sup>	296,000	37/2.25 mm	0.0886	0.6200	15.75	896.4	Y7
300 MCM	300,000	19/.1257"	0.1257	0.6290	15.98	926.9	3A
300 MCM	300,000	37/.0900"	0.0900	0.6290	15.98	926.9	3A
185 mm <sup>2</sup>	365,000	27/2.52 mm	0.0992	0.6950	17.65	1124.1	Y8
400 MCM	400,000	37/.1040	0.1040	0.7200	18.29	1235.2	3H
240 mm <sup>2</sup>	474,000	61/2.25 mm	0.0886	0.7970	20.24	1478.2	Y9
500 MCM	500,000	19/.1622"	0.1622	0.8130	20.65	1544.0	3Q
500 MCM	500,000	37/.1162"	0.1162	0.8130	20.65	1544.0	3Q
750 MCM	750,000	61/.1109"	0.1109	0.9980	25.35	2316.0	4L
500 mm <sup>2</sup>	987,000	61/3.20 mm	0.1260	1.1340	28.80	2990.8	W1
1000 MCM	1,000,000	61/.1280"	0.1280	1.1520	29.26	3088.0	4Y

# Technical Information

## DSA COPPER-BONDED CONDUCTOR

Cable Stranding	Nominal Diameter	kcmil	Equivalent Copper Size*	Cadweld Cable Code
7/#10	.306	72.7	3 AWG	9A
7/#8	.385	115.6	1	9B
7/#7	.433	145.7	1/0	9C
7/#6	.486	183.8	2/0	9D
7/#5	.546	231.7	3/0	9E
19/#9	.572	248.8	3/0	9F
7/#4	.613	292.2	4/0	9L
19/#8	.642	313.7	4/0	9G
19/#7	.721	395.5	250 Kcmil	9H
37/#9	.801	484.4	300	7W
19/#6	.810	498.8	350	9J
37/#8	.899	610.9	400	7V
19/#5	.910	628.9	450	9K
37/#7	1.010	770.3	500	9M

\*Approximate based on fusing current calculations

## BARE COPPER-BONDED CONDUCTOR

Nominal Size	Material	Type	Thread Size	Body Dia.	Cadweld Ground Rod Code
1/2"	Copper-bonded	Sectional	9/16"	.505	14
	Steel*	Plain		.500	14
	Copper-bonded	Plain	1/2"	.475	15
	Copper-bonded	Sectional		.447	13
5/8"	Copper-bonded	Sectional	5/8"	.563	16
	Steel*	Plain		.625	31
	Copper-bonded	Plain	3/4"	.563	16
	Copper-bonded	Sectional		.682	18
3/4"	Steel*	Plain	3/4"	.750	33
	Copper-bonded	Plain		.682	18
	Copper-bonded	Sectional		.914	22
1"	Steel*	Plain	1"	1.000	37
	Copper-bonded	Plain		.914	22

\*Plain steel, stainless steel, stainless clad rods or galvanized steel.

## RECTANGULAR COPPER BUSBAR

Thickness (inches)	Width (inches)	Circular Mil Size	Weight (lbs per foot)	Cadweld Busbar Code
1/8	1	159,200	.484	CE
	1-1/2	238,700	.726	CG
	2	318,300	.969	CH
3/16	1	238,700	.727	DE
	2	477,500	1.45	DH
	1	318,300	.969	EE
	1-1/2	477,500	1.45	EG
	2	636,600	1.94	EH
1/4	3	954,900	2.91	EK
	4	1,273,000	3.88	EM
	1	477,500	1.45	GE
	1-1/2	716,200	2.18	GG
	2	954,900	2.91	GH
3/8	3	1,432,000	4.36	GK
	4	1,910,000	5.81	GM
	2	1,273,000	3.88	JH
1/2	3	1,910,000	5.81	JK
	4	2,546,000	7.75	JM

## REINFORCING BARS

Rebar Sizes	Nominal Dimensions		Equivalent Copper Sizes*	Cadweld Rebar Code
	Dia. (inches)	Cross-Sectional Area (Sq. inches)		
3	.375	.11	9 AWG	51
4	.500	.20	7	52
5	.625	.31	5	53
6	.750	.44	3	54
7	.875	.60	2	55
8	1.000	.79	1	56
9	1.128	1.00	1/0	57
10	1.270	1.27	2/0	58
11	1.410	1.56	3/0	59
14	1.693	2.25	250 kcmil	60
18	2.257	4.00	450	61

\*Based on 8% IACS, rounded to the next higher commercial copper size.

### Useful Conversions

#### Area

Square Inches x 1273 = kcmil

Square Millimeters x 1.974 = kcmil

kcmil x 0.5067 = Square Millimeters

#### Density

Copper: 0.323 lb/in<sup>3</sup>

Steel: 0.283 lb/in<sup>3</sup>

# Technical Information

## STEEL PIPE SIZES

**Standard Weight  
(Schedule 40)**

**ASTM® A53-90-B  
ANSI®/ASME® B36.10M-1985**

Nominal Size (inches)	O.D. (inches)	Wall Thickness (inches)	Cadweld Mold Code
1	1.315	.133	1
1-1/4	1.660	.140	1.25
1-1/2	1.900	.145	1.50
2	2.375	.154	2
2-1/2	2.875	.203	2.50
3	3.500	.216	3
3-1/2	4.000	.226	3.50
4	4.500	.237	4
5	5.563	.258	5
6	6.625	.280	6
8	8.625	.322	8
10	10.750	.365	10

## OTHER STANDARD SECTIONS USED FOR FENCE POSTS

Section	Cadweld Mold Code
1-1/2" square	PS15
2" square	PS20
2-1/2" square	PS25
3" square	PS30*
1.875 x 1.625 x .133 "H"	PH1
2.25 x 1.95 .143 "H"	PH2

\*For D or F mold price only.

### WARNING

nVent ERICO products shall be installed and used only as indicated in nVent ERICO's product instruction sheets and training materials. Instruction sheets are available at [nVent.com/ERICO](http://nVent.com/ERICO) and from your nVent ERICO customer service representative. Improper installation, misuse, misapplication or other failure to completely follow nVent ERICO's instructions and warnings may cause product malfunction, property damage, serious bodily injury and death.



Our powerful portfolio of brands:

**CADDY ERICO HOFFMAN RAYCHEM SCHROFF TRACER**



[nVent.com/ERICO](https://nVent.com/ERICO)

ANSI is a registered trademark of the American National Standards Institute. ASME is a registered trademark of the American Society of Mechanical Engineers. ASTM is a registered trademark of American Society for Testing and Materials. BICSI is a registered trademark of BICSI, Inc. CSA is a registered trademark of The Canadian Standards Association Int'l. cULus is a registered trademark of Underwriters Laboratories, Inc. DataView is a registered trademark of Chauvin Arnoux, Inc. EIA is a registered service mark of the Electronic Industries Alliance. IEEE is a registered trademark of The Institute of Electrical and Electronics Engineers, Inc. NEC is a registered trademark of, and National Electrical Code (NEC) standard is a copyright of the National Fire Protection Association. NEMA is a registered trademark of the National Electrical Manufacturers Association. NFPA is a registered trademark of the National Fire Protection Association. NFPA standard is a copyright of the National Fire Protection Association. NFPA is a registered trademark of the National Fire Protection Association. SAE is a registered trademark of SAE International. TIA is a registered service mark of the Telecommunications Industry Association.

©2022 nVent. All nVent marks and logos are owned or licensed by nVent Services GmbH or its affiliates. All other trademarks are the property of their respective owners. nVent reserves the right to change specifications without notice.  
ERICO-CAT-H86962-GroundingAndBonding-USEN-2209