

# Type BPRD Regulator By-Pass Switch for Distribution Switching



**HUBBELL POWER SYSTEMS, INC.**  
210 North Allen Street  
Centralia, MO 65240-1395 U.S.A.  
Telephone: (573) 682-5521

**IMPORTANT!**  
Keep this manual readily  
available for future reference.

Printed in U.S.A.  
P8050211 Rev. D

©2006, 2008 & 2010 Hubbell Power Systems, Inc., 210 North Allen Street, Centralia, MO 65240 U.S.A.

# Warnings

	<b>⚠ DANGER</b>
	<p><b>Electrical equipment contains hazardous voltages and high speed moving parts. Contact with these hazards will cause death, serious personal injury or damage equipment.</b></p> <p>Only qualified personnel shall install, operate and maintain this equipment. Always properly ground equipment and lock out electric power (de-energize) before maintenance. Using non-specified/unauthorized parts or components to repair equipment, or tampering with safety devices/systems will result in dangerous conditions which can cause death, severe personal injury or damage to equipment. Take note of and follow all safety instructions contained in this installation, operation and maintenance manual.</p>

## IMPORTANT

These installation, operation and maintenance instructions do not claim to cover all details or variations in equipment. Nor do they provide for all possible conditions encountered while installing, operating or maintaining this equipment. If further information is desired or needed to address any particular installation, operation or maintenance problem not covered in this document, contact your authorized factory representative.

The information in this document does not relieve the user from exercising good judgment in selecting equipment for suitability of application. Nor does it relieve the user from using sound practices in installation, operation and maintenance of the equipment purchased.

Note: Because HUBBELL has a policy of continuous product improvement, we reserve the right to change design and specifications without notice. Should a conflict arise between the general information in this document and the contents of drawings or supplementary material, or both, the latter shall take precedence.

## QUALIFIED PERSON

For the purpose of this manual, a qualified person is:

- (a) **familiar with the installation, operation and maintenance** of the subject equipment and the hazards involved with its installation, operation and maintenance.
- (b) **trained** to de-energize, clear, ground, and tag circuits and equipment in accordance with established safety practices.
- (c) **trained** in the proper care and use of protective equipment such as rubber gloves, hard hat, safety glasses or face shields, flash clothing, etc., in accordance with established utility safety practices.
- (d) **trained** to render first aid.

## SUMMARY

The information in this document does not claim to cover all details or variations in equipment, nor to provide for every possible contingency encountered with installation, operation, or maintenance. Should further information be needed or problems arise that are not covered sufficiently, contact your authorized factory representative.

The contents of this document are not part of, nor do they modify, any prior or existing agreement, commitment or relationship. HUBBELL terms and conditions of sale constitute the entire obligation of HUBBELL. The warranty in the terms and conditions of sale is the sole warranty of HUBBELL. Any statements in this document do not create new warranties or modify any existing warranty.

# Overview

## Qualified Person

Only qualified trained and competent personnel that understand proper safety procedures must select, install and service this equipment.

Read and understand these instructions before installing, operating or maintaining this equipment.

This guide is not a substitute for adequate training and experience in safety procedures for this type of equipment.

## Signal Words

The signal words "DANGER," "WARNING" and "CAUTION" (along with their assigned symbol) throughout this manual indicate the degree of hazard the user may encounter. These symbols and words are defined as:

### DANGER

DANGER indicates an imminently hazardous situation which, if not avoided, will result in death or serious injury.

### WARNING

WARNING indicates a potentially hazardous situation which, if not avoided, could result in death or serious injury.

### CAUTION

CAUTION indicates a potentially hazardous situation which, if not avoided, may result in minor or moderate injury.

### CAUTION

CAUTION used without the safety alert symbol indicates a potentially hazardous situation which, if not avoided, may result in property damage.

## Product

The products covered by this manual are the BPRD sequenced voltage regulator overhead by-pass switches for medium voltage electrical switching.

These products are designed for switching only at their rated capacities. They cannot be field modified for capacities other than what was shipped with the units. If a different capacity is desired, contact your supervisor or factory representative to secure the appropriate unit.

## Function

These products are loadbreak disconnect switches designed to provide a means for by-passing, disconnecting and isolating voltage regulators on the electrical systems.

## General

The BPRD By-Pass Switch is a single-phase 3-blade, 1-pull, hookstick operated switch. It is used for manually disconnecting a voltage regulator without interrupting normal electrical service.

The BPRD Switch is provided with a loadbreak interrupter to suppress the voltage regulator exciting current during switch opening. The BPRD has no deadending provisions.

### • No Mounting Bracket (standard)

Provides slots in the switch base for direct base to structure mounting without the use of a back strap. The structure must be drilled to match the base mounting slots. The user supplies the mounting hardware.

### • Back Strap

Provides a galvanized steel back strap and hardware for structural applications, single or double crossarms. Mounting hardware supplied consists of two each of  $\frac{1}{2}$ " diameter by 8" long and 10" long carriage bolts with square nuts and flat washers.

## Specifications

Select the proper BPRD Switch for each installation with consideration to voltage, lightning impulse withstand, continuous current, short time current withstand, and variations. If there is concern about the use of this switch as rated, consult your supervisor before installation.

- Nominal voltage ratings of 15.5 kV, 27 kV or 38 kV (model dependent)
- Lightning impulse peak withstand ratings of 110 kV or 150 kV (model dependent)
- Continuous current rating of 600 amperes
- Short time current withstand rating:
  - 25 kA symmetrical for 1 second
  - 65 kA peak



### DANGER

#### Hazardous voltage.

Will cause death, severe personal injury, or property damage.

Only qualified personnel should work on or around this equipment after becoming thoroughly familiar with this document and other publications regarding this equipment.

# Receiving & Handling

## Inspect Packaging

- Upon receipt, immediately inspect packaging for signs of damage
- Start inspection with the packaging material and proceed to the equipment within
- Look for concealed damage
- If damage is found, note damage on Bill of Lading prior to accepting delivery

**Note: Documentation of visible shipping damage can determine the outcome of any damage claim. Immediately notifying the carrier of concealed damage is essential to resolving or minimizing unsettled claims. Immediately file your claim and notify your factory representative.**

## Unpack and Operate Switch

- Place shipping crate on stable, level surface and remove top and side boards.
- Open the switch. Proper sequencing is



ensured when the by-pass blade closes as the disconnect blades open. Close the switch. Proper sequencing is ensured when the by-pass blade opens as the disconnect blades close. Refer to the Operation section of this manual on pages 5 and 6.

- If the switch fails to operate as described,

contact your supervisor or a factory representative. **DO NOT INSTALL.**

- Remove nuts holding the switch base to the crate ends and remove ends.

# Switch Installation

## Install Switch

The BPRD By-Pass Switch is available in two mounting arrangements. It may be obtained with no back strap for structure mounting or with back strap for structure, single-, or double-crossarm mounting. Select your application from the descriptions below and install the switch accordingly.

## Structure Application

- Refer to Dimension Drawing below.
- Determine the switch mounting location on the structure
- Provide a minimum of two  $\frac{9}{16}$ " diameter mounting holes in the structure matching the slot patterns as shown in the switch base detail
- Secure lifting sling as shown
- Using your company's standard practice, hoist the switch into position
- Attach the switch to the structure with  $\frac{1}{2}$ " diameter user supplied mounting hardware and torque according to your company standards.

## Back Strap Application

- Refer to pictures on front sheet.

- Secure lifting sling as shown.
- Using your company's standard practice, hoist the switch into position.
- Attach the switch using the provided back strap and appropriate length bolts.
- Adjust the bolts in the switch base and back strap slots to fit close to the crossarms or structure members.
- Torque mounting hardware nuts to 60 ft-lb.

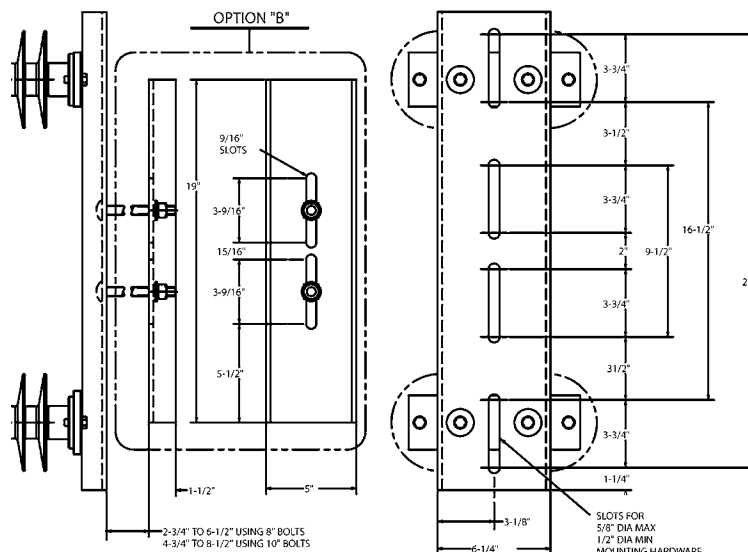

# Wiring

Use your company's standard practices for conductor termination.

## Operation

### General

Operation of the BPRD By-Pass Switch is shown in Figures 1 and 2. In normal operation, the by-pass blade is open and the two disconnect blades are closed (Figure 1), allowing the regulator to be in the circuit. When isolation of the regulator is required, a single pull on the pull ring closes the by-

pass blade and opens the disconnect blades (Figure 2) to isolate the regulator from the circuit.

- Position yourself below and in front of the switch's hook stick pull ring.
- Position feet and body in a manner that provides good stability and allows for hook stick use without losing a steady

footing.

- Under ice conditions, be prepared to use greater force to overcome the additional resistance.
- Allow a minimum of 24 inches (610 mm) clearance from the bottom of the hook stick to the ground or other objects for uninterrupted hookstick travel.

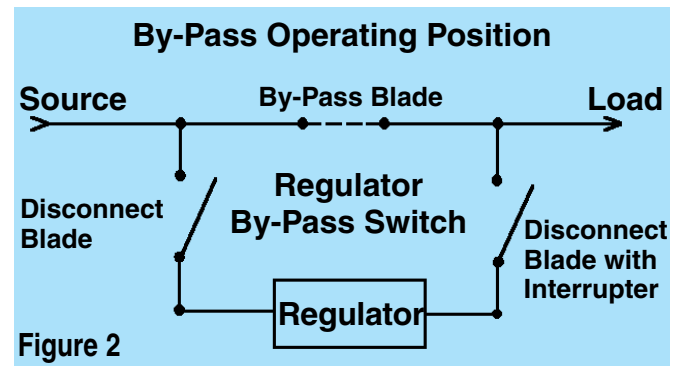
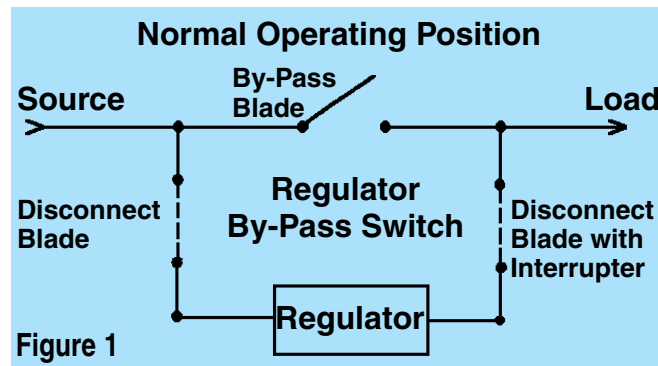

For three-phase induction regulators, contact your supervisor or your authorized factory representative.

	<b>WARNING</b>
	<p>This switch is not designed for by-passing single-core, three-phase induction regulators.</p> <p>Consult your supervisor or authorized factory representative for these applications.</p>

### Closing Switch

- To close the BPRD Switch, place a hookstick in the pull ring as shown.
- Turn head and look away from the switch.

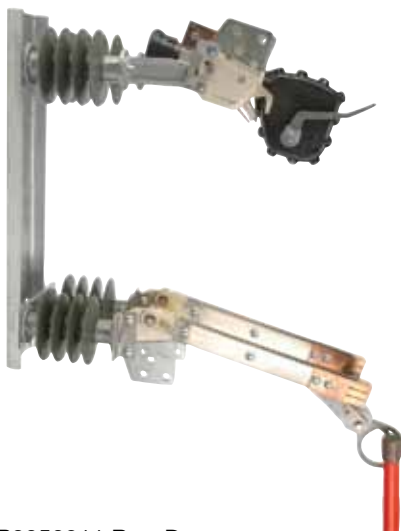

- **Quickly, firmly and without hesitation** drive the switch to the closed position.
- Carefully remove the hookstick from the pull ring to avoid opening the switch.
- The BPRD Switch is properly closed when the blades are fully engaged and the

"Hook" portion of the pull ring extends through the guide/latch slot.

- Reset voltage regulator automatic control to desired settings.

# Operation

- When by-passing a voltage regulator, follow the steps outlined below.

## Opening Switch

- Set voltage regulator automatic control to manual. Set voltage regulator to its neutral position. By-pass blade is open and disconnect blades are closed.
- The BPRD is a single pull, sequenced switch. A single pull on the pull ring performs the four switching operations (A, B, C, D) in the proper sequence.
  - Place a hookstick in the pull ring as shown below.
  - Turn head and look away from the switch.
  - Quickly, firmly and without hesitation** pull down until the disconnect blades are fully opened to stop position.
  - Remove the hookstick from the pull ring when switch is fully opened.



	<b>⚠ WARNING</b>
	<p><b>High Voltage Circulating Current Hazard.</b></p> <p>By-passing a voltage regulator without first setting the regulator to its neutral position can cause excessively high circulating currents.</p> <p>Can cause death, severe personal injury, regulator or property damage.</p> <p>Set regulator to its neutral position before performing a by-pass operation.</p>

	<b>⚠ WARNING</b>
	<p><b>High Voltage Circulating Current Hazard.</b></p> <p>An out-of-sequence regulator by-pass switch can cause excessively high circulating currents.</p> <p>Can cause death, severe personal injury, regulator or property damage.</p> <p>Ensure regulator by-pass switch is properly sequenced before operating.</p>

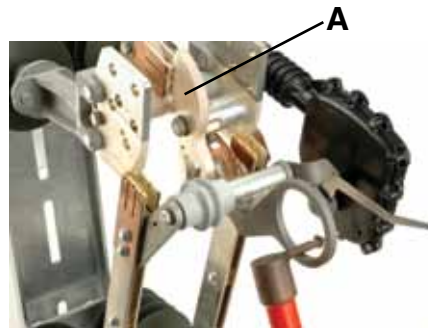

A. By-pass blade closes.

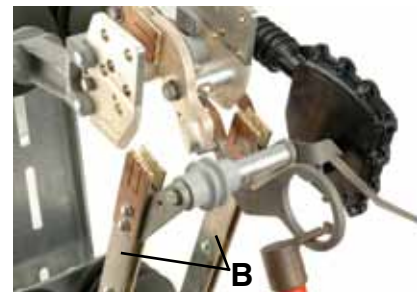

B. Source disconnect blades open.



C. Load disconnect blade opens through interrupter.

D. Interruption of regulator exciting current.

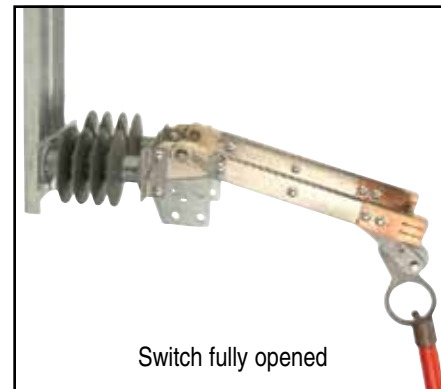

Switch fully opened

Remove the hookstick from the pull ring when switch is fully opened.

- During the closing operation, the automatic sequence is reversed. The enforced sequence operation minimizes the possibility of operator error.



# Maintenance



## General

Prolong the life of the BPRD By-Pass Switch with a periodic inspection and maintenance program. Although the switch is designed for long-term exposure in all weather conditions, certain environments may reduce its life without periodic maintenance. Following these minimum inspection and maintenance procedures will help ensure long service life.

**Note: It is recommended that all switches go through a maintenance check at least once a year; more frequently if located in a contaminated area.**

For additional recommendations, refer to ANSI C37.35 "IEEE Guide for the Application, Installation, Operation, And Maintenance of High Voltage Air Disconnect and Load Interrupter Switches."

	 <b>DANGER</b>
	<p><b>Hazardous voltage.</b></p> <p>Contact with energized lines will result in death, personal injury or property damage.</p> <p>All maintenance work should be performed on de-energized switches. If work must be performed on live lines, follow your company's standard safe operating procedures.</p>

	 <b>WARNING</b>
	<p><b>Hazardous voltage.</b></p> <p>Can cause death, severe personal injury.</p> <p>Contact with the switch bases, hardware or crossarm could result in electrical shock. Ground the switch bases and mounting hardware prior to maintenance.</p>

## Switch

Operate the switch periodically to clean contact surfaces to keep parts moving freely.

- Check for burned or pitted contacts and replace if necessary. Lubricate if necessary with Dow Corning FS-1292 grease.
- Check the hinge bolts for looseness. If loose, clean bolt threads, apply Loctite®-271 and torque to 40-in-lb.
- Inspect all blade rivets for tightness and replace blade assembly if loose.
- Inspect the mounting hardware and tighten according to specifications located in the Installation Section of the manual.
- Replace any damaged or tracked insulators. Clean or replace if heavily contaminated. Consult your authorized factory representative for authorized replacement insulators.

## Conductors

- Be sure all conductors are routed so they do not interfere with switch operation
- Inspect all conductors to be sure terminations are tight and corrosion free
- If necessary, clean and apply contact sealing paste (Chance Z.L.N. or equivalent) and retighten terminations.

# Notes/Records

---