

Zelio Logic

Smart relays

Quick access to product information

Get technical information about your product

References

Modicon TM3
I/O expansion modules for Modicon controllers
Analog I/O modules

Number and type of channels	Input range	Output range	Resolution	Input format (internal product)	Reference	Weight (kg)
2 voltage/current inputs	-15...+10 VDC 0...10 VDC 0...20 mA A, 20 mA	16.00V or 12.00V 4 sign	16.00V or 12.00V 4 sign	0.001V 0.001V 0.001V	TM3AI2H TM3AI2HG TM3AI2H	0.110 0.204 0.100
4 voltage/current inputs	-15...+10 VDC 0...10 VDC 0...20 mA A, 20 mA	16.00V or 12.00V 4 sign	16.00V or 12.00V 4 sign	0.001V 0.001V 0.001V	TM3AI4H TM3AI4HG TM3AI4H	0.110 0.204 0.100
4 differential temperature inputs (I, K, R, S, T, E, C, J) or 2 differential pressure (RTD: Ni100, Ni1000, Pt100, Pt1000)	Thermopiles or RTD (I, K, R, S, T, E, C, J) -15...+10 VDC 0...20 mA A, 20 mA	16.00V or 12.00V 4 sign	16.00V or 12.00V 4 sign	0.1V 0.1V 0.1V	TM3TI4 TM3TI4G TM3TI4	0.110 0.204 0.100
4 differential temperature inputs (I, K, R, S, T, E, C, J) or 2 differential pressure (RTD: Ni100, Ni1000, Pt100, Pt1000)	Thermopiles or RTD (I, K, R, S, T, E, C, J) -15...+10 VDC 0...20 mA A, 20 mA	16.00V or 12.00V 4 sign	16.00V or 12.00V 4 sign	0.1V 0.1V 0.1V	TM3TI4G TM3TI4G TM3TI4G	0.110 0.204 0.100
8 voltage/current	-15...+10 VDC	16.00V or 12.00V 4 sign	16.00V or 12.00V 4 sign	0.001V 0.001V 0.001V	TM3AI8 TM3AI8G TM3AI8	0.110 0.204 0.100

Share Price Global (English)

Life Is On Schneider Electric

Search products, documents & more

PRODUCTS SOLUTIONS SERVICES SUPPORT ABOUT US

All products Industrial Automation and Control PLC, PAC and Dedicated Controllers Distributed Input/Output (I/O) Modules Modicon TMI

View all Modicon TMI

TM3AI2H

Module TM3 - 2 analog inputs high resolution

Show more characteristics >

Related Software >

Product Datasheet User guide Catalogue CAD Document

Characteristics Documents and Downloads Technical FAQs Additional Information Dimensions Drawings >

Main

range of product Modicon TMI

product or component type Analog input module

range compatibility Modicon M251

Each commercial reference presented in a catalog contains a hyperlink. Click on it to obtain the technical information of the product:

- Characteristics, Dimensions and drawings, Mounting and clearance, Connections and schemas, Performance curves
- Product image, Instruction sheet, User guide, Product certifications, End of life manual

Find your catalog

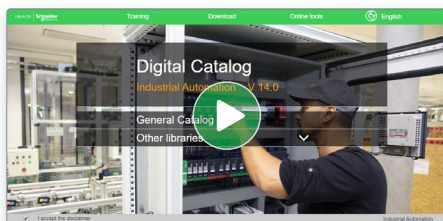

- > With just 3 clicks, you can access the Industrial Automation and Control catalogs, in both English and French
- > Consult digital automation catalogs at [Digi-Cat Online](#)

Industrial Automation

General Catalog

Plastication, Switches, Pilot Lights & Displays

Homeless 280

Product Selector

360°

Up-to-date catalogs

Embedded product selectors, 360° pictures

Optimized search by commercial references

Select your training



- > Find the right [Training](#) for your needs on our Global website
- > Locate the training center with the selector tool, using this [link](#)

Training and courses

Training by domain of expertise

Electrical Insulation and Safety

Data Center

Industrial Automation

Contents

Zelio Logic

Smart relays

General page 2

Selection guides:

□ *Compact smart relays* page 4

□ *Modular smart relays and extensions* page 6

■ Compact and modular smart relays

□ Presentation page 8

□ Functions

- Definitions page 12

- Preset functions page 13

- SFC (GRAFCET) function page 13

- Logic function page 13

- Macro function page 14

- PID function page 14

□ Description

- Compact smart relays page 15

- Modular smart relays page 15

- Digital I/O extension module page 15

□ References

- Compact smart relays with display page 16

- Modular smart relays page 18

- Digital I/O extension module page 19

- Software page 20

- Dedicated HMI page 20

- Connection accessories page 20

- Memory cartridge page 20

- Mounting accessories page 21

■ Communication

- Presentation page 22

- Programming protocol description page 23

□ Communication protocol: Modbus serial link

- Presentation page 24

- Connection examples page 25

- Functions page 26

- References page 29

□ Communication protocol: Ethernet Modbus/TCP

- Presentation, description page 27

- Functions page 28

- References page 29

■ Analogue I/O extension module

- Presentation, description page 30

- References page 31

■ Modem communication interface

- Presentation, description pages 32 and 33

- Functions, Setting-up pages 34 and 35

- References page 35

Product reference index

■ index page 36

Step into an intuitive world!



Designed for the management of simple automation systems, Zelio Logic smart relays, with their unique combination of value for money and ease of use, provide a real alternative to solutions based on hard-wired logic or dedicated cards.

Simple to select, install, and program, Zelio Logic is suitable for all your applications.

Zelio Logic is a flexible solution, offering you the choice of two ranges:

- > Compact versions with fixed configurations
- > Modular versions that allow the use of extension modules with two programming languages (FBD or ladder).

Advantages

Higher performance

- > Two times more programming memory and more function blocks by simply updating the firmware

Greater functionality

- > PID function for HVAC applications and 2G/3G modems
- > 24 VDC module inputs compatible with NTC temperature probes (programmable in FBD language)

Greater efficiency, less engineering time

- > Free software and firmware downloadable from the Schneider Electric website
- > Get to grips with the software in less than an hour, simplified tool-free programming in ladder, FBD, and SFC languages for small applications
- > Access to the program and modification of settings on integrated display

More flexibility - Easy design, maintenance, and commissioning

- > Range of compact and modular smart relays and extension modules
- > Programmable logic: a smart alternative to hard-wired logic or dedicated cards

System components



Color HMI

The Harmony Small Panel [HMISTO705](#) is recommended for Zelio Logic smart relays: 4.3" color touch screen + [EcoStruxure™ Operator Terminal Expert](#) programming software



Zelio Logic smart relay

- > Compact
- > With or without display



Zelio Logic communication module

- > GSM/UMTS modem

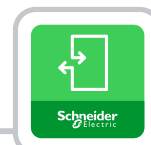

Zelio Soft 2 programming software (downloadable from our [website](#))



Zelio Logic smart relay

- > Modular
- > With display

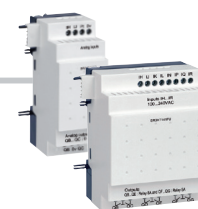

Zelio Logic I/O extension modules

- > Analog I/O
- > Discrete I/O

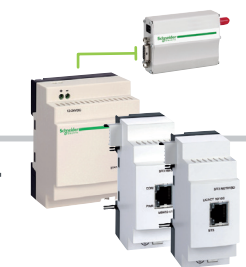

Zelio Logic communication modules

- > GSM/UMTS modem
- > Modbus serial link
- > Ethernet Modbus/TCP

Product type		Compact smart relays										
Supply voltage		24 V ~	48 V ~	100...240 V ~			12 V ---		24 V ---			
Number of I/O		12	20	20	10	12	20	12	20	10	12	20
Number of discrete inputs (including analog inputs)		8 (0)	12 (0)	12 (0)	6 (0)	8 (0)	12 (0)	8 (4)	12 (6)	6 (0)	8 (4)	12 (2), 12 (6)
Number of "relay"/"transistor" outputs		4/0	8/0	8/0	4/0	4/0	8/0	4/0	8/0	4/0	4/0, 0/4	8/0, 0/8
With display, with clock Programming language		SR2B●●1B FBD (1) or ladder	–	SR2B●●●1FU FBD (1) or ladder	SR2B●●1JD FBD (1) or ladder			SR2B●●●BD FBD (1) or ladder				
With display, without clock Programming language		–	SR2A201E Ladder only (2)	SR2A●●●1FU Ladder only (2)	–			SR2A●●●BD Ladder only (2)				
Without display, with clock Programming language		SR2E●●1B FBD (1) or ladder	–	SR2E●●●1FU FBD (1) or ladder	–			SR2E●●●BD FBD (1) or ladder				
Without display, without clock Programming language		–	–	SR2D●●●1FU Ladder only (2)	–			SR2D●●●BD Ladder only (2)				
Programming software (see page 20)		"Zelio Soft 2" ESR2SFT01 (downloadable from our website)			"Zelio Soft 2" ESR2SFT01 (downloadable from our website)							
Connection accessories (see page 20)	Serial link cable	SR2CBL01			SR2CBL01							
	USB connecting cable	SR2USB01			SR2USB01							
	Connecting cable for HMI terminals	SR2CBL09 for Harmony terminals HMISTO705 (2)			SR2CBL09 for Harmony terminals HMISTO705 (2)							
	Bluetooth interface	SR2BTC01			SR2BTC01							
Memory cartridge (see page 20)		SR2MEM02 (⚠ incompatible with SR2COM01)			SR2MEM02 (⚠ incompatible with SR2COM01)							
"Discovery" packs (see page 18)		–	SR2PACK●FU			–		SR2PACK●BD				
Modem communication interface (see page 35)		SR2COM01			SR2COM01 (for SR2B and SR2E)			SR2COM01		SR2COM01 (for SR2B and SR2E)		
GSM/UMTS modem (see page 35)		SR2MOD02			SR2MOD02			SR2MOD02		SR2MOD02		
Alarm management software (see page 35)		"Zelio Logic Alarm" ESR2SFT02 (downloadable from our website)			"Zelio Logic Alarm" ESR2SFT02 (downloadable from our website)							
Converters (thermocouple types J and K, Pt100 probes, and voltage/current)		–			–		RM●●●●BD: Refer to the Harmony Analog catalog Ref. DIA5ED2210501EN					
Power supplies for DC control circuit		–			Refer to the Modicon Power Supply catalog Ref. DIA3ED2170401EN and our website www.se.com							
References		SR2●●●1B	SR2A201E	SR2●●●1FU	SR2B●●1JD			SR2●●●●BD				
Page		16 and 17	16	16 and 17	16			16 and 17				

(1) FBD: Function block diagram.
 (2) The Harmony HMISTO705 terminals cannot be used on logic modules that only use the LADDER language.

Zelio Logic

Modular smart relays
I/O extension modules

Network communication extension modules

Product type	Modular smart relays																
Supply voltage	24 V ~			100...240 V ~			12 V ---			24 V ---							
Number of I/O	10	26		10	26		26			10	26						
Number of discrete inputs (including analog inputs)	6 (0)	16 (0)		6 (0)	16 (0)		16 (6)			6 (4)	16 (6)						
Number of "relay"/"transistor" outputs	4/0	10/0		4/0	10/0		10/0			4/0, 0/4	10/0, 0/10						
With display, with clock	Yes						Yes										
Programming language	FBD (1) or LADDER						FBD (1) or LADDER										
Programming software (see page 27)	"Zelio Soft 2" ESR2SFT01 (downloadable from our website)						"Zelio Soft 2" ESR2SFT01 (downloadable from our website)										
Connection accessories (see page 28)	Serial link cable			SR2CBL01			SR2CBL01			SR2CBL01							
	USB connecting cable			SR2USB01			SR2USB01			SR2USB01							
	Connecting cable for HMI terminals			SR2CBL09 for Harmony terminals HMISTO705			SR2CBL09 for Harmony terminals HMISTO705			SR2CBL09 for Harmony terminals HMISTO705							
	Bluetooth interface			SR2BTC01			SR2BTC01			SR2BTC01							
Memory cartridge (see page 28)	SR2MEM02 (⚠ incompatible with SR2COM01)						SR2MEM02 (⚠ incompatible with SR2COM01)										
"Discovery" packs (see page 14)	-			SR3PACK0BD			-			SR3PACK0BD							
Modem communication interface (see page 31)	SR2COM01						SR2COM01										
GSM/UMTS modem (see page 31)	SR2MOD02						SR2MOD02										
Alarm management software (see page 35)	"Zelio Logic Alarm" ESR2SFT02 (downloadable from our website)						"Zelio Logic Alarm" ESR2SFT02 (downloadable from our website)										
Converters (thermocouple types J and K, Pt100 probes, and voltage/current)	-						RM0000BD: Refer to the Harmony Analog catalog Ref. DJA5ED2210501EN										
Power supplies for DC control circuit	-						Refer to the Modicon Power Supply catalog Ref. DIA3ED2170401EN and our website www.se.com										
References	SR3B001B			SR3B001FU			SR3B261JD			SR3B000BD							
Page	18			18			18			18							
Corresponding extension module type	Discrete I/O extension modules									Network communication extension modules		I/O extension modules					
										Modbus serial link (server)		Ethernet port (server)		Analog		Discrete	
Number of I/O	6	10	14	6	10	14	6	10	14	■ Number of words: □ 4 (inputs) □ 4 (outputs) □ 4 (clock) □ 1 (status)		■ Number of words: □ 4 (inputs) □ 4 (outputs) □ 4 (clock) □ 1 (status)		4	6	10	14
Type and number of discrete inputs (or analog inputs)	4 (0)	6 (0)	8 (0)	4 (0)	6 (0)	8 (0)	4 (0)	6 (0)	8 (0)					0 (2)	4 (0)	6 (0)	8 (0)
Type and number of relay outputs (or analog outputs)	2 (0)	4 (0)	6 (0)	2 (0)	4 (0)	6 (0)	2 (0)	4 (0)	6 (0)					0 (2)	2 (0)	4 (0)	6 (0)
References	SR3XT00B			SR3XT00FU			SR3XT00JD			SR3MBU01BD		SR3NET01BD		SR3XT43BD		SR3XT00BD	
Page	19			19			19			29		31		19			

(1) FBD: Function block diagram

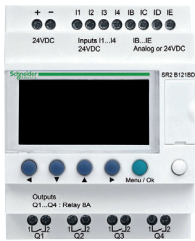

Zelio Logic compact smart relay

Combination of modular smart relays and extension modules

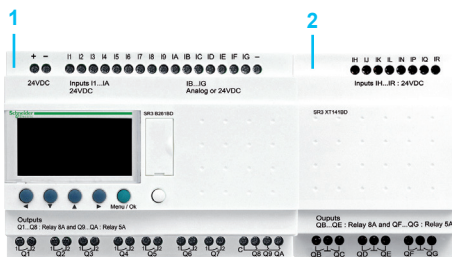

- 1 Modular Zelio Logic smart relay (10 or 26 I/O)
- 2 Discrete (6, 10, or 14 I/O) or analog (4 I/O) I/O extension module

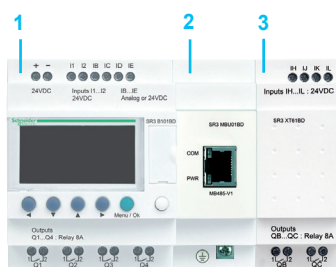

- 1 Modular Zelio Logic smart relay (10 or 26 I/O)
- 2 Modbus serial link or Ethernet Modbus/TCP network communication extension modules
- 3 Discrete (6, 10, or 14 I/O) or analog (4 I/O) I/O extension module

⚠ Observe the order of assembly above when using a Modbus server or Ethernet server network communication extension module and a discrete or analog I/O extension module.
An I/O extension module cannot be inserted before a network communication extension module.

Presentation

Zelio Logic smart relays are designed for use in small automated systems. They are used in both the industrial and commercial sectors.

- **For industry:**
 - automation of small finishing, production, assembly, or packaging machines
 - small automated systems operating at 48 V ~ (hoisting application, etc.)
 - decentralized automation of ancillary equipment for large and medium-sized machines (in the textile, plastics, materials processing sectors, etc.)
 - automation systems for agricultural machinery (irrigation, pumping, greenhouses, etc.)
- **For the commercial/building sectors:**
 - automation of barriers, roller shutters, access control
 - automation of lighting systems
 - automation of compressors and air conditioning systems
 - etc.

Their compact size and ease of setup make them a competitive alternative to solutions based on cabled logic or specific cards.

Programming

Simple programming, backed up by the universal nature of the languages, meets the requirements of automation specialists and the needs of electricians.

Programming can be performed:

- locally, using the buttons on the Zelio Logic smart relay (ladder language)
- on a PC using “Zelio Soft 2” software

When using a PC, programming can be performed either in ladder language or in function block diagram (FBD) language (see [page 10](#)).

The LCD display unit backlight (1) is activated by pressing one of the six programming buttons on the Zelio Logic smart relay or by programming with “Zelio Soft 2” software (e.g. flashing when diagnosing a malfunction).

The clock has a lithium battery, which gives it an independent operating time of 10 years. Data backup (preset values and current values) is provided by an EEPROM Flash memory (with the same lifetime as the smart relay).

Compact smart relays

Compact smart relays meet requirements for simple automation systems.

The number of I/O can be:

- 12 or 20 I/O, supplied with 24 V ~ or 12 V = power
- 20 I/O, supplied with 48 V ~ power
- 10, 12, or 20 I/O, supplied with 100...240 V ~, or 24 V = power

Modular smart relays and extension modules

The number of I/O for modular smart relays can be:

- 26 I/O, supplied with 12 V = power
 - 10 or 26 I/O, supplied with 24 V ~, 100...240 V ~, or 24 V = power
- To improve performance and flexibility, Zelio Logic modular smart relays can take extension modules to obtain a maximum of 40 I/O.
- Modbus serial link or Ethernet Modbus/TCP network communication extension modules, supplied with 24 V = power via the Zelio Logic smart relay at the same voltage
 - Analog I/O extension module with 4 I/O, supplied with 24 V = power via the Zelio Logic smart relay at the same voltage
 - Discrete I/O extension modules with 6, 10, or 14 I/O, supplied with power via the Zelio Logic smart relay at the same voltage

(1) LCD: Liquid crystal display



Connecting cable



Bluetooth interface



Memory cartridge



Modbus serial link communication extension module



Ethernet Modbus/TCP communication extension module



Modem communication interface



GSM/UMTS modem



HMISTO705 Small Panel



Zelio Logic compact smart relay + SR2CBL09 cable

Communication

Cabled and wireless programming tools

- These programming tools allow the Zelio Logic smart relay to be connected to a PC running "Zelio Soft 2" software:
 - Cable connection:
 - SR2USB01 cable to USB port
 - or
 - SR2CBL01 cable to 9-way serial port
 - Wireless connection:
 - SR2BTC01 Bluetooth interface

Memory cartridge

The Zelio Logic smart relay can take a backup memory cartridge that allows the application program to be copied to another Zelio Logic smart relay (it is only possible to load and update the firmware with the SR2MEM02 memory cartridge).

- The memory cartridge also enables a backup copy of the program to be saved prior to replacing the product.
- When used with a smart relay without display or buttons, the copy of the program contained in the cartridge is automatically transferred to the Zelio Logic smart relay on power-up.

Modbus serial link and Ethernet Modbus/TCP communication extension modules

The Modbus serial link and Ethernet Modbus/TCP network communication extension modules allow connection to automation system equipment such as display units or PLCs (see [page 22](#)).

Modem communication interface

The "modem communication interface" offer in the Zelio Logic range includes:

- an SR2COM01 modem communication interface connected between a Zelio Logic smart relay and a modem
- an SR2MOD02 GSM/UMTS (1) modem
- "Zelio Logic Alarm" software

This offer is designed for monitoring or remote control of machines or installations that operate without personnel.

The Modem communication interface, supplied with 12...24 V $\bar{\square}$ power, enables messages, phone numbers, and calling conditions to be stored (see [page 32](#)).

HMI terminal

The Harmony HMISTO Small Panel offers added value to the equipment by enabling the creation of eye-catching dialog screens.

- It has a color screen.
- It connects directly to the front panel of the smart relay in the memory cartridge slot via a special cable (SR2CBL09).
- It is configured using EcoStruxure Operator Terminal Expert software (2). Exchanges with the smart relay are simplified using the SL In and SL Out data exchange blocks in "Zelio Soft 2" software (FBD language only). 24 words can be exchanged in each direction.

(1) Global System Mobile (2G)/Universal Mobile Telecommunications System (3G)

(2) Visit [EcoStruxure Operator Terminal Expert](#) on our website.

Zelio Logic

Compact and modular smart relays

“Zelio Soft 2” programming software

“Zelio Soft 2” for PC – version 5.1 (1)

“Zelio Soft 2” software enables:

- programming in ladder language or function block diagram (FBD) language (see [page 12](#))
- simulation, monitoring, and supervision
- uploading and downloading of programs
- print-out of customized files
- automatic program compilation
- online help

Consistency checks and application languages

“Zelio Soft 2” monitors applications by means of its consistency check function.

An indicator turns red at the slightest input error (ladder language). The problem can be located by simply clicking the mouse.

“Zelio Soft 2” software allows users to switch between the six available languages (English, French, German, Italian, Portuguese, and Spanish) at any time and edit the application file in the selected language.

Inputting messages for display on Zelio Logic

“Zelio Soft 2” software allows text function blocks to be configured, which can then be displayed on Zelio Logic smart relays that have a display.

Program testing

Two test modes are provided:

- **Simulation** mode in “Zelio Soft 2” is used to test a program without a Zelio Logic smart relay, i.e. to:

- enable discrete inputs
- display output status
- vary the voltage of the analog inputs
- enable the programming buttons
- simulate the application program in real time or in accelerated time
- display the different active program elements dynamically in red

- **Monitoring** mode is used to test the program executed by the smart relay, i.e. to:

- display the program “online”
- force inputs, outputs, auxiliary relays, and current function block values
- adjust the date and time
- switch from STOP mode to RUN mode and vice versa

In simulation or monitoring mode, the supervision window allows users to view the status of the smart relay I/O within the application environment (diagram or image).

(1) These functions exist for versions \geq 5.1.

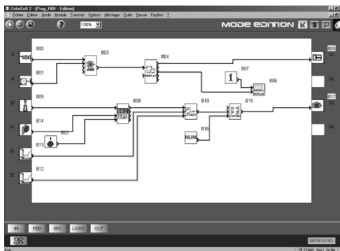

Programming in FBD language

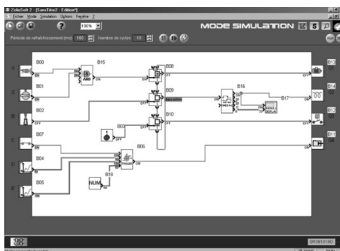

Simulation mode

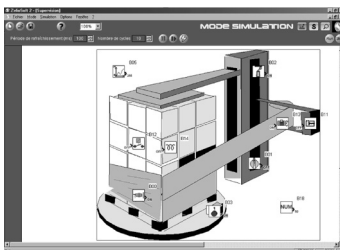

Supervision window

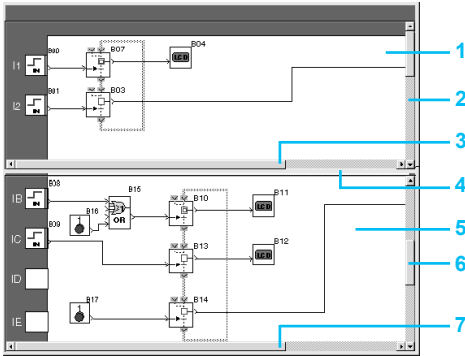

Structure of a split wiring sheet

User interfaces

“Zelio Soft 2” software (versions ≥ 4.1) improves the ease of use of user interfaces for the following functions:

“Split wiring sheet” function (ladder and FBD language)

The wiring sheet can be split into two to allow two separate parts of the wiring sheet to be displayed on the same screen.

This can be used to:

- Display the required function blocks in the top and bottom parts of the screen
- Move the split bar as required
- Connect the function blocks between the two parts of the wiring sheet

The split wiring sheet is structured as follows:

- 1 View of top part
- 2 Top window vertical scroll bar
- 3 Top window horizontal scroll bar
- 4 Split bar
- 5 View of bottom part
- 6 Bottom window vertical scroll bar
- 7 Bottom window horizontal scroll bar

“Replace function block” function (FBD language)

This function allows a block to be replaced without losing the input and output connections.

E.g. replacing an “OR” block with a “NOR” block

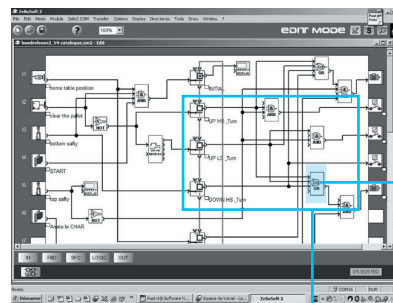

- 1 “OR” block to be replaced

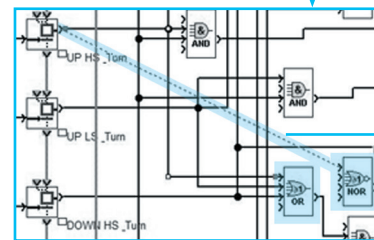

- 2 Move the links to the new “NOR” block

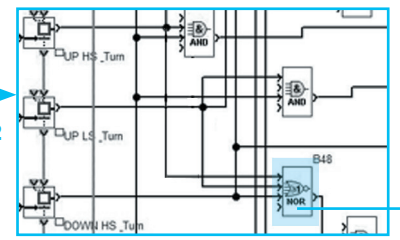

- 3 Delete the “OR” block and position the “NOR” block in its place

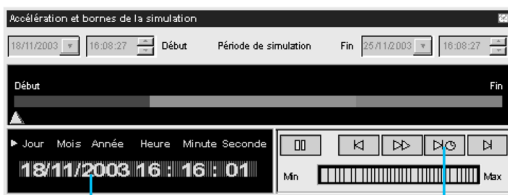

“Acceleration and simulation terminals” window

“Time Prog simulation” (ladder and FBD languages)

Ladder or FBD program simulation mode allows the program to be debugged by simulating it on the software workshop host computer.

A function allows the time on the simulator clock to be modified by setting it to 3 s before the start of the next event.

The “Next event” button 1 is used to modify the simulator clock 2.

Ladder language

Definitions



Text function block



Timer



Up/down counter



Fast counter



Analog comparator



Clock



Auxiliary relay



Counter comparator



LCD backlight



Daylight saving time change



Output coil



Message

Ladder language enables a ladder program to be written with elementary functions, elementary function blocks, and derived function blocks, as well as with contacts, coils, and variables.

The contacts and coils can be annotated. Text can be placed freely within the graphic.

■ Ladder diagram input modes

“Zelio input” mode allows users who have programmed the Zelio Logic smart relay directly on the device to achieve the same ease of use, even when using the software for the first time.

“Ladder input” mode, which is more intuitive, is very user-friendly and incorporates many additional features.

Two types of symbol can be used in ladder programming language:

- ladder symbols
- electrical symbols

“Ladder input” mode also allows the creation of mnemonics and comments associated with each program line.

Instant switching from one input mode to the other is possible at any time, simply by clicking the mouse.

Up to 240 (1) ladder diagram lines can be programmed, with 5 contacts and 1 coil per program line.

■ Functions

- 16 text function blocks
- 28 (1) timers, each of which can be configured from among 11 different types (1/10 second to 9,999 hours)
- 28 (1) up/down counters from 0 to 32,767
- 1 fast counter (1 kHz)
- 16 analog comparators
- 8 clocks, each with 4 channels
- 56 (1) auxiliary relays
- 8 counter comparators
- LCD screen with programmable backlight
- automatic daylight saving time changeover
- variety of functions: coil latching (Set/Reset), impulse relay, contactor
- 28 message blocks (with modem communication interface, see [page 32](#))

Functions

Position	Electrical diagram	Ladder language	Comment
Contact			I corresponds to the real state of the contact wired to the smart relay input. i corresponds to the inverse state of the contact wired to the smart relay input.
Standard coil			The coil is energized when the contacts to which it is connected are closed.
Latch coil (Set)			The coil is energized (set) when the contacts to which it is connected are closed. It remains energized even if the contacts are no longer closed.
Unlatch coil (Reset)			The coil is de-energized (reset) when the contacts to which it is connected are closed. It remains de-energized even if the contacts are no longer closed.

(1) Possible using version V5.0 and above of “Zelio Soft 2” provided that the SR2COM01 communication module is not used. If this module is used, 16 timers, 16 counters, and 32 auxiliary relays are available and the program is limited to 120 ladder diagram lines.





































Function block language (FBD/Grafcet SFC/logic functions) (1)

Definition:







FBD language allows graphical programming based on the use of predefined function blocks. It provides the use of 36 pre-programmed functions for counting, time delay, timing, switching threshold definition (e.g. temperature regulation), pulse generation, time programming, multiplexing, and display. There are also 7 SFC functions and 6 logic functions.

Pre-programmed functions

Zelio Logic smart relays provide a high processing capacity, up to 500 (2) function blocks, including 36 pre-programmed functions:

 <p>TIMER AC TIMER A/C</p> <p>Timer. Function A/C (ON-delay and OFF-delay)</p>	 <p>TIMER BH TIMER B/H</p> <p>Timer. Function BH (adjustable pulsed signal)</p>	 <p>TIMER LI TIMER Li</p> <p>Pulse generator (ON-delay, OFF-delay)</p>	 <p>TIMER BW TIMER B/W</p> <p>Timer. Function BW (pulse on rising/falling edge)</p>	 <p>TIMER AC TIMER A/C</p> <p>Timer. Function A/C with external preset adjustment (ON-delay and OFF-delay)</p>
 <p>TIMER BH TIMER B/H</p> <p>Timer. Function BH with external preset adjustment (adjustable pulsed signal)</p>	 <p>TIMER LI TIMER Li</p> <p>Pulse generator with external preset adjustment (ON-delay, OFF-delay)</p>	 <p>BISTABLE BISTABLE</p> <p>Impulse relay function</p>	 <p>SET-RESET SET RESET</p> <p>Bistable latching – Priority assigned to either SET or RESET function</p>	 <p>BOOLEAN BOOLEAN</p> <p>Allows logic equations to be created between connected inputs</p>
 <p>CAM CAM</p> <p>Cam programmer</p>	 <p>PRESET COUNT PRESET COUNT</p> <p>Up/down counter</p>	 <p>UP DOWN COUNT UP DOWN COUNT</p> <p>Up/down counter with external preset</p>	 <p>PRESET H-METER PRESET H-METER</p> <p>Hour counter (hour, minute preset)</p>	 <p>TIME PROG 02/06/03 TIME PROG</p> <p>Time programmer, weekly and annual</p>
 <p>GAIN GAIN</p> <p>Allows conversion of an analog value by change of scale and offset</p>	 <p>TRIGGER TRIGGER</p> <p>Defines an activation zone with hysteresis</p>	 <p>MUX MUX</p> <p>Multiplexing functions on 2 analog values</p>	 <p>MAX COMP IN ZONE MAX VAL MIN</p> <p>Zone comparison (Min. ≤ Value ≤ Max.)</p>	 <p>ADD/SUB +</p> <p>Add and/or subtract function</p>
 <p>MUL/DIV x =</p> <p>Multiply and/or divide function</p>	 <p>TEXT TEXT</p> <p>Display of 4 digital and analog data, date, time, messages for Human-Machine interface</p>	 <p>DISPLAY DISPLAY</p> <p>Display of digital and analog data, date, time, messages for Human-Machine interface</p>	 <p>COM COM</p> <p>Sending of messages with communication interface (see page 32)</p>	 <p>COMPARE V1 V2 COMPARE</p> <p>Comparison of 2 analog values using the operands =, >, <, ≤, ≥, ≠</p>
 <p>STATUS STATUS</p> <p>Access to smart relay status</p>	 <p>ARCHIVE ARCHIVE</p> <p>Storage of 2 values simultaneously</p>	 <p>SPEED COUNT 1234 SPEED COUNT</p> <p>Fast counting up to 1 kHz</p>	 <p>CAN CAN</p> <p>Analog-to-digital converter</p>	 <p>CNA CNA</p> <p>Digital-to-analog converter</p>
 <p>SL In In</p> <p>Input of a word via serial link</p>	 <p>SL Out Out</p> <p>Output of a word via serial link</p>	 <p>SUNTRACK SUM SET RISE</p> <p>Tracks the sun's position</p>	 <p>SUNRISE/SUNSET G</p> <p>Outputs the sunrise and sunset times</p>	 <p>PID</p> <p>Temperature, level, flow rate, or pressure control functions</p>
 <p>THERMISTOR t0</p> <p>NTC temperature probe input</p>				

SFC functions (GRAF CET)

 <p>RESET-INIT RESET-INIT</p> <p>Reset initial step</p>	 <p>INIT STEP INIT STEP</p> <p>Initial step</p>	 <p>STEP STEP</p> <p>SFC step</p>	 <p>DIV-OR 2 DIV-OR 2</p> <p>Divergence to OR</p>	 <p>CONV-OR 2 CONV-OR 2</p> <p>Convergence to OR</p>
 <p>DIV-AND 2 DIV-AND 2</p> <p>Divergence to AND</p>	 <p>CONV-AND 2 CONV-AND 2</p> <p>Convergence to AND</p>			

Logic functions

 <p>AND AND</p> <p>AND function</p>	 <p>OR OR</p> <p>OR function</p>	 <p>NAND NAND</p> <p>NOT AND function</p>	 <p>NOR NOR</p> <p>NOT OR function</p>	 <p>XOR XOR</p> <p>Exclusive OR function</p>	 <p>NOT NOT</p> <p>NOT function</p>
---	--	---	---	--	---

(1) FBD: Function block diagram. SFC: Sequential function chart

(2) Possible in version V5.0 or above of “Zelio Soft 2”

Function block language (FBD/Grafcet SFC/logic functions) (continued)

Macro function

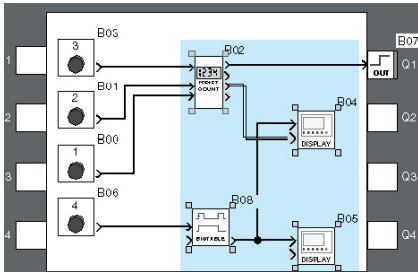

Creating a macro

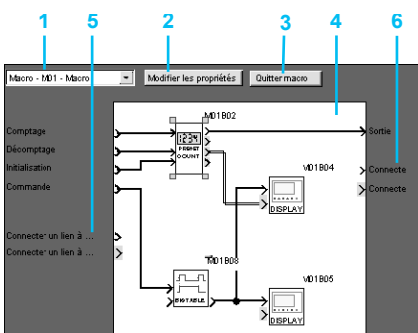

Inside a macro

- 1 Select macro
- 2 Edit properties
- 3 Return to external view of a macro
- 4 Internal function block in the macro
- 5 Non-connected inputs
- 6 Non-connected outputs

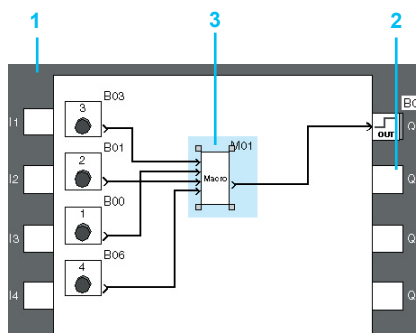

External view of a macro

- 1 Input connections
- 2 Output connection
- 3 Macro function block

A macro is a group of function blocks. It is characterized by its number, name, links, internal function blocks (255 max.) and its I/O connections.

Seen from the outside, a macro behaves like a function block with inputs and/or outputs likely to be connected to links. Once created, a macro can be manipulated like a function block:

- Macro characteristics:
 - The maximum number of macros is 64.
 - A dedicated macro password can be used to protect their content.
 - A macro can be edited/duplicated.
 - A macro's comments can be edited.

- Macro properties:

A “Macro Properties” dialog box is used to enter or modify the properties of a macro. The properties of a macro are as follows:

 - Macro name (optional)
 - Block symbol, which may be:
 - an identifier
 - an image
 - Name of inputs
 - Name of outputs

PID function

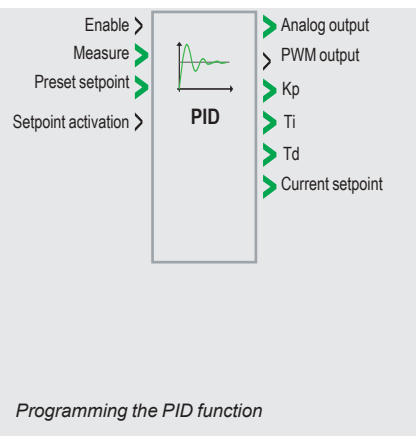

Programming the PID function

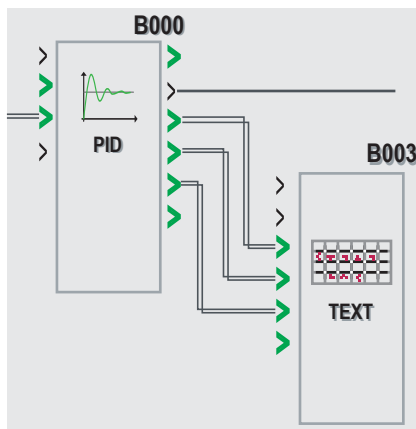

Presentation

The PID function block is used to program simple temperature, level, or pressure control functions.

Two types of output enable adaptation to the most common actuators available on the market:

- Analog output, requiring the use of a modular smart relay and an analog I/O extension module
- PWM output, enabling the integrated outputs in any smart relay to be used. Depending on the period set for PWM, and to help extend service life, a smart relay equipped with transistor outputs is recommended.

Programming

PID function blocks are available in FBD language. To help with tuning, default parameters are available for several typical applications (flow, level, pressure, temperature). These parameters can be modified.

Tuning

The TEXT and DISPLAY function blocks are used to help tune the control parameters (Kp, Ti, Td) without using Zelio Soft 2: the parameters can be modified directly using the buttons on the front of the smart relay and the display.

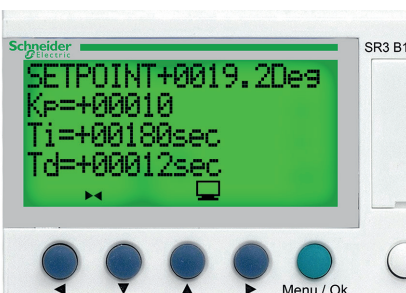

Modifying parameters (Kp, Ti, Td) using the programming and parameter setting buttons

Compact smart relays

With display – 10, 12, and 20 I/O

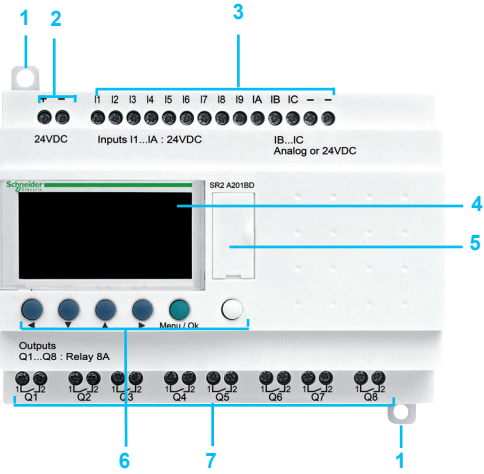

Without display – 10, 12, and 20 I/O

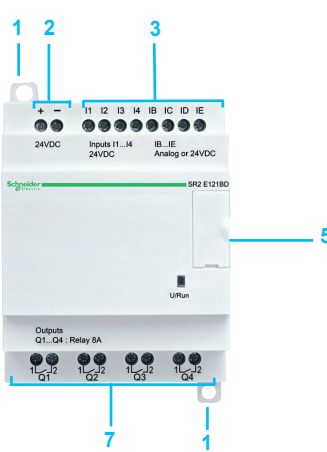

Zelio Logic compact smart relay front panels comprise:

- 1 Two retractable mounting lugs
- 2 Two power supply terminals
- 3 Terminals for connecting the inputs
- 4 Backlit LCD display with 4 lines of 18 characters
- 5 Slot for memory cartridge or connection to PC, modem communication interface, HMI terminal (Harmony Small Panel), or Bluetooth interface
- 6 6 buttons for programming and parameter entry
- 7 Terminals for connecting the outputs

Modular smart relays

With display – 10 and 26 I/O

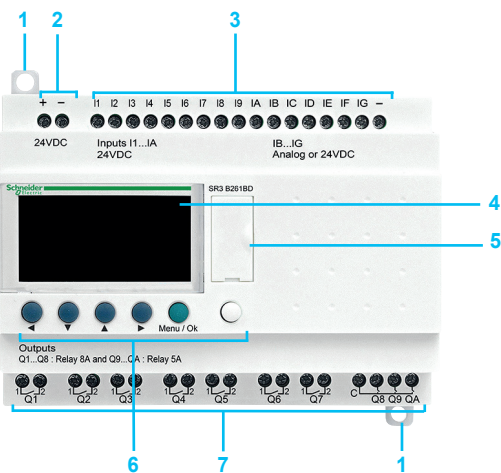

Zelio Logic modular smart relay front panels comprise:

- 1 Two retractable mounting lugs
- 2 Two power supply terminals
- 3 Terminals for connecting the inputs
- 4 Backlit LCD display with 4 lines of 18 characters
- 5 Slot for memory cartridge or connection to PC, modem communication interface, HMI terminal (Harmony Small Panel), or Bluetooth interface
- 6 6 buttons for programming and parameter entry
- 7 Terminals for connecting the outputs

Discrete I/O extension modules

6 discrete I/O

10 and 14 discrete I/O

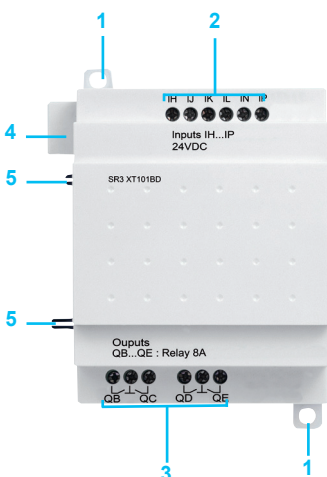
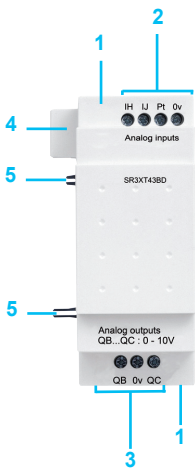

Discrete I/O extension module front panels comprise:

- 1 Two retractable mounting lugs
- 2 Terminals for connecting the inputs
- 3 Terminals for connecting the outputs
- 4 Connector for connection to the Zelio Logic smart relay (powered via the Zelio Logic smart relay)
- 5 Locating pegs

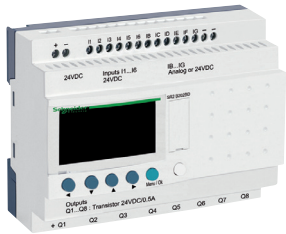

SR2A201BD



"Zelio Soft 2" software



SR2PACK●●●●

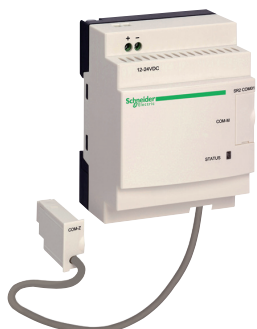

Modem communication interface

Compact smart relays with display

Number of I/O	Discrete inputs	Including 0-10 V $\overline{\text{---}}$ analog inputs	Relay outputs	Transistor outputs	Clock	Reference	Weight kg/lb
24 V \sim power supply							
12	8	0	4	0	Yes	SR2B121B	0.250 0.551
20	12	0	8	0	Yes	SR2B201B	0.380 0.838
48 V \sim power supply							
20	12	0	8	0	No	SR2A201E (1)	0.380 0.838
100...240 V \sim power supply							
10	6	0	4	0	No	SR2A101FU (1)	0.250 0.551
12	8	0	4	0	Yes	SR2B121FU	0.250 0.551
20	12	0	8	0	No	SR2A201FU (1)	0.380 0.838
					Yes	SR2B201FU	0.380 0.838
12 V $\overline{\text{---}}$ power supply							
12	8	4	4	0	Yes	SR2B121JD	0.250 0.551
20	12	6	8	0	Yes	SR2B201JD	0.380 0.838
24 V $\overline{\text{---}}$ power supply							
10	6	0	4	0	No	SR2A101BD (1)	0.250 0.551
12	8	4	4	0	Yes	SR2B121BD (2)	0.250 0.551
			0	4	Yes	SR2B122BD (2)	0.220 0.485
20	12	2	8	0	No	SR2A201BD (1)	0.380 0.838
		6	8	0	Yes	SR2B201BD (2)	0.380 0.838
			0	8	Yes	SR2B202BD (2)	0.280 0.617

"Zelio Soft 2" software

See [page 20](#).

Accessories

See [page 20](#).

Compact "discovery" packs

Pack contents:

Compact smart relays with display SR2B●●●●● + PC connecting cable SR2USB01

Number of I/O	Pack contents (references)	Reference	Weight kg/lb
100...240 V \sim power supply			
12	SR2B121FU + SR2USB01	SR2PACKFU	0.700 1.543
20	SR2B201FU + SR2USB01	SR2PACK2FU	0.850 1.874
24 V $\overline{\text{---}}$ power supply			
12	SR2B121BD + SR2USB01	SR2PACKBD (2)	0.700 1.543
20	SR2B201BD + SR2USB01	SR2PACK2BD (2)	0.700 1.543

Modem communication interface

12...24 V $\overline{\text{---}}$ power supply

Description	Reference
Modem communication interface	See page 32

(1) Programming in ladder language only

(2) The 0-10 V $\overline{\text{---}}$ analog inputs on SR2B●●●●BD compact smart relays can be connected to NTC (negative temperature coefficient) temperature probes. See probes on [page 21](#).

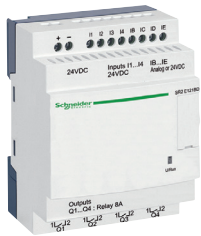

SR2E121BD



"Zelio Soft 2" software



Modem communication interface

Compact smart relays without display

Number of I/O	Discrete inputs	Including 0-10 V $\overline{\text{---}}$ analog inputs	Relay outputs	Transistor outputs	Clock	Reference	Weight kg/lb
24 V \sim power supply							
12	8	0	4	0	Yes	SR2E121B	0.220 0.485
20	12	0	8	0	Yes	SR2E201B	0.350 0.772
100...240 V \sim power supply							
10	6	0	4	0	No	SR2D101FU (1)	0.220 0.485
12	8	0	4	0	Yes	SR2E121FU	0.220 0.485
20	12	0	8	0	No	SR2D201FU (1)	0.350 0.772
					Yes	SR2E201FU	0.350 0.772
24 V $\overline{\text{---}}$ power supply							
10	6	0	4	0	No	SR2D101BD (1)	0.220 0.485
12	8	4	4	0	Yes	SR2E121B (2)	0.220 0.485
20	12	2	8	0	No	SR2D201BD (1)	0.350 0.772
		6	8	0	Yes	SR2E201BD (2)	0.350 0.772

"Zelio Soft 2" software

See [page 20](#).

Accessories

See [page 20](#).

Modem communication interface

12...24 V $\overline{\text{---}}$ power supply

Description	Reference
Modem communication interface	See page 32

(1) Programming in ladder language only

(2) The 0-10 V $\overline{\text{---}}$ analog inputs on SR2E●●●BD compact smart relays can be connected to NTC (negative temperature coefficient) temperature probes. See probes on [page 21](#).

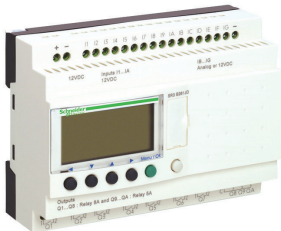

SR3B261B



"Zelio Soft 2" software

Modular smart relays with display

Number of I/O	Discrete inputs	Including 0-10 V $\overline{\text{---}}$ analog inputs	Relay outputs	Transistor outputs	Clock	Reference	Weight kg/lb
24 V \sim power supply							
10	6	0	4	0	Yes	SR3B101B	0.250 0.551
26	16	0	10 (1)	0	Yes	SR3B261B	0.400 0.882
100...240 V \sim power supply							
10	6	0	4	0	Yes	SR3B101FU	0.250 0.551
26	16	0	10 (1)	0	Yes	SR3B261FU	0.400 0.882
12 V $\overline{\text{---}}$ power supply							
26	16	6	10 (1)	0	Yes	SR3B261JD	0.400 0.882
24 V $\overline{\text{---}}$ power supply							
10	6	4	4	0	Yes	SR3B101BD (2)	0.250 0.551
			0	4	Yes	SR3B102BD (2)	0.220 0.485
26	16	6	10 (1)	0	Yes	SR3B261BD (2)	0.400 0.882
			0	10	Yes	SR3B262BD (2)	0.300 0.661

"Zelio Soft 2" software

See [page 20](#).

Accessories

See [page 20](#).

Modular "discovery" packs

Pack contents:

Modular smart relays with display [SR3B●●●●](#) + PC connecting cable [SR2USB01](#)

Number of I/O	Pack contents (references)	Reference	Weight kg/lb
100...240 V \sim power supply			
10	SR3B101FU + SR2USB01	SR3PACKFU	0.700 1.543
26	SR3B261FU + SR2USB01	SR3PACK2FU	0.850 1.874
24 V $\overline{\text{---}}$ power supply			
10	SR3B101BD (2) + SR2USB01	SR3PACKBD (2)	0.700 1.543
26	SR3B261BD (2) + SR2USB01	SR3PACK2BD (2)	0.850 1.874

(1) Including 8 outputs with maximum current of 8 A and 2 outputs with maximum current of 5 A.
Note: The Zelio Logic smart relay and its associated extension modules must have an identical voltage to be able to operate together.

(2) The 0-10 V $\overline{\text{---}}$ analog inputs on [SR3B●●●●BD](#) modular smart relays can be connected to NTC (negative temperature coefficient) temperature probes. See probes on [page 21](#).



SR3PACK●●●



Modbus serial link communication extension module



Ethernet Modbus/TCP communication extension module



SR3XT141JD



Modem communication interface

Communication extension module (1)

24 V $\overline{\text{---}}$ power supply (via SR3B...BD smart relays)

Used for	Communication ports	Reference
SR3B...1BD and SR3B...2BD Zelio Logic modular smart relays	Modbus RS485 serial link (RJ45)	See page 22
	Ethernet Modbus/TCP (RJ45)	See page 22

Analog I/O extension module (2)

24 V $\overline{\text{---}}$ power supply (via Zelio Logic SR3B...BD smart relay)

Number of I/O	Inputs	Including $\overline{\text{---}}$ 0-10 V	Including 0-20 mA	Including Pt100	0-10 V $\overline{\text{---}}$ output	Reference
4	2	Up to 2	Up to 2	Up to 1	2	See page 30

Discrete I/O extension modules

Number of I/O	Discrete inputs	Relay outputs	Reference	Weight kg/lb
24 V \sim power supply (via Zelio Logic SR3B...B smart relays)				
6	4	2	SR3XT61B	0.125 0.276
10	6	4	SR3XT101B	0.200 0.441
14	8	6 (3)	SR3XT141B	0.220 0.485
100-240 V \sim power supply (via Zelio Logic SR3B...FU smart relays)				
6	4	2	SR3XT61FU	0.125 0.276
10	6	4	SR3XT101FU	0.200 0.441
14	8	6 (3)	SR3XT141FU	0.220 0.485
12 V $\overline{\text{---}}$ power supply (via Zelio Logic SR3B261JD smart relay)				
6	4	2	SR3XT61JD	0.125 0.276
10	6	4	SR3XT101JD	0.200 0.441
14	8	6 (3)	SR3XT141JD	0.220 0.485
24 V $\overline{\text{---}}$ power supply (via Zelio Logic SR3B...BD smart relays)				
6	4	2	SR3XT61BD	0.125 0.276
10	6	4	SR3XT101BD	0.200 0.441
14	8	6 (3)	SR3XT141BD	0.220 0.485

Modem communication interface (4)

12...24 V $\overline{\text{---}}$ power supply

Description	Reference
Modem communication interface	See page 32

(1) See [page 22](#).

(2) See [page 30](#).

(3) Including 4 outputs with maximum current of 8 A and 2 outputs with maximum current of 5 A.

(4) See [page 32](#).

Note: The Zelio Logic smart relay and its associated extension modules must have an identical voltage to be able to operate together.

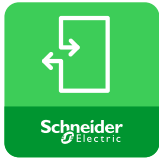

Zelio Soft 2



HMISTO705



SR2USB01



SR2CBL09



SR2BTC01



SR2MEM02

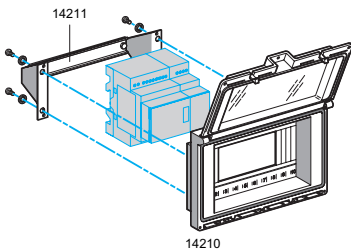

Modicon regulated switch mode power supply ABLM1A24012

Programming

Description	Use	Reference	Weight kg/lb
-------------	-----	-----------	--------------

“Zelio Soft 2” software

Programming software “Zelio Soft 2”, multilingual	For PC and 32-bit and 64-bit operating systems compatible with Windows 7, 8.1, and 10 This software was previously supplied on CD. It is now supplied as a free download available on our website .	Free download from our website	
---	--	--	--

HMI

Harmony Small Panel with color TFT touch screen	4.3" color screen 26 MB application memory capacity Programmed using EcoStruxure Operator Terminal Expert	HMISTO705 (1) (3)	0.220 0.485
--	---	--------------------------------------	----------------

Connection accessories

Connecting cables Length: 3 m (9.84 ft) For use with “Zelio Soft 2”	Between the PC (9-way SUB-D connector) and the Zelio Logic smart relay (programming port connector)	SR2CBL01	0.150 0.331
--	---	--------------------------	----------------

	Between the PC (USB connector) and the Zelio Logic smart relay (programming port connector)	SR2USB01	0.100 0.220
--	---	--------------------------	----------------

Connecting cables Length: 2.5 m (8.2 ft)	Between the Harmony Small Panel HMISTO705 (9-way removable screw terminal block) and the Zelio Logic smart relays (programming port connector)	SR2CBL09	-
--	--	--------------------------	---

Bluetooth interface for Zelio Logic smart relays	Between the PC (wireless link) and the Zelio Logic smart relay. Range of 10 m (32.8 ft) (class 2)	SR2BTC01	0.015 0.033
---	--	--------------------------	----------------

Memory cartridges (2)

EEPROM memory cartridges	For firmware (software embedded in the smart relay) version ≤ 2.4	SR2MEM01	0.010 0.022
---------------------------------	---	--------------------------	----------------

	For firmware (software embedded in the smart relay) version ≥ 3.0	SR2MEM02	0.010 0.022
--	---	--------------------------	----------------

Mounting accessories

Description/use	Mounting capacity	Reference	Weight kg/lb
-----------------	-------------------	-----------	--------------

Dust- and damp-proof enclosure with split blanking plate arrangement, equipped with an IP55 dust- and damp-proof window with hinged flap for mounting through a door	- 1 or 2 SR2 smart relays with 10 or 12 I/O - or 1 SR2 smart relay with 20 I/O - or 1 SR3 smart relay with 10 I/O + 1 I/O extension module with 6, 10 or 14 I/O - 1 SR3 smart relay with 26 I/O + 1 I/O extension module with 6 I/O	14210	0.350 0.772
---	--	-----------------------	----------------

Mounting bracket and symmetrical mounting rail	For mounting enclosure 14210 through a door panel	14211	0.210 0.463
---	---	-----------------------	----------------

Online documentation available

User Manuals for direct programming on the Zelio Logic smart relay (in English, French, German, Italian, Portuguese, or Spanish): downloadable from our [website](#).

Regulated switch mode power supplies

Input voltage	Nominal output voltage	Reference
---------------	------------------------	-----------

100...240 V ~ (50/60 Hz)	5 V $\overline{\text{---}}$, 12 V $\overline{\text{---}}$, or 24 V $\overline{\text{---}}$	Refer to the Modicon Power Supply catalog Ref. DIA3ED2170401EN
--------------------------	--	--

Converters







Description	Reference
-------------	-----------

Converters for thermocouples types J and K, Pt100 probes, and voltage/current	Refer to the Harmony Analog catalog Ref. DIA5ED2210501EN
--	--

(1) The SR2CBL09 cable used to connect an HMISTO705 panel to a smart relay must be equipped with a shunt between the terminals marked CTS and RTS. This shunt is included on all cables leaving the factory after June 2017 (date code 1722).

(2) The use of memory cartridge SR2MEM02 to load the program is not compatible with the SR2COM01 modem communication interface.

(3) The Harmony HMISTO705 terminals cannot be used on logic modules that only use the LADDER language.

Measurement accessories (1)						
Designation	Description	Cable length m (ft)	Unit reference	Sold in lots of... (2)	Weight kg/ lb	
Temperature control with NTC probe. The NTC (negative temperature coefficient) probe is a thermistor, i.e. a passive temperature sensor. Its resistance changes with the temperature, decreasing as the temperature rises and vice versa.						
Multi-purpose NTC probes						
	<ul style="list-style-type: none"> ■ IP68 ■ Equipped with 2 conductor cables for controller side 	1.5 (4.92)	TM1STNTCRN52015	8	0.1448 0.320	
		3 (9.84)	TM1STNTCRN52030	5	0.1808 0.400	
		5 (16.4)	TM1STNTCRN52050	4	0.228 0.500	
	<ul style="list-style-type: none"> ■ IP67 ■ Equipped with 2 conductor cables for controller side 	1.5 (4.92)	TM1STNTCRN61515	8	0.1048 0.230	
		3 (9.84)	TM1STNTCRN61530	5	0.1258 0.280	
		5 (16.4)	TM1STNTCRN61550	4	0.1648 0.360	
	<ul style="list-style-type: none"> ■ FAST ■ IP67 ■ Equipped with 2 conductor cables for controller side 	1.5 (4.92)	TM1STNTCSF44015	8	0.1448 0.320	
		3 (9.84)	TM1STNTCSF44030	5	0.1758 0.390	
	<ul style="list-style-type: none"> ■ IP68 ■ Equipped with 2 conductor cables for controller side 	1.5 (4.92)	TM1STNTCSN62015	8	0.1448 0.320	
		3 (9.84)	TM1STNTCSN62030	5	0.1758 0.390	
		5 (16.4)	TM1STNTCSN62050	4	0.2328 0.510	
NTC probes with wrist strap, for pipes						
	<ul style="list-style-type: none"> ■ IP68 ■ Equipped with 2 conductor cables for controller side ■ Equipped with wrist strap 	1.5 (4.92)	TM1STNTNTC62015	8	0.1528 0.340	
		3 (9.84)	TM1STNTNTC62030	5	0.1808 0.400	
NTC probes for wall mounting						
	<ul style="list-style-type: none"> ■ For external air temperature: -50...100 °C (-58...212 °F) ■ IP65 ■ Wall mounting 	-	TM1STNTCW69755	1	0.114 0.25	
			<ul style="list-style-type: none"> ■ For internal (ambient) air temperature: -25...40 °C (-13...104 °F) ■ IP30 ■ Mounting on internal wall 	-	TM1STNTCWN75750	1

(1) The TM1 probes presented on this page are type NTC 10 kOhm at 25 °C B3435 (25/85).
Other types of probe can be used, as per the table below:

Probe type	Measurement range	
	°C	°F
NTC 10 kOhm at 25 °C B3435 (25/85)	-50...+150	-58...+302
NTC 10 kOhm at 25 °C B3984 (25/85)	-55...+60	-67...+140
NTC 1,000 kOhm at 25 °C B4608 (25/85)	+10...+300	+50...+572
KTY 81 210/220/221/222/250	-55...+150	-67...+302
PT 500	-200...+850	-328...+1,562

(2) The value indicated is the number of products supplied when ordering a reference.

Presentation

In order to communicate with their environment, Zelio Logic compact and modular smart relays and their extension modules are equipped with various types of communication port.

- Compact and modular smart relays feature a serial link port for connecting a PC, the modem communication interface, a memory cartridge slot, or an HMI terminal. This port uses a dedicated Zelio Logic communication protocol.
- Zelio Logic modular smart relay extension modules feature:
 - 1 RS 485 serial link port using the Modbus protocol on the **SR3MBU01BD** extension module
 - 1 Ethernet Modbus/TCP 10/100 base T port on the **SR3NET01BD** extension module

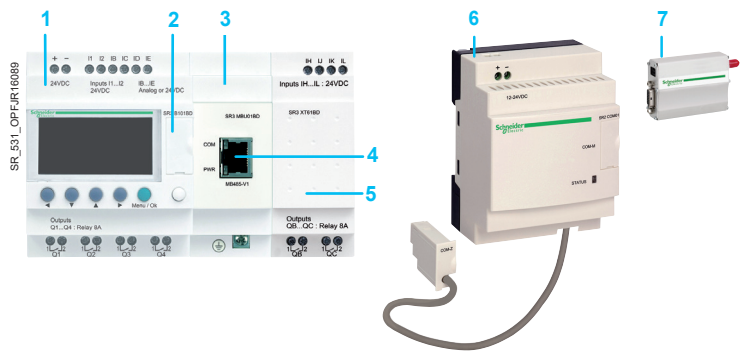

- 1 Modular smart relay (10 or 26 I/O)
- 2 Serial link port, Zelio Logic connector
- 3 Modbus server or Ethernet server communication extension module
- 4 RJ45 connector for Modbus serial link or Ethernet Modbus/TCP network connection
- 5 Discrete (6, 10, or 14 I/O) or analog (4 I/O) I/O extension module
- 6 Modem communication interface
- 7 GSM/UMTS modem

⚠ Observe the order of assembly above when using a Modbus serial link (server) or Ethernet Modbus/TCP (server) network communication extension module and a discrete or analog I/O extension module.

An I/O extension module cannot be inserted before the Modbus serial link (server) or Ethernet Modbus/TCP (server) network communication extension module.

Communication ports on Zelio Logic smart relays and their extension modules

	Smart relay serial link port	Modbus serial link port on SR3MBU01BD extension module	Ethernet Modbus/TCP port on SR3NET01BD extension module	Modem communication interface port
Smart relays	Physical layer			
	Proprietary		RS 485	10/100 base T
	Connector			
	Zelio Logic	RJ45	RJ45	Dedicated Zelio
Compact	All types (connection and isolation via SR2CBL01 or SR2USB01 cable)	–	–	All SR2B●●●● and SR2E●●●● smart relays with clock (see page 35)
Modular	All types (connection and isolation via SR2CBL01 or SR2USB01 cable)	All SR3B●●●BD smart relays with 24 V $\overline{\text{DC}}$ power supply	All SR3B●●●BD smart relays with 24 V $\overline{\text{DC}}$ power supply	All types (see page 35)

Description

Wired connection

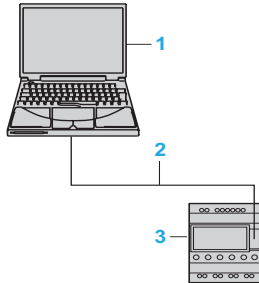

- 1 Programming PC
- 2 USB cable (SR2USB01) or serial link cable (SR2CBL01) (1)
- 3 Zelio Logic compact or modular smart relay

Wireless connection

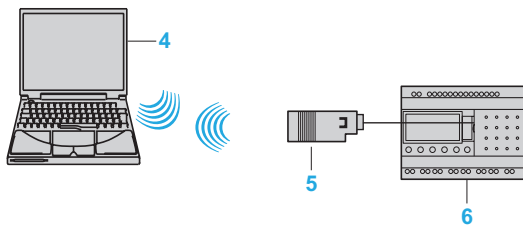

- 4 Programming PC with integrated Bluetooth technology (1)
- 5 Bluetooth interface (SR2BTC01) for Zelio Logic smart relay (1)
- 6 Zelio Logic compact or modular smart relay

Modem link

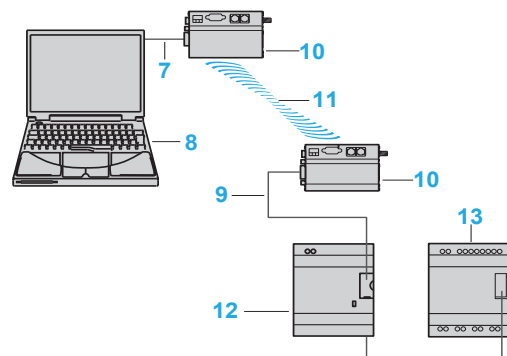

- 7 PC-modem connecting cable (SR1CBL03)
- 8 Programming PC
- 9 Modem interface connecting cable included with SR2COM01(1)
- 10 Data transmission/reception modem (SR2MOD02) (1)
- 11 Phone or radio link
- 12 Communication interface (SR2COM01)
- 13 Zelio Logic compact or modular smart relay

(1) See page 20.

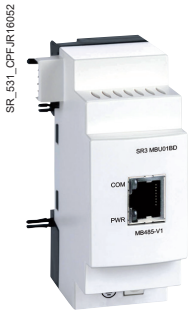

Modbus serial link network communication extension module

Presentation

The Modbus communication protocol is the client/server type. Two exchange methods are possible:

- Request/response:
 - The client sends a request to a specific server.
 - The server waits for a response from the polled client.
- Broadcast:
 - The Client broadcasts a request to all server stations on the bus. These stations execute the command without transmitting a response.

Zelio Logic modular smart relays are connected to the Modbus network via the Modbus server network communication extension module. This extension module is a server that is not electrically isolated.

The Modbus server network communication extension module must be connected to an SR3B●●●BD modular smart relay with a 24 V $\overline{\text{DC}}$ power supply.

Configuration

The Modbus server network communication extension module can be configured:

- locally, using the buttons on the smart relay (1)
- on a PC using “Zelio Soft 2” software (see [page 10](#))

When using a PC, programming can be performed either in ladder language or in function block diagram (FBD) language (see [page 12](#)).

Description

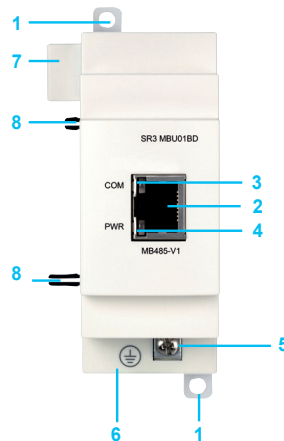

The Modbus server network communication extension module **SR3MBU01BD** comprises:

- 1 Two retractable mounting lugs
- 2 A Modbus network connection (RJ45 shielded female connector)
- 3 A communication LED (COM)
- 4 A power LED (PWR)
- 5 A screw terminal block for the protective ground connection
- 6 Spring for clip-on mounting on 35 mm/1.38 in. rail
- 7 Connector for connection to the Zelio Logic smart relay (powered via the Zelio Logic smart relay)
- 8 Locating pegs

(1) Programming via the buttons on the front panel of the smart relay is only possible in ladder language.

Connection examples

Example 1

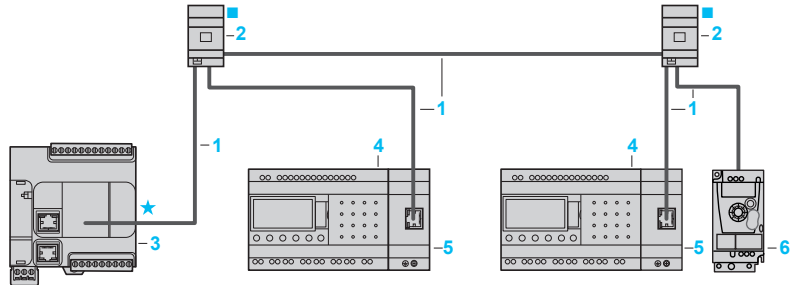

- Total length of cables between M221 and Altivar 12: ≤ 30 m (98 ft)

- Length of cable 3: ≤ 10 m (33 ft)

★ Line polarization active ■ Line terminator

- 1 Modbus RS485 cordsets (**VW3A8306R** extension cables)
- 2 Junction box **TWDXCAT3RJ** (1x RJ45 for trunk cable, 2x RJ45 for drop)
- 3 Client Modicon logic controller **TM221C** equipped with communication cartridge **TMC2SL1** (1)
- 4 Modular smart relay **SR3B**BD
- 5 Modbus communication extension module **SR3MBU01BD**
- 6 Altivar 12 drive

(1) Polarization must be enabled in the Client Modicon M221.

Example 2

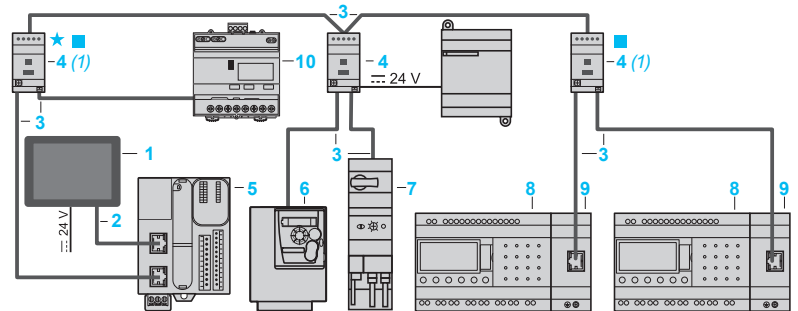

- Total length of cables between isolation boxes 4: $\leq 1,000$ m (3,281 ft)

- Length of drop cables 3: ≤ 10 m (33 ft)

★ Line polarization active ■ Line terminator

- 1 Client display unit **HMISCU**
- 2 Controller to Harmony HMI cordsets
- 3 Modbus RS485 cordsets (**VW3A8306R** extension cables)
- 4 Serial link tap isolation box **TWDXCAISO** (1x RJ45 for trunk cable, 2x RJ45 for drop)
- 5 Client Modicon logic controller **TM221M** (Network server connected to serial link port SERIAL1)
- 6 Altivar 312 drive
- 7 TeSys U motor starter controller
- 8 Modular smart relay **SR3B**BD
- 9 Modbus communication extension module **SR3MBU01BD**
- 10 Power meter **IEM31**

(1) Box powered by the logic controller

Function description

- The Modbus server network communication extension module is connected to a 2-wire or 4-wire Modbus network (1).
- The maximum length between two **TWDXCAISO** taps configured as line terminators is 1,000 m/3,281 ft (9600 baud max., AWG 26).
- A maximum of 32 servers can be connected to the Modbus network, or a maximum of 247 servers with repeaters.
- The connection cable and its RJ45 male connectors must be shielded.
- The module \perp terminal must be connected directly to the protective ground.

(1) Refer to the Quick Reference Guide supplied with the product.

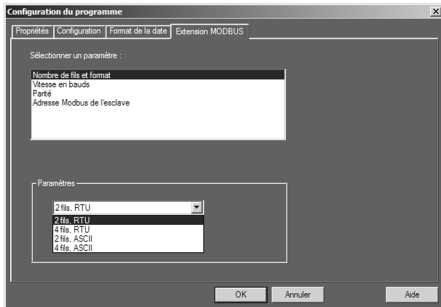

Software workshop parameter entry window

Parameter entry

Parameters can be entered either using “Zelio Soft 2” software, or directly using the buttons on the Zelio Logic smart relay (1). When the “RUN” command is issued, the Zelio Logic smart relay initializes the Modbus server network communication extension module in a configuration previously defined in the basic program.

The Modbus server network communication extension module has 4 parameters:

- number of UART wires and Modbus frame format
- transmission speed
- parity
- Modbus extension module network address

The default parameter settings are as follows: 2-wire, RTU, 19,200 baud, even parity, address 1.

Parameters	Options
Number of wires	2 or 4
Frame format	RTU or ASCII
Transmission speed (baud)	1200, 2400, 4800, 9600, 19,200, 28,800, 38,400, 57,600
Parity	None, even, odd
Network address	1 to 247

Addressing Modbus exchanges

Ladder programming

In ladder mode, the 4 data words (16 bits) to be exchanged cannot be accessed by the application. Transfers with the Client are implicit and are carried out in a way that is totally transparent.

Modbus exchanges	Code	Number of words
Image of smart relay I/O	Read 03	4
Clock words 	Read/Write 16, 06, or 03	4
Status words	Read 03	1

Function block diagram (FBD) programming

In FBD mode, the 4 input data words (16 bits) (J1XT1 to J4XT1) and the 4 output data words (O1XT1 to O4XT1) can be accessed by the application. Conversion function blocks are used to:

- break down a word type input (16 bits) into 16 separate “bit” type outputs using the CAN (analog-to-digital conversion) function e.g. to break down a J1XT1 to J4XT1 type input and copy these status values to discrete outputs
- compose a word type output (16 bits) from 16 separate “bit” type outputs using the CNA (digital-to-analog conversion) function e.g. to transfer the status value of discrete inputs or the status of a function to an O1XT1 to O4XT1 type output

Modbus exchanges	Code	Number of words
Input words	Read/Write 16, 06, or 03	4
Output words	Read 03	4
Clock words 	Read/Write 16, 06, or 03	4
Status words	Read 03	1

(1) Programming via the buttons on the front panel of the smart relay is only possible in ladder language.

Input words

Output words

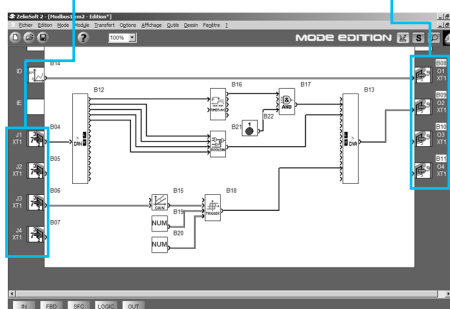
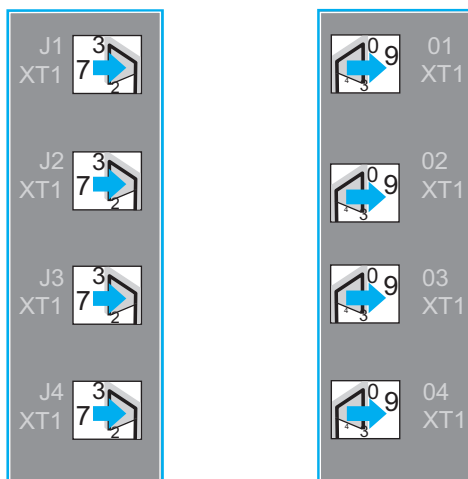

FBD program editing window



Ethernet (server) network communication extension module

Presentation

The **SR3NET01BD** extension module is used to communicate over Ethernet via the Modbus/TCP protocol in server mode. It must be connected to an **SR3B●●●BD** smart relay with a 24 V $\bar{\text{---}}$ power supply.

Configuration

This extension module is configured on a PC using “Zelio Soft 2” software (see [page 10](#)). Programming on the PC is performed in function block diagram (FBD) language (see [page 12](#)).

Description

The Ethernet Modbus/TCP network communication extension module **SR3NET01BD** comprises:

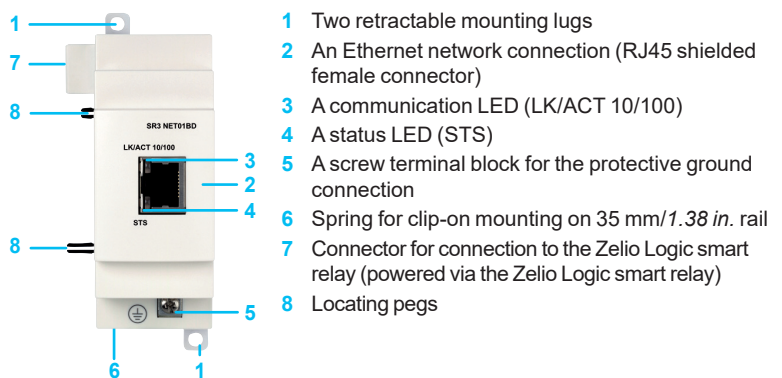

Connection example

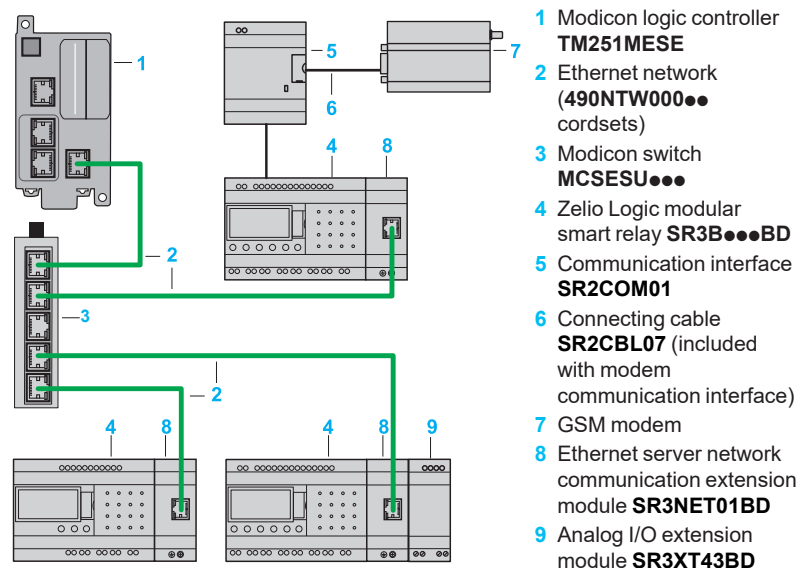

Function description

- The Ethernet Modbus/TCP network communication extension module is connected to a LAN.
- The maximum length between two devices is 100 m/328 ft.
- The connection cable must be at least category 5, and its RJ45 male connectors must be shielded.
- The $\bar{\text{---}}$ terminal must be connected directly to the protective ground.

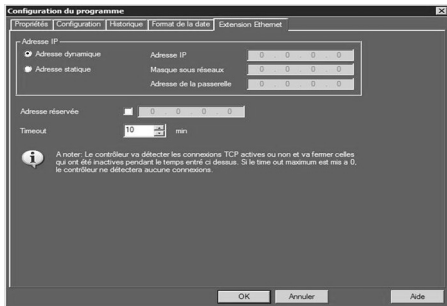

Ethernet extension module configuration window

Parameter entry

Parameters can be entered using “Zelio Soft 2” software. When the “RUN” command is issued, the Zelio Logic smart relay initializes the Ethernet Modbus/TCP network communication extension module in a configuration previously defined in the basic program.

The Ethernet Modbus/TCP network communication extension module has 6 parameters:

- type of addressing (dynamic or static)
- IP address
- subnet mask
- gateway address
- reserved address
- time out

Addressing Ethernet exchanges

Function block diagram (FBD) programming

In FBD mode, the 4 input data words (16 bits) (J1XT1 to J4XT1) and the 4 output data words (O1XT1 to O4XT1) can be accessed by the application.

Conversion function blocks are used to:

- break down a word type input (16 bits) into 16 separate “bit” type outputs using the CAN (analog-to-digital conversion) function e.g. to break down a J1XT1 to J4XT1 type input and copy these status values to discrete outputs
- compose a word type output (16 bits) from 16 separate “bit” type outputs using the CNA (digital-to-analog conversion) function e.g. to transfer the status value of discrete inputs or the status of a function to an O1XT1 to O4XT1 type output

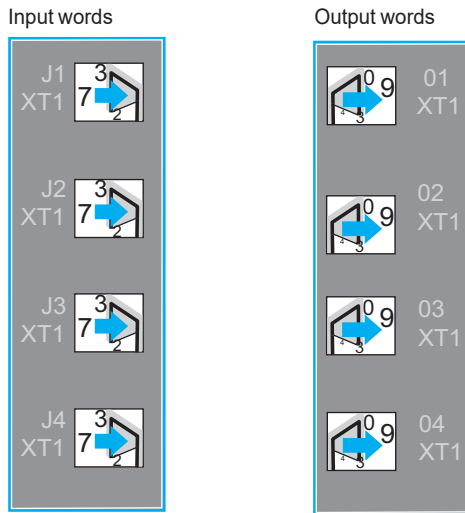

Ethernet exchanges	Code	Number of words
Input words	Read/Write 16, 06, or 03	4
Output words	Read 03	4
Clock words	Read/Write 16, 06, or 03	4
Status words	Read 03	1

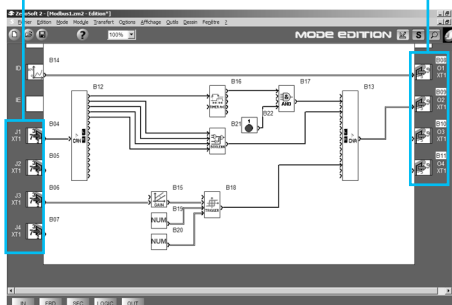

FBD program editing window



SR3MBU01BD



SR3NET01BD



MCSESU053FN0



TWDXCAT3RJ



TWDXCAISO

Modbus serial link and Ethernet Modbus/TCP network communication extension modules

For use with	Communication ports	Reference	Weight kg/lb
Modular smart relays SR3B●●1BD and SR3B●●2BD	Serial link (RJ45)	SR3MBU01BD	0.110 0.242
	Ethernet (RJ45)	SR3NET01BD (1)	0.110 0.242

Connection accessories

Designation	Description	Network	Reference	Weight kg/lb
Modicon unmanaged Ethernet switch	<input type="checkbox"/> 5 copper ports <input type="checkbox"/> Certified CE, UL, and RCM	Ethernet TCP/IP	MCSESU053FN0	0.125 0.275
Junction boxes	<input type="checkbox"/> Screw terminals for trunk cable <input type="checkbox"/> 2x RJ45 connectors for tap link <input type="checkbox"/> Isolation of RS 485 serial link <input type="checkbox"/> Polarization and line termination <input type="checkbox"/> 24 V $\bar{\bar{}}$ power supply <input type="checkbox"/> Mounting on $\bar{\bar{}}$ rail (35 mm/1.38 in.)	Modbus serial link	TWDXCAISO	0.100 0.220
		Modbus serial link	TWDXCAT3RJ	0.080 0.176
Line terminator	<input type="checkbox"/> For RJ45 connector <input type="checkbox"/> R = 120 Ω , C = 1 nF	Modbus serial link	VW3A8306RC	0.200 0.440

Designation	Description	Network	Length m/ft	Reference	Weight kg/lb
T-junctions	<input type="checkbox"/> 2x RJ45 connectors <input type="checkbox"/> 1 integrated cable with RJ45 connector	Modbus serial link	0.3/0.98	VW3A8306TF03	0.190 0.418
			1/3.28	VW3A8306TF10	0.210 0.462
			3/9.84	VW3A8306R30	0.150 0.330
RS 485 extension cables	<input type="checkbox"/> 2x RJ45 connectors	Modbus serial link	0.3/0.98	VW3A8306R03	0.030 0.066
			1/3.28	VW3A8306R10	0.050 0.110
			3/9.84	VW3A8306R30	0.150 0.330
Straight-through shielded twisted pair extension cables	<input type="checkbox"/> 2x RJ45 connectors	Ethernet Modbus/TCP	2/6.56	490NTW00002 (2)	–
			5/16.4	490NTW00005 (2)	–
			12/39	490NTW00012 (2)	–
			40/131	490NTW00040 (2)	–
			80/262	490NTW00080 (2)	–

(1) Can only be used in FBD language.

(2) Cable compliant with EIA/TIA-568 Category 5 and IEC 1180/EN 50173 Class D. For UL and CSA 22.1 approved cables, add the letter **U** at the end of the reference.



Analog I/O extension module for modular smart relays

Presentation

Modular smart relays and analog I/O extension modules

To improve performance and flexibility, Zelio Logic modular smart relays can take analog I/O extension modules with 10-bit resolution. The inputs accept 0-10 V, 0-20 mA, and Pt100 signals.

Using a Zelio Logic modular smart relay with a 24 V $\overline{\text{AC}}$ power supply in conjunction with an analog I/O extension module with 4 I/O makes it possible to obtain up to 30 I/O, including 8 analog inputs and 2 analog outputs.

The analog I/O extension module works with SR3●●●BD smart relays with a 24 V $\overline{\text{AC}}$ power supply.

Description

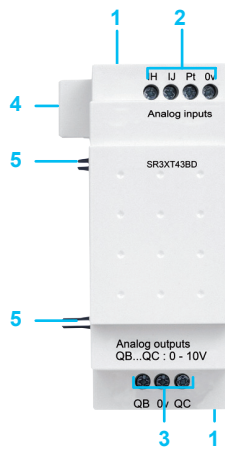

The analog I/O extension module front panel comprises:

- 1 Two retractable mounting lugs
- 2 Terminals for connecting the inputs
- 3 Terminals for connecting the outputs
- 4 Connector for connection to the smart relay (powered via the smart relay)
- 5 Locating pegs

Combination of modular smart relays and extension modules

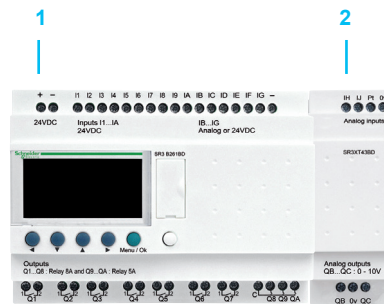

- 1 Modular smart relay (10 or 26 I/O)
- 2 Analog I/O extension module (4 I/O)

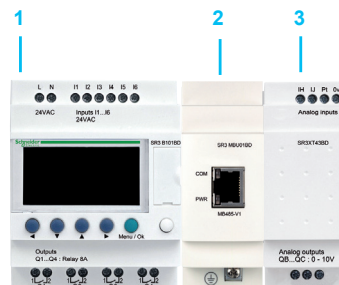

- 1 Modular smart relay (10 or 26 I/O)
- 2 Modbus serial link or Ethernet Modbus/TCP network communication extension modules
- 3 Analog I/O extension module (4 I/O)

⚠ Observe the order of assembly above when using a network communication extension module and an analog I/O extension module. An I/O extension module cannot be inserted before a network communication extension module.

Zelio Logic

Analog I/O extension module



SR3XT43BD

Analog I/O extension module

24 V $\overline{\text{---}}$ power supply (via SR3B●●●BD smart relays)

Number of I/O	Number of inputs	Including 0-10 V	Including 0-20 mA	Including Pt100	0-10 V output	Reference	Weight kg/lb
4	2	2 max.	2 max.	1 max.	2	SR3XT43BD (1)	0.110/ 0.243

(1) Can only be used in FBD language.

Zelio Logic

Modem communication interface



Modem communication interface



GSM/UMTS modem (1)

Presentation

The communication products in the Zelio Logic range are primarily designed for monitoring or remote control of machines or installations that operate without personnel. Examples:

- monitoring of lift pumps, livestock buildings (ventilation, feed level, etc.), refrigeration units, car washes
- alarm in the event of failure of industrial or domestic heating boilers
- remote control of lighting: parking lots, warehouses
- remote control and monitoring of escalators, public transport
- refuse compactor full alert

The communication range comprises:

- a communication interface connected between a smart relay and a modem
- A GSM/UMTS modem (1)
- "Zelio Logic Alarm" software

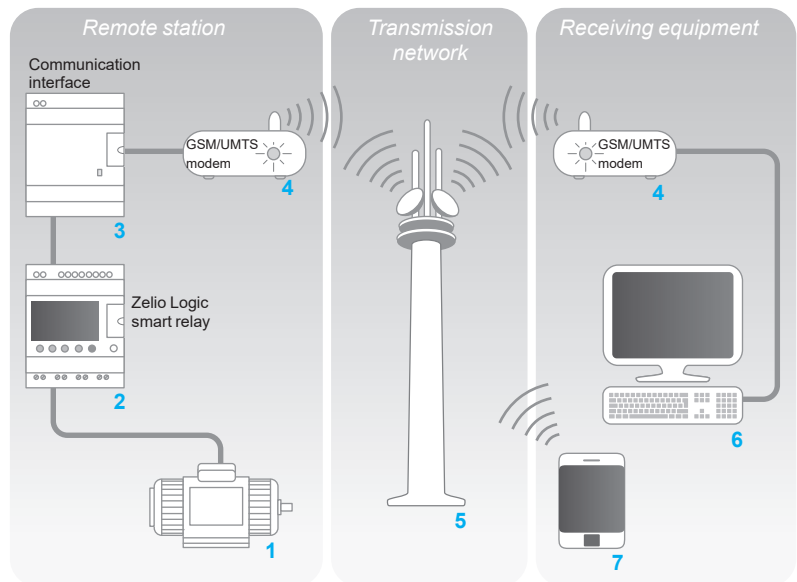

The system comprises:

- A remote station, machine, or installation to be monitored 1: control is achieved using a Zelio Logic smart relay with clock from the SR●B●●●●● or SR2E●●●●● range 2 via its inputs and outputs. The smart relay is connected via a communication interface 3 to a GSM/UMTS modem (1) 4.
- The GSM/UMTS telephone transmission network 5 provided by different telecommunications operators
- A monitoring or control receiver device, which may be either of the following:
 - A PC 6 equipped with a GSM/UMTS modem
 - A GSM/UMTS phone 7

Note: The majority of modems built into PCs can be used.

Various combinations are possible between the types of modem used on the remote station, the type of receiver device (PC + modems or phone), and the type of GSM/UMTS network available.

The type of architecture selected will therefore mainly depend on whether there is a need to send SMS messages or not (see page 35).

(1) GSM = Global System Mobile (2G). UMTS = Universal Mobile Telecommunications System (3G). The versions of modem communicating on the UMTS network (3G) are reserved for certain countries. Please contact our Customer Care Center.

Presentation (continued)

Smart relay (remote station)

As on an independent machine or installation, the smart relay is used for control (1). It contains the application program created using “Zelio Soft 2”.

The smart relay can be selected from the various models in the Zelio Logic range:

- according to the supply voltage
- with 10, 12, 20, or 26 I/O (up to 40 I/O with discrete extension module)
- with or without display
- with clock

Modem communication interface (remote station)

The modem communication interface allows messages, phone numbers, and calling conditions to be stored.

When the calling conditions are met, the messages, as well as any values to be sent, are date-stamped and stored in the interface.

The modem communication interface scales analog values to the physical values (degrees, bar, Pascal, etc.) required by the user.

GSM/UMTS modem

GSM/UMTS modems can be used on both the *remote station* and PC-type *receiver devices* (if the PC is not equipped with an internal modem). This modem automatically adapts to the available network by prioritizing the GSM network, which offers the greatest functionality. If there is only a UMTS network available, there will be reduced functionality (see the table on [page 35](#)).

In order to exploit the capabilities associated with the the communication modem, the modems are equipped with data SIM cards. Voice SIM cards may also be used but some functions will not be available (see the table on [page 35](#)).

“Zelio Logic Alarm” alarm management software (PC type receiver device)

This software is used to:

- receive, classify, and export diagnostic alarm messages
- read or remotely force the status of program elements (inputs, outputs, auxiliary relays, timer or counter values, etc.)
- send control instructions (RUN, STOP, setting the time of the smart relay, etc.)
- send specific instructions (modifying access rights, recipients, etc.)

Note: This software can only be used on GSM networks (2G).

(1) *Zelio Logic smart relays (see [page 8](#))*

Description

The SR2COM01 modem communication interface comprises:

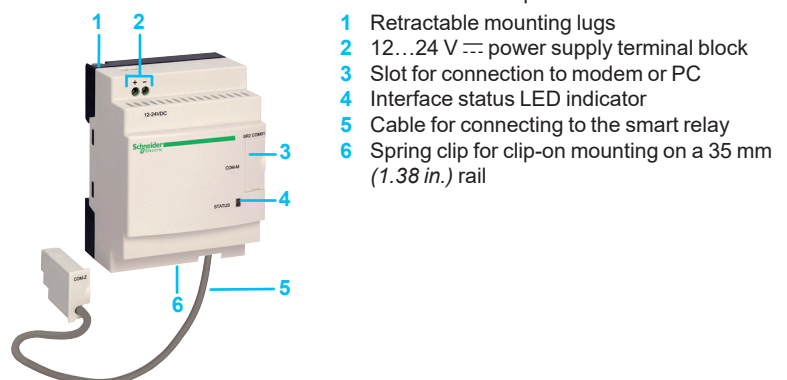

- 1 Retractable mounting lugs
- 2 12...24 V $\overline{\text{---}}$ power supply terminal block
- 3 Slot for connection to modem or PC
- 4 Interface status LED indicator
- 5 Cable for connecting to the smart relay
- 6 Spring clip for clip-on mounting on a 35 mm (1.38 in.) rail

Functions

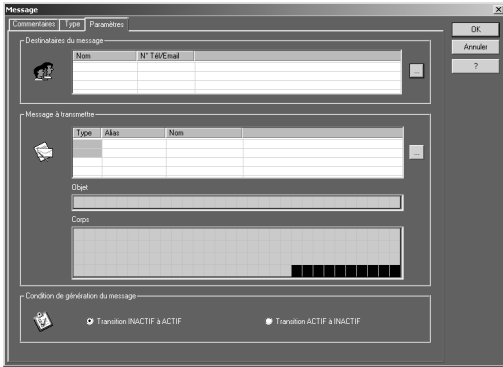

Message parameter entry window

Sending alarms

This function is used to send an alarm message to a *receiver device*. When the calling condition is met, a message is sent to one or several phone numbers or e-mail addresses.

Types of message:

- alarm message on a PC with modem and “Zelio Logic Alarm” software
- SMS message (1) on a GSM/UMTS phone
- e-mail via SMS (1) (2)

One or all of these solutions can be selected simultaneously.

The *remote station* to be monitored initiates the call.

The phone line is only used while the alarm message is being transmitted.

Up to 28 messages can be used.

These messages consist of:

- a 160-character text, which may contain discrete and/or analog values (counter values, analog input voltages that can be scaled, etc.)
- 1 to 10 recipient phone numbers/e-mail addresses

Receiving commands

This function allows the status or the value of a program element to be modified from the *receiver device*.

The operator initiates the call using the *receiver device* (PC or phone). It is then possible to force the status of the discrete and/or analog value of each of the 28 messages.

Remote dialog using “Zelio Soft 2”

This function enables use of the Transfer, Monitoring, and Diagnostics modes available in “Zelio Soft 2” via the *transmission network* instead of via the physical link (SR2USB01 or SR2CBL01 cable) between the device (*remote station*) and the PC (*receiver device*).

It is then possible to:

- transfer a program created on a PC to the *remote station*
- transfer a program installed on the *remote station* to the PC
- modify the receiver device phone numbers/e-mail addresses and the alarm sending conditions from the PC
- update the firmware of the smart relay and the modem communication interface
- display and modify discrete and analog values
- perform diagnostics on the smart relay and modem communication interface

(1) Requires the use of a GSM/UMTS modem on the *remote station* side.

(2) Check with the transmission network operator that the e-mail by SMS service is available.

Functions available depending on the hardware architecture and/or type of SIM card

Function	Remote station device			
	GSM network (2G)			UMTS network (3G)
	Type of SIM card			
Data	Data and voice	Voice		
		Data number	Voice number	
Send alarm/receive command with GSM/UMTS phone	Available	Available	Available	Available
Send alarm/receive command with PC equipped with “Zelio Logic Alarm” software (1)	Available	Available	Not available	Not available
Transfer program, update firmware, monitoring (1)	Available	Available	Not available	Not available
Send alarm via e-mail	Available	Available	Available	Not available

Available

Functions not available

Note: Commands cannot be sent by e-mail.

(1) When using a GSM/UMTS modem on the PC side, it is essential that the SIM card has a data number.

Installation setup

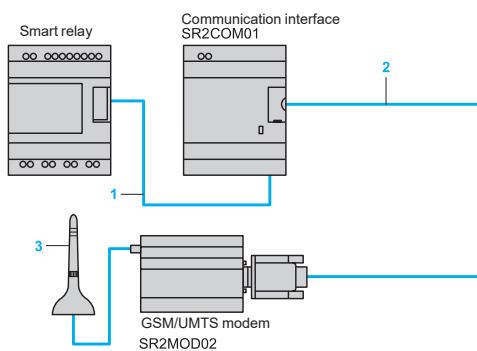
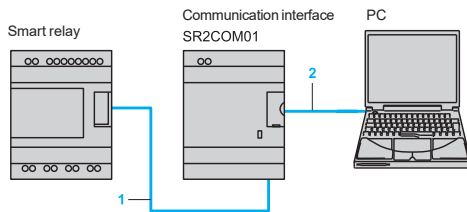

There are two steps involved in setting up the installation or machine to be monitored:

Connection for programming the smart relay and interface

- 1 Interface cable marked COM-Z
- 2 SR2USB01 or SR2CBL01 cable

After having powered-up the smart relay and the interface, the application program can be transferred in order to simultaneously:

- load the automation system program into the smart relay
- load the alarm conditions, messages, and phone numbers into the interface

This operation can also be carried out remotely using "Transfer" mode, after having established the connections described below.

△ The use of memory cartridge SR2MEM01 or SR2MEM02 to load the program is not compatible with the SR2COM01 modem communication interface.

Connections for operation

- 1 Interface cable marked COM-Z
- 2 SR2CBL07 cable supplied with the interface
- 3 Antenna included with modem

References



SR2COM01



SR2MOD02



SR2CBL07

Modem communication interface

Description	For use with	Power supply	Reference	Weight kg/lb
Modem communication interface (including SR2CBL07 cable)	SR●B●●●● SR2E●●●●	12...24 V $\overline{\text{---}}$	SR2COM01	0.200 0.441

Modem

Description	Supply voltage	Reference	Weight kg/lb
GSM/UMTS modem (1) including: □ power supply cable (1.5 m/4.92 ft) □ antenna with cable (2.5 m/8.2 ft) □ mounting on \perp rail (assembled with GSM/UMTS modem) □ 2 lugs for plate mounting	12...24 V $\overline{\text{---}}$	SR2MOD02 (2)	0.335 0.739

Software

Description	Use Compatibility	Reference
Zelio Logic Alarm This software was previously supplied on CD. It is now supplied as a free download available on our website.	For PC and 32-bit and 64-bit operating systems compatible with Windows 7, 8.1, and 10	Free download from our website

Connection accessories

Description	Composition/Use	Length m/ft	Reference	Weight kg/lb
Connecting cables	9-way SUB-D/9-way SUB-D connectors Between Modem and PC	1.8/5.906	SR1CBL03	0.110 0.243
	Special Zelio/9-way SUB-D connector Between communication interface and modem	0.5/1.640	SR2CBL07 (3)	0.050 0.110

(1) Global System Mobile (2G)/Universal Mobile Telecommunications System (3G). The versions of modem communicating on the UMTS network (3G) are reserved for certain countries. Please contact our Customer Care Center for more information.

(2) Not recommended for Japan.

(3) Spare part (cable included as standard with SR2COM01 communication interface).

#			
14210	20	SR3NET01BD	29
14211	20	SR3PACK2BD	18
490NTW00002	29	SR3PACK2FU	18
490NTW00005	29	SR3PACKBD	18
490NTW00012	29	SR3PACKFU	18
490NTW00040	29	SR3XT101B	19
490NTW00080	29	SR3XT101BD	19
		SR3XT101FU	19
		SR3XT101JD	19
H		SR3XT141B	19
HMISTO705	20	SR3XT141BD	19
		SR3XT141FU	19
M		SR3XT141JD	19
MCSESU053FN0	29	SR3XT43BD	31
S		SR3XT61B	19
SR1CBL03	35	SR3XT61BD	19
SR2A101BD	16	SR3XT61FU	19
SR2A101FU	16	SR3XT61JD	19
SR2A201BD	16		
SR2A201E	16	T	
SR2A201FU	16	TM1STNTCRN52015	21
SR2B121B	16	TM1STNTCRN52030	21
SR2B121BD	16	TM1STNTCRN52050	21
SR2B121FU	16	TM1STNTCRN61515	21
SR2B121JD	16	TM1STNTCRN61530	21
SR2B122BD	16	TM1STNTCRN61550	21
SR2B201B	16	TM1STNTCSF44015	21
SR2B201BD	16	TM1STNTCSF44030	21
SR2B201FU	16	TM1STNTCSN62015	21
SR2B201JD	16	TM1STNTCSN62030	21
SR2B202BD	16	TM1STNTCSN62050	21
SR2BTC01	20	TM1STNTCW69755	21
SR2CBL01	20	TM1STNTCWN75750	21
SR2CBL07	35	TM1STNTNTC62015	21
SR2CBL09	20	TM1STNTNTC62030	21
SR2COM01	35	TWDXCAISO	29
SR2D101BD	17	TWDXCAT3RJ	29
SR2D101FU	17		
SR2D201BD	17	V	
SR2D201FU	17	VW3A8306R03	29
SR2E121B	17	VW3A8306R10	29
SR2E121FU	17	VW3A8306R30	29
SR2E201B	17	VW3A8306RC	29
SR2E201BD	17	VW3A8306TF03	29
SR2E201FU	17	VW3A8306TF10	29
SR2MEM01	20		
SR2MEM02	20		
SR2MOD02	35		
SR2PACK2BD	16		
SR2PACK2FU	16		
SR2PACKBD	16		
SR2PACKFU	16		
SR2USB01	20		
SR3B101B	18		
SR3B101BD	18		
SR3B101FU	18		
SR3B102BD	18		
SR3B261B	18		
SR3B261BD	18		
SR3B261FU	18		
SR3B261JD	18		
SR3B262BD	18		
SR3MBU01BD	29		

Life Is On



Learn more about our products at
www.se.com

The information provided in this documentation contains general descriptions and/or technical characteristics of the performance of the products contained herein. This documentation is not intended as a substitute for and is not to be used for determining suitability or reliability of these products for specific user applications. It is the duty of any such user or integrator to perform the appropriate and complete risk analysis, evaluation and testing of the products with respect to the relevant specific application or use thereof. Neither Schneider Electric nor any of its affiliates or subsidiaries shall be responsible or liable for misuse of the information contained herein.

Design: Schneider Electric
Photos: Schneider Electric

Schneider Electric Industries SAS

Head Office
35, rue Joseph Monier - CS 30323
F-92500 Rueil-Malmaison Cedex
France

DIA3ED2111202EN
January 2022 - V4.0