

# Section 7

## Miniature and Molded Case Circuit Breakers

Selection Information	7-1
QO™ and QOU Miniature Circuit Breakers	7-11
Homeline™ Miniature Circuit Breakers	7-21
Multi9™ Miniature Circuit Breakers	7-24
PowerPacT™ Molded Case Circuit Breakers	7-30
Mission Critical Circuit Breakers	7-46
500 Vdc Circuit Breakers	7-47
Automatic Switches	7-48
Motor Circuit Protectors	7-49
PowerPacT™ Circuit Breaker Accessories	7-55
MicroLogic™ Electronic Trip Units	7-65
MasterPacT™ Power Circuit Breakers	7-70
Enerlin'X Digital Solutions	7-79
Ground-Fault Protection	7-84
Dimensions and Shipping Weights	7-85
Circuit Breaker Enclosures	7-87



B-Frame



H-Frame



J-Frame



L-Frame



M-Frame



P-Frame



R-Frame

QO Miniature Circuit Breakers

QO™ Circuit Breakers																	
																	
Circuit Breaker Type	Plug-on	QO			QO-H			QO-VH			QH		QOT	QO-AF	QO-VHAF	QO-AFGF	QOVH-AFGF
	Bolt-on	QOB			QOB-H			QOB-VH			QHB		—	QOB-CAFI	QOB-VHAF	QOB-DF	QOB-VHDF
	Unit Mount	—			—			—			—		—	—		—	
Number of Poles	1	2	3	2	1	2	3	1	2, 3 [1]	1, 2	3	1	1, 2	1, 2	1	1	
Current Range (A)	10–70	10–200 [2]	10–100	15–100	15–70	15–125	15–100	15–70	15–150	15–30	15–30	15–30	15–20	15–20	15–20	15–20	
Interrupting Ratings																	
UL/CSA Rating (kA) (50/60 Hz)	120 Vac	10	10	10	10	22	22	22	22	22	65	65	10	10	22	10	22
	120/240 Vac	10	10	10	10	22	22	22	22	22	65	65	10	10	22	—	—
	208Y/120	—	—	—	—	—	—	—	—	—	—	—	—	—	—	—	—
	240 Vac [3]	—	—	10	10	—	—	22	—	22 [4]	—	65	—	—	—	—	—
	277 Vac	—	—	—	—	—	—	—	—	—	—	—	—	—	—	—	—
DC Ratings	48 Vdc	—	5 [5]	—	—	—	—	—	—	—	—	—	—	—	—	—	—
	60 Vdc	—	—	—	—	—	—	—	—	—	—	—	—	—	—	—	—
	65 Vdc	—	—	—	—	—	—	—	—	—	—	—	—	—	—	—	—
	125 Vdc	—	—	—	—	—	—	—	—	—	—	—	—	—	—	—	—
	250 Vdc	—	—	—	—	—	—	—	—	—	—	—	—	—	—	—	—
	500 Vdc	—	—	—	—	—	—	—	—	—	—	—	—	—	—	—	—
IEC 60947-2 (50/60 Hz) [6]	IEC (Icu)	—	—	—	—	—	—	—	—	—	—	—	—	—	—	—	—
Special Ratings																	
CCC	—																
Fed. Specs W-C-375B/GEN	X	—	—	—	X	—	—	—	—	X	—	X	X	—	—	X	X
Other Standard	HACR [7] NOM			HACR [7]						—	—	—	HACR [7]	—	HACR [7]	HACR [7]	
Accessories and Modifications																	
Shunt Trip [8]	X	X	X	X	X	X	X	X	X	X [9]	X	X	X	—	—	—	—
Undervoltage Trip	—	—	—	—	—	—	—	—	—	—	—	—	—	—	—	—	—
Auxiliary Switches [8]	X	X	X	X	X	X	X	X	X	X [9]	X	X	X	—	X	—	—
Alarm Switch [8]	X	X	X	X	X	X	X	X	X	X [9]	X	X	X	—	X	—	—
Handle Operators	—	—	—	—	—	—	—	—	—	—	—	—	—	—	—	—	—
Handle Padlock Attachment	X	X	X	X	X	X	X	X	X	X	X	X	X	X	X	X	X
Trip System Type																	
Thermal-magnetic	X	X	X	X	X	X	X	X	X	X	X	X	X	X	X	X	X
Molded Case Switch	X	X	X	—	—	—	—	—	—	—	—	—	—	—	—	—	—
Dimensions (1P Unit Mount)																	
Dimensions (1P Unit Mount) in. (mm)	Height	3.5 (89) [1]										4.75 (121)					
	Width	—										0.75 (19) [1]					
	Depth	—										2.92 (74) [1]					
Pages	—										page 7-11						

[1] For dimensions for QOB2150VH, QOB3110VH, QOB3125VH and QOB3150VH, see page 7-85

[2] 2P 150–200 A requires 4P width.

[3] See the Supplemental Digest, Section 3 for 3Ø corner grounded systems.

[4] 22 kA @ 240 Vac for 3P only.

[5] 2P, 10–60 A only, suffix 5272.



[6] See the Supplemental Digest Section 10 for circuit breakers with IEC ratings.

[7] HACR on QO, QOB 1P 10–70 A, 2P 15–100 A, 3P 10–100 A; QOB-VH 1P 15–70 A, 2P 15–125 A, 3P 15–100 A.

[8] Factory-installed option only.

[9] Factory-installed accessories are not available on QOB-VH 2P150 A and 3P 110–150 A.

**QO-GFI, QO-EPD, QOU, QOM Miniature Circuit Breakers**

		QO Circuit Breakers						QOU Circuit Breakers			QOM1 and QOM2 Main Circuit Breakers		
													
Circuit Breaker Type	Plug-on	QO-GFI			QO-VHGF1	QO-EPD QO-EPE		—			—	—	
	Bolt-on	QOB-GFI			QOB-VHGF1	QOB-EPD QOB-EPE		—			QOM1-VH	QOM2-VH	
	Unit Mount	—	—	—	—	—	—	QOU			—	—	
Number of Poles	1	2	3	1	1	2	3	1	2	3	2	2	
Current Range (A)	15-30	15-60	15-50	15-30	15-30	15-60	15-50	10-100	10-125	10-100	50-125	100-225	
<b>Interrupting Ratings</b>													
UL/CSA Rating (kA RMS) (50/60 Hz)	120 Vac	10	10	—	22	10	10	—	10	10	10	22	22
	120/240 Vac	—	10	—	—	—	10	—	10	10	10	22	22
	208Y/120	—	—	10	—	—	—	—	—	—	—	—	—
	240 Vac [10]	—	—	—	—	—	—	10	—	—	10	—	—
	277 Vac	—	—	—	—	—	—	—	—	—	—	—	—
DC Ratings	480Y/277 Vac	—	—	—	—	—	—	—	—	—	—	—	—
	48 Vdc	—	—	—	—	—	—	—	—	—	—	—	—
	60 Vdc	—	—	—	—	—	—	—	5 [11]	5 [11]	5 [11]	—	—
	65 Vdc	—	—	—	—	—	—	—	—	—	—	—	—
	125 Vdc	—	—	—	—	—	—	—	—	—	—	—	—
	250 Vdc	—	—	—	—	—	—	—	—	—	—	—	—
IEC 60947-2 (50/60 Hz) Icu	500 Vdc	—	—	—	—	—	—	—	—	—	—	—	—
	240 Vac	—	—	—	—	—	—	—	—	—	—	—	—
	415 Vac	—	—	—	—	—	—	—	—	—	—	—	—
<b>Special Ratings</b>													
CCC	—	—	—	—	—	—	—	X [12]	X [12]	X [12]	—	—	
Fed. Specs W-C-375B/GEN	X	—	—	—	X	—	—	X	X	X	X	X	
Other Standard	NOM			—	NOM		—	HACR [13]			—	—	
<b>Accessories and Modifications</b>													
Shunt Trip	—	—	—	—	—	—	—	X [14]	X [14]	X [14]	—	X [14]	
Undervoltage Trip	—	—	—	—	—	—	—	—	—	—	—	—	
Auxiliary Switches	X	X	X	X	X	X	X	X [14]	X [14]	X [14]	—	—	
Alarm Switch	X	X	X	X	X	X	X	X [14]	X [14]	X [14]	—	—	
Handle Operators	—	—	—	—	—	—	—	—	—	—	—	—	
Handle Padlock Attachment	X	X	X	X	X	X	X	X	X	X	X	X	
<b>Trip System Type</b>													
Thermal-magnetic	X	X	X	X	X	X	X	X	X	X	X	X	
Molded Case Switch	—	—	—	—	—	—	—	—	X	X	—	—	
<b>Dimensions (1P Unit Mount)</b>													
Dimensions (1P Unit Mount) in. (mm)	Height	4.12 (103)						4.05 (103)			5.09 (129) [15]	5.60 (142) [15]	
	Width	0.75 (19)						0.75 (19)			5.00 (127) [15]	5.07 (129) [15]	
	Depth	2.92 (74)						2.92 (74)			3.47 (88) [15]	3.60 (91) [15]	
Pages	page 7-11						page 7-18			See Section 1			

**NOTE:** All circuit breakers on this chart are UL Listed and CSA Certified unless otherwise noted.

[10] For information regarding 3Ø corner grounded systems see the Supplemental Digest, Section 3.  
 [11] QOU is UL Listed for 60 Vdc per pole 80-100 A, 1P; 80-125 A, 2P; and 70-100 A, 3P.  
 [12] 15-70 A 1P and 2P, 15-60 A 3P  
 [13] HACR on QOU 1P and 3P 15-100 A, 2P 15-125 A;  
 [14] Factory-installed option only.  
 [15] QOM1 and QOM2 dimensions are for 2-pole unit.

HOM Circuit Breakers

HOM Circuit Breakers										
Circuit Breaker Type	Plug-on		HOM	HOM-CAFI	HOM-DF	HOM-GFI	HOM-EPD	HOMT		
	Bolt-on	—	—	—	—	—	—	—	—	—
	Unit Mount	—	—	—	—	—	—	—	—	—
Number of Poles		1	2	1, 2	1	1	2	1	2	1
Current Range (A)		15–50	15–200 [16]	15–20	15–20	15–20	15–50	15–20	15–50	15–50 [17]
Interrupting Ratings										
UL/CSA Rating (kA) (50/60 Hz)	120 Vac	10	10	10	10	10	10	10	10	10
	120/240 Vac	10	10	10	—	—	10	—	10	10
	208Y/120	—	—	—	—	—	—	—	—	—
	240 Vac [18]	—	—	—	—	—	—	—	—	—
	277 Vac	—	—	—	—	—	—	—	—	—
DC Ratings	480Y/277 Vac	—	—	—	—	—	—	—	—	—
	48 Vdc	—	—	—	—	—	—	—	—	—
	60 Vdc	—	—	—	—	—	—	—	—	—
	65 Vdc	—	—	—	—	—	—	—	—	—
	125 Vdc	—	—	—	—	—	—	—	—	—
IEC 60947-2 (50/60 Hz) [19]	250 Vdc	—	—	—	—	—	—	—	—	—
	IEC (Icu)	—	—	—	—	—	—	—	—	—
Special Ratings										
CCC		—	—	—	—	—	—	—	—	—
Fed. Specs W-C-375B/GEN		X	X	X	X	X	X	X	X	X
Other Standard		HACR [20] NOM			HACR [20]					
Accessories and Modifications										
Shunt Trip [21]		—	—	—	—	—	—	—	—	—
Undervoltage Trip		—	—	—	—	—	—	—	—	—
Auxiliary Switches [21]		—	—	—	—	—	—	—	—	—
Alarm Switch [21]		—	—	—	—	—	—	—	—	—
Handle Operators		—	—	—	—	—	—	—	—	—
Handle Padlock Attachment		X	X	X	X	—	—	—	—	X [22]
Trip System Type										
Thermal-magnetic		X	X	X	X	X	X	X	X	X
Molded Case Switch		—	—	—	—	—	—	—	—	—
Dimensions (1P Unit Mount)										
Dimensions (1P Unit Mount) in. (mm)	Height									3.13 (79)
	Width									1.00 (25)
	Depth									2.98 (76)
Pages										page 7-21

[16] 2P 150–200 A requires 4P width.  
 [17] HOMT tandem is 30 A maximum. HOMT quad tandem has 20 A maximum on outside poles, and 50 A maximum on the inside poles.  
 [18] See the Supplemental Digest, Section 3 for 3Ø corner grounded systems.  
 [19] See the Supplemental Digest Section 10 for circuit breakers with IEC ratings.  
 [20] HACR on HOM 1P 15–50 A and 2P 15–100 A.  
 [21] Factory-installed option only.  
 [22] Handle padlock attachment available for HOMT quad tandem only.

**Multi9™, EDB Miniature Circuit Breakers**

		Multi9™ Circuit Breakers and Supplementary Protectors							EDB Circuit Breakers						
Circuit Breaker Type	Plug-on	—			—		—		—		—		—		
	Bolt-on	—			—		—		EDB		EGB		EJB		
	Unit Mount	UL 489 C60BP			UL1077 C60SP [23]		C60H-DC		—		—		—		
Number of Poles	1	2	3	1	2	3,4	1	2	1	2,3	1	2,3	1	2,3	
Current Range (A)	0.5–63	0.5–63	0.5–63	0.5–63	1–63	1–63	0.5–63	0.5–63	15–70	15–125	15–70	15–125	15–70	15–125	
<b>Interrupting Ratings</b>															
UL/CSA Rating (kA RMS) (50/60 Hz)	120 Vac	14 [24]	14 [24]	14 [24]	14 [25]	14 [25]	14 [25]	—	—	25	25	65	65	100	100
	120/240 Vac	14 [24]	14 [24]	14 [24]	14 [25]	14 [25]	14 [25]	—	—	18	25	35	65	65	100
	240 Vac [26]	14 [24]	14 [24]	14 [24]	14 [25]	14 [25]	14 [25]	—	—	18	25	35	65	65	100
	277 Vac	—	—	—	10 [27]	10 [27]	10 [27]	—	—	18	18	35	35	65	65
DC Ratings	480Y/277 Vac	10 [28]	10 [29]	10 [29]	—	10 [27]	10 [27]	—	—	—	18	—	35	—	65
	48 Vdc	—	—	—	—	10	—	—	5	5	—	—	—	—	—
	60 Vdc	10	10	—	20	—	—	—	5	5	—	—	—	—	—
	65 Vdc	—	—	—	—	—	—	—	5	5	—	—	—	—	—
	125 Vdc	—	10	—	—	—	—	—	5	5	—	—	—	—	—
	250 Vdc	—	—	—	—	—	—	—	5	5	—	—	—	—	—
IEC 60947-2 (50/60 Hz) Icu	240 Vac	10	20	20	10	20	20	—	—	20	—	—	—	—	—
	415 Vac	—	10	10	—	5	5	—	—	10	—	—	—	—	—
<b>Special Ratings</b>															
CCC	X			X			X			—			—		
Other Standard	IEC							HACR							
<b>Accessories and Modifications</b>															
Shunt Trip	X	X	X	X	X	X	X	X	X	X [31]	X [31]	X [31]	X [31]	X [31]	X [31]
Undervoltage Trip	X	X	X	X	X	X	X	X	X	—	—	—	—	—	—
Auxiliary Switches	X	X	X	X	X	X	X	X	X	X [31]	X [31]	X [31]	X [31]	X [31]	X [31]
Alarm Switch	X	X	X	X	X	X	X	X	X	X [31]	X [31]	X [31]	X [31]	X [31]	X [31]
Handle Operators	X	X	X	X	X	X	X	X	X	—	—	—	—	—	—
Handle Padlock Attachment	X	X	X	X	X	X	X	X	X	X	X	X	X	X	X
<b>Trip System Type</b>															
Thermal-magnetic	X	X	X	X	X	X	X	X	X	X	X	X	X	X	X
Molded Case Switch	—	—	—	—	—	—	—	—	—	—	—	—	—	—	—
<b>Dimensions (1P Unit Mount)</b>															
Dimensions (1P Unit Mount) in. (mm)	Height	4.05 (103)			3.19 (81)		3.19 (81)		5.66 (144)						
	Width	0.71 (18)			0.71 (18)		0.71 (18)	1.42 (36)		0.98 (25)					
	Depth	2.76 (70)			2.76 (70)		2.56 (65)		4.05 (103)						
Pages	page 7-24							See Section 9							

**NOTE:** All circuit breakers on this chart are UL Listed and CSA Certified unless otherwise noted.

[23] C60 are recognized components per UL 1077.  
 [24] 14 kA up to 35 A, 10 kA from 40 to 63 A.  
 [25] 14 kA up to 32 A, 10 kA from 40 to 63 A.  
 [26] For information regarding 3Ø corner grounded systems see the Supplemental Digest, Section 3.  
 [27] 10 kA up to 32 A, 5 kA from 40 to 63 A.  
 [28] Up to 35 A.  
 [29] 10 kA up to 35 A.  
 [30] 2 poles must be wired in series for 500 Vdc.  
 [31] Factory-installed option only.



B-, H-, J-Frame Molded Case Circuit Breakers

		PowerPacT™ 125 A B-Frame				PowerPacT 150 A H-Frame					PowerPacT 250 A J-Frame				
						Electronic Trip Version					Electronic Trip Version				
Circuit Breaker Type		BD	BG	BJ	BK	HD	HG	HJ	HL	HR	JD	JG	JJ	JL	JR
Number of Poles		1, 2, 3, 4	1, 2, 3, 4	1, 2, 3, 4	1, 2	2, 3	2, 3	2, 3 [32]	2, 3 [32]	3	2, 3 [32]	2, 3 [32]	2, 3 [32]	2, 3 [32]	3
Current Range (A)		15-125	15-125	15-125	15-30	15-150	15-150	15-150	15-150	15-150	70-250 [33]	70-250 [33]	70-250 [33]	70-250 [33]	70-250 [33]
Interrupting Ratings															
UL/CSA/ NOM AC Rating (kA RMS) (50/60 Hz)	240 Vac	25	65	100	100	25	65	100	125	200	25	65	100	125	200
	480Y/277 Vac	18 [34]	35	65	65	18	35	65	100	200	18	35	65	100	200
	480 Vac	18 [35]	35 [34]	65	65	18	35	65	100	200	18	35	65	100	200
	600Y/347 Vac	14	18 [34]	25	65	14	18	25	50	100	14	18	25	50	100
UL/CSA/ NOM DC Ratings	250 Vdc [36]	10	20	50	—	20	20	20	20	—	20	20	20	20	—
	500 Vdc [36]	—	—	—	—	—	20	—	50	—	—	20	—	50	—
IEC AC Rating (kA RMS) (50/60 Hz) Icu/Ics [36]	220/240 Vac	25	65	100	100	25	65	100	125	150	25	65	100	125	150
	380/415 Vac	18	35	65	65	18	35	65	100	125	18	35	65	100	125
	440/480 Vac	18	35	65	65	18	35	65	100	125	18	35	65	100	125
	500/525 Vac	14	18	25	25	14	18	25	50	75	14	20	20	20	75
IEC DC Ratings	250 Vdc	—	—	—	—	—	—	—	—	—	20	20	20	20	—
	500 Vdc	—	—	—	—	—	—	—	—	—	20	20	20	20	—
Special Ratings															
CCC		X	X	X	X	X	X	X	X	X	X	X	X	X	X
HACR		X	X	X	X	X	X	X	X	X	X	X	X	X	X
FCC		X	X	X	X	X	X	X	X	X	X	X	X	X	X
CE		X	X	X	X	X	X	X	X	X	X	X	X	X	X
UKCA		X	X	X	X	X	X	X	X	X	X	X	X	X	X
Connections/Terminations															
Unit Mount		X	X	X	X	X	X	X	X	X	X	X	X	X	X
I-Line™		X	X	X	X	X	X	X	X	X	X	X	X	X	X
Rear Connection		—	—	—	—	X [39]	X [39]	X	X	X	X	X	X	X	X
Drawout		—	—	—	—	X [39]	X [39]	X	X	X	X	X	X	X	X
Optional Lugs		X	X	X	X	X [39]	X [39]	X	X	X	X	X	X	X	X
Accessories and Modifications															
Shunt Trip		X	X	X	X	X	X	X	X	X	X	X	X	X	X
Undervoltage Trip		X	X	X	X	X	X	X	X	X	X	X	X	X	X
Auxiliary Switches		X	X	X	X	X	X	X	X	X	X	X	X	X	X
Alarm Switch		X	X	X	X	X	X	X	X	X	X	X	X	X	X
Motor Operator		—	—	—	—	X [39]	X [39]	X	X	X	X	X	X	X	X
Handle Operators		X	X	X	X	X [39]	X [39]	X	X	X	X	X	X	X	X
Mechanical Interlocks (3P)		X	X	X	—	X	X	X	X	X	X	X	X	X	X
Handle Padlock Attachment		X	X	X	X	X [39]	X [39]	X	X	X	X	X	X	X	X
Cylinder Lock (3P)		—	—	—	—	—	—	—	—	—	—	—	—	—	—
Optional GF Protection		—	—	—	—	X	X	X	X	X	X	X	X	X	X
Trip System Type															
Thermal-magnetic		X	X	X	X	X	X	X	X	—	X	X	X	X	X
Instantaneous-only (MCP)		—	—	—	—	—	X	X [40]	X [40]	X [40]	—	X [40]	X [40]	X	X
Molded Case Switch (Automatic)		X	X	X	X	—	X	—	X	—	—	X	—	X	X
Electronic		—	—	—	—	X [40]	X [40]	X [40]	X [40]	X [40]	X [40]	X [40]	X [40]	X [40]	X [40]
Product Dimensions															
Dimensions (3P Unit Mount) in. (mm)	Height	5.4 (137)				6.4 (163)					7.5 (191)				
	Width	3.2 (81)				4.1 (104)					4.1 (104)				
	Depth	3.5 (89)				3.4 (86)					3.4 (86)				
Enclosures (page 7-85–page 7-87)															
General Purpose (NEMA 1)		—	—	—	—	X	X	X	X	—	X	X	X	X	—
Raintight (NEMA 3R)		—	—	—	—	X	X	X	X	—	X	X	X	X	—
Dust-tight (NEMA 12)		—	—	—	—	X	X	X	X	—	X	X	X	X	—
Watertight (NEMA 4, 4X, 5)		—	—	—	—	X	X	X	X	—	X	X	X	X	—
Explosion Proof (NEMA 7, 9)		—	—	—	—	—	—	—	—	—	X [41]	X [41]	—	—	—
Pages (Unit Mount) / (I-Line)		page 7-32 / Section 9				page 7-34 / Section 9					page 7-34 / Section 9				

NOTE: All circuit breakers on this chart are certified to UL and CSA standards unless otherwise noted.

- [32] 2P in a 3P module.
- [33] 70-250 A with electronic trip system
- [34] Only two pole circuit breaker.
- [35] Only two, three and four pole.
- [36] Not available with electronic trip units
- [37] 1P Available at 125 Vdc
- [38] Dual UL and IEC ratings and CE markings on circuit breakers. For additional IEC ratings, see the Supplemental Digest, Section 10.
- [39] Not available in HD and HG 2P rating (2P module).
- [40] 3P only.
- [41] Not UL Listed due to wire bending space.



**PowerPac™ Q-Frame, Q4, LA, LH, L-Frame Molded Case Circuit Breakers**

		PowerPacT 250 A Q-Frame			400 A LA/LH		PowerPacT 600 A L-Frame			
										
Circuit Breaker Type		QB	QD	QG	LA	LH	LG	LJ	LL	LR
Number of Poles		2, 3	2, 3	2, 3	2, 3	2, 3	3, 4	3, 4	3, 4	3, 4
Current Range (A)		70–250 [42]	70–250 [42]	70–250 [42]	125–400	125–400	70–600	70–600	70–600	70–600
<b>Interrupting Ratings</b>										
UL/CSA/NOM AC Rating (kA RMS) (50/60 Hz)	240 Vac	10	25	65	42	65	65	100	125	200
	480Y/277 Vac	—	—	—	30	35	35	65	100	200
	480 Vac	—	—	—	30	35	35	65	100	200
	600Y/347 Vac	—	—	—	22	25	18	25	50	100
UL/CSA/NOM DC Ratings	600 Vac	—	—	—	22	25	18	25	50	100
	250 Vdc [43]	—	—	—	10	50	—	—	—	—
IEC AC Rating (kA RMS) (50/60 Hz) Icu/Ics [45]	500 Vdc [44][43]	—	—	—	—	20	20	—	50	—
	220/240 Vac	10/5	10/5	10/5	—	—	65	100	125	150
IEC DC Ratings	380/415 Vac	10/5	10/5	10/5	20/5[46]	20/5[46]	18	65	100	125
	440/480 Vac	—	—	—	—	—	18	65	100	125
	500/525 Vac	—	—	—	—	—	14	25	50	75
	690 Vac	—	—	—	—	—	—	—	—	20
<b>Special Ratings</b>										
CCC		—	—	—	—	—	X	X	X	X
HACR (2P, 3P)		X	X	X	X	X	X	X	X	X
FCC		—	—	—	—	—	X	X	X	X
CE		—	—	—	—	—	X	X	X	X
UKCA		—	—	—	—	—	X	X	X	X
<b>Connections/Terminations</b>										
Unit Mount		X	X	X	X	X	X	X	X	X
I-Line™		X	X	X	X	X	X	X	X	X
Rear Connection		—	—	—	X	X	X	X	X	X
Drawout		—	—	—	—	—	X	X	X	X
Optional Lugs		—	—	—	X	X	X	X	X	X
<b>Accessories and Modifications</b>										
Shunt Trip		—	—	—	X	X	X	X	X	X
Undervoltage Trip		—	—	—	X	X	X	X	X	X
Auxiliary Switches		—	—	—	X	X	X	X	X	X
Alarm Switch		—	—	—	X	X	X	X	X	X
Motor Operator		—	—	—	X	X	X	X	X	X
Handle Operators		—	—	—	X	X	X	X	X	X
Mechanical Interlocks (3P)		X	X	X	X [47]	X [47]	X	X	X	X
Handle Padlock Attachment		X	X	X	X	X	X	X	X	X
Cylinder Lock (3P[48])		—	—	—	X	X	—	—	—	—
Optional GF Protection[49]		—	—	—	—	—	X	X	X	X
<b>Trip System Type</b>										
Thermal-magnetic		X	X	X	X	X	—	—	—	—
Instantaneous-only (MCP)		—	—	—	X	X	X	X	X	X
Molded Case Switch (Automatic)		X	—	—	—	X	—	—	X	X
Electronic		—	—	—	—	—	X	X	X	X
<b>Product Dimensions</b>										
Dimensions (3P Unit Mount) in. (mm)	Height	6.47 (164)			11 (279)		13.38 (340)			
	Width	4.5 (114)			6 (152)		5.51 (140)			
	Depth	3.93 (100)			5.84 (148)		4.33 (110)			
<b>Enclosures (page 7-85–page 7-87)</b>										
General Purpose (NEMA 1)		X	X	X	X	X	—	—	—	—
Raintight (NEMA 3R)		X	X	X	X	X	—	—	—	—
Dust-tight (NEMA 12)		—	—	—	X	X	X [50]	X [50]	X [50]	X [50]
Watertight (NEMA 4, 4X, 5)		—	—	—	X	X	—	—	—	—
Explosion Proof (NEMA 7, 9)		—	—	—	—	—	—	—	—	—
Pages (Unit Mount) / (I-Line)		page 7-38 / Supplemental Section 9			page / Supplemental Section 9		page 7-40 / Supplemental Section 9			

**NOTE:** All circuit breakers on this chart are certified to UL and CSA standards unless otherwise noted.

[42] I-Line Q-frame circuit breakers are available 70–225 A only. 250 A Q-frame unit-mount circuit breakers are limited to Cu conductors only.  
 [43] Not available with electronic trip units  
 [44] Ungrounded UPS systems only. See page 7-47. Special DC J-Frame only.  
 [45] Dual UL and IEC ratings and CE markings on circuit breakers. For additional IEC ratings, see the Supplemental Digest, Section 10.  
 [46] For additional IEC ratings, see the Supplemental Digest Section 10.  
 [47] Requires circuit breaker with WB suffix.  
 [48] Factory-installed option only.  
 [49] Requires factory-installed "G" shunt trip and 3P module.  
 [50] Enclosure rating 1, 3R, 5 and 12.,

M-, P-, and R-Frame Molded Case Circuit Breakers

	PowerPacT 800 A M-Frame		PowerPacT 1200 A P-Frame				PowerPacT 3000 A R-Frame				
											
Circuit Breaker Type	MG	MJ	PG	PJ	PK	PL	RG	RJ	RK	RL	
Number of Poles	2, 3	2, 3	2, 3, 4	2, 3, 4	2, 3, 4	2, 3, 4	2, 3, 4	2, 3, 4	2, 3, 4	2, 3, 4	
Current Range (A)	300–800	300–800	100–1200	100–1200	100–1200	100–1200	240–3000	240–3000	240–3000	240–3000	
<b>Interrupting Ratings</b>											
UL/CSA/NOM Rating (KA RMS) (50/60 Hz)	240 Vac	65	100	65	100	65	125	65	100	65	125
	480Y/277 Vac	35	65	35	65	50	100	35	65	65	100
	480 Vac	35	65	35	65	50	100	35	65	65	100
	600Y/347 Vac	18	25	18	25	50	—	18	25	65	50
DC Ratings	600 Vac	18	25	18	25	50	—	18	25	65	50
	250 Vdc	—	—	—	—	—	—	—	—	—	—
IEC (KA RMS) (50/60 Hz) Icu/Ics [52]	500 Vdc [51]	—	—	—	—	—	—	—	—	—	—
	240 Vac	50/25	65/35	50/25	65/35	50/25	125/65	50/25	65/35	85/65	125/65
	415 Vac	35/20	50/25	35/20	50/25	50/25	85/45	35/20	50/25	70/55	85/45
<b>Special Ratings</b>											
CCC	X	X	X	X	X	X	X	X	X	X	X
HACR (2P, 3P)	X	X	X	X	X	X	X	X	X	X	X
FCC	X	X	X	X	X	X	X	X	X	X	X
CE	X	X	X	X	X	X	X	X	X	X	X
UKCA	X	X	X	X	X	X	X	X	X	X	X
<b>Connections/Terminations</b>											
Unit Mount	X	X	X	X	X	X	X	X	X	X	X
I-Line™	X	X	X	X	X	X	X	X [53]	X [53]	X [53]	X [53]
Rear Connection	—	—	—	—	—	—	—	—	—	—	—
Drawout	—	—	X [54]	X [54]	X [54]	X [54]	X [54]	—	—	—	—
Optional Lugs	X	X	X	X	X	X	X	X	X	X	X
<b>Accessories and Modifications</b>											
Shunt Trip	X	X	X	X	X	X	X	X	X	X	X
Undervoltage Trip	X	X	X	X	X	X	X	X	X	X	X
Auxiliary Switches	X	X	X	X	X	X	X	X	X	X	X
Alarm Switch	X	X	X	X	X	X	X	X	X	X	X
Motor Operator	—	—	X [54]	X [54]	X [54]	X [54]	X [54]	—	—	—	—
Handle Operators	—	—	X [54]	X [54]	X [54]	X [54]	X [54]	—	—	—	—
Mechanical Interlocks (3P)	—	—	X	X	X	X	—	—	—	—	—
Handle Padlock Attachment	X	X	X	X	X	X	X	X	X	X	X
Cylinder Lock (3P)	—	—	—	—	—	—	—	—	—	—	—
Optional GF Protection	—	—	X	X	X	X	X	X	X	X	X
<b>Trip System Type</b>											
Thermal-magnetic	—	—	—	—	—	—	—	—	—	—	—
Instantaneous-only (MCP)	—	—	—	X	X	—	—	—	—	—	—
Molded Case Switch (Automatic)	X	X	X	X	X	X	X	X	X	X	X
Electronic	X	X	X	X	X	X	X	X	X	X	X
<b>Product Dimensions</b>											
Dimensions (3P Unit Mount)	Height—in. (mm)	12.80 (325)		16.20 (413)				15 (381)			
	Width—in. (mm)	8.30 (210)		8.30 (210)				16.50 (420)			
	Depth—in. (mm)	8.10 (205)		8.10 (205)				14.40 (366)			
<b>Enclosures (page 7-85–page 7-87)</b>											
General Purpose (NEMA 1)	X	X	X	X	X	X	—	—	—	—	
Raintight (NEMA 3R)	X	X	X	X	X	X	—	—	—	—	
Dust-tight (NEMA 12)	X	X	X	X	X	X	—	—	—	—	
Watertight (NEMA 4, 4X, 5)	X	X	—	—	—	—	—	—	—	—	
Explosion Proof (NEMA 7, 9)	—	—	—	—	—	—	—	—	—	—	
Pages (Unit Mount) / (I-Line)	page 7-42 / Section 9		page 7-43, page 7-48 / Section 9				page 7-44, page 7-48 / Section 9				

**NOTE:** All circuit breakers on this chart are certified to UL and CSA standards unless otherwise noted.

[51] Ungrounded UPS systems only. See page 7-47.

[52] Dual UL and IEC ratings and CE markings on circuit breakers. For additional IEC ratings, see the Supplemental Digest, Section 10.

[53] 1000 A and 1200 A only.

[54] 65/50 kA Icu/Ics for 450–600 A ratings.



**MasterPacT MTZ Molded Case Circuit Breakers**



		MasterPacT MTZ1 800–1600 A					MasterPacT MTZ2 800–6000 A				MasterPacT MTZ3 4000–6000 A			
														
Circuit Breaker Type		MTZ1-N	MTZ1-H	MTZ1-L1	MTZ1-L	MTZ1-LF [55]	MTZ2-N	MTZ2-H	MTZ2-L	MTZ2-LF [55]	MTZ2-H	MTZ2-L	MTZ3-H	MTZ3-L
Number of Poles		3, 4	3, 4	3	3	3	3, 4	3, 4	3	3	3, 4	3	3, 4	3
Current Range		400–1200	400–1200	400–1200	400–1200	400–1200	400–2000	400–2000	400–2000	400–2000	1200–3000	1200–3000	2000–6000	2000–6000
<b>Interrupting Ratings</b>														
UL/CSA Rating (kA RMS) (50/60 Hz)	240 Vac	50	65	100	200	200	65	100	200	200	100	200	100	200
	480Y/277 Vac	50	50	65	100	100	65	100	150	150	100	150	100	150
	480 Vac	50	50	65	100	100	65	100	150	150	100	150	100	150
	600Y/347 Vac	35	50	—	—	—	50	85	100	100	85	100	85	100
DC Ratings	600 Vac	35	50	—	—	—	50	85	100	100	85	100	85	100
	250 Vdc	—	—	—	—	—	—	—	—	—	—	—	—	—
IEC [56] (kA RMS) Icu/ Ics	500 Vdc	—	—	—	—	—	—	—	—	—	—	—	—	—
	240 Vac	—	—	—	—	—	—	—	—	—	—	—	—	—
Special Ratings	415 Vac	—	—	—	—	—	—	—	—	—	—	—	—	—
	CCC	—	—	—	—	—	—	—	—	—	—	—	—	—
	Fed. Specs W-C-375B/GEN	—	—	—	—	—	—	—	—	—	—	—	—	—
HACR (2P, 3P)	—	—	—	—	—	—	—	—	—	—	—	—	—	
<b>Connections/Terminations</b>														
Unit Mount		X	X	X	X	X	X	X	X	X	X	X	X	X
I-Line™		—	—	—	—	—	—	—	—	—	—	—	—	—
Rear Connection		X	X	X	X	X	X	X	X	X	X	X	X	X
Drawout		X	X	X	X	X	X	X	X	X	X	X	X	X
Optional Lugs		—	—	—	—	—	—	—	—	—	—	—	—	—
<b>Accessories and Modifications</b>														
Shunt Trip		X	X	X	X	X	X	X	X	X	X	X	X	X
Undervoltage Trip		X	X	X	X	X	X	X	X	X	X	X	X	X
Auxiliary Switches		X	X	X	X	X	X	X	X	X	X	X	X	X
Alarm Switch		X	X	X	X	X	X	X	X	X	X	X	X	X
Motor Operator		X	X	X	X	X	X	X	X	X	X	X	X	X
Handle Operators		—	—	—	—	—	—	—	—	—	—	—	—	—
Mechanical Interlocks		X	X	X	X	X	X	X	X	X	X	X	X	X
Padlock Attachment		X	X	X	X	X	X	X	X	X	X	X	X	X
Optional GF Protection		X	X	X	X	X	X	X	X	X	X	X	X	X
<b>Trip System Type</b>														
Thermal-magnetic		—	—	—	—	—	—	—	—	—	—	—	—	—
Instantaneous-only (MCP)		—	—	—	—	—	—	—	—	—	—	—	—	—
Electronic		X	X	X	X	X	X	X	X	X	X	X	X	X
<b>Product Dimensions</b>														
Dimensions (3P Drawout) in. (mm)	Height	12.67 (322)					17.28 (439)				17.28 (439)		17.28 (439)	
	Width	11.25 (286)					17.74 (450)				17.74 (450)		30.94 (786)	
	Depth	13.54 (344)					18.50 (470)				18.50 (470)		18.50 (470)	
<b>Enclosures</b>														
General Purpose (NEMA 1)		—	—	—	—	—	—	—	—	—	—	—	—	—
Raintight (NEMA 3R)		—	—	—	—	—	—	—	—	—	—	—	—	—
Dust-tight (NEMA 12)		—	—	—	—	—	—	—	—	—	—	—	—	—
Watertight (NEMA 4, 4X, 5)		—	—	—	—	—	—	—	—	—	—	—	—	—
Explosion Proof (NEMA 7, 9)		—	—	—	—	—	—	—	—	—	—	—	—	—
Pages		MasterPacT™ Power Circuit Breakers, page 7-70 and Catalog 0614CT1701												

**NOTE:** All circuit breakers on this chart are certified to UL and CSA standards unless otherwise noted.

[55] Tested to show arc flash hazard risk category as reference by NFPA70E.

[56] See Catalog 0614CT1701 for additional ratings and other information.

MasterPac NT, NW Molded Case Circuit Breakers

MasterPacT 1200 A						MasterPacT 6000 A									
 															
Circuit Breaker Type	NT-N	NT-H	NT-L1	NT-L	NT-LF [57]	NW-N	NW-H	NW-L	NW-LF [57]	NW-H	NW-L	NW-H	NW-L		
Number of Poles	3, 4	3, 4	3	3	3	3, 4	3, 4	3	3	3, 4	3	3, 4	3		
Current Range	100–1200	100–1200	100–1200	100–1200	100–1200	100–2000	100–2000	100–2000	100–2000	640–3000	640–3000	1200–6000	1200–6000		
<b>Interrupting Ratings</b>															
UL/CSA/NOM Rating (kA RMS) (50/60 Hz)	240 Vac	50	65	100	200	200	65	100	200	200	100	200	100	200	
	480Y/277 Vac	50	50	65	100	100	65	100	150	150	100	150	100	150	
	480 Vac	50	50	65	100	100	65	100	150	100	150	100	150		
	600Y/347 Vac	35	50	—	—	—	50	85	100	100	85	100	85	100	
DC Ratings	600 Vac	35	50	—	—	—	50	85	100	100	85	100	85	100	
	250 Vdc	—	—	—	—	—	—	—	—	—	—	—	—		
IEC [58] (kA RMS) Icu/ Ics	500 Vdc	—	—	—	—	—	—	—	—	—	—	—	—		
	240 Vac	—	—	—	—	—	—	—	—	—	—	—	—		
Special Ratings	415 Vac	—	—	—	—	—	—	—	—	—	—	—	—		
	CCC	—	—	—	—	—	—	—	—	—	—	—	—		
	Fed. Specs W-C-375B/GEN	—	—	—	—	—	—	—	—	—	—	—	—		
HACR (2P, 3P)	—	—	—	—	—	—	—	—	—	—	—	—	—		
<b>Connections/Terminations</b>															
Unit Mount	X	X	X	X	X	X	X	X	X	X	X	X	X		
I-Line™	—	—	—	—	—	—	—	—	—	—	—	—	—		
Rear Connection	X	X	X	X	X	X	X	X	X	X	X	X	X		
Drawout	X	X	X	X	X	X	X	X	X	X	X	X	X		
Optional Lugs	—	—	—	—	—	—	—	—	—	—	—	—	—		
<b>Accessories and Modifications</b>															
Shunt Trip	X	X	X	X	X	X	X	X	X	X	X	X	X		
Undervoltage Trip	X	X	X	X	X	X	X	X	X	X	X	X	X		
Auxiliary Switches	X	X	X	X	X	X	X	X	X	X	X	X	X		
Alarm Switch	X	X	X	X	X	X	X	X	X	X	X	X	X		
Motor Operator	X	X	X	X	X	X	X	X	X	X	X	X	X		
Handle Operators	—	—	—	—	—	—	—	—	—	—	—	—	—		
Mechanical Interlocks	X	X	X	X	X	X	X	X	X	X	X	X	X		
Padlock Attachment	X	X	X	X	X	X	X	X	X	X	X	X	X		
Cylinder Lock	—	—	—	—	—	—	—	—	—	—	—	—	—		
Optional GF Protection	X	X	X	X	X	X	X	X	X	X	X	X	X		
<b>Trip System Type</b>															
Thermal-magnetic	—	—	—	—	—	—	—	—	—	—	—	—	—		
Instantaneous-only (MCP)	—	—	—	—	—	—	—	—	—	—	—	—	—		
Molded Case Switch (Automatic)	X	X	X	X	X	X	X	X	X	X	X	X	X		
Electronic	X	X	X	X	X	X	X	X	X	X	X	X	X		
<b>Product Dimensions</b>															
Dimensions (3P Drawout) in. (mm)	Height	12.67 (322)				17.28 (439)				17.28 (439)				17.28 (439)	
	Width	11.25 (286)				17.74 (450)				17.74 (450)				30.94 (786)	
	Depth	13.00 (331)				18.38 (467)				18.38 (467)				18.38 (467)	
<b>Enclosures</b>															
General Purpose (NEMA 1)	—	—	—	—	—	—	—	—	—	—	—	—	—		
Raintight (NEMA 3R)	—	—	—	—	—	—	—	—	—	—	—	—	—		
Dust-tight (NEMA 12)	—	—	—	—	—	—	—	—	—	—	—	—	—		
Watertight (NEMA 4, 4X, 5)	—	—	—	—	—	—	—	—	—	—	—	—	—		
Explosion Proof (NEMA 7, 9)	—	—	—	—	—	—	—	—	—	—	—	—	—		
Pages	page 7-77 and Catalog 0613CT0001						page 7-77 and Catalog 0613CT0001								

**NOTE:** All circuit breakers on this chart are certified to UL and CSA standards unless otherwise noted.

7 MINIATURE AND MOLDED CASE CIRCUIT BREAKERS

[57] Tested to show arc flash hazard risk category as reference by NFPA70E.  
[58] See Catalog 0613CT0001 for additional ratings and other information.

**QO Standard Plug-On Circuit Breakers**

Square D brand QO miniature circuit breakers are plug-on products for use in QO and QON load centers, NQ panelboards, NQ OEM interiors or Speed-D™ switchboard distribution panels. Bolt-on QOB circuit breakers are for use in NQOB and NQ panelboards or interiors. [1]

The Square D exclusive Qwik-Open™ mechanism, with a trip reaction within 1/60th of a second, is standard on all 1P 15 and 20 A QO circuit breakers.



**Table 7.1: Standard QO Plug-On Circuit Breakers**

Amperes Rating [2]	1P—120/240 Vac	2P—120/240 Vac Common Trip	2P—240 Vac [3] Common Trip	3P—240 Vac Common Trip
<b>10 k AIR</b>				
10 A	QO110	QO210	—	QO310
15 A	QO115 [4] [5]	QO215 [4]	QO215H	QO315 [4]
20 A	QO120 [4] [5]	QO220 [4]	QO220H	QO320 [4]
25 A	QO125 [4]	QO225 [4]	QO225H OBS	QO325 [4]
30 A	QO130 [4]	QO230 [4]	QO230H	QO330 [4]
35 A	QO135 [4]	QO235 [4]	—	QO335 [4]
40 A	QO140 [4]	QO240 [4]	QO240H	QO340 [4]
45 A	QO145 OBS	QO245 [4]	—	QO345 [4]
50 A	QO150 [4]	QO250 [4]	QO250H OBS	QO350 [4]
60 A	QO160 [4]	QO260 [4]	QO260H OBS	QO360 [4]
70 A	QO170 [4]	QO270 [4]	QO270H OBS	QO370 [4]
80 A	—	QO280 [4]	QO280H OBS	QO380 [4]
90 A	—	QO290 [4]	QO290H OBS	QO390 [4]
100 A	—	QO2100 [4]	QO2100H	QO3100 [4]
110 A	—	QO2110 [4]	—	—
125 A	—	QO2125 [4]	—	—
150 A	—	QO2150 [4] [6]	—	—
175 A	—	QO2175 [4] [7] [6]	—	—
200 A	—	QO2200 [4] [7] [6]	—	—
Molded Case Switch 60 A max.—240 Vac		—	QO200	QO300 OBS
<b>22 k AIR [4]</b>				
15 A	QO115VH [5]	QO215VH [8]	—	QO315VH [8]
20 A	QO120VH [5]	QO220VH [8]	—	QO320VH [8]
25 A	—	QO225VH [8]	—	QO325VH [8]
30 A	QO130VH	QO230VH [8]	—	QO330VH [8]
40 A	QO140VH	QO240VH [8]	—	QO340VH [8]
50 A	—	QO250VH [8]	—	QO350VH [8]
60 A	QO160VH	QO260VH [8]	—	QO360VH [8]
70 A	—	QO270VH [8]	—	QO370VH [8]
80 A	—	QO280VH [8]	—	QO380VH [8]
90 A	—	QO290VH [8]	—	QO390VH [8]
100 A	—	QO2100VH [8] [9]	—	QO3100VH [8]
110 A	—	QO2110VH [8] [9]	—	—
125 A	—	QO2125VH [8] [9]	—	—
150 A	—	QO2150VH [7] [8] [6]	—	—
175 A	—	QO2175VH OBS	—	—
200 A	—	QO2200VH [7] [8] [6]	—	—
<b>42 k AIR [4]</b>				
40 A	—	QOH240 OBS	—	—
45 A	—	QOH245 OBS	—	—
50 A	—	QOH250 OBS	—	—
60 A	—	QOH260 [10]	—	—
70 A	—	QOH270	—	—
80 A	—	QOH280	—	—
90 A	—	QOH290	—	—
100 A	—	QOH2100	—	—
110 A	—	QOH2110 [10]	—	—
125 A	—	QOH2125	—	—
<b>65 k AIR [4]</b>				
15 A	QH115 OBS	QH215 OBS	—	QH315 OBS
20 A	QH120 [5]	QH220	—	QH320 OBS
25 A	QH125 OBS	QH225 OBS	—	QH325 [10]
30 A	QH130 OBS	QH230	—	QH330 OBS

OBS This product is obsolete.

Refer to page 7-2 for Interrupting Ratings, Accessories, and Dimensions.

[1] See Digest Section 1 for load centers and Section 9 for panelboards and interiors.  
 [2] 10–30 A circuit breakers are suitable for use with 60°C or 75°C conductors. 35–125 A circuit breakers are suitable for use with 75°C conductors.  
 [3] UL Listed 5 k AIR on corner grounded Delta systems.  
 [4] UL Listed as HACR type for use with air conditioning, heating and refrigeration equipment having motor group combinations and marked for use with HACR type circuit breakers.  
 [5] UL Listed as SWD (switching duty) rated. Suitable for switching 120 Vac fluorescent lighting loads.  
 [6] Not suitable for use in 3Ø panels. Use only in 1Ø panel rated 150 A or greater.  
 [7] Requires four spaces (1 AWG–300 kcmil Al/Cu.) Suitable for switching 120 Vac fluorescent lighting loads.  
 [8] UL Listed for use ahead of QO, QO-GFI, QO-EPD, QOT, QO-AFI, and QO-PL 10 k AIR circuit breakers to permit their application at 22 kA fault level.  
 [9] 100 A maximum branch mounted opposite.  
 [10] Order only. Contact your local Field Office.

Table 7.2: QO/QOB 48 Vdc 5 kA

Ampere Rating	Poles	Suffix
10–60 A	2	5272

QO/QOB Ring Terminal

Table 7.3: QO/QOB Ring Terminal—Factory-Installed Only

Ampere Rating	Poles	Suffix
10–30 A	1, 2, 3	5237
35–60 A	1, 2	5238
35–50 A	3	
70–110 A	2	
60–100 A	3	5273

Wire Sizes for QO/QOB Circuit Breakers

Table 7.4: Wire Sizes for QO/QOB Circuit Breakers

Circuit Breaker Type	Ampere Rating [11]	Wire Size (AWG/kcmil)
QO 1P	10–30 A	14–8 Al/Cu
	10–30 A	(2) 14–10 Cu
	35–70 A	8–2 Al/Cu
QO 2P	10–30 A	14–8 Al/Cu
	10–30 A	(2) 14–10 Cu
	35–70 A	8–2 Al/Cu
	80–125 A	4–2/0 Al/Cu
QO 3P	10–30 A	14–8 Al/Cu, (2) 14–10 Cu
	35–70 A	8–2 Al/Cu
	80–125 A	4–2/0 Al/Cu
QOB-VH	110–150 A	4–300 Al/Cu
QOT	15–20 A	12–8 Al 14–8 Cu
QO-AFI, QO-GFI or QO-EPD	15–30 A	12–8 Al 14–8 Cu
	40, 50, 60 A	12–4 Al 14–6 Cu
QO-PL	10–60 A	12–2 Al 14–2 Cu

QOT and QO Tandem Circuit Breakers

QOT tandem circuit breakers have a mounting cam as shown. Installation into a QO load center can only be made in those positions having a mounting pan rail slot. Meets Paragraph 408.54 of the NEC®. UL Listed as Class CTL.



QOT 1P Tandem  
1 Space Required

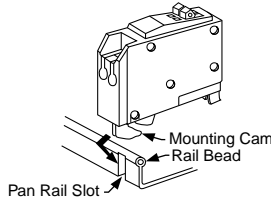

Table 7.5: QOT Tandem Circuit Breakers (CTL)—Not Compatible with Plug-on Neutral Systems

Ampere Rating [11]	Cat. No. [12]
<b>1P—120/240 Vac</b>	
15 A and 15 A	QOT1515
15 A and 20 A	QOT1520
20 A and 20 A	QOT2020
<b>2P—120/240 Vac Common Trip</b>	
Order two QOT1515 or QOT2020 circuit breakers and handle tie QOTHT for common switching of center two poles.	

Table 7.6: QO Tandem Circuit Breakers (non-CTL)—Compatible with Plug-on Neutral Systems

Ampere Rating [11]	Cat. No. [12]
<b>1P—120/240 Vac—1 Space Required</b>	
15 A and 15 A	QO1515
15 A and 20 A	QO1520
20 A and 20 A	QO2020
20 A and 30 A	QO2030
30 A and 20 A	QO3020
<b>Two 1P Individual Trip—120/240 Vac—2 Spaces Required</b>	
15 A and 15 A	Order two QO1515 or QO2020 circuit breakers and handle tie QOTHT
15 A and 20 A	
20 A and 20 A	
20 A and 30 A	QO20303020 [13]
30 A and 20 A	—

NOTE: The torque values for these products can be found at [www.se.com](http://www.se.com)

[11] 10–30 A circuit breakers are suitable for use with 60°C or 75°C conductors. 35–125 A circuit breakers are suitable for use with 75°C conductors.

[12] UL Listed as HACR type for use with air conditioning, heating and refrigeration equipment having motor group combinations and marked for use with HACR type circuit breakers.

[13] Includes two circuit breakers (one QO2030 and one QO3020) and handle tie QOTHT.

**QO Arc-Fault Circuit Breaker (QO-CAFI)**

QO arc-fault circuit breakers provide protection for Series and Parallel Type Arcing as required by the NEC and local code adoption, and comply with UL 1699.



1P  
QO-CAFI  
Plug-On Neutral



1P  
QO-CAFI  
Pigtail

**Table 7.7: QO-CAFI Circuit Breakers**

Circuit Breaker Type [14]	Ampere Rating	One-Pole 120 Vac		Two-Pole 120/240 Vac
		10 k AIR 1 Space Required	22 k AIR 1 Space Required	10 k AIR 2 Space Required
Combination Arc-fault Interrupter (Pigtail Neutral)	15 20	QO115CAFI QO120CAFI	QO115VHCAFI QO120VHCAFI	QO215CAFI [15] QO220CAFI [15]
Plug-On Neutral Combination Arc-fault Interrupter	15 20	QO115PAF QO120PAF	QO115VHPAF QO120VHPAF	—

**QO Dual Function Circuit Breaker**

QO Combination Arc Fault and Ground Fault Circuit Interrupters (Dual Function) provide overload and short circuit protection, plus arc fault and ground fault protection in accordance with the NEC, UL 1699 and UL943.



1P QO-DF  
Plug-on Neutral



1P QO-DF  
Pigtail

**Table 7.8: QO-DF Circuit Breakers**

Circuit Breaker Type [14]	Ampere Rating	1P 120 Vac 10 k AIR 1 Space Required	1P 120 Vac 22 k AIR 1 Space Required
Combination Arc-fault and Ground Fault Circuit Interrupter (Pigtail Neutral)	15 20	QO115DF QO120DF	— QO120VHDF
Plug-On Neutral Combination Arc-fault and Ground Fault Circuit Interrupter	15 20	QO115PAFGF QO120PAFGF	QO115VHPAFGF QO120VHPAFGF

**QO Ground-Fault Circuit Breakers (GFI)**

Qwik-Gard™ circuit breakers provide overload and short circuit protection, combined with Class A ground fault protection. Class A denotes a ground fault circuit interrupter that will trip when a fault current to ground is 6 mA or more, for people protection. Do not connect to more than 250 feet of load conductor for the total one-way run to prevent nuisance tripping.



1P  
QO-GFI



2P  
QO-GFI

**Table 7.9: QO-GFI Circuit Breakers**

Circuit Breaker Type	Ampere Rating [16]	Qwik-Gard Circuit Breakers With Ground Fault Circuit Interrupter			
		1P 120 Vac		2P Common Trip 120/240 Vac	3P Common Trip 208Y/120 Vac
		10 k AIR 1 Space Required	22 k AIR 1 Space Required	10 k AIR 2 Spaces Required	10 k AIR 3 Spaces Required
Ground-Fault Circuit Interrupter (Pigtail Neutral)	15	QO115GFI	QO115VHGFI	QO215GFI	QO315GFI
	20	QO120GFI	QO120VHGFI	QO220GFI	QO320GFI
	25	—	—	QO225GFI	—
	30	QO130GFI	—	QO230GFI	QO330GFI
	35	—	—	QO235GFI	—
	40	—	—	QO240GFI	QO340GFI
	45	—	—	QO245GFI	—
	50	—	—	QO250GFI	QO350GFI
Plug-On Neutral Ground-Fault Circuit Interrupter	15	QO115PGFI [18]	—	—	—
	20	QO120PGFI [18]	—	—	—

[14] UL Listed as HACR type for use with air conditioning, heating and refrigeration equipment having motor group combinations and marked for use with HACR type circuit breakers.

[15] For 120/240 V only, not for 208Y/120 V.

[16] 10–30 A circuit breakers are suitable for use with 60°C or 75°C conductors. 35–125 A circuit breakers are suitable for use with 75°C conductors.

[17] Suitable only for feeding 240 Vac and 208 Vac two-wire loads. Does not contain load neutral connection.

[18] New Plug-On Neutral

### QO-EPD/EPE Circuit Breakers

QO-EPD/EPE circuit breakers provide overload and short circuit protection combined with Class B ground fault protection. They are designed to provide ground fault protection of equipment at a 30 mA level (EPD) or 100 mA level (EPE). They are not designed to protect people from electrical shock.



QO220EPD

Table 7.10: QO-EPD Circuit Breakers

Ampere Rating [19]	1P 120 Vac 10 k AIR 1 Space Required	2P Common Trip 120/240 Vac 10 k AIR 2 Spaces Required	
15	QO115EPD	QO215EPD	QO315EPE [20]
20	QO120EPD	QO220EPD	QO320EPE [20]
25	QO125EPD <sup>Obs</sup>	QO225EPD	—
30	QO130EPD	QO230EPD	QO330EPE [20]
40	—	QO240EPD	QO340EPE [20]
50	—	QO250EPD	QO350EPE [20]
60	—	QO260EPD [21]	—

<sup>Obs</sup> This product is obsolete.

### QO Switch Neutral Common Trip Circuit Breakers (QO-SWN)

Switch Neutral Common Trip 2008 NEC® 514.11

Table 7.11: QO-SWN Circuit Breakers

Ampere Rating [22]	2 Wire 120 Vac 10 k AIR 2 Spaces Required
15	QO215SWN
20	QO220SWN

### QO High Intensity Discharge Circuit Breakers (QO-HID)

HID circuit breakers are for use on circuits feeding fluorescent and high intensity discharge (HID) lighting systems such as mercury vapor, metal halide, or high pressure sodium. These circuit breakers are physically interchangeable with QO circuit breakers.



QO320HID

Table 7.12: QO-HID Circuit Breakers

Ampere Rating [22]	1P 120/240 Vac 10 k AIR	2P Common Trip 120/240 Vac 10 k AIR	3P Common Trip 240 Vac 10 k AIR
20	—	QO220HID	QO320HID

[19] 10–30 A circuit breakers are suitable for use with 60°C or 75°C conductors. 35–125 A circuit breakers are suitable for use with 75°C conductors.  
 [20] See note in Instruction Bulletin when using in an enclosure with a QO403 or QON prefix.  
 [21] Suitable only for feeding 240 Vac and 208 Vac two-wire loads. Does not contain load neutral connection.  
 [22] 10–30 A circuit breakers are suitable for use with 60°C or 75°C conductors. 35–60 A circuit breakers are suitable for use with 75°C conductors.

### QO High Magnetic Trip Circuit Breakers (QO-HM)

High magnetic trip circuit breakers are recommended for applications where high initial inrush may occur and for individual dimmer applications.

**Table 7.13: QO-HM Circuit Breakers**

120 Vac—10 k AIR	
Ampere Rating [23]	1P
15 A	QO115HM [24] [25]
20 A	QO120HM [24] [25]

### Non-Automatic (Standard) Miniature Switches

Miniature non-automatic switches have the same physical packaging as miniature circuit breakers, but open only when the handle is switched to the OFF position.

Non-automatic switches provide no overcurrent protection or short circuit protection. They must not be used on systems that have an available fault current greater than the values listed in the table. Non-automatic switches are UL Listed per UL 1087 and are CSA certified.

**Table 7.14: QO Non-Automatic Miniature Switches, 240 Vac 10 kA**

Ampere Rating	2P	3P
60	QO200	QO300 OBS

<sup>OBS</sup> This product is obsolete.

[23] 10–30 A circuit breakers are suitable for use with 60oC or 75oC conductors. 35–60 A circuit breakers are suitable for use with 75oC conductors.

[24] UL Listed as HACR type for use with air conditioning, heating and refrigeration equipment having motor group combinations and marked for use with HACR type circuit breakers.

[25] UL Listed as SWD (switching duty) rated. Suitable for switching 120 Vac fluorescent lighting loads.

Accessories for QO/QOB Circuit Breakers

Table 7.15: Accessories for use with QO and QOB Miniature Circuit Breakers

Description		Cat. No.	Schedule
<b>Handle Attachments</b>			
Handle Tie	Converts any two adjacent 120/240 Vac 1P QO circuit breakers to independent trip 2P Converts any two adjacent 120/240 Vac1P side-by-side QOT circuit breakers to independent trip 2P	QO1HT QOTHT QO3HT	DE2E DE2E
Handle Clamp	Clamp for holding QO 1P handle in ON or OFF position Clamp for holding QO or Q1 either 1P, 2P or 3P circuit breaker handles in ON or OFF position	QO1LO HLO1	DE2E DE2E
Handle Padlock Attachment for Padlocking in ON or OFF position	For padlocking 1P QO circuit breaker in ON or OFF position Loose attachment Fixed attachment	QOHPL QO1PA	DE2E DE2E
	For padlocking 1P side-by-side QOT circuit breaker in ON or OFF position	QOTHPA <sup>obs</sup>	DE2E
	For padlocking 2P QO-GFI circuit breakers in either ON or OFF position, fixed attachment.	GFI2PA	DE2A
	For 2P and 3P QO and Q1 standard circuit breakers which require padlocking in either ON or OFF position. Loose attachment Fixed attachment	QO1HPL QO1PL	DE2E DE2E
Handle Padlock Attachment for Padlocking in OFF position	For padlocking 2P and 3P QO circuit breakers in OFF position only, fixed attachment.	QO2PAF	DE2E
	For padlocking 1P QO, QO-GFI, QO-CAFI, QO-DF and QO-EPD circuit breakers in OFF position only, fixed attachment.	QOADV1PAF	DE2E
	For padlocking 2P QO-GFI, QO-CAFI and QO-EPD circuit breakers in OFF position only, fixed attachment.	QOGFI2PAF	DE2E
Ring Terminal	Ring terminals are available as a factory-installed option.	See Section 7	DE2A
Sub-feed Lugs	60 A 2P plug-on – 2 spaces required (6–2 Al/Cu) 125 A 2P plug-on – 2 spaces required (12–2/0 Al/Cu) 225 A 2P plug-on – 4 spaces required (4–300 Al/Cu) 125 A 3P plug-on – 3 spaces required (12–2/0 Al/Cu)	QO60SL <sup>obs</sup> QO2125SL QO2225SL [26] QO3125SL	DE2A DE2A DE2A DE3
Mechanical Interlock Attachment	For interlocking the handles of two 2P or one 2P and one 1P QO and Q1 circuit breakers mounted side-by-side so that only one circuit breaker can be ON at a time (Not QOU)	QO2DTI	DE2E
With Retaining Kit	QO2DTI mechanical interlock attachment with retaining kits for securing two adjacent back-fed circuit breakers in dual power supply applications. Can be used with (2) 2Ps or (1) 2P and (1) 1P QO circuit breakers in QO816L100 load centers.	QO2DTIM	DE2E

<sup>obs</sup> This product is obsolete.



QO1PA



QO1PL



QO1HT



HLO1



QO1PAF



QO2DTI



QO1HPL



QOTHPA



QO1LO



QOHPL



QO2PAF



QOADV1PAF

Factory-Installed Accessories for QO and QOB Miniature Circuit Breakers

Factory-installed electrical accessories take up an additional pole space on QO, QO-GFI, QO-EPD, QO-SWN and QOU circuit breakers. All AC electrical accessories shown below are rated for 50/60 Hz. Accessories are not available for QOB-VH (2P 150 A and 3P 110–150 A) circuit breakers or QO, QOU molded case switches. QO circuit breakers will accept only one accessory per circuit breaker. Undervoltage trip is not available on miniature circuit breakers. Factory-installed accessories are not available for QO-AFI or

[26] Not suitable for use in 3Ø panels. Use only in 1Ø panel rated 150 A or greater.



QO-CAFI Arc Fault Circuit Breakers, QO-CAFI, QO-DF, or QO-PDF circuit breakers, or on QO2150, QO2175, or QO2200 circuit breakers.

**Table 7.16: Factory-Installed Accessories for QO/QOB Circuit Breakers<sup>[27]</sup>**

Accessory	Description	Rated Voltage	Coil Burden	Cat. No. Suffix	Accessory	Description	Contact Comb.	Max. Voltage	Max.	Cat. No. Suffix
Shunt Trip	Trips the circuit breaker from a remote location by means of a trip coil energized from a separate circuit. A 120 Vac shunt trip will operate at 55% or more of rated voltage. All other shunt trips will operate at 75% or more of rated voltage. <b>Application</b> <ul style="list-style-type: none"> <li>For use with momentary or maintained push button.</li> <li>Not available on QO-GFI, QO-EPD, QO-AFI, QO-CAFI, QO-DF, or QO-PDF.</li> <li>Shunt trip terminals accept (2) 0.14–0.12 AWG Cu.</li> </ul>	12 Vac/Vdc 24 Vac/Vdc	60 VA 168 VA	-1042	Auxiliary Switches	Monitors circuit breaker contact status and provides a remote signal indicating the circuit breaker contacts are OPEN or CLOSED. <b>Application</b> <ul style="list-style-type: none"> <li>Auxiliary switch terminals accept (2) 14–12 AWG Cu leads.</li> <li>Leads (EH): Yellow for "A", Blue for "B", Striped common 18 AWG Cu.</li> </ul>	1A 1B	120 Vac 120 Vac	5 A 5 A	-1200 -1201
		120 Vac 208 Vac 240 Vac	72 VA 228 VA 288 VA	-1021	Alarm Switches	Used with control circuits and is actuated only when the circuit breaker has tripped. Standard construction includes a normally-open contact. <b>Application</b> <ul style="list-style-type: none"> <li>Leads: Alarm switch terminals accept (2) 14–12 AWG Cu leads.</li> </ul>	1A	120 Vac	5 A	-2100

**QO Mounting Bases**

**Table 7.17: QO OEM Mounting Bases—UL Recognized Components**

Voltage System	Main Lug Rating	Spaces	Max. No. 1P Circuits	Mounting Bases Cat. No.	Main Wire Size AWG/kcmil
<b>QO Plug-On Mounting Bases—Accepts Only QO Plug-On Circuit Breakers - Not Compatible With QO Plug-On Neutral Circuit Breakers</b>					
1Ø2W 240 Vac Max. 10 k AIC (Without Neutral Assembly)	70 A	2	2	QON2L70	14–4 Cu, 12–3 Al
	125 A	4	4	SK9948BW	12–1/0 Cu/Al
	125 A	6	6	SK9795	12–1/0 Cu/Al
<b>QO Plug-On Mounting Bases—Accepts Only QO Plug-On Circuit Breakers - Not Compatible With QO Plug-On Neutral Circuit Breakers</b>					
1Ø3W 240 Vac Max. 10 k AIC	40 A	2	2	QON2L40	14–6 Cu, 12–6 Al
	70 A	2	4	QON24L70	14–4 Cu, 12–3 Al
	100 A	6	12	QON612L100	8–1/0 Cu/Al
	100 A	8	16	QON816L100	8–1/0 Cu/Al
<b>QO Plug-On Neutral Mounting Bases - Compatible with QO Plug-On Circuit Breakers and QO Plug-On Neutral Circuit Breakers</b>					
1Ø3W 240 Vac Max. 10 k AIC	125 A	12	24	QON112L125PI	4–2/0 Cu/Al
	125 A	20	24	QON120L125PI	4–2/0 Cu/Al
	200 A	12	24	QON112L200PI	4–250 Cu/Al
	200 A	24	36	QON124L200PI	4–250 Cu/Al
	200 A	24	36	QON124L200PDL	(2) 4–300 Cu/Al
	200 A	30	40	QON130L200PI	4–250 Cu/Al
	225 A	42	52	QON142L225PI	4–300 Cu/Al
	225 A	52	72	QON154L225P	4–300 Cu/Al
<b>QO Plug-On Mounting Bases—Accepts Only QO Plug-On Circuit Breakers - Not Compatible With QO Plug-On Neutral Circuit Breakers</b>					
3Ø3W 240 Vac Max. 10 k AIC (Without Neutral Assy.)	125 A	12	12	QON312L125	4–2/0 Cu/Al
	125 A	20	20	QON320L125	4–2/0 Cu/Al
	125 A	24	24	QON324L125	4–2/0 Cu/Al
	200 A	18	18	QON318L200	4–300 Cu/Al
	200 A	24	24	QON324L200	4–300 Cu/Al
	200 A	30	30	QON330L200	4–300 Cu/Al
	225 A	42	42	QON342L225	4–300 Cu/Al
<b>QO Plug-On Mounting Bases—Accepts Only QO Plug-On Circuit Breakers - Not Compatible With QO Plug-On Neutral Circuit Breakers</b>					
3Ø4W 240 Vac Max. 10 k AIC	60 A	3	3	QON403L60N	12–6 Cu/Al
	125 A	12	12	QON312L125I	4–2/0 Cu/Al
	125 A	20	20	QON320L125I <sup>[28]</sup>	4–2/0 Cu/Al
	125 A	24	24	QON324L125I	4–2/0 Cu/Al
	200 A	30	30	QON330L200I <sup>[28]</sup>	4–300 Cu/Al
<b>QO Plug-On Mounting Bases—Accepts Only QO Plug-On Circuit Breakers - Not Compatible With QO Plug-On Neutral Circuit Breakers</b>					
1Ø2W 240 Vac Max. 10 k AIC (Without Neutral Assembly)	70 A	1	1	QOMB1	14–4 Cu 12–2 Al
	70 A	2	2	QOMB2	14–4 Cu 12–2 Al
	70 A	3	3	QOMB3	14–4 Cu 12–2 Al
<b>QOB Bolt-On Mounting Bases—Accepts only QOB Bolt-On Circuit Breakers</b>					
3Ø3W 240 Vac Max. 10 k AIC (Without Neutral Assembly)	100 A	3	3	QON3B	12–1 Cu/Al

**Table 7.18: Solid Neutral Assemblies**

Main Lug Rating	Number of Branch Neutral Terminals	Cat. No.	Main Neutral Lug Wire Size Cu/Al	Branch Neutral Terminal Wire Size	
				Cu	Al
125 A	12	SN12125	4–2/0 AWG	14–4 AWG	12–4 AWG
125 A	20	SN20	4–2/0 AWG	14–4 AWG	12–4 AWG
200 A	12	SN12200	4 AWG–300 kcmil	14–4 AWG	12–4 AWG
200 A	30	SN30	4 AWG–300 kcmil	14–4 AWG	12–4 AWG
225 A	42	SN42	4 AWG–300 kcmil	14–4 AWG	12–4 AWG

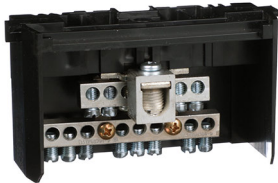

SN12125

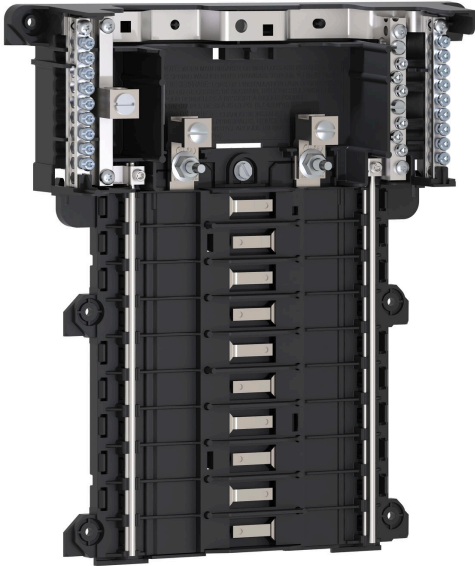

QON120L125P1



QON3B

<sup>[27]</sup> QOB circuit breakers with shunt trip, auxiliary switches, and/or alarm switches, which are no longer active commercial references, may be available Factory Assembled into NQ Panelboards.

<sup>[28]</sup> Also IEC rated and CE marked for IEC 60439-1. Use only Square D brand Type QOXC, QOXD, QOHX and QOE circuit breakers for 415Y/240 Vac max. systems.

**Low Ampere QOU Miniature Circuit Breakers**

QOU unit mount miniature circuit breakers (cable-in/cable-out) are ideal for OEM applications. They have the Square D™ circuit breaker’s unique Visi-Trip™ feature and can be DIN rail-mounted or surface- or flush-mounted using mounting feet. Mounting feet not provided [29].

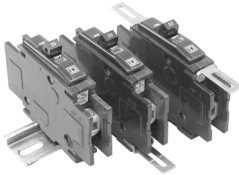

Low Ampere QOU

**General Specifications Common to All Low Ampere QOU Circuit Breakers**

- For convenient flush mount, surface mount or DIN mount (symmetrical rail 35 x 7.5 DIN/EN 50 022)
- Single handle with internal common trip
- Terminal lug wire size (1) 14–2 AWG Cu or Al
- Reversible line and load lugs
- Field-installable quick connectors
- UL Listed 48 Vdc (5 k AIR)
- UL Listed as HACR Type: 10–70 A
- High magnetic trip circuit breakers (QOU-HM) are recommended for applications where high initial inrush may occur and for individual dimmer applications.
- For DIN mounting rails, see IEC Starters and Relays, Section 18.

**Table 7.19: QOU Low Ampere Miniature Circuit Breakers**

Ampere Rating	Cat. No.			
	1P 120/240 Vac	2P 120/240 Vac	2P 240 Vac [30]	3P 240 Vac
<b>10 k AIR</b>				
10 A	QOU110	QOU210	—	QOU310
15 A	QOU115	QOU215	QOU215H	QOU315
20 A	QOU120	QOU220	QOU220H	QOU320
25 A	QOU125	QOU225	QOU225H <sup>Obs</sup>	QOU325
30 A	QOU130	QOU230	QOU230H	QOU330
35 A	QOU135	QOU235	—	QOU335
40 A	QOU140	QOU240	—	QOU340
45 A	QOU145 <sup>Obs</sup>	QOU245	—	QOU345
50 A	QOU150	QOU250	—	QOU350
60 A	QOU160	QOU260	—	QOU360
70 A	QOU170	QOU270	—	QOU370
<b>22 k AIR</b>				
15 A	QOU115VH	QOU215VH	—	QOU315VH <sup>Obs</sup>
20 A	QOU120VH	QOU220VH	—	QOU320VH
30 A	QOU130VH	QOU230VH	—	QOU330VH
50 A	QOU150VH <sup>Obs</sup>	QOU250VH	—	—
60 A	QOU160VH	QOU260VH	—	—

<sup>Obs</sup> This product is obsolete.

**Table 7.20: QOU-HM Miniature Circuit Breakers (10 k AIR)**

Ampere Rating	Cat. No.			
	1P 120/240 Vac	2P 120/240 Vac	2P 240 Vac	3P 240 Vac
15 A	QOU115HM	—	—	—
20 A	QOU120HM	—	—	—

[29] See QOU Accessories, page 7-20.  
[30] QOU-H interrupting rating is 10 kA at 240 Vac.



High Ampere QOU

**High Ampere QOU Circuit Breakers**

**General Specifications Common to All High Ampere QOU Circuit Breakers**

- Flush mount, surface mount, and DIN rail mount.
- Internal common trip.
- Non-reversible line and load lugs.
- Terminal lug wire size (1) 12– 2/0 AWG Cu or Al.
- UL Listed 60 Vdc per pole (5 k AIR). (**Note:** except switches)
- UL Listed as HACR type, 80–125 A.
- Non-automatic switches have the same physical packaging as miniature circuit breakers, but provide no overcurrent or short circuit protection. They are UL Listed per UL1087 and are CSA certified.

**Table 7.21: QOU High Ampere Miniature Circuit Breakers (10 k AIR)**

Ampere Rating	Cat. No.			
	1P 120/240 Vac	2P 120/240 Vac	2P 240 Vac	3P 240 Vac
80 A	QOU180	QOU280	—	QOU380
90 A	QOU190 <sup>OBS</sup>	QOU290	—	QOU390
100 A	QOU1100	QOU2100	—	QOU3100
125 A	—	QOU2125	—	—

<sup>OBS</sup> This product is obsolete.

**Table 7.22: QOU Non-Automatic Switches**

Ampere Rating	Cat. No.	
	2P 240 Vac	3P 240 Vac
60 A	QOU200	QOU300
100 A	QOU2000 <sup>OBS</sup>	QOU3000 <sup>OBS</sup>
125 A	QOU20001	QOU30001 <sup>OBS</sup>

<sup>OBS</sup> This product is obsolete.

Interrupting ratings see [page 7-3](#)

Accessories see [page 7-20](#)

Dimensions see [page 7-85](#)

QOU Accessories

Table 7.23: Accessories for QOU Low Ampere Circuit Breakers (Except as Noted)

Description	Order Qty.	Cat. No.
Factory-installed ring tongue terminal, 10–32 screw, for 1P, 2P, 3P QOU, 10–60 A	—	Suffix -5283
Hex drive 5/32 in. wire binding screw for QOU	—	Suffix -5280
For padlocking 1P low ampere QOU circuit breaker in OFF or ON position	—	QOU1PA OBS
For padlocking 2P and 3P low ampere QOU circuit breaker in OFF or ON position	—	QOU1PL
For padlocking 1P low ampere QOU circuit breaker in OFF position only	—	QOU1PAFLA
For padlocking 2P and 3P low ampere QOU circuit breaker in OFF position only	—	QOU2PAFLA
For padlocking 2P and 3P high ampere QOU circuit breaker in OFF position only	—	Suffix -7100
Handle lock-out, ON or OFF position	—	HLO1
4P 100 A Jumper bar assy. w/front wiring with base, cover and screw	1	QOU14100JBAF
4P 100 A Jumper bar assy. w/right side wiring with base, cover and screw	1	QOU14100JBAR OBS
4P 100 A Jumper bar assy. w/left side wiring with base, cover and screw	1	QOU14100JBAL
1Ø, 4P, 100 A Jumper bar base with front wiring	40	QOU14100BAFB
1Ø, 4P, 100 A Jumper bar base with left side wiring	40	QOU14100BALB
1Ø, 4P, 100 A Jumper bar base with right side wiring	40	QOU14100BARB
4P Jumper bar cover	40	QOU14100CAB
Mounting screw for jumper bar cover	40	QOU1CMSB OBS
6P 150 A Jumper bar assy. w/front wiring with base, cover and screw	1	QOU16150JBAF
1Ø, 6P, 150 A Jumper bar base with front wiring	40	QOU16150BAFB
1Ø, 6P, 150 A Jumper bar base with left side wiring	40	QOU16150BALB OBS
1Ø, 6P, 150 A Jumper bar base with right side wiring	40	QOU16150BARB OBS
6P jumper bar cover	40	QOU16150CAB OBS
Vertical rainproof cover 2P and 3P QO, QOU, FA and KA	1 10	BCV [31] BCVB OBS
Horizontal rainproof cover 2P QO, QOU, and 3P Q2, EH	1 10	BCH [31] BCHB [31]
1P Fingersafe™ cover for high ampere QOU circuit breaker	1 40	QOUHFSC1 QOUHFSC1B OBS
1P Fingersafe cover for low ampere QOU circuit breaker	1 40	QOUFSC1 QOUFSC1B
Cover plate for one 2P QOU circuit breaker	1 40	QOUCP2 OBS QOUCP2B
Cover plate for one 3P QOU circuit breaker	1 40	QOUCP3 OBS QOUCP3B
Cover plate for two 2P QOU circuit breakers	1 40	QOUCP4 OBS QOUCP4B
Cover plate for three 2P QOU circuit breakers	1 40	QOUCP6 OBS QOUCP6B
Field-installable ring tongue terminal adaptor	1 80	QOURT QOURTB
Quick connector end connection wiring	1 40	QOUQC QOUQCB
Quick connector forward or reverse wiring	1 40	QOUFR OBS QOUFRB
1P QOU mounting foot	1 80	QOUMF1 [31] QOUMF1B [31]
2P QOU mounting foot	1 40	QOUMF2 [31] QOUMF2B [31]
3P QOU mounting foot	1 24	QOUMF3 OBS QOUMF3B [31]
Tapped mounting foot for QOU, 1P and 2P 10–70 A, 3P 10–60 A		
Packaged with circuit breaker		Suffix -3100
Individually packaged	1	QOUMFS1
Bulk packed	80	QOUMFS1B OBS
Mechanical interlock attachment: Used to interlock two circuit breakers mounted side-by-side so that only one circuit breaker can be ON at a time. A 1P or 2P circuit breaker can be mounted on the left and interlocked with a 2P or 3P circuit breaker on the right.	1	QOU2DTILA [32]

OBS This product is obsolete.

QOUQ Low Ampere Circuit Breakers

QOUQ low ampere circuit breakers with four-point quick-connect terminals are provided with permanent factory-installed terminals which are affixed to the Load or OFF end of the circuit breaker. This special terminal will accommodate up to four 1/4-inch insulated female quick connect wire terminations. Total ampacity of these connections must not exceed the rating of the circuit breaker.

Table 7.24: QOUQ Four-Point Quick-Connect Terminals

	Poles	Order Qty.	Cat. No.
Four-Point Quick-Connect Terminals	1	1	Change QOU to QOUQ
	2	1	
	3	1	

The QOU uses the same electrical accessories as the QO. See the QO information for available electrical accessories.



QOU14100JBAF

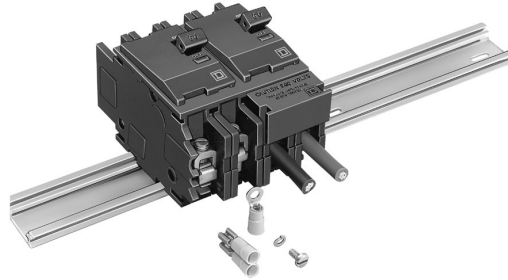

2P DIN-Mounted QOU Circuit Breaker

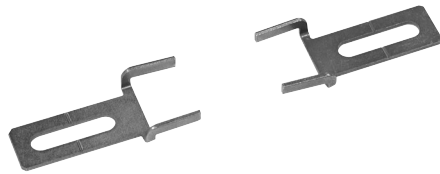

Mounting Foot QOUMF1

[31] For use on low and high ampere QOU.  
[32] 10–70 A 1P and 2P, 10–60 A 3P.



HOM 1P and 2P



HOM2200BB Branch Circuit Breaker  
4 Spaces Required

### Homeline Standard Plug-On Circuit Breakers

The Square D Homeline circuit breakers are in a 1 in. wide format for 1-pole circuit breakers. They are designed to plug into Homeline load centers.

**Table 7.25: Standard HOM Plug-on Circuit Breakers**

Ampere Rating	AIR	1P—120 Vac, 1 Space Required	2P—120/240 Vac Common Trip 2 Spaces Required.
15 A	10 kA	HOM115 [1][2]	HOM215 [2]
20 A	10 kA	HOM120 [1][2]	HOM220 [2]
25 A	10 kA	HOM125 [2]	HOM225 [2]
30 A	10 kA	HOM130 [2]	HOM230 [2]
35 A	10 kA	—	HOM235 [2]
40 A	10 kA	HOM140 [2]	HOM240 [2]
45 A	10 kA	—	HOM245 [2]
50 A	10 kA	HOM150 [2]	HOM250 [2]
60 A	10 kA	—	HOM260 [2]
70 A	10 kA	—	HOM270 [2]
80 A	10 kA	—	HOM280 [2]
90 A	10 kA	—	HOM290 [2]
100 A	10 kA	—	HOM2100 [2]
110 A	10 kA	—	HOM2110 [2]
125 A	10 kA	—	HOM2125 [2]
150 A	10 kA	—	HOM2150BB [2][3]
175 A	10 kA	—	HOM2175BB [2][3]
200 A	10 kA	—	HOM2200BB [2][3]

### Homeline High Magnetic Circuit Breakers (HOM-HM)

High magnetic trip circuit breakers are recommended for applications where high initial inrush current may occur.

**Table 7.26: HOM-HM Circuit Breakers**

Amperes	1P—120/240 Vac	2Ps
20 A	HOM120HM [4]	—

### Homeline Combination Arc Fault Circuit Interrupters (HOM-CAFI)

Homeline Combination Arc Fault Circuit Interrupters—Provide overload and short circuit protection, plus arc fault protection in accordance with the NEC and UL1699.

**Table 7.27: HOM-CAFI Circuit Breakers**

Circuit Breaker Type	Ampere Rating	Poles 120 Vac	Cat. No.
<b>One-Pole</b>			
Combination Arc-Fault Circuit Interrupter with Pigtail Neutral	15 A	1	HOM115CAFI [4]
	20 A	1	HOM120CAFI [4]
Plug-On Neutral Combination Arc-Fault Interrupter	15 A	1	HOM115PCAIFI [4]
	20 A	1	HOM120PCAIFI [4]
<b>Two-Pole</b>			
Combination Arc-Fault Circuit Interrupter with Pigtail Neutral	15 A	2	HOM215CAFI [4] [5]
	20 A	2	HOM220CAFI [4] [5]



HOM 1P CAFE  
Plug-on Neutral



HOM 1P CAFE  
Pigtail

### Homeline Dual Function Circuit Breaker (HOM-DF)

Homeline Combination Arc Fault and Ground Fault Circuit Interrupters (Dual Function)—Provide overload and short circuit protection, plus arc fault and ground fault protection in a single device in accordance with the NEC, UL1699 and UL943.

**Table 7.28: HOM-DF Circuit Breakers**

Circuit Breaker Type	Ampere Rating	Poles 120 Vac	Cat. No.
Combination Arc-Fault and Ground Fault Circuit Interrupter with Pigtail Neutral	15 A	1	HOM115DF [4]
	20 A	1	HOM120DF [4]
Plug-On Neutral Combination Arc-Fault and Ground Fault Circuit Interrupter	15 A	1	HOM115PDF [4]
	20 A	1	HOM120PDF [4]



HOM 1P DF  
Plug-on Neutral



HOM 1P DF  
Pigtail

[1] UL Listed as SWD (switching duty) rated. Suitable for switching 120 Vac fluorescent lighting loads.

[2] UL Listed as HACR type for use with air conditioning, heating and refrigeration equipment having motor group combinations and marked for use with HACR type circuit breakers.

[3] Requires four spaces (1 AWG—300 kcmil Al/Cu). Use only in 1Ø panel rated 150 A or greater.

[4] UL Listed as HACR type for use with air conditioning, heating and refrigeration equipment having motor group combinations and marked for use with HACR type circuit breakers.

[5] For 120/240 V only, not for 208Y/120 V.



### Homeline Ground-Fault Circuit Breaker (HOM-GFI)

HOM-GFI circuit breakers provide overload and short circuit protection, combined with Class A ground fault protection. Class A denotes a ground fault circuit interrupter that will trip when a fault current to ground is 6 milliamperes or more.

Table 7.29: HOM-GFI Circuit Breakers

Circuit Breaker Type	Ampere Rating	AIR	1P—120 Vac 1 Space Required	2P—120/240 Vac Common Trip 2 Spaces Required
Ground-Fault Circuit Interrupter (Pigtail Neutral)	15 A	10 kA	HOM115GFI	HOM215GFI
	20 A	10 kA	HOM120GFI	HOM220GFI
	25 A	10 kA	—	HOM225GFI
	30 A	10 kA	—	HOM230GFI
	35 A	10 kA	—	HOM235GFI
	40 A	10 kA	—	HOM240GFI
	45 A	10 kA	—	HOM245GFI
Plug-On Neutral Ground-Fault Circuit Interrupter	50 A	10 kA	—	HOM250GFI
	15 A	10 kA	HOM115PGFI	—
	20 A	10 kA	HOM120PGFI	—

### Homeline Equipment Protection Device (HOM-EPD)

Homeline Equipment Protection Device—Circuit Breakers with 30 mA Equipment Ground Fault Protection (UL Listed).

Table 7.30: HOM-EPD Circuit Breakers

Amperes	1P—120 Vac	2P—120/240 Vac Common Trip
20 A	HOM120EPD	HOM220EPD
30 A	—	HOM230EPD
40 A	—	HOM240EPD
50 A	—	HOM250EPD

### Homeline Tandem and Quad Tandem Circuit Breakers (HOMT)

Table 7.31: HOMT Tandem Circuit Breakers



HOMT Tandem  
Circuit Breaker

Ampere Rating [6]	AIR	1P Tandem—120/240 Vac (One Space Required)
15 and 15 A	10 kA	HOMT1515 [7]
15 and 20 A	10 kA	HOMT1520 [7]
20 and 20 A	10 kA	HOMT2020 [7]
30 and 15 A	10 kA	HOMT3015 [7]
30 and 20 A	10 kA	HOMT3020 [7]

Table 7.32: HOMT Quad Tandem 1P Circuit Breakers



HOMT1515215  
2 Spaces Required

Ampere Rating [6]		AIR	2P Tandem—120/240 Vac (Two Spaces Required)
1P	2P		
(2) 15 A	15 A	10 kA	HOMT1515215
(2) 15 A	20 A	10 kA	HOMT1515220
(2) 15 A	30 A	10 kA	HOMT1515230
(2) 15 A	40 A	10 kA	HOMT1515240
(2) 15 A	50 A	10 kA	HOMT1515250
(2) 20 A	20 A	10 kA	HOMT2020220
(2) 20 A	25 A	10 kA	HOMT2020225
(2) 20 A	30 A	10 kA	HOMT2020230
(2) 20 A	40 A	10 kA	HOMT2020240
(2) 20 A	50 A	10 kA	HOMT2020250

NOTE: Typical catalog no. (e.g. HOMT 1515230) represents two 1P, outer poles (two 15 A 1P CBs) and one 2P inner circuit breaker with common trip (one 30 A 2P CB).

Table 7.33: HOMT Quad Tandem 2P Circuit Breakers



HOMT225225  
2 Spaces Required

Ampere Rating [6]		AIR	(2) 2P Tandem—120/240 Vac (Two Spaces Required)
2P	2P		
15 A	15 A	10 kA	HOMT215215
15 A	20 A	10 kA	HOMT215220
15 A	25 A	10 kA	HOMT215225
15 A	30 A	10 kA	HOMT215230
15 A	40 A	10 kA	HOMT215240
15 A	50 A	10 kA	HOMT215250
20 A	20 A	10 kA	HOMT220220
20 A	25 A	10 kA	HOMT220225
20 A	30 A	10 kA	HOMT220230
20 A	40 A	10 kA	HOMT220240
20 A	50 A	10 kA	HOMT220250
25 A	25 A	10 kA	HOMT225225
25 A	30 A	10 kA	HOMT225230
25 A	40 A	10 kA	HOMT225240

[6] 15–20 A tandem or quad tandem circuit breakers are suitable for use with 60°C or 75°C conductors. 25–50 A tandem or quad tandem circuit breakers are suitable for use with 75°C conductors only.

[7] UL Listed as HACR type for use with air conditioning, heating and refrigeration equipment having motor group combinations and marked for use with HACR type circuit breakers.

**Table 7.33 HOMT Quad Tandem 2P Circuit Breakers (cont'd.)**

Ampere Rating [8]		AIR	(2) 2P Tandem—120/240 Vac (Two Spaces Required)
2P	2P		
25 A	50 A	10 kA	HOMT225250
30 A	30 A	10 kA	HOMT230230
30 A	40 A	10 kA	HOMT230240
30 A	50 A	10 kA	HOMT230250

**NOTE:** Typical catalog no. (i.e. HOMT215230) represents two 2P; outer poles (one 15 A 2P with common trip) and inner poles (one 30 A 2P with common trip).

**Homeline Circuit Breaker Wire Sizes**

**Table 7.34: Wire Sizes for Homeline Circuit Breakers**

Breaker Type	Ampere Rating	Wire Size (AWG/kcmil) [9]	
		Aluminum	Copper
HOM 1P	15–30 A	14–8 AWG	14–8 AWG or (2) 14–10 AWG
	40–50 A	8–2 AWG	8–2 AWG
HOM 2P	15–30 A	14–8 AWG	14–8 AWG or (2) 14–10 AWG
	35–70 A	8–2 AWG	8–2 AWG
	80–125 A	4–2/0 AWG	4–2/0 AWG
	150–200 A	4 AWG–300 kcmil	4 AWG–300 kcmil
HOMT and Quad	15–30 A	14–8 AWG	14–8 AWG
Quad Only	40–50 A	6–12 AWG	6–14 AWG
HOM-GFI - 1P	15–20 A	14–10 AWG	14–10 AWG
HOM-GFI - 2P	15–50 A	12–4 AWG	14–6 AWG

**Accessories for Homeline Circuit Breakers**

**Table 7.35: Accessories for Use with Homeline Circuit Breakers**

Description	Cat. No.	
<b>Handle Attachments</b>		
Handle Tie: Converts any two adjacent 120/240 Vac single HOM circuit breakers to independent trip 2P	HOM1HT	
Handle Tie: Converts any two adjacent 120/240 Vac 1P side-by-side HOMT circuit breakers to independent trip 2P	HOMTHT	
Handle Clamp: Clamp for holding HOM 1P handle in the ON or OFF position	QO1LO	
Handle Blocking Device: Attaches to standard HOM 2P circuit breakers for holding the handle in the OFF position	HOM2HBD	
Handle Padlock Attachment: For padlocking 1P Standard HOM breakers in the ON or OFF position	HOM1PA	
Handle Padlock Attachment: For padlocking 2P Standard HOM circuit breakers in ON or OFF position	15–70 A	HOM2PALA
	80–125 A	HOM2PAHA
Handle Padlock Attachment: For padlocking 1P CAFI, DF, GFI, and EPD HOM breakers in ON or OFF position	HOMELEC1PA	
Handle Padlock Attachment: For padlocking 2P CAFI, GFI, and EPD HOM breakers in ON or OFF position	HOMELEC2PALA	
Handle Padlock Attachment: For padlocking center poles of Homeline Quad breakers in the OFF position	HOMQPA	
Handle Padlock Attachment: For padlocking main circuit breakers in convertible load center in OFF position	50–125 A	QOM1PA [10]
	100–225 A	QOM2PA [10]
<b>Sub-Feed Lugs</b>		
125 A 2P plug-on—2 spaces required	HOML2125	
225 A 2P plug-on—4 spaces required	HOML2225 [11]	

<sup>oBS</sup> This product is obsolete.

[8] 15–20 A tandem or quad tandem circuit breakers are suitable for use with 60°C or 75°C conductors. 25–50 A tandem or quad tandem circuit breakers are suitable for use with 75°C conductors only.  
 [9] 15–30 A circuit breakers are suitable for use with 60°C or 75°C conductors. 40–125 A circuit breakers are suitable for use with 75°C conductors.  
 [10] 50–125 A QOM1 frame size; 100–225 A QOM2 frame size.  
 [11] Requires four spaces (1 AWG–300 kcmil Al/Cu). Use only in 1Ø panel rated 150 A or greater.



UL489 / CSA C22.2 No 5 / IEC/EN 60947-2 / GB14048-2  
Miniature Circuit Breakers

### Multi9 C60<sub>BP</sub> and C60<sub>BPR</sub> Miniature Circuit Breakers

C60<sub>BP</sub> and C60<sub>BPR</sub> are multi-standard miniature circuit breakers and branch circuit protection as defined by UL489. They combine the following functions:

- circuit protection against short-circuit curves
- circuit protection against overload currents
- tripping and fault indication by the addition of auxiliary accessories

Number of 18 mm (0.71 in.) Poles	Rating (A) 25°C/77°F	Breaking Capacity (kA rms)							
		UL 489 / CSA C22.2 No 5				IEC 60947-2			
		AIR				Icu			
	Voltage (Ue)	277 Vac	240 Vac	120 Vac	60 Vdc	440 Vac	415 Vac	240 Vac	60 Vdc
1P	0.5 to 35	10	14	14	10	—	3	10	20
	40 to 63	—	10	10	10	—	3	10	20
	Voltage (Ue)	480Y/277 Vac		240 Vac	125 Vdc	440 Vac	415 Vac	240 Vac	125 Vdc
2P	1 to 25	10		14	10	6	10	20	—
	30 to 35	10		14	—	6	10	20	—
3P	1 to 35	10		14	—	6	10	20	—
2P/3P	40 to 63	—		10	—	6	10	20	—

Table 7.36: C60<sub>BP</sub> and C60<sub>BPR</sub> Catalog Numbers

Type Rating (In)	UL489 and CSA Voltages	1P		2P		3P		
		Curve		Curve		Curve		
		Z	C	D (= K)	C	D (= K)	C	D (= K)
<b>C60<sub>BP</sub> (Tunnel Terminal Connection)</b>								
0.5	480Y/277 V and 240 V	M9F44170	M9F42170	M9F43170	—	—	—	
1		M9F44101	M9F42101	M9F43101	M9F42201	M9F43201	M9F42301	M9F43301
2		M9F44102	M9F42102	M9F43102	M9F42202	M9F43202	M9F42302	M9F43302
3		M9F44103	M9F42103	M9F43103	M9F42203	M9F43203	M9F42303	M9F43303
4		M9F44104	M9F42104	M9F43104	M9F42204	M9F43204	M9F42304	M9F43304
5		M9F44105	M9F42105	M9F43105	M9F42205	M9F43205	M9F42305	M9F43305
6		M9F44106	M9F42106	M9F43106	M9F42206	M9F43206	M9F42306	M9F43306
8		M9F44108	M9F42108	M9F43108	M9F42208	M9F43208	M9F42308	M9F43308
10		M9F44110	M9F42110	M9F43110	M9F42210	M9F43210	M9F42310	M9F43310
15		M9F44115	M9F42115	M9F43115	M9F42215	M9F43215	M9F42315	M9F43315
20		M9F44120	M9F42120	M9F43120	M9F42220	M9F43220	M9F42320	M9F43320
25		M9F44125	M9F42125	M9F43125	M9F42225	M9F43225	M9F42325	M9F43325
30		M9F44130	M9F42130	M9F43130	M9F42230	M9F43230	M9F42330	M9F43330
35		M9F44135	M9F42135	M9F43135	M9F42235	M9F43235	M9F42335	M9F43335
40		M9F44140	M9F42140	M9F43140	M9F42240	M9F43240	M9F42340	M9F43340
45		M9F44145	M9F42145	M9F43145	M9F42245	M9F43245	M9F42345	M9F43345
50		M9F44150	M9F42150	M9F43150	M9F42250	M9F43250	M9F42350	M9F43350
63	M9F44163	M9F42163	M9F43163	M9F42263	M9F43263	M9F42363	M9F43363	
<b>C60<sub>BPR</sub> (Ring Tongue Terminal Connection)</b>								
1	480Y/277 V and 240 V	M9F54101	M9F52101	M9F53101	M9F52201	M9F53201	M9F52301	M9F53301
2		M9F54102	M9F52102	M9F53102	M9F52202	M9F53202	M9F52302	M9F53302
4		M9F54104	M9F52104	M9F53104	M9F52204	M9F53204	M9F52304	M9F53304
6		M9F54106	M9F52106	M9F53106	M9F52206	M9F53206	M9F52306	M9F53306
8		M9F54108	M9F52108	M9F53108	M9F52208	M9F53208	M9F52308	M9F53308
10		M9F54110	M9F52110	M9F53110	M9F52210	M9F53210	M9F52310	M9F53310
15		M9F54115	M9F52115	M9F53115	M9F52215	M9F53215	M9F52315	M9F53315
20		M9F54120	M9F52120	M9F53120	M9F52220	M9F53220	M9F52320	M9F53320
25		M9F54125	M9F52125	M9F53125	M9F52225	M9F53225	M9F52325	M9F53325
30		M9F54130	M9F52130	M9F53130	M9F52230	M9F53230	M9F52330	M9F53330
35		M9F54135	M9F52135	M9F53135	M9F52235	M9F53235	M9F52335	M9F53335
40		M9F54140	M9F52140	M9F53140	M9F52240	M9F53240	M9F52340	M9F53340
45		M9F54145	M9F52145	M9F53145	M9F52245	M9F53245	M9F52345	M9F53345
50		M9F54150	M9F52150	M9F53150	M9F52250	M9F53250	M9F52350	M9F53350
63		M9F54163	M9F52163	M9F53163	M9F52263	M9F53263	M9F52363	M9F53363



C60<sub>BP</sub> 1P



C60<sub>BP</sub> 2P



C60<sub>BP</sub> 3P



C60<sub>BPR</sub> 1P



C60<sub>BPR</sub> 2P



C60<sub>BPR</sub> 3P





UL1077 / CSA C22.2 No 235 / IEC/EN 60947-2 / GB14048-2  
Multi9 Miniature Circuit Breaker

**Multi9 C60<sub>SP</sub> Miniature Circuit Breakers**

C60<sub>SP</sub> circuit breakers are multi-standard miniature circuit breakers and supplementary protection as defined by UL1077. They combine the following functions:

- circuit protection against short-circuit curves
- circuit protection against overload currents
- tripping and fault indication by the addition of auxiliary accessories

Number of 18 mm (0.71 in.) Poles	Rating (A) 25°C/77°F	Breaking capacity (kA rms)							
		AIR UL 489 / CSA C22.2 No 235				Icu IEC 60947-2			
		277 Vac	240 ac	120 Vac	65 Vdc	440 Vac	415 Vac	240 Vac	60 Vdc
1P	Voltage (Ue)	277 Vac	240 ac	120 Vac	65 Vdc	440 Vac	415 Vac	240 Vac	60 Vdc
	0.5 to 32	10	14	14	10	—	3	10	20
	40 to 63	5	10	10	10	—	3	10	20
2P	Voltage (Ue)	480Y/277 Vac		240 Vac	125 Vdc	440 Vac	415 Vac	240 Vac	125 Vdc
	1 to 25	10		14	10	6	10	20	—
	32	10		14	—	6	10	20	—
3P/4P	2 to 32	10		14	—	6	10	20	—
2P/3P/4P	40 to 63	5		10	—	6	10	20	—

**Table 7.37: C60<sub>SP</sub> Catalog Numbers**

Rating (In)	Tunnel Terminal Connection					
	Curve			Curve		
	B	C	D (= K)	B	C	D (= K)
	1P			2P		
0.5	M9F21170	M9F22170	M9F23170	—	—	—
1	M9F21101	M9F22101	M9F23101	M9F21201	M9F22201	M9F23201
2	M9F21102	M9F22102	M9F23102	M9F21202	M9F22202	M9F23202
3	M9F21103	M9F22103	M9F23103	M9F21203	M9F22203	M9F23203
4	M9F21104	M9F22104	M9F23104	M9F21204	M9F22204	M9F23204
5	M9F21105	M9F22105	M9F23105	M9F21205	M9F22205	M9F23205
6	M9F21106	M9F22106	M9F23106	M9F21206	M9F22206	M9F23206
8	M9F21108	M9F22108	M9F23108	M9F21208	M9F22208	M9F23208
10	M9F21110	M9F22110	M9F23110	M9F21210	M9F22210	M9F23210
13	M9F21113	M9F22113	M9F23113	M9F21213	M9F22213	M9F23213
16	M9F21116	M9F22116	M9F23116	M9F21216	M9F22216	M9F23216
20	M9F21120	M9F22120	M9F23120	M9F21220	M9F22220	M9F23220
25	M9F21125	M9F22125	M9F23125	M9F21225	M9F22225	M9F23225
32	M9F21132	M9F22132	M9F23132	M9F21232	M9F22232	M9F23232
40	M9F21140	M9F22140	M9F23140	M9F21240	M9F22240	M9F23240
45	M9F21145	M9F22145	M9F23145	M9F21245	M9F22245	M9F23245
50	M9F21150	M9F22150	M9F23150	M9F21250	M9F22250	M9F23250
63	M9F21163	M9F22163	M9F23163	M9F21263	M9F22263	M9F23263
	3P			4P		
0.5	—	—	—	—	—	—
1	—	—	—	—	—	—
2	M9F21302	M9F22302	M9F23302	M9F21402	M9F22402	M9F23402
3	—	—	—	—	—	—
4	—	—	—	—	—	—
5	—	—	—	—	—	—
6	M9F21306	M9F22306	M9F23306	M9F21406	M9F22406	M9F23406
8	M9F21308	M9F22308	M9F23308	M9F21408	M9F22408	M9F23408
10	M9F21310	M9F22310	M9F23310	M9F21410	M9F22410	M9F23410
13	M9F21313	M9F22313	M9F23313	M9F21413	M9F22413	M9F23413
16	M9F21316	M9F22316	M9F23316	M9F21416	M9F22416	M9F23416
20	M9F21320	M9F22320	M9F23320	M9F21420	M9F22420	M9F23420
25	M9F21325	M9F22325	M9F23325	M9F21425	M9F22425	M9F23425
32	M9F21332	M9F22332	M9F23332	M9F21432	M9F22432	M9F23432
40	M9F21340	M9F22340	M9F23340	M9F21440	M9F22440	M9F23440
45	M9F21345	M9F22345	M9F23345	M9F21445	M9F22445	M9F23445
50	M9F21350	M9F22350	M9F23350	M9F21450	M9F22450	M9F23450
63	M9F21363	M9F22363	M9F23363	M9F21463	M9F22463	M9F23463



C60<sub>SP</sub> 1P



C60<sub>SP</sub> 2P



C60<sub>SP</sub> 3P



C60<sub>SP</sub> 4P



UL 1077, IEC/EN 60947-2, GB14048.2  
Multi9 Miniature Circuit Breakers

**Multi9 C60<sub>H-DC</sub> Miniature Circuit Breakers for DC Circuits**

C60<sub>H-DC</sub> circuit breakers are multi-standard miniature circuit breakers and supplementary protection as defined by UL1077, dedicated to direct current applications. They combine the following functions:

- circuit protection against short-circuit curves
- circuit protection against overload currents
- tripping and fault indication by the addition of auxiliary accessories

Number of 18 mm (0.71 in.) Poles	Rating (A) 25°C/77°F	Breaking capacity (kA rms)			
		AIR UL 1077SA C22.2 No 5		Icu IEC 60947-2	
Voltage (Ue)		12–250 Vdc	110 Vdc	220 Vdc	250 Vdc
1P	0.5 to 63	5	20	10	6
Voltage (Ue)		12–250 Vdc	—	220 Vdc	440 Vdc 500 Vdc
2	0.5 to 63	5	—	20	10 6

**Table 7.38: C60<sub>H-DC</sub> Catalog Numbers**

Rating (In)	Curve			Curve		
	B	C	K (= D)	B	C	K (= D)
	1P			2P		
0.5	—	M9U21170	—	—	M9U21270	—
1	—	M9U21101	M9U31101	—	M9U31201	M9U31201
2	—	M9U21102	M9U31102	—	M9U21202	M9U31202
3	—	M9U21103	M9U31103	—	M9U21203	M9U31203
4	—	M9U21104	M9U31104	—	M9U21204	M9U31204
6	M9U11106	M9U21106	M9U31106	M9U11206	M9U21206	M9U31206
10	M9U11110	M9U21110	M9U31110	M9U11210	M9U21210	M9U31210
13	M9U11113	M9U21113	M9U31113	M9U11213	M9U21213	M9U31213
16	M9U11116	M9U21116	M9U31116	M9U11216	M9U21216	M9U31216
20	M9U11120	M9U21120	M9U31120	M9U11220	M9U21220	M9U31220
25	M9U11125	M9U21125	M9U31125	M9U11225	M9U21225	M9U31225
32	M9U11132	M9U21132	M9U31132	M9U11232	M9U21232	M9U31232
40	M9U11140	M9U21140	M9U31140	M9U11240	M9U21240	M9U31240
50	M9U11150	M9U21150	M9U31150	M9U11250	M9U21250	M9U31250
63	M9U11163	M9U21163	M9U31163	M9U11263	M9U21263	M9U31263



C60<sub>H-DC</sub> 1P



C60<sub>H-DC</sub> 2P

**Multi9 GFP Ground Fault Protectors**

UL 1053 residual current circuit breakers already protected upstream by a short circuit and overload protection device are used for:

- control and disconnection of electric circuits
- protection of people against electric shock by direct and indirect contacts
- protection of installations against insulation faults
- enhanced continuity of supply, during a series of close lightning strokes, IT earthing system, equipment including interference suppression filters, variable speed controllers, frequency converters, electronic ballasts for lighting
- enhanced earth leakage protection: in presence of harmonics or high frequency ejections.

A-SI type GFPs are ideal for operation in environments with a humid atmosphere and/or polluted by aggressive agents: swimming pools, marinas, agri-food industries, water treatment stations, industrial sites, etc.



UL 1053, IEC/EN 61008  
Multi9 Ground Fault Protectors

**Table 7.39: GFP UL 1053 Type A-SI**

A-S1 Type	Rating (A)	Sensitivity (mA)		Catalog No		Width in modules of 9 mm (0.354 in.)
		UL 1053	IEC/ EN 61008	120 or 240 V 230 or 240 V	240 V 480V/277 V 230/400 or 240/415 V	
	25	26	30	M9R81225	M9R41225	4
		86	100	M9R12225	M9R44225	
		260	300	M9R84225	—	
	40	26	30	M9R81240	M9R41240	
		260	300	M9R84240	—	
	63	26	30	M9R81263	—	
	25	26	30	—	M9R81425	8
		86	100	—	M9R12425	
		260	300	—	M9R84425	
	40	26	30	—	M9R81440	
		260	300	—	M9R84440	
	63	26	30	—	M9R81463	
		86	100	—	M9R12463	
	100	86	100	—	M9R12491	
		260	300	—	M9R84491	



Multi9 GFP 2P



Multi9 GFP 4P



**C60<sub>BP</sub> (UL489) Comb Busbars**

These comb busbars are aimed to be used only with C60<sub>BP</sub> circuit-breakers.

They perform distribution and subdistribution of the electric power supply and allow rapid assembly and disassembly of equipment.

**Table 7.40: C60<sub>BP</sub> Comb Busbars**

Connection Accessories	Comb Busbars						Insulated Connectors	Tooth Covers	End-Piece	
Function	<ul style="list-style-type: none"> <li>The comb busbars make it easier to install C60<sub>BP</sub> UL489 circuit breakers.</li> <li>They must not be cut.</li> </ul>						<ul style="list-style-type: none"> <li>Comb busbar power supply</li> <li>Vertical incoming feeder</li> </ul>	<ul style="list-style-type: none"> <li>Insulation of teeth remaining free</li> </ul>	<ul style="list-style-type: none"> <li>Ensures the correct comb busbar insulation</li> </ul>	
Use	Power supply by insulated connector <ul style="list-style-type: none"> <li>Use with rigid and flexible copper cable</li> <li>6 to 35 mm<sup>2</sup> (AWG #10 to #2):</li> </ul>						Tightening torque: 3.5 N•m (31 lb.in.)			
<b>Standard Comb Busbars</b>										
Number of poles	1P		2P			3P		All	All	—
Catalogue numbers	M9XUP106	M9XUP112	M9XUP206	M9XUP212	M9XUP306	M9XUP312	M9XUPC04	M9XCTC18	—	
Number of 18 mm modules	6	12	6	12	6	12	—	—	—	
Set of	1	1	1	1	1	1	4	5 x 3	—	
<b>Cuttable Comb Busbars</b>										
Number of poles x	1P	2P	3P	1P+Aux	3P+Aux		All	All	—	
Catalogue numbers	M9XCP157	M9XCP256	M9XCP357	M9XCA137	M9XCA348		M9XCPC04	M9XUTC18	M9XCEC10	
Number of 18 mm modules	57	56	57	37	48		—	—	—	
Set of	1	1	1	1	1		4	5 x 3	—	
<b>Technical Specifications</b>										
Acceptable current at 40°C (I <sub>e</sub> )	Standard comb busbars: 115 A Cuttable comb busbars: 80 A									
Resistance to short-circuit currents	Compatible with the breaking capacity of Schneider Electric modular circuit breakers									
Voltage rating (U <sub>e</sub> )	480Y/277 V									
Insulation voltage (U <sub>i</sub> )	1000 V AC									
Pollution degree	3									
Fire resistance	Self-extinguishability 960°C 30 s/30 s									
Colour	RAL 7035									
Standards	UL508									





**C60<sup>SP</sup> (UL1077) Comb Busbars**

The comb busbars are used only for C60<sup>SP</sup> circuit breakers UL 1077 supplementary protection in conformity with standards:

- UL 1077 / CSA C22.2 No. 235 / IEC 60947-2 / GB 14048-2.

They perform distribution and subdistribution of the electric power supply and allow rapid assembly and disassembly of equipment.

**Table 7.41: C60<sup>SP</sup> Comb Busbars**

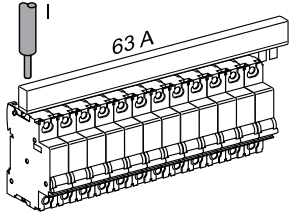
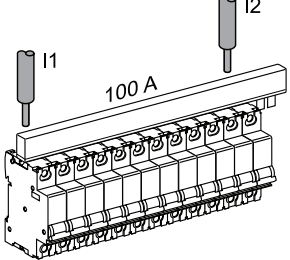
Connection Accessories		Comb Busbars			Tooth Cover End-Piece	
						
<b>Function</b>						
		<ul style="list-style-type: none"> <li>• The comb busbars make it easier to install Schneider Electric circuit breakers UL1077 supplementary protection.</li> <li>• Power supply directly in the cage of the circuit breaker.</li> </ul>			<ul style="list-style-type: none"> <li>• The Tooth Caps are insulated protectors which may be slipped onto the unused teeth of the comb busbar.</li> <li>• They come in strips with 1-pole spacing, but can be snapped apart to be used individually.</li> </ul>	
Number of poles		1P	2P	3P	All	
Voltage rating (Ue)		480Y/277 Vac	480Y/277 Vac	480Y/277 Vac	—	
Catalogue numbers		10285	10286	10287	60488	
Number of 18 mm modules		12 (8.5 in./216 mm)	12 (8.5 in./216 mm)	12 (8.5 in./216 mm)	—	
Set of		1	1	1	20	
<b>Technical Specifications</b>						
Insulation voltage (Ui)		690 Vac			—	
Impulse withstand voltage (Uimp)		12 kV under 240 V 5 kV under 480Y/277 V or 277 V			—	
Acceptable current at 40°C (Ie)		63 A with 1 central power supply point		100 A with 2 power supply points		—
						—
		Power supply via cable directly in the cage of the device:			—	
		<ul style="list-style-type: none"> <li>• cross section max: 3 AWG (25 mm<sup>2</sup>)</li> <li>• cross section min: 10 AWG (5.27 mm<sup>2</sup>)</li> </ul>			—	

**Multi9 C60 Accessories**

Electrical Accessories for C60 Circuit Breakers and Supplementary Protectors

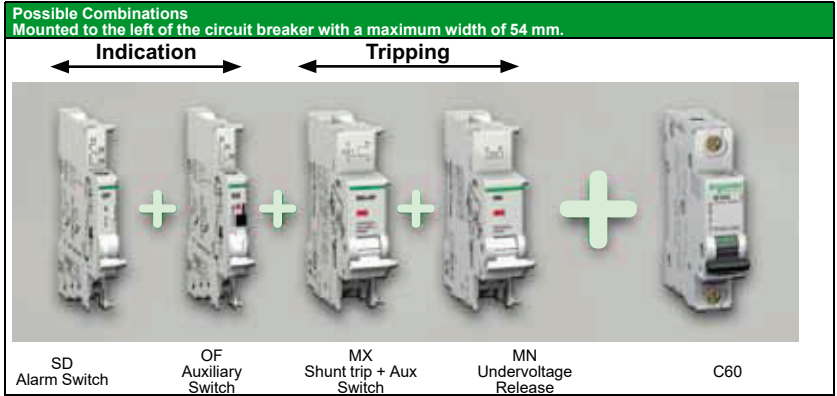
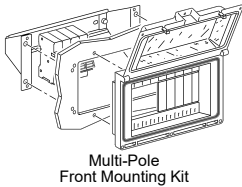
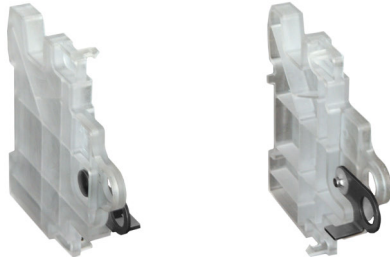
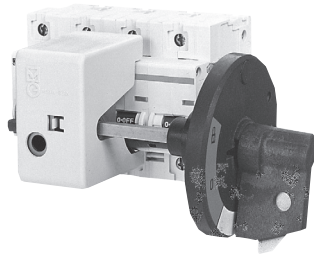
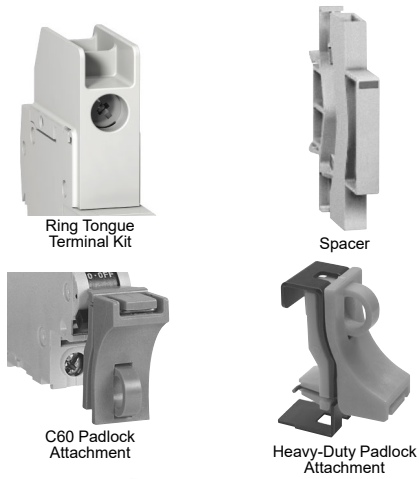

**Table 7.42: Multi9 C60 Electrical Accessories**

Descriptions	Control Voltage		Width in 9 mm Modules	C60 UL/IEC Cat. No.
	Vac	Vdc		
OF Auxiliary Switch (1a1b)	12–277	12–125	1	M9A26924
SD Alarm Switch (1a1b)	12–277	12–125	1	M9A26927
MX Shunt Trip + OF Auxiliary Switch (1a1b)	24	24	2	M9A26948
	48	48	2	M9A26947
	110–240–277	125	2	M9A26946
MN Undervoltage Release	24	24	2	M9A27108
	48	48	2	M9A26961
	120	—	2	M9A27107
	240	—	2	M9A26960
Multi9 GFP UL 1053 Listed Ground Fault Protectors	120 to 480Y/277 Vac; 30, 100, and 300 mA; 2P and 4Ps. See Multi 9 GFP Ground Fault Protectors, page 7-26 or Catalog LVCA90EM_EN			

**Table 7.43: Multi9 C60 Mechanical Accessories**

Descriptions	C60 Cat. No.
Ring tongue terminal kit for UL1077 C60	For one pole M9A17400
Spacer for DIN rail, Not UL Recognized	9 mm wide 27062
Padlock Attachment (1 per for 1P, 2P, 3P or 4P)	2 per pack 26970
Heavy-duty Padlock Attachment for C60, Locks OFF only	2 per pack M9PAF
Padlocking Device Left Side Mount, Locks OFF only [1]	1 per pack MGN26380
Padlocking Device Right Side Mount, Locks OFF only [2]	
Front Mounting Kit	1P MG26983
	2P MG26984
	3P MG26985
	4P MG26989
Terminal Screw Shield (Not UL Recognized)	Bag of two 4P shields 26981
Terminal cover (Not UL Recognized)	1P 26975
	2P 26976
	3P 26975 + 26976
	4P 26978
Rotary Handle for C60 (Non UL Recognized)	
Operating Subassembly	2P/3P/4P 27046
Door Interlock Handle	
Fixed Handle (Front or Lateral)	
<b>Multi-pole Front Mounting Kit</b>	
Rail Support (20 of 9 mm modules)	14211
Hinged Transparent Cover	14210

[1] Left-side mounted padlocking device cannot be used in conjunction with accessories SD, OF, MX or MN. Use right-side mounted padlocking device when accessories are required.  
[2] Right-side mounted padlocking device cannot be used in conjunction with VIGI module. Use left-side mounted padlocking device when VIGI Module is required.

### The PowerPacT Advantage

- **Proven Performance:** Industry-leading circuit breaker innovation and protection for heavy-duty commercial and industrial applications.
- **Smart:** Integrated metering options provide a cost-effective solution to reduce energy consumption, optimize energy costs, and improve energy availability for your facilities.
- **Flexible:** Full range of thermal-magnetic and electronic trip molded case circuit breakers from 15 to 3000 A, delivering the ratings, configurations, and operators for your unique applications.
- **Simple:** Common catalog numbers, standardized ratings, and a full range of field-installable accessories make product selection, installation and maintenance easier than ever.
- **Common Design Features:** Mounting holes, door trim, and handle accessories

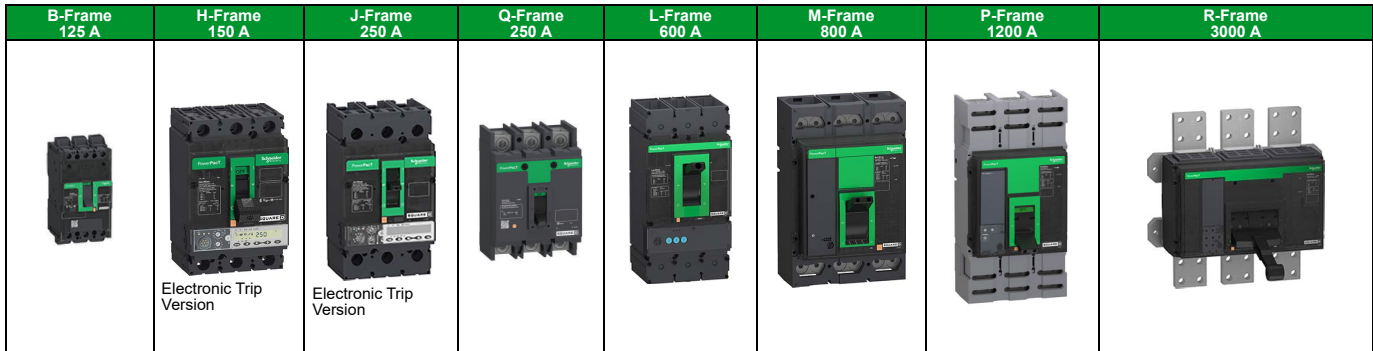

Table 7.44: PowerPacT Interrupting Ratings

Voltage	Interrupting Rating						
	B	D	G	J	K	L	R
240 Vac	10 kA	25 kA	65 kA	100 kA	65 kA [1]	125 kA	200 kA
480 Vac	—	18 kA	35 kA	65 kA	65 kA [2]	100 kA	200 kA
600 Vac	—	14 kA	18 kA	25 kA	65 kA [2]	50 kA [3]	100 kA

[1] B-frame K interrupting rating is 100 kA at 240 Vac  
 [2] P-frame K interrupting is 50 kA at 480 and 600 Vac.  
 [3] P-frame L interrupting is 25 kA at 600 Vac.

**Table 7.45: Common Catalog Numbering System**

Frame	Rating	Termination	Poles	Voltage	Amperage <sup>[4]</sup>			Suffix Code		Suffix Code	
H	G	L	3	6	1	5	0	A	B	S	A

1=1Pole  
2=2Pole  
3=3Pole  
4=4Pole

4=480 V  
6=600 V

2A/2B Auxiliary Switch

110 Vac Shunt Trip

**Frame Designation**

B	125 A Frame
H	150 A Frame
J	250 A Frame
Q	250 A Frame
L	600 A Frame
M	800 A Frame
P	1200 A Frame
R	3000 A Frame

**Interrupting Rating**

	240 Vac	480 Vac	600Vac
B	10 kA	—	—
D	25 kA	18 kA	14 kA
G	65 kA	35 kA	18 kA
J	100 kA	65 kA	25 kA
K	100 kA	65 kA	65 kA
L	125 kA	100 kA	50 kA
R	200 kA	200 kA	100 kA

**Terminations**

A	I-Line
L	Lugs on Both Ends
F	Bus Bar (No Lugs)
M	Lugs Line Side Only
P	Lugs Load End Only
N	Plug-in
D	Drawout
S	Rear Connected Studs

**For more information:**

- B-Frame Circuit Breakers, page 7-32
- H- and J-Frame Circuit Breakers, page 7-34
- Q-Frame Circuit Breakers, page 7-38
- L-Frame Circuit Breakers, page 7-40
- P-Frame Circuit Breakers, page 7-43
- R-Frame Circuit Breakers, page 7-44
- H, J, and L-Frame Motor Protectors, page 7-52
- Motor Circuit Protectors and Motor Protector Circuit Breakers, page 7-52
- Automatic Switches, page 7-48
- 500 Vdc Circuit Breakers, page 7-47
- Mission Critical Circuit Breakers, page 7-46
- Electrical Accessories for Circuit Breakers, page 7-55
- Motor Operators, page 7-56 and Rotary Handles, page 7-57
- Locks, Installation Accessories, and Rear Connectors, page 7-58
- Mechanical Lugs, page 7-60
- Compression Lugs, page 7-61 and Power Distribution Connectors, page 7-62
- Terminal Nuts, Terminal Pads, Terminal Shields, and Accessories, page 7-63
- Plug-In and Drawout Mountings, page 7-64
- MicroLogic Electronic Trip Units, page 7-65
- Trip Unit Accessories, page 7-68

[4] For amperage of M-, P- or R-frame circuit breakers, add a zero to the three amperage digits; for example, 120 = 1200 A.



B-Frame Thermal-Magnetic Trip Unit



With EverLink Lug Technology

**PowerPac B-Frame Molded Case Circuit Breakers (125 A)**

PowerPac B-frame circuit breakers provides economical thermal-magnetic circuit protection in a compact size.

- Fixed 15-125 A thermal-magnetic protection up to 600Y/347 Vac and 250 Vdc
- 1- to 4-pole unit mount construction; 1- to 3-pole I-Line construction
- UL listed interrupting ratings from 18 kA to 65 kA at 480 Vac
- EverLink lugs, a cable connection method that helps maintain low resistance connections
- UL, CSA, NOM, IEC, CCC certified and UKCA and CE marked for global acceptance

**Table 7.46: PowerPac B-Frame 125 A Thermal-Magnetic Circuit Breakers (600Y/347 Vac) with EverLink Lugs**

Current Rating @ 40° C	Interrupting Rating													
	D				G				J				K	
	1 Pole 347 Vac 125 Vdc	2 Pole 600Y/347 Vac 250 Vdc	3 Pole 600Y/347 Vac 250 Vdc	4 Pole 600Y/347 Vac 250 Vdc	1 Pole 347 Vac 125 Vdc	2 Pole 600Y/347 Vac 250 Vdc	3 Pole 600Y/347 Vac 250 Vdc	4 Pole 600Y/347 Vac 250 Vdc	1 Pole 347 Vac 125 Vdc	2 Pole 600Y/347 Vac 250 Vdc	3 Pole 600Y/347 Vac 250 Vdc	4 Pole 600Y/347 Vac 250 Vdc	1 Pole 347 Vac	2 Pole 600Y/347 Vac
15 A	BDL16015	BDL26015	BDL36015	BDL46015	BGL16015	BGL26015	BGL36015	BGL46015	BJL16015	BJL26015	BJL36015	BJL46015	BKL16015	BKL26015
20 A	BDL16020	BDL26020	BDL36020	BDL46020	BGL16020	BGL26020	BGL36020	BGL46020	BJL16020	BJL26020	BJL36020	BJL46020	BKL16020	BKL26020
25 A	BDL16025	BDL26025	BDL36025	BDL46025	BGL16025	BGL26025	BGL36025	BGL46025	BJL16025	BJL26025	BJL36025	BJL46025	BKL16025	BKL26025
30 A	BDL16030	BDL26030	BDL36030	BDL46030	BGL16030	BGL26030	BGL36030	BGL46030	BJL16030	BJL26030	BJL36030	BJL46030	BKL16030	BKL26030
35 A	BDL16035	BDL26035	BDL36035	BDL46035	BGL16035	BGL26035	BGL36035	BGL46035	BJL16035	BJL26035	BJL36035	BJL46035	—	—
40 A	BDL16040	BDL26040	BDL36040	BDL46040	BGL16040	BGL26040	BGL36040	BGL46040	BJL16040	BJL26040	BJL36040	BJL46040	—	—
45 A	BDL16045	BDL26045	BDL36045	BDL46045	BGL16045	BGL26045	BGL36045	BGL46045	BJL16045	BJL26045	BJL36045	BJL46045	—	—
50 A	BDL16050	BDL26050	BDL36050	BDL46050	BGL16050	BGL26050	BGL36050	BGL46050	BJL16050	BJL26050	BJL36050	BJL46050	—	—
60 A	BDL16060	BDL26060	BDL36060	BDL46060	BGL16060	BGL26060	BGL36060	BGL46060	BJL16060	BJL26060	BJL36060	BJL46060	—	—
70 A	BDL16070	BDL26070	BDL36070	BDL46070	BGL16070	BGL26070	BGL36070	BGL46070	BJL16070	BJL26070	BJL36070	BJL46070	—	—
80 A	BDL16080	BDL26080	BDL36080	BDL46080	BGL16080	BGL26080	BGL36080	BGL46080	BJL16080	BJL26080	BJL36080	BJL46080	—	—
90 A	BDL16090	BDL26090	BDL36090	BDL46090	BGL16090	BGL26090	BGL36090	BGL46090	BJL16090	BJL26090	BJL36090	BJL46090	—	—
100 A	BDL16100	BDL26100	BDL36100	BDL46100	BGL16100	BGL26100	BGL36100	BGL46100	BJL16100	BJL26100	BJL36100	BJL46100	—	—
110 A	BDL16110	BDL26110	BDL36110	BDL46110	BGL16110	BGL26110	BGL36110	BGL46110	BJL16110	BJL26110	BJL36110	BJL46110	—	—
125 A	BDL16125	BDL26125	BDL36125	BDL46125	BGL16125	BGL26125	BGL36125	BGL46125	BJL16125	BJL26125	BJL36125	BJL46125	—	—

**Table 7.47: B-Frame Interrupting Ratings**

Voltage	BD				BG				BJ				BK	
	1P 15 A-125 A	2P 15 A-125 A	3P 15 A-125 A	4P 15 A-125 A	1P 15 A-125 A	2P 15 A-125 A	3P 15 A-125 A	4P 15 A-125 A	1P 15 A-125 A	2P 15 A-125 A	3P 15 A-125 A	4P 15 A-125 A	1P 15 A- 30 A	2P 15 A- 30 A
240 Vac	25	25	25	25	65	65	65	65	100	100	100	100	100	100
480Y/277 Vac [5]		18				35								
277 Vac	18				35				65				65	
480 Vac		18	18	18		35	35	35		65	65	65		65
600Y/347 Vac		14	14	14		18	18	18		25	25	25		65
347 Vac	14				18				25				65	
240 IØ - 3Ø		18				35				65				65
125 Vdc	10				20				50					
250 Vdc		10	10	10		20	20	20		50	50	50		

[5] Only available with 480 V rated I-line catalogs.



**Table 7.48: B-Frame Termination Options**

Termination Letter and Description	Example
A I-Line (See Section 9, Panelboards)	B D L 3 6 1 0 0 For factory-installed termination, place termination letter in the <b>third</b> block of the circuit breaker catalog number. In this example "L" indicates EverLink Lugs for both ON and OFF ends.
F No Lugs (includes terminal nut kit on both ends)	
L ON end: EverLink Lugs OFF end: EverLink Lugs	
M ON end: EverLink Lugs OFF end: Terminal Nut Kit	
P ON end: Terminal Nut Kit OFF end: EverLink Lugs	

**Table 7.49: B-Frame Lug Options**

Lug Option Suffix	
No Suffix = EverLink Lugs both ends	B D L 3 6 1 0 0 LU For factory-installed lug option, place suffix after the amperage in the circuit breaker catalog number.
LU = EverLink Lug with Control Wire Terminal ON end; EverLink Lug OFF end	
LV = EverLink Lug ON end; EverLink Lug with Control Wire Terminal OFF end	
LW = EverLink Lug with Control Wire Terminal both ends	
LC = Copper Mechanical Lugs both ends	
LH = Aluminum Mechanical Lugs both ends	

**Table 7.50: PowerPacT B-Frame 125 A Magnetic Trip Values**

Current Rating @ 40° C	Fixed AC Magnetic Trip	
	Hold	Trip
15 A	400 A	600 A
20 A	400 A	600 A
25 A	480 A	720 A
30 A	480 A	720 A
35 A	480 A	720 A
40 A	480 A	720 A
45 A	480 A	720 A
50 A	480 A	720 A
60 A	640 A	960 A
70 A	800 A	1200 A
80 A	800 A	1200 A
90 A	1000 A	1500 A
100 A	1000 A	1500 A
110 A	1000 A	1500 A
125 A	1000 A	1500 A

Accessories see [page 7-55](#)  
 Optional Lugs see [page 7-60](#)  
 Dimensions see [page 7-86](#)



J-Frame  
MicroLogic™ Trip Unit



J-Frame 3-Pole  
Thermal-Magnetic Trip Unit

**Table 7.51: Lug Kit Wire Ranges**

Sensor Rating	Standard Lug Kit	Terminal Wire Range
60–150 A	AL150HD	14–3/0 AWG Al or Cu
250 A	AL250JD	3/0 AWG–350 kcmil Al or Cu

## PowerPacT H- and J-Frame Molded-Case Circuit Breakers (150 A and 250 A)

A flexible, high performance offer certified to global standards.

- Thermal magnetic or MicroLogic™ trip protection from 15–250 A up to 600 Vac and 250 Vdc
- 2 and 3-pole unit mount and I-Line constructions<sup>[6]</sup>
- High performance UL listed interrupting ratings from 18 to 200 kA at 480 Vac
- H- and J-Frame have common mounting holes, handle locations and trim dimensions with many shared accessories and auxiliaries.
- UL, CSA, NOM, IEC, CCC certified, and UKCA and CE marked for global acceptance.

**Table 7.52: H- and J-Frame Interrupting Ratings**

Voltage	Interrupting Rating				
	D	G	J	L	R
240 Vac	25 kA	65 kA	100 kA	125 kA	200 kA
480 Vac	18 kA	35 kA	65 kA	100 kA	200 kA
600 Vac	14 kA	18 kA	25 kA	50 kA	100 kA
250 Vdc <sup>[7]</sup>	20 kA	20 kA	20 kA	20 kA	—

**Table 7.53: H- and J-Frame Termination Options**

Termination Letter	
A = I-Line (See Section 9—Panelboards)	H D L 3 6 0 1 5 For factory-installed termination, place termination letter in the third block of the circuit breaker catalog number.
F = No Lugs (includes terminal nut kit on both ends)	
L = Lugs both ends	
M = Lugs ON end Terminal Nut Kit OFF end	
P = Lugs OFF end Terminal Nut Kit ON end	
N = Plug-in	
D = Drawout	
S = Rear Connected	

Accessories see [page 7-55](#)

Optional Lugs see [page 7-60](#)

Dimensions see [page 7-86](#)

Enclosures see [page 7-87](#)

[6] H- and J- frame circuit breakers can be used as a main or sub-feed circuit breaker in an NQ or NF panelboard.

[7] Not available with electronic trip units.

**PowerPacT H-Frame Thermal-Magnetic Circuit Breakers**

**Table 7.54: PowerPacT H-Frame 150 A Thermal-Magnetic UL Current-Limiting [8] Circuit Breakers (600 Vac, 250 Vdc) [9] With Factory Sealed Trip Unit Suitable for Reverse Connection [10]**

Current Rating @ 40°C	Fixed AC Magnetic Trip		Interrupting Rating							
			D		G		J [9]		L [9]	
	Hold	Trip	Standard (80% Rated)	100% Rated	Standard (80% Rated)	100% Rated	Standard (80% Rated)	100% Rated	Standard (80% Rated)	100% Rated
<b>H-Frame, 150A 2P, 600 Vac 50/60 Hz, 250 Vdc [11]</b>										
15 A	350 A	750 A	HDL26015	HDL26015C	HGL26015	HGL26015C	HJL26015	HJL26015C	HLL26015	HLL26015C
20 A	350 A	750 A	HDL26020	HDL26020C	HGL26020	HGL26020C	HJL26020	HJL26020C	HLL26020	HLL26020C
25 A	350 A	750 A	HDL26025	HDL26025C	HGL26025	HGL26025C	HJL26025	HJL26025C	HLL26025	HLL26025C
30 A	350 A	750 A	HDL26030	HDL26030C	HGL26030	HGL26030C	HJL26030	HJL26030C	HLL26030	HLL26030C
35 A	400 A	850 A	HDL26035	HDL26035C	HGL26035	HGL26035C	HJL26035	HJL26035C	HLL26035	HLL26035C
40 A	400 A	850 A	HDL26040	HDL26040C	HGL26040	HGL26040C	HJL26040	HJL26040C	HLL26040	HLL26040C
45 A	400 A	850 A	HDL26045	HDL26045C	HGL26045	HGL26045C	HJL26045	HJL26045C	HLL26045	HLL26045C
50 A	400 A	850 A	HDL26050	HDL26050C	HGL26050	HGL26050C	HJL26050	HJL26050C	HLL26050	HLL26050C
60 A	800 A	1450 A	HDL26060	HDL26060C	HGL26060	HGL26060C	HJL26060	HJL26060C	HLL26060	HLL26060C
70 A	800 A	1450 A	HDL26070	HDL26070C	HGL26070	HGL26070C	HJL26070	HJL26070C	HLL26070	HLL26070C
80 A	800 A	1450 A	HDL26080	HDL26080C	HGL26080	HGL26080C	HJL26080	HJL26080C	HLL26080	HLL26080C
90 A	800 A	1450 A	HDL26090	HDL26090C	HGL26090	HGL26090C	HJL26090	HJL26090C	HLL26090	HLL26090C
100 A	800 A	1700 A	HDL26100	HDL26100C	HGL26100	HGL26100C	HJL26100	HJL26100C	HLL26100	HLL26100C
110 A	900 A	1700 A	HDL26110	HDL26110C	HGL26110	HGL26110C	HJL26110	HJL26110C	HLL26110	HLL26110C
125 A	900 A	1700 A	HDL26125	HDL26125C	HGL26125	HGL26125C	HJL26125	HJL26125C	HLL26125	HLL26125C
150 A	900 A	1700 A	HDL26150	HDL26150C	HGL26150	HGL26150C	HJL26150	HJL26150C	HLL26150	HLL26150C
<b>H-Frame 150A 3P, 600 Vac 50/60 Hz, 250 Vdc</b>										
15 A	350 A	750 A	HDL36015	HDL36015C	HGL36015	HGL36015C	HJL36015	HJL36015C	HLL36015	HLL36015C
20 A	350 A	750 A	HDL36020	HDL36020C	HGL36020	HGL36020C	HJL36020	HJL36020C	HLL36020	HLL36020C
25 A	350 A	750 A	HDL36025	HDL36025C	HGL36025	HGL36025C	HJL36025	HJL36025C	HLL36025	HLL36025C
30 A	350 A	750 A	HDL36030	HDL36030C	HGL36030	HGL36030C	HJL36030	HJL36030C	HLL36030	HLL36030C
35 A	400 A	850 A	HDL36035	HDL36035C	HGL36035	HGL36035C	HJL36035	HJL36035C	HLL36035	HLL36035C
40 A	400 A	850 A	HDL36040	HDL36040C	HGL36040	HGL36040C	HJL36040	HJL36040C	HLL36040	HLL36040C
45 A	400 A	850 A	HDL36045	HDL36045C	HGL36045	HGL36045C	HJL36045	HJL36045C	HLL36045	HLL36045C
50 A	400 A	850 A	HDL36050	HDL36050C	HGL36050	HGL36050C	HJL36050	HJL36050C	HLL36050	HLL36050C
60 A	800 A	1450 A	HDL36060	HDL36060C	HGL36060	HGL36060C	HJL36060	HJL36060C	HLL36060	HLL36060C
70 A	800 A	1450 A	HDL36070	HDL36070C	HGL36070	HGL36070C	HJL36070	HJL36070C	HLL36070	HLL36070C
80 A	800 A	1450 A	HDL36080	HDL36080C	HGL36080	HGL36080C	HJL36080	HJL36080C	HLL36080	HLL36080C
90 A	800 A	1450 A	HDL36090	HDL36090C	HGL36090	HGL36090C	HJL36090	HJL36090C	HLL36090	HLL36090C
100 A	800 A	1700 A	HDL36100	HDL36100C	HGL36100	HGL36100C	HJL36100	HJL36100C	HLL36100	HLL36100C
110 A	900 A	1700 A	HDL36110	HDL36110C	HGL36110	HGL36110C	HJL36110	HJL36110C	HLL36110	HLL36110C
125 A	900 A	1700 A	HDL36125	HDL36125C	HGL36125	HGL36125C	HJL36125	HJL36125C	HLL36125	HLL36125C
150 A	900 A	1700 A	HDL36150	HDL36150C	HGL36150	HGL36150C	HJL36150	HJL36150C	HLL36150	HLL36150C

HJ and HL are UL certified as current limiting circuit breakers.

**PowerPacT J-Frame Thermal-Magnetic Circuit Breakers**

**Table 7.55: J-Frame 250 A Thermal-Magnetic UL Current-Limiting [12] Circuit Breakers (600 Vac, 250 Vdc) With Factory Sealed Trip Unit Suitable for Reverse Connection [10]**

Current Rating @ 40°C	Adjustable AC Magnetic Trip		Interrupting Rating									
			D		G		J [12]		L [12]		R [12]	
	Low	High	Standard (80% Rated)	100% Rated	Standard (80% Rated)	100% Rated	Standard (80% Rated)	100% Rated	Standard (80% Rated)	100% Rated	Standard (80% Rated)	100% Rated
<b>J-Frame 250 A 2P, 600 Vac 50/60 Hz, 250 Vdc [13]</b>												
150 A	750 A	1500 A	JDL26150	JDL26150C	JGL26150	JGL26150C	JJL26150	JJL26150C	JLL26150	JLL26150C	—	—
175 A	875 A	1750 A	JDL26175	JDL26175C	JGL26175	JGL26175C	JJL26175	JJL26175C	JLL26175	JLL26175C	—	—
200 A	1000 A	2000 A	JDL26200	JDL26200C	JGL26200	JGL26200C	JJL26200	JJL26200C	JLL26200	JLL26200C	—	—
225 A	1125 A	2250 A	JDL26225	JDL26225C	JGL26225	JGL26225C	JJL26225	JJL26225C	JLL26225	JLL26225C	—	—
250 A	1250 A	2500 A	JDL26250	JDL26250C	JGL26250	JGL26250C	JJL26250	JJL26250C	JLL26250	JLL26250C	—	—
<b>J-Frame 250 A 3P, 600 Vac 50/60 Hz, 250 Vdc</b>												
150 A	750 A	1500 A	JDL36150	JDL36150C	JGL36150	JGL36150C	JJL36150	JJL36150C	JLL36150	JLL36150C	JRL36150	JRL36150C
175 A	875 A	1750 A	JDL36175	JDL36175C	JGL36175	JGL36175C	JJL36175	JJL36175C	JLL36175	JLL36175C	JRL36175	JRL36175C
200 A	1000 A	2000 A	JDL36200	JDL36200C	JGL36200	JGL36200C	JJL36200	JJL36200C	JLL36200	JLL36200C	JRL36200	JRL36200C
225 A	1125 A	2250 A	JDL36225	JDL36225C	JGL36225	JGL36225C	JJL36225	JJL36225C	JLL36225	JLL36225C	JRL36225	JRL36225C
250 A	1250 A	2500 A	JDL36250	JDL36250C	JGL36250	JGL36250C	JJL36250	JJL36250C	JLL36250	JLL36250C	JRL36250	JRL36250C

JJ, JL and JR are UL certified as current limiting circuit breakers.

[8] Circuit breakers with J and L interrupting ratings are UL certified as current limiting.  
 [9] Standard lug kit: AL150HD. Terminal wire range: 14–3/0 AWG Al or Cu.  
 [10] See Supplemental Digest Section 3 for circuit breakers with field interchangeable trip units.  
 [11] HD and HG circuit breakers are true two-pole construction.  
 [12] Circuit breakers with J, L, and R interrupting ratings are UL certified as current limiting.  
 [13] 2P in a 3P module

PowerPacT H- and J-Frame Electronic Trip Current Limiting Circuit Breakers (150 A and 250 A)



H-Frame MicroLogic™ Trip Unit



J-Frame MicroLogic™ Trip Unit

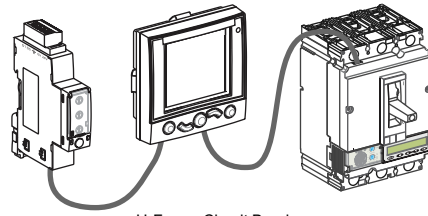

H-Frame Circuit Breaker  
Optional FDM and IFM Module

**Table 7.56: H-Frame 150 A and J-Frame 250 A Electronic Trip UL Current-Limiting [14] Standard (80% Rated) Circuit Breakers (600 Vac) With Factory Sealed Trip Unit [15] Suitable for Reverse Connection [16]**

Electronic Trip Unit			Sensor Rating	Interrupting Rating (80% Rated)				
Type	Function	Trip Unit		D	G	J [14]	L [14]	R [14]
600 Vac, 50/60 Hz, 3P								
MicroLogic Standard	LI	3.2 [17]	60 A	HDL36060U31X	HGL36060U31X	HJL36060U31X	HLL36060U31X	HRL36060U31X
			100 A	HDL36100U31X	HGL36100U31X	HJL36100U31X	HLL36100U31X	HRL36100U31X
			150 A	HDL36150U31X	HGL36150U31X	HJL36150U31X	HLL36150U31X	HRL36150U31X
			250 A	JDL36250U31X	JGL36250U31X	JJL36250U31X	JLL36250U31X	JRL36250U31X
MicroLogic Standard	LSI	3.2S [17] [18]	60 A	HDL36060U33X	HGL36060U33X	HJL36060U33X	HLL36060U33X	HRL36060U33X
			100 A	HDL36100U33X	HGL36100U33X	HJL36100U33X	HLL36100U33X	HRL36100U33X
			150 A	HDL36150U33X	HGL36150U33X	HJL36150U33X	HLL36150U33X	HRL36150U33X
			250 A	JDL36250U33X	JGL36250U33X	JJL36250U33X	JLL36250U33X	JRL36250U33X
MicroLogic Ammeter	LSI	5.2A	60 A	HDL36060U43X	HGL36060U43X	HJL36060U43X	HLL36060U43X	HRL36060U43X
			100 A	HDL36100U43X	HGL36100U43X	HJL36100U43X	HLL36100U43X	HRL36100U43X
			150 A	HDL36150U43X	HGL36150U43X	HJL36150U43X	HLL36150U43X	HRL36150U43X
			250 A	JDL36250U43X	JGL36250U43X	JJL36250U43X	JLL36250U43X	JRL36250U43X
MicroLogic Energy	LSI	5.2E	60 A	HDL36060U53X	HGL36060U53X	HJL36060U53X	HLL36060U53X	HRL36060U53X
			100 A	HDL36100U53X	HGL36100U53X	HJL36100U53X	HLL36100U53X	HRL36100U53X
			150 A	HDL36150U53X	HGL36150U53X	HJL36150U53X	HLL36150U53X	HRL36150U53X
			250 A	JDL36250U53X	JGL36250U53X	JJL36250U53X	JLL36250U53X	JRL36250U53X
MicroLogic Ammeter	LSIG	6.2A [19]	60 A	HDL36060U44X	HGL36060U44X	HJL36060U44X	HLL36060U44X	HRL36060U44X
			100 A	HDL36100U44X	HGL36100U44X	HJL36100U44X	HLL36100U44X	HRL36100U44X
			150 A	HDL36150U44X	HGL36150U44X	HJL36150U44X	HLL36150U44X	HRL36150U44X
			250 A	JDL36250U44X	JGL36250U44X	JJL36250U44X	JLL36250U44X	JRL36250U44X
MicroLogic Energy	LSIG	6.2E	60 A	HDL36060U54X	HGL36060U54X	HJL36060U54X	HLL36060U54X	HRL36060U54X
			100 A	HDL36100U54X	HGL36100U54X	HJL36100U54X	HLL36100U54X	HRL36100U54X
			150 A	HDL36150U54X	HGL36150U54X	HJL36150U54X	HLL36150U54X	HRL36150U54X
			250 A	JDL36250U54X	JGL36250U54X	JJL36250U54X	JLL36250U54X	JRL36250U54X

[14] Circuit breakers with J, L, and R interrupting ratings are UL certified as current limiting.

[15] See Supplemental Digest Section 3 for circuit breakers with field interchangeable trip units.

[16] For applications requiring communications see page 7-68.

[17] 3P circuit breakers with this trip unit can be used for 2P applications.

[18] Fixed ST and LT delays.

[19] 3P circuit breakers with this trip unit can be used for 2P applications requiring ground fault protection. Additional metering capabilities will not work properly on the unconnected phase.

**Table 7.57: H-Frame 150 A and J-Frame 250 A Electronic Trip UL Current-Limiting [20] 100% Rated Circuit Breakers (600 Vac) With Factory Sealed Trip Unit [21] Suitable for Reverse Connection [22]**

Electronic Trip Unit			Sensor Rating	Interrupting Rating (100% Rated)				
Type	Function	Trip Unit		D	G	J [20]	L [20]	R [20]
600 Vac, 50/60 Hz, 3P[23]								
MicroLogic Standard	LI	3.2 [24]	60 A	HDL36060CU31X	HGL36060CU31X	HJL36060CU31X	HLL36060CU31X	HRL36060CU31X
			100 A	HDL36100CU31X	HGL36100CU31X	HJL36100CU31X	HLL36100CU31X	HRL36100CU31X
			150 A	HDL36150CU31X	HGL36150CU31X	HJL36150CU31X	HLL36150CU31X	HRL36150CU31X
			250 A	JDL36250CU31X	JGL36250CU31X	JJL36250CU31X	JLL36250CU31X	JRL36250CU31X
MicroLogic Standard	LSI	3.2S [24] [25]	60 A	HDL36060CU33X	HGL36060CU33X	HJL36060CU33X	HLL36060CU33X	HRL36060CU33X
			100 A	HDL36100CU33X	HGL36100CU33X	HJL36100CU33X	HLL36100CU33X	HRL36100CU33X
			150 A	HDL36150CU33X	HGL36150CU33X	HJL36150CU33X	HLL36150CU33X	HRL36150CU33X
			250 A	JDL36250CU33X	JGL36250CU33X	JJL36250CU33X	JLL36250CU33X	JRL36250CU33X
MicroLogic Ammeter	LSI	5.2A	60 A	HDL36060CU43X	HGL36060CU43X	HJL36060CU43X	HLL36060CU43X	HRL36060CU43X
			100 A	HDL36100CU43X	HGL36100CU43X	HJL36100CU43X	HLL36100CU43X	HRL36100CU43X
			150 A	HDL36150CU43X	HGL36150CU43X	HJL36150CU43X	HLL36150CU43X	HRL36150CU43X
			250 A	JDL36250CU43X	JGL36250CU43X	JJL36250CU43X	JLL36250CU43X	JRL36250CU43X
MicroLogic Energy	LSI	5.2E	60 A	HDL36060CU53X	HGL36060CU53X	HJL36060CU53X	HLL36060CU53X	HRL36060CU53X
			100 A	HDL36100CU53X	HGL36100CU53X	HJL36100CU53X	HLL36100CU53X	HRL36100CU53X
			150 A	HDL36150CU53X	HGL36150CU53X	HJL36150CU53X	HLL36150CU53X	HRL36150CU53X
			250 A	JDL36250CU53X	JGL36250CU53X	JJL36250CU53X	JLL36250CU53X	JRL36250CU53X
MicroLogic Ammeter	LSIG	6.2A [26]	60 A	HDL36060CU44X	HGL36060CU44X	HJL36060CU44X	HLL36060CU44X	HRL36060CU44X
			100 A	HDL36100CU44X	HGL36100CU44X	HJL36100CU44X	HLL36100CU44X	HRL36100CU44X
			150 A	HDL36150CU44X	HGL36150CU44X	HJL36150CU44X	HLL36150CU44X	HRL36150CU44X
			250 A	JDL36250CU44X	JGL36250CU44X	JJL36250CU44X	JLL36250CU44X	JRL36250CU44X
MicroLogic Energy	LSIG	6.2E	60 A	HDL36060CU54X	HGL36060CU54X	HJL36060CU54X	HLL36060CU54X	HRL36060CU54X
			100 A	HDL36100CU54X	HGL36100CU54X	HJL36100CU54X	HLL36100CU54X	HRL36100CU54X
			150 A	HDL36150CU54X	HGL36150CU54X	HJL36150CU54X	HLL36150CU54X	HRL36150CU54X
			250 A	JDL36250CU54X	JGL36250CU54X	JJL36250CU54X	JLL36250CU54X	JRL36250CU54X

Accessories see page 7-55  
 Optional Lugs see page 7-60  
 Dimensions see page 7-86  
 Enclosures see page 7-87

[20] Circuit breakers with J, L, and R interrupting ratings are UL certified as current limiting.  
 [21] See Supplemental Digest Section 3 for circuit breakers with field interchangeable trip units.  
 [22] For applications requiring communications see page 7-68.  
 [23] 3-pole PowerPacT H- and J-frame circuit breakers can be used for 2-pole applications. (For such instances, MicroLogic 6.2 Ammeter and Energy trip units can be used for ground fault protection. Additional metering capabilities are not guaranteed when using MicroLogic Ammeter and Energy trip units for this type of application.  
 [24] 3P circuit breakers with this trip unit can be used for 2P applications.  
 [25] Fixed ST and LT delays.  
 [26] 3P circuit breakers with this trip unit can be used for 2P applications requiring ground fault protection. Additional metering capabilities will not work properly on the unconnected phase.

Class 0734 / Refer to Catalog: 0734CT0201

**Q-Frame Molded Case Circuit Breakers (250 A)**

PowerPacT Q-frame circuit breakers are used for overcurrent protection and switching on 240 Vac applications.<sup>[27]</sup>

- Fixed thermal magnetic protection from 70–250 A at 240 Vac
- 2- and 3-pole unit mount and I-Line constructions<sup>[28]</sup>
- UL listed interruption ratings from 10 kA to 100 kA at 240 Vac
- Available in standard (80%) rating only
- cULus and NOM certified



2-Pole Q-Frame with Thermal-Magnetic Trip Unit 70–250



3-Pole Q-Frame with Thermal-Magnetic Trip Unit 70–250 A

**Table 7.58: PowerPacT Q-Frame 250 A Thermal-Magnetic Circuit Breaker (240 Vac)**

Ampere Rating	Fixed AC Magnetic Trip		Interrupting Rating				Terminal Wire Range
	Hold	Trip	B	D	G	J	
<b>2P, 240 Vac</b>							
70 A	1000 A	1800 A	QBL22070	QDL22070	QGL22070	QJL22070	#4 AWG - 300 kcmil Al/Cu
80 A	1000 A	1800 A	QBL22080	QDL22080	QGL22080	QJL22080	
90 A	1000 A	1800 A	QBL22090	QDL22090	QGL22090	QJL22090	
100 A	1200 A	2400 A	QBL22100	QDL22100	QGL22100	QJL22100	
110 A	1200 A	2400 A	QBL22110	QDL22110	QGL22110	QJL22110	
125 A	1200 A	2400 A	QBL22125	QDL22125	QGL22125	QJL22125	
150 A	1200 A	2400 A	QBL22150	QDL22150	QGL22150	QJL22150	
175 A	1200 A	2400 A	QBL22175	QDL22175	QGL22175	QJL22175	
200 A	1200 A	2400 A	QBL22200	QDL22200	QGL22200	QJL22200	
225 A	1200 A	2400 A	QBL22225	QDL22225	QGL22225	QJL22225	
250 A <sup>[29]</sup>	1200 A	2400 A	QBL22250	QDL22250	QGL22250	QJL22250	
<b>3P, 240 Vac</b>							
70 A	1000 A	1800 A	QBL32070	QDL32070	QGL32070	QJL32070	#4 AWG - 300 kcmil Al/Cu
80 A	1000 A	1800 A	QBL32080	QDL32080	QGL32080	QJL32080	
90 A	1000 A	1800 A	QBL32090	QDL32090	QGL32090	QJL32090	
100 A	1200 A	2400 A	QBL32100	QDL32100	QGL32100	QJL32100	
110 A	1200 A	2400 A	QBL32110	QDL32110	QGL32110	QJL32110	
125 A	1200 A	2400 A	QBL32125	QDL32125	QGL32125	QJL32125	
150 A	1200 A	2400 A	QBL32150	QDL32150	QGL32150	QJL32150	
175 A	1200 A	2400 A	QBL32175	QDL32175	QGL32175	QJL32175	
200 A	1200 A	2400 A	QBL32200	QDL32200	QGL32200	QJL32200	
225 A	1200 A	2400 A	QBL32225	QDL32225	QGL32225	QJL32225	
250 A <sup>[30]</sup>	1200 A	2400 A	QBL32250	QDL32250	QGL32250	QJL32250	

**Table 7.59: Q-Frame Interrupting Ratings**

Voltage	Interrupting Rating			
	B	D	G	J
240 Vac	10 kA	25 kA	65 kA	100 kA <sup>[31]</sup>

**Table 7.60: Q-Frame Termination Options**

Termination Letter	Q G L 3 2 2 0 0
A = I-Line (See Section 9—Panelboards)	For factory-installed termination, place termination letter in the third block of the circuit breaker catalog number.
E = Bolt-on I-Line (See Section 9)	
F = No lugs	
L = Lugs both ends	
M = Lugs ON end, studs on OFF end	
P = Lugs OFF end, studs on ON end	

Dimension see page 7-86

Enclosures see page 7-87

<sup>[27]</sup> Replacement lugs and electrical accessories are not available for PowerPacT Q-frame circuit breakers.

<sup>[28]</sup> Q-frame can be used as main or sub-feed circuit breaker in a NQ panelboard.

<sup>[29]</sup> 250 A lugs are suitable for copper conductors only.

<sup>[30]</sup> 250 A circuit breakers are suitable for copper conductors only.

<sup>[31]</sup> 3P QJ circuit breakers are rated at 208Y/120 Vac only.



LAL/LHL  
2P and 3P 125–400 A

**LA/LH-Frame Molded Case Circuit Breaker (600 A)**

- Thermal magnetic protection from 125-400 A up to 600 Vac and 250 Vdc
- 2- and 3-pole unit mount and I-Line constructions
- UL listed interrupting ratings from 30 kA to 35 kA at 480 Vac
- UL and CSA certified

**NOTE:** Consider using PowerPacT™ circuit breakers for situations requiring circuit breaker accessories. See [PowerPacT Accessories](#), page 7-55 for more information.

**Table 7.61: LA/LH-Frame, 600 A, Thermal-Magnetic, Individually-Mounted Circuit Breakers, 600 Vac**

Ampere Rating	Adjustable AC Magnetic Trip		Cat. No.		Terminal Wire Range
	Low	High	Standard Interrupting	High Interrupting	
<b>2P, 600 Vac, 250 Vdc</b>					
125 A	625 A	1250 A	LAL26125	LHL26125	AL400LA (1) 1 AWG–600 kcmil Al or (2) 1 AWG–250 kcmil Al
150 A	750 A	1500 A	LAL26150	LHL26150	
175 A	875 A	1750 A	LAL26175	LHL26175	
200 A	1000 A	2000 A	LAL26200	LHL26200	
225 A	1125 A	2250 A	LAL26225	LHL26225	
250 A	1250 A	2500 A	LAL26250	LHL26250	
300 A	1500 A	3000 A	LAL26300	LHL26300	
350 A	1750 A	3500 A	LAL26350	LHL26350	
400 A	2000 A	4000 A	LAL26400	LHL26400	
<b>3P, 600 Vac, 250 Vdc</b>					
125 A	625 A	1250 A	LAL36125	LHL36125	AL400LA (1) 1 AWG–600 kcmil Al or (2) 1 AWG–250 kcmil Al
150 A	750 A	1500 A	LAL36150	LHL36150	
175 A	875 A	1750 A	LAL36175	LHL36175	
200 A	1000 A	2000 A	LAL36200	LHL36200	
225 A	1125 A	2250 A	LAL36225	LHL36225	
250 A	1250 A	2500 A	LAL36250	LHL36250	
300 A	1500 A	3000 A	LAL36300	LHL36300	
350 A	1750 A	3500 A	LAL36350	LHL36350	
400 A	2000 A	4000 A	LAL36400	LHL36400	

**Table 7.62: Interrupting Ratings**

Voltage	LAL	LHL
240 Vac	42 kA	65 kA
480 Vac	30 kA	35 kA
600 Vac	22 kA	25 kA

Accessories see [PowerPacT Accessories](#), page 7-55 through [Plug-In and Drawout Mountings](#), page 7-64

Optional Lugs see [Mechanical Lug Information](#), page Supplemental Digest Section 3.

Dimensions see [Dimensions and Shipping Weights](#), page 7-85

Enclosures see [Circuit Breaker Enclosures](#), page 7-87

**PowerPacT L-Frame Molded Case Circuit Breakers (600 A)**

A flexible, high performance offer certified to global standards.

- Basic Electronic and MicroLogic trip protection from 250–600 Vac
- 2-, 3- and 4-pole design; wide range of trip units to protect most applications
- High performance UL listed interrupting ratings from 35 kA to 200 kA at 480 Vac
- Standard (80%) or 100% rating
- UL, CSA, NOM, IEC, CCC certified, and UKCA and CE marked for global acceptance



PowerPacT L-Frame with MicroLogic™ Trip Unit

**Table 7.63: L-Frame 600 A Standard (80% Rated) UL Current-Limiting [32] Circuit Breakers (600 Vac) with Lugs and Factory-Sealed Electronic Trip Units Suitable for Reverse Connection [33][34]**

Electronic Trip Unit			Sensor Rating	Interrupting Rating (80% Rated)				
Type	Function	Trip Unit		G	J [32]	L [32]	R [32]	Terminal
600 Vac, 50/60 Hz, 3P								
MicroLogic Standard	LI	3.3 [35]	250 A	LGL36250U31X	LJL36250U31X	LLL36250U31X	LRL36250U31X	AL400L61K3 [36]
			400 A	LGL36400U31X	LJL36400U31X	LLL36400U31X	LRL36400U31X	AL600LS52K3
			600 A	LGL36600U31X	LJL36600U31X	LLL36600U31X	LRL36600U31X	AL400L61K3 [38]
MicroLogic Standard	LSI	3.3S [35] [37]	250 A	LGL36250U33X	LJL36250U33X	LLL36250U33X	LRL36250U33X	AL400L61K3 [38]
			400 A	LGL36400U33X	LJL36400U33X	LLL36400U33X	LRL36400U33X	AL600LS52K3
			600 A	LGL36600U33X	LJL36600U33X	LLL36600U33X	LRL36600U33X	AL600LS52K3
MicroLogic Ammeter	LSI	5.3A	400 A	LGL36400U43X	LJL36400U43X	LLL36400U43X	LRL36400U43X	AL600LS52K3
MicroLogic Energy	LSI	5.3E	400 A	LGL36400U53X	LJL36400U53X	LLL36400U53X	LRL36400U53X	
			600 A	LGL36600U53X	LJL36600U53X	LLL36600U53X	LRL36600U53X	
MicroLogic Ammeter	LSIG	6.3A	400 A	LGL36400U44X	LJL36400U44X	LLL36400U44X	LRL36400U44X	
			600 A	LGL36600U44X	LJL36600U44X	LLL36600U44X	LRL36600U44X	
MicroLogic Energy	LSIG	6.3E [39]	400 A	LGL36400U54X	LJL36400U54X	LLL36400U54X	LRL36400U54X	
			600 A	LGL36600U54X	LJL36600U54X	LLL36600U54X	LRL36600U54X	
600 Vac, 50/60 Hz, 4P								
MicroLogic Standard	LI	3.3	250 A	LGL46250U31X	LJL46250U31X	LLL46250U31X	LRL46250U31X	AL400L61K4
			400 A	LGL46400U31X	LJL46400U31X	LLL46400U31X	LRL46400U31X	AL600LS52K4
			600 A	LGL46600U31X	LJL46600U31X	LLL46600U31X	LRL46600U31X	AL400L61K4
MicroLogic Standard	LSI	3.3S [37]	250 A	LGL46250U33X	LJL46250U33X	LLL46250U33X	LRL46250U33X	AL400L61K4
			400 A	LGL46400U33X	LJL46400U33X	LLL46400U33X	LRL46400U33X	AL600LS52K4
			600 A	LGL46600U33X	LJL46600U33X	LLL46600U33X	LRL46600U33X	AL600LS52K4
MicroLogic Ammeter	LSI	5.3A	400 A	LGL46400U43X	LJL46400U43X	LLL46400U43X	LRL46400U43X	AL600LS52K4
MicroLogic Energy	LSI	5.3E	400 A	LGL46600U43X	LJL46600U43X	LLL46600U43X	LRL46600U43X	
			600 A	LGL46400U53X	LJL46400U53X	LLL46400U53X	LRL46400U53X	
MicroLogic Ammeter	LSIG	6.3A	400 A	LGL46400U44X	LJL46400U44X	LLL46400U44X	LRL46400U44X	
			600 A	LGL46600U44X	LJL46600U44X	LLL46600U44X	LRL46600U44X	
MicroLogic Energy	LSIG	6.3E	400 A	LGL46400U54X	LJL46400U54X	LLL46400U54X	LRL46400U54X	
			600 A	LGL46600U54X	LJL46600U54X	LLL46600U54X	LRL46600U54X	

[32] Circuit breakers with J, L, and R interrupting ratings are UL certified as current limiting.

[33] See Supplemental Digest Section 3 for circuit breakers with field interchangeable trip units.

[34] For applications requiring communications see page 7-68.

[35] 3P circuit breakers with this trip unit can be used for 2P applications.

[36] AL600LS52K3 terminal wire range is (2) 2/0 AWG 500 kcmil Al/Cu

[37] Fixed ST and LT delays.

[38] AL400L61K3 terminal wire ranges are (1) 2 AWG–600 kcmil Cu or (1) 2 AWG–500 kcmil Al.

[39] 3-pole circuit breakers can be used for 2-pole applications. (For such instances, MicroLogic 6.2 Ammeter and Energy trip units can be used for ground fault protection. Additional metering capabilities are not guaranteed when using MicroLogic Ammeter and Energy trip units for this type of application.)



**Table 7.64: L-Frame 600 A 100% Rated UL Current-Limiting [40] Circuit Breakers with Lugs and Factory-Sealed Electronic Trip Units Suitable for Reverse Connection [41][42]**

Electronic Trip Unit			Sensor Rating	Interrupting Rating (100% Rated)					Terminal
Type	Function	Trip Unit		D	G	J [40]	L [40]	R [40]	
600 Vac, 50/60 Hz, 3P									
MicroLogic Standard	LI	3.3 [43]	250 A	LDL36250CU31X	LGL36250CU31X	LJL36250CU31X	LLL36250CU31X	LRL36250CU31X	AL400L61K3
			400 A	LDL36400CU31X	LGL36400CU31X	LJL36400CU31X	LLL36400CU31X	LRL36400CU31X	AL600LS52K3
MicroLogic Standard	LSI	3.3S [43] [44]	250 A	LDL36250CU33X	LGL36250CU33X	LJL36250CU33X	LLL36250CU33X	LRL36250CU33X	AL400L61K3
			400 A	LDL36400CU33X	LGL36400CU33X	LJL36400CU33X	LLL36400CU33X	LRL36400CU33X	AL600LS52K3
MicroLogic Ammeter	LSI	5.3A	400 A	LDL36400CU43X	LGL36400CU43X	LJL36400CU43X	LLL36400CU43X	LRL36400CU43X	AL600LS52K3
MicroLogic Energy	LSI	5.3E	400 A	LDL36400CU53X	LGL36400CU53X	LJL36400CU53X	LLL36400CU53X	LRL36400CU53X	
MicroLogic Ammeter	LSIG	6.3A	400 A	LDL36400CU44X	LGL36400CU44X	LJL36400CU44X	LLL36400CU44X	LRL36400CU44X	
MicroLogic Energy	LSIG	6.3E [45]	400 A	LDL36400CU54X	LGL36400CU54X	LJL36400CU54X	LLL36400CU54X	LRL36400CU54X	
600 Vac, 50/60 Hz, 4P									
MicroLogic Standard	LI	3.3	250 A	LDL46250CU31X	LGL46250CU31X	LJL46250CU31X	LLL46250CU31X	LRL46250CU31X	AL400L61K4
			400 A	LDL46400CU31X	LGL46400CU31X	LJL46400CU31X	LLL46400CU31X	LRL46400CU31X	AL600LS52K4
MicroLogic Standard	LSI	3.3S	250 A	LDL46250CU33X	LGL46250CU33X	LJL46250CU33X	LLL46250CU33X	LRL46250CU33X	AL400L61K4
			400 A	LDL46400CU33X	LGL46400CU33X	LJL46400CU33X	LLL46400CU33X	LRL46400CU33X	AL600LS52K4
MicroLogic Ammeter	LSI	5.3A	400 A	LDL46400CU43X	LGL46400CU43X	LJL46400CU43X	LLL46400CU43X	LRL46400CU43X	AL600LS52K4
MicroLogic Energy	LSI	5.3E	400 A	LDL46400CU53X	LGL46400CU53X	LJL46400CU53X	LLL46400CU53X	LRL46400CU53X	
MicroLogic Ammeter	LSIG	6.3A	400 A	LDL46400CU44X	LGL46400CU44X	LJL46400CU44X	LLL46400CU44X	LRL46400CU44X	
MicroLogic Energy	LSIG	6.3E	400 A	LDL46400CU54X	LGL46400CU54X	LJL46400CU54X	LLL46400CU54X	LRL46400CU54X	

**Table 7.65: PowerPacT L-Frame Terminal Wire Ranges**

Terminal	Wire Range
AL400L61K3	(1) 2 AWG–600 kcmil Cu or 1) 2 AWG–500 kcmil Al.
AL600LS52K3	(2) 2/0 AWG–500 kcmil Al/Cu.

**Table 7.66: PowerPacT L-Frame Termination Options**

Termination Letter	Termination Option
A	I-Line (See Section 9—Panelboards)
F	No lugs
L	Lugs both ends
M	Lugs ON end, terminal nut kit OFF end
P	Lugs OFF end, terminal nut kit ON end
N	Plug In
D	Drawout
S	Rear Connected

For factory-installed termination, place termination letter in the third block of the circuit breaker catalog number.  
Termination Letter  
L G L 3 6 6 0 0 U 4 4 X

**Table 7.67: PowerPacT L-Frame Interrupting Ratings**

Voltage	Interrupting Rating				
	D	G	J	L	R
240 Vac	25 kA	65 kA	100 kA	125 kA	200 kA
480 Vac	18 kA	35 kA	65 kA	100 kA	200 kA
600 Vac	14 kA	18 kA	25 kA	50 kA	100 kA

Accessories see page 7-55  
 Optional Lugs see page 7-60  
 Dimensions see page 7-86  
 Enclosures see page 7-87

[40] Circuit breakers with J, L, and R interrupting ratings are UL certified as current limiting.  
 [41] See Supplemental Digest Section 3 for circuit breakers with field interchangeable trip units.  
 [42] For applications requiring communications see page 7-68.  
 [43] 3P circuit breakers with this trip unit can be used for 2P applications.  
 [44] Fixed ST and LT delays.  
 [45] 3-pole circuit breakers can be used for 2-pole applications. (For such instances, MicroLogic 6.2 Ammeter and Energy trip units can be used for ground fault protection. Additional metering capabilities are not guaranteed when using MicroLogic Ammeter and Energy trip units for this type of application.)



PowerPacT M-Frame Circuit Breaker with Basic Electronic Trip Unit

### PowerPacT M-Frame Molded Case Circuit Breakers (800 A)

PowerPacT M-frame circuit breakers use an electronic trip system with the simplicity of a thermal magnetic breaker.

- Basic electronic trip protection from 300 to 800 A up to 600 Vac
- 2- and 3-pole unit mount and I-line construction
- UL listed interrupting ratings from 35 to 65 kA at 480 Vac
- Common mounting holes, handle locations and trim dimensions with shared auxiliaries and accessories with P-frame devices
- Available in standard (80%) rating only
- UL, CSA, NOM, IEC, CCC certified, and UKCA and CE marked for global acceptance

**Table 7.68: M-Frame 800 A, Basic Electronic Trip System Type ET 1.0 [46] Factory-Sealed Trip Unit**

Electronic Trip Unit		Ampere Rating	Adjustable Instantaneous Trip Range		Interrupting Rating	
Type	Function		Low	High	G	J
2P, 600 Vac 50/60 Hz						
Basic	Fixed Long-time, Adjustable Instantaneous Trip	400 A	800	4000	MGL26400	MJL26400
		600 A	1200	6000	MGL26800	MJL26800
3P, 600 Vac 50/60 Hz						
Basic	Fixed Long-time, Adjustable Instantaneous Trip	400 A	800	4000	MGL36400	MJL36400
		600 A	1200	6000	MGL36800	MJL36800

**Table 7.69: M-Frame 800 A, Adjustable Amperage Electronic Trip Unit**

Electronic Trip Unit		Adjustable Long-Time Settings	Adjustable Instantaneous		Interrupting Rating	
Type	Function		Low	High	G	J
2P, 600 Vac 50/60 Hz						
Basic	Adjustable Long-Time Adjustable Instantaneous Trip	300–800	2x	10x	MGL26800E10	MJL26800E10
3P, 600 Vac 50/60 Hz						
Basic	Adjustable Long-Time Adjustable Instantaneous Trip	300–800	2x	10x	MGL36800E10	MJL36800E10

**Table 7.70: M-Frame Termination Options**

Termination Letter	Termination Option
A	I-Line (See Section 9—Panelboards)
F	No lugs
L	Lugs both ends
M	Lugs ON end, terminal nut kit OFF end
P	Lugs OFF end, terminal nut kit ON end

M G L 3 6 4 0 0  
For factory-installed termination, place termination letter in the third block of the circuit breaker catalog number.

**Table 7.71: PowerPacT M-Frame Interrupting Ratings**

Voltage	Interrupting Rating	
	G	J
240 Vac	65 kA	100 kA
480 Vac	35 kA	65 kA
600 Vac	18 kA	25 kA

Accessories see [page 7-55](#)  
Optional Lugs see [page 7-60](#)

Dimensions see [page 7-86](#)  
Enclosures see [page 7-87](#)

[46] The ET 1.0 trip unit cannot be field replaced or have the long-time trip point setting adjusted. It is considered an electronic equivalent of a thermal-magnetic circuit breaker.



P-Frame 1200 A Unit-Mount



Electrically Operated P-Frame 800 A Unit-Mount

**Table 7.72: P-Frame Interrupting Ratings**

Voltage	P-Frame Interrupting Rating			
	G	J	K	L
240 Vac	65 kA	100 kA	65 kA	125 kA
480 Vac	35 kA	65 kA	50 kA	100 kA
600 Vac	18 kA	25 kA	50 kA	—

**Table 7.73: P-Frame Termination Options**

Termination Letter
A = I-Line (See Section 9—Panelboards)
D = Drawout
F = No Lugs (Includes terminal nut kit on both ends)
L = Lugs both ends
M = Lugs ON end, terminal nut kit OFF end
P = Lugs OFF end, terminal nut kit ON end
P G L 3 6 0 4 0 U 4 1 A
For factory-installed termination, place termination letter in the third block of the circuit breaker catalog number.

Dimensions see page 7-86

Trip Unit Options see page 7-66

Optional Lugs see page 7-60

Alternate Rating Plugs see page 7-68

Enclosures see page 7-87

Accessories see page 7-55

**PowerPac P-Frame Molded Case Circuit Breakers (1200 A)**

- MicroLogic trip protection from 250 to 1200 A up to 600 Vac
- 2-, 3- and 4-pole unit-mount construction
- UL listed interrupting ratings from 35 kA to 100 kA at 480 Vac
- Same dimensions, common mounting, bussing, cabling and door cut-out as PowerPac M-frame circuit breakers
- Standard (80%) and 100% rating
- UL, CSA, NOM, IEC, CCC certified, and UKCA and CE marked for global acceptance

**Table 7.74: P-Frame 1200 A (600 Vac, 50/60 Hz) 3P [47] Circuit Breaker with Electronic Trip Unit**

Type	Electronic Trip Unit		Sensor Rating	Cat. No. [48]	Terminal Wire Range
	Function	Trip Unit			
Basic Electronic Trip Unit (Not Interchangeable)	Fixed long-time, Adjustable Instantaneous	ET1.01	600 A	P■L36060	AL800M23K (3) 3/0 AWG–500 kcmil Al or Cu
			800 A	P■L36080	AL1200P25K (4) 3/0 AWG–500 kcmil Al or Cu
			1000 A	P■L36100	
			1200 A	P■L36120	
MicroLogic Interchangeable Standard Trip Unit	LI	3.0	250 A	P■L36025(C)U31A	AL800M23K (3) 3/0 AWG–500 kcmil Al or Cu
			400 A	P■L36040(C)U31A	
			600 A	P■L36060(C)U31A	
			800 A	P■L36080(C)U31A	
			1000 A	P■L36100(C)U31A	
			1200 A	P■L36120(C)U31A	
	LSI	5.0	250 A	P■L36025(C)U33A	AL800M23K (3) 3/0 AWG–500 kcmil Al or Cu
			400 A	P■L36040(C)U33A	
			600 A	P■L36060(C)U33A	
			800 A	P■L36080(C)U33A	
			1000 A	P■L36100(C)U33A	
			1200 A	P■L36120(C)U33A	
MicroLogic Interchangeable Ammeter Trip Unit	LI	3.0A	250 A	P■L36025(C)U41A	AL800M23K (3) 3/0 AWG–500 kcmil Al or Cu
			400 A	P■L36040(C)U41A	
			600 A	P■L36060(C)U41A	
			800 A	P■L36080(C)U41A	
			1000 A	P■L36100(C)U41A	
			1200 A	P■L36120(C)U41A	
	LSI	5.0A	250 A	P■L36025(C)U43A	AL800M23K (3) 3/0 AWG–500 kcmil Al or Cu
			400 A	P■L36040(C)U43A	
			600 A	P■L36060(C)U43A	
			800 A	P■L36080(C)U43A	
			1000 A	P■L36100(C)U43A	
			1200 A	P■L36120(C)U43A	
LSIG	6.0A	250 A	P■L36025(C)U44A	AL800M23K (3) 3/0 AWG–500 kcmil Al or Cu	
		400 A	P■L36040(C)U44A		
		600 A	P■L36060(C)U44A		
		800 A	P■L36080(C)U44A		
		1000 A	P■L36100(C)U44A		
		1200 A	P■L36120(C)U44A		
MicroLogic Interchangeable Power Trip Unit	LSI	5.0P	250 A	P■L36025(C)U63AE1	AL800M23K (3) 3/0 AWG–500 kcmil Al or Cu
			400 A	P■L36040(C)U63AE1	
			600 A	P■L36060(C)U63AE1	
			800 A	P■L36080(C)U63AE1	
			1000 A	P■L36100(C)U63AE1	
			1200 A	P■L36120(C)U63AE1	
	LSIG	6.0P	250 A	P■L36025(C)U64AE1	AL800M23K (3) 3/0 AWG–500 kcmil Al or Cu
			400 A	P■L36040(C)U64AE1	
			600 A	P■L36060(C)U64AE1	
			800 A	P■L36080(C)U64AE1	
			1000 A	P■L36100(C)U64AE1	
			1200 A	P■L36120(C)U64AE1	
MicroLogic Interchangeable Harmonic Trip Unit	LSI	5.0H	250 A	P■L36025(C)U73AE1	AL800M23K (3) 3/0 AWG–500 kcmil Al or Cu
			400 A	P■L36040(C)U73AE1	
			600 A	P■L36060(C)U73AE1	
			800 A	P■L36080(C)U73AE1	
			1000 A	P■L36100(C)U73AE1	
			1200 A	P■L36120(C)U73AE1	
	LSIG	6.0H	250 A	P■L36025(C)U74AE1	AL800M23K (3) 3/0 AWG–500 kcmil Al or Cu
			400 A	P■L36040(C)U74AE1	
			600 A	P■L36060(C)U74AE1	
			800 A	P■L36080(C)U74AE1	
			1000 A	P■L36100(C)U74AE1	
			1200 A	P■L36120(C)U74AE1	

[47] For 2P and 4P information see Catalog 0612CT0101.

[48] To complete the catalog number:

Replace the ■ with the appropriate interrupting rating (G, J, K or L).

For all L interrupting ratings, change the 5th character (voltage rating) from a 6 (600 V) to a 4 (480V). The 480 V AIR is standard 100 kA.

For 100% rated circuit breakers, add a "C" in the 9th character place. For example, the catalog number for a 100% rated trip unit with LI trip functions at 250 A would be PBL36025CU31A.

PowerPac R-Frame Molded Case Circuit Breakers (3000 A)

- MicroLogic electronic trip protection from 600–3000A up to 600 Vac
- 2-, 3- and 4-pole construction
- UL listed interrupting ratings from 35 to 100 kA at 480Vac
- Built-in Modbus protocol
- Standard (80%) and 100% rating
- UL, CSA, NOM, IEC, CCC certified, and UKCA and CE marked for global acceptance



R-Frame Unit-Mount

Table 7.75: R-Frame Interrupting Ratings

Voltage	R-Frame Interrupting Rating			
	G	J	K	L
240 Vac	65 kA	100 kA	65 kA	125 kA
480 Vac	35 kA	65 kA	65 kA	100 kA
600 Vac	18 kA	25 kA	65 kA	50 kA

Table 7.76: R-Frame Termination Options

Termination Letter
A = I-Line (See Section 9—Panelboards)
F = No Lugs (Includes terminal nut kit on both ends)
RJ F 3 6 3 0 0 U 4 1 A
For factory-installed termination, place termination letter in the third block of the circuit breaker catalog number.

Dimensions see page 7-86  
 Trip Unit Options see page 7-66  
 Optional Lugs see page 7-60  
 Alternate Rating Plugs see page 7-68  
 Enclosures see page 7-87  
 Accessories see page 7-55

Table 7.77: R-Frame 3000 A (600 Vac, 50/60 Hz) 3P Circuit Breaker with Electronic Trip Unit

Type	Electronic Trip Unit [49]		Sensor Rating	Cat. No. [50]
	Function	Trip Unit		
Basic Electronic Trip Unit (Not Interchangeable)	Fixed long-time, Adjustable Instantaneous	ET1.0I	1200 A	R■F36120
			1600 A	R■F36160
			2000 A	R■F36200
			2500 A	R■F36250
MicroLogic Interchangeable Standard Trip Unit	LI	3.0	600 A	R■F36060(C)U31A
			800 A	R■F36080(C)U31A
			1000 A	R■F36100(C)U31A
			1200 A	R■F36120(C)U31A
			1600 A	R■F36160(C)U31A
			2000 A	R■F36200(C)U31A
			2500 A	R■F36250(C)U31A
			3000 A	R■F36300(C)U31A
	LSI	5.0	600 A	R■F36060(C)U33A
			800 A	R■F36080(C)U33A
			1000 A	R■F36100(C)U33A
			1200 A	R■F36120(C)U33A
			1600 A	R■F36160(C)U33A
			2000 A	R■F36200(C)U33A
			2500 A	R■F36250(C)U33A
			3000 A	R■F36300(C)U33A
MicroLogic Interchangeable Anmeter Trip Unit	LI	3.0A	600 A	R■F36060(C)U41A
			800 A	R■F36080(C)U41A
			1000 A	R■F36100(C)U41A
			1200 A	R■F36120(C)U41A
			1600 A	R■F36160(C)U41A
			2000 A	R■F36200(C)U41A
			2500 A	R■F36250(C)U41A
			3000 A	R■F36300(C)U41A
	LSI	5.0A	600 A	R■F36060(C)U43A
			800 A	R■F36080(C)U43A
			1000 A	R■F36100(C)U43A
			1200 A	R■F36120(C)U43A
			1600 A	R■F36160(C)U43A
			2000 A	R■F36200(C)U43A
			2500 A	R■F36250(C)U43A
			3000 A	R■F36300(C)U43A
LSIG	6.0A	600 A	R■F36060(C)U44A	
		800 A	R■F36080(C)U44A	
		1000 A	R■F36100(C)U44A	
		1200 A	R■F36120(C)U44A	
		1600 A	R■F36160(C)U44A	
		2000 A	R■F36200(C)U44A	
		2500 A	R■F36250(C)U44A	
		3000 A	R■F36300(C)U44A	
MicroLogic Interchangeable Power Trip Unit	LSI	5.0P	600 A	R■F36060(C)U63AE1
			800 A	R■F36080(C)U63AE1
			1000 A	R■F36100(C)U63AE1
			1200 A	R■F36120(C)U63AE1
			1600 A	R■F36160(C)U63AE1
			2000 A	R■F36200(C)U63AE1
			2500 A	R■F36250(C)U63AE1
			3000 A	R■F36300(C)U63AE1
	LSIG	6.0P	600 A	R■F36060(C)U64AE1
			800 A	R■F36080(C)U64AE1
			1000 A	R■F36100(C)U64AE1
			1200 A	R■F36120(C)U64AE1
			1600 A	R■F36160(C)U64AE1
			2000 A	R■F36200(C)U64AE1
			2500 A	R■F36250(C)U64AE1
			3000 A	R■F36300(C)U64AE1

[49] For 2P and 4P information see Catalog 0612CT0101.  
 [50] To complete the catalog number: Replace the ■ with the appropriate interrupting rating (G, J, K or L); For 100% rated circuit breakers, add a "C" in the 9th character place. For example, the catalog number for a 100% rated trip unit with LI trip functions at 2500 A would be RGF36025CU31A.

**Table 7.77 R-Frame 3000 A (600 Vac, 50/60 Hz) 3P Circuit Breaker with Electronic Trip Unit (cont'd.)**

Type	Electronic Trip Unit [51]		Sensor Rating	Cat. No. [52]
	Function	Trip Unit		
MicroLogic Interchangeable Harmonic Trip Unit	LSI	5.0H	600 A	R■F36060(C)U73AE1
			800 A	R■F36080(C)U73AE1
			1000 A	R■F36100(C)U73AE1
			1200 A	R■F36120(C)U73AE1
			1600 A	R■F36160(C)U73AE1
			2000 A	R■F36200(C)U73AE1
			2500 A	R■F36250(C)U73AE1
	3000 A	R■F36300(C)U73AE1		
	LSIG	6.0H	600 A	R■F36060(C)U74AE1
			800 A	R■F36080(C)U74AE1
			1000 A	R■F36100(C)U74AE1
			1200 A	R■F36120(C)U74AE1
			1600 A	R■F36160(C)U74AE1
			2000 A	R■F36200(C)U74AE1
2500 A			R■F36250(C)U74AE1	
3000 A	R■F36300(C)U74AE1			

**Unit-Mount R-Frame Standard Bus Connection**

R-frame circuit breakers can be bus- or cable-connected.

- For cable connections, an optional terminal pad kit RLTB or equivalent bus structure is required.
- RLTB kits comes standard with bus bar connections.

**RLTB / RT3B Kits**

- RLTB kits are included with 2500 A 100% rated circuit breakers.
- Each kit contains terminal pads for one end of the circuit breaker only
- Has provisions for mounting a maximum of 8 lugs per phase (9 lugs for 3000 A).
- RL3TB kits are included with the 3000 A, 80% and 100% rated circuit breakers.

R-Frame I-Line circuit breakers come with lugs on the load side. (See Panelboards—Section 9).

For other circuit breakers, order terminal pad kit (RLTB) and optional lugs separately. See [Terminal Nuts](#), [Terminal Pads](#), [Terminal Shields and Accessories](#), page 7-63 and [Mechanical Lugs](#), page 7-60.

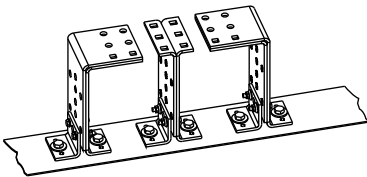

RLTB Terminal Pad Kit

[51] For 2P and 4P information see Catalog 0612CT0101.

[52] To complete the catalog number: Replace the ■ with the appropriate interrupting rating (G, J, K or L.); For 100% rated circuit breakers, add a "C" in the 9th character place. For example, the catalog number for a 100% rated trip unit with LI trip functions at 2500 A would be RGF36025CU31A.



PowerPac J-Frame

**PowerPac Mission Critical Circuit Breakers**

Delivering high levels of selective coordination in a flexible design that can be easily configured for a variety of applications.

- Adjustable long-time settings in three sensor sizes provide coverage from 70-600 A on 120-240, 208Y/120, 240, and 480Y/277 Vac systems
- Undergone rigorous testing procedures to certify the coordination with downstream circuit breakers
- Available in J-Frame (250A) and L-Frame (600A)
- UL 489 listed, CSA Certified Voltage: 480Y/277V

**Table 7.78: J-Frame 250 A Electronic Trip Mission Critical 80% Rated Circuit Breakers (480/277 Vac) with Factory Sealed Trip Units Suitable for Reverse Connection**

Electronic Trip Unit Type	Trip Function	Trip Unit	Continuous Current	Cat. No.				Terminal
				D Interrupting	G Interrupting	J Interrupting	L Interrupting	
Standard	LI	3.2 W	250 A	JDL34250WU31X	JGL34250WU31X	JJL34250WU31X	JLL34250WU31X	AL250JD [1]
Standard	LSI	3.2S-W	250 A	JDL34250WU33X	JGL34250WU33X	JJL34250WU33X	JLL34250WU33X	AL250JD [1]
High Perf. Ammeter	LSI	5.2A-W	250 A	JDL34250WU43X	JGL34250WU43X	JJL34250WU43X	JLL34250WU43X	AL250JD [1]
High Perf. Energy	LSI	5.2E-W	250 A	JDL34250WU53X	JGL34250WU53X	JJL34250WU53X	JLL34250WU53X	AL250JD [1]
High Perf. Ammeter	LSIG	6.2A-W	250 A	JDL34250WU44X	JGL34250WU44X	JJL34250WU44X	JLL34250WU44X	AL250JD [1]
High Perf. Energy	LSIG	6.2E-W	250 A	JDL34250WU54X	JGL34250WU54X	JJL34250WU54X	JLL34250WU54X	AL250JD [1]

**Table 7.79: L-Frame 600 A Electronic Trip Mission Critical Circuit Breakers (480/277 Vac) with Factory Sealed Trip Units Suitable for Reverse Connection [2]**

Electronic Trip Unit Type	Trip Function	Trip Unit	Continuous Current	Cat. No.				Terminal
				D Interrupting	G Interrupting	J Interrupting	L Interrupting	
480/277 Vac, 50/60 Hz, 3P								
Standard	LI	3.3 W	250 A	LDL34250WU31X	LGL34250WU31X	LJL34250WU31X	LLL34250WU31X	AL400L61K3 [3]
			400 A	LDL34400WU31X	LGL34400WU31X	LJL34400WU31X	LLL34400WU31X	AL600LS52K3 [4]
			600 A	LDL34600WU31X	LGL34600WU31X	LJL34600WU31X	LLL34300WU31X	AL400L61K3 [3]
Standard	LSI	3.3S-W	250 A	LDL34250WU33X	LGL34250WU33X	LJL34250WU33X	LLL34250WU33X	AL400L61K3 [3]
			400 A	LDL34400WU33X	LGL34400WU33X	LJL34400WU33X	LLL34400WU33X	AL600LS52K3 [4]
			600 A	LDL34600WU33X	LGL34600WU33X	LJL34600WU33X	LLL34300WU33X	AL600LS52K3 [4]
High Perf. Ammeter	LSI	5.3A-W	400 A	LDL34400WU43X	LGL34400WU43X	LJL34400WU43X	LLL34400WU43X	AL600LS52K3 [4]
			600 A	LDL34600WU43X	LGL34600WU43X	LJL34600WU43X	LLL34300WU43X	AL600LS52K3 [4]
			400 A	LDL34400WU53X	LGL34400WU53X	LJL34400WU53X	LLL34400WU53X	AL600LS52K3 [4]
High Perf. Energy	LSI	5.3E-W	600 A	LDL34600WU53X	LGL34600WU53X	LJL34600WU53X	LLL34300WU53X	AL600LS52K3 [4]
			400 A	LDL34400WU44X	LGL34400WU44X	LJL34400WU44X	LLL34400WU44X	AL600LS52K3 [4]
			600 A	LDL34600WU44X	LGL34600WU44X	LJL34600WU44X	LLL34300WU44X	AL600LS52K3 [4]
High Perf. Ammeter	LSIG	6.3A-W	400 A	LDL34400WU54X	LGL34400WU54X	LJL34400WU54X	LLL34400WU54X	AL600LS52K3 [4]
			600 A	LDL34600WU54X	LGL34600WU54X	LJL34600WU54X	LLL34300WU54X	AL600LS52K3 [4]
			400 A	LDL34400WU54X	LGL34400WU54X	LJL34400WU54X	LLL34400WU54X	AL600LS52K3 [4]
480/277 Vac, 50/60 Hz, 4P								
Standard	LI	3.3 W	250 A	LDL44250WU31X	LGL44250WU31X	LJL44250WU31X	LLL44250WU31X	AL400L61K4 [3]
			400 A	LDL44400WU31X	LGL44400WU31X	LJL44400WU31X	LLL44400WU31X	AL600LS52K4 [4]
			600 A	LDL44600WU31X	LGL44600WU31X	LJL44600WU31X	LLL44300WU31X	AL400L61K4 [3]
Standard	LSI	3.3S-W	250 A	LDL44250WU33X	LGL44250WU33X	LJL44250WU33X	LLL44250WU33X	AL400L61K4 [3]
			400 A	LDL44400WU33X	LGL44400WU33X	LJL44400WU33X	LLL44400WU33X	AL600LS52K4 [4]
			600 A	LDL44600WU33X	LGL44600WU33X	LJL44600WU33X	LLL44300WU33X	AL600LS52K4 [4]
High Perf. Ammeter	LSI	5.3A-W	400 A	LDL44400WU43X	LGL44400WU43X	LJL44400WU43X	LLL44400WU43X	AL600LS52K4 [4]
			600 A	LDL44600WU43X	LGL44600WU43X	LJL44600WU43X	LLL44300WU43X	AL600LS52K4 [4]
			400 A	LDL44400WU53X	LGL44400WU53X	LJL44400WU53X	LLL44400WU53X	AL600LS52K3 [4]
High Perf. Energy	LSI	5.3E-W	600 A	LDL44600WU53X	LGL44600WU53X	LJL44600WU53X	LLL44300WU53X	AL600LS52K3 [4]
			400 A	LDL44400WU44X	LGL44400WU44X	LJL44400WU44X	LLL44400WU44X	AL600LS52K4 [4]
			600 A	LDL44600WU44X	LGL44600WU44X	LJL44600WU44X	LLL44300WU44X	AL600LS52K4 [4]
High Perf. Ammeter	LSIG	6.3A-W	400 A	LDL44400WU54X	LGL44400WU54X	LJL44400WU54X	LLL44400WU54X	AL600LS52K4 [4]
			600 A	LDL44600WU54X	LGL44600WU54X	LJL44600WU54X	LLL44300WU54X	AL600LS52K4 [4]
			400 A	LDL44400WU54X	LGL44400WU54X	LJL44400WU54X	LLL44400WU54X	AL600LS52K4 [4]

**Table 7.80: Terminal Wire Ranges**

Terminal	Wire Range
AL250JD	(1) 3/0 AWG-350 kcmil AL or Cu
AL400L61K3	(1) #2 AWG-500 kcmil Al or (1) #2 AWG-600 kcmil Cu.
AL600LS52K3	(2) 2/0 AWG-500 kcmil Al or Cu.

Accessories see page 7-55  
 Optional Lugs see page 7-60  
 Compression and PDC Lugs see Supplemental Digest, Section 3  
 Dimensions see page 7-86  
 Enclosures see page 7-87

**Table 7.81: J- and L-Frame Termination Options**

Termination Letter	
A = I-Line (See Section 9)	J G L 3 6 1 0 0
F = No Lugs (includes terminal nut kit on both ends) [5]	For factory-installed termination, place termination letter in the third block of the circuit breaker catalog number.
L = Lugs both ends	Termination Letter
M = Lugs ON end Terminal Nut Kit OFF end	
P = Lugs OFF end Terminal Nut Kit ON end	
N = Plug-in	
D = Drawout	
S = Rear Connected	

**Table 7.82: J- and L-Frame Interrupting Ratings**

Voltage	Interrupting Rating			
	D	G	J	L
240 Vac	25 kA	65 kA	100 kA	125 kA
480 Vac	18 kA	35 kA	65 kA	100 kA

[1] AL250JD terminal wire range is (1) 3/0 AWG-350 kcmil Al or Cu.  
 [2] 100% rated for 250 A and 400 A. 80% rated for 600 A.  
 [3] AL400L61K3 terminal wire ranges are (1) #2 AWG-500 kcmil Al or (1) #2 AWG-600 kcmil Cu.  
 [4] AL600LS52K3 terminal wire ranges are (2) 2/0 AWG-500 kcmil Al or Cu.  
 [5] Add TS suffix for circuit breaker without terminal nut kit.

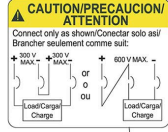

Connection Diagram

**Table 7.83: 500 Vdc Termination Options**

Termination Letter	Termination Option
F	No Lugs (bus bar connection)
L	Lugs Both Ends
S	Rear Connection

JGL37125D81—Place termination letter in third block of circuit breaker catalog number.

**PowerPacT 500 Vdc Circuit Breakers**

Designed for use on ungrounded dc systems having a maximum short-circuit voltage of 500 Vdc or a maximum floating (unloaded) voltage of 600 Vdc. Suitable for use only with UPS (ungrounded uninterruptible power supplies systems).

This two-level voltage rating allows these circuit breakers to be applied to battery sources having a short-circuit availability of 20,000 amperes or 50,000 amperes for PowerPacT H-, J-, and L-frame DC circuit breakers at 500 Vdc. IEC 500 Vdc rating is available on PowerPacT J-frame circuit breakers.

PowerPacT H-frame DC circuit breakers have a fixed magnetic trip system. PowerPacT J- and L-frame DC circuit breakers are provided with an adjustable magnetic trip that is readily accessible by means of a single adjustment on the face of the circuit breaker.

PowerPacT H- and J-frame circuit breakers are UL Listed for the interrupting ratings shown only if applied with three poles connected in series (series connection is external to circuit breaker). (See figure for example of diagram.)

PowerPacT L-frame circuit breakers are UL Listed for the interrupting ratings shown with two or three poles connected in series (series connection is external to circuit breaker).

**NOTE:** Due to external series connection, I-Line™ circuit breakers are not available for this application.

**Table 7.84: 500 Vdc Molded Case Circuit Breakers**

Ampere Rating	Circuit Breaker Cat. No.	Fixed Magnetic Trip —DC Amperes	Adjustable Magnetic Trip Range—DC Amperes [1]		Interrupting Rating @ 500 Vdc
			Low	High	
30 A	HGL37030D87	450	—	—	20 k AIR
50 A	HGL37050D87	450	—	—	
70 A	HGL37070D87	450	—	—	
100 A	JGL37100D81	—	400	600	20 k AIR
125 A	JGL37125D81	—	400	600	
150 A	JGL37150D81	—	400	600	
175 A	JGL37175D81	—	400	600	
200 A	JGL37200D82	—	500	850	
225 A	JGL37225D82	—	500	850	20 k AIR
250 A	JGL37250D82	—	500	850	
300 A	LGL37030D27	—	750	1500	
350 A	LGL37035D29	—	875	1750	
400 A	LGL37040D30	—	1000	2000	
450 A	LGL37045D31	—	1125	2250	
500 A	LGL37050D32	—	1250	2500	
600 A	LGL37060D33	—	1500	3000	
700 A	LGL47070D35	—	1750	3500	
800 A	LGL47080D36	—	2000	4000	
900 A	LGL47090D86	—	2250	4500	
1000 A	LGL47100D40	—	2500	5000	
1200 A	LGL47120D42	—	3000	6000	
30A	HLL37030D87	450	—	—	50 k AIR
50A	HLL37050D87	450	—	—	
70A	HLL37070D87	450	—	—	
100A	JLL37100D81	—	400	600	50 k AIR
125A	JLL37125D81	—	400	600	
150A	JLL37150D81	—	400	600	
175A	JLL37175D81	—	400	600	
200A	JLL37200D82	—	500	850	
225A	JLL37225D82	—	500	850	
250A	JLL37250D82	—	500	850	
300A	LLL37030D27	—	750	1500	
350A	LLL37035D29	—	875	1750	50 k AIR
400A	LLL37040D30	—	1000	200	
450 A	LLL36045D31	—	1125	2250	
500 A	LLL37050D32	—	1250	2500	
600 A	LLL37060D33	—	1500	3000	
700 A	LLL47070D35	—	1750	3500	
800 A	LLL47080D36	—	2000	4000	
900 A	LLL47090D86	—	2250	4500	
1000 A	LLL47100D40	—	2500	5000	
1200 A	LLL47120D42	—	3000	6000	

Accessories see page 7-55 and Supplemental Digest Section 3  
 Optional Lugs see page 7-60 and Supplemental Digest Section 3  
 Dimensions see page 7-86 and Supplemental Digest Section 3  
 Enclosures see page 7-90

[1] Magnetic trip tolerances are -20%/+30% from the nominal values shown.

PowerPacT Automatic Switches

Automatic molded case switches open instantaneously at a factory preset magnetic trip point. Calibrated to protect only the molded case switch itself, when it is subjected to high fault currents. The trip point is nonadjustable and provides no overload or low level fault protection.



J-Frame Switch



L-Frame Switch

- PowerPacT™ H-, J-, and L-frame automatic switches are available in unit mount, I-Line™, plug-in and drawout versions.
- Accept the same lugs and accessories as equivalent thermal-magnetic circuit breakers<sup>[1]</sup>.
- May be interlocked with another switch or circuit breaker to form a source-changeover system
- UL Listed per UL 489 and CSA Certified.

Table 7.85: PowerPacT™ B-Frame Automatic Molded Case Switches, 600 Vac

Circuit Breaker	Poles	Ampere Rating	D Withstand		G Withstand		J Withstand		Terminal	Wire Range
			Cat. No.	Trip Point	Cat. No.	Trip Point	Cat. No.	Trip Point		
B-Frame	2 [2]	125 A	BDL26000S12	1625 A	BGL26000S12	1625 A	BJL26000S12	1625 A	LV426973	14–2/0 AWG Cu
	3	125 A	BDL36000S12	1625 A	BGL36000S12	1625 A	BJL36000S12	1625 A	LV426974	14–2/0 AWG Cu

Table 7.86: H-, J-, and L-Frame PowerPacT™ Automatic Molded Case Switches, 600 Vac

Circuit Breaker	Poles	Ampere Rating	G Withstand		L Withstand		R Withstand		Terminal	Wire Range
			Cat. No.	Trip Point	Cat. No.	Trip Point	Cat. No.	Trip Point		
H-Frame J-Frame	2	150 A	HGL26000S15 [2]	2250 A	HLL26000S15	2250 A	—	—	AL150HD	14 AWG–3/0 AWG Al/Cu
		175 A	JGL26000S17	3125 A	JLL26000S17	3125 A	—	—	AL175JD	4–4/0 AWG Al/Cu
		250 A	JGL26000S25	3125 A	JLL26000S25	3125 A	—	—	AL250JD	3/0 AWG–350 kcmil Al/Cu
		150 A	HGL36000S15	2250 A	HLL36000S15	2250 A	—	—	AL150HD	14 AWG–3/0 AWG Al/Cu
L-Frame	3	175 A	JGL36000S17	3125 A	JLL36000S17	3125 A	JRL36000S17	3125 A	AL175JD	4–4/0 AWG Al/Cu
		250 A	JGL36000S25	3125 A	JLL36000S25	3125 A	JRL36000S25	3125 A	AL250JD	3/0 AWG–350 kcmil Al/Cu
		400 A	LGL36000S40X	4800 A	LLL36000S40X	4800 A	LRL36000S40X	4800 A	AL150HD	AL600LS2K3
		600 A	LGL36000S60X	6600 A	LLL36000S60X	6600 A	LRL36000S60X	6600 A	AL250JD	(2) 2/0 AWG–500 kcmil Al/Cu
L-Frame	4	400 A	LGL46000S40X	4800 A	LLL46000S40X	4800 A	LRL46000S40X	4800 A	AL150HD	AL600LS2K4
		600 A	LGL46000S60X	6600 A	LLL46000S60X	6600 A	LRL46000S60X	6600 A	AL250JD	(2) 2/0 AWG–500 kcmil Al/Cu

Table 7.87: P-Frame and R-Frame PowerPacT™ Automatic Molded Case Switches [3], 600 Vac

Frame	Poles	Ampere Rating	J Withstand		K Withstand		L Withstand		Terminal	Wire Range
			Cat. No.	Trip Point	Cat. No.	Trip Point	Cat. No.	Trip Point		
M	2	800 A	MJL26000S80	10 kA	—	—	—	—	AL800M23K	(3) 3/0 AWG–500 kcmil Al or Cu
	3	800 A	MJL36000S80	10 kA	—	—	—	—	AL800M23K	(3) 3/0 AWG–500 kcmil Al or Cu
P	2	600 A	PJL26000S60	10 kA	PKL26000S60	24 kA	PLL24000S60 [4]	10 kA	AL800M23K	(3) 3/0 AWG–500 kcmil Al or Cu
		800 A	PJL26000S80	10 kA	PKL26000S80	24 kA	PLL24000S80 [4]	10 kA		
		1000 A	PJL26000S10	10 kA	PKL26000S10	24 kA	PLL24000S10 [4]	10 kA		
	3	1200 A	PJL26000S12	10 kA	PKL26000S12	24 kA	PLL24000S12 [4]	10 kA	AL1200P25K	(4) 3/0 AWG–500 kcmil Al or Cu
		600 A	PJL36000S60	10 kA	PKL36000S60	24 kA	PLL34000S60 [4]	10 kA		
		800 A	PJL36000S80	10 kA	PKL36000S80	24 kA	PLL34000S80 [4]	10 kA		
R	2	1000 A	PJL36000S10	10 kA	PKL36000S10	24 kA	PLL34000S10 [4]	10 kA	AL1200P25K	(4) 3/0 AWG–500 kcmil Al or Cu
		1200 A	PJL36000S12	10 kA	PKL36000S12	24 kA	PLL34000S12 [4]	10 kA		
		1200 A	—	—	RKF26000S12	57 kA	RLF26000S12	48 kA		
	3	1600 A	—	—	RKF26000S16	57 kA	RLF26000S16	48 kA		
		2000 A	—	—	RKF26000S20	57 kA	RLF26000S20	48 kA		
		2500 A	—	—	RKF26000S25	57 kA	RLF26000S25	48 kA		
		1200 A	—	—	RKF36000S12	57 kA	RLF36000S12	48 kA		
		1600 A	—	—	RKF36000S16	57 kA	RLF36000S16	48 kA		
		2000 A	—	—	RKF36000S20	57 kA	RLF36000S20	48 kA		
2500 A	—	—	RKF36000S25	57 kA	RLF36000S25	48 kA				
3000 A	—	—	RKF36000S30	57 kA	RLF36000S30	48 kA				

R-frame circuit breakers can be bus-connected or cable-connected. For cable connections, RLTB kit or equivalent bus structure is required. Kit is included with 3000 A switches. For all others, see page 7-63.

Table 7.88: Q-Frame (240 Vac) PowerPacT™ Automatic Molded Case Switches

Circuit Breaker	Poles	Ampere Rating	J Withstand		Wire Range
			Cat. No.	Trip Point	
Q-Frame [5]	2	225 A	QBL22000S22	4500 A	4 AWG–300 kcmil
	3	225 A	QBL32000S22	4500 A	

Table 7.89: B-, H-, J-, L- P-, and R-Frame Withstand Ratings [6]

Voltage	Withstand					
	D	G	J	K	L	R
240 Vac	25 kA	65 kA	100 kA	65 kA	125 kA	200 kA
480 Vac	18 kA	35 kA	65 kA	50 kA [7]	100 kA	200 kA
600 Vac	14 kA	18 kA	25 kA	50 kA [7]	50 kA	100 kA

Accessories see page 7-55 and Supplemental Digest Section 3  
Optional Lugs see page 7-60 and Supplemental Digest Section 3  
Dimensions see page 7-85 and page 7-86  
Enclosures see page 7-87

[1] Q-frame switches do not have electrical accessories available.

[2] True 2P device. Others are a 2P in a 3P module.

[3] UL magnetic trip tolerances are -20% / +30% from the nominal values shown.

[4] P-frame L-interrupting is available in 480 Vac only.

[5] Withstand rating of 10 kA at 240 Vac.

[6] The withstand rating is the fault current at rated voltage that the molded case switch will withstand without damage when protected by a circuit breaker with an equal continuous current rating.

[7] B- and R-frame withstand is 65 kA.





**Instantaneous Trip Circuit Breakers for Motor Protection Applications**

Adjustable instantaneous-trip circuit breakers are intended for use in combination with motor starters with overload relays for the protection of motor circuits from short circuits.

Other specific applications include rectifiers and resistance welders. These circuit breakers contain a magnetic trip element in each pole with the trip point adjustable from the front. Interrupting ratings are determined by testing the instantaneous-trip circuit breakers in combination with a contactor and overload relay.

Select instantaneous-trip circuit breakers as follows:

This selection table is suitable for motors, other than NEMA Design E, with locked-rotor indicating code letters per NEC® Table 430.7 (b) as follows:

**Table 7.90: Locked-Rotor Indicating Codes**

Horsepower	Motor Code Letter
1/2 or less	A-L
3/4 to 1-1/2	A-K
2 to 3	A-J
5 to 25	A-H
30 to 125	A-G
150 or more	A-F

- For other motors order a special thermal-magnetic circuit breaker with magnetic trip settings for the specific motor— specify motor horsepower, voltage, frequency, full-load current and code letter or locked rotor current.
- Determine motor hp rating from the motor nameplate.
- Refer to the tables and select an instantaneous-trip circuit breaker with an ampere rating recommended for the hp and voltage involved.
- Select an adjustable trip setting of at least 800%, not to exceed 1300%, of the motor full-load amperes (FLA) for other than Design E motors. For Design E motors, select an adjustable trip setting of at least 1100% not to exceed 1700% of FLA.
- The NEC 1300% maximum setting may be inadequate for instantaneous-trip circuit breakers to withstand current surges typical of the magnetization current of autotransformer type reduced voltage starters, or open transition wye-delta starters during transfer from “start” to “run,” constant hp multi-speed motors, and motors labeled “high efficiency.” Select thermal-magnetic circuit breakers for those applications.
- Part-winding motors, per NEC 430.4, should have two circuit breakers selected from the above at not more than one half the allowable trip setting for the horsepower rating. The two circuit breakers should operate simultaneously as a disconnecting means per NEC 430.103.
- Based on NEC 430.52 and NEC Table 430.250.

**Table 7.91: Selection Tables for Conductors, Safety Switches and Thermal-Magnetic Circuit Breakers**  
Based on 2017 NEC® Tables 430.247, 430.248 & 430.250

Horsepower Ratings										Full Load Amperage [1]	Amperage of Thermal-Magnetic [2] Inverse Time Circuit Breaker			QMB and Heavy Duty Switch with Time Delay Fuses [3]	Minimum Size metallic Conduit 75° C, C Wire Field-Installed Sized for 125% FLA [4]		
Squirrel-Cage and Wound-Rotor Motors with Norm. Torque Characteristics Operating at Usual Speeds				1Ø 10 Hz ac			Average Direct Current Motors Operating at Base Speed		Ordinary Service [6]		Heavy Service and Energy Efficient [7]	For Motor Code Letter F to V [5]	AWG kcmil		Conduit 3 W		
3Ø 60 Hz				115 Vac	200 Vac [8]	230 Vac	120 Vdc	240 Vdc							THHN THWN XHHW	THW	
200 Vac [8]	230 Vac	460 Vac	575 Vac														
						3/4			6.9 A								
				1/3					7.2 A		15 A						
		5						3.4	7.6 A			20 A					
2									7.8 A								
					3/4				7.9 A								
						1			8.0 A		15 A						
								2	8.5 A			20 A					
			7-1/2						9.0 A								
					1				9.2 A								
							1		9.5 A			25 A					
	3								9.6 A								
				1/2					9.8 A								
						1-1/2			10.0 A								
3		7-1/2	10						11.0 A		20 A						
					1-1/2				11.5 A			30 A					
						2			12.0 A								
								3	12.2 A								
							1-1/2		13.2 A								
				3/4	2				13.8 A		25 A						
		10							14.0 A								
	5								15.2 A								
				1					16.0 A		30 A						
			15			3	2		17.0 A								
5									17.5 A								
					3				19.6 A		35 A						
				1-1/2					20.0 A								
		15							21.0 A								
	7-1/2								22.0 A		40 A						
				2					24.0 A								
								3	25.0 A		45 A						
7-1/2									25.3 A								
		20	25						27.0 A		50 A						
	10					5			28.0 A								
								7-1/2	29.0 A								
			30						32.0 A		60 A						
10									32.2 A								
		25		3					34.0 A		60 A						
								7-1/2	38.0 A								
								5	40.0 A		80 A						
									41.0 A								
	15								42.0 A								
				7-1/2					46.0 A								
15									48.3 A								
								10	50.0 A		90 A						
		40	50						52.0 A								
	20								54.0 A								
								15	55.0 A								
				5					56.0 A			150 A					
					10				57.5 A								
								7-1/2	58.0 A								
			60						62.0 A								
20									62.1 A		100 A						
		50							65.0 A								
	25								68.0 A								
								20	72.0 A								
								10	76.0 A								
		60	75						77.0 A								
									78.2 A								
25				7-1/2					80.0 A		110 A						
	30								89.0 A		125 A						
												225 A	200 A	2	1 in.	1-1/4 in.	

[1] Motor full load currents thru 200 hp are taken from NEC Tables 430.247, 248 and 250. Above 200 hp from UL 98. Select wire size, circuit breakers, or fuses on basis of hp rather than nameplate full load current per NEC 430.6. Do not use these values to select overload relay thermal units. See Digest pages 16-129—16152 for selection of thermal units when actual full load current is not known. Voltages listed are rated motor voltages. Corresponding nominal system voltages are 110–120 V, 200–208 V, 220–240 V, 440–480 V and 550–600 V

[2] Thermal-magnetic circuit breaker ampere ratings recommended are approximate for average conditions, based on trip characteristics of Square D circuit breakers and NEC Table 430.52. Under some conditions, the next size larger switch or circuit breaker rating may be necessary to accommodate the motor starting current and is permitted by NEC 430.52(C)(1) Exception 2. High starting currents are anticipated with Design E and other energy efficient motors. For explanation of Code letter markings, see NEC 430.7(B). For Busway Plug-in units, see page 9-7.

[3] Switch size only is shown in table. Selected fuses should not exceed maximum percent of full-load current as given in NEC Table 430.52. Above 50 hp dc switches are not hp rated by UL as Motor Circuit Switches, but as General Use Switches only and are not necessarily capable of interrupting the max. operating overload current of a motor. See NEC 100 for definition of General Use Switch. When protecting a 3Ø, Design E energy efficient motor, the switch is required by NEC 430.109 to have a hp rating of not less than 1.4 times that of a motor rated 3–100 hp, or not less than 1.3 times that of a motor rated over 100 hp. Switches shown in this table do not necessarily comply with that requirement.

[4] NEC 430.22 for Single Motor. Smaller conductors may be permitted for light duty-cycle service per 430.22 (B) Exception No. 1. DC motors operating from rectified 1Ø power supply will require larger conductors per 430.22 (A) Exception No. 1. For motor-generator arc welders, see 630.11

[5] Thermal-magnetic breaker ampere ratings recommended are approximate for average conditions and based on trip characteristics of Square D circuit breakers and NEC Tables 430.7(B) and 430.52.

[6] Ordinary service for normal starting duty only, acceleration time of 10 sec. or less.

[7] Heavy service is jogging or plugging duty or cycling load with over 25 starts per hour or over 5 starts per minute. Energy efficient motors are polyphase motors defined in NEMA Standard MG1 and exhibit high starting current.

[8] 200 V motors are commonly used on 208 V services.

[9] 8 XHHW requires 3/4 in. conduit for 3W.

**Table 7.91 Selection Tables for Conductors, Safety Switches and Thermal-Magnetic Circuit Breakers Based on 2017 NEC® Tables 430.247, 430.248 & 430.250 (cont'd.)**

Horsepower Ratings										Amperage of Thermal-Magnetic [11] Inverse Time Circuit Breaker			QMB and Heavy Duty Switch with Time Delay Fuses [12]	Minimum Size metallic Conduit 75° C, C Wire Field-Installed Sized for 125% FLA [13]		
Squirrel-Cage and Wound-Rotor Motors with Norm. Torque Characteristics Operating at Usual Speeds 3Ø 60 Hz				1Ø 10 Hz ac			Average Direct Current Motors Operating at Base Speed		Full Load Amperage [10]	For Motor Code Letter B to E		For Motor Code Letter F to V [14]		AWG kcmil	Conduit 3 W	
200 Vac [17]	230 Vac	460 Vac	575 Vac	115 Vac	200 Vac [17]	230 Vac	120 Vdc	240 Vdc		Ordinary Service [15]	Heavy Service and Energy Efficient [16]				THHN THWN XHHW	THW
30									92.0 A							
		75							96.0 A							
			100						99.0 A							
				10					100.0 A	150 A	200 A	250 A	1	1-1/4 in.	1-1/2 in.	
	40								104.0 A		225 A	300 A				
40								30	106.0 A	175 A			1/0	1-1/4 in.	1-1/2 in.	
									120.0 A		250 A					
		100							124.0 A		250 A	350 A	2/0	1-1/2 in.	1-1/2 in.	
			125						125.0 A							
	50								130.0 A							
								40	140.0 A	200 A	300 A					
			150						144.0 A							
50									150.0 A				3/0	1-1/2 in.	2 in.	
	60								154.0 A			400 A				
		125							156.0 A	225 A	350 A					
								50	173.0 A							
60									177.0 A				4/0	2 in.	2 in.	
		150							180.0 A	250 A	400 A	500 A				
	75		200						192.0 A				250	2 in.	2 in.	
									221.0 A	300 A	450 A	600 A	300	2 in.	2-1/2 in.	
		200							240.0 A							
			250						242.0 A	350 A	500 A	700 A	350	2-1/2 in.	2-1/2 in.	
	100								248.0 A							
100									285.0 A							
			300						289.0 A	400 A	600 A	800 A	500	3 in.	3 in.	
		250							302.0 A							
	125								312.0 A	450 A	700 A		(2) 3/0	(2) 2-1/2 in.	(2) 2 in.	
			350						336.0 A	500 A						
125									359.0 A							
	150								360.0 A				(2) 4/0	(2) 2 in.	(2) 2 in.	
		300							361.0 A	600 A	800 A	1000 A				
			400						382.0 A							
150		350							414.0 A		900 A		(2)300	(2) 2 in.	(2) 2-1/2 in.	
				500					472.0 A			1200 A				
			400						477.0 A	800 A	1000 A		(2) 350	(2) 2-1/2 in.	(2) 2-1/2 in.	
		200							480.0 A							
200									552.0 A							
		500							590.0 A		1200 A	1600 A	—	(3) 300	(3) 2 in.	(3) 2-1/2 in.
	250								602.0 A	900 A						

Contact your local Field Office for circuit breaker selection on constant horsepower multi-speed motors.

[10] Motor full load currents thru 200 hp are taken from NEC Tables 430.247, 248 and 250. Above 200 hp from UL 98. Select wire size, circuit breakers, or fuses on basis of hp rather than nameplate full load current per NEC 430.6. Do not use these values to select overload relay thermal units. See Digest pages 16-129—16152 for selection of thermal units when actual full load current is not known. Voltages listed are rated motor voltages. Corresponding nominal system voltages are 110–120 V, 200–208 V, 220–240 V, 440–480 V and 550–600 V

[11] Thermal-magnetic circuit breaker ampere ratings recommended are approximate for average conditions, based on trip characteristics of Square D circuit breakers and NEC Table 430.52. Under some conditions, the next size larger switch or circuit breaker rating may be necessary to accommodate the motor starting current and is permitted by NEC 430.52(C)(1) Exception 2. High starting currents are anticipated with Design E and other energy efficient motors. For explanation of Code letter markings, see NEC 430.7(B). For Busway Plug-in units, see page 9-7.

[12] Switch size only is shown in table. Selected fuses should not exceed maximum percent of full-load current as given in NEC Table 430.52. Above 50 hp dc switches are not hp rated by UL as Motor Circuit Switches, but as General Use Switches only and are not necessarily capable of interrupting the max. operating overload current of a motor. See NEC 100 for definition of General Use Switch. When protecting a 3Ø, Design E energy efficient motor, the switch is required by NEC 430.109 to have a hp rating of not less than 1.4 times that of a motor rated 3–100 hp, or not less than 1.3 times that of a motor rated over 100 hp. Switches shown in this table do not necessarily comply with that requirement.

[13] NEC 430.22 for Single Motor. Smaller conductors may be permitted for light duty-cycle service per 430.22 (B) Exception No. 1. DC motors operating from rectified 1Ø power supply will require larger conductors per 430.22 (A) Exception No. 1. For motor-generator arc welders, see 630.11

[14] Thermal-magnetic breaker ampere ratings recommended are approximate for average conditions and based on trip characteristics of Square D circuit breakers and NEC Tables 430.7(B) and 430.52.

[15] Ordinary service for normal starting duty only, acceleration time of 10 sec. or less.

[16] Heavy service is jogging or plugging duty or cycling load with over 25 starts per hour or over 5 starts per minute. Energy efficient motors are polyphase motors defined in NEMA Standard MG1 and exhibit high starting current.

[17] 200 V motors are commonly used on 208 V services.

Accessories see page 7-55 and Supplemental Digest Section 3  
Optional Lugs see page 7-60 and Supplemental Digest Section 3  
Dimensions see page 7-86  
Enclosures see page 7-87

**PowerPacT Motor Protector Circuit Breakers—Two Device Solutions**

MicroLogic 2.2M and 2.3M trip units provide built-in thermal and magnetic protections. Use PowerPacT Motor Protect Circuit Breakers in two-device motor feeder solutions to provide protection against short-circuits, overloads, and phase unbalance.

- Protection settings are made using a rotary switch.
- Accept the same accessories and terminals as equivalent PowerPacT circuit breakers.
- UL, CSA, NOM, IEC, CCC certified, and UKCA and CE marked for global acceptance.

**Table 7.92: H-Frame (150 A), J-Frame (250 A) and L-Frame (600 A) Electronic Motor Protector Circuit Breakers (UL Ratings)—Two Device Solutions [10]**

Electronic Trip Unit Type	Frame	Sensor Rating	Trip Unit	Full Load Amperes Range (FLA)	Isd (x FLA)	Interrupting Rating			
						G	J	L	R
Standard [11]	H-Frame	30	2.2 M	14–25	5-13 x FLA	HGL36030M38X	HJL36030M38X	HLL36030M38X	HRL36030M38X
		50		14–42	5-13 x FLA	HGL36050M38X	HJL36050M38X	HLL36050M38X	HRL36050M38X
		100		30–80	5-13 x FLA	HGL36100M38X	HJL36100M38X	HLL36100M38X	HRL36100M38X
		150		58–130	5-13 x FLA	HGL36150M38X	HJL36150M38X	HLL36150M38X	HRL36150M38X
		250		114–217	5-13 x FLA	JGL36250M38X	JLJ36250M38X	JLL36250M38X	JRL36250M38X
		400		190–348	5-13 x FLA	LGL36400M38X	LJL36400M38X	LLL36400M38X	LRL36400M38X
	L-Frame	600	312–520	5-13 x FLA	LGL36600M38X	LJL36600M38X	LLL36600M38X	LRL36600M38X	

To select combination starters and motor controllers using MCP's meeting NEC Article 430, refer to Section 16.

**PowerPacT H, J, and L-Frame Motor Protectors**

**Table 7.93: Application of PowerPacT H- and L-Frame Motor Protector Circuit Breaker**

200 Vac	Hp Ratings of Induction Type Squirrel-Cage and Wound Rotor Motors 3Ø 60 Hz			Full Load Amperes [12]	PowerPacT Family Motor Protector Circuit Breaker Cat. No. [13]	Magnetic Trip Settings [14]	
	230 Vac	460 Vac	575 Vac			MIN	MAX
		10		14	H(L)JL36030M38X	500%	1300%
	5			15.2	H(L)JL36030M38X		
			15	17	H(L)JL36030M38X		
5				17.5	H(L)JL36030M38X		
		15		21	H(L)JL36030M38X		
	7-1/2		20	22	H(L)JL36030M38X		
				25.3	H(L)JL36030M38X	500%	1300%
		20	25	27	H(L)JL36050M38X		
	10			28	H(L)JL36050M38X		
			30	32	H(L)JL36050M38X		
10				32.2	H(L)JL36050M38X		
		25		34	H(L)JL36050M38X		
		30		40	H(L)JL36050M38X	500%	1300%
			40	41	H(L)JL36050M38X		
	15			42	H(L)JL36050M38X		
			40	48.3	H(L)JL36100M38X		
15		40	50	52	H(L)JL36100M38X		
	20			54	H(L)JL36100M38X		
			60	62	H(L)JL36100M38X	500%	1300%
20		50		65	H(L)JL36100M38X		
					J(L)JL36250M38X		
75				221	L(L)JL36400M38X		
		200		240	L(L)JL36400M38X		
			250	242	L(L)JL36400M38X		
	100			248	L(L)JL36400M38X	500%	1300%
100				285	L(L)JL36400M38X		
			300	289	L(L)JL36400M38X		
		250		302	L(L)JL36400M38X		
	125			312	L(L)JL36400M38X		
			350	336	L(L)JL36400M38X		
	125			359	L(L)JL36600M38X	500%	1300%
		150		360	L(L)JL36600M38X		
			300	361	L(L)JL36600M38X		
			400	382	L(L)JL36600M38X		
150		350		414	L(L)JL36600M38X		
			500	472	L(L)JL36600M38X		
		400		477	L(L)JL36600M38X	500%	1300%
	200			480	L(L)JL36600M38X		



HJL36100M38X Motor Circuit Protector

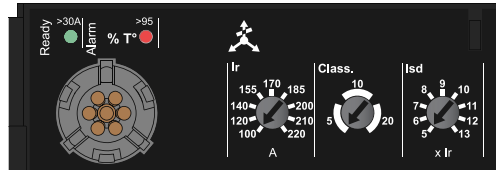

MicroLogic 2.2M and 2.3M Trip Units

**Ii=4800A**

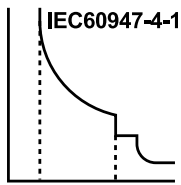

[10] Two-device solutions (these electronic motor protector circuit breakers include short circuit and overload protection)

- 1 electronic motor circuit protector with a MicroLogic 2.2 M plus
- 1 contactor

[11] The standard trip unit offers Class 5, 10 and 20 and phase unbalance or phase loss protection.

[12] Motor full-load currents are taken from NEC Table 430.250. Select wire and circuit breakers on basis of horsepower rather than nameplate full-load current per NEC 430.6 (A) for general motor applications. Do not use these values to select overload relay thermal units. See Digest Section 14 for selection of thermal units when actual full load current is not known. The voltages listed are rated motor voltages. Corresponding nominal system voltages are 200–208, 220–240, 440–480 and 550–600 V.

[13] To complete catalog number, replace the blank with the appropriate rating (G, J, L or R).

[14] Only MIN and MAX settings are shown, intermediate settings are available on all circuit breakers.

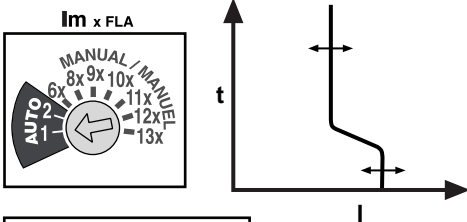
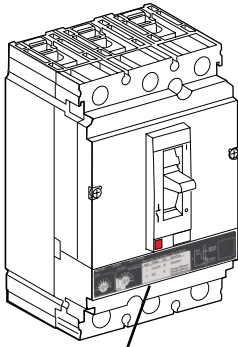

Motor Type / Tipo de Motor / Type de Moteur			
Auto	NEMA	IEC	Type/Tipo
1	A, B, C, D	N	Standard
2	B, E	H	Energy Efficient Energie Efficace Energia Efficente

**Motor Circuit Protection Selection**

PowerPact H- and J-frame electronic Motor Circuit Protectors (MCP) are magnetic-only instantaneous-trip circuit breakers. They are designed to offer short circuit protection and are National Electrical Code (NEC) compliant when installed as part of a combination controller having motor overload protection. MCP circuit breakers accept the same accessories and terminals as the equivalent thermal-magnetic circuit breakers.

Determine the hp rating from the nameplate of the motor. Select a MCP with an ampere rating recommended for the hp and voltage involved. When using the automatic settings the MCP microprocessor automatically adjusts the trip settings for both current and time to align with the start-up characteristic for the motor type, whether it is a standard or energy-efficient motor. This includes a dampening means to accommodate a transient motor in-rush current without nuisance tripping of the circuit breaker.

**Table 7.94: H- and J-Frame Electronic Motor Circuit Protectors (MCP)**

Frame	Sensor Rating	Full Load Amperes Range	Adjustable Instantaneous Trip Range	Suffix	J (See SCCR Cat. No. Table Below)	L (See SCCR Cat. No. Table Below)	R (See SCCR Cat. No. Table Below)
H-Frame	30 A	1.5–25 A	9–325 A	M71	HJL36030-M71	HLL36030-M71	HRL36030M71
	50 A	14–42 A	84–546 A	M72	HJL36050-M72	HLL36050-M72	HRL36050M72
	100 A	30–80 A	180–1040 A	M73	HJL36100-M73	HLL36100-M73	HRL36100M73
	150 A	58–130 A	348–1690 A	M74	HJL36150-M74	HLL36150-M74	HRL36150M74
J-Frame	250 A	114–217 A	684–2500 A	M75	JLL36250-M75	JLL36250-M75	JRL36250M75

**Table 7.95: Maximum Rating or Setting of Motor Protective Devices [15]**

Type of Motor	Percentage of Full-load Current		
	Setting	Not to Exceed [16]	
A, B, C, D	Standard	800%	1300%
B, E	Energy Efficient	1100%	1700%

**Table 7.96: MCP Selection by HP Ratings [17] of Induction-type Squirrel-Cage and Wound-Rotor Motors [18]**

3Ø60 Hz Voltages [19]				Full-Load Amperes	Suffix
200 Vac	230 Vac	460 Vac	575 Vac		
5–5	5–7.5	.75–15	1–20	1.5–25	M71
5–10	5–15	10–30	15–40	14–42	M72
10–25	15–30	25–60	30–75	30–80	M73
20–40	25–50	50–100	60–125	58–130	M74
40–60	50–75	100–150	125–200	114–217	M75

**Short Circuit Current Rating (SCCR)**

Tested to meet NEC and UL508A requirements for short circuit current ratings as part of an approved combination controller.

**Table 7.97: Short Circuit Current Ratings (SCCR)**

Contactor/Starter	Interrupting Rating					
	J			L		
	200–240 Vac	480 Vac	600 Vac	200–240 Vac	480 Vac	600 Vac
Tesys D-line and F-line	100 kA	65 kA	25 kA	125 kA	100 kA	50 kA
NEMA Type S	100 kA	65 kA	25 kA	125 kA	100 kA	50 kA

See www.us.schneider-electric.us for specific ratings and combination ID numbers.

To select combination starters and motor controllers using MCP's Meeting NEC Article 430, refer to Section 16.

Accessories see page 7-55  
Lugs see page 7-60  
Dimensions see page 7-86  
Enclosures see page 7-87

**H-, J-Frame Motor Circuit Protectors**

**Table 7.98: Application of PowerPact™ H-Frame and J-Frame Electronic Motor Circuit Protectors (MCP)**

Starter Size	Horsepower Rating of Induction-Type Squirrel-Cage and Wound-Rotor Motors 3Ø 60 Hz				NEC Full Load Amperes	PowerPact H-Frame and J-Frame Electronic MCP
	200 Vac	230 Vac	480 Vac	575 Vac		
00			1/2	1/2	0.9 A	HJL36030M71 and HLL36030M71 1/2–10 hp
				3/4	1.1 A	
					1.3 A	
			3/4	1	1.7 A	

[15] Based on 2015 NEC Table 430.52.

[16] See NEC Exception No. 1 to Table 430.52. The NEC 1300% maximum setting may be inadequate for instantaneous trip circuit breakers to withstand current surges typical of the magnetization current of autotransformer type reduced voltage starters, or open transition wye-delta starters during transfer from "start" to "run," constant hp multi-speed motors, and motors labeled "high efficiency."

[17] Based on 2005 NEC Table 430.250.





[18] Per NEC 430.3, part-winding motors should select two circuit breakers, each at not more than one-half the allowable trip setting for the horsepower rating. The two circuit breakers should operate simultaneously as a disconnecting means per NEC 430.103.

[19] Listed voltages are rated motor voltages. Corresponding system voltages are 200 Vac, 220–240 Vac, 440–480 Vac and 550–600 Vac. Select wire and circuit breakers based on horsepower rather than nameplate full-load current per NEC 430.6 (A) for general motor applications.



PowerPacT Accessories

Table 7.99: Electrical Accessories

Accessory	Description	Rated Voltage	B-, H-, J-, and L-Frame					M-, P-, and R-Frame			
			Factory Installed Cat. Suffix	B-Frame		H- and J-Frame	L-Frame	Factory Installed Cat. Suffix	Field-Installable Cat. No.		
				Field-Installable Cat. No.	Field-Installable Pre-Wired Cat. No.	Field-Installable Cat. No.	Field-Installable Cat. No.				
 <p>Auxiliary and Alarm Switches (OF, SD, SDE)</p> <p>B-Frame</p> <p>H-, J-, L-, M-, P, and R-Frame</p>	<p>Provides circuit breaker contact status. Note: The location of the accessory in the circuit breaker determines its function.</p>	<p>Standard Min Load = 10mA with 24V</p> <p>Low Level Min Load = 1mA with 24V</p>	1 auxiliary switch (OF) 1a1b	AA	LV426950	LV426951	S29450	S29450	AA	S29450	
			2 auxiliary switch (OF) 2a2b	AB	—	—	2x S29450	2x S29450	AB	2x S29450	
			3 auxiliary switch (OF) 3a3b	AC	—	—	—	3x S29450	3x S29450	AC	3x S29450
			Alarm Switch (SD) 1a1b	BC	LV426950	LV426952	S29450	S29450	BC	S29450	
			Overcurrent trip switch (SDE) 1a1b	BD	—	—	—	S29450	BD	S29450	
			Consisting of:	OF Switch	—	—	—	S29450	—	—	
				SDE Adapter	—	—	—	S29451	—	—	
			Alarm switch and Overcurrent trip switch	BE	—	—	—	2x S29450	BE	2x S29450	
			Consisting of:	OF Switch	—	—	—	2x S29450	—	—	
				SDE Adapter	—	—	—	S29451	—	—	
			Auxiliary Switch/Alarm Switch/Adapter (OF/SD/SDE) Kit	—	—	—	—	—	—	S33801 [1]	
			One auxiliary switch (OF) 1a1b	AE	—	—	S29452	S29452	AE	S29452	
			Two auxiliary switches (OF) 2a2b	AF	—	—	2x S29452	2x S29452	AF	2x S29452	
			3 auxiliary switches (OF) 3a3b	AG	—	—	—	3x S29452	AG	3x S29452	
			Alarm Switch (SD) 1a1b	BH	—	—	S29452	S29452	BH	S29452	
Overcurrent trip switch (SDE) 1a1b	BJ	—	—	—	S29452	BJ [2]	S29452				
Consisting of:	OF Switch	—	—	—	S29452	—	—				
	SDE Adapter	—	—	—	S29451	—	—				
Alarm switch and Overcurrent trip switch	BK	—	—	—	2x S29452	BK [2]	2x S29452				
Consisting of:	OF Switch	—	—	—	2x S29452	—	—				
	SDE Adapter [3]	—	—	—	S29451	—	—				
 <p>Shunt Trip (MX)</p> <p>B-Frame</p> <p>H-, J-, and L-Frame</p>	<p>Trips the circuit breaker from a remote location by means of a trip coil energized from a separate supply voltage circuit.</p>	<p>AC</p> <p>DC</p>	24	SK	LV426841	LV426861	P29384	P29384	SK	S33659	
			48	SL	LV426842	LV426862	P29385	P29385	SL	S33660	
			110–130	SA	LV426843	LV426863	P29386	P29386	SA	S33661	
			220–240	SD, SF	—	—	—	—	SC	S33662	
			208–277	SD	LV426844	LV426864	P29387	P29387	SD	S33663	
			380–480	SH	LV426846	LV426866	P29388	P29388	SH	S33664	
			525–600	SJ	—	—	P29389	P29389	—	—	
			12	SN	LV426850	—	P29382	P29382	SN	—	
			24	SO	LV426841	LV426861	P29390	P29390	SK	S33659	
			30	SU	—	—	P29391	P29391	SK	S33659	
			48	SP	LV426842	LV426862	P29392	P29392	SL	S33660	
			60	SV	—	—	P29383	P29383	SL	S33660	
			125	SR	LV426843	LV426863	P29393	P29393	SA	S33661	
			250	SS	LV426844	LV426864	P29394	P29394	SC	S33662	
			 <p>Undervoltage Trip (MN)</p> <p>H-, J-, and L-Frame</p>	<p>Instantaneously opens the circuit breaker when the under-voltage trip supply voltage drops to a value between 35% and 70% of its rated voltage. Closing is allowed when the supply voltage of the undervoltage trip reaches 85% of rated voltage.</p>	<p>AC</p> <p>DC</p>	24	UK	LV426801	LV426821	P29404	P29404
48	UL	LV426802				LV426822	P29405	P29405	UL	S33669	
110–130	UA	LV426803				LV426823	P29406	P29406	UA	S33670	
220–240	UC	LV426804				LV426824	—	—	UC	S33671	
208–277	UD	LV426805				LV426825	P29407	P29407	—	—	
380–415	UF	LV426806				LV426826	—	—	—	—	
380–480	UH	LV426807				LV426827	P29408	P29408	UH	S33673	
525–600	UJ	—				—	P29409	P29409	—	—	
12	UN	—				—	P29402	P29402	—	—	
24	UO	LV426801				LV426821	P29410	P29410	UK	S33668	
30	UU	—				—	P29411	P29411	UK	S33668	
48	UP	LV426802				LV426822	P29412	P29412	UL	S33669	
60	UV	—				—	P29403	P29403	UL	S33669	
125	UR	LV426803				LV426823	P29413	P29413	UA	S33670	
250	US	LV426815				LV426835	P29414	P29414	UC	S33671	
 <p>Time Delay Unit</p>	<p>Undervoltage trip with externally mounted adjustable time delay unit for UVR of 0.5, 0.9, 1.5, 3.0 seconds before circuit breaker trips</p> <p>Undervoltage trip with externally mounted non-adjustable time delay unit of 0.25 sec before circuit breaker trips.</p>	AC/DC	48	—	S33680 [4]	—	S33680 [4]	S33680 [4]	—	S33680 [4]	
			100–130	—	S33681 [4]	—	S33681 [4]	S33681 [4]	—	S33681 [4]	
			220–250	—	S33682 [4]	—	S33682 [4]	S33682 [4]	—	S33682 [4]	
		380–480	—	—	—	—	—	—	S33683 [4]		
		AC/DC	48	—	S29426 [4]	—	S29426 [4]	S29426 [4]	—	—	
			100–130	—	—	—	—	—	—	S33684 [4]	
			200–250	—	—	—	—	—	—	S33685 [4]	
220–240	—		S29427 [4]	—	S29427 [4]	S29427 [4]	—	—			

[1] P-frame drawout circuit breaker only.  
 [2] Not available on electrically operated P-frame.  
 [3] SDE Adapter used for H- and J-frame only.  
 [4] Field-installable kit includes time delay module only. Order undervoltage trip separately.

### Motor Operators

#### Motor Operators for H-, J-, and L-Frame Circuit Breakers

- Circuit-breaker indications and information remain visible and accessible, including trip-unit settings and indications
- Suitability for isolation is maintained and padlocking remains possible
- All termination connection (fixed, plug-in/withdrawable) possibilities are maintained
- Double insulation of the front face

Description	Rated Voltage	Factory Installed Cat. No. Suffix	Field-Installable Kit				
			H-Frame [5] Cat. No.	J-Frame Cat. No.	L-Frame 600 A Cat. No.		
 <p>Standard motor for electrically-operated circuit breakers [6]</p> <p>Communicating motor for electrically-operated circuit breakers [7]</p> <p>Locking device</p> <p>Operations counter</p> <p>Adapter for I-Line circuit breaker</p>	AC	48-60	ML	S29440	S31548	S432639	
		110-130	MA	S29433	S31540	S432640	
		208-277 220-240	MD	S29434	S31541	S432641	
		380-415	MF	—	—	S432642	
		440-480	MH	S29435	S31542	S432647	
		DC	24-30	MO	S29436	S31543	S432643
			48-60	MV	S29437	S31544	S432644
			110-130	MR	S29438	S31545	S432645
			250	MS	S29439	S31546	S432646
	Mounting hardware	220-240	NC	S429441	S431549	S432652	
		—	—	—	—	S32649	
		Ronis lock	—	S41940	S41940	S41940	
	Profalux lock	—	S42888	S42888	S42888		
Mounting hardware plus Ronis lock	—	—	S429449	S429449	—		
—	—	—	—	—	S32648		
—	—	—	S37420	S37420	—		

#### Spring-Charging Motors for Electrically-Operated P-Frame Circuit Breakers

Automatically charges the spring mechanism for closing the P-frame circuit breaker and also recharges the spring mechanism when the circuit breaker is in the ON position. Instantaneous reclosing of the circuit breaker is thus possible following circuit breaker opening.

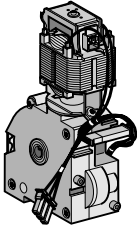
Description	Rated Voltage	Factory Installed Cat. No. Suffix	P-Frame (For Field Replacement Only)	Replacement Coils		
			Spring Charging Motor Cat. No.	Opening/Closing Coil Cat. No.		
 <p>Standard motor for electrically-operated circuit breakers. Factory-installed includes motor and opening/closing coils.</p> <p>Communicating motor mechanism for electrically operated circuit breakers. Factory-installed includes motor and opening/closing coils.</p>	AC	48	ML	S47391	S33660	
		100-130	MA	S47395	S33661	
		220-240	MC	S47396	S33662	
		380-415	MF	S47398	S33664	
		DC	24-30	MO	S47390	S33659
			48-60	MV	S47391	S33660
			110-130	MR	S47392	S33661
			200-250	MS	S47393	S33662
			48	NL	S47391	S33034
	AC	100-130	NA	S47395	S33035	
		220-240	NC	S47396	S33036	
		380-415	NF	S47398	S33038	
		DC	24-30	NO	S47390	S33033
			48-60	NV	S47391	S33034
			110-130	NR	S47392	S33035
	200-250	NS	S47393	S33036		

[5] Not available in H-frame 2P modules.

[6] Factory and field-installed standard motor operators for H- and J-frame circuit breakers require the SDE switch and SDE adapter (both included).

[7] Factory and field-installed standard motor operators for L-frame circuit breakers require the SDE switch (included).

[7] Installation requires BSCM Modbus SL/ULP with NSX Cord. For ordering information see page 7-68 .



**Rotary Handles**

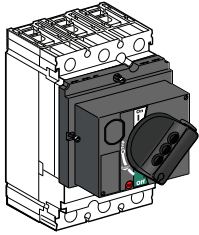

Direct-Mounted Rotary Handle

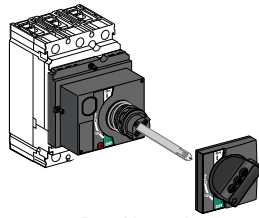

Door-Mounted Rotary Handle

Device	Description	B-Frame		H- and J-Frame [8]		L-Frame		P-Frame	
		Factory Installed Cat. No. Suffix	Field-Installable Cat. No.	Factory Installed Cat. No. Suffix	Field-Installable Cat. No.	Factory Installed Cat. No. Suffix	Field-Installable Cat. No.	Factory Installed Cat. No. Suffix	
Direct Mounted	Standard black handle	Operating mechanism kit	RD10	LV426930	RD10	S29337	RD10	S32597	RD10
	Standard black handle with	Two early-break and two early make switches	—	—	—	—	—	—	RD16
		One early-break switch	—	—	RD12	S29337 + S29345	RD12	S32597 + S32605	—
		Two early-make switches	—	—	RD13	S29337 + S29346	RD13	S32597 + S29346	—
	Red handle on yellow bezel	Operating mechanism kit	RD20	LV426931	RD20	S29339	RD20	S32599	—
		One early-break switch	—	—	RD22	S29339 + S29345	RD22	S32599 + S32605	—
		Two early-make switches	—	—	RD23	S29339 + S29346	RD23	S32599 + S29346	—
	MCC conversion accessory	—	—	—	S429341	—	S32606	—	
CNOMO conversion accessory	—	—	—	29342	—	S32602	—		
Door Mounted	Standard black handle	Operating mechanism kit	—	LV426932	RE10	S29338	RE10	S32598	RE10
	Standard black handle with:	Two early-break and two early make switches	—	—	—	—	—	—	RE16
		Two early make switches	—	—	RE13	S29338 + S29346	RE13	S32598 + S29346	—
	Red handle on yellow bezel	Operating mechanism kit	—	LV426933	RE20	S29340	RE20	S32600	—
Rotary Handle Replacement Kit	—	—	—	—	—	—	—	S33875	
Telescoping	—	—	—	RT10	S29343	RT10	S32603	—	
Accessories	Key lock adapter	—	—	—	S429344	—	S32604	—	
	Key locks	Ronis 1351.500	—	—	—	S41940	—	S41940	—
		Profalux KS5 B24 D4Z	—	—	—	S42888	—	S42888	—
		2 Ronis keylocks with 1 key	—	—	—	S41950	—	S41950	—
		2 Profalux keylocks with 1 key	—	—	—	S42878	—	S42878	—
	Indication Auxiliary Switch	One early-break switch	—	—	—	S29445	—	S32605	—
		Two early-make switches	—	—	—	S29346	—	S29346	—

Refer to Digest Section 8—Operating Mechanisms for additional operating mechanism options.

[8] Not available in H-frame 2P modules.

Locks, Installation Accessories, and Rear Connectors

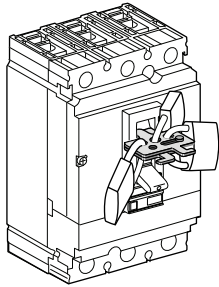

Removable Padlock Attachment

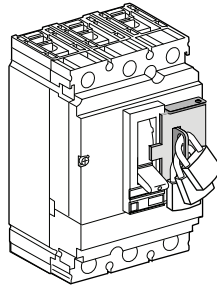

Fixed Padlock Attachment

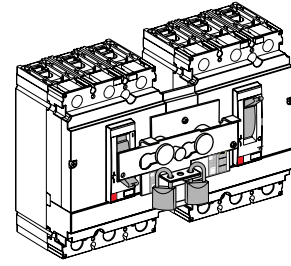

Interlocking with Toggle Control

Table 7.100: Locks, Interlocking

Device	Description	B- Frame		H- and J- Frame		Q- Frame		L- Frame	M- and P- Frame		R- Frame		
		Factory-Installed Cat. No. Suffix	Field-Installable Cat. No.	Factory-Installed Cat. No. Suffix	Field-Installable Cat. No.	Factory-Installed Cat. No. Suffix	Field-Installed Cat. No.	Field-Installable Cat. No.	Factory-Installed Cat. No. Suffix	Field-Installable Cat. No. [9]	Factory-Installed Cat. No. Suffix	Field-Installable Cat. No.	
Handle Padlocking Device	Removable (lock OFF only)	—	S29370	—	S29370	—	—	S29370	—	S44936	—	S33996	
	Fixed (lock OFF or ON)	YP	LV426905 LV426907 (I-Line)	YP	HJPA	YP	QBPA	S32631	YP	S32631	YP	S32631	
	Fixed (lock OFF only)[10]	YQ	LV426906 LV426908 (I-Line)	YQ	HJPAF	YQ	QBPAF	NJPAF	YQ	MPRPAF	YQ	MPRPAF	
	Fixed (lock OFF only)–2P	—	—	YQ	H2PHLA	YQ	—	—	—	—	—	—	
Interlocking (Not UL listed)	Mechanical for circuit breakers with rotary handles [11]	—	—	—	S29369	—	—	S32621	—	S33890	—	—	
	Mechanical for circuit breakers with toggles [11]	—	LV426909	—	S29354	—	QBMIK	S32614	—	—	—	—	
Key Locking	Provision only, vertical mount, 1 or 2 locks	Kirk	—	—	—	—	—	—	JA	—	—	—	
	Provisions only, vertical mounting one key interlock including padlock provision, open position only.	Kirk	—	—	—	—	—	—	JE [12] [13]	—	JE [13]	—	
	Provision only, horizontal mount 1 lock, M- and P-frame 1 or 2 locks, R-frame	Kirk	—	—	—	—	—	—	—	JK	—	JK	—
		Ronis	—	—	—	—	—	—	—	—	—	JB	—
		Profalux	—	—	—	—	—	—	—	—	—	JD	—
	Provision and 1 lock, vertical mount	Kirk	—	—	—	—	—	—	—	JG	—	—	—
		Kirk	—	—	—	—	—	—	—	JL	—	JL	—
		Ronis	—	—	—	—	—	—	—	—	—	JC	—
	Provision and 1 lock, horizontal mount	Kirk	—	—	—	—	—	—	—	—	—	JF	—
		Ronis	—	—	—	—	—	—	—	—	—	—	—
Profalux		—	—	—	—	—	—	—	—	—	—	—	
Provision and 2 locks keyed alike	Kirk	—	—	—	—	—	—	—	JN	—	JN	—	
Provision and 2 locks keyed differently	Kirk	—	—	—	—	—	—	—	JP	—	JP	—	

[9] For Drawout breakers use only horizontal keylock. Not available for PowerPac P with motor operator.

[10] Not available on HD and HG 2P modules.

[11] Not available in M frame or HD and HG 2P modules.

[12] Not available on M-frame.

[13] Not available on I-Line.



Phase Barriers

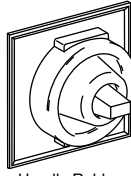

Handle Rubber Boot

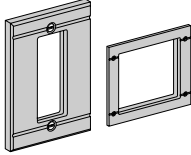

Front Panel Escutcheons



DIN Rail Mounting Kit



Visi-Trip H-, J- Frame



Visi-Trip L- Frame

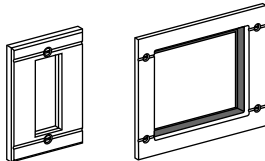

Door Escutcheon

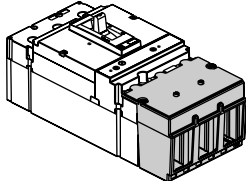

Terminal Covers

**Table 7.101: Installation Accessories for B-, H-, J-, and L- Frame Circuit Breakers**

Description	Field-Installable Cat. No.		
	B-Frame	H- and J- Frame	L- Frame
Front Panel Escutcheon for Toggle Breakers	—	S29315	32556
Front Panel Escutcheon for Rotary Handle, Motor Operator, or extended escutcheon	—	S29317	S32558
Phase Barriers (set of 6)	LV426920	S29329	32570
Handle Rubber Boot [14]	—	S29319	S32560
Sealing Accessories (for front cover screws)	S29375	S29375	S29375
DIN rail mounting kit (requires 15 mm depth on a 35 mm DIN rail) [14]	Standard	S29305	—
DIN rail adapter	Standard	—	—
Handle Extensions (set of 5)	—	S29313	S432553
Rear Insulation Kit (2P)	LV426921	—	—
Rear Insulation Kit (3P)	LV426922	—	—
Rear Insulation Kit (4P)	LV426923	—	—
Terminal Extensions-Spreaders (3P)	LV426940	—	—
Terminal Extensions-Spreaders (4P)	LV426941	—	—
5 N-m Torque Limiting Bit, Set of 6	LV426992	—	—
5 N-m Torque Limiting Bit, Set of 8	LV426993	—	—
9 N-m Torque Limiting Bit, Set of 6	LV426990	—	—
9 N-m Torque Limiting Bit, Set of 8	LV426991	—	—
Visi-Trip qty 1	—	VTRIPHJ	VTRIPL
Visi-Trip qty 5	—	VTRIPHJ05	VTRIPL05
Visi-Trip qty 10	—	VTRIPHJ10	VTRIPL10

**Table 7.102: Installation Accessories for M-, P-, and R-Frame Circuit Breakers**

Description		Frame	Field-Installable Cat. No.
Door Escutcheon	Accessory Cover	M-, P-Frame	S33718
		R-Frame	S33929
	Toggle Handle	M-, P-Frame	S33717
	Drawout	P-Frame	S33857
Terminal Covers	Short lug cover 3P	P-Frame	S33932
	Short lug cover 4P		S33933
	Long lug cover 3P		S33934
	Long lug cover 4P		S33935
Replacement Handle	Standard	R-Frame	S33997
	Standard Short	M-, P-Frame	S46998
	Long	M-, P-Frame	S46996

**Table 7.103: H-, J-, and L-Frame Rear Connections**

Device	Description	H-Frame			J-Frame			L-Frame			
		Poles	Factory-Installed Termination No.	Field-Installable Cat. No.	Poles	Factory-Installed Termination No.	Field-Installable Cat. No.	Poles	Factory-Installed Termination No.	Field-Installable Cat. No.	
 Rear Connection	Mixed Rear Connection Kit [15]	2	S	—	2	S	—	3	S	S32477	
		3	S	S37432	3	S	S37437	4	S	S32478	
	Consisting of:	Short rear connections (set of 2)	2 or 3	—	2x S37433	2 or 3	—	2x S37438	3	—	2x S432475
		Long rear connections (set of 2)	—	S37434	—	S37439 [16]	—	—	—	2x	S432476
		Short terminal cover (3P)	3	—	S37436	3	—	S37440	3	—	2x S32562
		Short terminal cover (4P)	4	—	—	—	—	—	4	—	2x S32563

[14] Not available in HD and HG 2P modules.

[15] Kit contains 4 short rear connections, 2 long rear connections (4 long rear connections for 4P), hardware, and 2 terminal covers.

[16] For use with 3P circuit breakers only.

### Mechanical Lugs

**Table 7.104: Mechanical Lug Kits for B-Frame Circuit Breakers [17]**

Description	Circuit Breaker Application			Ampere Rating	Number of Wires Per Lug and Wire Range	Factory-Installed Cat. Suffix	Field-Installable Cat. No.	Qty Per Kit
	Standard	Ampere Rating	Optional					
Al Lugs for Use with Al or Cu Wire			BD BG BJ	15-125 A	(1) 14-2/0 AWG Al or Cu	LH	LV426966	2
			BD BG BJ	15-125 A	(1) 14-2/0 AWG Al or Cu	LH	LV426967	3
Cu Lugs for Use with Cu Wire Only			BD BG BJ	15-125 A	(1) 14-1/0 AWG Cu	LC	LV426964	2
			BD BG BJ	15-125 A	(1) 14-1/0 AWG Cu	LC	LV426965	3
EverLink Lug	BD BG BJ (1P)	15 - 125 A			(1) 14-3/0 AWG Cu	---	---	---
	BD BG BJ (2P)	15 - 125 A			(1) 14-3/0 AWG Cu	---	---	---
	BD BG BJ (3P)	15 - 125 A			(1) 14-3/0 AWG Cu	---	---	---
	BD BG BJ (4P)	15 - 125 A			(1) 14-3/0 AWG Cu	---	---	---
EverLink Lug with Control Wire Terminal		15 - 125 A	BD BG BJ (2P)		(1) 14-3/0 AWG Cu	LU, LV, or LW [18]	LV426973	1
		15 - 125 A	BD BG BJ (3P)		(1) 14-3/0 AWG Cu	LU, LV, or LW [18]	LV426974	1
		15 - 125 A	BD BG BJ (4P)		(1) 14-3/0 AWG Cu	LU, LV, or LW [18]	LV426975	1

**Table 7.105: Mechanical Lug Kits for H- and J-Frame Circuit Breakers [17]**

Description	Circuit Breaker Application			Ampere Rating	Number of Wires Per Lug and Wire Range	Kit Cat. No.	Qty Per Kit
	Standard	Ampere Rating	Optional				
Al Lugs for Use with Al or Cu Wire	HD, HG, HJ, HL	15-150 A			(1) 14-3/0 AWG Al or Cu	AL150HD	3
	JD, JG, JJ, JL	150-175 A			(1) 4-4/0 AWG Al or Cu	AL175JD	3
	JD, JG, JJ, JL	200-250 A	JD, JG, JJ, JL	150-175 A	(1) 3/0-350 kcmil Al or Cu	AL250JD	3
Cu Lugs for Use with Cu Wire Only			HD, HG, HJ, HL	15-150 A	(1) 14-2/0 AWG Cu	CU150HD	3
			JD, JG, JJ, JL	150-250 A	(1) 1/0-300 kcmil Cu	CU250JD	3
Control Wire Terminal for H-frame lug kit						S37423	2
Control Wire Terminal for J-frame lug kit						S37424	2

**Table 7.106: Mechanical Lug Kits for L-Frame Circuit Breakers [19]**

Description	Circuit Breaker Application				Number of Wires Per Lug and Wire Range	Kit Cat. No.	Qty Per Kit
	Ampere Rating	Poles	Unit Mount	I-Line			
Al Lugs for Use with Al or Cu Wire	250	3	X	X	(1) 2 AWG-500 kcmil Al	AL400L61K3	3
		4	X	---	(1) 2 AWG-600 kcmil Cu	AL400L61K4	4
	400/600	3	X	---	(2) 2/0 AWG-500 kcmil Al or Cu	AL600LS52K3	3
		4	X	---	(2) 2/0 AWG-500 kcmil Al or Cu	AL600LS52K4	4
Cu Lugs for Use with Cu Wire Only	400/600	3	X	X	(2) 3/0 AWG-500 kcmil Al or Cu	AL600LF52K3	3
		250	3	X	X	(1) 2 AWG-600 kcmil Cu	CU400L61K3
	400/600	4	X	---	(1) 2 AWG-600 kcmil Cu	CU400L61K4	4
		3	X	---	(2) 2/0 AWG-500 kcmil Cu	CU600LS52K3	3
	400/600	4	X	---	(2) 2/0 AWG-500 kcmil Cu	CU600LS52K4	4
		3	X	X	(2) 3/0 AWG-500 kcmil Cu	CU600LF52K3	3

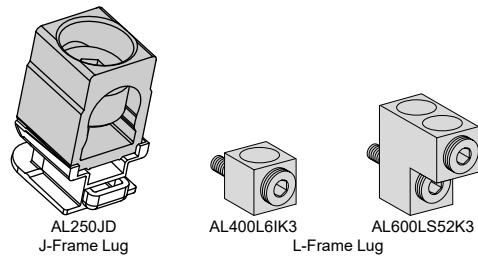

**Table 7.107: Mechanical Lug Kits for M-, P- and R-Frame Circuit Breakers [20]**

Description	Circuit Breaker Application				Wires per Lug and Wire Range	Cat. No.	Lugs Per Kit
	Standard	Rating	Optional	Rating			
Al Lugs for AL or Cu Wire	M-Frame, P-Frame	800 A	---	800 A	(3) 3/0 AWG-500 kcmil	AL800M23K	3
		1200 A	MG, MJ, PG, PJ, PK, PL	800 A	(4) 3/0 AWG-500 kcmil	AL1200P24K [21]	1
		---	MG, MJ, PG, PJ, PK, PL	800 A	(2) 3/0 AWG-600 kcmil	AL800P6K [21]	3
		---	MG, MJ, PG, PJ, PK, PL	800 A	(2) 3/0 AWG-600 kcmil	AL800P6K4 [21]	4
		---	MG, MJ, PG, PJ, PK, PL	800 A	(2) 3/0 AWG-750 kcmil 750 kcmil: compact AL only	AL800P7K [21]	3
	P-Frame	1200 A	PG, PJ, PK, PL	800 A	(4) 3/0 AWG-500 kcmil	AL1200P25K [22]	3
		---	PG, PJ, PK, PL	800 A	(4) 3/0 AWG-500 kcmil	AL1200P25K4 [22]	4
		---	PG, PJ, PK, PL	800-1200 A	(3) 350-600 kcmil	AL1200P6KU [22]	3
		---	PG, PJ, PK, PL	800-1200 A	(3) 350-600 kcmil	AL1200P6KU4 [22]	4
		PG, PJ, PL	---	PG, PJ, PK, PL	1200 A	(3) 3/0 AWG-750 kcmil 750 kcmil: compact AL only	AL1200P7KU [22]
R-Frame	1200 A	I-Line	---	(4) 3/0 AWG-600 kcmil	AL1200R53K	1	
	2500 A	Unit Mount	---	(1) 3/0 AWG-750 kcmil	AL2500RK [23]	2	
Cu Lugs for Cu Wire Only [24]	M-Frame, P-Frame	---	PJ	100-150 A	(1) 1-1/0 AWG	CU250P1K [25]	3
		800 A	MG, MJ, PG, PJ, PK, PL	---	(3) 3/0 AWG-500 kcmil	CU800M23K	3
	1200 A	MG, MJ, PG, PJ, PK, PL	800-1200 A	(4) 3/0 AWG-500 kcmil	CU1200P24K [21]	1	
	P-Frame	1200 A	PG, PJ, PK, PL	800-1200 A	(4) 3/0 AWG-500 kcmil	CU1200P25K [26]	3
		1200 A	PG, PJ, PK, PL	800-1200 A	(4) 3/0 AWG-500 kcmil	CU1200P25K4	4
R-Frame	1200 A	I-Line	---	(4) 3/0 AWG-500 kcmil	CU1200R53K	1	

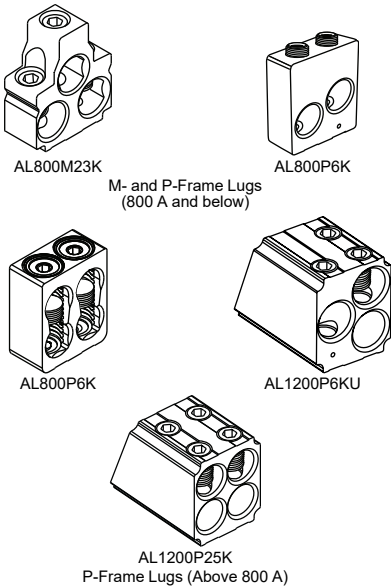

[17] For terminal nuts/bus bar connections see page 7-63.

[18] LU = ON end only, LV = OFF end only, LW = BOTH ends

[19] Lug kits for Legacy L-frame circuit breakers can be found in Supplemental Digest Section 11 (i.e. LA, LH circuit breakers).

[20] For lug with a tapped hole for control wire, add a "T" before the "K" in the catalog number (for example, AL800P6TK).

[21] Does not fit onto ON end of unit-mount P-frame circuit breakers.

[22] For unit-mount circuit breaker only.

[23] All unit-mount R-frame circuit breakers require terminal pads for mounting lugs of any type.

[24] Not available with tapped hole for control wire.

[25] This lug can only be used on low amp PJ frame breakers where the Instantaneous setting must not be turned OFF. The cables must be laced with rope per lug instructions.

[26] For unit-mount circuit breaker only.

**Compression Lugs**

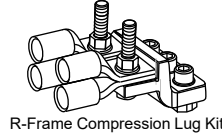
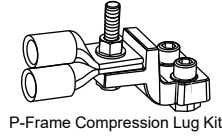
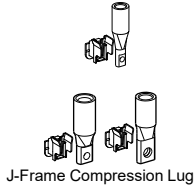

A = Crimp lugs or PDC connectors extension past end of circuit breaker

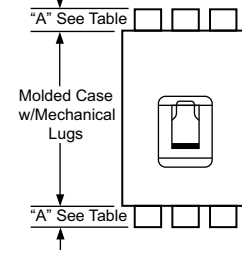

**Table 7.108: Compression Lug Kits for PowerPacT™ Circuit Breakers**

Description	Circuit Breaker Type	Ampere Rating	System Range	Mounting Type	Dimension A (in)	Max. Lugs per Terminal	Cat. No.	Qty. Per Kit			
<b>Compression Lug Kits for B-Frame Circuit Breakers</b>											
Aluminum Compression Lug Kits	B-frame	125 A	8-1/0 AWG Al or Cu	Unit/I-line [27]	1.3	1	LV426988	2			
		125 A	8-1/0 AWG Al or Cu		1.3	1	LV426989	3			
Copper Compression Lug Kits	B-frame	125 A	6-1/0 AWG Cu		1.4	1	LV426986	2			
		125 A	6-1/0 AWG Cu		1.4	1	LV426987	3			
<b>Compression Lug Kits for H-Frame and J-Frame Circuit Breakers</b>											
Aluminum Compression Lug Kits	H-frame	60 A	6-2 AWG Al or Cu	Unit/I-line [27]	1.2	1	YA060HD	3			
		150 A	1/0-4/0 AWG Al or Cu		2.5	1	YA150HD	3			
	J-frame	150 A	1-3/0 AWG Al or Cu		1.2	1	YA150JD	3			
		250 A	3/0-350 kcmil Al or Cu		2.5	1	YA250J35	3			
Copper Compression Lug Kits	H-frame	60 A	6-1/0 AWG Cu		1.0	1	CYA060HD	3			
		150 A	4-2/0 AWG Cu		1.2	1	CYA150HD	3			
	J-frame	150 A	6-1/0 AWG Cu		0.7	1	CYA150JD	3			
		250 A	2/0-300 kcmil Cu		1.1	1	CYA250J3	3			
<b>Compression Lug Kits for L-Frame Circuit Breakers</b>											
Aluminum Compression Lug Kits	L-frame	250 A	4-300 kcmil Al/Cu	Unit/I-line [27]	1.2	1	YA400L31K3	3			
		400 A	4-300 kcmil Al/Cu		2.5	2	YA600L32K3	6			
		250 A	2/0-500 kcmil Al/Cu		1.2	1	YA400L51K3	3			
		600 A	2/0-500 kcmil Al/Cu		2.5	2	YA600L52K3	6			
		400 A	500-750 kcmil Al 500 kcmil Cu		1.2	1	YA400L71K3	3			
		250 A	4-300 kcmil Al/Cu		2.5	2	YA400L31K4	4			
		400 A	4-300 kcmil Al/Cu		1.2	1	YA600L32K4	8			
		250 A	2/0-500 kcmil Al/Cu		2.5	2	YA400L51K4	4			
		600 A	2/0-500 kcmil Al/Cu		1.2	2	YA600L52K4	8			
		400 A	500-750 kcmil Al 500 kcmil Cu		2.5	1	YA400L71K4	4			
Copper Compression Lug Kits	L-frame	250 A	2/0-300 kcmil Cu	Unit/I-line [27]	1.2	1	CYA400L31K3	3			
		400 A	2/0-300 kcmil Cu		2.5	2	CYA600L32K3	6			
		250 A	250-500 kcmil Cu		1.2	1	CYA400L51K3	3			
		600 A	250-500 kcmil Cu		2.5	2	CYA600L52K3	6			
		250 A	2/0-300 kcmil Cu		1.2	1	CYA400L31K4	4			
		400 A	2/0-300 kcmil Cu		2.5	2	CYA600L32K4	8			
		250 A	250-500 kcmil Cu		1.2	1	CYA400L51K4	4			
		600 A	250-500 kcmil Cu		2.5	2	CYA600L52K4	8			
		<b>Compression Lug Kits for M-Frame, P-Frame, and R-Frame Circuit Breakers</b>									
		Aluminum Compression Lug Kits	M-, P-frame		250 A	2/0-300 kcmil	Unit/I-line [27]	3.7	2	YA250P3	1
300 A	4/0-500 kcmil			3.9	2	YA300P5		1			
400 A	2/0-300 kcmil			4.3	2	YA400P3		2			
400 A	500-750 kcmil Al, 500 kcmil Cu			3.7	2	YA400P7		1			
600 A	4/0-500 kcmil			3.9	2	YA600P5		2			
800 A	500-750 kcmil Al, 500 kcmil Cu			4.3	2	YA800P7		2			
R-frame [28]	1200 A		2/0-300 kcmil	I-line [27]	3.8	4	YA1200R3	4			
	1200 A		4/0-500 kcmil		4.0	4	YA1200R5	4			
	1200 A		500-750 kcmil Al, 500 kcmil Cu		4.4	4	YA1200R7	4			
	2000 A		2/0-300 kcmil		— [28]	8	YA2000R3	2			
Unit [27]	2000 A	4/0-500 kcmil	Unit [27]	— [28]	8	YA2000R5	2				
	2500 A	500-750 kcmil		— [28]	8 [29]	YA2500R7	2				
	400 A	4/0-500 kcmil		Unit [27]	3.3	2	CYA400P5	1			
	600 A	4/0-500 kcmil			3.3	2	CYA600P5	2			
800 A	500-750 kcmil	3.6	2		CYA800P7	2					
Copper Compression Lug Kits	M-, P-frame	1200 A	4/0-500 kcmil	I-Line [27]	3.5	4	CYA1200R5	4			
		1200 A	500-750 kcmil		3.8	4	CYA1200R7	4			

[27] Not for use on I-Line™ circuit breakers unless wire bending space is adequate.  
 [28] All unit-mount R-frame circuit breakers require terminal pads for mounting lugs of any type.  
 [29] 9 lugs for 3000 A circuit breakers



PDC6HD6



PDC6JD4



PDC3HD2



PDC3JD20

Crimp lugs or PDC connectors extension "A" past end of circuit breaker

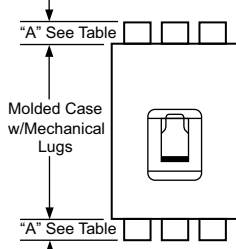

**Power Distribution Connectors**

Power distribution connectors (PDCs) can be used for multiple load wire connections on one circuit breaker in place of standard distribution block to save space and time.

The connectors are attached to circuit breaker terminals equipped with separately provided terminal nut connectors. [30]

Applications:

- For use on load end of circuit breaker only
- For use in UL 508 Industrial Control applications
- For use in UL 1995/CSA C22.2 No. 236 heating and cooling equipment
- For copper wire only

**Table 7.109: Power Distribution Connectors for B-Frame, H-Frame, J-Frame and L-Frame Circuit Breakers [31]**

Use with Circuit Breaker Type	Ampere Rating	(Wires Per Terminal) Wire Range	Dimension A (in.)	Cat. No.	Qty. Per Kit	Kit Contents
BD, BG, BJ	125 A	(3) 14 - 2 AWG	1.2	PDC3BD2	3	Mounting hardware, lugs
	125 A	(6) 14 - 6 AWG	1	PDC6BD6	3	
HD, HG, HJ, HL [32]	15-150 A	(6) 14-6 AWG Cu	1.0	PDC6HD6	3	Mounting hardware, lugs, special purpose label and instructions
	15-150 A	(3) 14-2 AWG Cu	1.2	PDC3HD2	3	
JD, JG, JJ, JL [32]	150-250 A	(6) 14-4 AWG Cu	1.0	PDC6JD4	3	
	150-250 A	(2) 14-1 AWG and (1) 3-2/0 AWG Cu	1.5	PDC3JD20	3	
LD, LG, LJ, LL [33]	150-600 A	(3) 14-1 AWG and (2) 3-2/0 AWG	1.28	PDC5DG20L3	3	Mounting hardware, lugs, special purpose label, Medium Terminal Shield and instructions
	150-600 A	(12) 14-4 AWG	1.31	PDC12DG4L3	3	Mounting hardware, lugs, special purpose label, Long Terminal Shield and instructions

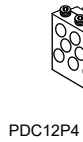

PDC12P4

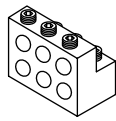

PDC6P20

**Table 7.110: Power Distribution Connectors for M-Frame and P-Frame Circuit Breakers [31]**

	Ampere Rating	(Wires Per Terminal) Wire Range	Cat. No.	Qty Per Kit	Kit Contents
Use for multiple load connections on one circuit breaker in place of standard distribution block to save space and time. • Use on load end of circuit breaker only • Use in UL508 Industrial Control applications only. • Use in UL1995/CSA C22.2 No. 236 heating and cooling equipment. • For Cu wire only.	250-1200 A	(6) 12-2/0 AWG Cu	PDC6P20	3	Mounting hardware, lugs, special purpose label and instructions
		(6) 12-2/0 AWG Cu	PDC6P204	4	Mounting hardware, lugs, special purpose label and instructions
	250-1200 A	(12) 10-4 AWG Cu	PDC12P4	3	Mounting hardware, lugs, special purpose label and instructions
			PDC12P44	4	Mounting hardware, lugs, special purpose label and instructions

[30] Refer to Terminal Shields and Phase Barriers.

[31] Not for use with I-Line™ circuit breakers.

[32] Special Purpose—Not for General Use. Use on ON end of the circuit breaker only when ON end is used as Load end. Use on OFF end of the circuit breaker only when OFF end is used as Load end.

[33] Kit includes long terminal shield and cover, which adds 1.65 inches to standard lug with short terminal shield.

**Terminal Accessories**

**Table 7.111: Terminal Nuts for Bus Bar Connection of B-, H- and J-Frame Circuit Breakers**

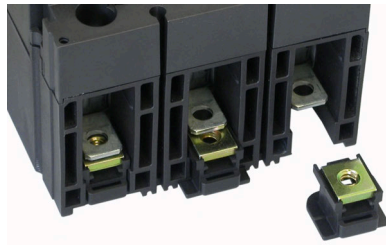

Description	Frame	Tap	Cat. No.	Qty Per Kit
B-Frame Terminal Nut Insert-Metric	BD/BG/BJ (2P)	M6	LV426962	2
B-Frame Terminal Nut Insert-Metric	BD/BG/BJ (3P)	M6	LV426963	3
H-Frame Terminal Nut Insert-English	HD/HG/HJ/HL	1/4-20	S37425	2
H-Frame Terminal Nut Insert-English	HD/HG/HJ/HL	1/4-20	S37444	3
H-Frame Terminal Nut Insert-Metric	HD/HG/HJ/HL	M6	S37426	2
J-Frame Terminal Nut Insert-English	JD/JG/JJ/JL	1/4-20	S37427	2
J-Frame Terminal Nut Insert-English	JD/JG/JJ/JL	1/4-20	S37445	3
J-Frame Terminal Nut Insert-Metric	JD/JG/JJ/JL	M8	S37428	2
Control Wire Terminal for H-Frame Terminal Nut	HD/HG/HJ/HL	—	S37429	2
Control Wire Terminal for J-Frame Terminal Nut	JD/JG/JJ/JL	—	S37430	2

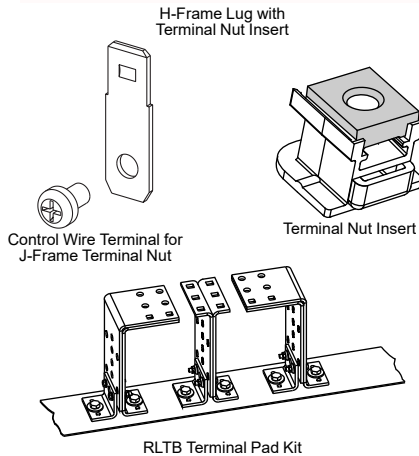

**Table 7.112: Bus Bar Connections Hardware for L-, M-, and P-Frame Circuit Breakers**

Frame	Description	Term. No.	Poles	Cat. No.
L-Frame	Set of 4 terminal screws and washers for one side	F	4	S36967
M- and P-Frame	Bus Connector Kit for one pole, one end	—	1	S33928

**Table 7.113: Terminal Pad Kits for R-Frame Circuit Breakers**

R-Frame Circuit Breaker	Terminal Pad Kit		Field-Installable Kits	
	Usage	Lugs per Phase	3P Kit (One End Only) Cat. No.	4P Kit (One End Only) Cat. No.
3000 A, 100% Rated [34]	Required for cable or bus	9	RL3TB	RL3TB4
3000 A, Standard (80% Rated) [35]	Required for cable or bus			
2500 A, 100% Rated	Required for cable or bus	8	RLTB	RLTB4
2500 A, Standard (80% Rated)	Required for cable, optional for bus			
All Other R-Frame Circuit Breakers	Required for cable, optional for bus			

For cable connection to RLTB, use AL2500RK lug. See page 7-61.

**Table 7.114: Terminal Shields and Phase Barriers**

Used With	Description		Dimension B (in.)	Cat. No.	Qty Per Kit		
H- and J-Frame Mechanical Lugs	Short Lug Shield [36]	Frame	Max. Wire Size				
		H-Frame 60 A	3 AWG	0.50	S37446	1	
		H-Frame 150 A	3/0 AWG	0.50	S37447	1	
		J-Frame	350 kcmil	0.24	S37448	1	
B-, H- and J-Frame Power Distribution Connectors and Compression Lugs	Compatible with:						
	PDC	Compression Lugs					
		Aluminum	Copper				
	B-Frame Long Lug Shield	PDC3BD2	L- V426988	LV426986	1.9	LV426911 (2P) LV426912 (3P) LV426913 (4P)	
		PDC6BD6	V426989	LV426987			
	H-Frame Long Lug Shield	PDC6HD6	YA060HD	CYA060HD	2.24	S37449	1
		PDC3HD2	YA150HD	CYA150HD			
	J-Frame Long Lug Shield	PDC6JD4	YA150JD	CYA150JD	1.68	S37450	1
PDC3JD2		[37]	CYA250J3				
L-Frame	3P Short Terminal Shield			LTSS3P	1		
	3P Medium Terminal Shield			LTSM3P	1		
	3P Long Terminal Shield			LTSL3P	1		
	4P Medium Terminal Shield			LTSM4P	1		
	4P Long Terminal Shield			LTSL4P	1		
M-, P-Frame	Phase Barriers			S33646	3		
R-Frame				S33998			

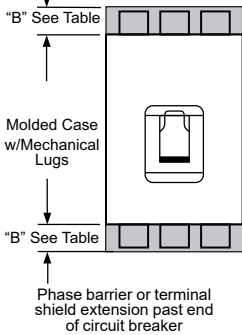

**Table 7.115: Miscellaneous H-, J-, and L-Frame Circuit Breaker Accessories**

Accessory	Description	Field-Installable Cat. No.
Spare Parts	Bag of screws for accessory cover, L-frame	S432552
	1 spare toggle extension, L-frame	32595
	Set of 10 identification labels	LV429226

[34] 3000 A 80% and 100% rated RL3TP (3P) and RL3TP4 (4P) ship with 2 kits.  
 [35] 2500 A 80% and 100% rated RLTB (3P) and RLTB4 (4P) ship with 2 kits.  
 [36] Short lug shields provide IP20 protection for mechanical lugs and are compatible with control wire terminals.  
 [37] J-frame terminal shield is not compatible with the YA250J35 compression terminal.

Mountings

Table 7.116: Plug-In and Drawout Mountings for H- and J-Frame Circuit Breakers (3P or 2P in a 3P module)



H- and J-Frame Plug-In Mounting



H- and J-Frame Drawout Mounting

Description		Factory Installed Cat. No.	Field-Installable Cat. No.	
Complete Factory-Assembled Circuit Breakers	Plug-in base shipped with circuit breaker	N	—	
	Drawout cradle shipped with circuit breaker	D	—	
Special Order Options for Plug-In and Drawout Circuit Breakers	Plug-In Base	Circuit breaker Only	HJ00	
		Plug-in base kit	—	S29278
	Drawout Cradle	Circuit breaker only	HJ00	—
		Plug-in base kit	—	S29278
		Cradle side plates (fixed part of chassis)	—	S29282
		Circuit breaker side plates (moving part of chassis)	—	S29283
Accessories for Plug-In and Drawout	H-Frame Shutter Kit (set of two)	—	S37442	
	J-Frame Shutter Kit (set of two)	—	S37443	
	Secondary Disconnect Blocks	Fixed part 9-wire connector (mounted on base)	—	S29273
		Moving part 9-wire connector (mounted on circuit breaker)	—	S29274
		Support for 2-moving connectors	—	S29275
	Extended escutcheon with extended toggle handle	—	S29284	
	Two position indicating switches (connected/disconnected)	—	S29287	
H-Frame Short Terminal Cover (3P)	—	S37436		
J-Frame Short Terminal Cover (3P)	—	S37440		

Table 7.117: Plug-In and Drawout Mountings for L-Frame Circuit Breakers



L-Frame Plug-In Mounting



L-Frame Drawout Mounting

Description	Poles	Plug-in Mounting		Drawout Mounting		
		Factory-Installed Cat. No.	Field-Installable Cat. No.	Factory-Installed Cat. No.	Field-Installable Cat. No.	
Kit (stationary and moving parts)	3	N	—	D	—	
	4	N	—	D	—	
Stationary Part	Plug-in base	3	—	S32514	—	
		4	—	S32515	—	
Moving Part	Fixed part of chassis	—	—	—	S32532	
		—	—	—	S32533	
	Circuit breaker only	—	HJ00	—	HJ00	—
		—	—	—	—	S32533
Short terminal covers	3	—	2x S32562	—	2x S32562	
	4	—	2x S32563	—	2x S32563	

Table 7.118: Plug-In and Drawout Accessories for L-Frame Circuit Breakers

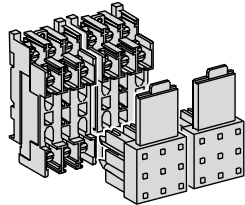

L-Frame Disconnecting Blocks

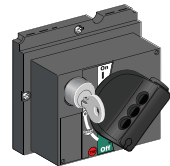

L-Frame Locking Device

Description		Field-Installable Cat. No.
Secondary Disconnecting Blocks	Fixed Part	9-wire connector S29273
	Moving Part	9-wire connector S32523
		Support for 3 moving connectors
Fixed + Moving	9-wire manual auxiliary connector	S29272
Shutters	Two shutters for plug-in base	32521
Chassis Accessories	Extended escutcheon for toggle	S32534
	Locking device (key lock is not included)	S29286
	Two position indicating switches (connected/disconnected)	S29287

Table 7.119: Termination Options

Termination Letter	Termination No.
N = Plug-in	LGL36400U31X
D = Drawout	For factory-installed termination, place termination letter in the third block of the circuit breaker catalog number.

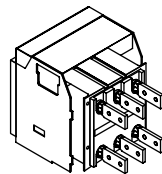
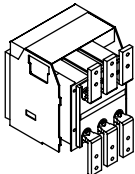

P-Frame Drawout Cradle Connections

Table 7.120: Drawout Cradle and Accessories for P-Frame Circuit Breakers

Description		Cat. No.
Drawout Cradle		Product Selector
Cradle Connectors	Front Connected Flat (FCF)	SFCF12 [38]
	Rear Connected T Horizontal/Vertical (RCTH/RCTV)	SRCTV12 [38]
Cradle Accessories	Modbus™ cradle communication module	S33852
	Safety shutters	S48933
	Secondary disconnects terminal shield	S33763
	Cradle position switch 1a/1b Form C—Connected/test/disconnected	S33170
	Low level cradle position switch 1a/1b Form C—Connected/test/disconnected	S33171
	Cell keying kit	S33767
	Disconnected position key locking—provision for Kirk or Federal Pioneer Lock	S33772
	Door interlock kit	S33786
	Racking interior kit	S33788
	Door escutcheon (for replacement only, included with circuit breaker)	S33857
	Transparent cover	S33859
	Push-in terminal kit (3 wires)	S33098
	Push-in terminal kit (6 wires)	S33099
	Finger cluster	S33166
	Cluster grease (12 oz. tube)	S48899

[38] Needs 2 kits per cradle.



PowerPacT H-, J-, and L-Frame MicroLogic Trip Units



**MicroLogic Trip Units [1]**

**MicroLogic Standard 3.2/3.3 Trip Units**

PowerPacT™ H-, J-, and L-frame molded case circuit breakers may be specified with any of the following MicroLogic Electronic Trip Units.

- True RMS sensing
- LI, LSI trip configurations
- Field-interchangeable trip units
- LED long-time pickup and trip indication
- Test kits available
- Thermal imaging

**MicroLogic Ammeter 5.2A/5.3A/6.2A/6.3A Trip Units**

Includes all features listed for MicroLogic standard trip unit, as well as:

- Advanced user interface
- Neutral protection
- Incremental fine tuning of settings
- Up to 12 alarms
- Digital ammeter—phase and neutral (4-pole only)
- Phase loading bar graph
- Maintenance indicators including contact wear, number of operations, operating hours, and load profiles
- Cause of trip information for troubleshooting assistance
- LCD Display
- Zone-selective interlocking (ZSI) (short-time & ground-fault)
- Optional Modbus™ communications—PowerLogic™ compatible

**MicroLogic Energy 5.2E/5.3E/6.2E/6.3E Trip Units**

Includes all features listed for MicroLogic ammeter trip unit, as well as:

- Ground-fault trip with programmable ground fault alarm (available on 6.2E/6.3E only)
- Power and energy measurement
- Power quality measurements
- Current demand and power demand measurements

**PowerPacT H, J and L-Frame MicroLogic Trip Units**

**Table 7.121: MicroLogic Trip Unit Settings for H-, J-, and L-Frame**

Model	Trip Function	Trip Unit	Ampere Setting
<b>MicroLogic Trip Unit Settings for H- and J-Frame Circuit Breakers</b>			
Standard	LI	3.2	15-20-25-30-35-40-45-50-60
			35-40-45-50-60-70-80-90-100
	LSI	3.2S	50-60-70-80-90-100-110-125-150
			70-80-100-125-150-175-200-225-250
Ammeter	LSI	5.2A	15-20-25-30-35-40-45-50-60
			35-40-45-50-60-70-80-90-100
	LSIG	6.2A	50-60-70-80-90-100-110-125-150
			70-80-100-125-150-175-200-225-250
Energy	LSI	5.2E	15-60
			35-100
	LSIG	6.2E	50-150
			70-250
<b>MicroLogic Trip Unit Settings for L-Frame Circuit Breakers</b>			
Standard	LI	3.3	15-60
			35-100
	LSI	3.3S	50-150
			70-250
Ammeter	LSI	5.3A	125-400
	LSIG	6.3A	200-600
Energy	LSI	5.3E	125-400
	LSIG	6.3E	200-600

[1] See Supplemental Digest Section 3 for circuit breakers with field-interchangeable trip units.

## PowerPacT P- and R-Frame MicroLogic Trip Units

PowerPacT P- and R-Frame MicroLogic Trip Units



Standard Trip Unit

Ammeter Trip Unit

Power Trip Unit

Harmonic Trip Unit

Adjustable Rating Plug

### MicroLogic (Standard) 3.0 and 5.0 Trip Units

PowerPacT™ P- and R-frame molded case circuit breakers may be specified with any of the following MicroLogic Electronic Trip Units.

- True RMS sensing
- LI, LSI trip configurations
- Field-interchangeable long-time rating plugs
- LED long-time pickup indication
- Test kits available
- Thermal imaging

### MicroLogic (Ammeter) 3.0A, 5.0A and 6.0A Trip Units

Includes all features listed for MicroLogic standard trip unit, as well as:

- LSIG trip configurations
- Digital ammeter—phase and neutral (4-pole only)
- Phase loading bar graph
- LED trip indication
- Zone-selective interlocking (ZSI) (short-time & ground-fault)
- Optional Modbus™ communications—PowerLogic™ compatible

### MicroLogic (Power) 5.0P and 6.0P Trip Units

Power measurement and advanced protection features includes all features listed for MicroLogic ammeter trip unit, as well as:

- LSI trip configuration with programmable ground fault alarm
- LSIG (Ground-fault trip) with programmable ground fault alarm
- Incremental “fine tuning” of L, S, I, and G pickup and delay settings
- LCD dot matrix display and LED trip indication
- Advanced user interface
- Advanced protection IDMTL—selectable long-time delay bands
- Neutral protection
- Power measurement
- Contact wear indication
- Modbus communications—PowerLogic compatible
- Local and remote settings

### MicroLogic (Harmonic) 5.0H and 6.0H Trip Units

Power quality measurement and advanced protection features. Includes all features listed for the MicroLogic power trip unit, as well as:

- Enhanced power measurements functions
- Power quality measurements

### Adjustable Rating Plugs for PowerPacT™ P-Frame and R-Frame and MasterPacT™ NT and NW Circuit Breakers—Selection

To provide maximum design flexibility, system protection, and field upgradeability, each MicroLogic™ trip unit is equipped with an interchangeable long-time rating plug. Each trip unit requires an adjustable rating plug to determine the long-time pickup range of the circuit breaker. These plugs are factory installed on new trip units, or can be ordered separately for field-installable upgrades.

Adjustable rating plugs are offered in eight different ranges of long-time pickup adjustments. The following chart show the ranges of adjustments. Each adjustment times the sensor rating ( $I_r \times I_n$ ) of the circuit breaker sets the long-time pickup value of the circuit breaker.

**Table 7.122: PowerPacT P- and R-Frame MicroLogic Trip Unit and Options**

Model	Protection	Additional Features	Field-Installable Cat. No. [2]
2.0 (IEC only)	LSO	None	S132R
3.0 (UL/ANSI only)	LI		S131A
5.0	LSI		S133A
2.0A (IEC only)	LSO	Ammeter	S142R [3]
3.0A (UL/ANSI only)	LI		S141A [3]
5.0A	LSI		S143A [3]
6.0A	LSIG		S144A [3]
5.0P	LSI	Metering, Adv. Protection	S163A [3][4]
6.0P	LSIG		S164A [3][4]
5.0H	LSI	Metering, Adv. Protection & Harmonic Analysis	S173A [3][4]
6.0H	LSIG		S174A [3][4]

**Table 7.123: PowerPacT P- and R-Frame MicroLogic Trip Units**  
x – Standard Feature    o – Available Option

Features	Standard		Ammeter			Power		Harmonic	
	3.0	5.0	3.0A	5.0A	6.0A	5.0P	6.0P	5.0H	6.0H
LI	X	—	X	—	—	—	—	—	—
LSI (Instantaneous can be turned off)	—	X	—	X	X	X	X	X	X
LSIG / Ground-Fault Trip [5]	—	—	—	—	X	—	X	—	X
Ground-Fault Alarm (No Trip) [5][6]	—	—	—	—	—	X	—	X	—
Ground-Fault Alarm and Trip [5][6]	—	—	—	—	—	—	X	—	X
Adjustable Rating Plugs	X	X	X	X	X	X	X	X	X
True RMS Sensing	X	X	X	X	X	X	X	X	X
UL Listed	X	X	X	X	X	X	X	X	X
Thermal Imaging	X	X	X	X	X	X	X	X	X
Phase Loading Bar Graph	—	—	X	X	X	X	X	X	X
LED for Long-time Pickup	X	X	X	X	X	X	X	X	X
LED for Trip Indication	—	—	X	X	X	X	X	X	X
Digital Ammeter	—	—	X	X	X	X	X	X	X
Zone-selective Interlocking	—	—	X	X	X	X	X	X	X
Communications	—	—	X	X	X	X	X	X	X
LCD Dot Matrix Display	—	—	—	—	—	X	X	X	X
Advanced User Interface	—	—	—	—	—	X	X	X	X
Protective Relay Functions	—	—	—	—	—	X	X	X	X
Neutral Protection	—	—	—	—	—	X	X	X	X
Contact Wear Indication	—	—	—	—	—	X	X	X	X
Incremental Fine Tuning of Settings	—	—	—	—	—	X	X	X	X
Selectable Long-time Delay Bands	—	—	—	—	—	X	X	X	X
Power Measurement	—	—	—	—	—	X	X	X	X
Power Quality Measurements	—	—	—	—	—	—	—	X	X
Waveform Capture	—	—	—	—	—	—	—	X	X

**Table 7.124: PowerPacT P- and R-Frame Long-Time Pickup Settings**

Rating Plug	Long-time Pickup Settings								
A	.40	.45	.50	.60	.63	.70	.80	.90	1.0
B	.40	.44	.50	.56	.63	.75	.88	.95	1.0
C	.42	.50	.53	.58	.67	.75	.83	.95	1.0
D	.40	.48	.64	.70	.80	.90	.93	.95	1.0
E	.60	.70	.75	.80	.85	.90	.93	.95	1.0
F	.84	.86	.88	.90	.92	.94	.96	.98	1.0
G	.66	.68	.70	.72	.74	.76	.78	.80	.82
H	.48	.50	.52	.54	.56	.58	.60	.62	.64

**Table 7.125: Special Options**

Description	Factory-Installed Suffix	Field-Installable Cat. No.
Ship circuit breaker in closed position	YK	N/A
Alternate Maintenance Setting (AMS) kit (use with 5.0/6.0 A, P or H and 5.3/6.3 A or E MicroLogic trip units)	—	84957
Energy Reduction Maintenance Setting (ERMS) kit (use with 5.0/6.0 P or H MicroLogic trip units)	—	84956
Maintenance Mode Setting Switch kit	120 Vac	LV429659
	24 Vdc	LV429658

[2] The standard rating plug supplied with a trip unit will be the "A" rating plug. To specify an alternative adjustable rating plug, please add the letter designation to the end of the catalog number. Please refer to page 7-68 for a complete listing of adjustable settings available with each plug. (Example: S143B would specify a "B" rating plug instead of the standard "A" plug.) Use suffix "N" if no rating plug is required, deduct.

[3] When replacing a standard trip unit with Type A (Ammeter), P (Power metering) or H (Harmonic analysis) trip unit, order the 12-pin connector kit S33101 for the MasterPacT NW and NT and the PowerPacT P-frame drawout circuit breakers or kit S33100 for PowerPacT P-frame and R-frame unit-mount and I-Line circuit breakers.

[4] Requires Circuit Breaker Communications Module.

[5] Requires neutral current transformer in 3Ø4W systems.

[6] Alarm history is available through the trip unit display and communications. Local indication of an alarm requires an M2C Programmable Contact Module.

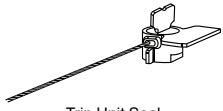

Trip Unit Seal



Sensor Plug

**Trip Unit Accessories**

Adjustable rating plug "A" is installed as standard on all MicroLogic trip unit orders. However, an alternative selection may be specified from the "Assembled" table below, and factory installed with your trip unit order at no additional charge. To order, please attach the appropriate catalog suffix to the end of the trip unit Cat. No. (after specifying trip unit options). Adjustable rating plugs may also be purchased as field-installable components from the table below.

For Enerlin'X accessory information, see [Enerlin'X Digital Solutions, page 7-79](#)

**Table 7.126: Rating Plugs**

Rating Plug [7]	Factory Installed Cat. Suffix	Field-Installable Cat. No.
A	A (standard)	S48818
B	B	S48819
C	C	S48820
D	D	S48836
E	E	S48837
F	F	S48838
G	G	S48839
H	H	S48840

**Table 7.127: Neutral Current Transformers**

Use With	Cat. No.	Sensor
H- Frame	S429521	60–100
	S430562	150
J- Frame	S430563	250
L- Frame	S432575	400–600
P- Frame	S33575[8]	250
	S33576[8]	400–1600
R- Frame	S48916[8]	250
	S34036[8]	400–1600
	S48896[8]	2000
	S48182[8]	3000
All	NCTWIRING	All

**Table 7.128: Zone-Selective Interlocking**

Description	Factory-Installed Cat. Suffix	Field-Installable Cat. No.
ZSI Interface Module	—	S434212
24 Vdc Terminal Block	EN	S434210
ZSI Wire Harness, H/J Frame	YH3	S434300
ZSI Wire Harness, L- Frame	YH3	S434301
ENCT & ZSI Wire Harness	YH4	—

**Table 7.130: Sensor Plugs for P- and R- Frame Circuit Breakers [10]**

Description	Sensor Plug Range	Sensor Plug Cat. No.	Circuit Breaker Frames Accepting Sensor Plug								
			250 A	400 A	600 A	630 A [11]	800 A	1000 A	1200 A	1250 A [11]	1600 A
<b>P- Frame Circuit Breaker</b>											
UL	250 A	S47052	X	—	—	—	—	—	—	—	—
	400 A	S47053	—	X	X	—	X	—	—	—	—
	600 A	S48823	—	—	X	—	X	X	X	—	—
	800 A	S33092	—	—	—	—	X	X	X	—	—
	1000 A	S33093	—	—	—	—	—	X	X	—	—
	1200 A	S48824	—	—	—	—	—	—	X	—	—
IEC	630 A	S33091	—	—	—	X	X	X	—	X	X
	800 A	S33092	—	—	—	—	X	X	—	X	X
	1000 A	S33093	—	—	—	—	—	X	—	X	X
	1250 A	S33094	—	—	—	—	—	—	—	X	X
	1600 A	S33095	—	—	—	—	—	—	—	—	X
<b>R- Frame Circuit Breaker</b>											
UL	600 A	S48823	X	X	X	X	—	—	—	—	—
	800 A	S33092	—	X	X	X	X	—	—	—	—
	1000 A	S33093	—	—	X	X	X	X	—	—	—
	1200 A	S48824	—	—	—	X	X	X	X	—	—
	1600 A	S33095	—	—	—	—	X	X	X	X	—
	2000 A	S33982	—	—	—	—	—	X	X	X	—
	2500 A	S33983	—	—	—	—	—	—	X	X	—
	3000 A	S48825	—	—	—	—	—	—	—	X	—
	3200 A	S33984	—	—	—	—	—	—	—	—	X
IEC	1600 A	S33095	—	—	—	—	X	X	X	X	X
	2000 A	S33982	—	—	—	—	—	X	X	X	X
	2500 A	S33983	—	—	—	—	—	—	X	X	X
	3200 A	S33984	—	—	—	—	—	—	—	—	X

[7] Long-time pickup amperes (Ir) = Sensor Rating (In) X Setting of rating plug. "Fine adjustment tuning" is included on MicroLogic Power and Harmonic trip units, allowing for incremental settings of 1 A between the plug setting and .40 X Sensor Rating.

[8] Includes NCTWIRING kit.

[9] Service Interface Test Kit can be ordered through SE Services only. Service Interface Test kit replaces obsolete UTA, Hand-Held and Full Function Test Kit.

[10] For use only with circuit breakers with date codes later than 07011. For long-time pickup range, See rating plug information at [page 7-65](#).

[11] IEC Only.

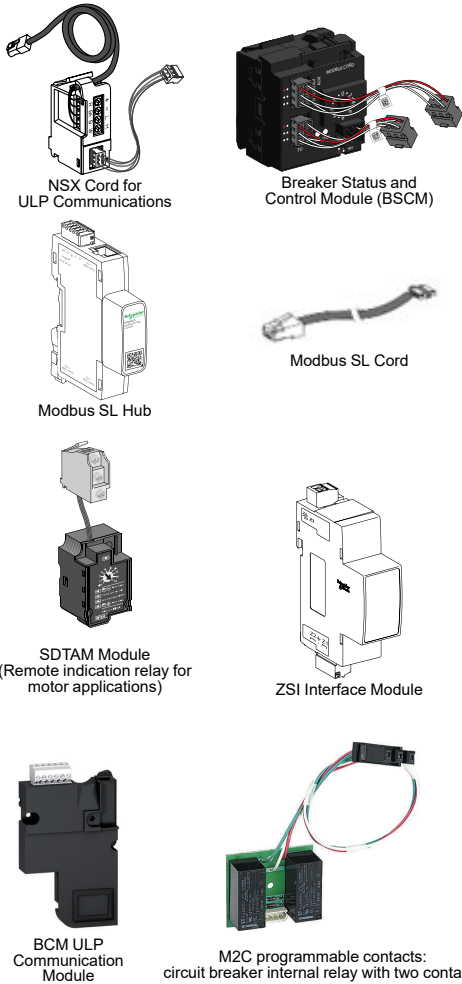

**Table 7.131: Electronic Trip Unit Accessories, Wire Harness [12] and ULP Cords for H-, J-, and L- Frame Circuit Breakers [13]**

Description	Factory-Installed Cat. No. Suffix	Field-Installable Kit Cat. No.	
		H-, J-, and L- Frame	L- Frame
NSX Cord [14] (for ULP Communication)	EA	L = 1.3 m (4.27 ft)	S434201
		L = 3 m (9.84 ft)	S434202
BSCM (Breaker Status and Control Module) with NSX ULP Cord V, <= 480 Vac [14]	EG [15]	L = 1.3 m (4.27 ft)	S434201BX
		L = 3 m (9.84 ft)	S434202BX
Replacement BSCM for Modbus SL or ULP	—	—	S434220
BSCM with NSX ULP Cord for V > 480 Vac [14]	EK [15]	L = 1.3 m (4.27 ft)	S434204BX
		L = 3 m (9.84 ft)	S434303BX
BSCM with MB SL Cord for V <= 480 Vac [16]	EL [15]	L = 3.0 m (9.84 ft)	S434223BX
		L = 1.3 m (4.27 ft)	S434222BX
		L = 0.35 m (1.15 ft)	S434221BX
Modbus SL Hub for Daisy chain, 3x RJ45 connections, DIN rail mount, stacking connector compatible [16]	—	—	S434224
SDTAM 24/415 Vac/dc Module [17]	V	—	S429424
SDX Module 24/415 Vac/dc [18]	V	—	S429532
ZSI Wire Harness, H/J Frame	YH3	—	S434300
ZSI Wire Harness, L- Frame	YH3	—	S434301
ENCT Wire Harness	YH2	—	S434302
OF Wire Harness	YH1	—	S434500
SD/SDE Wire Harness	YH1	—	S434501
SDx/SDTAM Wire Harness	YH1	—	S434502
MN Wire Harness	YH1	—	P434503
MX Wire Harness	YH1	—	P434504
24 Vdc Terminal Block Wire Harness [19]	YH1	—	S434505
Motor Operator Wire Harness	YH1	—	S434506
Communicating Motor Operator Wire Harness	YH1	—	S434507
NSX Wire Harness [19]	YH1	—	S434508

**Table 7.132: Trip Unit Field-Installable Accessories for P- and R-Frame Circuit Breakers**

Description	Factory-Installed Cat. No. Suffix	Field-Installable Kit Cat. No.						
		P- Frame					R- Frame	
		Unit Mount	I-Line	Motor Operated	Drawout	With Rotary Handle	Unit Mount	I-Line
Breaker Communication Module (BCM ULP)	E1	S64205	S64205	S64207	S64206	S64205	S64205	S64205
Replacement BCM ULP	—	33106	33106	33106	33106	33106	33106	33106
Two Programmable Contacts Module (M2C) [20]	V	S64273	S64273	S64273	S64273	S64273	S64273	S64273
External Voltage Sensing (EVS)	YV	S64203	S64203	S64210	S64209	S64210	S64208	S64208

**Table 7.133: Trip Unit Field-Installable Accessories for MasterPact NT/NW Circuit Breakers**

Description	Factory-Installed Cat. No. Suffix	Field-Installable Kit Cat. No.			
		MasterPact NT		MasterPact NW	
		Fixed	Drawout	Fixed	Drawout
Breaker Communication Module (BCM ULP)	—	S48188	S47485	S47405	S48384
Replacement BCM ULP	—	33106	33106	33106	33106
Two Programmable Contacts Module (M2C) [20]	—	S47403	S47485	S47403	S48382
External Voltage Sensing (EVS)	—	S47506	S47507	S47506	S48533

[12] Wire harness is required for I-Line applications, optional for unit-mount applications

YH1 = all installed accessories but ZSI and ENCT

YH2 = ENCT and all installed accessories

YH3 = ZSI and all installed accessories

YH4 = ZSI, ENCT and all installed accessories

[13] For proper selection, see catalog 0611CT1001.

[14] Installation requires IFM (LV434000) for Modbus communication and/or FDM (STRV00121) for external display.

[15] If using with motor operator requires communicating motor operator (suffix NC).

[16] Modbus serial only <= 480Vac. Use only with matching Modbus serial components.

[17] Remote indication relay for motor applications

[18] Remote indication relay

[19] I-Line wire harness is included for communication network accessories.

[20] Compatible with MicroLogic P and H only.

New!

MasterPac MTZ Circuit Breakers

MasterPac MTZ continues the performance and reliability of the MasterPac line. MasterPac MTZ circuit breakers bring innovation and upgradability throughout the entire lifecycle, for improved power uptime, business performance, and cost control.

- Customize MicroLogic X control unit anytime
- Purchase optional Digital Modules for additional protection, measurement and maintenance & diagnostic
- Easy installation using established architectures
- Demonstrated compliance with standards
- Smartphone connectivity for wireless alerts and maintenance
- Built in power meter with Class 1 precision for smart energy metering



MasterPac MTZ2  
800–4000 A

Table 7.134: MasterPac MTZ1 Circuit Breaker Ratings

Standard Frame Rating Interrupting Code		ANSI C37 Certified/ UL 1066 Listed		UL 489 Listed												
		800 A		800 A				1200 A				1600 A [1]				
		N1	N	N	H	L1	L	LF [2]	N	H	L1	L	LF [2]	N	H	L1
Interrupting Current (kA RMS) 50/60 Hz	240 Vac	42	50	65	100	200	200	50	65	100	200	200	50	65	100	200
	480 Vac	42	50	50	65	100	100	50	50	65	100	100	50	50	65	100
	600 Vac	—	35	50	—	—	—	35	50	—	—	—	35	50	N/A	N/A
Short-time Withstand Current (kA RMS)		42	35	35	10	10	10	35	35	10	10	10	35	35	10	10
Built-in Instantaneous Override (kA RMS ±10%)		—	40	40	10	10	10	40	40	10	10	10	40	40	10	10
Close and latch rating (kA RMS)		40	25	25	10	10	10	25	25	10	10	10	25	25	10	10
Tested to show the arc flash hazard risk category as referenced by NFPA70E		—	—	—	—	—	Yes	—	—	—	—	Yes	—	—	—	—
Breaking time		25–30 ms with no intentional delay		25–30 ms with no intentional delay (9 ms for L and LF)												
Closing time		< 50 ms														
Sensor Rating		400–800 A		400–800 A				600–1200 A				800–1600 A				
Endurance Rating (C/O Cycles) With No Maintenance		Mechanical		12,500		12,500		12,500		12,500		12,500		12,500		
		Electrical		2800		2800		2800		2800		2800		2800		

Table 7.135: MasterPac MTZ2 and MTZ3 Circuit Breaker Ratings

Standard Frame Rating Interrupting Code		ANSI C37 Certified/UL 1066 Listed														UL 489 Listed														
		800–1600 A						2000 A				3200/4000 A [3]				4000/5000 A				800/1200/1600/2000 A		2500/3000 A		4000/5000/6000 A						
		N1	H1	H2	H3	L1 [2]	L1F [2]	H1	H2	H3	L1 [2]	L1F [2]	H1	H2	H3	L1 [2]	H2	H3	L1 [2]	N	H	L [2]	LF [2]	H	L [2]	H	L [2]			
Interrupting Current (kA RMS) 50/60 Hz	240 Vac	42	65	85	10-0	200	200	65	85	100	200	200	65	85	100	200	85	100	200	65	100	200	200	100	200	100	200			
	480 Vac	42	65	85	10-0	200	200	65	85	100	200	200	65	85	100	200	85	100	200	65	100	150	150	100	150	100	150			
	600 Vac	42	65	85	85	130	130	65	85	85	130	130	65	85	85	130	85	85	130	50	85	100	100	85	100	85	100			
Short-time Withstand Current (kA RMS)		42	65	85	85	30	22	65	85	85	30	22	65	85	85	100	85	85	100	42	65	30 [4]	22	65	65	85	100			
Built-in Instantaneous Override (kA RMS ±10%)		35	35	35	85	35	24	—	—	85	35	24	—	—	85	117	—	—	117	40	40	35 [4]	24	65	65	75	75			
Close and latch rating (kA RMS)		42	65	40	40	25	22	65	40	40	25	22	65	40	40	40	85	75	40	40	40	25 [5]	22	40	40	40	40			
Tested to show arc flash hazard risk category as referenced by NFPA70E		—	—	—	—	—	Yes	—	—	—	—	Yes	—	—	—	—	—	—	—	—	—	—	Yes	—	—	—	—			
Breaking time		25–30 ms with no intentional delay (9 ms for L1, L1F, L and LF)																												
Closing time		70 ms																												
Sensor Rating (A)		400–800 800–1600				1000–2000				1600–3200				2000–4000 2500–5000				400–800 600–1200 800–1600 1000–2000				1200–2500 1600–3000		2000–4000 2500–5000 3000–6000						
Endurance Rating (C/O Cycles) With No Maintenance	Mech.	12,500						10,000				10,000				5k				5,000				12,500 [6]		10,000		5,000		
	Elec.	2800						1,000				1,000				1k				1,000				2800 [6]				1,000		1,000

[1] Fixed mounted only.  
 [2] Drawout mounted only.  
 [3] 4000 A standard width circuit breaker is not available in L1 interrupting rating code or drawout construction (fixed mounting only).  
 [4] 65 kA RMS for 2000 A.  
 [5] 40 kA RMS for 2000 A.  
 [6] For 2000 A N/H/L/LF devices, the endurance rating is 10,000 for mechanical and 1000 for electric.

7 MINIATURE AND MOLDED CASE CIRCUIT BREAKERS

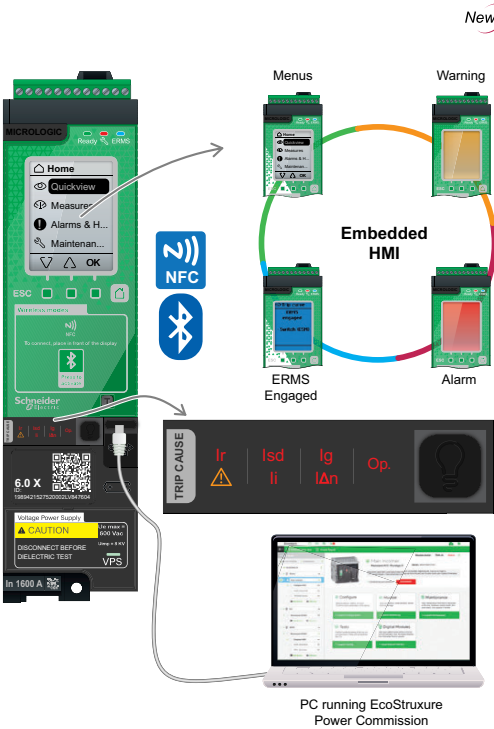

New!

### MicroLogic X Control Unit for MasterPacT MTZ Circuit Breakers

The MicroLogic X control unit protection functions include overcurrent, short-circuit, and ground-fault protection. Along with the standard protection functions LI, LSI, and LSIg, new features enhance the overall performance of a system: dual settings, fine settings, fast tripping.

MicroLogic X measures electrical parameters of a power system: currents, voltages, frequency, power, energy, power factor, current and power demand. Min/Max and average values are calculated for most of the parameters.

MicroLogic X capability for maintenance & diagnostics simplifies circuit breaker service and operations. Relevant indicators and messages are powerful tools that can help the user scheduling both preventive and predictive maintenance, and device replacement.

### MasterPacT MTZ Digital Modules Options for Advanced Functions

Optional Digital Modules can be purchased and downloaded to enhance the performance of MicroLogic X control units. They are dedicated to advanced protection, measurement, and maintenance & diagnostics, and are available through Go Digital on the Schneider Electric website.

Module (Available on the Schneider Electric GoDigital Website)		Part Number
<b>Protection</b>		
ANSI 27/59—Under/Over Voltage Protection	Monitors the circuit breaker voltages and trips when the voltage exceeds the settings.	LV850012
ANSI 32P—Reverse Active Power Protection	Monitors the active power.	LV850011
ANSI 51N/51G—Ground-Fault Alarm	Provides an integrated ground fault alarm.	LV850007
ERMS—Energy Reducing Maintenance Settings	Used to lower the protection settings in order for the MasterPacT MTZ circuit breaker to trip faster, reducing arc energy.	LV850009
<b>Metering</b>		
Energy per Phase Digital Module	Calculates and displays the active, reactive and apparent energy per phase of the power system and provides total active, reactive and apparent energy per phase.	LV850002
Individual Harmonics Analysis	Provide harmonics of voltage and current to the 40th harmonic.	LV850006
<b>Maintenance &amp; Diagnostic</b>		
Power Restoration Assistant,	Displays available circuit breaker information to help determine potential causes of an event and also provides guidance for potential solutions to restore power.	LV850004
MasterPacT Operation Assistant	Assists in closing or opening the circuit breaker remotely with Bluetooth by delivering applicable instructions. Requires Comm & Diag accessories.	LV850005
Waveform Capture on Trip Event	Automatically logs five cycles of phase and neutral currents.	LV850003
Modbus Legacy Dataset	Allows easy integration in existing Modbus installations where modification of supervision software for MTZ circuit breakers is not desired.	LV850045

New generation MicroLogic X control units incorporate wireless technology (Bluetooth and NFC) that allows the transfer of a wide selection of critical information (protection, measurements, maintenance & diagnostics) to your mobile device, by means of the EcoStruxure Power Device App.

Alternatively, MasterPacT MTZ can be equipped with ETHERNET communication through either the IFE module or the new embedded EIFE that includes webpages. Modbus SL communication is available through the IFM interface module.

MicroLogic X Sensor Plugs

Table 7.136: Sensor Plug

In (A)	Sensor Plug :	MTZ1-08 MTZ2-08	MTZ2-16	MTZ2-16	MTZ2-32	MTZ2-40	MTZ3-32	MTZ3-40	MTZ3-50	MTZ3-60	MTZ3-63
400	LV847053SP	X	—	—	—	—	—	—	—	—	—
600	LV848823SP	X	—	—	—	—	—	—	—	—	—
630	LV833091SP	X	X	—	—	—	—	—	—	—	—
800	LV833092SP	X	X	—	—	—	—	—	—	—	—
1000	LV833093SP	—	X	X	—	—	—	—	—	—	—
1200	LV848824SP	—	X	X	—	—	—	—	—	—	—
1250	LV833094SP	—	X	X	—	—	—	—	—	—	—
1600	LV833095SP	—	X	X	X	—	—	—	—	—	—
2000	LV833982SP	—	—	X	X	X	X	X	X	X	X
2500	LV833983SP	—	—	—	X	X	X	X	X	X	X
3000	LV848825SP	—	—	—	X	X	X	X	X	X	X
3200	LV833984SP	—	—	—	X	X	X	X	X	X	X
3600	LV836390SP	—	—	—	—	X	X	X	X	X	X
4000	LV836391SP	—	—	—	—	X	X	X	X	X	X
2000	LV847821SP	—	—	—	—	—	X	X	—	—	—
2500	LV847822SP	—	—	—	—	—	X	X	X	—	—
3000	LV848826SP	—	—	—	—	—	X	X	X	X	—
3200	LV847823SP	—	—	—	—	—	X	X	X	X	X
3600	LV836391SP	—	—	—	—	—	—	X	X	X	X
4000	LV847824SP	—	—	—	—	—	—	X	X	X	X
5000	LV847825SP	—	—	—	—	—	—	—	X	X	X
6000	LV848827SP	—	—	—	—	—	—	—	—	X	X
6300	LV847826SP	—	—	—	—	—	—	—	—	—	X

Table 7.137: Replacement Parts for MicroLogic X Control Units

Replacement Part	Part Number
MicroLogic X Embedded Display & Wireless Card	LV850054SP
Internal Battery	LV833593SP
Transparent Cover with No Access Holes to MicroLogic X Control Unit	LV839454SP
Transparent Cover with Access Holes to MicroLogic X Control Unit	LV839453SP
USB Cable (miniUSB/USB) for MicroLogic X Control Unit	LV850067SP



*New!*

**MasterPac MTZ Accessories**

**Table 7.138: MasterPac MTZ Circuit Breaker Accessories**

Accessory	Circuit Breaker	Version	
		Fixed	Drawout
<b>Connection</b>			
Horizontal and vertical rear connection	MTZ1/2/3	X	X
Front connection	MTZ1/2/3	X	X
Vertical-connection adapters	MTZ1	X	X
Cable-lug adapters	MTZ1	X	X
Spreaders	MTZ1	X	X
Disconnectable front connection adapter	MTZ2/3	X	—
Lugs for 240 mm <sup>2</sup> or 300 mm <sup>2</sup> cables	MTZ1	X	X
Interphase barriers	MTZ1/2/3	X	X
Arc chute cover (CC)	MTZ1	X	—
Brackets for mounting	MTZ2/3	X	—
<b>Signalling</b>			
ON/OFF indication contacts (OF)	MTZ1/2/3	X	X
Fault-trip indication contact (SDE)	MTZ1/2/3	X	X
Combined connected/closed contacts (EF)	MTZ2/3	—	X
Cradle switches (CE, CD, CT)	MTZ1/2/3	—	X
Ready-to-close contact (PF)	MTZ1/2/3	X	X
ERMS switch module (ESM)	MTZ1/2/3	X	X
Mechanical operation counter (CDM)	MTZ1/2/3	X	X
<b>Controlling</b>			
Diagnostic and communicating shunt close (XF diag&com)	MTZ1/2/3	X	X
Shunt close (XF)	MTZ1/2/3	X	X
Diagnostic and communicating shunt trip (MX diag&com)	MTZ1/2/3	X	X
Shunt trip (MX)	MTZ1/2/3	X	X
Diagnostic undervoltage release (MN diag)	MTZ1/2/3	X	X
Undervoltage release (MN)	MTZ1/2/3	X	X
Non-adjustable delay unit (R)	MTZ1/2/3	X	X
Adjustable delay unit (Rr)	MTZ1/2/3	X	X
Isolation module	MTZ1/2/3	X	X
Spring charging motor (MCH)	MTZ1/2/3	X	X
Electrical reset option (RES)	MTZ1/2/3	X	X
Automatic reset option (RAR)	MTZ1/2/3	X	X
Electrical closing pushbutton (BPFE)	MTZ1/2/3	X	X
<b>Locking and Interlocking</b>			
ON/OFF pushbutton locking (VBP)	MTZ1/2/3	X	X
OFF position locking (VSPO-VCPO)	MTZ1/2/3	X	X
Cradle locking in disconnected position by padlock	MTZ1/2/3	—	X
Cradle locking in disconnected position: by keylock (VSPD)	MTZ1/2/3	—	X
Optional connected/disconnected/test position locking	MTZ1/2/3	—	X
Safety shutters (VO)	MTZ1/2/3	—	X
Shutter position indication and locking (VIVC)	MTZ2/3	—	X
Cable-type door interlock (IPA)	MTZ1/2/3	X	X
Door interlock (VPEC)	MTZ1/2/3	—	X
Racking interlock (VPOC)	MTZ1/2/3	—	X
Racking interlock between crank and OFF pushbutton (IBPO)	MTZ2/3	—	X
Cradle rejection kit	MTZ1/2/3	—	X
<b>Circuit Protection</b>			
External sensor for ground-fault protection (ENCT)	MTZ1/2/3	X	X
External sensor for source ground-return (SGR) protection	MTZ1/2/3	X	X
<b>Operation Protection</b>			
Automatic spring discharge before circuit breaker removal (DAE)	MTZ2/3	—	X
Grounding kit (KMT)	MTZ2/3	X	X
<b>Mechanical Protection</b>			
Terminal cover (CB)	MTZ1/2/3	—	X
Escutcheon (CDP)	MTZ1/2/3	X	X
Blanking plate for escutcheon (OP)	MTZ1/2/3	X	X
Transparent cover for escutcheon (CP)	MTZ1/2/3	—	X
<b>Power Supplies</b>			
Voltage power supply (VPS)	MTZ1/2/3	X	X
External 24 Vdc power supply module (AD)	MTZ1/2/3	X	X
Battery module (BAT)	MTZ1/2/3	X	X
Mobile Power Pack by APC	MTZ1/2/3	X	X
Spare internal battery	MTZ1/2/3	X	X



Microswitch Type ON/OFF Indication Contacts (OF) (MTZ1)

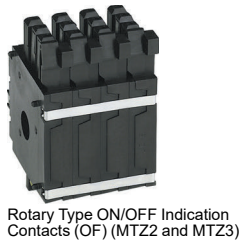

Rotary Type ON/OFF Indication Contacts (OF) (MTZ2 and MTZ3)

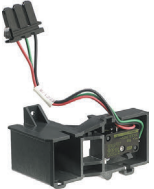

Additional Overcurrent Trip Indication Contacts (SDE)



Combined Connected/Closed Contacts



Connected / Disconnected / Test Position Cradle Switches (CE, CD and CT)

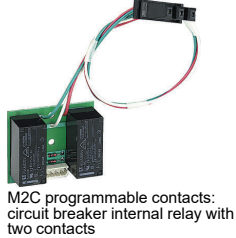

M2C programmable contacts: circuit breaker internal relay with two contacts

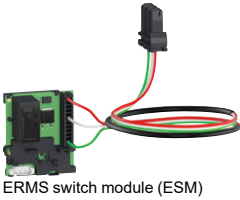

ERMS switch module (ESM)



Ready-to-close contacts (PF)



Pushbutton locking (VBP) with padlock

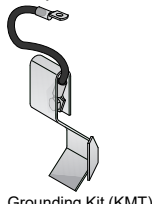

Grounding Kit (KMT)

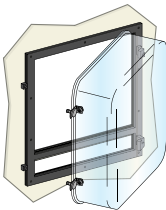

Transparent Cover for Escutcheon (CCP)

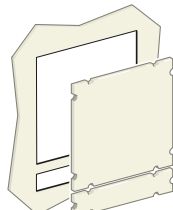

Cover for Escutcheon (CCP)

**Communication Accessories**  
**Table 7.139: Monitoring and Control**



EIFE Embedded Ethernet Interface



IO Application Module



IFE Interface



IFE Switchboard Server

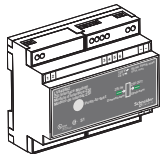

ZSI Interface Module

Description	Catalog Number	
Enerlin'X modules	EIFE Embedded Ethernet module full kit includes EIFE and EIFE cable; for MTZ1-drawout	LV851100SP
	EIFE Embedded Ethernet module full kit includes EIFE actuators and EIFE cable; for MTZ2/3-drawout	LV851200SP
	EIFE Embedded Ethernet stand-alone module; for MTZ1/2/3-drawout	LV851001SP
	Ethernet interface LV breaker	LV434001
	Ethernet interface for LV breakers and gateway	LV434002
	I/O application module	LV434063
	EIFE Cable; for MTZ1-drawout	LV851120SP
ULP port modules	EIFE Cable; for MTZ2/3-drawout	LV851220SP
	ULP port - for MasterPacT MTZ1 - fixed	LV850063SP
	ULP port - for MasterPacT MTZ1 - drawout	LV850064SP
	ULP port - for MasterPacT MTZ2/3 - fixed	LV850061SP
Ethernet display module	ULP port - for MasterPacT MTZ2/3 - drawout	LV850062SP
	Front display module FDM128	LV434128
ULP Wiring Accessories	5 RJ45 connectors female/female	TRV00870
	10 ULP line terminators	TRV00880
	10 RJ45/RJ45 male cord L = 0.3 m	TRV00803
	10 RJ45/RJ45 male cord L = 0.6 m	TRV00806
	5 RJ45/RJ45 male cord L = 1 m	TRV00810
	5 RJ45/RJ45 male cord L = 2 m	TRV00820
	5 RJ45/RJ45 male cord L = 3 m	TRV00830
ZSI Interface Module	1 RJ45/RJ45 male cord L = 5 m	TRV00850
	Connects up to 15 PowerPacT H/J/L/P/R or MasterPacT MTZ/NT/NW Circuit Breakers or for applications requiring compliance with IEC and CENELEC HD 60364-4-41 or those requiring double insulation.	LV848892SP

**Auxiliary, Alarm Contacts and Power Supply Catalog Numbers**

Combined Contacts

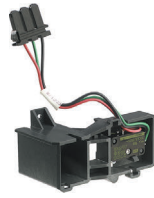
 Additional Overcurrent Trip Indication  
 Contacts (SDE)

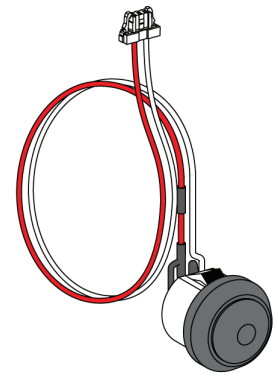
 Microswitch Type ON/OFF Indication Contacts  
 (OF) (MTZ1)

 MasterPacT Electrical Closing Pushbutton  
 (BPFE)

**Table 7.140: Auxiliary and Alarm Contacts, Programmable Contact Module, Electrical Close Pushbutton**

Accessory	Catalog Number	
	MTZ1	MTZ2/MTZ3
1a/1b Form C Auxiliary Switch	LV847076SP	—
Low Level 1a/1b Form C Auxiliary Switch	LV847077SP	—
4a/4b Form C Auxiliary Switch (OF)	—	LV864922SP
1a/1b Form C Connected/Closed Switch (EF)	—	LV848477SP
Low Level 1a/1b Form C Connected/Closed Switch (EF)	—	LV848478SP
1a/1b Form C Second Trip Alarm Switch (SDE2)	LV847915SP	LV847915SP
Low Level 1a/1b Form C Second Trip Alarm Switch	LV847916SP	LV847916SP
1a/1b Form C Ready-to-Close Switch (PF)	LV847080SP	LV847080SP
Low Level 1a/1b Form C Ready-to-Close Switch	LV847081SP	LV847081SP
Electrical Close Pushbutton (BPFE)	LV864917SP	LV848534SP

**Table 7.141: Cradle Position Switches (Cell Switches)**

Description	Catalog Number
1a/1b Form C Connected/Test/Disconnected Switch	LV833170SP
Low Level 1a/1b Form C Connected/Test/Disconnected Switch	LV833171SP
1a Connected/Test/Disconnected Switch MTZ2-3 (Ring Tongue)	LV839289SP
1b Connected/Test/Disconnected Switch MTZ2-3 (Ring Tongue)	LV839290SP
Set of 3 Cell Switch Actuating Arms	LV848560SP

**NOTE:** Auxiliary, alarm and status switches' terminal blocks need to be ordered separately, see Secondary Terminal Block Kits, below.

**Table 7.142: Secondary Terminal Block Kits**

Description	Fixed MTZ1/2/3	Drawout MTZ1	Drawout Drawout MTZ2/3
Push-in Terminal kit (3 Wires)	LV847074SP	LV833098SP	LV847849SP
Push-in Terminal kit (6 Wires)	LV847075SP	LV833099SP	LV847850SP
Ring Tongue Kit 1a MTZ2-3	—	—	LV839296SP
Ring Tongue Kit 1b MTZ2-3	—	—	LV839297SP
Ring Tongue Kit 1a & 1b MTZ2-3	—	—	LV839298SP

**Table 7.143: Accessories for MicroLogic X Control Units**

Description	Voltage	Catalog Number
External power supply module (AD)	24–30 Vdc	LV454440
	48–60 Vdc	LV454441
	100–125 Vdc	LV454442
	110–130 Vdc	LV454443
	200–240 Vdc	LV454444

**Vigirex™ Ground-Fault Relay System**

The Vigirex ground-fault relays, with associated sensors (current transformers), measure the residual current in an electrical installation to detect levels which may be damaging. When used for protection, they cause an associated circuit breaker or switch to interrupt the supply of power to the protected system. They may also be used for monitoring only, with output to an alarm. The product line includes fixed sensitivities from 30 mA to 1 A and adjustable sensitivities up to 30 A.

The Vigirex relays may be easily mounted on DIN rail or may be panel mounted in a meter cutout. Sensors for conductors range from a little more than an inch diameter toroids, to large rectangular sensors measuring 6 x 18 inches. The compact size of the relay and its sensor make it ideal for protection of OEM equipment as well as branch circuits.



**Table 7.144: Vigirex Ground-Fault Relays (UL 1053 Listed)**

Model	Delay	Reset	Control Voltage	Sensitivity	Cat. No.	
<b>DIN Rail Mounted</b>						
RH10M	Instantaneous	Manual	12–24 Vac/12–48 Vdc	30 mA	56300	
				100 mA	56302	
				300 mA	56305	
				500 mA	56306	
				1 A	56307	
				30 mA	56320	
			110–130 Vac	100 mA	56322	
				300 mA	56325	
				500 mA	56326	
				1 A	56327	
				220–240 Vac	30 mA	56330
					100 mA	56332
300 mA	56335					
500 mA	56336					
1 A	56337					
RH21M	Instantaneous or 60 msec (2 settings)	Manual	12–24 Vac/12–48 Vdc 110–130 Vac 220–240 Vac		30 mA [7] or 300 mA (2 settings)	56360 56362 56363
RH99M	Adjustable (9 settings): 0, 0.06, 0.15, 0.23, 0.31, 0.5, 0.8, 1.0, 4.5 sec	Manual	12–24 Vac/12–48 Vdc	Adjustable, (9 settings): 0.03 [7], 0.1, 0.3, 0.5, 1, 3, 5, 10, 30 A	56370TD	
			110–130 Vac		56372TD	
			220–240 Vac		56373TD	
		Automatic	12–24 Vac/12–48 Vdc		56390TD	
			110–130 Vac		56392TD	
			220–240 Vac		56393TD	
<b>Panel Mounted</b>						
RH10P	Instantaneous	Manual	12–24 Vac/12–48 Vdc	30 mA	56400	
				100 mA	56402	
				300 mA	56405	
				500 mA	56406	
				1 Amp	56407	
				30 mA	56420	
			110–130 Vac	100 mA	56422	
				300 mA	56425	
				500 mA	56426	
				1 Amp	56427	
				220–240 Vac	30 mA	56430
					100 mA	56432
300 mA	56435					
500 mA	56436					
1 A	56437					
RH21P	Instantaneous or 60 msec (2 settings)	Manual	12–24 Vac/12–48 Vdc 110–130 Vac 220–240 Vac		30 mA [7] or 300 mA (2 settings)	56460 56462 56463
RH99P	Adjustable (9 settings): 0, 0.06, 0.15, 0.23, 0.31, 0.5, 0.8, 1.0, 4.5 sec	Manual	12–24 Vac/12–48 Vdc	Adjustable (9 settings): 0.03 [7], 0.1, 0.3, 0.5, 1, 3, 5, 10, 30 A	56470TD	
			110–130 Vac		56472TD	
			220–240 Vac		56473TD	
		Automatic	12–24 Vac/12–48 Vdc		56490TD	
			110–130 Vac		56492TD	
			220–240 Vac		56493TD	

**Table 7.145: Sensors for Vigirex Ground-Fault Relays**

Sensors	Type	Maximum Current [8]	Inside Diameter		Cat. No.
			in.	mm	
Closed Toroids, Type A	TA30	65 A	1.18	30	50437
	PA50	85 A	1.97	50	50438
	IA80	160 A	3.15	80	50439
	MA120	250 A	4.72	120	50440
	SA200	400 A	7.87	200	50441
	GA300	630 A	11.81	300	50442
Vigirex Sensor Iron Rings (Optional)	TA30	65 A	0.79	20	56055
	PA50	85 A	1.58	40	56056
	IA80	160 A	2.76	70	56057
	MA120	250 A	4.33	110	56058
Split toroids, Type TOA	TOA80	160 A	3.15	80	50420
	TOA120	250 A	4.73	120	50421
Rectangular Sensors	280 x 115	1600 A	11.02 x 4.53	280 x 115	56053
	470 x 160	3200 A	18.50 x 6.30	470 x 160	56054



7 MINIATURE AND MOLDED CASE CIRCUIT BREAKERS

[7] 30 mA is instantaneous only, except for RH99M and RH99P models. Their suffix TD indicates time delay at 30 mA. For models with no time delay (IEC compliant) consult catalog 0972CT0401.  
[8] Use as a guideline for sizing wire through sensor.

MasterPacT NT and NW Circuit Breakers

The MasterPacT NT and NW universal power circuit breakers offer a family of circuit protection products meeting the most common world standards, ANSI, UL and IEC. The basic design platform for each is common. The final result is UL, ANSI and IEC circuit breakers with the same basic external dimensions, features and accessories.



- Complete product offering up to 200 k AIR without fuses
- Circuit breakers tested to show arc flash hazard risk category as referenced by NFPA70E
- 800 A to 6000 A frames, fixed and draw-out
- Rated for AC voltage systems through 600 V (635 V ANSI)
- Short-time withstand ratings up to 100 kA
- Cradle position indicator: connected, test and disconnected
- Simple, visual contact wear indicators
- Full complement of field-installable accessories common to all standards
- Four interchangeable MicroLogic trip units to choose from
- Available PowerLogic™ based power metering and monitoring capabilities
- Available protective relay functions as defined by ANSI C37.2 and C37.90

The following charts show the MasterPacT NW and NT ratings for ANSI and UL 489. See the Catalog 0613CT0001.

Table 7.146: MasterPacT NW Circuit Breaker Ratings

Standard Frame Rating Interrupting Code	ANSI C37 Certified/UL 1066 Listed																		UL 489 Listed															
	800–1600 A						2000 A						3200/4000 A [9]						4000/5000 A				800/1200/1600/2000 A				2500/3000 A		4000/5000/6000 A					
	N1	H1	H2	H3	L1 [10]	L1F [10]	H1	H2	H3	L1 [10]	L1F [10]	H1	H2	H3	L1 [10]	H2	H3	L1 [10]	N	H	L [10]	LF [10]	H	L [10]	H	L [10]								
Interrupting Current (kA RMS) 50/60 Hz	240 Vac	42	65	85	100	200	200	65	85	100	200	200	65	85	100	200	85	100	200	65	100	200	200	100	200	100	200							
	480 Vac	42	65	85	100	200	200	65	85	100	200	200	65	85	100	200	85	100	200	65	100	150	150	100	150	100	150							
	600 Vac	42	65	85	85	130	130	65	85	85	130	130	65	85	85	130	85	85	130	50	85	100	100	85	100	85	100							
Short-time Withstand Current (kA RMS)	42	65	85	85	30	22	65	85	85	30	22	65	85	85	100	85	85	100	42 [11]	65 [11]	30 [11]	22 [12]	22	65	65	85	100							
Built-in Instantaneous Override (kA RMS ±10%)	35 [13]	35 [13]	35 [13]	85	35 [13]	24	—	—	85	35	24	—	—	85	117	—	—	117	40	40	35 [11]	24 [14]	24	65	65	75	75							
Close and latch rating (kA RMS)	42	65	40	40	25	22	65	40	40	25	22	65	40	40	40	85	75	40	40	40	25 [15]	22	40	40	40	40	40							
Tested to show arc flash hazard risk category as referenced by NFPA70E	—	—	—	—	—	Yes	—	—	—	—	Yes	—	—	—	—	—	—	—	—	—	—	Yes	—	—	—	—	—							
Breaking time	25–30 ms with no intentional delay (9 ms for L1, L1F, L and LF)																																	
Closing time	70 ms																																	
Sensor Rating	100–250 A 400–800 A 800–1600 A						1000–2000 A						1600–3200 A						2000–4000 A 2500–5000 A						100–250 A 400–800 A 600–1200 A 800–1600 A 1000–2000 A				1200–2500 A 1600–3000 A		2000–4000 A 2500–5000 A 3000–6000 A			
Endurance Rating (C/O Cycles) With No Maintenance	Mechanical	12,500						10,000						10,000						5k	5,000						12,500 [16]				10,000		5,000	
	Electrical	2800						1,000						1,000						1k	1,000						2800 [16]				1,000		1,000	

[9] 4000 A standard width circuit breaker is not available in L1 interrupting rating code or drawout construction (fixed mounting only).  
 [10] Drawout mounted only.  
 [11] 24 kA RMS for 800 A circuit breaker frame with 100 A or 250 A sensor.  
 [12] 65 kA RMS for 2000 A.  
 [13] None except 24 kA RMS for 800 A circuit breaker frame with 100 A or 250 A sensor.  
 [14] 65 kA RMS for 2000 A.  
 [15] 40 kA RMS for 2000 A.  
 [16] The endurance rating for 2000 A, N/H/L/LF is 10,000 for mechanical and 1000 for electrical.

**Table 7.147: MasterPacT NT Circuit Breaker Ratings**

Standard Frame Rating Interrupting Code		ANSI C37 Certified/ UL 1066 Listed	UL 489 Listed													
		800 A	800 A					1200 A					1600 A [17]			
		N1	N	H	L1	L	LF [18]	N	H	L1	L	LF [18]	N	H	L1	L
Interrupting Current (kA RMS) 50/60 Hz	240 Vac	42	50	65	100	200	200	50	65	100	200	200	50	65	100	200
	480 Vac	42	50	50	65	100	100	50	50	65	100	100	50	50	65	100
	600 Vac	—	35	50	—	—	—	35	50	—	—	—	35	50	N/A	N/A
Short-time Withstand Current (kA RMS)		42	35	35	10	10	10	35	35	10	10	10	35	35	10	10
Built-in Instantaneous Override (kA RMS ±10%)		—	40	40	10	10	10	40	40	10	10	10	40	40	10	10
Close and latch rating (kA RMS)		40	25	25	10	10	10	25	25	10	10	10	25	25	10	10
Tested to show the arc flash hazard risk category as referenced by NFPA70E		—	—	—	—	—	Yes	—	—	—	—	Yes	—	—	—	—
Breaking time		25–30 ms with no intentional delay	25–30 ms with no intentional delay (9 ms for L and LF)													
Closing time		< 50 ms														
Sensor Rating		100–250 A	100–250 A					600–1200 A					800–1600 A			
		400–800 A	400–800 A					—					—			
Endurance Rating (C/O Cycles) With No Maintenance	Mechanical	12,500	12,500					12,500					12,500			
	Electrical	2800	2800					2800					2800			



NWMPRR

**Table 7.148: MasterPacT NW/NT Circuit Breaker Remote Racking**

Description	Cat. No.
MasterPacT NW/NT/MTZ1/2/3 Remote Racking Devices [19]	LV839291SP
MasterPacT NW/MTZ2/3 Remote Racking Device [19]	LV839292SP
MasterPacT NT/MTZ1 Remote Racking Device [19]	LV839293SP
Mounting Bracket Kit for NW/MTZ2/3 Remote Racking (contains 10 mounting brackets) [20]	LV839294SP
Mounting Bracket Kit for NT/MTZ1 Remote Racking (contains 10 mounting brackets) [20]	LV839295SP
Control Unit for NW/NT/MTZ1/2/3 Remote Racking [20]	S47101
30 ft Control Cable for NW/NT/MTZ1/2/3 Remote Racking [20]	S47102
Drive Shaft for NW/MTZ2/3 Remote Racking [20]	S47103
Drive Shaft for NT/MTZ1 Remote Racking [20]	S47105

[17] Fixed mounted only.  
 [18] Drawout mounted only.  
 [19] Unit comes with 10 mounting brackets included.  
 [20] For replacement only.

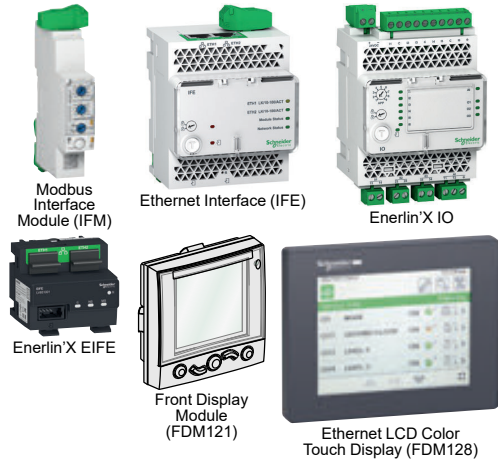

**Enerlin'X System for MicroLogic Trip Units**

Enerlin'X Systems enable network connectivity for MasterPacT and PowerPacT circuit breakers to provide remote monitoring, control & alarming features which is central to the Smart Systems Architecture with Square D low voltage distribution equipment.

Enerlin'X interface modules support Smart System Applications by facilitating access to circuit breaker data that provides performance information, circuit breaker status, metering measurements and various maintenance alert indicators such as contact wear, operation counters, load profile etc.

**Table 7.149: Communications and IO Interface Modules and Front Display Screens for MasterPacT MTZ/NT/NW and PowerPacT H/J/L/P/R Circuit Breakers**

Description	Part Number
IFM Modbus-SL Interface for LV Circuit Breaker	LV434000
IFE Interface (Ethernet Module)	LV434001
IFE Interface + Gateway (Ethernet and ModbuGateway)	LV434002
EIFE embedded Ethernet interface for drawout MasterPacT MTZ	LV851001SP
EIFE Spare part kit for one MasterPacT MTZ1 drawout circuit breaker	LV851100SP
EIFE Spare part kit for one MasterPacT MTZ2/MTZ3 drawout circuit breaker	LV851200SP
IO Module (Input/Output Programmable Module)	LV434063
FDM121 (1 Circuit Breaker to 1 Front Display over ULP) <sup>[1]</sup>	STRV00121
FDM128 (8 Circuit Breakers to 1 Front Display over Ethernet)	LV434128

[1] The FDM121 is not compatible with MasterPacT MTZ circuit breakers.

Enerlin'X System Accessories

Accessories for Enerlin'X Modules

Table 7.150: Accessories for Interfacing Enerlin'X Modules with MasterPacT MTZ/NT/NW and PowerPacT H/J/L/P/R Circuit Breakers

Description	Part Number	
Circuit Breaker ULP Cord—BCM to Enerlin'X Interface Module	L = 0.35 m (1.15 ft.)	LV434195
	L = 1.3 m (4.27 ft.)	LV434196
	L = 3 m (9.24 ft.)	LV434197
	L = 5 m (16.40 ft.)	LV434198
NSX ULP Cord for V ≤ 480 V for PowerPacT H/J/L	L = 1.3 m (4.27 ft.)	S434201
	L = 3 m (9.24 ft.)	S434202
NSX ULP Cord for V > 480 V for PowerPacT H/J/L	L = 1.3 m (4.27 ft.)	S434204
	L = 3 m (9.24 ft.)	S434203
BSCM (Breaker Status and Control Module) with NSX ULP Cord For PowerPacT H/J/L	L = 1.3 m (4.27 ft.)	S434201BX
	L = 3 m (9.24 ft.)	S434202BX
Replacement BSCM for Modbus SL or ULP for PowerPacT H/J/L	—	S434220
BSCM with NSX ULP Cord for V > 480 Vac for PowerPacT H/J/L	L = 1.3 m (4.27 ft.)	S434204BX
	L = 3 m (9.24 ft.)	S434303BX
BSCM with MB SL Cord for V ≤ 480Vac [2]	L = 3.0 m (9.84 ft.)	S434223BX
	L = 1.3 m (4.27 ft.)	S434222BX
	L = 0.35 m (1.15 ft.)	S434221BX
Modbus SL Cord for V ≤ 480Vac [2]	L = 3.0 m (9.84 ft.)	S434223
	L = 1.3 m (4.27 ft.)	S434222
	L = 0.35 m (1.15 ft.)	S434221
Modbus SL Hub for Daisy chain, 3x RJ45 connectors, DIN rail mount, stacking connector compatible [2]	—	S434224
ULP Cable, 10 Cables (Male to Male RJ45)	L = 0.3 m (0.98 ft.)	TRV00803
	L = 0.6 m (1.97 ft.)	TRV00806
ULP Cable, 5 Cables (Male to Male RJ45)	L = 1 m (3.28 ft.)	TRV00810
	L = 2 m (6.56 ft.)	TRV00820
	L = 3 m (9.84 ft.)	TRV00830
ULP Cable, 1 Cable (Male to Male RJ45)	L = 5 m (16.40 ft.)	TRV00850
RJ45 Female/Female Connector, 10 Connectors	—	TRV00870
ULP Line Terminator, 10 Terminators	—	TRV00880
Insulated ULP Module and Circuit Breaker Cord (for system voltage > 480 Vac) (Cord with female socket)	L = 1 m (3.28 ft.)	S434204
	L = 3 m (9.84 ft.)	S434203
Stacking Accessory (10 stacking accessories for IFM)	—	TRV00217
Adaptor Cable (for IFM V2 Modbus daisy chaining)	—	LV434211
Modbus Line Terminator for Screw Terminal, 2 Terminators	—	VW3A8306DRC
Modbus Line Terminator for RJ45 Terminal, 2 Terminators	—	VW3A8306RC
Surface-Mounting Accessory for FDM121	—	TRV00128
ULP Port Modules for:		
MasterPacT MTZ1 Fixed Circuit Breaker	—	LV850063SP
MasterPacT MTZ2/MTZ3 Fixed Circuit Breaker	—	LV850061SP
MasterPacT MTZ1 Drawout Circuit Breaker	—	LV850064SP
MasterPacT MTZ2/MTZ3 Drawout Circuit Breaker	—	LV850062
EIFE Cable for Drawout MasterPacT MTZ1 Circuit Breaker	—	LV851120SP
EIFE Cable for Drawout MasterPacT MTZ2/MTZ3 Circuit Breaker	—	LV851220SP

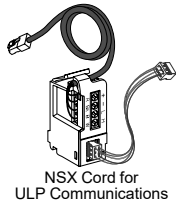

NSX Cord for ULP Communications

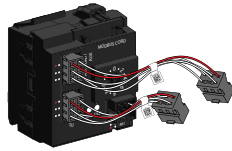

Breaker Status and Control Module (BSCM)

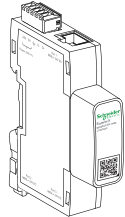

Modbus SL Hub



Modbus SL Cord



AD External Power Supply Module 24 Vdc



ABL8RPS24030



ABL8RPS24100

Recommended 24 Vdc Power Supplies

Available 24 Vdc power supplies include the range of Phaseo ABL8 modules and the AD modules:

- Schneider Electric Phaseo ABL8 power supplies (3 to 10 A, overvoltage category II) are recommended for large installations.
- Schneider Electric AD power supplies (1 A, overvoltage category IV) are recommended in the following cases:
  - For installations limited to a few IMUs.
  - As a power supply of MicroLogic trip units in MasterPacT NT/NW or PowerPacT P- and R-frame circuit breakers.

7

MINIATURE AND MOLDED CASE  
CIRCUIT BREAKERS

Table 7.151: Power Supply Modules for MicroLogic Trip Units and Enerlin'X Modules

Power Supply	Rating	Input-Output Voltage	Catalog No.
Schneider Electric AD Power Supply Primary overvoltage category IV Temperature: -25°C tp +70°C (-13°F to +158°F)	1 A	24/30 Vac, 24 Vdc	LV454440
		48/60 Vac, 24 Vdc	LV454441
		100/125 Vac, 24 Vdc	LV454442
		110/130 Vac, 24 Vdc	LV454443
		200/240 Vac, 24 Vdc	LV454444
Schneider Electric Phaseo ABL8 Power Supply Primary overvoltage category II Temperature: 0°C tp +60°C (32°F to +140°F) (derated to 80% of the current above 50°C [122°F])	3 A	100/500 Vac, 24 Vdc	ABL8RPS24030
	5 A	100/500 Vac, 24 Vdc	ABL8RPS24050
	10 A	100/500 Vac, 24 Vdc	ABL8RPS24100

[2] Modbus serial only ≤ 480Vac. Use only with matching Modbus serial components.



*New!*

**Communication Architecture - Modbus Direct MCCBs**

**NOTE:** Refer the Smart System Data Acquisition user guide (<https://www.schneider-electric.us/en/download/document/0614DB1801/>) to aid in component selection for Smart Systems.

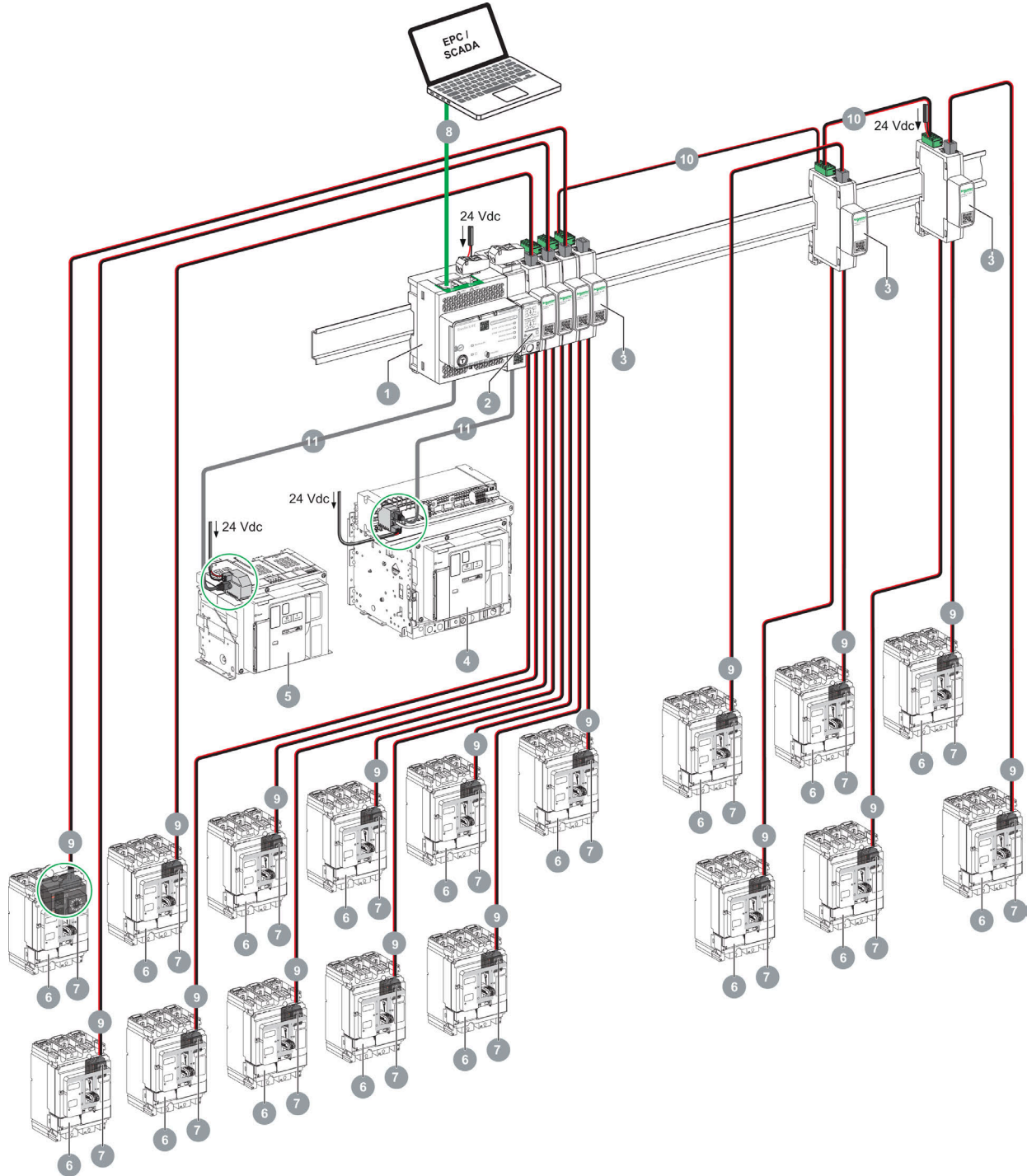
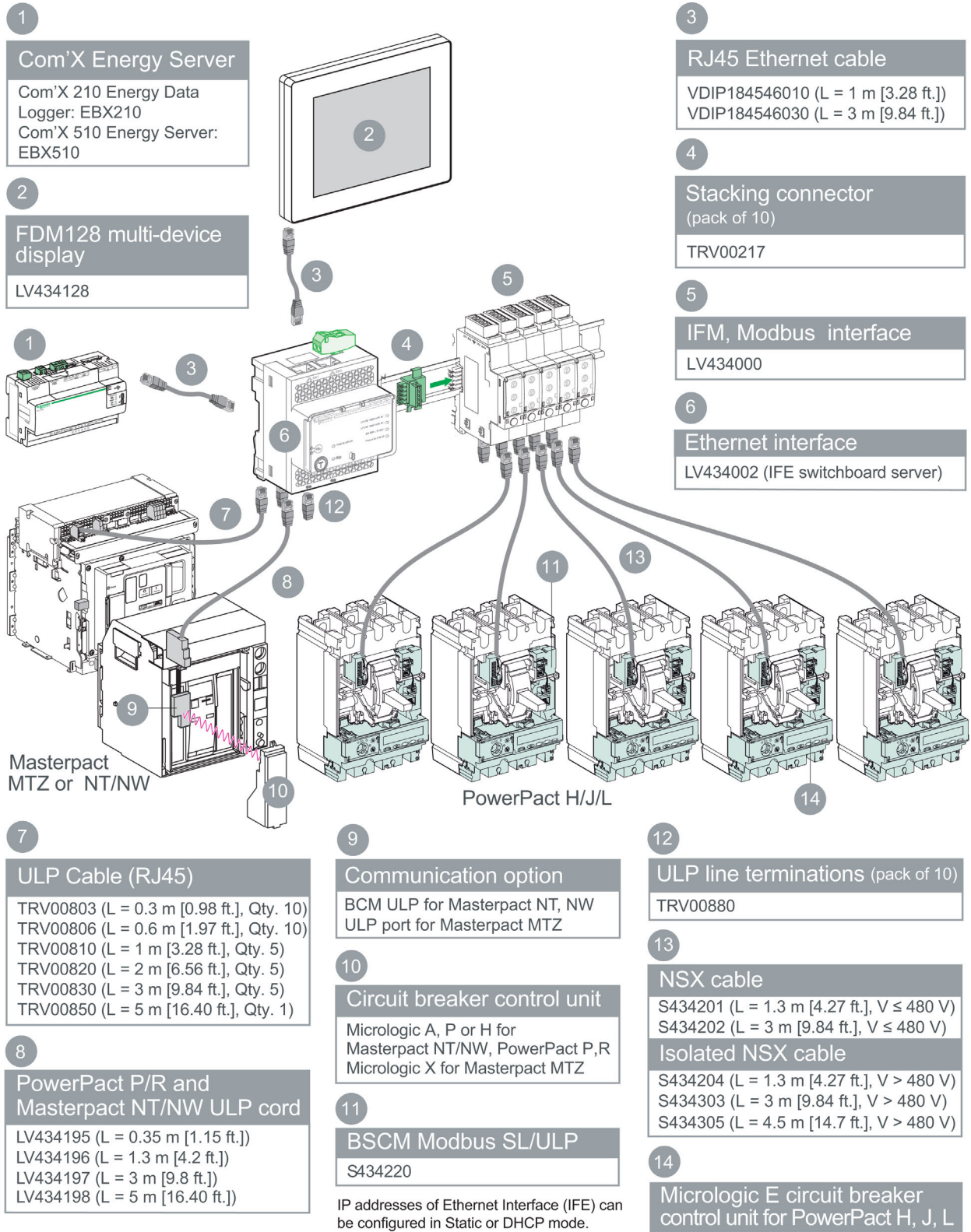

**Table 7.152: Legend**

1	IFE (LV434001/LV434002)	7	BSCM MBSL/ULP (S434220)
2	IFM (LV434000)	8	Ethernet
3	Modbus SL hub (S434224)	9	BSCM MBSL cord (S434221/S434222/S434223)
4	Drawout MasterPacT™ MTZ1/MTZ2/MTZ3	10	Modbus cord
5	Fixed MasterPacT MTZ1/MTZ2/MTZ3	11	ULP cord
6	ComPacT NSX/PowerPacT H-, J-, L-Frame		

Hybrid Communication—Ethernet and Modbus

**NOTE:** Refer the Smart System Data Acquisition user guide (<https://www.schneider-electric.us/en/download/document/0614DB1801/>) to aid in component selection for Smart Systems.



**1**  
Com'X Energy Server  
Com'X 210 Energy Data  
Logger: EBX210  
Com'X 510 Energy Server:  
EBX510

**2**  
FDM128 multi-device  
display  
LV434128

**3**  
RJ45 Ethernet cable  
VDIP184546010 (L = 1 m [3.28 ft.])  
VDIP184546030 (L = 3 m [9.84 ft.])

**4**  
Stacking connector  
(pack of 10)  
TRV00217

**5**  
IFM, Modbus interface  
LV434000

**6**  
Ethernet interface  
LV434002 (IFE switchboard server)

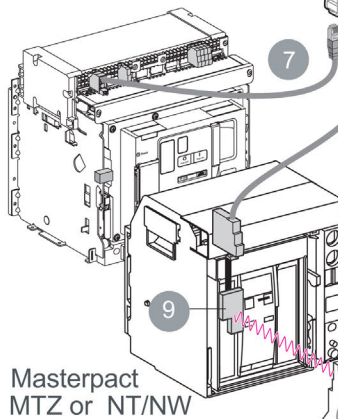
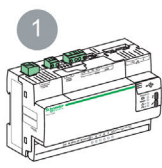

**7**  
ULP Cable (RJ45)  
TRV00803 (L = 0.3 m [0.98 ft.], Qty. 10)  
TRV00806 (L = 0.6 m [1.97 ft.], Qty. 10)  
TRV00810 (L = 1 m [3.28 ft.], Qty. 5)  
TRV00820 (L = 2 m [6.56 ft.], Qty. 5)  
TRV00830 (L = 3 m [9.84 ft.], Qty. 5)  
TRV00850 (L = 5 m [16.40 ft.], Qty. 1)

**8**  
PowerPact P/R and  
Masterpact NT/NW ULP cord  
LV434195 (L = 0.35 m [1.15 ft.])  
LV434196 (L = 1.3 m [4.2 ft.])  
LV434197 (L = 3 m [9.8 ft.])  
LV434198 (L = 5 m [16.40 ft.])

**9**  
Communication option  
BCM ULP for Masterpact NT, NW  
ULP port for Masterpact MTZ

**10**  
Circuit breaker control unit  
Micrologic A, P or H for  
Masterpact NT/NW, PowerPact P,R  
Micrologic X for Masterpact MTZ

**11**  
BSCM Modbus SL/ULP  
S434220

IP addresses of Ethernet Interface (IFE) can  
be configured in Static or DHCP mode.

**12**  
ULP line terminations (pack of 10)  
TRV00880

**13**  
NSX cable  
S434201 (L = 1.3 m [4.27 ft.], V ≤ 480 V)  
S434202 (L = 3 m [9.84 ft.], V ≤ 480 V)  
Isolated NSX cable  
S434204 (L = 1.3 m [4.27 ft.], V > 480 V)  
S434303 (L = 3 m [9.84 ft.], V > 480 V)  
S434305 (L = 4.5 m [14.7 ft.], V > 480 V)

**14**  
Micrologic E circuit breaker  
control unit for PowerPact H, J, L

**Communications—Direct Ethernet**

**NOTE:** Refer the Smart System Data Acquisition user guide (<https://www.schneider-electric.us/en/download/document/0614DB1801/>) to aid in component selection for Smart Systems.

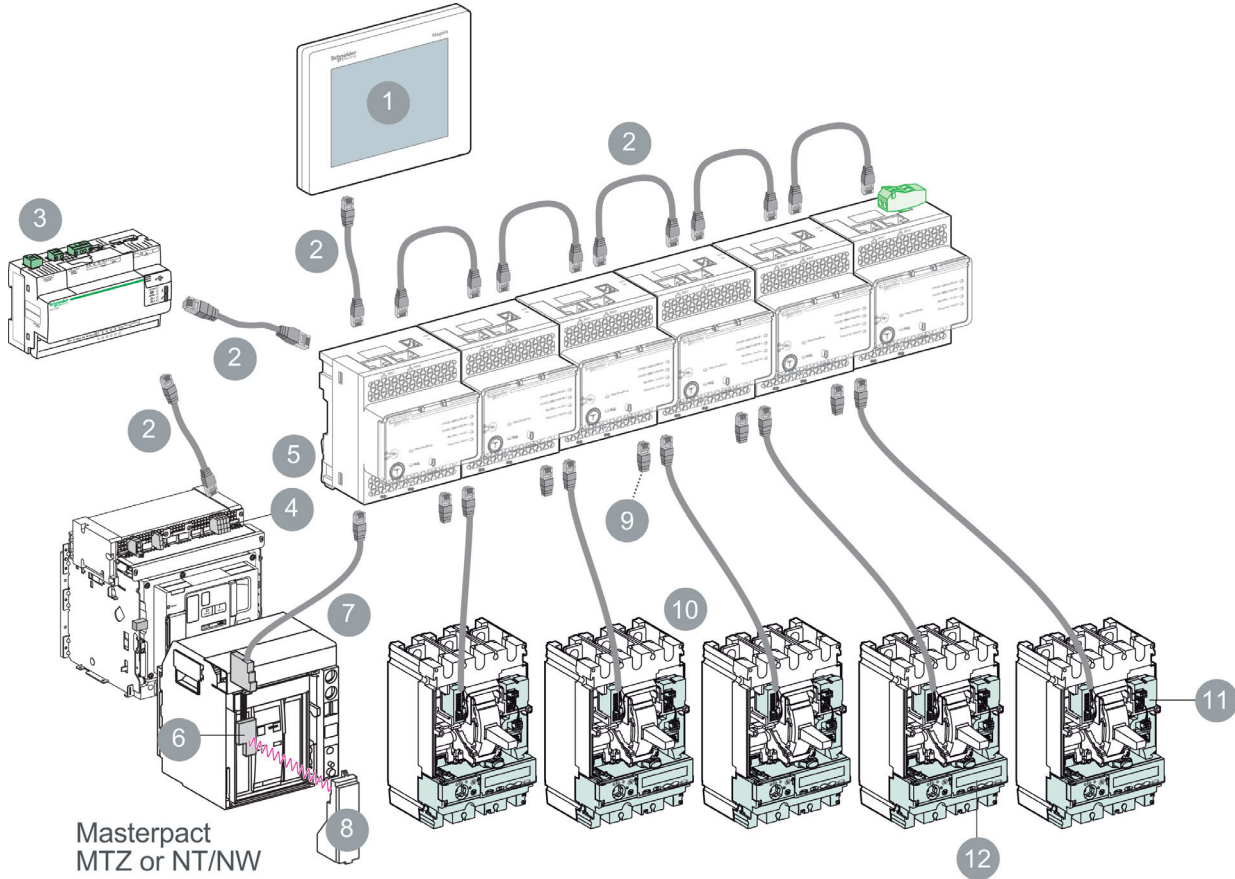

**1**  
FDM128 Multi-Device Display  
LV434128

**2**  
RJ45 Ethernet Cable  
VDIP184546010 (L = 1 m [3.28 ft.])  
VDIP184546030 (L = 3 m [9.84 ft.])

**3**  
Com'X Energy Server  
Com'X 210 Energy Data Logger: EBX210  
Com'X 510 Energy Server: EBX510

**4**  
EIFE Embedded Ethernet Interface  
LV851120SP

IP addresses of Ethernet Interface (IFE) can be configured in Static or DHCP mode.

**5**  
IFE Ethernet Interface  
LV434001

**6**  
Communication Option  
BCM ULP for Masterpact NT, NW  
ULP port for Masterpact MTZ

**7**  
PowerPact P/R and Masterpact NT/NW ULP Cord  
LV434195 (L = 0.35 m [1.15 ft.])  
LV434196 (L = 1.3 m [4.27 ft.])  
LV434197 (L = 3 m [9.24 ft.])  
LV434198 (L = 5 m [16.40 ft.])

**8**  
Circuit breaker control unit  
Micrologic A, P or H for Masterpact NT/NW, PowerPact P,R  
Micrologic X for Masterpact MTZ

**9**  
ULP line terminations (pack of 10)  
TRV00880

**10**  
NSX cable  
S434201 (L = 1.3 m [4.27 ft.], V ≤ 480 V)  
S434202 (L = 3 m [9.84 ft.], V ≤ 480 V)  
Isolated NSX cable  
S434204 (L = 1.3 m [4.27 ft.], V > 480 V)  
S434303 (L = 3 m [9.84 ft.], V > 480 V)  
S434305 (L = 4.5 m [14.7 ft.], V > 480 V)

**11**  
BSCM Modbus SL/ULP  
S434220

**12**  
Micrologic E circuit breaker control unit for PowerPact H, J, L

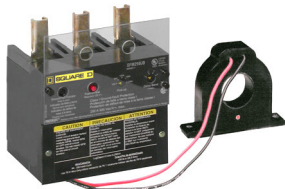

GFM250 with Optional GFM25CT

**MicroLogic™ Add-on Ground-Fault Module (GFM)**

The MicroLogic Ground-Fault Module (GFM) is a UL Listed/CSA Certified circuit breaker accessory which protects equipment from damage caused by ground faults. It is an add-on module which, when connected to a PowerPacT H- or J-frame thermal-magnetic circuit breaker only, provides ground-fault sensing and ground-fault relay functions.

HD/JD ground-fault modules feature:

- Adjustable ground-fault pickup levels
- Adjustable ground-fault time delays
- Integral ground fault push-to-test feature
- Ground-fault indicator (mechanical for local, contacts for remote)
- All GFMs are supplied for I-Line™ mounting as standard, easily convertible to unit mount by removing the I-Line bracket
- Fault-powered (through the sensing current transformer) for electronics, shunt trip, and integral test feature. Meets NEC 230.95(C)
- A 12 Vdc shunt trip module (Catalog No. P29382) is required in the circuit breaker. This may be field installed or factory installed when the circuit breaker is ordered with an -SN suffix.
- UL 1053 — Ground-fault Sensing and Relaying Equipment

The GFM system requires the following:

- H-frame (15–150 A) or J-frame (150–250 A) molded case circuit breaker
- Shunt trip is required for the function of the GFM (may be factory-installed or field-installed)
- Bus bar connection (terminal nut inserts) for OFF end of circuit breaker
- Optional neutral current transformer, catalog number GFM25CT (must be ordered for 4-wire applications). NOTE: Ground-fault modules cannot be used for alarming only.

**Table 7.153: Module/Enclosure Selection Chart [1]**

Companion Circuit Breaker Prefix	Cat. No. [2]	I-Line Switchboard	Ground-fault Pickup Adjustment Range
HD, HG, HJ, HL	GFM150HD	LA	20–100 A
JD, JG, JJ, JL	GFM250JD	LA	40–200 A
Accessories			
H & J	GFM25CT	Optional Neutral Current Transformer (required for 4-wire loads)	

**Earth Leakage Module (ELM) for PowerPacT H- and J-Frame MCCBs**

The Earth Leakage Module (ELM) is an add-on module which, when connected to a PowerPacT H- or J-frame MCCB, provides low-level ground-fault sensing and ground-fault relay functions.

Because these ELMs are highly sensitive (30 mA to 3 A), they provide much greater protection than GFMs (20 to 200 A sensitivity). The ELMs provide greater protection of control circuits and other sensitive equipment. The associated circuit breaker must have a 48 Vdc shunt trip, which may be field-installed (kit P29392) or factory-installed (suffix –SP) in the H- or J-Frame circuit breaker.

Add-on Earth Leakage Module (ELM) Features:

- Adjustable ground-fault pickup levels as low as 30 mA
- Adjustable ground-fault time delays from instantaneous to 500 msec (Time delay can be applied to the 30 mA setting)
- Integral ground fault push-to-test feature
- Ground-fault indicator; pop-up button for local status and contacts for remote indication (to be used only with the tripping option)
- All ELMs are supplied for I-Line™ mounting and are easily convertible to unit-mount by removing the I-Line brackets
- Three poles; 240 to 600 Vac maximum: 3-wire applications only (no neutral)
- Line-power obtained through internal bus to provide power for electronics, shunt trip, and integral test feature.
- A shunt trip is required in the circuit breaker; it may be field-installed or factory-installed in the PowerPacT H and J circuit breakers.
- UL 1053 – Ground-fault Sensing and Relaying Equipment

**Table 7.154: ELM Selection Chart [3]**

Companion Circuit Breaker [4]	Enclosure Space Required I-Line Switchboard	Pick-Up Adjustment Range	Catalog Number
HD, HG, HJ, HL	LA	30 mA–3 A	ELM150HD
JD, JG, JJ, JL	LA	30 mA–3 A	ELM250JD



J-Frame Unit Mount with ELM Installed

[1] At 250 A, the GFM250JD can be used with 80% rated circuit breakers only.

[2] See Supplemental Digest Section 3 for additional GFMs.

[3] At 250 A, the ELM250JD can be used with 80% rated circuit breakers only.

[4] For Factory Installation of ELM Module: For termination designation (3rd letter of catalog number) use ONLY "M". Add factory installed 48 Vdc shunt trip (suffix SP) to breaker plus suffix VL or VM.

**Miniature and Molded Case Circuit Breaker Dimensions**

**Table 7.155: QO™, QOU, Multi9™ Circuit Breakers**

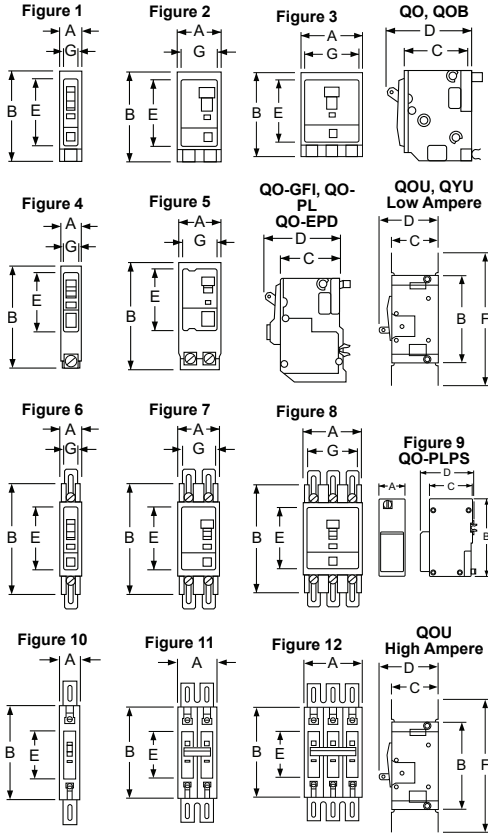

Circuit Breaker Cat. No. Prefix	Poles	Fig. No.	Dimensions—Inches						
			A	B	C	D	E	F	G
QO, QOB	1	1	0.75	3.00 [1]	2.31	2.91	2.25	—	0.59
	2	2	1.50	3.00 [1]	2.31	2.91	2.25	—	1.34
	3	3	2.25	3.00 [1]	2.31	2.91	2.25	—	2.09
QOB-VH 150 A QOB-VH 110–150 A	2	2	3.0	5.72	2.53	4.90	3.78	—	2.85
	3	3	4.50	5.72	2.53	4.90	3.78	—	4.35
QO-PL QO-GFI QO-EPD	1	4	0.75	4.12 [2]	2.31	2.91	2.25	—	0.59
	2	5	1.50	4.12 [2]	2.31	2.91	2.25	—	1.34
	3	5	2.25	4.12 [2]	2.31	2.91	2.25	—	2.09
QOU QYU Low Ampere	1	6	0.75	4.05 [3]	2.38	2.98	2.25	5.00 [4]	0.62
	2	7	1.50	4.05 [3]	2.38	2.98	2.25	5.00 [4]	1.37
	3	8	2.25	4.05 [3]	2.38	2.98	2.25	5.00 [5]	2.12
QOU High Ampere	1	10	0.75	4.45	2.37	2.96	2.25	6.78	—
	2	11	1.50	4.45	2.37	2.96	2.25	6.78	—
	3	12	2.25	4.45	2.37	2.96	2.25	6.78	—
Multi9™ C60	1	13	0.71	3.19	1.73	2.76	1.77	—	—
	2	14	1.42	3.19	1.73	2.76	1.77	—	—
	3	15	2.13	3.19	1.73	2.76	1.77	—	—
	4	16	2.84	3.19	1.73	2.76	1.77	—	—
QO-PLPS Power Supply	2	9	1.45	4.35	2.42	3.11	—	—	—

**Table 7.156: QB, QD, QG, QJ, Q4, FA, LA, Circuit Breakers**

Circuit Breaker Cat. No. Prefix	Poles	Fig. No.	Dimensions—Inches							
			A	B	C	D	E	F	G	H
QB, QD, QG, QJ	2	22	6.47	3.00	3.02	3.93	[6]	4.25	—	—
	3	23	6.47	4.50	3.02	3.93	[6]	4.25	1.50	0.75
FAL, FHL	1	21	6.00	1.50	3.16	4.13	0.44	5.13	1.50	—
	2	22	6.00	3.00	3.16	4.13	0.44	5.13	—	—
	3	23	6.00	4.50	3.16	4.13	0.44	5.13	1.50	0.75
Q4L, LAL, LHL	2 & 3	23	11.00	6.00	4.06	5.84	0.88	9.25	2.00	1.00

**Table 7.157: Shipping Weights [7]**

Frame Size	Approx. Shipping Weight (Lbs.)	Frame Size	Approx. Shipping Weight (Lbs.)
FAL, FHL 1P	2	QB, QD, QG, QJ	4
FAL, FHL 2P	3	LAL, LHL	15
FAL, FHL 3P	5	Q4L	15

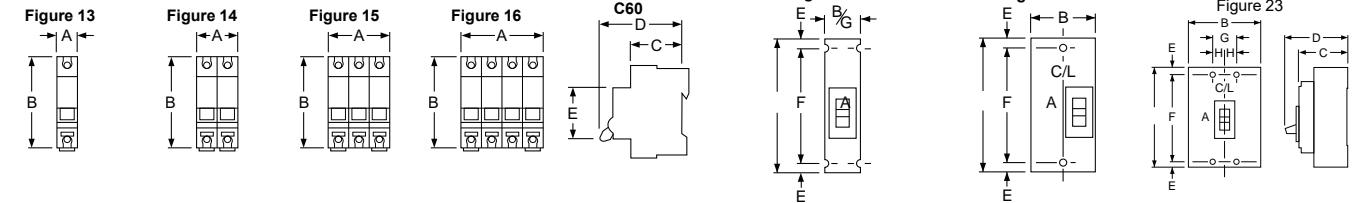

[1] 35–70 A is 3.12 in; 80–100 A 2P and 70–100 A 3P are 3.50 in.  
 [2] QO-PL is 4.55 in.  
 [3] 80–100 A 1P and 80–125 A 2P are 4.45 in.  
 [4] 80–100 A 1P and 80–125 A 2P are 6.78 in.  
 [5] 70–100 A is 6.78 in.  
 [6] Dimensions E are 1.59 in at ON end and 0.63 in at OFF end.  
 [7] All weights are for 3P circuit breakers unless otherwise noted.

Molded Case Circuit Breaker Dimensions

Table 7.158: PowerPacT B-, H-, J-, and L-Frame Circuit Breakers

Circuit Breaker Frame	No. of Poles	Fig. No.	Dimensions — Inches							
			A	B	C	D	E	F	G	H
B-Frame	1	35	6.79	1.06	3.15	4.01	0.20	6.33	—	5.39
	2	36	6.22	2.12	3.15	4.01	0.86	4.48	—	5.39
	3	37	6.22	3.19	3.15	4.01	0.86	4.48	1.06	5.39
	4	38	6.22	4.25	3.15	4.01	0.86	4.48	2.12	5.39
H-Frame	2 [8]	25	6.40	2.74	2.87	4.36	0.74	4.92	—	—
	3	26	6.40	4.12	2.87	4.36	0.74	4.92	1.38	—
J-Frame	3	27	7.52	4.12	2.87	5.00	1.30	4.92	1.38	—
L-Frame	3	28	13.38	5.51	3.75	6.61	2.22	7.87	1.77	—

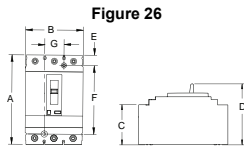
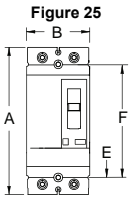

Figure 27

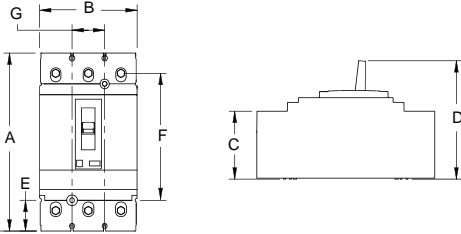

Figure 28

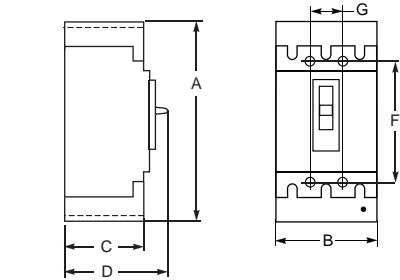

Figure 29

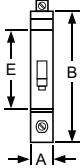

Figure 30



Figure 31

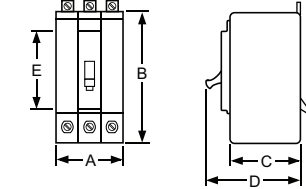

Figure 32

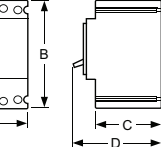

Figure 33

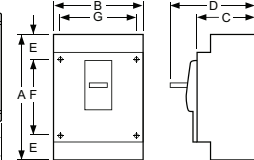

Figure 34

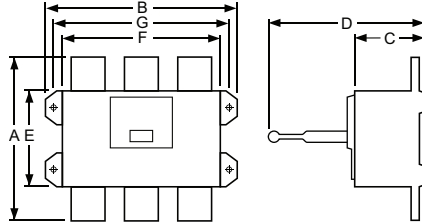

Figure 35

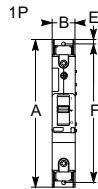

Figure 37

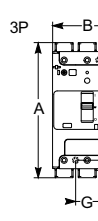

Figure 36

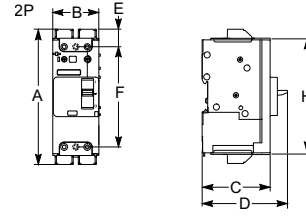

Figure 38

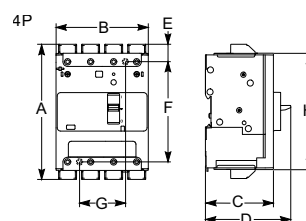

Table 7.159: ED, EG, EJ, and GJ Circuit Breakers

Circuit Breaker Cat. No. Prefix	No. of Poles	Fig. No.	Dimensions — Inches				
			A	B	C	D	E
ED, EG, EJ	1	29	0.98	5.66	3.09	4.05	3.32
ED, EG, EJ	2	30	1.96	5.66	3.09	4.05	3.32
ED, EG, EJ	3	31	2.94	5.66	3.09	4.05	3.32
GJ	3	32	3.54	4.72	2.76	3.94	2.20

Table 7.160: PowerPacT M-, P-, and R-Frame Circuit Breakers

Circuit Breaker Frame	No. of Poles	Fig. No.	Dimensions — Inches						
			A	B	C	D	E	F	G
M-Frame (800 A and below)	2, 3	33	12.86	8.27	5.77	8.05	2.49	7.87	7.83
P-Frame (1000–1200 A)	2, 3	33	16.16	8.27	5.77	8.05	4.19	7.87	7.83
R-Frame	2, 3	34	16.24	16.54	6.63	14.49	8.73	14.25	15.35

Table 7.161: Shipping Weights [9]

Frame Size	Approx. Shipping Weight (Lbs.)	Frame Size	Approx. Shipping Weight (Lbs.)
B-Frame 1P	1	H-Frame 2P	4
B-Frame 2P	2	H-Frame 3P	5
B-Frame 3P	3	J-Frame	5
B-Frame 4P	4	L-Frame	14
EDB 1P	2	M-Frame	29
EDB 2P	3	P-Frame	32
EDB 3P	4	R-Frame (Without RLTB)	52

[8] Only HD and HG are in 2P module, HJ, HL and HR 2P are in 3P module.

[9] All weights are for 3P circuit breakers unless otherwise noted.

**PowerPacT Circuit Breaker Enclosures**

- The enclosures for the family of PowerPacT circuit breakers B- through Q-frame are cULus listed unless otherwise noted.
- The enclosures are suitable for service entrance equipment when neutral assembly is installed.
- The short circuit current rating of the enclosed circuit breakers is equal to the rating of the circuit breaker installed unless otherwise noted.
- All enclosures will accept 100% rated circuit breakers unless otherwise noted.

**PowerPacT B-Frame Circuit Breaker Enclosures**

- The enclosures' maximum short circuit ratings are 65 kA at 600V, 65 kA at 480 Vac, 100 kA at 240 Vac and 50 kA at 250 Vdc unless otherwise noted.
- Enclosures accept 100% rated circuit breakers [8].

**Table 7.162: PowerPacT B-Frame Circuit Breaker Enclosures**

Circuit Breaker			Enclosure Catalog Number			Accessory Catalog Number	
Cat. No. Prefix	Rating	Poles				Neutral Assembly Kit	Service Ground Kit
			NEMA 1 Flush	NEMA 1 Surface	NEMA 3R		
BDL, BGL, BJL	15–100 A	2, 3	B125F	B125S	B125RB	SN100FA	PKOGTA2
BDL, BGL, BJL	110–125 A	2, 3				SN225KA	
BKL	15–30 A	2				SN100FA	
			NEMA 4, 4X, 5 Type 304 Stainless Steel	NEMA 12 With Knockouts	NEMA 12 Without Knockouts		
BDL, BGL, BJL	15–100 A	2, 3	B125DS	B125A	B125AWK[1]	SN100FA	PKOGTA2
BDL, BGL, BJL	110–125 A	2, 3				SN225KA	
BKL	15–30 A	2				SN100FA	

**PowerPacT™ H- and J-Frame Circuit Breaker Enclosures**

The enclosures' maximum short circuit ratings are 25 kAIR at 600 Vac, 65 kAIR at 480 Vac, 125 kAIR at 240 Vac and 20 kA at 250 Vdc unless otherwise noted. Enclosures accept 100% rated circuit breakers [2]. The enclosures are not compatible with earth-leakage or ground-fault modules.

H- and J-frame circuit breakers with MicroLogic trip units can be used with these enclosures, but have the following limitations:

- No communication accessories can be mounted in the enclosure (no IFM or Front Display Module, IFE, etc).
- The trip unit will not be accessible or visible without the removal of the cover (except J250F and J250S).
- For LSIG, there is no room for the NCT to mount in the enclosure.

**Table 7.163: PowerPacT H- and J-Frame Circuit Breaker Enclosures**

Circuit Breaker			Enclosure Cat. No.			Neutral Assembly Kit Cat. No.	Service Ground Kit Cat. No.
Cat. No. Prefix	Rating	Poles					
			NEMA 1 Flush	NEMA 1 Surface	NEMA 3R		
HDL	15–100 A	3	—	HD100S [3][4][5]	—	SN100FA	PKOGTA2
HDL, JDL	125–225 A	3	—	JD250S [6][4][5]	—	SN225KA	PKOGTA2
	125–250					SN400LA	
HDL, HGL	15–100 A	2	H150F	H150S	H150R [7]	SN100FA	PKOGTH150
	125–150 A	2				SN400LA	
HJL, HLL	15–100 A	2	J250F	J250S [8]	J250R [7][9]	SN100FA	PKOGTH150
HDL, HGL, HJL, HLL	15–100 A	3				SN400LA[10]	
	125–150 A	3					
JDL, JGL, JLL, JLL	150–250 A	2, 3					PKOGTJ250
			NEMA 4, 4X, 5 [11] Type 304 Stainless Steel [12]	NEMA 4, 4x, 5 [11] Type 316 Stainless Steel [12]	NEMA 12/3R Without Knockouts [12]		
HDL, HGL, HJL, HLL	15–100 A	2, 3	J250DS [13]	J250SS [13]	J250AWK [13]	SN100FA	PKOGTH150
	125–150 A	2, 3				SN400LA[10]	
JDL, JGL, JLL, JLL	150–250 A	2, 3					

[1] For NEMA 3R applications, remove drain scerw from bottom end well.  
 [2] Use only 90°C (minimum) rated wire sized per ampacity of 75°C rated conductors for 100% rated circuit breakers.  
 [3] Rated for 240 Vac maximum. Short circuit current rating is 25 kAIR at 240 Vac.  
 [4] Accepts standard 80% rated circuit breakers only. Not rated for 100% rated circuit breakers.  
 [5] Use copper conductors only.  
 [6] Rated 480 Vac maximum. Short circuit current rating is 18 kAIR at 480 V.  
 [7] For conduit entry through the top end wall use one of the following Square D conduit hubs: A200L for 2.00 in., A250L for 2.50 in., A300L for 3.00 in., A350L for 3.50 in. or A400L for 4.00 in.  
 [8] Add suffix BE if no knockouts are required on the end walls.  
 [9] For access to the circuit breaker's standard, ammeter or energy trip unit panel/LCD, add suffix T.  
 [10] For 200% neutral use copper wire only.  
 [11] Complete rating is NEMA 3, 3R, 4, 4X, 5, and 12.  
 [12] For NEMA 3R applications, remove drain screw from bottom endwall.  
 [13] Add suffix VW for visibility to the standard, ammeter or energy trip unit of the PowerPacT circuit breaker.

**PowerPacT L-Frame Circuit Breaker and Molded Case Switch Enclosures**

All enclosures accept 80% rated circuit breakers. The enclosures will also accept 100% rated circuit breakers to 400 amps. The enclosures have a blank top end wall and require field-cut openings. For details and hub catalog numbers see page 3–10.

**Table 7.164: PowerPacT L-Frame Circuit Breaker Enclosures**

Circuit Breaker			Cat. No.			
Cat. No. Prefix	Rating	Poles	NEMA 12/3R Enclosures Without Knockouts	Neutral Assembly Kit	Copper Only Neutral Assembly Kit	Service Ground Kit
LDL, LGL, L JL, LLL, LRL	250–400 A	3	L600AWK [14][15][16]	SN400LA	SNC400LX	PKOGTA4
	400–600 A			SN1000MA	SNC800LX	
LGL, LLL, LRL	250–400 A	3	L600AWKMC [17][15]	SN400LA	SNC400LX	PKOGTA4
	400–600 A			SN1000MA	SNC800LX	

**PowerPacT Q-Frame Circuit Breaker Enclosures**

The enclosures for the PowerPacT Q Frame Circuit Breaker are UL listed. The short circuit ratings of these enclosed circuit breakers are equal to the interrupter ratings, at the supply voltage marked on the circuit breaker installed, unless otherwise noted.

**Table 7.165: PowerPacT Q-Frame Circuit Breaker Enclosures**

Circuit Breaker			Enclosure Cat. No.			Neutral Assembly Kit Cat. No.	Service Ground Kit Cat. No.
Cat. No. Prefix	Rating	Poles	NEMA 1 Flush	NEMA 1 Surface	NEMA 3R		
QBL, QDL, QGL, QJL [18]	70–225 A	2	—	Q22200NS [19]	Q22200NRB [19]	—	PKOGTA2
		2, 3	Q23225NF	Q23225NS	Q23225NRB		

**PowerPacT M- and P-Frame Circuit Breaker Enclosures**

All enclosures will accept 80% rated circuit breakers. The P1200 enclosures will accept 100% rated circuit breakers to 800 A. If a CT neutral is required, the enclosure will no longer accept a 200% neutral. The M800R and the P1200R enclosures have a blank top end wall and require field-cut openings. For details and hub catalog numbers see page 3–10.

**Table 7.166: PowerPacT M- and P-Frame Circuit Breaker Enclosures**

Circuit Breaker			Cat. No.						
Cat. No. Prefix	Rating	Poles	Enclosure			Neutral Assembly Kit	200% Neutral Kit	CT Neutral Kit [20][21]	Service Ground Kit
			NEMA 1 Flush	NEMA 1 Surface	NEMA 3R				
MGL, MJL, PGL, PJL, PKL, PLL	300–800 A	2, 3	—	M800S	M800R	AL800SN	SN800SNI and 2 each SN1200	S33576MK	PKOGTA4
			—	P1200S	P1200R	SN1200	—	S33576MK	PKOGTA4
			NEMA 4, 4X, 5 [22] Type 304 Stainless Steel [15]	NEMA 4, 4X, 5 [22] Type 316 Stainless Steel [15]	NEMA 12/3R Without Knockouts [15]				
MGL, MJL, PGL, PJL, PKL, PLL	300–800 A	2, 3	M800DS	M800SS	M800AWK	AL800SN	—	S33576MK	PKOGTA4
PGL, PJL, PKL, PLL	250–1200 A	2, 3	—	—	P1200AWK	SN1200	—	S33576MK	PKOGTA4

**PowerPacT L-Frame 500 Vdc Circuit Breaker Enclosures**

The PowerPacT L-frame circuit breaker enclosure's maximum short circuit rating is 20 kAIR at 250 Vdc and 50 kAIR at 500 Vdc.

Listed for use ONLY on UPS systems.

**Table 7.167: DC Circuit Breaker Enclosures for LG and LL DC-Rated Circuit Breakers**

Circuit Breaker [23]			Cat. No.		
Cat. No. Prefix	Ampere Rating	Poles	NEMA 1 Surface Enclosure	Replacement Ground Lugs	Service Ground Kit
LGL, LLL	300–600 A	3	L1200S	8010440301	Standard
	700–1200 A	4	L1200S		

[14] Will accept PowerPacT L-frame circuit breakers and Motor Protectors with suffixes M38X

[15] For NEMA 3R applications, remove drain screw from bottom endwall.

[16] Add suffix VW for visibility to the standard, ammeter or energy trip unit of the PowerPacT circuit breaker.

[17] Will accept PowerPacT L-frame Molded Case Switches.

[18] When the QJL circuit breaker is installed in the enclosure, the enclosure is limited to Short Circuit Current ratings of 65 kAIR at 240 V and 100 kAIR at 208 V.

[19] Limited to 200 A.

[20] Order current transformer kit S33576 separately.

[21] Current transformers applicable only on PowerPacT P circuit breakers. Current limitations are 400–800 A and 400–1200 A respectively for the M800 and P1200 family of enclosures.

[22] Complete rating is NEMA 3, 3R, 4, 4X, 5, and 12.

[23] Use 500 Vdc or 250 Vdc rated circuit breakers only.



**LA/LH Circuit Breaker Enclosures**  
**LA/LH Thermal-Magnetic Circuit Breaker Enclosures**



The enclosures for the LA/LH thermal-magnetic circuit breakers are UL listed and CSA certified. The enclosures are suitable for service entrance equipment when neutral assembly is installed. The short circuit ratings of these enclosed circuit breakers are equal to the interrupter rating, at the supply voltage marked on the circuit breaker installed.

The LA400R enclosure has a blank top end wall and requires field cut openings. For details and hub catalog numbers see Digest Section 3.

**Table 7.168: LA/LH Thermal-Magnetic Circuit Breaker Enclosures**

Circuit Breaker			Enclosure			Neutral Assembly Kit	Service Ground Kit
Cat. No. Prefix	Rating	Poles	Cat. No.	Cat. No.	Cat. No.	Cat. No.	Cat. No.
			NEMA 1 Flush	NEMA 1 Surface	NEMA 3R		
LAL, LHL	125–225 A	2, 3	LA400F [24]	LA400S [24]	LA400R	SN225KA	PKOGTA2
	225–400 A					400SN	
LAL	125–400	3	—	LA400LS [25] [26][27][28]	—	SN400LA	
			NEMA 4, 4X, 5 [29] Type 304 Stainless Steel [30]	NEMA 12K With Knockouts	NEMA 12/3R Without Knockouts [30]		
LAL, LHL	125–225 A	2, 3	LA400DS [27]	—	LA400AWK [27]	SN225KA	PKOGTA2
	225–400 A					SN400LA	

**Enclosures for Special Applications**

**Hazardous Locations: NEMA 7 And NEMA 9 Circuit Breaker Enclosures**

The NEMA 7 and 9 enclosures are cULus listed unless otherwise noted. They are rated for use in hazardous locations as defined in NEC Article 500. The short circuit current rating of the enclosed circuit breakers is equal to the rating of the circuit breaker installed unless otherwise noted. They are suitable for use as service entrance equipment when neutral is installed. Enclosures require the use of 75°C copper wire only. The NEMA 7 enclosures are suitable for rainproof applications when the included PKDB1 breather and drain kit is installed.

**Table 7.169: NEMA 7 and NEMA 9 Circuit Breaker Enclosures; Thermal-Magnetic B-Frame and PowerPacT J-Frame Circuit Breakers**

Circuit Breaker			Enclosure Catalog Number		Neutral Assembly Kit Cat. No.	Service Ground Kit Cat. No.	Threaded Conduit Provisions, Inches
Cat. No. Prefix	Rating	Poles	NEMA 7/9 Cast Aluminum [31][32]	NEMA 9 Cast Aluminum [32]			
BKL	15–30 A	2	B100X	—	100SNA	Included	1 1/4 in.
BDL, BGL, B JL	15–100 A	2, 3					
JDL, JGL	150–225 A	2, 3	J225X [33][34]	J225Y [33][34]	225SNA	Included	2 1/2 in.

**Enclosed Molded Case Switches**

For information on enclosed molded case switches, see Supplemental Digest Section 3.

[24] Enclosures are provided with the Handle Padlock Attachment (HPALM) for field installation to lock the circuit breaker in the "ON" or "OFF" positions.  
 [25] Use copper conductors only.  
 [26] Maximum short circuit and voltage is 30 kAIR at 480 Vac.  
 [27] LAL or LHL circuit breakers with an MB or MT suffix are not compatible with these enclosures: LA400DS, LA400AWK, and LA400LS.  
 [28] Enclosure cover has an integral padlock provision to provide a means to lock the circuit breaker in the "ON" or "OFF" position.  
 [29] Complete rating is NEMA 3, 3R, 4, 4X, 5, and 12.  
 [30] For NEMA 3R applications, remove drain screw from bottom endwall.  
 [31] NEMA 7 — Indoor Hazardous Locations — Division 1 and 2, Class I, Groups C and D; Class II, Groups E, F and G; Class III  
 [32] NEMA 9 — Indoor Hazardous Locations — Division 1 and 2, Class ii, Groups E, F and G; Class iii  
 [33] Short circuit current rating: 65 kAIR at 240 Vac, 25 kAIR at 480 Vac, and 18 kAIR at 600 Vac  
 [34] Not cULus listed due to wire bending space.

**Enclosure Accessories**

**Table 7.170: Neutral Kit Terminal Data**

Neutral Kit Catalog Number	Terminal Lug Data -Total Available (Line plus Load) AWG/kcmil AL/CU	All Copper Neutral Terminal Lug Data -Total Available (Line plus Load) AWG/kcmil
100SNA	(2) 14-1/0 Cu or (2) 12-1/0 Al plus (1) 14-4 Cu	—
SN100FA	(4) 14-1/0 Cu or (4) 12-1/0 Al	—
SN225KA	(2) 4-300 Al/Cu plus (2) 14-1/0 Al/Cu	—
225SNA	(4) 6-350 Al/Cu	—
400SN	(2) 1-600 or (4) 1-250 Al/Cu, plus (2) 4-300 Al/Cu	—
SN400LA	(2) 1-600 or (4) 1-250 Al/Cu, plus (2) 4-300 Al/Cu	—
SN1000MA	(6) 3/0-500 Al/Cu, plus (1) 1-4/0 Al/Cu	—
SNC400LX	—	(2) 2-600 Cu, plus (2) 6-250 Cu
SNC800LX	—	(4) 2-600 Cu, plus (1) 2-4/0 Cu
AL800SN	(6) 3/0-500 Al/Cu, plus (2) 6-250 Al/Cu	—
SN1200	(8) 3/0-750 Al/Cu, plus (2) 6-350 Al/Cu	—
S33576MK	(8) 3/0-500 Al/Cu, plus (2) 4-300 Al/Cu	—

**Table 7.171: Service Ground Kit Terminal Data**

Service Ground Kit Catalog Number	Terminal Data AWG/kcmil	Lugs Per Kit
PKOGTA2	10-2/0 Cu or 6-2/0 Al	2
PKOGTH150	14-2 Al/Cu	2
PKOGTJ250	6-300 Al/Cu	2
PKOGTA4	6-250 Al/Cu	4

**Terminal Shields for Service Entrance Applications**

- Can be applied as line side barriers in service entrance applications
- Will fit on top or bottom of the circuit breaker

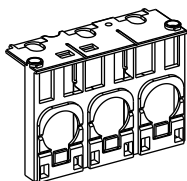

J-Frame Short Lug Shield

**Table 7.172: Terminal Shields**

Frame	2P	3P
PowerPacT Q	QSB2	QSB3
PowerPacT H (3 AWG Max. Wire Size)	—	S37446
PowerPacT H (3/0 Max. Wire Size)	—	S37447
PowerPacT J	—	S37448
PowerPacT M	—	MGJTC
PowerPacT P	—	PA12TC
LA/LH	—	LAHTC

See Supplemental Digest Section 3 for special options for enclosures:

- Stainless steel fronts
- Pilot lights, push buttons
- Lock-on SPL0
- Key interlock systems
- Legend plates

**Enclosure Dimensions**

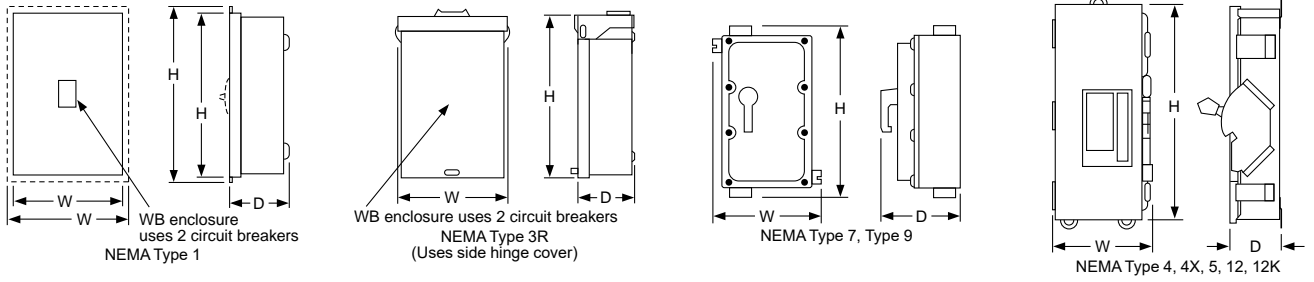

**Table 7.173: Dimensions**

Cat. No.	Series	Approximate Dimension					
		H		W		D	
		in.	mm	in.	mm	in.	mm
B125F	A01	19.5	495	9.88	251	4.13	105
B125S	A01	18.13	461	8.63	219	4.13	105
B125FSS	A01	19.5	495	9.88	251	4.13	105
B125RB	A01	18.0	457	8.88	226	4.88	124
B125DS	A01	19.5	495	9.13	232	4.88	124
B125SS	A01	19.5	495	9.13	232	4.88	124
B125A	A01	19.5	495	9.13	232	4.88	124
B125AWK	A01	19.5	495	9.13	232	4.88	124
B125AWKMC	A01	19.5	495	9.13	232	4.88	124
HD100S	A01	17.00	431.8	7.90	200.7	4.75	120.7
H150F	A01	32.40	823	15.40	391	6.00	152
H150R	A01	31.05	789	14.47	368	6.28	160
H150S	A01	31.36	797	14.36	365	6.00	152
J250F	A01	32.40	823	15.40	391	6.00	152
J250R	A01	31.05	789	14.47	368	6.28	160
J250S	A01	31.36	797	14.36	365	6.00	152
J250DS	A01	32.26	819	9.72	247	7.94	202
J250SS	A01	32.26	819	9.72	247	7.94	202
J250AWK	A01	32.26	819	9.72	247	7.94	202
JD250S	A01	26.40	670.6	8.90	226.1	5.50	139.7
J225X	A01	22.70	577	10.93	278	7.70	196
J225Y	A01	22.70	577	10.93	278	7.70	196
L600AWK	A01	57.50	1461	20.38	518	8.25	210
L600AWKVW	A01	57.50	1461	20.38	518	8.25	210
L600AWKMC	A01	57.50	1461	20.38	518	8.25	210
L1200S	A01	51.88	1818	20.25	514	7.75	197
LA400AWK	E05	42.25	1073	13.75	349	7.25	184
LA400DS	E05	42.25	1073	13.75	349	7.25	184
LA400F	E03	45.63	1159	16.50	419	6.50	165
LA400R	E03	44.00	1118	15.38	391	7.88	200
LA400S	E03	44.50	1130	15.38	391	6.50	165
LA400LS	A01	27.40	696.0	15.40	391.2	6.625	168.3
M800S	A01	40-3/8	1025.52	21	533.4	9-3/4	247.65
M800R	A01	40-3/8	1025.52	21	533.4	9-3/4	247.65
M800DS	A01	40-7/8	1036.96	20-3/4	527.05	9-1/2	241.3
M800SS	A01	40-7/8	1036.96	20-3/4	527.05	9-1/2	241.3
M800AWK	A01	40-7/8	1036.96	20-3/4	527.05	9-1/2	241.3
P1200S	A01	52-1/8	1323.98	21	533.4	9-3/4	247.65
P1200R	A01	52-1/8	1323.98	21	533.4	9-3/4	247.65
P1200AWK	A01	53	1346.20	20-3/4	527.05	9-1/2	241.3
Q22200NRB	E05	23.38	594	7.63	194	4.75	121
Q22200NS	E05	23.13	588	7.63	194	4.25	108
Q23225NF	E05	26.25	667	9.88	251	4.75	121
Q23225NRB	E05	26.25	667	9.88	251	5.50	140
Q23225NS	E05	26.25	667	9.88	251	4.75	121

