

General Cable Support Information

NEC/CEC:
Listed for Ordinary Locations

Applications

- Used to support cables in vertical raceways or risers.
- Relieves the strain that would be placed on terminations, the interior of panels, or other devices to which the cables are connected.
- Properly designed cable supports must not only be capable of supporting a given weight of cable with a good margin of safety but must also support the cable without damaging the insulation or excessively reducing the amount of insulation over the conductor in the area where the cable is supported. O-Z/Gedney™ has been furnishing Cable Supports to the electrical industry for almost 100 years that meet these requirements.

Certifications and Compliances

- Requirements for Cable Supports in the National Electrical Code reads as follows: 300.19 Supporting Conductors in Vertical Raceways. (A) Spacing Intervals - Maximum. Conductors in vertical raceways shall be supported if the vertical rise exceeds the values in Table 300.19(A). One cable support shall be provided at the top of the vertical raceway or as close to the top as practical. Intermediate supports shall be provided as necessary to limit supported conductor lengths to not greater than those specified in Table 300.19(A).

Example:

- A 10-story building contains a vertical conduit run from the basement to the top floor, approx. 34 m (110 ft) in length. The raceway contains 4/0 copper conductors. Per Table 300.19(A), the unsupported cable length cannot exceed 25 m (80 ft). Therefore, one cable support is required at or near the top of the vertical riser, and one intermediate support is required at or near the midpoint in the conduit run, assuring that any unsupported cable length does not exceed 25 m (80 ft).

Spacing for Conductor Supports

Size of Wire	Support of Conductors in Vertical Raceways	Aluminum or Copper – Clad Aluminum Meters (Feet)	Copper Meters (Feet)
18 AWG thru 8 AWG	Not greater than	30 (100)	30 (100)
6 AWG thru 1/0 AWG	Not greater than	60 (200)	30 (100)
2/0 AWG thru 4/0 AWG	Not greater than	55 (180)	25 (80)
over 4/0 AWG - 350 kcmil	Not greater than	41 (135)	18 (60)
over 350 kcmil - 500 kcmil	Not greater than	36 (120)	15 (50)
over 500 kcmil - 750 kcmil	Not greater than	28 (95)	12 (40)
over 750 kcmil	Not greater than	26 (85)	11 (35)

Application	Recommended O-Z/Gedney™ Cable Supports
TWO or more wires - Indoors - at voltages to 600 Volt	Type S
Retrofit - TWO or more wires - Indoors - at voltages to 600 Volt	Type D
ONE or more wires - Indoors - at all voltages	Type R
Retrofit - ONE or more wires - Indoors - at all voltages	Type DR
Ventilating - ONE or more wires - Outdoors - at all voltages	Type CMT
Ventilating - Bakelite - ONE or more wires - Outdoors - at all voltages	Type V
Non-ventilating - ONE or more wires - Outdoors - at all voltages	Type C
Locking - Horizontal/Vertical - ONE or more wires - Indoors - at all voltages	Type K
Space Maker - ONE or more wires - Indoors - at all voltages	Type M
Pull Box - ONE or more wires - Outdoors at all voltages	Type W
Conduit Ventilators	Type KVF/KVM
Grounding Lugs	Type G
Wire Armored Cable - In conduit or supported by structure	Type F/FS/FT/SF1773

General Cable Support Information

NEC/CEC:
Listed for Ordinary Locations

Applications

- Two basic types of cable supports are offered for use with non-armored cable. They both utilize the pOZi-grip™ Wedging Plug. pOZi-grip™ is a unique manufacturing technique for lining the cable grooves with a coarse grain grit using a high strength epoxy adhesive. This grit improves the cable support holding power and does not injure the jacket or insulation on the cable.

One Piece Plug Type "S"

- This type consists of a metal body having an insulating liner with a knurled and tapered inside surface and a one piece impregnated hardwood wedging plug having a groove for each wire. This type support is recommended for use with all types of non-armored cables 600 Volts or less, as it is the easiest to install, impossible to install incorrectly and it provides ventilation of the conduit. This design is used in our Types S and D Cable Supports. The basic principles of their assembly are illustrated below.

Multiple Segment Plug Type "R"

- This type consists of an all metal body having a tapered inner surface and a canvas bakelite multiple segment wedging plug so constructed that each cable is supported between grooves in adjacent segments. This construction provides the uniform pressure distribution required by the softer types of insulations frequently used at higher voltages. This design is used in non-ventilating types R, DR, W, C, K and M, and Ventilating Compound Types CMT, and V. The basic principles of their assembly are illustrated below.

Type S

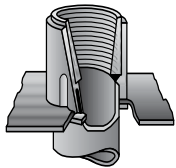

1. Screw body on the end of the conduit or connector in place of the regular insulating bushing.

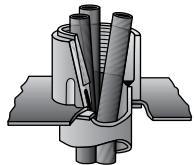

2. Pull wires and arrange temporary means of support.

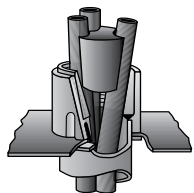

- 3a. Remove all pulling compound from wires in the area where they pass through the cable support.
- 3b. Place the plug between the wires as close to the top of the body as possible. Care should be taken to locate each wire in the proper groove.

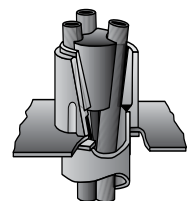

4. Tap the plug firmly into the support body.

Type R

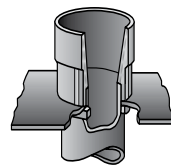

1. Screw body on the end of the conduit or connector in place of the regular insulating bushing.

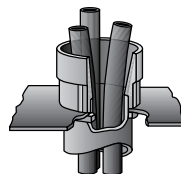

2. Pull wires and arrange temporary means of support.

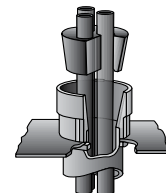

- 3a. Remove all pulling compound from wires in the area where they pass through the cable support.
- 3b. Place the segments of the plug around the wires. Where more than two segments are involved the top of each plug segment has numbers at each end and it is important that these are paired with the corresponding numbers on the adjacent plug segments.

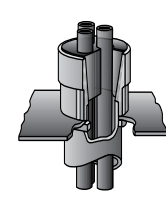

4. Tap the plug segments evenly and firmly into the support body.

Drill Chart for Type S and D Cable Supports

NEC/CEC:
Listed for Ordinary Locations

HOW TO USE THIS CHART FOR S AND D CABLE SUPPORTS

- (1) Select your conduit size and measure your cable diameter(s) which must fit within the min/max range corresponding to the quantity of cables in the white area of this chart. (Note: S and D Cable Supports must be used with two or more cables, 600 volts maximum)
- (2) Cable diameters that fall within the gray area of this chart cannot be accommodated. Therefore a 3" Cable Support has a cable range of 0.261" up to 1.130". Cables smaller or larger cannot be considered.
- (3) Example: A 3" Cable Support will be used for 3 cables at 1.051" and 1 cable at 0.384". Refer to the 3" Conduit Size column. We can fit 4 cables between 1.011" to 1.070" therefore 3 at 1.051" will fit. The fourth cable fits between 0.361" to 0.410" within the white area in the 3" Conduit column. This drilling will work.
- (4) Using the example above but the fourth cable is smaller at 0.216", this drilling will not work. The 0.216" cable falls into the 0.211" to 0.260" range which is within the gray shaded area of the 3" conduit column. In this case, we recommend using our Cable Supports with R-type wedging plugs. See the R table below.

For combinations of cables that fall outside these parameters, please contact your local representative.

Types S and D Min/Max Cable OD	Conduit Size							
	1-1/2"	2"	2-1/2"	3"	3-1/2"	4"	5"	6"
.180 - .210	10	15						
.211 - .260	8	13	16					
.261 - .310	8	11	14	18				
.311 - .360	6	9	12	16	19			
.361 - .410	4	8	11	15	17			
.411 - .460	4	6	10	13	15	17		
.461 - .510	4	5	8	11	14	16		
.511 - .560	4	5	7	10	12	14		
.561 - .610	2	5	6	9	11	13		
.611 - .660	2	4	5	8	10	12		
.661 - .710		4	4	8	10	11		
.711 - .760		4	4	7	9	10		
.761 - .810		2	4	7	8	10		
.811 - .860			4	6	8	9	12	
.861 - .910			4	6	7	8	11	
.911 - .960			4	5	7	8	10	
.961 - 1.010				5	6	7	10	
1.011 - 1.070				4	6	7	9	
1.071 - 1.130				4	4	6	9	11
1.131 - 1.190					4	6	8	11
1.191 - 1.250					4	5	7	10
1.251 - 1.310					4	4	7	10
1.311 - 1.370						4	7	9
1.371 - 1.430						4	6	8
1.431 - 1.490						4	6	8
1.491 - 1.550						4	5	8
1.551 - 1.610						2	4	7

Type S Cable Supports

For Two or More Wires - Indoors - at Voltages to 600 Vac

For Rigid Conduit, IMC and EMT with pOZi-grip™ "S-style" Wedging Plug.

NEC/CEC:
Listed for Ordinary Locations

Applications

- For supporting non-armored electrical cables in vertical conduit risers.

Features

- Threaded for Rigid Conduit and IMC.
- Use with all types of insulations at voltages to and including 600 Volt.
- The fastest and easiest type cable support to install.
- The knurled insulating inner surface and one piece impregnated hardwood pOZi-grip plug provide positive support well in excess of code requirements.
- Body Only can be ordered separately, for installation prior to wire pulling. Plug Only can be ordered later, once wires are in place.
- If mounting on a non-metallic/non-grounded conduit, a Lay-In-Lug™ grounding lug should be mounted on cable support body.
- For Threadless Rigid Conduit, Threadless IMC, or EMT, the body can be attached to the male threads of a set-screw or compression connector.
- For PVC Conduit, use a PVC terminal adapter.

Material/Finish

- Bodies: malleable or ductile iron with hot dip galvanized finish

NEC/CEC Certifications and Compliances

- UL Standard: ANSI/UL 514B
- UL Listed: E-11853
- CSA Standard: C22.2 No.18.3
- CSA Certified: 011584

Optional Material/Finish

- For non-metallic bodies see Type D
- For Lay-In-Lug, see O-Z/Gedney™ Type G Grounding Lugs for use with cable supports.

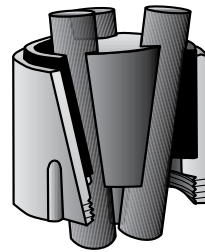

TO ORDER SPECIFY:

- Catalog Number
- Number of conductors in conduit
- Outside diameters of each conductor

Illustrated Features

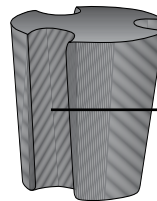

Impregnated Hardwood
pOZi-grip™ Wedging Plug

Shape and special gripping surface
of grooves in plug give maximum
support to cable.

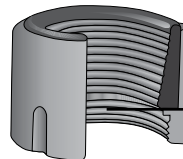

Malleable or Ductile Iron Body

Tapered inside surface of insulating
bushing is knurled to grip cable.

Conduit Size (Inches)	Dimensions in Millimeters (Inches)		Complete Fitting Catalog Number ①			Plug Only Catalog Number ①	
	Outside Diameter	Overall Height	2-4 Same Size Wires	Any Number of Different Size Wires or 5 or More Same Size Wires	Body Only	2-4 Same Size Wires	Any Number of Different Size Wires or 5 or More Same Size Wires
1-1/2	66.8 (2.63)	60.4 (2.38)	S-1500-1	S-1500-2	S-1500-BO	SPLG-1500-1	SPLG-1500-2
2	79.5 (3.13)	66.8 (2.63)	S-2000-1	S-2000-2	S-2000-BO	SPLG-2000-1	SPLG-2000-2
2-1/2	95.3 (3.75)	76.2 (3.00)	S-2500-1	S-2500-2	S-2500-BO	SPLG-2500-1	SPLG-2500-2
3	114.3 (4.50)	79.5 (3.13)	S-3000-1	S-3000-2	S-3000-BO	SPLG-3000-1	SPLG-3000-2
3-1/2	130.3 (5.13)	88.9 (3.50)	S-3500-1	S-3500-2	S-3500-BO	SPLG-3500-1	SPLG-3500-2
4	143.0 (5.63)	3.88 (3.88)	S-4000-1	S-4000-2	S-4000-BO	SPLG-4000-1	SPLG-4000-2
5	174.8 (6.88)	114.3 (4.50)	S-5000-1	S-5000-2	S-5000-BO	SPLG-5000-1	SPLG-5000-2
6	212.9 (8.38)	139.7 (5.50)	S-6000-1	S-6000-2	S-6000-BO	SPLG-6000-1	SPLG-6000-2

① Cable support plugs will not be supplied undrilled. See Drill Chart for wire fill information.

Type D Cable Supports

For Two or More Wires Already Installed in Conduit - Indoors - at Voltages to 600 Vac

Retrofit Type Split Bakelite Body with pOZi-grip™ "S-style" Wedging Plug.

NEC/CEC:
Listed for Ordinary Locations

Applications

- For supporting non-armored electrical cables in vertical conduit risers.

Features

- Retrofit type cable support can be installed after conductors are pulled and terminated.
- Split body rests on existing bushing atop any conduit raceway.
- The two halves of the body are placed around the cables, seated on the existing bushing and securely held together by the steel band set in a groove around the body. The plug is then wedged between the cables.
- Use with all types of insulations at voltages to and including 600 Volts.
- The tapered, knurled insulating inner body surface and pOZigrip plug provide support well in excess of code requirements.

Material/Finish

- Bodies: two molded canvas bakelite halves. Inside surface is knurled to grip cables
- Band: steel/zinc plated
- Bolts and nuts: stainless steel

NEC/CEC Certifications and Compliances

- UL Standard: ANSI/UL 514B
- UL Listed: E-11853
- CSA Standard: C22.2 No.18.3
- CSA Certified: 011584

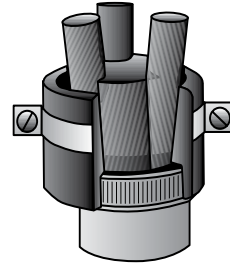

TO ORDER SPECIFY:

- Catalog Number
- Number of conductors in conduit
- Outside diameters of each conductor

Illustrated Features

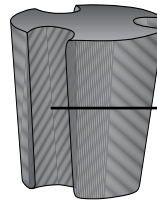

Impregnated Hardwood
pOZi-grip™ Wedging Plug

Shape and special gripping surface of grooves in plug give maximum support to cable.

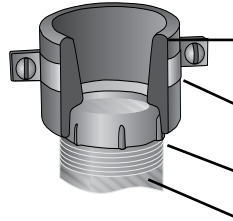

Two molded Canvas Bakelite halves. Inside surface is knurled to grip cables.

Steel band, Zinc Plated. Bolts and nuts are Stainless Steel.

Existing Bushing

Existing Conduit

Conduit Size (Inches)	Dimensions in Millimeters (Inches)					Complete Fitting Catalog Number ①		Plug Only Catalog Number ①	
	Outside Diameter	Overall Height	Approx. Turning Radius R	Inside Diameter	Number of Straps	2-4 Same Size Wires	Any Number of Different Size Wires or 5 or More Same Size Wires	2-4 Same Size Wires	Any Number of Different Size Wires or 5 or More Same Size Wires
1-1/2	66.8 (2.63)	50.8 (2.00)	50.8 (2.00)	57.2 (2.25)	1.00	D-1502-1	D-1502-2	SPLG-1500-1	SPLG-1500-2
2	82.6 (3.25)	57.2 (2.25)	60.4 (2.38)	73.2 (2.88)	1.00	D-2002-1	D-2002-2	SPLG-2000-1	SPLG-2000-2
2-1/2	98.6 (3.88)	63.5 (2.50)	76.2 (3.00)	85.9 (3.38)	2.00	D-2502-1	D-2502-2	SPLG-2500-1	SPLG-2500-2
3	114.3 (4.50)	73.2 (2.88)	79.5 (3.13)	101.6 (4.00)	2.00	D-3002-1	D-3002-2	SPLG-3000-1	SPLG-3000-2
3-1/2	133.4 (5.25)	85.9 (3.38)	92.2 (3.63)	117.6 (4.63)	2.00	D-3502-1	D-3502-2	SPLG-3500-1	SPLG-3500-2
4	146.1 (5.75)	88.9 (3.50)	98.6 (3.88)	130.3 (5.13)	2.00	D-4002-1	D-4002-2	SPLG-4000-1	SPLG-4000-2
5	171.5 (6.75)	95.3 (3.75)	120.7 (4.75)	158.8 (6.25)	2.00	D-5002-1	D-5002-2	SPLG-5000-1	SPLG-5000-2
6	209.6 (8.25)	117.6 (4.63)	133.4 (5.25)	187.5 (7.38)	2.00	D-6002-1	D-6002-2	SPLG-6000-1	SPLG-6000-2

① Cable support plugs will not be supplied undrilled. See Drill Chart for wire fill information.

Drill Chart for Type R, DR, CMT, V, C, K, M and W Cable Supports

NEC/CEC:
Listed for Ordinary Locations

For combinations of cables that fall outside these parameters, please contact your local representative.

Type R, DR, CMT, V, C, K, M, and W Cable Supports ①						
Max. Diameter of Wire Permitted – Millimeters (Inches)						
Conduit Size (Inches)	1 Wire	2 Wires	3 Wires	4 Wires	5 Wires	6 Wires
1-1/2"	35.6 (1.40)	16.3 (0.64)	15.0 (0.59)	13.0 (0.51)	9.91 (0.39)	9.4 (0.37)
2"	46.7 (1.84)	21.8 (0.86)	20.1 (0.79)	17.5 (0.69)	13.5 (0.53)	13.5 (0.53)
2-1/2"	57.2 (2.25)	26.9 (1.06)	24.9(0.98)	21.6 (0.85)	16.8 (0.66)	16.3 (0.64)
3"	72.1 (2.84)	34.5 (1.36)	31.8 (1.25)	27.9 (1.1)	21.8 (0.86)	21.6 (0.85)
3-1/2"	84.1 (3.31)	40.6 (1.60)	37.3 (1.47)	33.0 (1.3)	25.9 (1.02)	24.4 (0.96)
4"	96.8 (3.81)	46.7 (1.84)	43.1 (1.7)	38.1 (1.5)	20.0 (1.18)	27.7 (1.09)
5"	122.2 (4.81)	59.4 (2.34)	54.6 (2.15)	48.3 (1.9)	38.6 (1.52)	35.6 (1.4)
6"	148.3 (5.84)	72.6 (2.86)	66.6 (2.62)	59.4 (2.34)	47.2 (1.86)	43.4 (1.71)

OSG EDNEY

COMMERCIAL AND INDUSTRIAL FITTINGS: RIGID AND IMC CONDUIT FITTINGS

Type R Cable Supports

For One or More Wires - Indoors - at all Voltages

For Rigid Conduit, IMC and EMT with pOZi-grip™ "R-style" Wedging Plug.

NEC/CEC:
Listed for Ordinary Locations

Applications

- For supporting non-armored electrical cables in vertical conduit risers.
- Due to the possibility of Magnetic Induction Heating, a single alternating current conductor should not be used in iron fittings.

Features

- Threaded for rigid conduit and IMC.
- Use with all types of insulations at all voltages.
- The pOZi-grip wedging plug exerts uniform pressure around the cable, providing holding force in excess of that required by code without deforming cable insulation.
- Body Only can be ordered separately, for installation prior to wire pulling. Plug Only can be ordered later, once wires are in place.
- If mounting on a non-metallic/non-grounded conduit, a Lay-In-Lug™ grounding lug should be mounted on cable support body.
- For Threadless Rigid Conduit, Threadless IMC, or EMT, the body can be attached to the male threads of a set-screw or compression connector.

Material/Finish

- Body: malleable or ductile iron with hot dip galvanized finish

NEC/CEC Certifications and Compliances

- UL Standard: ANSI/UL 514B
- UL Listed: E-11853
- CSA Standard: C22.2 No.18.3
- CSA Certified: 011584

Options

- For Lay-In-Lug, see O-Z/Gedney™ Type G Grounding Lugs for use with cable supports.
- For non-metallic bodies, see type DR.

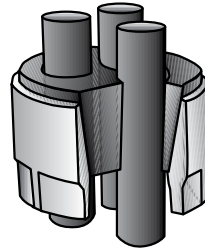

TO ORDER SPECIFY:

1. Catalog Number
2. Number of conductors in conduit
3. Outside diameters of each conductor

Illustrated Features

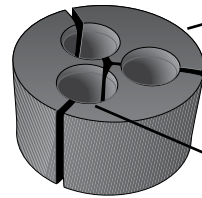

Canvas Bakelite pOZi-grip™ Wedging Plug
For one wire type, the plug consists of two pieces. For two wires or more, there is one piece for each wire.

Shape and special gripping surface of grooves in plug give maximum support to each cable and distributes even pressure around its entire circumference.

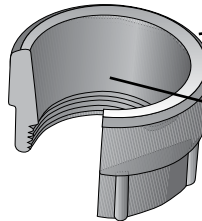

Malleable or Ductile Iron Body

Inside tapered surface is machined to assure proper seating of the Wedging Plug.

Conduit Size (Inches)	Dimensions in Millimeters (Inches)		Complete Fitting Catalog Number ①			Plug Only Catalog Number ①	
	Outside Diameter	Overall Height	1-4 Same Size Wires	Any Number of Different Size Wires or 5 or More Same Size Wires	Catalog Number Body Only	1-4 Same Size Wires	Any Number of Different Size Wires or 5 or More Same Size Wires
1-1/2	66.8 (2.63)	60.4 (2.38)	R-1501-1	R-1501-2	R-1501-BO	RPLG-1501-1	RPLG-1501-2
2	76.2 (3.00)	66.8 (2.75)	R-2001-1	R-2001-2	R-2001-BO	RPLG-2001-1	RPLG-2001-2
2-1/2	92.2 (3.63)	79.5 (3.13)	R-2501-1	R-2501-2	R-2501-BO	RPLG-2501-1	RPLG-2501-2
3	104.9 (4.13)	85.9 (3.38)	R-3001-1	R-3001-2	R-3001-BO	RPLG-3001-1	RPLG-3001-2
3-1/2	123.9 (4.88)	92.2 (3.63)	R-3501-1	R-3501-2	R-3501-BO	RPLG-3501-1	RPLG-3501-2
4	143.0 (5.63)	95.3 (3.75)	R-4001-1	R-4001-2	R-4001-BO	RPLG-4001-1	RPLG-4001-2
5	171.5 (6.75)	111.3 (4.38)	R-5001-1	R-5001-2	R-5001-BO	RPLG-5001-1	RPLG-5001-2
6	200.2 (7.88)	133.4 (5.25)	R-6001-1	R-6001-2	R-6001-BO	RPLG-6001-1	RPLG-6001-2

① Cable support plugs will not be supplied undrilled. See Drill Chart for wire fill information.

Type DR Cable Supports

For One or More Wires Already Installed in Conduit - Indoors - at all Voltages

Retrofit Type Split Bakelite Body with pOZi-grip™ "R-style" Wedging Plug.

NEC/CEC:
Listed for Ordinary Locations

Application

- For supporting non-armored electrical cables in vertical conduit risers.

Features

- Retrofit type cable support can be installed after conductors are pulled and terminated.
- Split body rests on existing bushing atop any conduit raceway.
- Use with all types of insulations at all voltages.
- The pOZi-grip™ wedging plug exerts uniform pressure around the cable, providing holding force in excess of that required by code without deforming cable insulation.

Material/Finish

- Bodies: two molded canvas bakelite halves
- Wedging plug: canvas bakelite pOZi-grip™
- Band: steel/zinc plated
- Bolts and nuts: stainless steel

NEC/CEC Certifications and Compliances

- UL Standard: ANSI/UL 514B
- UL Listed: E-11853
- CSA Standard: C22.2 No.18.3
- CSA Certified: 011584

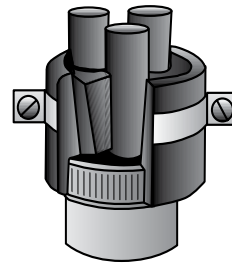

TO ORDER SPECIFY:

- Catalog Number
- Number of conductors in conduit
- Outside diameters of each conductor

Illustrated Features

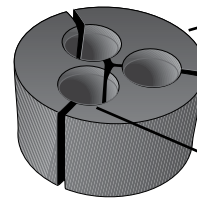

Canvas Bakelite pOZi-grip™ Wedging Plug
For one wire type, the plug consists of two pieces. For two wires or more, there is one piece for each wire.

Shape and special gripping surface of grooves in plug give maximum support to each cable and distributes even pressure around its entire circumference.

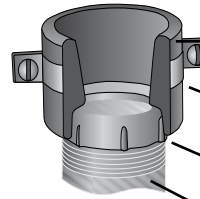

Two molded Canvas Bakelite halves.
Inside surface is knurled to grip cables.

Steel band, Zinc Plated. Bolts and nuts are Stainless Steel.

Existing Bushing

Existing Conduit

Conduit Size (Inches)	Dimensions in Millimeters (Inches)					Number of Straps	Complete Fitting Catalog Number ①		Plug Only Catalog Number ①	
	Outside Diameter	Overall Height	Approx. Turning Radius R	Inside Diameter	1-4 Same Size Wires		Any Number of Different Size Wires or 5 or More Same Size Wires	1-4 Same Size Wires	Any Number of Different Size Wires or 5 or More Same Size Wires	
1-1/2	66.8 (2.63)	50.8 (2.00)	50.8 (2.00)	57.2 (2.25)	1	DR-1502-1	DR-1502-2	RPLG-1501-1	RPLG-1501-2	
2	82.6 (3.25)	57.2 (2.25)	60.4 (2.38)	73.2 (2.88)	1	DR-2002-1	DR-2002-2	RPLG-2001-1	RPLG-2001-2	
2-1/2	98.6 (3.88)	63.5 (2.50)	76.2 (3.00)	85.9 (3.38)	2	DR-2502-1	DR-2502-2	RPLG-2501-1	RPLG-2501-2	
3	114.3 (4.50)	73.2 (2.88)	79.5 (3.13)	101.6 (4.00)	2	DR-3002-1	DR-3002-2	RPLG-3001-1	RPLG-3001-2	
3-1/2	133.4 (5.25)	85.9 (3.38)	92.2 (3.63)	117.6 (4.63)	2	DR-3502-1	DR-3502-2	RPLG-3501-1	RPLG-3501-2	
4	146.1 (5.75)	88.9 (3.50)	98.6 (3.88)	130.3 (5.13)	2	DR-4002-1	DR-4002-2	RPLG-4001-1	RPLG-4001-2	
5	171.5 (6.75)	95.3 (3.75)	120.7 (4.75)	158.8 (6.25)	2	DR-5002-1	DR-5002-2	RPLG-5001-1	RPLG-5001-2	
6	209.6 (8.25)	117.6 (4.63)	133.4 (5.25)	187.5 (7.38)	2	DR-6002-1	DR-6002-2	RPLG-6001-1	RPLG-6001-2	

① Cable support plugs will not be supplied undrilled. See Drill Chart for wire fill information.

Type CMT Cable Supports

Ventilating, Compound, Threaded Type. For One or More Wires - Outdoors - at all Voltages

For Rigid Conduit, IMC and EMT with pOZi-grip™ "R-style" Wedging Plug.

NEC:
Rated for Ordinary Locations

Application

- To support non-armored electrical cables in vertical conduit risers, furnish a weatherproof seal and provide ventilation at the top of the conduit.
- Due to the possibility of Magnetic Induction Heating, a single alternating current conductor should not be used in iron fittings.

Features

- Threaded for rigid conduit and IMC.
- Use with all types of insulations at all voltages.
- This device not only supports the cable, but furnishes a weatherproof seal and provides ventilation at the top of the conduit riser.
- The temperature in a conduit riser can be reduced +8 °C to 11 °C (15 °F to 20 °F) with proper venting. To obtain full effect of this decrease, the lower end of the conduit must be open or vented by use of the conduit ventilators.
- Body Only can be ordered separately, for installation prior to wire pulling. Plug Only can be ordered later, once wires are in place.
- If mounting on a non-metallic/non-grounded conduit, a Lay-In-Lug™ grounding lug should be mounted on cable support body.
- For threadless rigid conduit, threadless IMC, or EMT, the body can be attached to the male threads of a set-screw or compression connector.
- For PVC conduit, use a PVC terminal adapter.

Material/Finish

- Body: malleable or ductile iron with hot dip galvanized finish

Illustrated Features

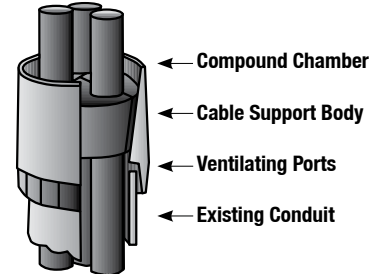

TO ORDER SPECIFY:
1. Catalog Number
2. Number of conductors in conduit
3. Outside diameters of each conductor

Optional Material

- For insulating compound, see O-Z/Gedney™ DOZSeal Insulating Compound page.

NEC Certifications and Compliances

- UL Standard: ANSI/UL 514B

Conduit Size (Inches)	Dimensions in Millimeters (Inches)			Complete Fitting Catalog Number ①			Plug Only Catalog Number ①	
	Outside Diameter	Overall Height	Compound Required Pints	1-4 Same Size Wires	Any Number of Different Size Wires or 5 or More Same Size Wires	Body Only	1-4 Same Size Wires	Any Number of Different Size Wires or 5 or More Same Size Wires
2	79.5 (3.13)	88.9 (3.50)	0.25	CMT-2000-1	CMT-2000-2	CMT-2000-BO	RPLG-2001-1	RPLG-2001-2
2-1/2	98.6 (3.88)	101.6 (4.00)	0.33	CMT-2500-1	CMT-2500-2	CMT-2500-BO	RPLG-2501-1	RPLG-2501-2
3	114.3 (4.50)	111.3 (4.38)	0.50	CMT-3000-1	CMT-3000-2	CMT-3000-BO	RPLG-3001-1	RPLG-3001-2
3-1/2	127.0 (5.00)	120.7 (4.75)	0.75	CMT-3500-1	CMT-3500-2	CMT-3500-BO	RPLG-3501-1	RPLG-3501-2
4	139.7 (5.50)	127.0 (5.00)	1.00	CMT-4000-1	CMT-4000-2	CMT-4000-BO	RPLG-4001-1	RPLG-4001-2
5	181.1 (7.13)	143.0 (5.63)	1.75	CMT-5000-1	CMT-5000-2	CMT-5000-BO	RPLG-5001-1	RPLG-5001-2
6	209.6 (8.25)	171.5 (6.75)	3.50	CMT-6000-1	CMT-6000-2	CMT-6000-BO	RPLG-6001-1	RPLG-6001-2

① Cable support plugs will not be supplied undrilled. See Drill Chart for wire fill information.

Type V Cable Supports

Ventilating, Compound, Setscrew type. For One or more wires - Outdoors - at all voltages

All Bakelite Cable Support For Threadless Rigid Conduit and IMC with pOZi-grip™ "R-style" Wedging Plug.

NEC:
Listed for Ordinary Locations

Application

- To support non-armored electrical cables in vertical conduit risers, furnish a weatherproof seal and provide ventilation at the top of the conduit.

Features

- Use with all types of insulations at all voltages.
- A special cable support made of canvas bakelite. This support furnishes a weatherproof seal and provides ventilation at the top of the conduit riser. The temperature in a riser can be reduced +8 °C to 11 °C (15 °F to 20 °F) with proper venting. To obtain full effect of this decrease, the lower end of the conduit must be open or vented by use of the conduit ventilators.
- Body Only can be ordered separately, for installation prior to wire pulling. Plug Only can be ordered later, once wires are in place.
- Body can also be mounted on EMT in trade sizes 2-1/2 thru 4.

Material/Finish

- Body and plug: canvas bakelite

Options

- Can also be supplied for standard tapered ends of fiber conduit. Contact your local sales representative.
- For insulating compound, see O-Z/Gedney™ dOZSeal Insulating Compound page.

NEC Certifications and Compliances

- UL Standard: ANSI/UL 514B
- UL Listed: E-11853

Illustrated Features

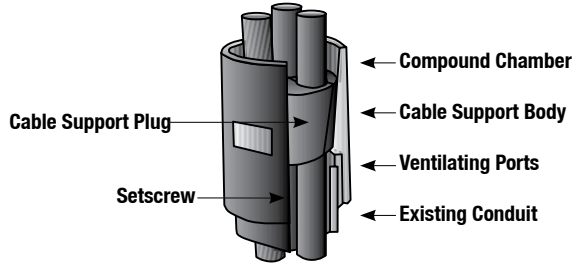

TO ORDER SPECIFY:

- Catalog Number
- Number of conductors in conduit
- Outside diameters of each conductor

OZGEDNEY

COMMERCIAL AND INDUSTRIAL FITTINGS: RIGID AND IMC CONDUIT FITTINGS

Conduit Size (Inches)	Dimensions in Millimeters (Inches)		Compound Required Pints	Complete Fitting Catalog Number ①			Plug Only Catalog Number ①	
	Outside Diameter	Overall Height		1-4 Same Size Wires	Any Number of Different Size Wires or 5 or More Same Size Wires	Body Only	1-4 Same Size Wires	Any Number of Different Size Wires or 5 or More Same Size Wires
2	82.6 (3.25)	95.3 (3.75)	0.25	V-2005-1	V-2005-2	V-2005-BO	RPLG-2001-1	RPLG-2001-2
2-1/2	95.3 (3.75)	104.9 (4.13)	0.33	V-2505-1	V-2505-2	V-2505-BO	RPLG-2501-1	RPLG-2501-2
3	111.3 (4.38)	114.3 (4.50)	0.50	V-3005-1	V-3005-2	V-3005-BO	RPLG-3001-1	RPLG-3001-2
3-1/2	127.0 (5.00)	127.0 (5.00)	0.75	V-3505-1	V-3505-2	V-3505-BO	RPLG-3501-1	RPLG-3501-2
4	136.7 (5.38)	136.7 (5.38)	1.00	V-4005-1	V-4005-2	V-4005-BO	RPLG-4001-1	RPLG-4001-2
5	174.8 (6.88)	152.4 (6.00)	1.75	V-5005-1	V-5005-2	V-5005-BO	RPLG-5001-1	RPLG-5001-2
6	206.5 (8.13)	177.8 (7.00)	3.50	V-6005-1	V-6005-2	V-6005-BO	RPLG-6001-1	RPLG-6001-2

① Cable support plugs will not be supplied undrilled. See Drill Chart for wire fill information.

Type C Cable Supports

Compound: Non-Ventilating. For One or More Wires Outdoors - at all Voltages

For Rigid Conduit, IMC and EMT with pOZi-grip™ “R-style” Wedging Plug.

NEC:
Listed for Ordinary Locations

Application

- To seal the end of conduit and support non-armored electrical cables in vertical conduit risers.
- Due to the possibility of Magnetic Induction Heating, a single alternating current conductor should not be used in iron fittings.

Features

- Threaded for rigid conduit and IMC.
- Use with all types of insulations at all voltages.
- This device not only supports the cable, but furnishes a watertight seal at the top of a conduit riser.
- Body Only can be ordered separately, for installation prior to wire pulling. Plug Only can be ordered later, once wires are in place.
- If mounting on a non-metallic/non-grounded conduit, a Lay-In-Lug™ grounding lug should be mounted on cable support body.
- For threadless rigid conduit, Threadless IMC, or EMT, the body can be attached to the male threads of a set-screw or compression connector.
- For PVC conduit, use a PVC terminal adapter.

Material/Finish

- Body: malleable or ductile iron with hot dip galvanized finish

Options

- For Lay-in-Lug, see O-Z/Gedney™ Type G Grounding Lugs for use with cable supports.
- For insulating compound, see O-Z/Gedney™ DOZSeal Insulating Compound page.

NEC Certifications and Compliances

- UL Standard: ANSI/UL 514B
- UL Listed: E-11853

Illustrated Features

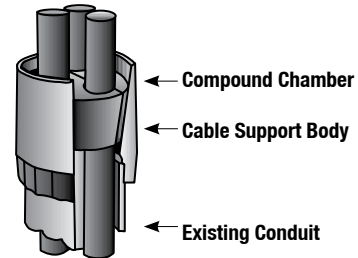

TO ORDER SPECIFY: ①
 1. Catalog Number
 2. Number of conductors in conduit
 3. Outside diameters of each conductor

Conduit Size (Inches)	Dimensions in Millimeters (Inches)			Complete Fitting Catalog Number ①			Plug Only Catalog Number ①	
	Outside Diameter	Overall Height	Compound Required Pints	1-4 Same Size Wires	Any Number of Different Size Wires or 5 or More Same Size Wires	Body Only	1-4 Same Size Wires	Any Number of Different Size Wires or 5 or More Same Size Wires
2	79.5 (3.13)	88.9 (3.50)	0.25	C-2004-1	C-2004-2	C-2004-BO	RPLG-2001-1	RPLG-2001-2
2-1/2	98.6 (3.88)	101.6 (4.00)	0.33	C-2504-1	C-2504-2	C-2504-BO	RPLG-2501-1	RPLG-2501-2
3	114.3 (4.50)	111.3 (4.38)	0.50	C-3004-1	C-3004-2	C-3004-BO	RPLG-3001-1	RPLG-3001-2
3-1/2	127.0 (5.00)	120.7 (4.75)	0.66	C-3504-1	C-3504-2	C-3504-BO	RPLG-3501-1	RPLG-3501-2
4	139.7 (5.50)	127.0 (5.00)	1.00	C-4004-1	C-4004-2	C-4004-BO	RPLG-4001-1	RPLG-4001-2
5	181.1 (7.13)	143.0 (5.63)	1.75	C-5004-1	C-5004-2	C-5004-BO	RPLG-5001-1	RPLG-5001-2
6	209.6 (8.25)	171.5 (6.75)	3.50	C-6004-1	C-6004-2	C-6004-BO	RPLG-6001-1	RPLG-6001-2

① Cable support plugs will not be supplied undrilled. See Drill Chart for wire fill information.

Type K Cable Supports

Locking Style: Horizontal or Inverted - One or More Wires - Indoors - at all Voltages

For Rigid Conduit, IMC and EMT with pOZi-grip™ “R-style” Wedging Plug.

NEC:
Listed for Ordinary Locations

Application

- Can be installed in horizontal or inverted position.
- For supporting non-armored electrical cables in conduit.
- Due to the possibility of Magnetic Induction Heating, a single alternating current conductor should not be used in iron fittings.

Features

- Threaded for Rigid Conduit and IMC.
- Use with all types of insulations at all voltages.
- The design of this support is similar to the Type R except that it is equipped with a locking collar which securely holds the pOZi-grip™ wedging plug in place. This permits the support to be installed in any position and provides holding force against pull in either direction.
- Body Only can be ordered separately, for installation prior to wire pulling. Plug Only can be ordered later, once wires are in place.
- If mounting on a non-metallic/non-grounded conduit, a Lay-In-Lug™ grounding lug should be mounted on cable support body.
- For Threadless Rigid Conduit, Threadless IMC, or EMT, the body can be attached to the male threads of a set-screw or compression connector.
- For PVC Conduit, use a PVC terminal adapter.

Material/Finish

- Body and locking collar: malleable or ductile iron with hot dip galvanized finish

Illustrated Features

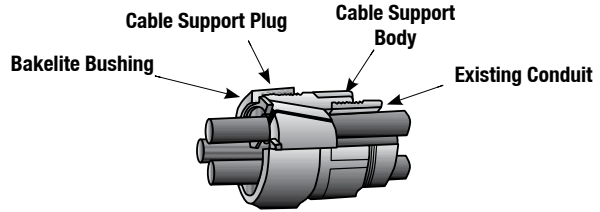

TO ORDER SPECIFY:

1. Catalog Number
2. Number of conductors in conduit
3. Outside diameters of each conductor

Options

- For Lay-in-Lug, see O-Z/Gedney™ Lay-In-Lug Grounding Lugs for use with cable supports.

NEC Certifications and Compliances

- UL Standard: ANSI/UL 514B
- UL Listed: E-11853

Dimensions in Millimeters (Inches)			Complete Fitting Catalog Number ①		Plug Only Catalog Number ①		
Conduit Size (Inches)	Outside Diameter	Overall Height	1-4 Same Size Wires	Any Number of Different Size Wires or 5 or More Same Size Wires	Body Only ②	1-4 Same Size Wires	Any Number of Different Size Wires or 5 or More Same Size Wires
1-1/2	73.2 (2.88)	69.9 (2.75)	K-1503-1	K-1503-2	K-1503-BO	RPLG-1501-1	RPLG-1501-2
2	85.9 (3.38)	79.5 (3.13)	K-2003-1	K-2003-2	K-2003-BO	RPLG-2001-1	RPLG-2001-2
2-1/2	101.6 (4.00)	88.9 (3.50)	K-2503-1	K-2503-2	K-2503-BO	RPLG-2501-1	RPLG-2501-2
3	114.3 (4.50)	95.3 (3.75)	K-3003-1	K-3003-2	K-3003-BO	RPLG-3001-1	RPLG-3001-2
3-1/2	130.3 (5.13)	101.6 (4.00)	K-3503-1	K-3503-2	K-3503-BO	RPLG-3501-1	RPLG-3501-2
4	158.8 (6.25)	111.3 (4.38)	K-4003-1	K-4003-2	K-4003-BO	RPLG-4001-1	RPLG-4001-2
5	187.5 (7.38)	123.9 (4.88)	K-5003-1	K-5003-2	K-5003-BO	RPLG-5001-1	RPLG-5001-2
6	212.9 (8.38)	146.1 (5.75)	K-6003-1	K-6003-2	K-6003-BO	RPLG-6001-1	RPLG-6001-2

① Cable support plugs will not be supplied undrilled. See Drill Chart for wire fill information.

② Includes Locking Collar and Bushing.

Type M Cable Supports

Space-Maker Style - One or More Wires - Indoors - at all Voltages

For Rigid Conduit, IMC and EMT with pOZi-grip™ "R-style" Wedging Plug.

NEC:
Listed for Ordinary Locations

Application

- Use where there is insufficient room for a cable support inside a junction box. For supporting non-armored electrical cables in vertical conduit risers.
- Due to the possibility of Magnetic Induction Heating, a single alternating current conductor should not be used in iron fittings.

Features

- Use with all types of insulations at all voltages.
- This fitting is similar to the Type R support, except that it is threaded at the top to allow fastening to a cabinet (1/4 max. thickness) with standard locknuts or threading into tapped (NPT) openings.
- Body Only can be ordered separately, for installation prior to wire pulling. Plug Only can be ordered later, once wires are in place. ①

Material/Finish

- Body: malleable or ductile iron with hot dip galvanized finish

Options

- For Lay-In-Lug, see O-Z/Gedney™ Type G Grounding Lugs for use with cable supports.

NEC Certifications and Compliances

- UL Standard: ANSI/UL 514B
- UL Listed: 11853

Illustrated Features

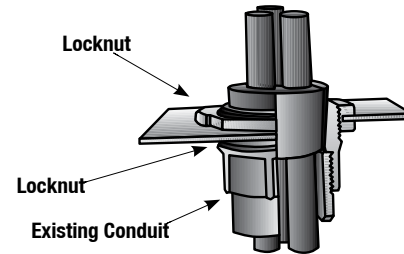

TO ORDER SPECIFY:
1. Catalog Number
2. Number of conductors in conduit
3. Outside diameters of each conductor

Conduit Size (Inches)	Knockout Size (Inches)	Dimensions in Millimeters (Inches)			Complete Fitting Catalog Number ②			Plug Only Catalog Number ②		
		Top Thread Length	Outside Diameter	Overall Height	1-4 Same Size Wires	Any Number of Different Size Wires or 5 or More Same Size Wires	Body Only ③	1-4 Same Size Wires	Any Number of Different Size Wires or 5 or More Same Size Wires	
1 - 1/2	2	25.4 (1.00)	66.8 (2.63)	57.2 (2.25)	M-1520-1	M-1520-2	M-1520-BO	RPLG-1501-1	RPLG-1501-2	
2	2-1/2	28.7 (1.13)	76.2 (3.00)	66.8 (2.63)	M-2025-1	M-2025-2	M-2025-BO	RPLG-2001-1	RPLG-2001-2	
2-1/2	3	31.8 (1.25)	92.2 (3.63)	73.2 (2.88)	M-2530-1	M-2530-2	M-2530-BO	RPLG-2501-1	RPLG-2501-2	
3	3-1/2	35.1 (1.38)	104.9 (4.13)	79.5 (3.13)	M-3035-1	M-3035-2	M-3035-BO	RPLG-3001-1	RPLG-3001-2	
3-1/2	4	38.1 (1.50)	123.9 (4.88)	85.9 (3.38)	M-3540-1	M-3540-2	M-3540-BO	RPLG-3501-1	RPLG-3501-2	
4	5	41.4 (1.63)	143.0 (5.63)	95.3 (3.75)	M-4050-1	M-4050-2	M-4050-BO	RPLG-4001-1	RPLG-4001-2	
5	6	41.4 (1.63)	171.5 (6.75)	104.9 (4.13)	M-5060-1	M-5060-2	M-5060-BO	RPLG-5001-1	RPLG-5001-2	

① For Threadless Rigid Conduit, Threadless IMC, or EMT, the body can be attached to the male threads of a set-screw or compression connector. For PVC Conduit, use a PVC terminal adapter. If mounting on a non-metallic/non-grounded conduit, a Type G grounding lug should be mounted on cable support body.

② Cable support plugs will not be supplied undrilled. See Drill Chart for wire fill information.

③ Includes two locknuts.

Type W Cable Supports

Pull Box Style - Raintite Enclosed - For One or More Wires - at all Voltages

For Threaded Rigid Conduit and IMC with pOzi-grip™ "R-style" Wedging Plug.

NEC/CEC:
Rated for Ordinary Locations

Applications

- For all types of insulations at all voltages.
- Provides intermediate support of non-armored conductors in an indoor/outdoor vertical conduit run where a junction box and/or pull point is unavailable.

Features

- Meets NEC Section 300.19(A) requirements for intermediate supports at midpoints in vertical conduit risers.
- Requires less space in conduit run than rectangular junction box. May be mounted side-by-side or staggered in multiple conduit runs.
- Type W cable support is essentially a modified type R cable support mounted within a pull box fitting.
- Lay-In-Lug™ grounding lug can be mounted on pull box end fitting.

Material/Finish

- Cable support body and pull box end fittings: malleable or ductile iron
- Oversize sleeve: steel
- Hot dip galvanized finish

Options

- For Lay-In-Lug, see O-Z/Gedney™ Type G Grounding Lugs for use with cable supports.

Illustrated Features

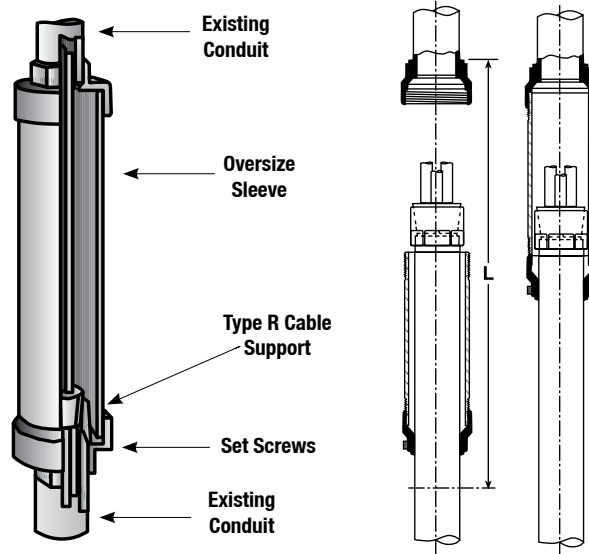

TO ORDER SPECIFY:

1. Catalog Number
2. Number of conductors in conduit
3. Outside diameters of each conductor

Conduit Size (Inches)	Sleeve Furnished With Fitting		Dimensions in Millimeters (Inches) Overall Length ①			1-4 Same Size Wires ①		5 or More Wires or Different Size Wires ①	
	Trade Size (Inches)	Length	Maximum Diameter	Fitting Closed	Fitting Open (Min.) L	Fitting With Sleeve	Fitting Without Sleeve	Fitting With Sleeve	Fitting Without Sleeve
1-1/2	63.5 (2.50)	12"	85.9 (3.38)	393.7 (15.50)	26	W-1508-1-OS	W-1508-1-LS	W-1508-2-OS	W-1508-2-LS
2	76.2 (3.00)	15"	101.6 (4.00)	476.3 (18.75)	32	W-2008-1-OS	W-2008-1-LS	W-2008-2-OS	W-2008-2-LS
2-1/2	88.9 (3.50)	15"	117.6 (4.63)	488.9 (19.25)	32	W-2508-1-OS	W-2508-1-LS	W-2508-2-OS	W-2508-2-LS
3	101.6 (4.00)	15"	130.3 (5.13)	488.9 (19.25)	32	W-3008-1-OS	W-3008-1-LS	W-3008-2-OS	W-3008-2-LS
3-1/2	114.3 (4.50)	18"	146.1 (5.75)	571.5 (22.50)	38	W-3508-1-OS	W-3508-1-LS	W-3508-2-OS	W-3508-2-LS
4	127.0 (5.00)	18"	158.8 (6.25)	571.5 (22.50)	38	W-4008-1-OS	W-4008-1-LS	W-4008-2-OS	W-4008-2-LS
5	177.8 (7.00)	18"	212.9 (8.38)	596.9 (23.50)	39	W-5008-1-OS	W-5008-1-LS	W-5008-2-OS	W-5008-2-LS
6	203.2 (8.00)	18"	241.3 (9.50)	615.9 (24.25)	39	W-6008-1-OS	W-6008-1-LS	W-6008-2-OS	W-6008-2-LS

① Cable support plugs will not be supplied undrilled. See Drill Chart for wire fill information.

Type KVM and Type KVF Conduit Ventilators

For Threaded Rigid Conduit and IMC.

NEC/CEC:
Rated for Ordinary Locations

Applications

- To provide for the flow of cooling air through a conduit riser.

Features

- The Type KVF conduit ventilators when used at the bottom of a vertical conduit riser which is properly vented at the top, provides for the movement of cooling air through the riser. The temperature in a riser can thus be reduced -9 °C to -6 °C (+15 °F to +20 °F) improving the service life of the cable and increasing its load-carrying capacity.
- The Type KVM conduit ventilator has a male threaded nipple at the top and is used in conjunction with a cable terminator or other device having a female thread where ventilation is desired.

Material/Finish

- Bodies of fittings are cast Aluminum.
- Type KVM nipple is steel, zinc electroplated.

Optional Material

- KVM nipple: available in aluminum. Add suffix **-A** to catalog number.

Illustrated Features

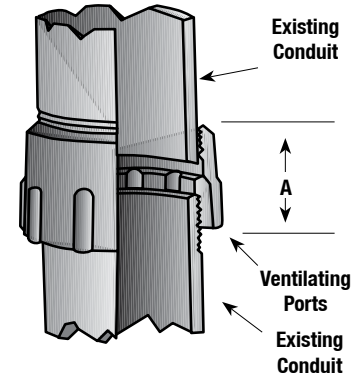

Type KVF

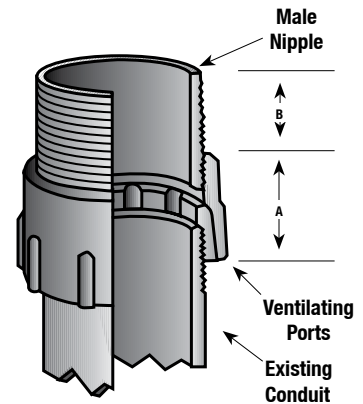

Type KVM

Conduit Size (Inches)	Type KVF		Type KVM		Dimensions in Millimeters (Inches)			Catalog Number
	Trade Size Top Female Thd.	Catalog Number	Trade Size Top Male Thd.	Max Dia.	A.	B. Approx.		
1-1/2	1 1/2"	KVF-1515	1-1/2	69.9 (2.75)	44.5 (1.75)	25.4 (1.00)	KVM-1515	
2	2"	KVF-2020	2	82.6 (3.25)	44.5 (1.75)	28.7 (1.13)	KVM-2020	
2-1/2	2 1/2"	KVF-2525	2-1/2	98.6 (3.88)	57.2 (2.25)	35.1 (1.38)	KVM-2525	
3	3"	KVF-3030	3	114.3 (4.50)	57.2 (2.25)	38.1 (1.50)	KVM-3030	
3-1/2	3 1/2"	KVF-3535	3-1/2	127.0 (5.00)	63.5 (2.50)	38.1 (1.50)	KVM-3535	
4	4"	KVF-4040	4	139.7 (5.50)	63.5 (2.50)	41.4 (1.63)	KVM-4040	
5	5"	KVF-5050	5	184.2 (7.25)	73.2 (2.88)	41.4 (1.63)	KVM-5050	
6	6"	KVF-6060	6	209.6 (8.25)	73.2 (2.88)	44.5 (1.75)	KVM-6060	

Type G Cable Supports

Lay-In-Lug™ Grounding Lugs for use with Cable Supports

Factory Installed. For mounting on O-Z/Gedney™ fittings, Copper Plus™ Lay-In-Lug™ Grounding Wire Connectors.

NEC/CEC:
Listed for Ordinary Locations

Application

- Provides a compact means of attaching a grounding or bonding conductor to an O-Z/Gedney™ fitting.

Features

- Highly conductive tin-plated copper saddle for use with copper or aluminum conductors.
- Connector opening allows easy insertion of grounding conductor for thru or end connection.
- Low grounding connector profile.
- Spring action design maintains positive firm contact on grounding conductor.
- These grounding wire connectors are used on the specification insulated grounding bushings.
- Grounding lugs not sold separately.

Material/Finish

- Grounding Saddle/Tin Plated Copper
- Clamping Tension Body/Stainless Steel
- Screws/Stainless Steel

NEC/CEC Certifications and Compliances

- UL Standard: ANSI/UL 514B, 467
- UL Listed: E-24264
- CSA Standard: C22.2 No. 18, 41
- CSA Certified: 11584

Note:

- Type G Grounding Lugs are only furnished factory-mounted to O-Z/Gedney™ fittings.
- Grounding Lugs are not sold separately.
- Type G Grounding Lugs are not compatible with all O-Z/Gedney™ fittings in this catalog. Please review specific fittings catalog page to insure compatibility. If unsure, please contact your local representative before ordering.

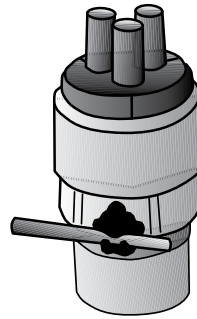

Mounted on Cable Support

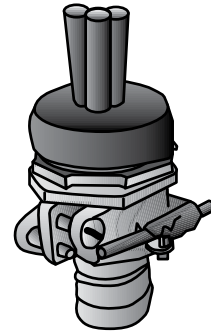

Mounted on PK Clamp

TO ORDER:

Place the order for each grounding lug on the next order line immediately after the fitting that the lug will be attached to. See Note prior to ordering.

Ordering Example:

Item #	Quantity	Description	Part Number
1	5	Cable Termination	PK-200
2	5	Grounding Lug	G-04S

Grounding Min.	Wire Size ① Max.	Lug Rating	Trade Size (Inches) ②	Part Number
14	4	CU only	1/2 – 6	G-04S
8	2/0	AL-CU	1/2 – 6	G-22S
6	4/0	AL-CU	2-1/2 – 6	G-24S
250	500	CU only	2-1/2 – 6	G-25S

① Solid or stranded for No. 4 AWG or smaller; stranded for No. 2 or larger

② Indicates trade sizes of fitting to which grounding wire connector can be mounted.

Type F Cable Supports

Unthreaded Conduit

For Wire Armored Cable

NEC/CEC:
Rated for Ordinary Locations

Applications

- For supporting wire armored cable in a vertical rise. Also used for supporting submarine cables up to 10,000 lbs.

Material/Finish

- Steel/Hot dip galvanized

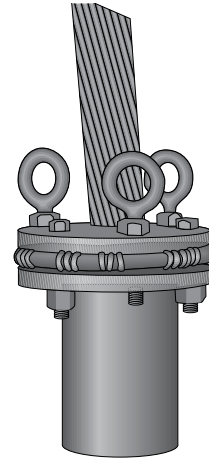

Upper end of cable, supported by Type F Cable

Illustrated Features

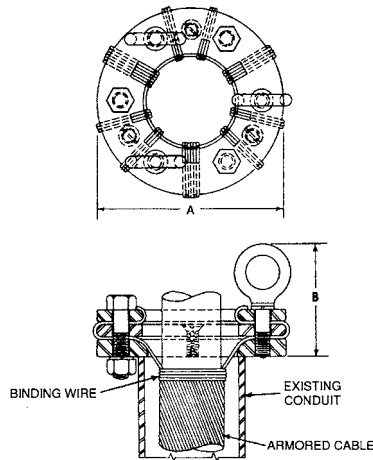

Type F – For Use with Unthreaded Conduit

Max. Conduit Size	Max. Cable Dia. over Wire Armor ①	Dimensions in Millimeters (Inches)		Catalog Number
		A	B. Approx.	
3	2	177.8 (7.00)	120.7 (4.75)	F-3020
4	3	203.2 (8.00)	120.7 (4.75)	F-4030
5	4	228.6 (9.00)	120.7 (4.75)	F-5040
6	5	254.0 (10.00)	158.8 (6.25)	F-6050

① No minimum cable O.D.

Type FT and FS Cable Supports

FT: Threaded Conduit, FS: Structure Mount

For Wire Armored Cable

NEC/CEC:
Rated for Ordinary Locations

Illustrated Features

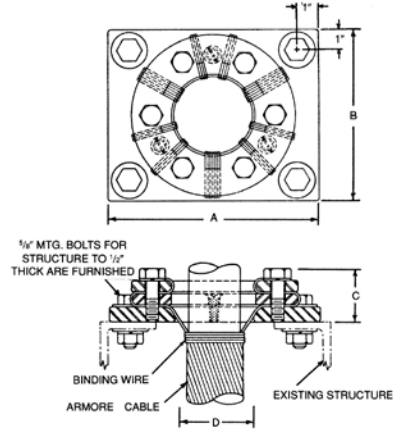
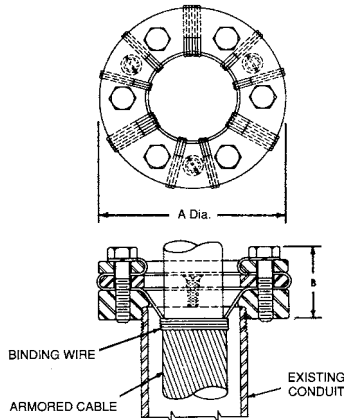

Type FT – For Use with Threaded Conduit

Type FS – For Mounting on an Existing Structure

Type FT

Max. Conduit Size	Max. Cable Dia. over Wire Armor ①	Dimensions in Millimeters (Inches)		Catalog Number
		A	B. Approx.	
3	2	177.8 (7.00)	73.2 (2.88)	FT-3020
4	3	203.2 (8.00)	73.2 (2.88)	FT-4030
5	4	228.6 (9.00)	73.2 (2.88)	FT-5040
6	5	254.0 (10.00)	101.6 (4.00)	FT-6050

Type FS

Dimensions in Millimeters (Inches)				
A	B. Approx.	C	D	Catalog Number
228.6 (9.00)	177.8 (7.00)	63.5 (2.50)	63.5 (2.50)	FS-0720
254.0 (10.00)	203.2 (8.00)	63.5 (2.50)	88.9 (3.50)	FS-0830
279.4 (11.00)	228.6 (9.00)	63.5 (2.50)	114.3 (4.50)	FS-0940
304.8 (12.00)	254.0 (10.00)	88.9 (3.50)	139.7 (5.50)	FS-1050

① No minimum cable O.D.

Type SF 1773 Cable Supports

For Wire Armored Cable

NEC/CEC:
Rated for Ordinary Locations

Auxiliary Supports

Special auxiliary support specified for use at the lower end of a conduit riser may be provided as an added factor of safety up to 10,000 lbs. Similar types are often used as intermediate supports when armored cable is run exposed. Contact your local representative for price and availability.

Notes

- All parts to be Hot Dip Galvanized except as noted.
- All Dimensions are nominal and may vary according to normal Foundry and Manufacturing Tolerances.

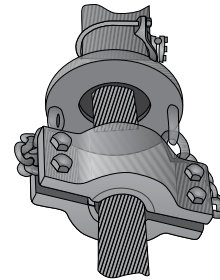

Type SF 1773

Illustrated Features

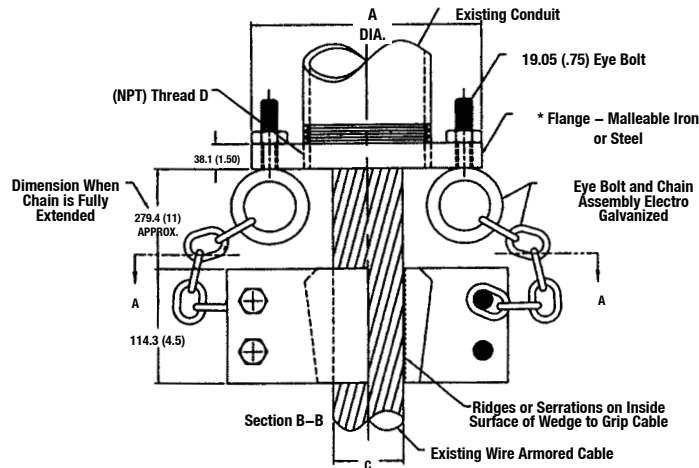
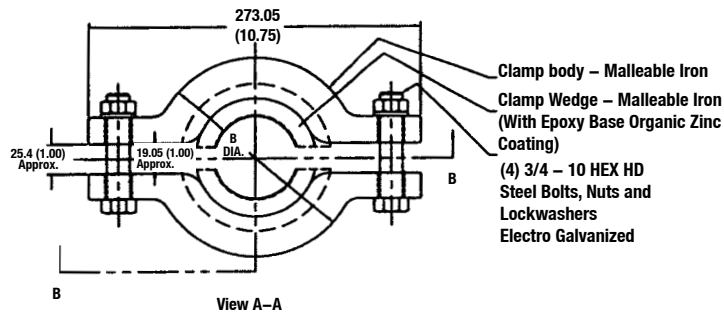

Dimensions in Millimeters (Inches)

Conduit Size (Inches)	Max. Cable DIA C	Min. Cable DIA C	Max. Conduit THD in Flange D	A DIA	B DIA	Catalog ① Number
5	4	3	127.0 (5.00)	231.9 (9.13)	196.9 (7.75)	SF1773-L4050
6	4	3	152.4 (6.00)	276.4 (10.88)	196.9 (7.75)	SF1773-L4060

① Supports are available less Flange for mounting to structure - Specify Catalog Number less the last two numerals. ie: SF1773L40.