

CHANCE[®]

Grounding Equipment

Catalog 3000 March 2020

Grounding Equipment – 3000



Safe Working Practices

There are many reasons for temporary grounding to protect personnel working on de-energized circuits, including:

1. Induced voltage from adjacent energized lines
2. Fault-current feedover from adjacent lines
3. Lightning strikes anywhere on the circuit
4. Switching-equipment malfunction or human error
5. Accident-initiated contact with adjacent lines
6. Backfeed from solar panels or incorrectly wired generators

Since any one of the above could result in re-energizing the circuit, most utilities treat these potential dangers as ever-present and impose strict temporary-grounding work rules. Their crews' experience often voices these watchwords for the wise to heed:

"If you can't see both ends, it's hot" and "If it isn't grounded, it isn't dead."

Vital Procedure Recommendations

Step One: Testing

- With a test instrument, confirm the circuit to be worked has been de-energized intentionally before ground sets are applied

Step Two: Cleaning

- For a good connection, scrub oxides and contaminants from conductor, buswork or lattice contact points
- CHANCE universal wire brushes make this easy

Step Three: Connecting

- CHANCE insulated Grip-All clampsticks are the proper tools to apply grounding clamps
- Various clampstick lengths and styles are available in Catalog Section 2100, "Insulated Hand Tools"



To indicate energized conditions on overhead lines, (from left) CHANCE Auto Ranging Voltage Indicator, Multi-Range Voltage Indicator and Multi-Range Voltage Detector. At far right, Energized Cable Sensor performs the same function on URD cable with an exposed concentric neutral and elbows without test points. See Catalog Section 2450, "Instruments and Meters," for details and ordering information.

Safety Reviews

- Equipotential grounding is recommended for personal protection
- Temporary grounding practices should be reviewed on a regular basis and after system changes
- These basics should be included on a review checklist:
 1. Clamp designs specific to each application
 2. Adequacy of grounding equipment to handle maximum potential fault current (see table on page 3002) and minimum slack lengths
 3. How construction affects placement of grounds
 4. Work procedures outlined above
 5. Inspect and test each grounding set

CHANCE Grounding-Set Tester

- Ideal for testing grounding sets
- Checks the resistance in a protective ground set
- Can help locate problems often remedied by simple repairs
- How-to video is included with the tester
- See Catalog Section 2450, "Instruments and Meters," for details and ordering information



TABLE 1 Protective Ground Cable, Ferrule, Clamp and Assembly Ratings for Symmetrical Current

Grade	Grounding Clamp Torque Strength, min				Short Circuit Properties ^A								Continuous Current Rating A RMS, 60 Hz
	Yield ^B		Ultimate		Withstand Rating, Symmetrical kA RMS, 60 Hz			Ultimate Rating Capacity ^{C,D} , Symmetrical kA RMS, 60 Hz					
	lbf-in.	n-m	lbf-in.	n-m	15 cycles (250 ms)	30 cycles (500 ms)	Copper Cable Size	15 cycles (250 ms)	30 cycles (500 ms)	60 cycles (1 s)	Maximum Copper Test Cable Size		
1	280	32	330	37	14	10	#2	18	13	9	2/0	200	
2	280	32	330	37	21	15	1/0	29	21	14	4/0	250	
3	280	32	330	37	27	20	2/0	37	26	18	4/0	300	
4	330	37	400	45	34	25	3/0	47	33	23	250 kcmil	350	
5	330	37	400	45	43	30	4/0	59	42	29	250 kcmil	400	
6	330	37	400	45	54	39	250 kcmil or 2 2/0	70	49	35	350 kcmil	450	
7	330	37	400	45	74	54	350 kcmil or 2 4/0	98	69	48	550 kcmil	550	

^A Withstand and ultimate short circuit properties are based on performance with surges not exceeding 20% asymmetry factor (see 9.1 and 12.3.4.2).
^B Yield shall mean no permanent deformation such that the clamp cannot be reused throughout its entire range of application.
^C Ultimate rating represents a symmetrical current which the assembly or individual components shall carry for the specified time.
^D Ultimate values are based upon application of Onderdonk's equation to 98% of nominal circular mil area allowed by Specifications B172 and B173.

TABLE 2 Ultimate Assembly Rating for High X/R Ratio Applications

High Asymmetrical Test Requirements X/R = 30 Cycle Current Peak Values (kA) Rating X 2.69					
Grade Size	Rating Rated Current (kA)	1st	15th	Test Duration (cycles)	1 ² t (Mega amps ² -s)
1H	15	41	23	15	74
2H	25	68	38	15	208
3H	31	84	46	15	312
4H	39	105	58	15	501
5H	47	127	70	15	728
6H	55	148	82	15	997
7H	68	183	101	15	1523

NOTE 1 – The above current values are based on electromechanical test values.
 NOTE 2 – Assemblies that have been subjected to these shall not be re-used.
 NOTE 3 – For use with currents exceeding 20% asymmetry factor.
 NOTE 4 – See X4.7.2 for additional information.
 NOTE 5 – Alternate testing circuits are available for laboratories that cannot achieve the above requirements. See Appendix X4 for details.

Selecting grounding clamps and cable

The CHANCE grounding line comprises both ready-made sets and separate components for your specific needs. Among the options and criteria to consider:

- Functional fit—Sizes of the clamp types in this section appear in ascending order of maximum-main-line size. By design, many clamps serve a wide size range for their conductor type (cable, bus or tower)
- Adequate capacity—Published ratings for both clamps and cable must withstand maximum-potential system fault-current magnitude and full-time duration. Test reports are available on request
- Coordinated connectors—Terminal (either pressure-type or threaded-type) selected for clamps dictates the cable ferrule type (either plain or threaded) to match
- On-site handling—Application clearances and fit (for overhead conductors and ground wires, transmission tower shapes, URD apparatus or substation buswork) affect clamp and cable dimensions

How to order a Grounding Set

In addition to the specifying criteria above, each part of a grounding set requires certain choices:

1. Clamps
 - ASTM designations for Type, Class and Grade given for clamps shown in this section
2. Ferrules
 - Copper, tin-plated copper or aluminum
 - Plain or threaded
3. Cable
 - Length required to reach application distances
 - ASTM Type I with black or yellow elastomer jackets for temperatures from -40°F (-40°C) through +194°F (+90°C)
 - ASTM Type III with clear thermoplastic jacket for temperatures from +14°F (-10°C) through +140°F (+60°C) should be used only in well-ventilated areas
4. Support Stud
 - This option recommended on only one clamp to help control lifting the set to the first clamp attachment point
 - Support studs are not designed to handle fault current unless otherwise noted.
5. Shrink Tubing
 - This translucent option recommended for stress relief and inspection of cable strands between ferrule and jacket.

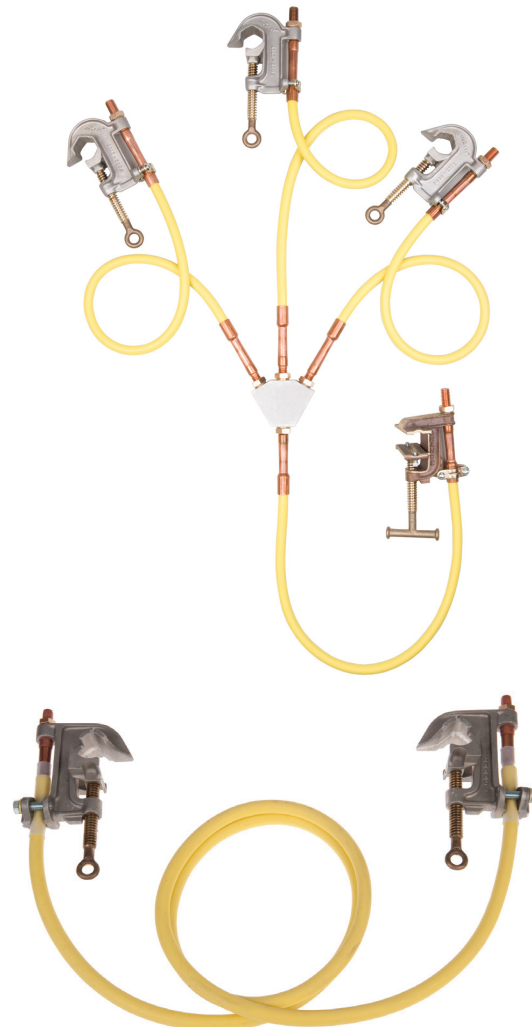
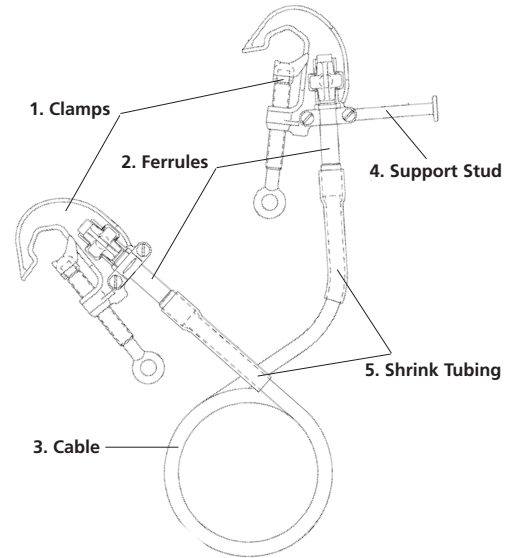

Installation information

- Several training aids available on request
- CHANCE videos and technical manuals provide details on proper installation
- Consult your CHANCE representative for any additional assistance

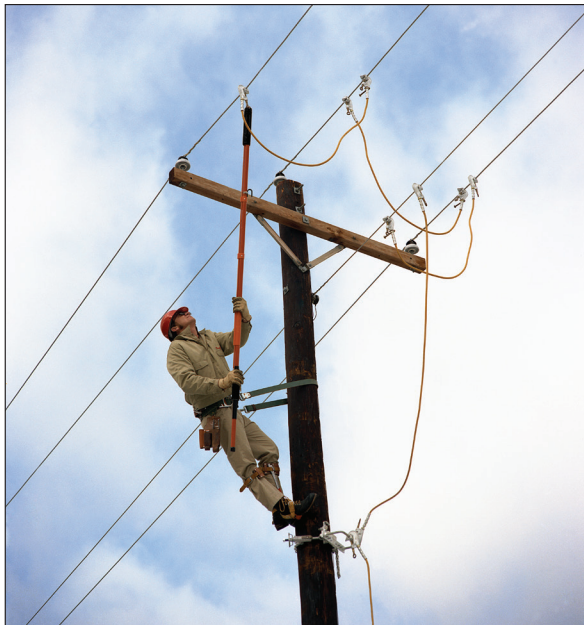

C-Type Grounding Clamps



T6000465
Bronze body,
Smooth jaws,
Bronze eyescrew
with fine threads,
Tapped for 5/8-11 UNC threaded ferrule
or T6000466,
Drilled for 5/8-11 UNC threaded ferrule



T6000790
Bronze body,
Smooth jaws,
Bronze T-handle/eyescrew
with fine threads,
Tapped for 5/8-11 UNC
threaded ferrule



C6002271
Bronze body,
Smooth jaws,
Bronze eyescrew
with fine threads,
Tapped for 5/8-11 UNC
threaded ferrule



C6001959
Bronze body,
Smooth jaws,
Bronze T-handle/eyescrew
with fine threads,
Tapped for 5/8-11 UNC
threaded ferrule

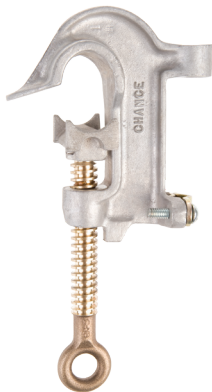

C6001754
Aluminum body,
Smooth jaws,
Bronze eyescrew
with Acme threads,
Tapped for 5/8-11 UNC
threaded ferrule

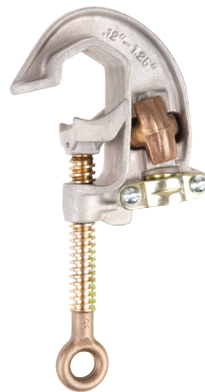

C6002275
Aluminum body,
Smooth jaws,
Bronze eyescrew
with Acme threads,
Bronze pressure-type
terminals



C6002276
Aluminum body,
Serrated jaws,
Bronze eyescrew
with Acme threads,
Bronze pressure-type
terminals

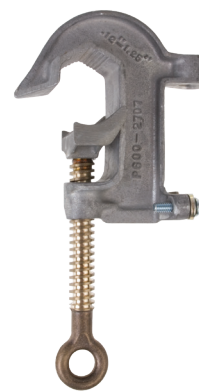

T6002708
Aluminum body,
Serrated jaws,
Bronze eyescrew
with Acme threads,
Tapped for 5/8-11 UNC
threaded ferrule



C6001743
Aluminum body,
Smooth jaws,
Bronze eyescrew
with fine threads,
Tapped for 5/8-11 UNC
threaded ferrule

Catalog Number	C6001959 T6000465 T6000466 T6000790	C6002271	C6001754	C6002275	C6002276	T6002708	C6001743
----------------	----------------------------------------------	----------	----------	----------	----------	----------	----------

ELECTRICAL RATINGS

Continuous Current (AMPS)	250	400	350	400	400	400	400
Fault Current - 15 Cycles (AMPS)	21,000	43,000	27,000	43,000	43,000	43,000	43,000
Fault Current - 30 Cycles (AMPS)	15,000	30,000	20,000	30,000	30,000	30,000	30,000

MECHANICAL RATINGS

Recommended Torque (in.-lb.)	200	250	250	250	250	250	250
Main Line Range - Max.	477 kcmil ACSR (0.814")	1033 kcmil ACSR (1.25")	750 kcmil Str. Cu. 636 kcmil ACSR (0.998")	1033 kcmil ACSR (1.25")	1033 kcmil ACSR (1.25")	1033 kcmil ACSR (1.25")	1000 kcmil Cu. 1590 kcmil ACSR (1.50")
Main Line Range - Min.	#6 Sol. Cu. (0.162")	#6 Sol. Cu. (0.162")	#8 Sol. Cu. (0.128")	#8 Sol. Cu. (0.128")	#8 Sol. Cu. (0.128")	#8 Sol. Cu. (0.128")	#6 Sol. Cu. (0.162")
Jumper Range - Max.	1/0 Grd. Cable	4/0 Grd. Cable	2/0 Grd. Cable	4/0 Grd. Cable	4/0 Grd. Cable	4/0 Grd. Cable	4/0 Grd. Cable
Jumper Range - Min.	#2 Grd. Cable	#2 Grd. Cable	#2 Grd. Cable	#2 Grd. Cable	#2 Grd. Cable	#2 Grd. Cable	#2 Grd. Cable
Weight Each	1 1/2 lb. / 0.7 kg.	2 lb. / 0.9 kg.	1 lb. / 0.5 kg.	1 1/4 lb. / 0.6 kg.	1 1/4 lb. / 0.6 kg.	1 1/4 lb. / 0.6 kg.	1 1/2 lb. / 0.7 kg.
ASTM Designation	Type I Class A Grade 2	Type I Class A Grade 5	Type I Class A Grade 3	Type I Class A Grade 5	Type I Class B Grade 5	Type I Class B Grade 5	Type I Class A Grade 5
IEC Ratings							
Jaws	Smooth	Smooth	Smooth	Smooth	Serrated	Serrated	Smooth
Ferrule	Threaded	Threaded	Threaded	Plain Plug	Plain Plug	Threaded	Threaded

C-Type Grounding Clamps



C6002281
Aluminum body,
Smooth jaws,
Bronze eyescrew
with Acme threads
Bronze pressure-type terminal



C6002255
Aluminum body,
Smooth jaws,
Bronze eyescrew
with Acme threads,
Tapped for 5/8-11 UNC threaded
ferrule
*Unshrouded Ferrules Only



C6002282
Aluminum body,
Serrated jaws,
Bronze eyescrew
with Acme threads
Bronze pressure-type terminal



C6002256
Aluminum body,
Serrated jaws, Bronze eyescrew
with Acme threads,
Tapped for 5/8-11 UNC threaded ferrule
or PSC6003412,
Drilled for 5/8-11 UNC threaded ferrule
*Unshrouded Ferrules Only



C6000386
*Mounted Clamp
Aluminum body,
Serrated jaws,
Bronze eyescrew
with Acme threads,
Bronze pressure-type terminal

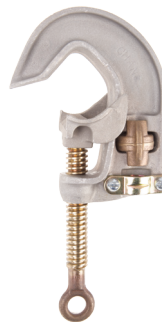

G36051
Aluminum body,
Smooth jaws,
Bronze eyescrew
with Acme threads,
Bronze pressure-type terminal



T6003203
Aluminum body,
Smooth jaws,
Bronze eyescrew
with Acme threads,
Tapped for 5/8-11 UNC
threaded ferrule
*Unshrouded Ferrules
Only



T6000658
Aluminum body, Smooth jaws,
Bronze eyescrew with Acme threads,
Drilled for 5/8-11 UNC threaded
ferrule
or T6000311 Tapped for 5/8-11 UNC
threaded ferrule

Catalog Number	C6002281	C6002255	C6002282	C6002256 (threaded) PSC6003412 (drilled)	*C6000386	G36051	T6003203	T6000658 (drilled) T6003011 (threaded)
----------------	----------	----------	----------	---------------------------------------------------	-----------	--------	----------	-------------------------------------------------

ELECTRICAL RATINGS

Continuous Current (amps)	400	400	400	400	400	400	400	400
Fault Current - 15 Cycles (amps)	43,000	47,000 High X/R	43,000	47,000 High X/R	43,000	43,000	43,000	55,000 High X/R
Fault Current - 30 Cycles (amps)	30,000		30,000		30,000	30,000	30,000	

MECHANICAL RATINGS

Recommended Torque (in.-lb.)	250	250	250	250	250	250	250	250
Main Line Range - Max.	2" O.D. Bus	2" O.D. Bus	2" O.D. Bus	2" O.D. Bus	2" O.D. Bus	2" O.D. Bus	2" O.D. Bus	2" O.D. Bus
Main Line Range - Min.	#6 Sol. Cu. (0.162")	#6 Sol. Cu. (0.162")	#6 Sol. Cu. (0.162")	#6 Sol. Cu. (0.162")	#6 Sol. Cu. (0.162")	#6 Sol. Cu. (0.162")	#6 Sol. Cu. (0.162")	#6 Sol. Cu. (0.162")
Jumper Range - Max.	4/0 Grd. Cable	4/0 Grd. Cable	4/0 Grd. Cable	4/0 Grd. Cable	4/0 Grd. Cable	4/0 Grd. Cable	4/0 Grd. Cable	4/0 Grd. Cable
Jumper Range - Min.	#2 Grd. Cable	#2 Grd. Cable	#2 Grd. Cable	#2 Grd. Cable	#2 Grd. Cable	#2 Grd. Cable	#2 Grd. Cable	#2 Grd. Cable
Weight Each	2 lb. / 0.9 kg.	1¾ lb./0.8 kg.	2 lb. / 0.9 kg.	1¾ lb./0.8 kg.	*	1¾ lb./0.8 kg.	1¾ lb./0.8 kg.	1¾ lb./0.8 kg.
ASTM Designation	Type I Class A Grade 5	Type I Class A Grade 5H	Type I Class B Grade 5	Type I Class B Grade 5H	Type II Class B Grade 5	Type I Class A Grade 5	Type I Class A Grade 5	Type I Class A Grade 6H
IEC Ratings		35 kA		35 kA				
Jaws	Smooth	Smooth	Serrated	Serrated	Serrated	Smooth	Smooth	Smooth
Ferrule	Plain Plug	Threaded *Unshrouded Only	Plain Plug	Threaded *Unshrouded Only	Plain Plug	Plain Plug	Threaded	Threaded

*C6000386 has 1-1/4" x 6' Epoxiglas® Pole and total weight of 3¾ lb. (1.7 kg.).



C-Type Grounding Clamps

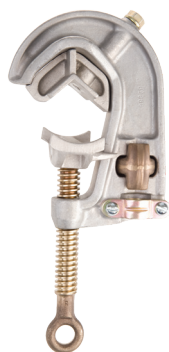

G33672
Aluminum body,
Smooth jaws,
Bronze eyescrew
with Acme threads,
Bronze pressure-type threads



C6001733
Aluminum body,
Smooth jaws,
Bronze eyescrew
with Acme threads,
Tapped for 5/8-11 UNC threaded ferrule
*Unshrouded Ferrules Only



C6000375
Aluminum body,
Serrated jaws,
Bronze eyescrew
with Acme threads,
Dual drilled for 5/8-11 UNC threaded ferrule

Bus-Bar Grounding Clamps:

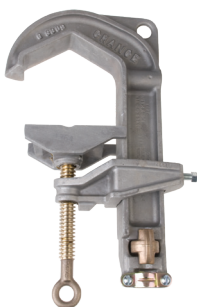

G3369
Aluminum body,
Smooth jaws,
Bronze eyescrew
with Acme threads,
Bronze pressure-type
terminal



C6000337
Aluminum body,
Smooth jaws,
Bronze eyescrew
with Acme threads,
Bronze pressure-type
terminal



T6000819
Aluminum body,
Smooth jaws,
Bronze eyescrew
with Acme threads,
rated stud

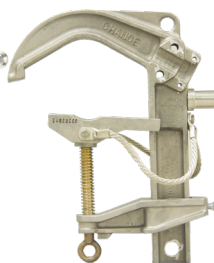

T6000844
Aluminum body,
Smooth jaws,
Bronze eyescrew
with Acme threads,
rated stud

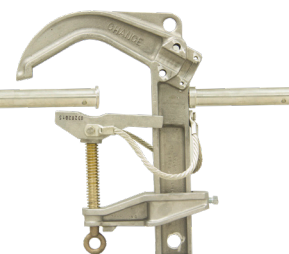

PSCT6000844001
Aluminum body,
Smooth jaws,
Bronze eyescrew
with Acme threads,
rated stud

Catalog Number	G33672	C6001733	C6000375	G3369	C6000337	T6000819 (8.5" x .75" stud)	T6000844 (8.5" x 1" stud)	PSCT6000844001 (6" x 1.25" stud)
----------------	--------	----------	----------	-------	----------	-----------------------------------	---------------------------------	-------------------------------------

ELECTRICAL RATINGS

Continuous Current (AMPS)	400	400	400	400	400	400	400	400
Fault Current - 15 Cycles (AMPS)	43,000	43,000	†70,000	43,000	43,000/ 54,000†	47,000 High X/R	47,000 High X/R	68,000 High X/R
Fault Current - 30 Cycles (AMPS)	30,000	30,000	†50,000	30,000	30,000/ 39,000†			

MECHANICAL RATINGS

Recommended Torque (in.-lb.)	250	250	300	300	300	300	300	300
Main Line Range - Max.	2-1/2" O.D. Bus	2-1/2" O.D. Bus	3" O.D. Bus	4" x 4" Square 4.5" O.D. Bus	6-5/8" O.D. Bus	4" x 4" Square 4.5" OD Bus	6-5/8" O.D. Bus	6-5/8" O.D. Bus
Main Line Range - Min.	#4 Str. Cu. (.232")	#4 Str. Cu. (.232")	0.50" O.D. Bus	4/0 Str. Cu. (.500")	3-1/2" O.D. Bus	4/0 Str. Cu. (.500")	3-1/2" O.D. Bus	3-1/2" O.D. Bus
Jumper Range - Max.	4/0 Grd. Cable	4/0 Grd. Cable	4/0 Grd. Cable	4/0 Grd. Cable	4/0 Grd. Cable	No Cable, uses Rated Stud	No Cable, uses Rated Stud	No Cable, uses Rated Stud
Jumper Range - Min.	#2 Grd. Cable	#2 Grd. Cable	#2 Grd. Cable	#2 Grd. Cable	#2 Grd. Cable			
Weight Each	2 3/8 lb. / 1.1 kg.	2 3/8 lb. / 1.1 kg.	3 lb. / 1.4 kg.	5 1/4 lb. / 2.4 kg.	6 lb. / 2.7 kg.	5 lb. / 2.3 kg.	7.6 lb/3.5 kg.	7.8 lb/3.5 kg.
ASTM Designation	Type I Class A Grade 5	Type I Class A Grade 5	Type I Class B Grade 7†	Type I Class A Grade 5	Type I Class A Grade 5/ Grade 6†	Type I Class A Grade 5H	Type I Class B Grade 5H	Type I Class B Grade 7H
IEC Rating (15 cycles)	35 kA	35 kA	35 kA					
Jaws	Smooth	Smooth	Serrated	Smooth	Smooth	Smooth	Smooth	Smooth
Ferrule	Plain Plug	Threaded	Threaded	Plain Plug	Plain Plug	Rated Stud	Rated Stud	Rated Stud

†Rating with twin-grounding cables.



Snap-On (Duckbill-type) Grounding Clamps



G18102
Aluminum body,
Bronze upper jaw,
Smooth jaws,
Bronze eyescrew
with fine threads,
Bronze pressure-type terminal



G36221
Aluminum body,
Smooth jaws,
Bronze eyescrew
with fine threads,
Bronze pressure-type terminal



HG37061
*Mounted Clamp
Aluminum body,
Smooth jaws,
Bronze eyescrew
with fine threads,
Bronze pressure-type terminal

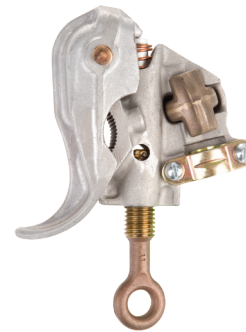

T6000806
Aluminum body,
Serrated jaws,
Bronze eyescrew
with fine threads,
Bronze pressure-type terminal

Catalog Number	G18102	G36221	*HG37061	T6000806
----------------	--------	--------	----------	----------

ELECTRICAL RATINGS

Continuous Current (AMPS)	300	400	400	400
Fault Current - 15 Cycles (AMPS)	27,000	43,000	34,000	43,000
Fault Current - 30 Cycles (AMPS)	20,000	30,000	25,000	30,000

MECHANICAL RATINGS

Recommended Torque (in.-lb.)	230	250	300	300
Main Line Range - Max.	250 kcmil Str. Cu. 4/0 ACSR (0.574")	566 kcmil Cu. 900 kcmil ACSR (1.162")	566 kcmil Cu. 900 kcmil ACSR (1.162")	1590 kcmil ACSR (1.625")
Main Line Range - Min.	#6 Sol. Cu. (0.162")	#6 Sol. Cu. (0.162")	#6 Sol. Cu. (0.162")	0.5"
Jumper Range - Max.	2/0 Grd. Cable	4/0 Grd. Cable	4/0 Grd. Cable	4/0 Grd. Cable
Jumper Range - Min.	#2 Grd. Cable	#2 Grd. Cable	#2 Grd. Cable	#2 Grd. Cable
Weight Each	1½ lb. / 0.6 kg.	1½ lb. / 0.6 kg.	*	1¾ lb. / 0.8 kg.
ASTM Designation	Type I Class A Grade 3	Type I Class A Grade 5	Type II Class A Grade 4	Type I Class B Grade 5
IEC Rating (15 cycles)		35 kA		
Jaws	Smooth	Smooth	Smooth	Serrated
Ferrule	Plain Plug	Plain Plug	Plain Plug	Plain Plug

*HG37061 has 1¼" x 6' Epoxiglas® Pole and total weight of 3½ lb. (1.6 kg.).



Snap-On (Duckbill-type) Grounding Clamps



C6001734
Aluminum body,
Smooth jaws,
Bronze eyescrew
with fine threads,
Tapped for 5/8-11 UNC threaded ferrule



C6000198
*Mounted Clamp
Aluminum body,
Serrated jaws,
Bronze eyescrew
with Acme threads,
Tapped for 5/8-11 UNC threaded ferrule



C6000197
Aluminum body,
Serrated jaws,
Bronze eyescrew
with Acme threads,
Tapped for 5/8-11 UNC threaded ferrule



C6001757
Aluminum body,
Smooth jaws,
Bronze eyescrew
with fine threads,
Tapped for 5/8-11 UNC threaded ferrule



C6000434
Aluminum body,
Serrated jaws,
Bronze eyescrew
with fine threads,
Bronze pressure-type terminal

Catalog Number	C6001734	*C6000198	C6000197	C6001757	C6000434
----------------	----------	-----------	----------	----------	----------

ELECTRICAL RATINGS

Continuous Current (AMPS)	400	400	400	400	400
Fault Current - 15 Cycles (AMPS)	31,000 High X/R / 43,000	43,000	47,000 High X/R	43,000	43,000
Fault Current - 30 Cycles (AMPS)	30,000	30,000		30,000	30,000

MECHANICAL RATINGS

Recommended Torque (in.-lb.)	250	250	250	250	250
Main Line Range - Max.	566 kcmil Cu. 900 kcmil ACSR (1.162")	700 kcmil Cu. 1113 kcmil ACSR (1.293")	700 kcmil Cu. 1113 kcmil ACSR (1.293")	2.5"	700 kcmil Cu. 1113 kcmil ACSR (1.293")
Main Line Range - Min.	#6 Sol. Cu. (0.162")	#6 Sol. Cu. (0.162")	#6 Sol. Cu. (0.162")	0.75"	#6 Sol. Cu. (0.162")
Jumper Range - Max.	4/0 Grd. Cable	4/0 Grd. Cable	4/0 Grd. Cable	4/0 Grd. Cable	4/0 Grd. Cable
Jumper Range - Min.	#2 Grd. Cable	#2 Grd. Cable	#2 Grd. Cable	#2 Grd. Cable	#2 Grd. Cable
Weight Each	1½ lb. / 0.7 kg.	*	1½ lb. / 0.7 kg.	2¼ lb. / 1.0 kg.	1½ lb. / 0.7 kg.
ASTM Designation	Type I Class A Grade 3H/Grade 5	Type II Class B Grade 5	Type I Class B Grade 5H	Type I Class A Grade 5	Type I Class B Grade 5
IEC Rating (15 cycles)	35 kA		35 kA		
Jaws	Smooth	Serrated	Serrated	Smooth	Serrated
Ferrule	Threaded	Threaded	Threaded	Threaded	Plan Plug

*C6000198 has 1¼" x 6' Epoxiglas[®] Pole and total weight of 3½ lb. (1.6 kg.).

Cluster Grounding Clamps

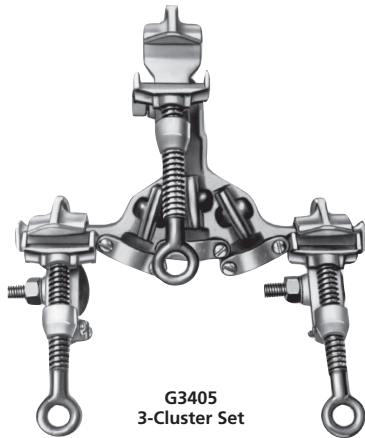

G3405
3-Cluster Set

with C-Type Aluminum-body clamps,

Smooth jaws, Bronze eyescrews with Acme threads,
and 3-phase Aluminum cluster bar
with Bronze Pressure-type terminals

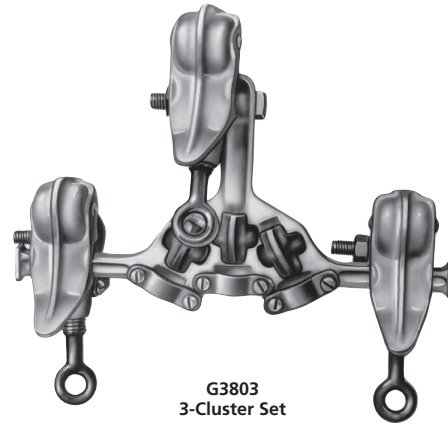

G3803
3-Cluster Set

with Snap-On (Duckbill-type) Aluminum-body clamps,

Smooth jaws, Bronze eyescrews with fine threads,
and 3-phase Aluminum cluster bar
with Bronze Pressure-type terminals

Important Note:

Cluster Sets are furnished as shown above. The center clamp is bolted to the cluster bar.

Typical fourth ground clamp
(not included in 3-Cluster Set,
must be ordered as separate item)

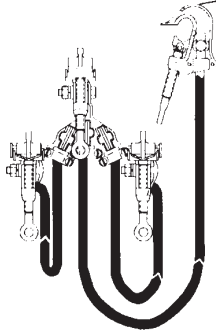

These drawings illustrate how Cluster Sets are to be connected, with **grounding cable** and a **fourth clamp** which **must be ordered separately**.

For cable and ferrules, see page 3021.

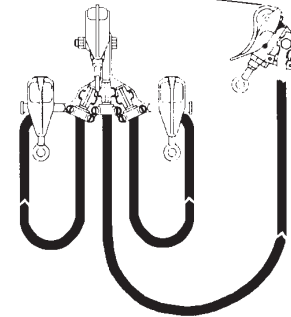

Catalog Number	G3405	G3803
ELECTRICAL RATINGS		
Continuous Current (AMPS)	350	400
Fault Current - 15 Cycles (AMPS)	27,000	34,000
Fault Current - 30 Cycles (AMPS)	20,000	25,000
MECHANICAL RATINGS		
Recommended Torque (in.-lb.)	250	250
Main Line Range - Max.	400 kcmil Str. Cu. 636 kcmil ACSR (.998")	566 kcmil Cu. 900 kcmil ACSR (1.162")
Main Line Range - Min.	#8 Sol. Cu. (0.12")	#6 Sol. Cu. (0.162")
Jumper Range - Max.	2/0 Grd. Cable	4/0 Grd. Cable
Jumper Range - Min.	#2 Grd. Cable	#2 Grd. Cable
Weight Each	4½ lb. / 2 kg.	6⅝ lb. / 3 kg.
ASTM Designation	Type I Class A Grade 3	Type I Class A Grade 4
Jaws	Smooth	Smooth
Ferrule	Plain Plug	Plain Plug

Tower & Flat-Face Grounding Clamps



C6002232
Bronze body, Serrated jaws,
Bronze eyescrew with Acme threads,
Drilled for 5/8-11 UNC threaded ferrule
or T6003196,
Tapped for 5/8-11 UNC threaded ferrule
or PST6003485
for Fine Thread Eyescrew version

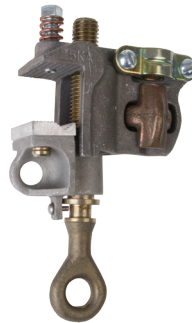

G336335J
Aluminum body,
Serrated jaws,
Bronze eyescrew
with fine threads,
Bronze pressure-type terminal



C6001735
Aluminum body,
Serrated jaws,
Bronze eyescrew
with fine threads,
Tapped for 5/8-11 UNC threaded ferrule



C6002231
Bronze body, Serrated jaws,
Bronze T-handle with Acme threads,
Drilled for 5/8-11 UNC threaded ferrule
or T6003195,
Tapped for 5/8-11 UNC threaded ferrule
or T6003009,
with Fine Threads T-Handle version

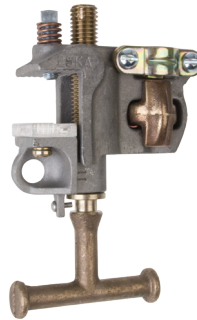

G336345J
Aluminum body,
Serrated jaws,
Bronze T-handle
with fine threads,
Bronze pressure-type terminal



T6001798
Aluminum body,
Serrated jaws,
Bronze T-handle
with Acme threads,
Tapped for 5/8-11 UNC threaded ferrule

Catalog Number	C6002232	G336335J	C6001735	C6002231	G336345J	T6001798
ELECTRICAL RATINGS						
Continuous Current (AMPS)	400	400	400	400	400	400
Fault Current - 15 Cycles (AMPS)	43,000	27,000	27,000	43,000	27,000	27,000
Fault Current - 30 Cycles (AMPS)	30,000	20,000	20,000	30,000	20,000	20,000
MECHANICAL RATINGS						
Recommended Torque (in.-lb.)	250	250	250	250	250	250
Main Line Range - Max.	1½" Angles 1½" Flat	1½" Angles 1½" Flat	1½" Angles 1½" Flat	1½" Angles 1½" Flat	1½" Angles 1½" Flat	1½" Angles 1½" Flat
Main Line Range - Min.	⅛"	⅛"	⅛"	⅛"	⅛"	⅛"
Jumper Range - Max.	4/0 Grd. Cable w/Threaded Stud	2/0 Grd. Cable w/Plain Plug	2/0 Grd. Cable w/Threaded Stud	4/0 Grd. Cable w/Threaded Stud	2/0 Grd. Cable w/Plain Plug	2/0 Grd. Cable w/Threaded Stud
Jumper Range - Min.	#2 Grd. Cable w/Threaded Stud	#2 Grd. Cable w/Plain Plug	#2 Grd. Cable w/Threaded Stud	#2 Grd. Cable w/Threaded Stud	#2 Grd. Cable w/Plain Plug	#2 Grd. Cable w/Threaded Stud
Weight Each	2 lb. / 0.9 kg.	1⅝ lb. / 0.7 kg.	1½ lb. / 0.7 kg.	2 lb. / 0.9 kg.	1⅝ lb. / 0.7 kg.	1½ lb. / 0.7 kg.
ASTM Designation	Type I Class B Grade 5	Type I Class B Grade 3	Type I Class B Grade 3	Type III Class B Grade 5	Type III Class B Grade 3	Type III Class B Grade 3
IEC Rating (15 Cycles)						
Jaws	Serrated	Serrated	Serrated	Serrated	Serrated	Serrated
Ferrule	Threaded	Plain Plug	Threaded	Threaded	Plain Plug	Threaded

Tower & Flat-Face Grounding Clamps



G33631
Bronze body,
Serrated jaws,
Bronze eyescrew
with fine threads,
Bronze pressure-type terminal

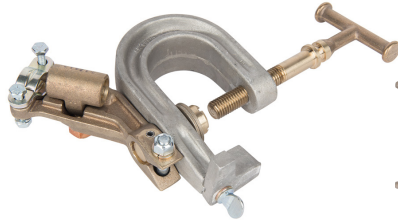

C6003598
Aluminum body and retainer,
Bronze scrubber-type contact pads,
Bronze T-handle
with fine threads,
Tapped for 5/8-11 UNC
threaded ferrule

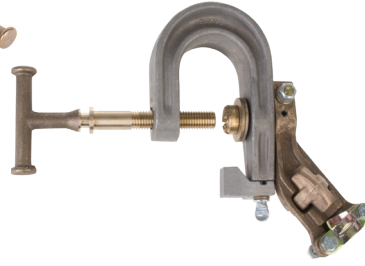

C6000085
Aluminum body and retainer,
Bronze scrubber-type contact pads,
Bronze T-handle
with fine threads,
Bronze pressure-type terminal
(Eyescrew version T6003090)



G33632
Bronze body,
Serrated jaws,
Bronze T-handle
with fine threads,
Bronze pressure-type terminal

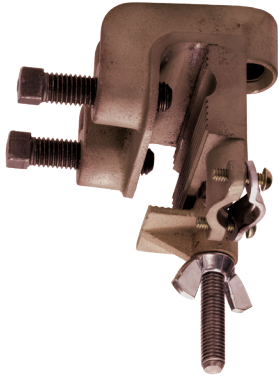

C6001783
Bronze body,
Serrated jaws and retainers,
Tapped for 3/8-11 UNC threaded ferrule



PSC6003635
Aluminum body
Serrated jaws
Tapped for 5/8-11 UNC threaded ferrule



PSC6003636
Aluminum body
Serrated jaws
Tapped for 5/8-11 UNC threaded ferrule

Catalog Number	G33631	C6003598	C6000085	G33632	C6001783	PSC6003635	PSC6003636
----------------	--------	----------	----------	--------	----------	------------	------------

ELECTRICAL RATINGS

Continuous Current (AMPS)	400	400	400	400	400	400	400
Fault Current - 15 Cycles (AMPS)	27,000	47,000 High X/R	43,000	27,000	47,000 High X/R	47,000 High X/R	47,000 High X/R
Fault Current - 30 Cycles (AMPS)	20,000		30,000	20,000			

MECHANICAL RATINGS

Recommended Torque (in.-lb.)	250	250	250	250	300	250 (set screws finger tight)	250 (set screws finger tight)
Main Line Range - Max.	1 1/2" Angles 1 1/2" Flat	4" Structural Angles	4" Structural Angles	1 1/2" Angles 1 1/2" Flat	3/4" x 5" Angles or Flats 5/8" Rod	1-1/2" Angles 1-1/2" Flat	1-1/2" Angles 1-1/2" Flat
Main Line Range - Min.	1/8"	2" Structural Angles	2" Structural Angles	1/8"	1/8"	1/8"	1/8"
Jumper Range - Max.	2/0 Grd. Cable w/Plain Plug	4/0	4/0 Grd. Cable w/Plain Plug	2/0 Grd. Cable w/Plain Plug	4/0 Grd. Cable w/Threaded Stud	4/0	4/0
Jumper Range - Min.	#2 Grd. Cable w/Plain Plug	#2	#2 Grd. Cable w/Plain Plug	#2 Grd. Cable w/Plain Plug	#2 Grd. Cable w/Threaded Stud	#2 Grd. Cable	#2 Grd. Cable
Weight Each	2 1/2 lb. / 1.1 kg.	3 3/4 lb. / 1.7 kg.	3 3/4 lb. / 1.7 kg.	2 1/2 lb. / 1.1 kg.	5 lb. / 2.3 kg.	2 5/8 lb. / 1.2 kg.	2 5/8 lb. / 1.2 kg.
ASTM Designation	Type I Class B Grade 3	Type III Class B Grade 5H	Type III Class B Grade 5	Type III Class B Grade 3	Type III Class B Grade 5H	Type III Class B Grade 5H	Type I Class B Grade 5H
IEC Rating (15 cycles)							
Jaws	Serrated	Serrated	Serrated	Serrated	Serrated	Serrated	Serrated
Ferrule	Plain Plug	Threaded	Plain Plug	Plain Plug	Threaded	Threaded	Threaded



All-Angle Grounding Clamps

Aluminum Bodies with Serrated Jaws

For installation ease, jaws pivot 75° left or right.

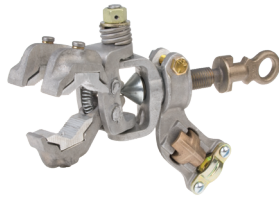

G422915J
*Pressure Terminal



†HG422965J
*Bronze Pressure Terminal
(Clamp same as G422915J)

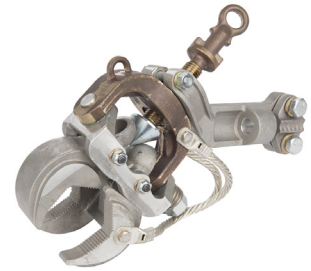

PSC6003499
Threaded Terminal

* For adapter to convert to threaded terminal, see Page 3023.

Catalog Number	G422915J	†HG422965J	PSC6003499
ELECTRICAL RATINGS			
Continuous Current (AMPS)	400	400	400
Fault Current - 15 Cycles (AMPS)	43,000	43,000	47,000 High X/R
Fault Current - 30 Cycles (AMPS)	30,000	30,000	
MECHANICAL RATINGS			
Recommended Torque (in.-lb.)	250	250	480
Main Line Range - Max.	954 kcmil ACSR (1.196")	954 kcmil ACSR (1.196")	2.88"
Main Line Range - Min.	#2 Cu. (.258")	#2 Cu. (.258")	0.258"
Jumper Range - Max.	4/0 Grd. Cable	4/0 Grd. Cable	4/0
Jumper Range - Min.	#2 Grd. Cable	#2 Grd. Cable	#2 Grd. Cable
Weight Each	2 lb. / 0.9 kg.	4¼ lb. / 1.9 kg.	8.0 lb. / 3.6 kg.
ASTM Designation	Type I Class B Grade 5	Type II Class B Grade 5	Type I Class B Grade 5H
Ferrule	Plain Plug	Plain Plug	Threaded

†Mounted Clamps supplied with 1¼" x 6' Epoxiglas® Pole.

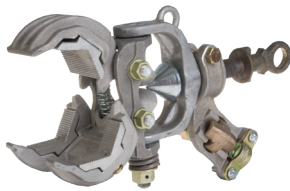

G422810SJ
*Bronze Pressure Terminal



†HG422816SJ
*Bronze Pressure Terminal
(Clamp same as G4228-10SJ)



T6001693
Tapped for 5/8-11 UNC threaded ferrule
(Two single serrated jaws,
for pothead and bus applications)



C6001732
Tapped for 5/8-11 UNC
threaded ferrule

* For adapter to convert to threaded terminal, see Page 3023.

Catalog Number	G422810SJ	†HG422816SJ	T6001693	C6001732
ELECTRICAL RATINGS				
Continuous Current (AMPS)	400	400	400	400
Fault Current - 15 Cycles (AMPS)	43,000	43,000	43,000	43,000
Fault Current - 30 Cycles (AMPS)	30,000	30,000	30,000	30,000
MECHANICAL RATINGS				
Recommended Torque (in.-lb.)	250	250	250	250
Main Line Range - Max.	2.88"	2.88"	2.88"	2.88"
Main Line Range - Min.	#2 Cu. (.258")	#2 Cu. (.258")	#2 Cu. (.258")	#2 Cu. (.258")
Jumper Range - Max.	4/0 Grd. Cable	4/0 Grd. Cable	4/0 Grd. Cable	4/0 Grd. Cable
Jumper Range - Min.	#2 Grd. Cable	#2 Grd. Cable	#2 Grd. Cable	#2 Grd. Cable
Weight Each	3¼ lb. / 1.5 kg.	5¼ lb. / 2.4 kg.	3¼ lb. / 1.5 kg.	3¼ lb. / 1.5 kg.
ASTM Designation	Type I Class B Grade 5	Type II Class B Grade 5	Type I Class B Grade 5	Type I Class B Grade 5
IEC Rating (15 cycles)				35 kA
Jaws	Serrated	Serrated	Serrated	Serrated
Ferrule	Plain Plug	Plain Plug	Threaded	Threaded

†Mounted Clamps supplied with 1¼" x 6' Epoxiglas® Pole.

5H BALL STUD / HEX STUD GROUNDING

Designed and Tested to meet requirements of ASTM F855 Table 2
Ultimate Assembly Rating for High X/R Ratio Applications

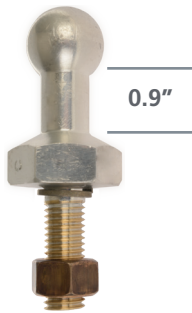

Short Ball Stud
 30 mm Ball, 3/4" dia. shaft
 5/8-11 UNC Threads
 Cat.No. PSC6003491

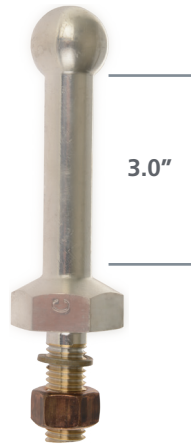

Long Ball Stud
 30 mm Ball, 3/4" dia. shaft
 5/8-11 UNC Threads
 Cat. No. PSC6003492

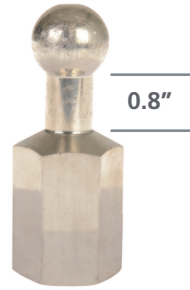

Short Ball Stud
 30 mm Ball, 3/4" dia. shaft
 5/8-11 UNC Female Threads
 Cat. No. PSC6003493

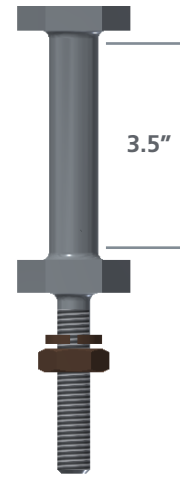

Hex Head Stud
 3/4" dia. x 3-1/2" Shaft
 1/2-13 UNC Threads
 Cat. No. PSC6003639



Ball Stud Ground Clamp
 accepts 30 mm Ball Studs
 Cat. No. PSC6003494



Short Ball Stud Cover
 Cat. No. PSC4060615
 Not an insulated cover



4 Hole NEMA Pad Adapter with permanent short Ball Stud
 Cat. No. PSC6003510

Three-Way Grounding Clamp for ball stud, conductors, busbars



- Compact design delivers high-current rating associated with large clamps
- For grounding trucks or other equipment, ball stud permanently mounts on each body with furnished lockwasher, flat washer and nut
- Removable stud has recessed-hex end fitting for through-mounting versatility
- Clamp body is aluminum
- Acme-threaded eyescrew and ball stud are bronze alloy
- Tin-plated ball stud has 20mm (0.8") diameter ball, 7/8"-hex fitting and 1-1/2"-long 1/2"-13 threads to fit NEMA terminal pads
- ASTM Designation of Type I, Class A, Grade 5 is met if associated grounding-cable sets are fitted with copper ferrules as on page 3021
- IEC rating at 15 cycles of 35 kA

Clamp Main Line Range

- Bare Conductors from #8 Sol. Cu. through 636 ACSR
- Ball Stud 20mm (0.788") only

Fault current ratings: 43,000 amps — 15 cycles
30,000 amps — 30 cycles

Recommended Installing Torques:

Eyescrew 250 inch-pounds **Ball Stud** 300 inch-pounds

Catalog No.	Description	Weight, each
C6002316	Three-Way Clamp Body only	1½ lb./0.7 kg.
C6002317	*20mm (0.788") diameter Ball Stud with flat washer, lockwasher and nut	¾ lb. / 0.2 kg.

*Ball stud does not interchange with system on page 3014.

Penetrator clamps and sets for underground cable

Features & Applications

- To be used to confirm URD cable is de energized prior to cutting. After Circuit has been grounded at the Pad Mounted Switch, the ground set with the penetrator clamp may be used as a last check to confirm the cable that will be worked on is de energized.
- Cable with jacket over concentric neutral, special clamps help ensure contact with center conductor
- Chisel-point clamp main-line capacity is 1-1/2"
- Spike-point clamp main-line capacity is 2-1/2"
- Screw-type copper-clad ground rod in sets indicated is 24" long for easy handling
- Helix (spiral) and handle are bronze
- Each set includes:
 - o 6-ft. of #2 copper clear-jacket ground cable and ferrules
 - o A penetrator clamp (choice of hardened-steel 1/2"-wide chisel or conical spike)
 - o C-type grounding clamp

Catalog No.	Description	Weight, each
C6001626	Chisel Clamp only	1¾ lb. / 0.8 kg.
P6001623P	Replacement Chisel Point	2 oz. / 0.1 kg.
T6002234	Chisel Set with Ground Rod	9¾ lb. / 4.4 kg.
C6001625	Chisel Set without Ground Rod	4½ lb. / 2 kg.
T6001922	Spiked Clamp only	1¾ lb. / 0.8 kg.
P6001969P	Replacement Spike Point	2 oz. / 0.1 kg.
T6002233	Spiked Set with Ground Rod	8 lb. / 3.6 kg.

Features & Applications

- By supporting other clamps in three-phase sets, ball studs reduce installation labor
- This can contribute to safety and minimize the number of clamp connections per conductor in an overhead grounding scheme
- Ball studs mount without furnished washers in holes of lower clamp boss
- The tapped holes ship with plastic plugs
- Clamp terminal is tapped for 5/8"-11 UNC threaded-stud ferrules on grounding cable from #2 through 4/0
- Versatile clamp serves such temporary-grounding uses as:
 - o A truck-grounding system
 - o On industrial metalclad switchgear
 - o Substation buswork, indoors and out
 - o Overhead, underground and substation switches
 - o Three-phase ground sets with special, multi-angle

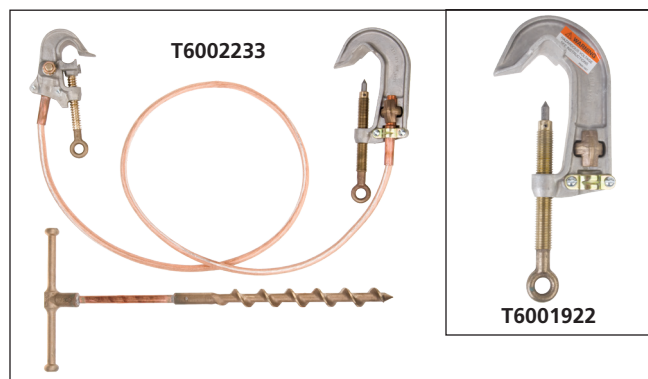

Underground Distribution Grounding Sets

Grounded Parking Bushing Sets for Single-Phase Switches & Transformers

- Set includes a loadbreak bushing and bronze ground clamp T6000466 connected by a 4' yellow 1/0 cable
- Tin-plated copper connector joins cable to bushing
- Threaded copper ferrule connects the cable to the clamp
- Fault current rating for each set: 10,000 amps for 10 cycles per IEEE 386

Catalog No.	*Application	Weight, each
T6003091	15kV	8 lb. / 3.6 kg.
T6003092	25 & 35kV small interface	9 lb. / 4.1 kg.

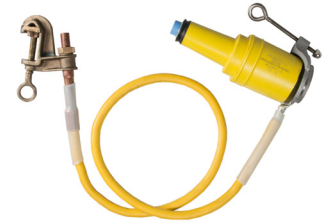

Grounding Elbow Sets for Single- or Three-Phase Switches & Transformers

- Set includes:
 - Yellow-jacketed elbow for the voltage-class indicated below
 - Six feet of 1/0 copper grounding cable with yellow jacket
 - Bronze ground clamp T6000466
- Fault current rating for each set: 10,000 amps for 10 cycles per IEEE 386

C6000729	15kV set	4 lb. / 1.8 kg.
T6002131	25kV set	6 lb. / 2.7 kg.
PSC6003709	35kV Small interface set	6 lb. / 2.7 kg.
C6001927	35kV large interface set	8 lb. / 3.6 kg.



Three-Phase Grounding Elbow Sets for Switches & Transformers

- Each of these sets consists of:
 - A three-way terminal block assembly
 - Three 6' lengths of 1/0 copper ground cable with yellow jacket
 - A bronze ground clamp T6000466
 - Three yellow elbows
- Fault current rating for each set: 10,000 amps for 10 cycles per IEEE 386

C6003102	15kV set	14.5 lb. / 6.6 kg.
C6003103	25kV set	15 lb. / 6.8 kg.
PSC6003710	35kV small interface set	15 lb. / 6.8 kg.
PSC6003103003	35kV large interface set	16 lb. / 7.3 kg.

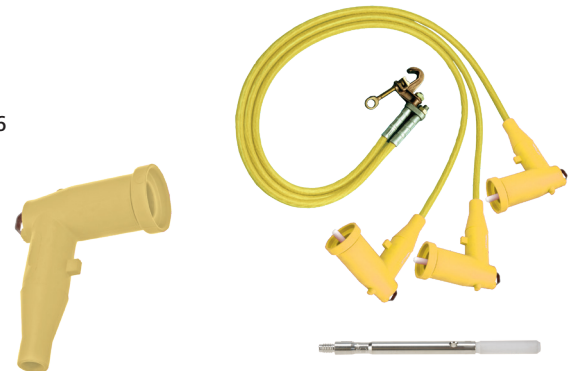

Replacement Parts: Grounding Elbow ONLY

215GEHSG	15kV - elbow only	1.9 lb./0.9 kg.
225GEHSG	25 & 35kV small interface - elbow only	2.0 lb./0.9 kg.
236GEHSG	35kV large interface - elbow only	4.0 lb./1.8 kg.

All Copper Connector ONLY

200LUGC6	for 1/0 Grounding Cable	1.8 oz. / 51 g.
200LUGC7	for 2/0 Grounding Cable	1.8 oz. / 51 g.

Elbow Probes ONLY

215LBP	15kV Probe	5.3 oz. / 150 g.
225LBP	25kV Probe	7.0 oz. / 198 g.
235LBP	35kV Small Interface Probe	1.1 lb. / 0.5 kg.
236LBP	35kV Large Interface Probe	1.1 lb. / 0.5 kg.

Temporary Grounding Sets for Live-Front Switches and Transformers

C6000758	C-Clamp Set	15 lb. / 6.8 kg.
----------	-------------	------------------

Fault current ratings: 21,000 amps for 15 cycles or 15,000 amps for 30 cycles
C-clamps are Cat. No. T6000466.

- Each C-Clamp set includes:
 - A three-way aluminum terminal block
 - Four bronze ground clamps
 - Three 6' lengths of 1/0 copper clear-jacket ground cable with threaded-stud ferrules

T6002246	Ball Socket Set	16.5 lb. / 7.5 kg.
----------	-----------------	--------------------

Fault current ratings: 27,000 amps for 15 cycles or 20,000 amps for 30 cycles

- Each Ball Stud set includes:
 - A three-way copper terminal block
 - Four bronze ground clamps
 - Three 6' lengths of 2/0 copper clear-jacket ground cable with threaded-stud ferrules

T6002375	Flat-Face Clamp Set	15.5 lb. / 7 kg.
----------	---------------------	------------------

Fault current ratings: 21,000 amps for 15 cycles
or 15,000 amps for 30 cycles

Each set Includes:

- A four-way bronze terminal block
- One 6' and three 4' lengths of 1/0 copper clear-jacket ground cable with shrouded plain-plug copper ferrules
- Three aluminum ground clamps with bronze eyescrews (G33633SJ)
- One with bronze T-handle (G33634SJ)

*For storage bag T6000865, see page 3023.



C6000758
ASTM Type I,
Class A, Grade 2



T6002246
ASTM Type I,
Class A, Grade 3



T6002375
ASTM Type III,
Class B, Grade 2

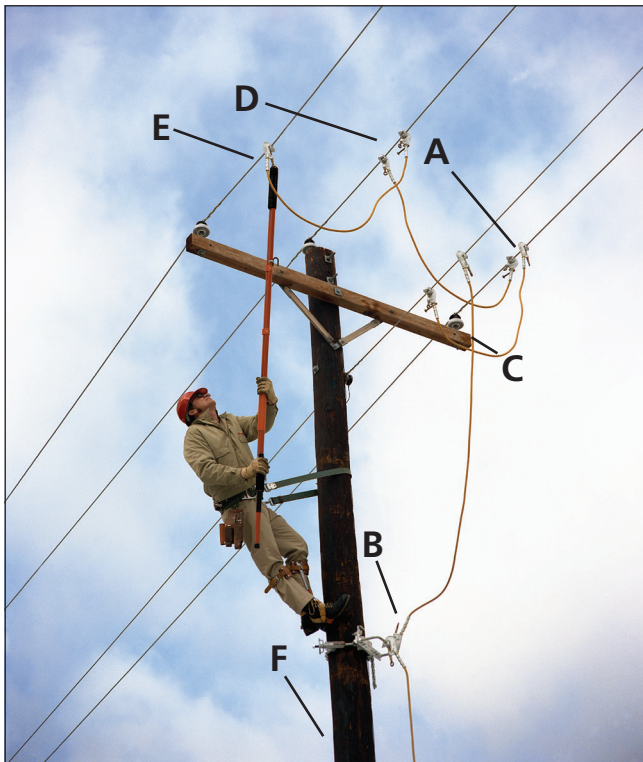

CHANCE grounding clamps, ferrules and cable meet ASTM F 855.
(Standard cable jacket is clear. Yellow-jacket cable, shown, is available upon request.)



C6002276

Main Line Range

Maximum	1033 kcmil ACSR (1.25")
Minimum	#8 Solid Copper (0.128")



G3626



G3370



T6001549

Overhead Distribution Grounding Sets with Pressure-Type Terminals

Features & Applications

- These complete sets of ground clamps, cable and accessories
- All equipment needed for many types of distribution structures in easy-to-use kits Ferrules are factory crimped to the grounding cable
- Each kit comes with C6002276 clamps
- Can be used on conductors ranging from #8 to 1033 kcmil ACSR

These kits were designed for use on the following types of structures:

7.2/12.5 kV A1 through C24
14.4/24.9 kV VA1 through VC9-3
46 kV TP1 through TP5
69 kV TS1 through TS3-2

The tables below list the components **completely assembled** in each of the Distribution Grounding Sets.

#2 Grounding Cable Set* (44 lb./20 kg.) Catalog No. T6000641 consists of:

Item	Description	Quantity	Information
A	Serrated jaw, "C" Clamp Cat. No. C6002276	10	For Plain Plug ferrules
B	Ground Cluster Support	1	Cat. No. T6001549
C	#2 Clear-Jacket Copper Ground Cable - Cat. No. S6449 (Other cable jackets available)	60 ft.	3 Cables 6 ft. long 1 Cable 12 ft. long 1 Cable 30 ft. long
D	#2 Plain Plug Ferrules	10	Cat. No. C6002626
E	Clamp Support Stud	3	Cat. No. G3626
F	Screw Ground Rod	1	Cat. No. G3370

1/0 Grounding Cable Set* (58 lb./26 kg.) Catalog No. T6003094 consists of:

Item	Description	Quantity	Information
A	Serrated jaw, "C" Clamp Cat. No. C6002276	10	For Plain Plug ferrules
B	Ground Cluster Support	1	Cat. No. T6001549
C	1/0 Clear-Jacket Copper Ground Cable - Cat. No. S7568 (Other cable jackets available)	60 ft.	3 Cables 6 ft. long 1 Cable 12 ft. long 1 Cable 30 ft. long
D	1/0 Plain Plug Ferrules	10	Cat. No. C6002627
E	Clamp Support Stud	3	Cat. No. G3626
F	Screw Ground Rod	1	Cat. No. G3370

2/0 Grounding Cable Set* (60 lb./27 kg.) Catalog No. T6003095 consists of:

Item	Description	Quantity	Information
A	Serrated jaw, "C" Clamp Cat. No. C6002276	10	For Plain Plug ferrules
B	Ground Cluster Support	1	Cat. No. T6001549
C	2/0 Clear-Jacket Copper Ground Cable - Cat. No. S6450 (Other cable jackets available)	60 ft.	3 Cables 6 ft. long 1 Cable 12 ft. long 1 Cable 30 ft. long
D	2/0 Plain Plug Ferrules	10	Cat. No. C6002628
E	Clamp Support Stud	3	Cat. No. G3626
F	Screw Ground Rod	1	Cat. No. G3370

4/0 Grounding Cable Set* (77 lb./35 kg.) Catalog No. T6003096 consists of:

Item	Description	Quantity	Information
A	Serrated jaw, "C" Clamp Cat. No. C6002276	10	For Plain Plug ferrules
B	Ground Cluster Support	1	Cat. No. T6001549
C	4/0 Clear-Jacket Copper Ground Cable - Cat. No. S6451 (Other cable jackets available)	60 ft.	3 Cables 6 ft. long 1 Cable 12 ft. long 1 Cable 30 ft. long
D	4/0 Plain Plug Ferrules	10	Cat. No. C6002629
E	Clamp Support Stud	3	Cat. No. G3626
F	Screw Ground Rod	1	Cat. No. G3370

*For storage bag T6000865, see page 3023.



Cutout Grounding Clamps

Features & Applications

- Bronze clamp used to ground bottom hinge contact on cutouts used on distribution riser poles or where grounding is required
- Fits these cutouts:
 - CHANCE F2, F3, and C Cutouts
 - Westinghouse LDX, Southern States B-80
 - Southern States Series 63
 - Joslyn; S&C Type SX
 - McGraw-Edison LMO, and GE Durabute
- Clamp can be installed with or without grounding cable
- Serves as a warning and helps avoid accidental closing of cutout
- Clamp's drilled terminal accepts threaded-stud cable ferrules
- Also accepts threaded L-Stud and T-Stud Terminals (3/4" diameter bronze) for use with conventional ground-clamp cable sets
- Fault Current rating: 20,000 amps for 30 cycles

Catalog No.	Description	Weight, each
C6000785	Cutout Clamp	2.2 lb. / 1 kg.
T6002408	T-Stud Terminal	1.4 lb. / 0.6 kg.
C6000841	L-Stud Terminal	1 lb. / 0.5 kg.
T6002567	Cutout Clamp with T-Stud Terminal	3.4 lb. / 1.5 kg.
C6000862	Cutout Clamp with L-Stud Terminal	3.8 lb. / 1.7 kg.

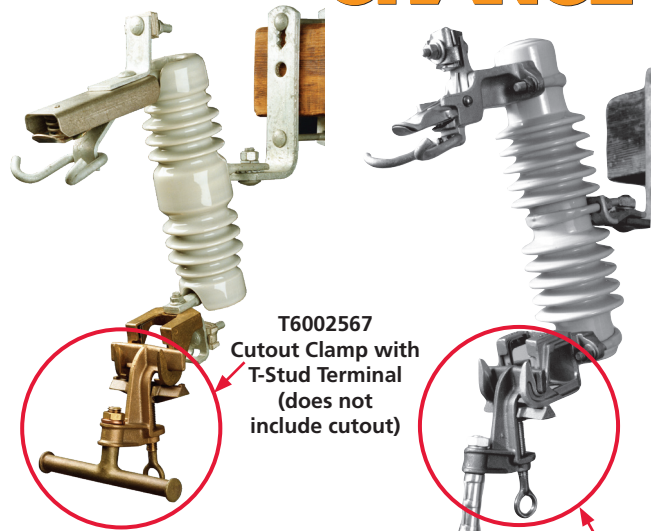

T6002567
Cutout Clamp with T-Stud Terminal (does not include cutout)

C6000785
(does not include cutout)



T6002408
T-Stud Terminal

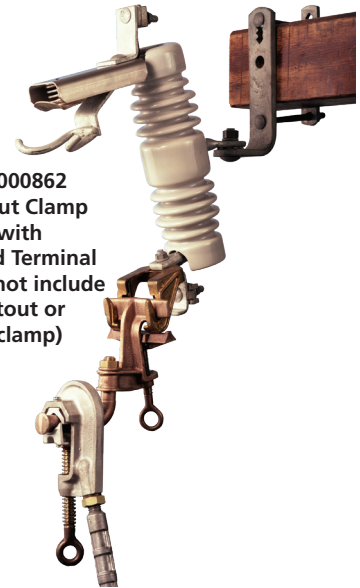

C6000862
Cutout Clamp with L-Stud Terminal (does not include cutout or C-clamp)



C6000841
L-Stud Terminal

Switch Blade Grounding Clamps

Features & Applications

- Attaches temporary ground to open switch during de-energized maintenance
- Helps keep ground lead away from energized switch jaw
- Shaped to fit blades of CHANCE Type M3 Disconnect switches
- Drilled terminal accepts threaded-stud ferrules on grounding cable from #2 through 4/0
- Also accepts threaded L-Stud Terminal (3/4" diameter bronze) for use with conventional ground-clamp cable sets

ASTM Designation: Type I, Class A, Grade 5
Fault Current ratings: 30,000 amps for 30 cycles
 43,000 amps for 15 cycles
with L-Stud Terminal: 20,000 amps for 30 cycles
Recommended torque: 250 inch pounds
Main Line Range: 3/4" x 1/8" flat through 2 1/2" x 1/4" flat

Catalog No.	Description	Weight, each
C6002145	Plain eyescrew Switch Clamp	3 1/2 lb. / 1.6 kg.
C6002146	T-handle/eyescrew Clamp	3 1/2 lb. / 1.6 kg.
C6000841	L-Stud Terminal only	1 lb. / 0.5 kg.

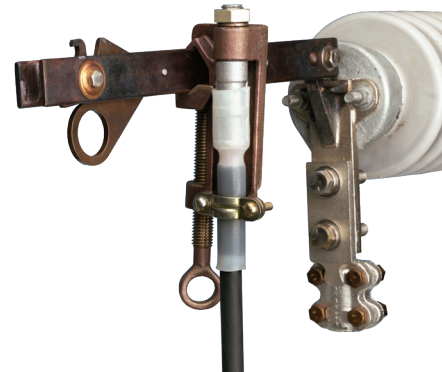

C6002145
Plain Eyescrew

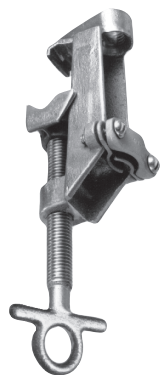

C6002146
T-handle/eyescrew

CHANCE® Substation Grounding Sets

with Pressure-Type Terminals

Features & Applications

- For grounding substation bus when de-energized for maintenance
- Makes workmen's job safer and easier
- Large capacity bus clamps are available in mounted versions
- Reaches any manageable height
- Increases worker's lifting capabilities
- Plastisol coated, Shepherd Hook Lift Stick, with block and rope assembly
- Reduces capacity clamps on overhead bus
- Two sizes of mounted clamps are available:
 - C6000618 has 6-5/8" bus capacity, utilizing a C6000337 ground clamp mounted on 1-1/4" x 9 ft. Epoxiglas® Pole
 - C6000619 has 4" bus capacity, utilizing a G3369 ground clamp mounted on 1-1/4" x 8'10" Epoxiglas® Pole
- Cables, ferrules and small grounding clamps should be ordered separately

Accessories

- C6000617 — Lift Hook Assembly, 1 1/4" x 8'8" Epoxiglas® pole, includes block and rope assembly.
 C6000620 — 1 1/4" x 12' Extension Pole (middle section).
 C6000621 — 1 1/4" x 8' Bottom Pole.

Catalog Number	C6000618	C6000619
----------------	----------	----------

ELECTRICAL RATINGS

	C6000618	C6000619
Continuous Current (AMPS)	400	400
Fault Current - 15 Cycles (AMPS)	43,000	43,000
Fault Current - 30 Cycles (AMPS)	30,000	30,000

MECHANICAL RATINGS

	C6000618	C6000619
Recommended Torque (in.-lb.)	250	250
Main Line Range - Max.	6 5/8" Angles	4 1/2" Angles
Main Line Range - Min.	4 1/2" Round Bus	1/0 Str. Copper (0.368")
Jumper Range - Max.	4/0 Grd. Cable w/Plain Plug	4/0 Grd. Cable w/Plain Plug
Jumper Range - Min.	#2 Grd. Cable w/Plain Plug	#2 Grd. Cable w/Plain Plug
Weight Each	10 lb./4.5 kg.	9 1/4 lb./4.2 kg.
ASTM Designation	Type II Class A Grade 5	Type II Class A Grade 5

Electro-Static Precipitator Grounding Tool Set

Simple Safety Procedures

- Drains off static charges that remain on collector plates after electrostatic-precipitator pollution-control equipment is de-energized
- When electrical system of precipitator is de-energized:
 - First, secure the tool's grounding clamp to a known ground
 - Next, use insulated handle to bring the Copper hook in contact with the precipitator collector plates
 - Contact hook hangs from collector plates (with the grounding clamp still attached to ground) while service is performed on precipitator
 - When maintenance is completed, use insulated handle to remove contact hook from collector plates
 - Finally, remove the ground clamp before re-energizing the precipitator

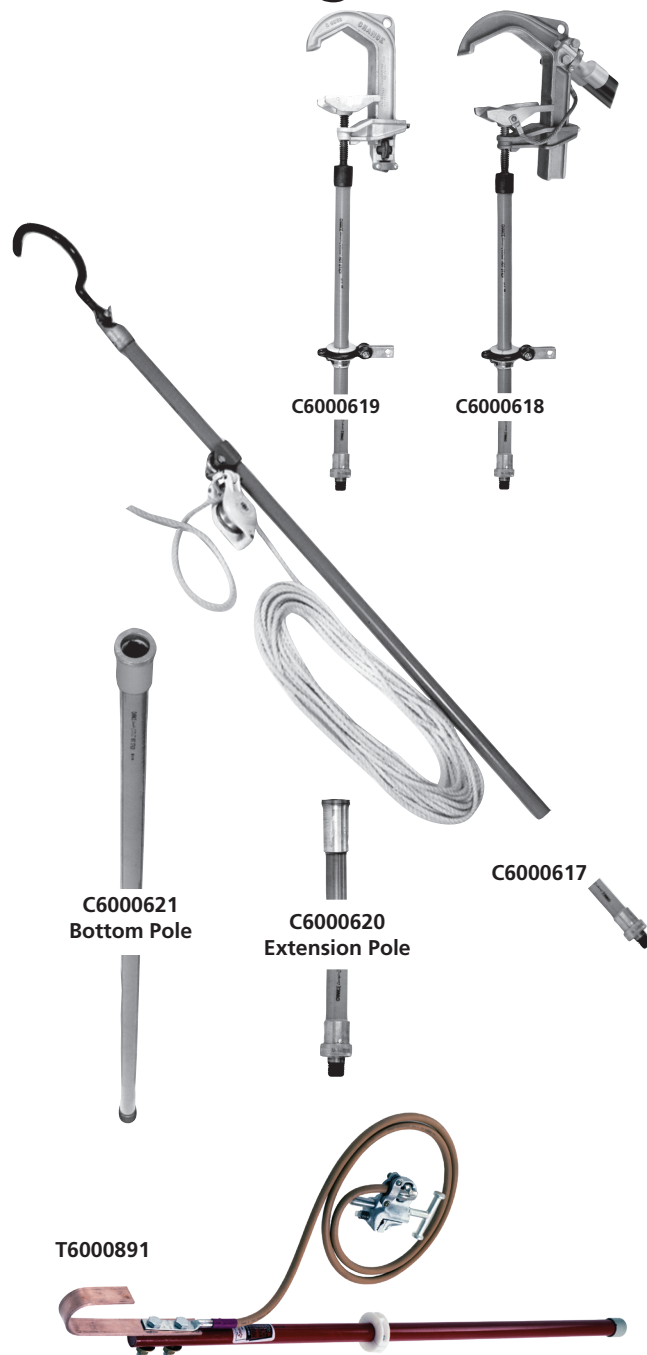

- Epoxiglas® handle (42" x 1-1/4") meets OSHA electrical requirements
- Gives operator sufficient added reach needed to make contacts
- Contact hook of 98%-conductive Copper is double-bolted to handle
- T-handle aluminum grounding clamp with serrated flat-face jaw ensures proper bonding
- Jaws open to 1-1/2" for attachment to grounded structural angles, flats or rods
- Extra-flexible (1638 strands) Copper grounding cable, 7 ft., with clear jacket fitted with copper terminal at each end gives high current-carrying capability

Catalog No.	Description	Weight, each
T6000891	Electrostatic Grounding Set	7 lb. / 3.2 kg.



CHANCE grounding ferrules and cable meet requirements of ASTM F 855; see table, page 3002.



Grounding Ferrules

Selection Criteria

- Shrouded ferrules overlap onto the grounding cable jacket for stress relief to the terminal. Two crimps secure the ferrule against the bare strands and one crimp applies on the jacket
- Unshrouded ferrules are available with shrink tubing that overlaps the bare cable conductor and jacket for stress relief
- Available either factory-installed in pairs on any cable length specified or as separate individual units, the ferrules install simply with a hydraulic crimping tool.

See ordering tables for crimping-die sizes applicable.

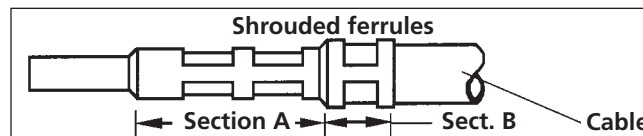
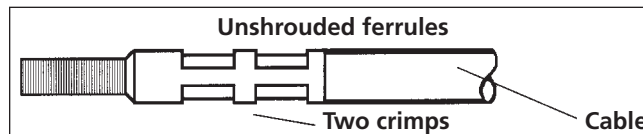

Copper ferrules

Plain-plug type for pressure-type grounding-clamp terminals

Shrouded plain copper ferrules

1 unit each, not installed Catalog No.	Burndy Die No.† or equivalent		Cable Size, AWG
	Sect. A	Sect. B	
C6002630	U165	U166	#2
C6002631	U165	U168	"1/0"
C6002632	U165	U-L	"2/0"
C6002633	U166	U-L	"4/0"

Unshrouded plain copper ferrules

1 unit each, not installed Catalog No.	Burndy Die No.† or equivalent	Cable Size, AWG
C6002614	U165	#2
C6002615	U165	"1/0"
C6002616	U165	"2/0"
C6002617	U166	"4/0"

Threaded-stud type for tapped or drilled grounding-clamp terminals

Shrouded threaded copper ferrules

Catalog No.	Burndy Die No.†	Burndy Die No.†	Cable Size, AWG
C6002622	U165	U166	#2
C6002623	U165	U168	"1/0"
C6002624	U165	U-L	"2/0"
C6002625	U166	U-L	"4/0"

Unshrouded threaded copper ferrules

Catalog No.	Burndy Die No.†	Cable Size, AWG
C6002606	U165	#2
C6002607	U165	"1/0"
C6002608	U165	"2/0"
C6002609	U166	"4/0"

Tin-Plated Copper ferrules

Plain-plug type for pressure-type grounding-clamp terminals

Shrouded plain tin-plated copper ferrules

Catalog No.	Burndy Die No.†	Burndy Die No.†	Cable Size, AWG
C6003119	U165	U166	#2
C6003120	U165	U168	"1/0"
C6003121	U165	U-L	"2/0"
C6003122	U166	U-L	"4/0"

Unshrouded plain tin-plated copper ferrules

Catalog No.	Burndy Die No.†	Cable Size, AWG
C6003111	U165	#2
C6003112	U165	"1/0"
C6003113	U165	"2/0"
C6003114	U166	"4/0"

Threaded-stud type for tapped or drilled grounding-clamp terminals

Shrouded threaded tin-plated copper ferrules

Catalog No.	Burndy Die No.†	Burndy Die No.†	Cable Size, AWG
C6003115	U165	U166	#2
C6003116	U165	U168	"1/0"
C6003117	U165	U-L	"2/0"
C6003118	U166	U-L	"4/0"

Unshrouded threaded tin-plated copper ferrules

Catalog No.	Burndy Die No.†	Cable Size, AWG
C6003107	U165	#2
C6003108	U165	"1/0"
C6003109	U165	"2/0"
C6003110	U166	"4/0"

*Anderson die-less VERSA-CRIMP™ compression tools require no dies and are capable of making these crimped connections. If using another crimp tool brand, contact that manufacturer for Burndy die equivalents.

Copper Grounding Cable



- Extra-flexible for handling ease yet strong and tough for long wear
- Jacketing is smooth, abrasion, weather and oil resistant
- In accordance with applicable ASTM Specifications, marked with AWG size approximately every 4 feet
- Yellow and black jackets are T-prene rubber compound with -20°F recommended low temperature
- Clear jackets (which allow visual inspection of strand conditions) are ultraviolet-inhibited Poly Vinyl Chloride (PVC)
- Recommended low temperature for PVC-jacketed cable is 0°F
- Extra-flexible cables, because of their extra-fine strands
- Require termination ferrules when used with ground clamps

Either aluminum or copper ferrules may be used with copper cable.

Catalog Number	Size AWG	Strands*	Diameter (Inches)	Approx. O.D. (Inches)	Approx. Wt. (lb./1,000 ft.)
----------------	----------	----------	-------------------	-----------------------	-----------------------------

Yellow-Jacket Copper Cable

S6116	#2	665	0.32	0.55	280
S6117	"1/0"	1045	0.41	0.66	425
S6118	"2/0"	1330	0.47	0.73	520
S6119	"4/0"	2109	0.59	0.87	760

Clear-Jacket Copper Cable

S6449	#2	665	0.344	0.53	289
S7568	"1/0"	1050	0.445	0.63	520
S6450	"2/0"	1323	0.487	0.70	546
S6451	"4/0"	2107	0.616	0.84	841

Black-Jacket Copper Cable

S3713	#2	665	0.32	0.55	280
S3715	"1/0"	1045	0.41	0.66	425
S3712	"2/0"	1330	0.47	0.73	510
S3714	"4/0"	2109	0.59	0.87	760

*Varies with manufacturer.



Aluminum ferrules

Plain-plug type for pressure-type grounding-clamp terminals

Shrouded plain aluminum ferrules

1 unit each, not installed Catalog No.	Burndy Die No. [†] or equivalent		Cable Size, AWG
	Sect. A	Sect. B	
C6002626	U165	U166	#2
C6002627	U165	U168	1/0
C6002628	U165	U-L	2/0
C6002629	U249	U-L	4/0



- Visual inspection of cable condition through clear heat-shrink tube determines breakage or corrosion that otherwise requires continuity test
- Factory-assembled units expose 1/2" of cable strands at junction point



Unshrouded plain aluminum ferrules

1 unit each, not installed Catalog No.	Burndy Die No. [†] or equivalent	Cable Size, AWG
C6002610	U165	#2
C6002611	U165	1/0
C6002612	U165	2/0
C6002613	U249	4/0

Shrink tubing for plain ferrules Features & Applications

- Clear heat-shrink tubes limit corrosion
- Excludes moisture
- Stress-relief for cable jacket and ferrule-to-stranding connection

Part No.	Lengths
P6001593P	5"
P6001982P	7"
P6002069P	9"

[†]Anderson die-less VERSA-CRIMP® compression tools require no dies and are capable of making these crimped connections. If using another crimp tool brand, contact that manufacturer for Burndy die equivalents.

Threaded-stud type for tapped or drilled grounding-clamp terminals

Shrouded threaded aluminum ferrules

1 unit each, not installed Catalog No.	Burndy Die No. [†] or equivalent		Cable Size, AWG
	Sect. A	Sect. B	
C6002618	U165	U166	#2
C6002619	U165	U168	1/0
C6002620	U165	U-L	2/0
C6002621	U249	U-L	4/0



Shrink tubing for threaded ferrules Features & Applications

- Clear heat-shrink tubes limit corrosion
- Excludes moisture
- Stress-relief for cable jacket and ferrule-to-stranding connection

Part No.	Lengths
P6001593P	5"
P6001982P	7"
P6002069P	9"

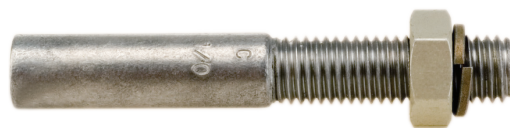

Unshrouded threaded aluminum ferrules

1 unit each, not installed Catalog No.	Burndy Die No. [†] or equivalent	Cable Size, AWG
C6002602	U165	#2
C6002603	U165	1/0
C6002604	U165	2/0
C6002605	U249	4/0

[†]Anderson die-less VERSA-CRIMP® compression tools require no dies and are capable of making these crimped connections. If using another crimp tool brand, contact that manufacturer for Burndy die equivalents.



Conversion Terminals

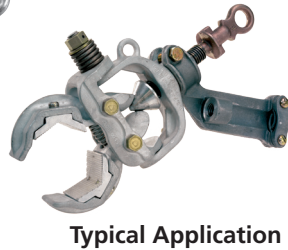
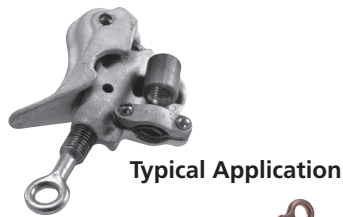

Features & Applications

- Threaded-terminal adapters for pressure-type grounding-clamp terminals
- Simply retrofit bolt-on adapters to convert clamps with pressure-type terminals to accept 5/8-11 UNC threaded ferrules

Catalog Number	Clamp Applications
C6001584 "eyebolt" style, includes shakeproof washer and nut	C Type, Snap-On, Flat-Face
C6001700 includes steel retainer straps for cable	All-Angle Clamps

Storage Bag for Temporary Grounding Clamps-and-Cable Sets



Features & Applications

- Easy-to-see, bright-yellow protective bag
- Made of double vinyl-laminated open-weave nylon cloth
- Lightweight and durable with nylon stitching throughout
- Full-separating closure constructed with heavy-duty snaps
- Heavy webbing handles
- 18" L x 12" W x 15" D

Catalog No.	Description	Weight
T6000865	Grounding Storage Bag	3 lb. / 1.4 kg.

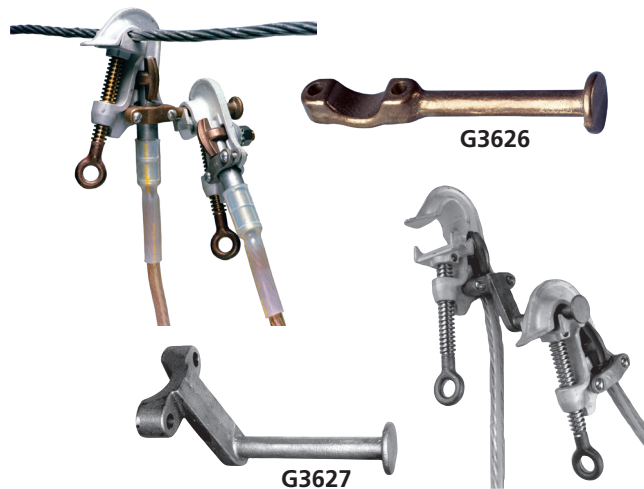

Support Studs

Features & Applications

- Can be installed on most Ground Clamps
- Replaces restraining strap immediately below terminal
- Serves as a mechanical parking stand for a second clamp
- Helps prevent "parked" clamp from making contact with conductor or ground
- Particularly beneficial in three-phase grounding applications
- Not tested and rated for fault current

Catalog No.	Description	Size of Stud	Weight
G3626	Stud for Rear Mount	7/16" x 2 1/2"	1/2 lb. / .2 kg.
G3627	Stud for Side Mount	7/16" x 3"	3/4 lb. / .3 kg.



Dielectric Compound No. 7

Dielectric Compound No. 7, a silicone base material, is made for use with load break disconnects and other electrical connecting and terminating devices.

Cat. No. C4170287..... 2 oz. Tube

Cable Splice

for cables with plain-plug ferrules

Features & Applications

- Use for splicing grounding cable when extensions are required
- Thumb screw makes attachment easy

Splice fits #2 through 4/0 grounding cable with plain ferrules

Catalog No.	Description	Weight
T6000252	Grounding Cable Splice	1½ lb. / 0.7 kg.

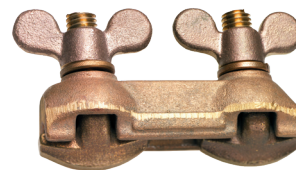

T6000252

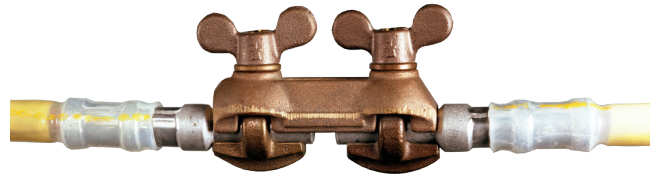

Terminal Blocks, 4-Way

for cables with plain-plug ferrules and threaded ferrules

Features & Applications

- Attach ground leads from grounding clamps to a common ground
- Accommodates 4/0 grounding cables

Catalog No.	Description	Weight
G47541	4-Way Terminal Blocks for Plain Plug Ferrules	2 lb. / 0.9 kg.
T6001964	4-Way Terminal Blocks for Threaded Ferrules ASTM Grade 5H	1 lb. / 0.5 kg.



G47541
for four
plain plug ferrules



T6001964
for four 3/8-11 UNC
threaded ferrules

Cluster Bars

Catalog No.	Description	Weight	ASTM Grade
C6000152	Cluster Bar, 11", w/ Pressure Terminal, 36" Chain	11.2 lb. / 5.1 kg.	5
C6000152A	Penetrating Cluster Bar, 11", w/ Pressure Terminal, 36" Chain, Pole-Penetrating Screw	11.5 lb. / 5.2 kg.	
C6000152AR	Penetrating Cluster Bar, 11", w/ Pressure Terminal, Retrofit Kit	0.3 lb. / 0.1 kg.	
PSC6003628	5H Rated Cluster Bar, 5/8" dia. x 11", 36" Chain	10.7 lb. / 4.9 kg.	5H
PSC6003628A	5H Rated Penetrating Cluster Bar, 5/8" dia. x 11", 36" Chain, Pole-Penetrating Screw	11 lb. / 5 kg.	
PST6003466	6H Rated Cluster Bar, 1" dia. x 11", 36" Chain	13.9 lb. / 6.3 kg.	6H
PST6003466A	6H Rated Penetrating Cluster Bar, 1" dia. x 11", 36" Chain, Pole-Penetrating Screw	14.2 lb. / 6.4 kg.	
T6001549	Cluster Bar w/ 5/8" dia. x 6" Bar, 36" Chain	7.2 lb. / 3.3 kg.	5
T6001549A	Penetrating Cluster Bar, 5/8" dia x 6" Bar, 36" Chain	8 lb. / 3.6 kg.	
T6001549AR	Penetrating Cluster Bar, 5/8" dia. x 6", Retrofit Kit	0.8 lb. / 0.4 kg.	
T6001737	Tower-Mount Cluster Bar	9 lb. / 4.1 kg.	

Note: Custom chain lengths available upon request



PSC6003628



Penetrating Retro Kit (C6000152AR) is circled and is included with PSC6003628A



T6001549



Penetrating Retro Kit (T6001549AR) is circled and is included with T6001549A



T6001737



Storage Reel for Grounding Cable



Cable Size	Reel Capacity
#2	225 ft.
1/0	185 ft.
2/0	145 ft.
4/0	100 ft.

Features & Applications

- Hole in outer flange for cable to feed through
- Rewind handle has galvanized-pipe extension for temporarily parking clamps
- Portable reel quickly pays-out/takes-up,
- Helps keep ground sets clean and neat, ready for use
- Handles are comfortable, turned aluminum
- Lightweight unit can be carried to remote sites
- Tubular-steel frame can be U-bolted to deck of truck
- Galvanized drum has ribbed flanges to resist flexing and beaded rims to eliminate sharp edges
- Reel is for storage only
- Cable and clamps should be removed completely from reel before use
- Failure to do so could result in a dangerous voltage drop and violent mechanical reactions
- A label on the unit gives this warning

Catalog No.	Description	Weight
C4176086	Portable Cable Reel	18 lb. / 8 kg.

Temporary Ground Rod

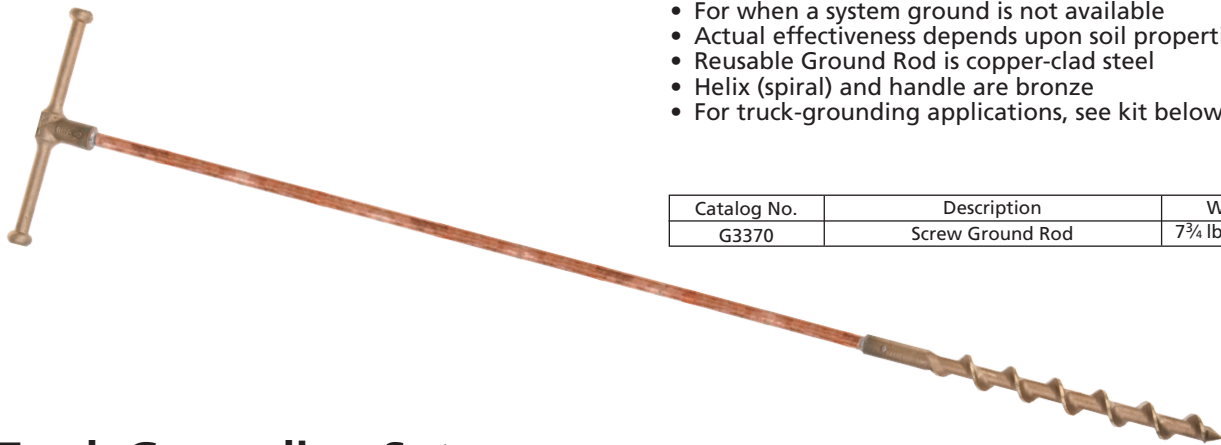

Features & Applications

- Screw Ground Rod provides a temporary ground
- For when a system ground is not available
- Actual effectiveness depends upon soil properties
- Reusable Ground Rod is copper-clad steel
- Helix (spiral) and handle are bronze
- For truck-grounding applications, see kit below

Catalog No.	Description	Weight
G3370	Screw Ground Rod	7¾ lb. / 3.5 kg.

Truck Grounding Set

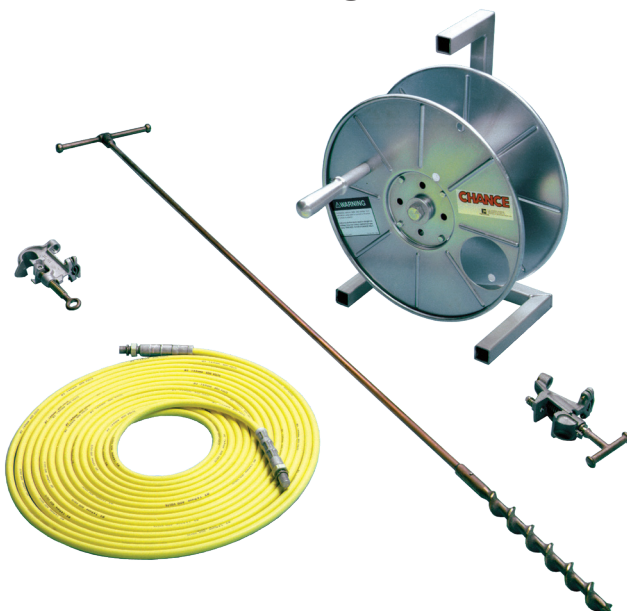

Features & Applications

- Provides means to drain off capacitance or static charges
- For winch trucks and aerial devices
- Flat-face clamp is for secure attachment to the truck bed at an area cleaned for electrical contact
- C-type clamp is for secure attachment to ground rod
- This grounding method should not be considered adequate protection to personnel against conductor contact
- For truck-grounding with ball/socket-clamp, see page 3103

Truck Grounding Set
Catalog No. T6001971
(total weight 35 lb./16 kg.)
consists of:

Component	Qty.	Description
Screw Ground Rod	1	Cat. No. G3370, see above
Flat Face Ground Clamp	1	Cat. No. T6001798, see page 3011
C-Type Ground Clamp	1	Cat. No. C6001754, see page 3005
#2 Copper Grounding Cable	50 ft.	Cat. No. S6116, see page 3021
*Shrouded Alum. Ferrules	2	Cat. No. C6002618, see page 3022
Storage Reel	1	Cat. No. C4176086, see above

*Threaded ferrules are factory-installed on ends of cable.

Truck Safety Barricade

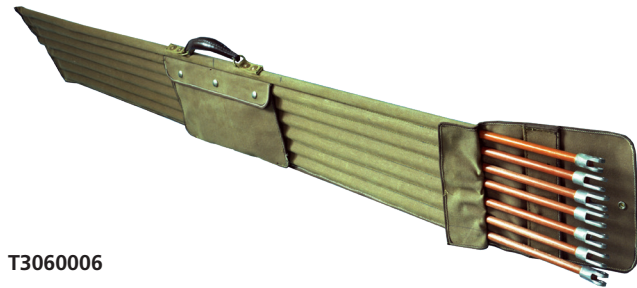

T3060006

Catalog No.	Description	Weight
T3060006	Truck Safety Barricade	21 lb. / 9.5 kg.

Features & Applications

- Keeps workers and onlookers away from truck when it is being used in proximity to energized conductors
- Six rods, made of bright orange Epoxirod®, provide a 6-foot air space around the entire perimeter of the truck
- Safety barricade also includes six pieces of 3-inch long steel tubing (to be welded to truck by the customer)
- Tubing holds barricade rods, 150 feet of yellow rope and a canvas storage bag
- Entire kit requires less storage than traffic cones and can be quickly installed and removed at each job site

Grounding Simulator Kit

Features & Applications

- Demonstrates principles for temporary grounding practices
- Portable instructional aid provides working model of three-phase system circuit
- Powered by a step-down transformer
- Plugs into a 110-volt 60-cycle household source
- Special light/buzzer unit simulates lineworker in maintenance on de-energized line
- Insulated wires with alligator clip at each end serve as grounding cable and clamp sets (10 included)
- Miniature grounding cluster bar is included for pole mounting

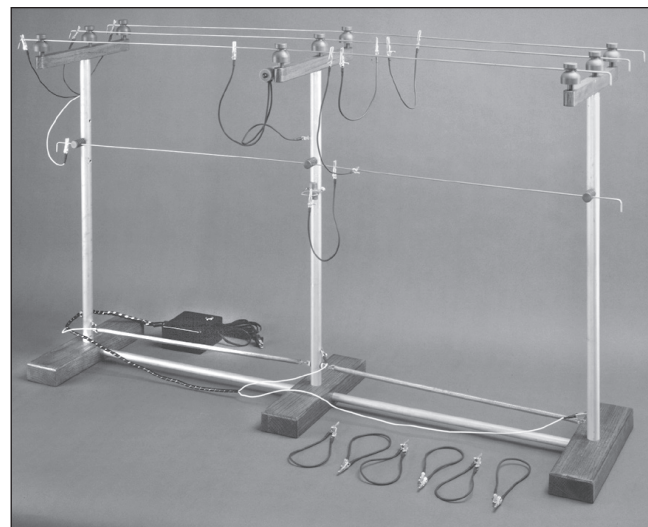

Modular design quickly sets up and takes down for storage in rugged transport case.

Operation

- To quickly test any proposed configuration, depress transformer foot switch to energize a fault on the system
- If the light glows and the buzzer sounds on the "worker," this indicates the grounding system in place fails to provide protection
- If no such signals occur, the scheme of grounding connections does create a protective zone of equalized potential at the worksite

Ordering Information

Catalog No.	Description	Weight
C6001950	Grounding Simulator Kit Dimensions: 33" H x 55" W x 15" D	23 lb. / 10.4 kg.

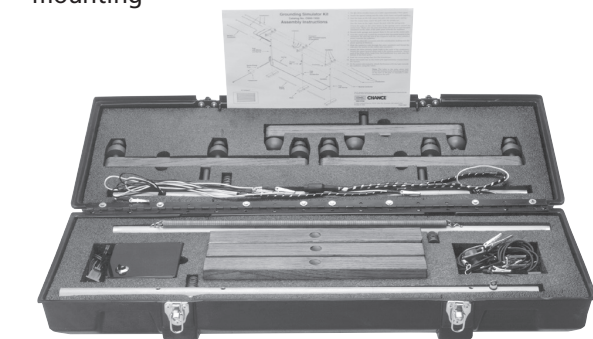

Durable & Accurate

- Durable, aluminum pipe poles
- Wood crossarms
- Electrically correct, aluminum poles effect the conductivity which should be assumed for actual poles
- Leads from the poles and neutral connect to ground side on source (transformer)



Standard (Orange) EQUI-MAT® Personal Protective Ground Grid

Features & Applications

- Complies with OSHA 1910.269 for equipotential requirements near vehicles, underground gear, overhead switches and in substations
- Meets ASTM F2715 Standard

Portable, lightweight, high performance

- An easy way to help establish an equipotential zone for a lineworker
- For standing on during various energized and de-energized work practices
- Properly applied, it accomplishes compliance with Occupational Safety and Health Administration (OSHA) 1910.269:
 - o "Equipotential zone. Temporary protective grounds shall be placed at such locations and arranged in such a manner that the employer can demonstrate will prevent each employee from being exposed to hazardous differences in electric potential."
- Can be taken anywhere needed, is simple to use, maintain and store
- Consists of a high-ampacity tinned-copper-braid cable sewn in a grid pattern onto a vinyl/polyester fabric
- Cable terminals permit connecting mat's grid in series with an electrical ground and subject system component or vehicle
- Simply rinsing with water comprises all the care the mat requires
- Mat may be folded and stored in a tool bag to help keep it clean and protected
- Complete instructions are included with each unit

... continued on the next page ...

Basic EQUI-MAT® Personal Protective Ground Grid Each Basic Unit includes a Long Ball Stud and illustrated instructions.

Catalog No.	Size	Weight
Single 1/4" Perimeter Braid		
PSC6003080* (Bucket)	24" x 24"	5 lb. / 2.3 kg.
C6002850	58" x 58"	8 lb. / 3.6 kg.
C6002851	58" x 120"	13 lb. / 5.9 kg.
C6002852	120" x 120"	20 lb. / 9.1 kg.

*For use in bottom of personnel bucket of lift truck.

Pre-Packaged Kits

Each Pre-Packaged Kit includes Ground Grid (size below with Long Ball Stud and illustrated instructions) plus Ground Set T6002841 and Storage Bag C4170147.

Kit Catalog No.	EQUI-MAT® Personal Protective Ground Grid Size	Weight per Kit
C6002989	58" x 58"	19 lb. / 8.6 kg.
C6002990	58" x 120"	27 lb. / 12.2 kg.
C6002991	120" x 120"	30 lb. / 13.6 kg.

Accessory Items

 **Long Ball Stud T6002364**
included with each Basic EQUI-MAT® Personal Protective Ground Grid (Catalog page 3014)



Ground Set T6002841 included with Kits only
Consists of 6 ft. long #2 cable with ferrules applied, Ball Socket clamp (C6002100) and C-Type clamp (T6000465)



Storage Bag C4170147
included with Kits only
Catalog pages 2512-13



CHANCE[®] Standard (Orange) EQUI-MAT[®]

Personal Protective Ground Grid

Features & Applications

- Complies with OSHA 1910.269
- For equipotential requirements near vehicles, underground gear, overhead switches and in substations

Applications

Padmounted Transformers and Switches

- Complies with OSHA 1910.269
- Protects workers operating and maintaining padmounted transformers and switchgear
- Proper use of EQUI-MAT Personal Protective Ground Grid in these applications creates an equipotential zone
- This is the same as a cluster bar (chain binder) does in overhead grounding practices



Bottom of Personnel Bucket on Lift Truck

- Use only 24" x 24" Catalog No. PSC6003080

Mechanical Equipment (Vehicles, etc.) Grounding

- Provides compliance with OSHA 1910.269
- Protects workers around mechanical equipment which could become energized, such as utility vehicles and portable generators
- For proper application, EQUI-MAT Personal Protective Ground Grids are attached to the vehicle (for example) at locations where workers could contact the vehicle
- This extends the equipotential area around the vehicle

Simple to join multiples for larger areas

- Cascading (or joining together) two or more mats is easy
- Connecting tab and hardware furnished with each mat

Overhead Distribution and Transmission Switches

- EQUI-MAT Personal Protective Ground Grid can help eliminate step and touch potential
- Connect it to the handle of an overhead switch and stand on it when opening or closing the switch

Line Apparatus Work

- Similar uses for installing, maintaining or operating regulators, reclosers, capacitor banks

Suspect Substation Grids

- If station ground mat integrity is questionable, apply the EQUI-MAT Personal Protective Ground Grid

- Connected in series, the conductive grids become one
- For larger area, place lug connector tabs of two adjacent mats on the supplied bolt or threaded shank of a ball stud and secure with supplied washer and nut



(Left) To join mats, conductive grids simply connect at tabs with bolt, washer and nut included with each mat. Tabs have shrink tube for stress relief. (Right) Ball stud can join mats and connect to ground set clamps.

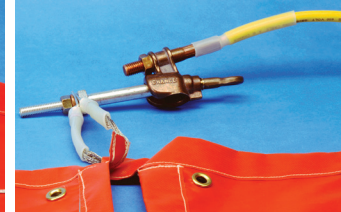

Long ball stud accepts various grounding clamps as shown below and at right: Ball/Socket, C Type and Duckbill.

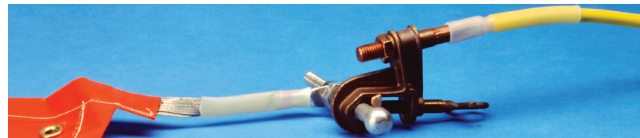
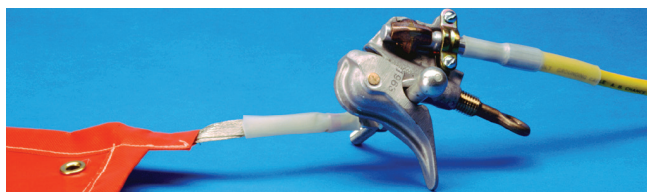

Phone: 573-682-5521 Email: hpsliterature@hubbell.com Web: hubbellpowersystems.com

Slip-Resistant (Black) EQUI-MAT® Personal Protective Ground Grid

Features & Applications

- Complies with OSHA 1910.269 for equipotential requirements near vehicles, underground gear, overhead switches and in substations
- Meets ASTM F2715 Standard

Portable, lightweight, high performance

- An easy way to help establish an equipotential zone for a lineworker
- For standing on during various energized and de-energized work practices
- Properly applied, it accomplishes compliance with Occupational Safety and Health Administration (OSHA) 1910.269:
 - o "Equipotential zone. Temporary protective grounds shall be placed at such locations and arranged in such a manner that the employer can demonstrate will prevent each employee from being exposed to hazardous differences in electric potential."
- Can be taken anywhere needed, is simple to use, maintain and store
- Consists of a high-ampacity tinned-copper-braid cable sewn in a grid pattern onto a vinyl/polyester fabric
- Cable terminals permit connecting mat's grid in series with an electrical ground and subject system component or vehicle
- Simply rinsing with water comprises all the care the mat requires
- Mat may be folded and stored in a tool bag to help keep it clean and protected
- Complete instructions are included with each unit

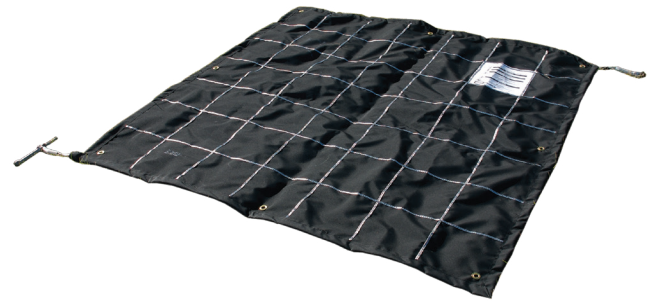

Slip-Resistant material

- For rain, snow and ice conditions
- Napped surface offers superior footing
- For dry conditions, consider the Standard (Orange) EQUI-MAT® Personal Protective Ground Grid, available in the same sizes and kits

... continued on the next page ...

Slip-Resistant EQUI-MAT® Personal Protective Ground Grid Each Unit includes Ground Grid, Long Ball Stud and illustrated instructions

Catalog No.	Size	Weight
<i>Single 1/4" Perimeter Braid</i>		
PSC6003345	58" x 58"	8 lb. / 3.6 kg.
PSC6003346	58" x 120"	13 lb. / 5.9 kg.
PSC6003347	120" x 120"	20 lb. / 9.1 kg.



Pre-Packaged Slip-Resistant EQUI-MAT® Kits Each Kit includes Ground Grid (size below with Long Ball Stud and illustrated instructions) plus Ground Set T6002841 and Storage Bag C4170147

Kit Catalog No.	EQUI-MAT® Personal Protective Ground Grid Size	Weight per Kit
PSC6003348	58" x 58"	19 lb. / 8.6 kg.
PSC6003349	58" x 120"	27 lb. / 12.2 kg.
PSC6003350	120" x 120"	30 lb. / 13.6 kg.



Accessories

 Long Ball Stud T6002364 included with each Basic EQUI-MAT® Personal Protective Ground Grid (Catalog page 3014)

 Ground Set T6002841 included with Kits only
Consists of 6 ft. long #2 cable with ferrules applied, Ball Socket clamp (C6002100) and C-Type clamp (T6000465)



Storage Bag C4170147 included with Kits only
Catalog pages 2512-13

Slip-Resistant (Black) EQUI-MAT[®] Personal Protective Ground Grid

Features & Applications

- Complies with OSHA 1910.269 for equipotential requirements near vehicles, underground gear, overhead switches and in substations

Padmounted Transformers and Switches

- Complies with OSHA 1910.269
- Protects workers operating and maintaining pad-mounted transformers and switchgear
- Proper use of EQUI-MAT Personal Protective Ground Grid in these applications creates an equipotential zone
- This is the same as a cluster bar (chain binder) does in overhead grounding practices

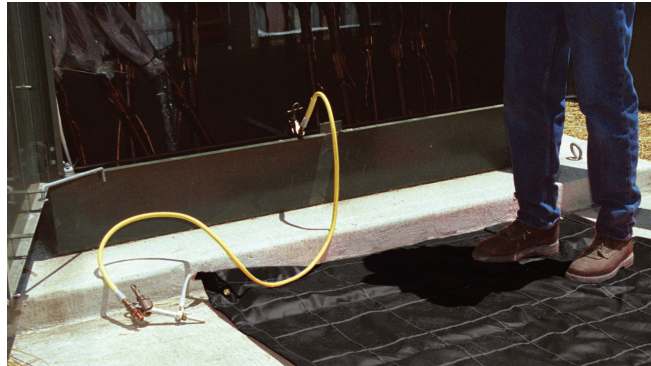

Mechanical Equipment (Vehicles, etc.) Grounding

- Provides compliance with OSHA 1910.269
- Protects workers around mechanical equipment which could become energized, such as utility vehicles and portable generators
- For proper application, EQUI-MAT Personal Protective Ground Grids are attached to the vehicle (for example) at locations where workers could contact the vehicle
- This extends the equipotential area around the vehicle

Overhead Distribution and Transmission Switches

- EQUI-MAT Personal Protective Ground Grid can help eliminate step and touch potential
- Connect it to the handle of an overhead switch and stand on it when opening or closing the switch

Line Apparatus Work

- Similar uses for installing, maintaining or operating regulators, reclosers, capacitor banks

Suspect Substation Grids

- If station ground mat integrity is questionable, apply the EQUI-MAT Personal Protective Ground Grid
- Connected in series, the conductive grids become one
- For larger area, place lug connector tabs of two adjacent mats on the supplied bolt or threaded shank of a ball stud and secure with supplied washer and nut

Simple to join multiples for larger areas

- Cascading (or joining together) two or more mats is easy
- Connecting tab and hardware furnished with each mat

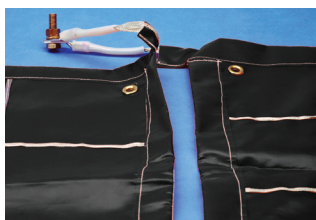

(Left) To join mats, conductive grids simply connect at tabs with bolt, washer and nut included with each mat. Tabs have shrink tube for stress relief. (Right) Ball stud can join mats and connect to ground set clamps.

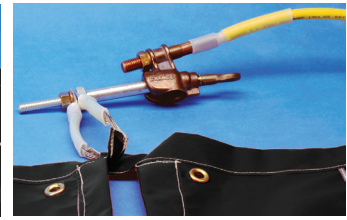

Long ball stud accepts various grounding clamps as shown below and at right: Ball/Socket, C Type and Duckbill.



Rotating Ground Adapters for Reels

Tested and Meets ASTM F855 Standard

Applications

- Provide system protection while conductor is pulled from reels for stringing operations. By design, the system adds conductor grounding but does not replace other grounding practices.
- This includes items such as Equi-Mat® personal protective ground grids (CHANCE Catalog Section 3000)
- System serves as intended path to ground for static discharge and accidental energizing from downed lines, equipment contact, adjacent conductors and lightning

Installation

- Rotating Ground Adapter slides on reel mandrel and three locking bolts secure it
- Outer collar contact connects to the end of the conductor from inside the reel
- Adapter's inner collar contact connects to a permanent or screw-in ground rod (not included, see CHANCE Catalog Section 3000)

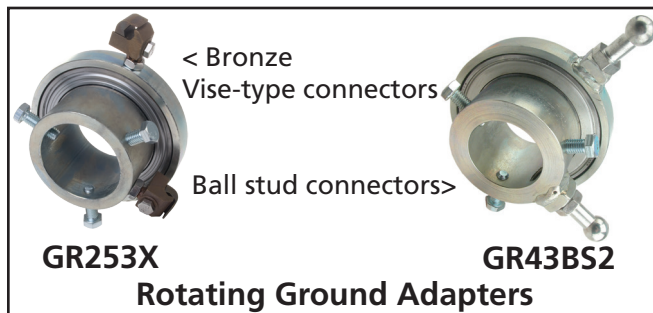

Rotating Ground Adapters for Reels Ordering Information

Catalog No.	ASTM Grade: Fault Rating	Pipe Dia. Maximum	Connector Type	Connector Range	Weight
Rotating Grounding Adapters					
GR253X	ASTM Grade 1: 14kA @ 15 cycles 10kA @30 cycles	3-3/16"	Bronze Vise Type	3 Sol. to 4/0 Str.	9.8 lb. / 4.4 kg.
GR43BS2	ASTM Grade 5: 43kA @15 cycles 30kA @30 cycles	2-11/16"	Two 1"-diameter Ball Studs	See Ball Stud Clamp in CHANCE Cat. Section 3000	12.8 lb. / 5.8 kg.
Single Reel Grounding Set					
PST6003438	Grade 3: 27kA @15 cycles 20kA @30 cycles (Ratings for this set are limited to those for the 2/0 grounding cable.)	2-11/16"	4 ea. C6001754 C-type ground clamps, 2 ea. T6002320 ball stud ground clamps, 1 ea. GR43BS2 rotating ground adapter, 6 ea. Ferrules (aluminum), 6 ea. Shrink tubes, 63 ft. S6118 yellow neoprene 2/0 cable (1 @ 50 ft., 1 @ 10 ft., 1 @ 3 ft.)		53.8 lb. / 24.4 kg.

HUBBELL[®]

Power Systems, Inc.

• 210 N. Allen St. • Centralia, MO 65240 • (573) 682-5521

NOTICE: For the latest revision of our Catalog and Literature, click here or visit our web site: www.hubbellpowersystems.com

NOTE: Hubbell has a policy of continuous product improvement. Please visit hubbellpowersystems.com to confirm current design specifications. ©Copyright 2020 Hubbell Incorporated

NEVER COMPROMISE™

www.hubbellpowersystems.com

MARCH 2020



Catalog 3000