

CONNECT AND PROTECT

# Fixing, Fastening & Support Products

For Electrical Installation and  
Datacom & Telecom Applications



  
nvent

**CADDY**

8

7

6

5

4

3

2

1



# nVent

Just as every idea begins with a spark, we at nVent view the dawn of every sunrise as a new opportunity to ignite innovation. Our inventive solutions benefit customers around the world every day, keeping lights on, data streaming and trains running on time.

From heat trace cables to critical equipment enclosures to labor-efficient fastening systems, we empower customers to improve performance, lower costs and reduce downtime.

We are a \$2.2 billion, high-performance electrical company with a dedicated team of 9,400 people and trusted brands such as nVent CADDY, ERICO, HOFFMAN, RAYCHEM, SCHROFF and TRACER. Known for innovation, quality and reliability, our products connect and protect, consistently delivering value to industrial, commercial, residential, energy and infrastructure customers.

While our name may be new, our products have set the standards for quality for more than a century. Today as nVent, we are focused and forward-looking, ready to build upon our legacy. The future is now.

# Table of Contents

Featured Products . . . . .	<b>A-1 - A-16</b>
Product Application Reference . . . . .	<b>B-1 - B-18</b>
Code Compliance . . . . .	<b>C-1 - C-20</b>
Cable/Conduit . . . . .	<b>1-1 - 1-56</b>
Structural Attachments . . . . .	<b>2-1 - 2-62</b>
nVent CADDY All-In-One . . . . .	<b>3-1 - 3-16</b>
Stud Wall . . . . .	<b>4-1 - 4-36</b>
Datacom/Low Voltage (featuring nVent CADDY Cat HP) . . . . .	<b>5-1 - 5-66</b>
nVent CADDY Rod Lock . . . . .	<b>6-1 - 6-12</b>
nVent CADDY Speed Link . . . . .	<b>7-1 - 7-26</b>
Ceiling/Acoustical . . . . .	<b>8-1 - 8-28</b>
(Mechanical) – Pipe and Tube Fixings . . . . .	<b>9-1 - 9-8</b>
nVent CADDY Pyramid . . . . .	<b>10-1 - 10-26</b>
Metal Framing . . . . .	<b>11-1 - 11-28</b>
Seismic Bracing Systems . . . . .	<b>12-1 - 12-18</b>
Reference . . . . .	<b>D-1 - D-10</b>
Alpha-Numeric Index . . . . .	<b>E-1 - E-13</b>



Click any product part number for more details via our online catalog at [nVent.com](http://nVent.com)



Click the video icon to watch installation or product videos containing those products

**WARNING** nVent products shall be installed and used only as indicated in nVent's product instruction sheets and training materials. Instruction sheets are available at [nVent.com/CADDY](http://nVent.com/CADDY) and from your nVent customer service representative. Improper installation, misuse, misapplication or other failure to completely follow nVent's instructions and warnings may cause product malfunction, property damage, serious bodily injury and/or death, and void your warranty.



# Featured Products



## FEATURED PRODUCTS

### Stud Wall

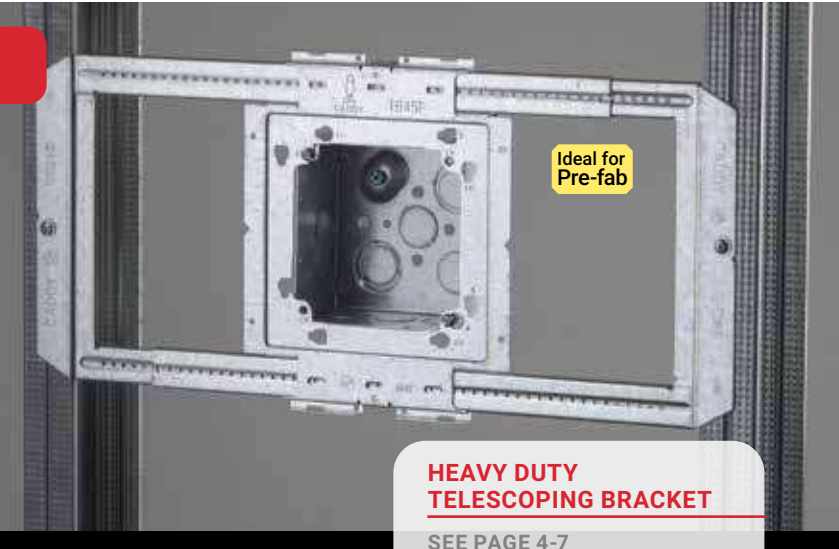

#### HEAVY DUTY TELESCOPING BRACKET

SEE PAGE 4-7

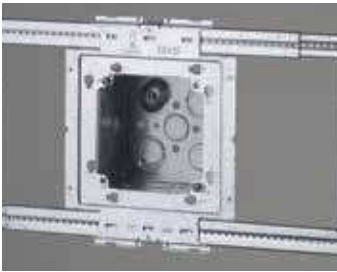

- Innovative design allows boxes to be added or removed without removing bracket from studs
- Attach boxes quickly and easily with snap-on box mounting plates (sold separately)
- Rigid design eliminates need for far-side support
- Ready to use out of the box

#### BOX MOUNTING PLATE

SEE PAGE 4-7

- Snap-on installation to Heavy Duty Telescoping Bracket allows for easy positioning along bracket
- Can also be mounted directly to metal or wood studs
- Key holes provide ease of installation and positive location when mounting boxes
- Extruded holes allow mounting of mud rings for both power and data applications
- Screws can be removed and reinstalled in extruded holes multiple times without compromising holding strength
- Accepts vertically or horizontally mounted single and double gang adjustable mud rings

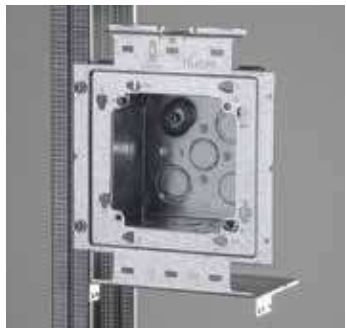

#### BOX MOUNTING PLATE WITH FAR SIDE SUPPORT

SEE PAGE 4-9

- Innovative far side support allows bracket to be installed on virtually any stud depth and up to 3" wide studs

## FEATURED PRODUCTS

### Stud Wall



#### FIRST MEANS OF SECUREMENT FOR HEAVY DUTY BOX BRACKET

---

SEE PAGE 4-9

- Provides first means of securement for MC/AC and EMT conduit
- Works with Heavy Duty Rigid Box Support and Heavy Duty Telescoping Bracket
- Snaps into channel and locks into place without screws
- Rigid locking tab securely locks into place when closed and opens for easy conduit placement



#### T-GRID MOUNTING CLIP FOR HEAVY DUTY TELESCOPING BOX BRACKET

---

SEE PAGE 8-22

- For use with Heavy Duty Telescoping Box Bracket (TB1624HD) and Box Mounting Plate (TB45P) to install electrical boxes between T-grid
- Snap-on design eliminates the need for attachment screw to T-grid
- Accommodates ceiling tile up to 1-1/4" thick



#### nVENT CADDY FIRE ALARM ELECTRICAL BOX WITH HEAVY DUTY BRACKET

---

SEE PAGE 4-9



#### BETWEEN STUD PANEL MOUNTING BRACKET

---

SEE PAGE 4-13

- Panel bracket attaches to panel box providing a rigid surface to quickly and easily secure flexible conduit
- Ideal for contractors wanting to pre-fab panel boxes
- Fasten and protect cables during assembly, shipping, and installation
- Can be used in combination with MC/AC Cable to Metal Stud Clip to securely attach 14-2 to 12-3 MC/AC size cables creating a tool free attachment process

## FEATURED PRODUCTS

### Stud Wall

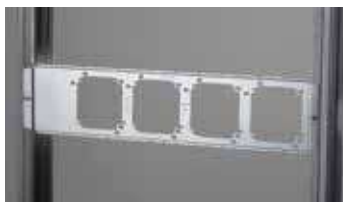

#### HEAVY DUTY RIGID BOX SUPPORT

---

SEE PAGE 4-4

- Heavy duty design with increased strength that is twice as strong than the first generation rigid box support
- Supports electrical boxes, plaster rings or low voltage devices from one bracket
- Accepts vertically or horizontally mounted single and double gang adjustable mud rings
- Designed to work with snap in place first means of support for conduit and cables



#### STUD SPANNER BAR

---

SEE PAGE 4-14

- Secures EMT, MC/AC, and flexible conduit between metal studs
- Innovative clip securely attaches to metal studs in pre-punched holes
- Roll-formed bar for increased strength and rigidity
- Use with Cable/Conduit Clip to secure conduit and cable to bar
- Adjustable for non-standard stud spacing
- No tools required for installation



#### FLAT RIGID BOX SUPPORT

---

SEE PAGE 4-5

- No offset resulting in a completely flat bracket
- Accepts any mud ring shape
- Extruded holes allow mounting of mud rings for both power and data applications

#### FIRST MEANS OF SUPPORT FOR FLAT RIGID BOX SUPPORT

---

SEE PAGE 4-6

- Provides reliable, rigid, support
- Securely holds within the stud space and is compatible with the "Colorado Jim" Cable Support
- Allows you to install any box, regardless of depth



#### FLOOR STAND FOR FLAT RIGID BOX SUPPORT

---

SEE PAGE 4-5

- Positions boxes a consistent 18-1/2" from the floor, no need to measure
- Meets ADA accessibility guidelines



## FEATURED PRODUCTS

### Stud Wall – Snap to Stud



#### **SNAP TO STUD "COLORADO JIM" CABLE SUPPORT**

SEE PAGE 4-16

- Snap to stud function makes installation fast and easy, saving time and increasing productivity
- No tools or fasteners needed for installation
- Cable locating ribs to maintain cable separation
- Flared edges for cable protection
- NEC® 300.4D applicable



#### **SNAP TO STUD ELECTRICAL BOX BRACKET**

SEE PAGE 4-10

- Snap to stud function makes installation fast and easy, saving time and increasing productivity
- Self-leveling feature ensures the electrical box is always square to the stud
- Mounts to either side of the stud and can be mounted side by side on the same stud
- Accommodates all stud depths



#### **SNAP TO STUD TELESCOPING SCREW GUN BOX BRACKET**

SEE PAGE 4-26

- Snap to stud function makes installation fast and easy, saving time and increasing productivity
- Self-leveling feature ensures the bracket is always square to the stud, for a consistent and professional installation
- Pre-configured for 2-1/8" deep boxes and only a simple adjustment needed for 1-1/2" deep boxes
- Can mount multiple boxes
- Requires only two screws to install



#### **nVENT CADDY GLIDER ELECTRICAL BOX ATTACHMENT, SCREWLESS**

SEE PAGE 4-28

- Secures electrical boxes to the TSGB without tools or screws
- Innovative design securely clips onto electrical box eliminating attachment screw
- Allows for easy repositioning of electrical boxes

## FEATURED PRODUCTS

### nVent CADDY Rod Lock Threaded Rod Mounting System



#### **nVENT CADDY ROD LOCK**

The Rod Lock family of products allows contractors to prefabricate complex assemblies at ground level or offsite, and then easily lift and lock them into place by pushing the threaded rod supports into the Rod Lock device. This ingenious technology works with threaded rod with burrs or imperfections, helping to eliminate clean-up time or the need to replace damaged threaded rod.

- Easy "push-to-install" design allows installers to simply push the threaded rod through the mounting hole, instantly holding it in position
- Works with slightly damaged threads and minor burrs on the threaded rod
- Prefabricated assemblies easily lift and lock into place, helping to save time and money



#### **ROD LOCK METAL DECKING PRESET ANCHOR**

SEE PAGE 6-5

- Set in place through a drilled hole in the metal decking before the concrete is poured
- Can be used in lower and upper flute installations



#### **ROD LOCK PLYWOOD FORM PRESET ANCHOR**

SEE PAGE 6-6

- Nails hold the anchor in place during the pour and easily break off with a strike of a hammer once the plywood forms are removed



#### **ROD LOCK METAL DECKING PRESET ANCHOR INSERT**

SEE PAGE 6-5

## FEATURED PRODUCTS

### nVent CADDY Rod Lock Spring Steel Fasteners



- Easy “push-to-install” design allows installers to simply push the threaded rod through the mounting hole, instantly holding it in position
- Prefabricated assemblies easily lift and lock into place, helping to save time and money
- Works with slightly damaged threads and minor burrs on threaded rod ends
- Design includes a release mechanism that works with pliers



#### ROD LOCK SPRING STEEL ROD HANGER

SEE PAGE 2-39

- Supports rod from block or concrete walls



#### ROD LOCK SPRING STEEL ROD HANGER WITH SHOT- FIRE BRACKET

SEE PAGE 2-41

- Suspends threaded rod without the need for additional hardware
- Complete with shot-fire bracket and pre-assembled drive pin
- Integrated pin installs easily using powder-actuated or single-shot gas-actuated tools



#### ROD LOCK SPRING STEEL ROD HANGER TO FLANGE CLIP

SEE PAGE 2-19

- Threaded rod hanger can swivel to provide a vertical dropdown
- Requires only a hammer to install



#### ROD LOCK SPRING STEEL ROD HANGER TO BEAM CLAMP

SEE PAGE 2-20

- Threaded rod hanger can swivel to provide a vertical dropdown

## FEATURED PRODUCTS

### nVent CADDY All-In-One Electrical Assemblies

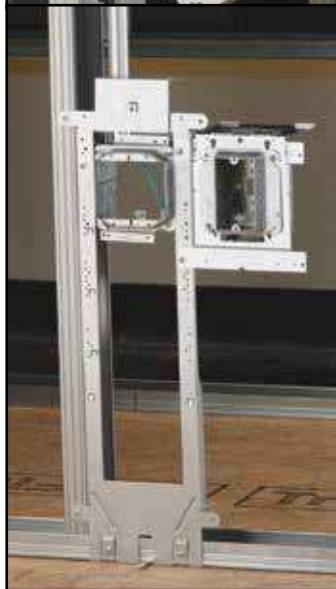

#### ALL-IN-ONE

SEE PAGE 3-1

We asked electrical contractors what problems they face and how nVent CADDY innovation can help meet their needs. We listened to what they do today and heard a consistent message: Find a better way to mount, wire and install electrical devices, such as switches and outlets, on the job or offsite. Then the nVent CADDY team designed and built ONE system that meets many of the different installation methods and preferences of today's electrical contractor.

- Complete assembly that is ready to use right out of the box and installs with just two screws
- Rigid back plate functions as a far-side support and is resistant to bending
- Box remains fixed in place when mud ring is removed (on applicable models)
- Open-back design offers faster and easier access to install conduit connectors or wiring
- Stocked inventory – available when you need it
- Made in the USA

## FEATURED PRODUCTS

### Shot-Fire / Nail Gun Fasteners



#### **DROP SMOOTH ROD WITH SHOT-FIRE BRACKET**

SEE PAGE 2-31

- Quickly and easily attaches to concrete, steel or composite metal decking
- Integrated pin installs easily using powder-actuated or single-shot gas-actuated tools
- Works with most standard nVent CADDY spring steel fasteners designed for rod attachments
- Rod is rigid and does not require secondary attachment to ceiling grid per NEC 300.11



#### **THREAD INSTALL ROD HANGER WITH NAIL GUN BRACKET**

SEE PAGE 2-37

- Suspends threaded rod without the need for additional hardware
- Complete with concrete nail gun insert bracket
- Clips onto nozzle of gas or battery-actuated nail guns allowing for hands-off installation at structure or from the floor using a pole
- Longer leg angle bracket for tool clearance



#### **ROD LOCK SPRING STEEL ROD HANGER WITH SHOT-FIRE BRACKET**

SEE PAGE 2-41

- Suspends threaded rod without the need for additional hardware
- Complete with shot-fire bracket and pre-assembled drive pin
- Integrated pin installs easily using powder-actuated or single-shot gas-actuated tools



#### **METAL PRESSURE CLIP WITH NAIL GUN INSERT**

SEE PAGE 5-56

- Ideal for smaller runs of cables
- Flexible clip allows for cables to be inserted after installation
- Rounded edges help prevent cable damage
- Low-profile allows for installations in tight spaces

# FEATURED PRODUCTS

## Fasteners



### TELESCOPING STRUT REPLACEMENT

SEE PAGE 6-9, 11-2

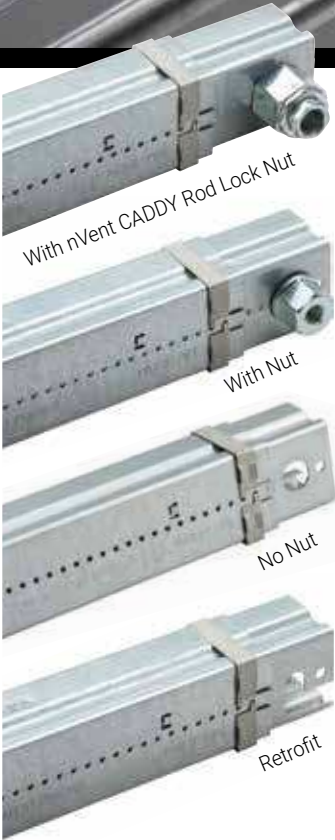

The Telescoping Strut Replacement is an innovative alternative to using traditional strut channels for trapeze or other support structures that accommodates standard strut fittings. This telescoping solution eliminates the need to handle and cut long lengths of strut to size. The bracket telescopes to the desired length and is locked in place by snapping closed a spring retainer clip.

- Standard strut profile runs the entire length of the part, allowing most standard fittings to be placed anywhere between the rods
- Spring steel retainer strap can be manually locked into place, allowing a tool-free installation
- Ready to use out of the box and eliminates the need for cutting sections of strut
- Pre-cut design is easier to transport and store than standard lengths of strut



## FEATURED PRODUCTS

### Fasteners



#### TELESCOPING CEILING BRACKET

---

SEE PAGE 8-12

- Supports fans, fixtures and luminaires from ceilings
- Can also be used in stud wall applications to support sconces and electrical boxes
- Allows for infinite positions for box location
- Easy to adjust after the electrical box is installed



#### ADJUSTABLE T-GRID BOX HANGER

---

SEE PAGE 8-18

- Adjustable height allows installation of double deep boxes, speaker cases and emergency light fixtures above T-Grid
- Snaps easily onto T-Grid
- Hanger comes complete with box mounting clip and screw

#### NVENT CADDY TRUSS-T BAR JOIST HANGER

---

SEE PAGE 2-11, 2-12

- Effortlessly slides through the middle slot of open web bar joists and quickly locks into place when put under load
- Provides greater adjustability and speed during system alignment
- Prefabricated single pipe hanger and multi-pipe/tube trapeze assemblies can be prefabricated and easily hung by the installer
- Eliminates torsion and/or distortion, adhering to the strict rules established by the Steel Joist Institute (SJI)
- Increased load carrying capacity – UL listed to support a maximum of 8" Schedule 40 pipe
- Included square washer with integrated threaded nut – no loose hardware
- Made in the USA

## FEATURED PRODUCTS

### Fasteners – Data

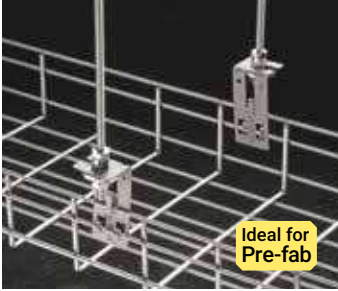

#### WIRE BASKET SUPPORT CLIP, RETROFIT

SEE PAGE 5-62

- Allows wire basket to be suspended from threaded rod without the need of a strut trapeze
- Slotted design allows wire basket to be installed above an existing trapeze
- Securing fingers provides superior stability, preventing damage to the cables in the basket
- Allows for pre-fabrication off site



#### WIRE BASKET TRAY CLIP

SEE PAGE 5-60

- Attaches wire basket tray to strut without additional hardware
- No tools required



#### LOW VOLTAGE ACCESSORY CLIP

SEE PAGE 5-57

- Ideal for low voltage applications, such as security, video, Wireless Access Protocol (WAP), Power over Ethernet (PoE), fire, and control wire
- Tool-free installation to existing wire basket pathway made easy with side retaining flaps
- Designed to fit commonly available wire basket tray with bottom and side mount applications
- Modular ganging feature for ease of installation expansion



#### METAL PRESSURE CLIP WITH NAIL GUN INSERT

SEE PAGE 5-56

- Clips onto nozzle of gas or battery-actuated nail guns allowing for hands-off installation at structure or from the floor using a pole
- Ideal for smaller runs of cables
- Flexible clip retains shape and allows for cables to be inserted after installation
- Rounded edges help prevent cable damage



# FEATURED PRODUCTS

## Data Center and Networking Solutions



### **nVent CADDY is proud to announce our new WBT Performance Cable Tray!**

The addition of the WBT product line allows nVent CADDY to offer a full, innovative solution for Data Center and Network Solutions (DNS) and cable pathway management. nVent CADDY's new wire basket tray offering provides:

- ~ 400% increase in cabling support
- Up to 65% reduction in cabling pressure/strain
- Premade, time-saving intersections
- No premium over old round wire crosswire
- Several easy-to-install configurations and finishes to fit your job site

**For more information, visit [go.nVent.com/datacom](http://go.nVent.com/datacom) or contact your sales representative.**

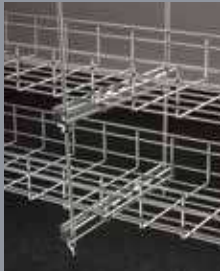

The nVent CADDY wire basket tray product family works in conjunction with the rest of our DNS line-up, including: nVent CADDY Spring Steel, nVent CADDY Universal Tray Support (UTS), nVent CADDY Telescoping Strut Replacement and nVent CADDY Wire Basket Support.

# FEATURED PRODUCTS

## nVent CADDY Seismic Bracing Systems Overview

SEE PAGE 12-1

01

Email drawings to your sales representative or complete our contact form online.



02

Receive a fully engineered, turn-key seismic solution customized to meet all code requirements.



Work with one of our trusted distributors for easy ordering and fast delivery.



03



nVent CADDY Seismic Solutions protect people, property and equipment during and after a seismic event by ensuring business continuity and continued operation of critical infrastructure and services. Areas of nVent CADDY expertise:

- Designing a complete, right-sized bracing system
- Identifying the appropriate product from our broad offering
- Offering compatible attachment and support products
- Explaining installation techniques and tips to meet evolving codes and standards requirements

From design to construction to inspection, the nVent CADDY team makes seismic simple by walking you through the full process for applications including Mechanical, HVAC, Electrical, Plumbing and Fire Protection.

Both cable and rigid bracing solutions are available for single pipe or conduit, trapeze, and for floor-, roof-, and wall-mounted equipment.



WE MAKE  
SEISMIC  
SIMPLE



# Applications

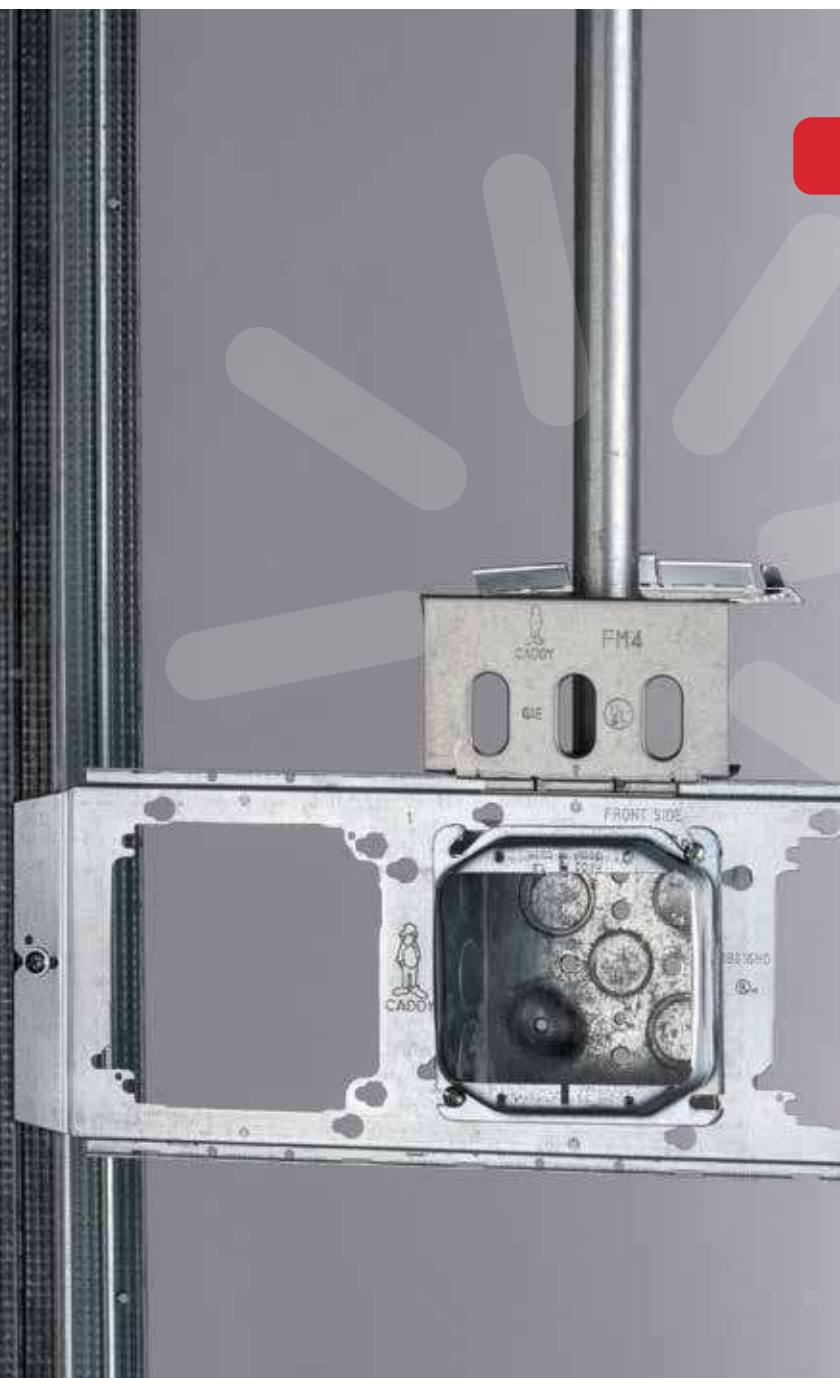

# Applications

## CABLE/CONDUIT



Page 1-2



Page 1-4



Page 1-9



Page 1-12



Page 1-14



Page 1-15



Page 1-22



Page 1-21



Page 1-21

# Applications

## CABLE/CONDUIT



Page 1-20



Page 1-20



Page 1-24

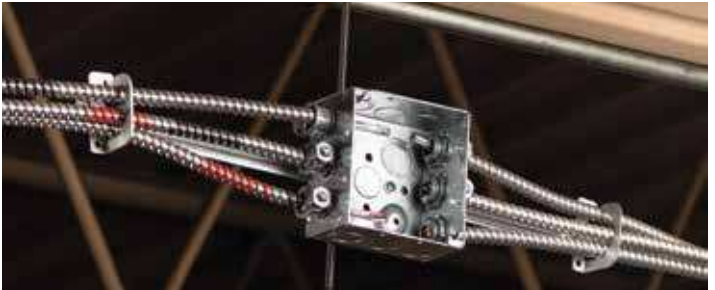

Page 1-52



Page 6-9, 9-2



Page 6-2, 9-4

# Applications

## CABLE/CONDUIT

---



Page 1-27



Page 1-27



Page 1-30



Page 1-25



Page 2-30, 1-34



Page 2-31, 1-48

## DATACOM/LOW VOLTAGE

---



Page 5-60



Page 5-51



Page 5-51



# Applications

## DATACOM/LOW VOLTAGE



Page 5-53



Page 5-54



Page 5-12



Page 5-22



Page 5-24



Page 5-23



Page 5-19



Page 5-2, 5-26, 5-35

# Applications

## DATACOM/LOW VOLTAGE

---



Page 2-31, 5-14



Page 5-20, 9-2, 11-5



Page 5-41



Page 5-57



Page 3-12



Page 3-14, 5-52



Page 3-4, 4-18



# Applications

## STUDWALL

---

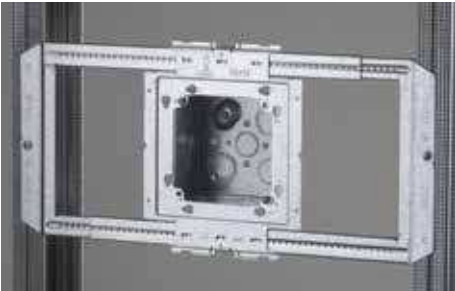

Page 4-7, 4-8



Page 3-14, 4-29



Page 3-2



Page 3-4



Page 4-7, 4-8, 3-15



Page 3-11

# Applications

## STUDWALL



Page 4-2, 4-12, 4-31



Page 4-9



Page 4-11



Page 4-4, 4-17



Page 4-6



Page 4-12, 4-20



Page 4-12

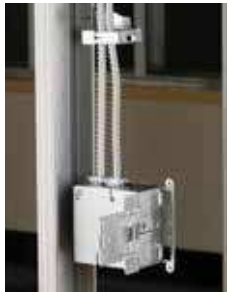

Page 4-3, 4-17

# Applications

## STUDWALL

---



Page 4-15



Page 4-16



Page 4-23



Page 4-18



Page 4-20



Page 4-18



Page 4-23



Page 4-27, 4-29

# Applications

## STUDWALL



Page 4-6



Page 4-25, 4-31



Page 4-32



Page 4-32



Page 4-26



Page 4-30



Page 4-26



Page 4-27

# Applications

## STUDWALL

---



Page 4-26, 4-28



Page 4-13

## CEILING / ACOUSTICAL

---



Page 8-2



Page 8-3



Page 8-3



Page 8-4, 7-6, 7-26

# Applications

## CEILING / ACOUSTICAL



Page 8-4



Page 8-9



Page 8-9, 7-18



Page 8-11, 7-12



Page 8-14



Page 8-6



Page 8-7

# Applications

## CEILING / ACOUSTICAL



Page 8-12



Page 8-22



Page 8-19



Page 8-24, 7-6



Page 7-11



Page 5-21



Page 7-6, 8-19, 8-21

# Applications

## STRUCTURAL ATTACHMENTS



Page 6-2, 2-50



Page 2-15, 7-6



Page 2-19



Page 2-22



Page 2-25



Page 2-26



Page 2-38



Page 2-47



Page 2-16



# Applications

## STRUCTURAL ATTACHMENTS



Page 2-65, 2-50



Page 6-2, 9-4



Page 7-2, 7-18



Page 7-12



Page 7-18



Page 7-5



Page 7-8



Page 7-2

# Applications

## STRUCTURAL ATTACHMENTS

---



Page 7-5



Page 5-56, 5-60



Page 2-31, 1-33



Page 2-31, 1-49



Page 2-30, 1-31

## ROOFTOP SUPPORTS

---



Page 10-7



Page 10-3

# Applications

## ROOFTOP SUPPORTS



Page 10-2, 10-3, 10-5



Page 10-2



Page 10-2



Page 10-4



Page 10-4

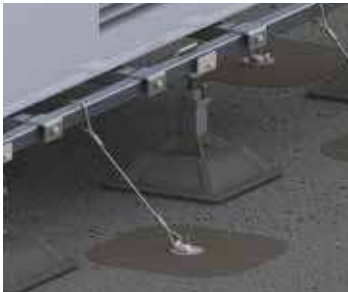

Page 10-10, 10-20

# Applications

## CONCRETE



Page 2-30, 2-31



Page 5-56, 5-60



Page 9-5



Page 1-17



Page 5-42



Page 1-25

## 2020 National Electrical Code®

## 2018 Canadian Electrical Code®

A handbook of recommended  
CADDY® Fasteners for easy  
compliance to the fastening  
requirements of the 2020 NEC®  
and 2018 CEC®

NFPA 70®, National Electrical Code® and NEC® (pages C-1 - C18) are registered trademarks of the National Fire Protection Association, Quincy, MA.

CEC (pages C-19 - C-20) is a registered trademark of, and the Canadian Electric Code (CEC) standard is a copyright of the Canadian Standards Association International.

## CODE COMPLIANCE

### NEC

The intent of this publication is to help the electrical industry meet the 2020 National Electrical Code requirements in North America as they relate to fastening applications. (See page C-19 for 2018 Canadian Electrical Code.)

Shown are a variety of solutions.

NOTE: Consult the AHJ (authority having jurisdiction) as local codes may supersede the National Electrical Code®.

#### **2020 NEC Article 90**

##### **Introduction**

##### **90.3 Code Arrangement.**

Chapter 8 covers communications systems and is not subject to the requirements of Chapters 1 through 7 except where the requirements are specifically referenced in Chapter 8. [See page 51-52]

##### **90.4 Enforcement.**

...The authority having jurisdiction for enforcement of the Code has the responsibility for making interpretations of the rules, for deciding on the approval of equipment and materials, and for granting the special permission contemplated in a number of the rules.

By special permission, the authority having jurisdiction may waive specific requirements in this Code or permit alternative methods where it is assured that equivalent objectives can be achieved by establishing and maintaining effective safety.

---

#### **2020 NEC Article 300**

##### **Wiring Methods**

##### **300.4 Protection Against Physical Damage.**

(D) Cables and Raceways Parallel to Framing Members.

...the cable or raceway shall be installed and supported...not less than 32 mm (1<sup>1</sup>/<sub>4</sub> in.) from the nearest edge of the framing member...where nails or screws are likely to penetrate. [See Fig. 1]

Where this distance cannot be maintained, the cable or raceway shall be protected from penetration by nails or screws by a steel plate, sleeve, or equivalent at least 1.6 mm (1<sup>1</sup>/<sub>16</sub> in.) thick... [See Fig. 2 & 10]

Exception No. 3: A listed and marked steel plate less than 1.6 mm (1/16 in.) thick that provides equal or better protection against nail or screw penetration shall be permitted.

# CODE COMPLIANCE

## NEC

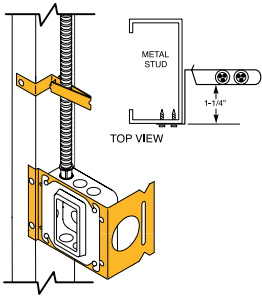

*C-J6 Cable Support for MC/AC and Nonmetallic Sheathed Cable*

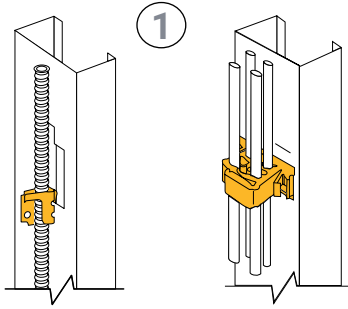

*MAC2 Series for MC/AC Cable*

*CG4 Cable Gripper for Nonmetallic Sheathed Cable or low-voltage wiring to wood and metal stud*

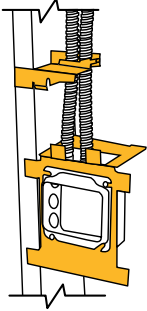

*CER4 MC/AC and Non-Metallic Sheathed Cable Support*

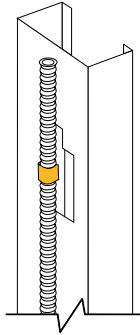

*449 MC/AC Cable to Metal Stud Clip*

Reference  
**CEC 12-510**  
**CEC 12-516**  
**CEC 12-618**

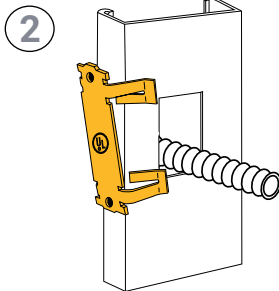

Reference  
**CEC 12-516**  
**CEC 12-616**

*304B2 Press-on Protection Plates for Wood and Metal Studs*

# CODE COMPLIANCE

## NEC

### 300.11 Securing and Supporting.

(A) Secured in Place. Raceways, cable assemblies, boxes, cabinets and fittings shall be securely fastened in place. Support wires that do not provide secure support shall not be permitted as the sole support. Support wires and associated fittings that provide secure support and that are installed in addition to the ceiling grid support wires shall be permitted as the sole support. Where independent support wires are used, they shall be secured at both ends. Cables and raceways shall not be supported by ceiling grids.

(1) Fire-Rated Assemblies. Wiring located within the cavity of a fire-rated floor-ceiling or roof-ceiling assembly shall not be secured to, or supported by, the ceiling assembly, including the ceiling support wires. An independent means of secure support shall be provided and shall be permitted to be attached to the assembly. Where independent support wires are used, they shall be distinguishable by color, tagging, or other effective means from those that are part of the fire-rated design. [See Fig. 3A and 3B]

(2) Non-Fire-Rated Assemblies. Wiring located within the cavity of a non-fire-rated floor-ceiling or roof-ceiling assembly shall not be secured to, or supported by, the ceiling assembly, including the ceiling support wires. An independent means of secure support shall be provided and shall be permitted to be attached to the assembly. Where independent support wires are used, they shall be distinguishable by color, tagging, or other effective means. [See page 53 for more details relating to 300.11 and fastener solutions.]

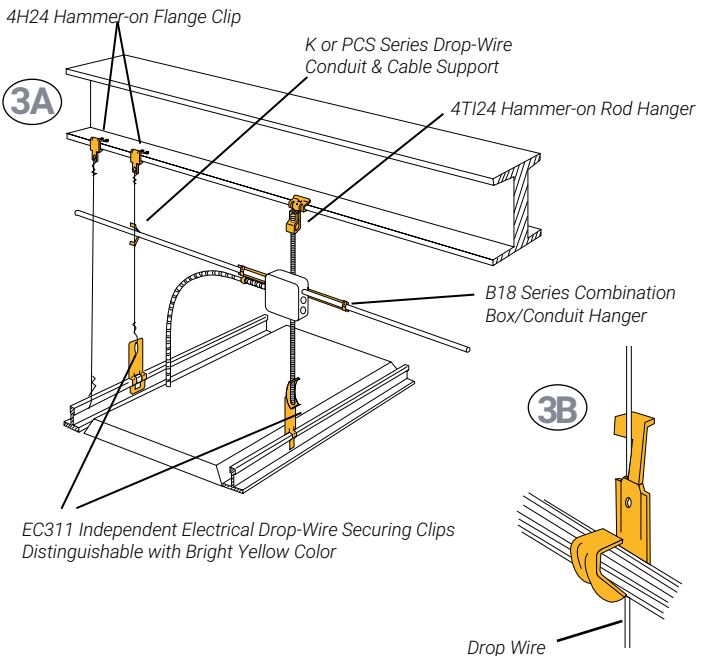



# CODE COMPLIANCE

## NEC

### 2020 NEC Article 310 Conductors for General Wiring

#### 310.15 Ampacities for Conductors Rated 0-2000 Volts 310.15(B)(3)(a) Adjustment Factors.

Exception No. 4: Adjustment factors shall not apply to Type AC cable or to Type MC cable under the following conditions:

- (a) The cables do not have an overall outer jacket.
- (b) Each cable has not more than three current-carrying conductors.
- (c) The conductors are 12 AWG copper.
- (d) Not more than 20 current-carrying conductors are installed without maintaining spacing, are stacked or are supported on "bridle rings".

Exception No. (4): If cables meeting the requirements in 310.15(B)(3)(4)a through c with more than 20 current-carrying conductors are installed longer than 600 mm (24 in.) without maintaining spacing, are stacked, or are supported on bridle rings, a 60 percent adjustment factor shall be applied.

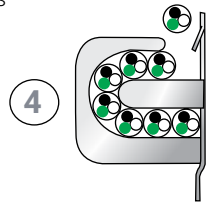

#### 310.15 Ampacities for Conductors Rated 0-2000 Volts 310.15(B)(3)(c) Adjustment Factors.

(c) Raceways and Cables Exposed to Sunlight on Rooftops. Where raceways or cables are exposed to direct sunlight on or above rooftops, raceways or cables shall be installed a minimum distance above the roof to the bottom of the raceway or cable of 23 mm (7/8 in.). Where the distance above the roof to the bottom of the raceway is less than 23 mm (7/8 in.), a temperature adder of 33°C (66°F) shall be added to the outdoor temperature to determine the applicable ambient temperature for application of the correction factors in Table 310.15(B)(2)(a) or Table 310.15(B)(2)(b).

Exception: Type XHHW-2 insulated conductors shall not be subject to this ampacity adjustment.

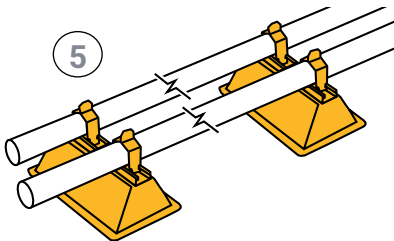

# CODE COMPLIANCE

## NEC

### 2020 NEC Article 314

#### Outlet, Device, Pull, and Junction Boxes; Conduit Bodies; Fittings; and Handhole Enclosures

##### 314.20 Flush-Mounted Installations.

Installations within or behind a surface of concrete, tile, gypsum, plaster, or other noncombustible material, including boxes employing a flush-type cover or faceplate, shall be made so that the front edge of the box, plaster ring, extension ring, or listed extender will not be set back of the finished surface more than 6 mm (1/4 in.).

Installations within a surface of wood or other combustible surface material, boxes, plaster rings, extension rings, or listed extenders shall extend to the finished surface or project therefrom.

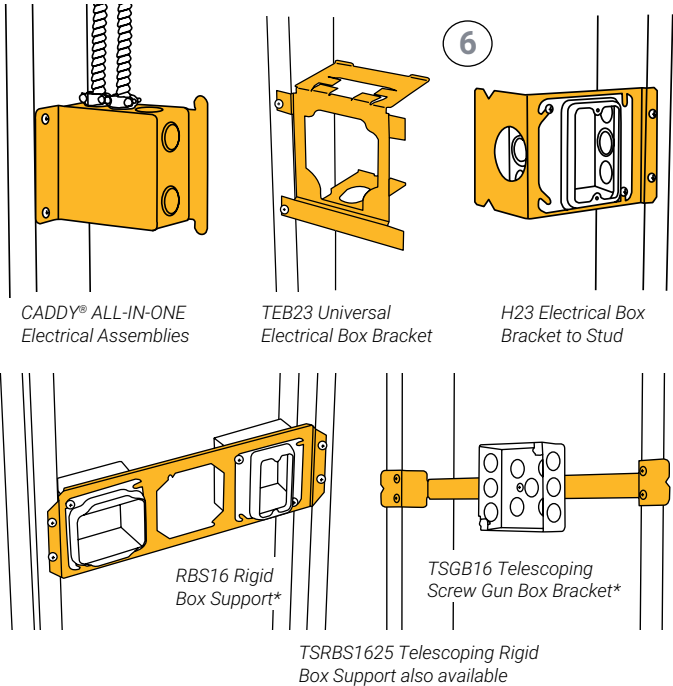

##### 314.23 Supports.

Enclosures within the scope of this article shall be supported in accordance with one or more of the provisions in 314.23(A) through (H).

(D) **Suspended Ceilings.** An enclosure mounted to structural or supporting elements of a suspended ceiling shall be not more than 1650 cm<sup>3</sup> (100 in.<sup>3</sup>) in size and shall be securely fastened in place in accordance with either (D)(1) or (D)(2).

(1) **Framing Members.** An enclosure shall be fastened to the framing members by mechanical means such as bolts, screws, or rivets, or by the use of clips or other securing means identified for use with the type of ceiling framing member(s) and enclosure(s) employed. The framing members shall be adequately supported and securely fastened to each other and to the building structure. [See Fig. 7A]

# CODE COMPLIANCE

## NEC

(2) Support Wires. The installation shall comply with the provisions of 300.11(A). The enclosure shall be secured, using methods identified for the purpose, to ceiling support wire(s), including any additional support wire(s) installed for that purpose. Support wire(s) used for enclosure support shall be fastened at each end so as to be taut within the ceiling cavity. [See Fig. 7B]

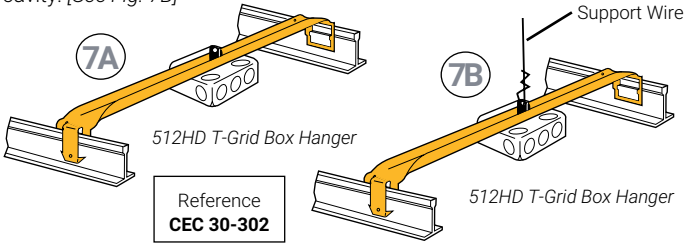

(E) Raceway Supported Enclosure, Without Devices, Luminaires, or Lampholders. Each conduit shall be secured within 900 mm (3 ft.) of the enclosure, or within 450 mm (18 in.) of the enclosure if all conduit entries are on the same side. [See Fig. 8A & 8B]

Consult Current NEC for Exceptions.

(F) Raceway-Supported Enclosures, with Devices, Luminaires, or Lampholders. Each conduit shall be secured within 450 mm. (18 in.) of the enclosure. [See Fig. 8C]

Consult Current NEC for Exceptions.

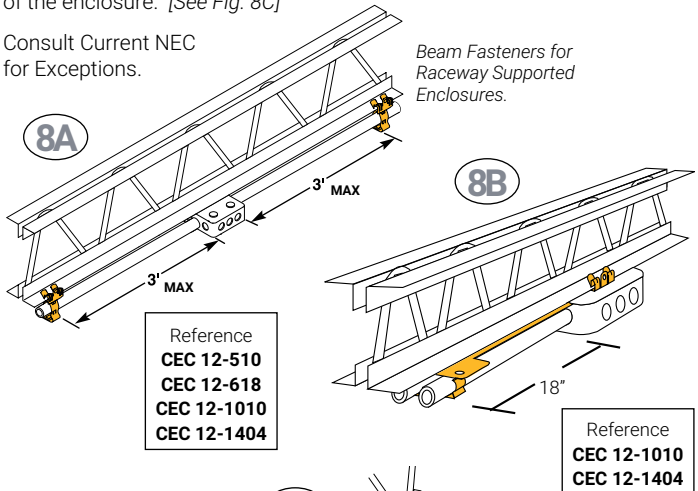

Reference  
**CEC 12-1010**  
**CEC 12-1404**

B18 Series Combination box/conduit hanger eliminates conduit bends.

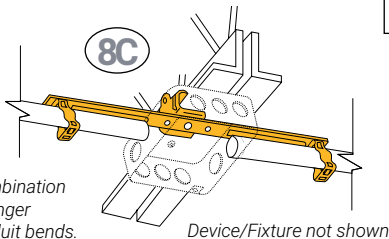

## CODE COMPLIANCE

### NEC

#### **314.27 Outlet Boxes.**

(A) Boxes at Luminaire or Lampholder Outlets. Outlet boxes or fittings designed for the support of luminaires and lampholders, and installed as required by 314.23, shall be permitted to support a luminaire or Lampholder.

(2) Ceiling Outlets. ... Boxes shall be required to support a luminaire weighing a minimum of 23 kg (50 lb). A luminaire that weighs more than 23 kg (50 lb) shall be supported independently of the outlet box, unless the outlet box is listed for not less than the weight to be supported. The interior of the box shall be marked by the manufacturer to indicate the maximum weight the box shall be permitted to support.

---

### **2020 NEC Article 320**

#### **Armored Cable: Type AC**

##### **320.2 Definition.**

Armored Cable, Type AC. A fabricated assembly of insulated conductors in a flexible interlocked metallic armor. See 320.100.

##### **320.17 Through or Parallel to Framing Members.**

Type AC cable shall be protected in accordance within 300.4...where installed through or parallel to framing members.

##### **320.30 Securing and Supporting.**

(A) General. Type AC cable shall be supported and secured by staples, cable ties listed and identified for securement and support: straps, hangers, or similar fittings; or other approved means designed and installed so as not to damage cable.

(B) Securing. Unless otherwise permitted, Type AC cable shall be secured within 300 mm (12 in.) of every outlet box, junction box, cabinet, or fitting and at intervals not exceeding 1.4 m (4-1/2 ft).

(C) Supporting. Unless otherwise permitted, Type AC cable shall be supported at intervals not exceeding 1.4 m (4-1/2 ft).

Horizontal runs of Type AC cable installed in wooden or metal framing members or similar supporting means shall be considered supported and secured where such support does not exceed 1.4-m (4-1/2-ft) intervals.

##### **320.80 Ampacity.**

The ampacity shall be determined in accordance with 310.15.

[See Fig. 4].

## CODE COMPLIANCE NEC

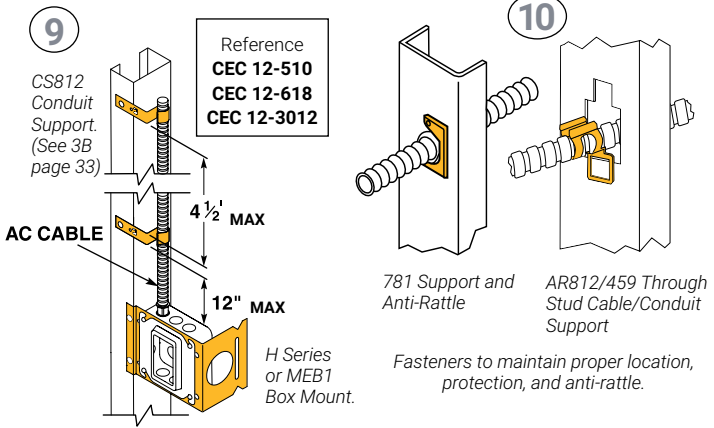

### 2020 NEC Article 330 Metal-Clad Cable: Type MC

#### 330.2 Definition.

Metal Clad Cable, Type MC. A factory assembly of one or more insulated circuit conductors with or without optical fiber members enclosed in an armor of interlocking metal tape, or a smooth or corrugated metallic sheath.

#### 330.17 Through or Parallel to Framing Members.

Type MC cable shall be protected in accordance with 300.4...where installed through or parallel to framing members.

#### 330.30 Securing and Supporting.

(A) General. Type MC cable shall be supported and secured by staples, cable ties listed and identified for securement and support: straps, hangers, or similar fittings; or other approved means designed and installed so as not to damage the cable.

(B) Securing. Unless otherwise provided, cables shall be secured at intervals not exceeding 1.8 m (6 ft). Cables containing four or fewer conductors sized no larger than 10 AWG shall be secured within 300 mm (12 in.) of every box, cabinet, fitting, or other cable termination.

(C) Supporting. Unless otherwise provided, cables shall be supported at intervals not exceeding 1.8 m (6-ft).

Horizontal runs of Type MC cable installed in wooden or metal framing members or similar supporting means shall be considered supported and secured where such support does not exceed 1.8-m (6-ft) intervals.

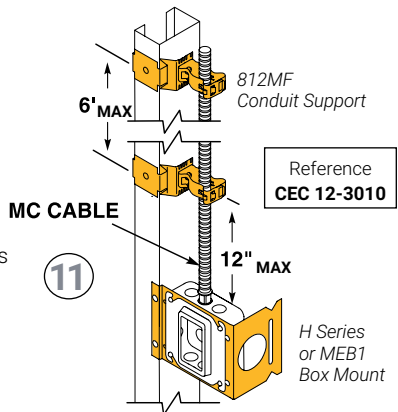

#### 330.80 Ampacity.

The ampacity of Type MC cable shall be determined in accordance with 310.14 or 311.60. [See Fig. 4].

## CODE COMPLIANCE

### NEC

#### 2020 NEC Article 334

#### Nonmetallic-Sheathed Cable: Types NM, NMC, and NMS

##### 334.2 Definition.

**Nonmetallic-Sheathed Cable.** A factory assembly of two or more insulated conductors enclosed within an overall nonmetallic jacket.

##### 334.17 Through or Parallel to Framing Members.

Types NM and NMC cable shall be protected in accordance with 300.4 where installed through or parallel to framing members. Grommets used as required in 300.4(B)(1) shall remain in place and be listed for the purpose of cable protection. [See Fig. 1]

##### 334.30 Securing and Supporting.

Nonmetallic-sheathed cable shall be supported and secured by staples, cable ties listed and identified for securement and support, or straps, hangers, or similar fittings designed and installed so as not to damage the cable, at intervals not exceeding 1.4 m (4-1/2 ft) and within 300 mm (12 in.) of every cable entry into enclosures such as outlet boxes, junction boxes, cabinets, or fittings. The cable length between the cable entry and the closest cable support shall not exceed 450 mm (18 in.).

(A) **Horizontal Runs through Holes and Notches.** In other than vertical runs, cables installed in accordance with 300.4 shall be considered supported and secured where such support does not exceed 1.4 m (4 1/2 ft.) intervals and the nonmetallic sheathed cable is securely fastened in place by an approved means within 300 mm. (12 in.) of each box, cabinet, conduit body, or other nonmetallic sheathed cable termination.

---

#### NEC 2020 Article 342

#### Intermediate Metal Conduit: Type IMC

##### 342.30 Securing and Supporting.

IMC shall be installed as a complete system in accordance with 300.18 and shall be securely fastened in place and supported in accordance with 342.30(A) and (B).

(A) **Securely Fastened.** Each IMC shall be secured in accordance with one of the following:

- (1) IMC shall be securely fastened within 900 mm. (3 ft.) of each outlet box, junction box, device box, cabinet, conduit body, or other conduit termination.
- (2) Where structural members do not readily permit fastening within 900 mm. (3 ft), fastening shall be permitted to be increased to a distance of 1.5 m. (5 ft.).
- (3) Where approved, conduit shall not be required to be securely fastened within 900 mm. (3 ft.) of the service head for above - the - roof termination of a mast.

(B) **Supports.** IMC shall be supported in accordance with one of the following:

- (1) Conduit shall be supported at intervals not exceeding 3 m. (10 ft).  
[See Fig. 13A]
- (2) The distance between supports for straight runs of conduit shall be permitted in accordance with Table 344.30(B)(2), provided the conduit is made up with threaded couplings and such supports prevent transmission of stresses to termination where conduit is deflected between supports.

# CODE COMPLIANCE

## NEC

### NEC 2020 Article 344 Rigid Metal Conduit: Type RMC

#### 344.30 Securing and Supporting.

RMC shall be installed as a complete system in accordance with 300.18 and shall be securely fastened in place and supported in accordance with 344.30(A) and (B).

(A) **Securely Fastened.** RMC shall be securely fastened within 900 mm. (3 ft.) of each outlet box, junction box, device box, cabinet, conduit body, or other conduit termination. Fastening shall be permitted to be increased to a distance of 1.5 m. (5 ft.) where structural members do not readily permit fastening within 900 mm. (3 ft.). Where approved, conduit shall not be required to be securely fastened within 900 mm. (3 ft.) of the service head for above-the-roof termination of a mast. [See Fig. 8A]

(B) **Supports.** RMC shall be supported in accordance with one of the following.

(1) Conduit shall be supported at intervals not exceeding 3 m. (10 ft.).

(2) The distance between supports for straight runs of conduit shall be permitted in accordance with Table 344.30(B)(2), provided the conduit is made up with threaded couplings, and supports that prevent transmission of stresses to termination where conduit is deflected between supports. [See Fig. 12]

nVent CADDY® Pyramid  
Alternative to wood blocks  
for roof top applications.

Reference  
CEC 12-1216

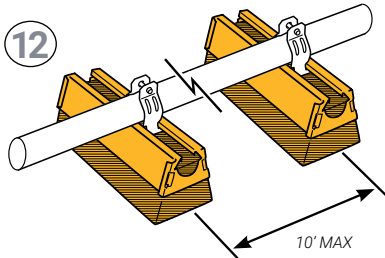

---

### 2020 NEC Article 358 Electrical Metallic Tubing: Type EMT

#### 358.30 Securing and Supporting.

EMT shall be installed as a complete system in accordance with 300.18 and shall be securely fastened in place and supported in accordance with 358.30(A) and (B).



# CODE COMPLIANCE

## NEC

(A) **Securely Fastened.** EMT shall be securely fastened in place at intervals not to exceed 3 m. (10 ft.). In addition, each EMT run between termination points shall be securely fastened within 900 mm. (3 ft.) of each outlet box, junction box, device box, cabinet, conduit body, or other tubing termination. [See Fig. 13A]

(B) **Supports.** Horizontal runs of EMT supported by openings through framing members at intervals not greater than 3 m. (10 ft.) and securely fastened within 900 mm. (3 ft.) of termination points shall be permitted. [See Fig. 13A & 13B]

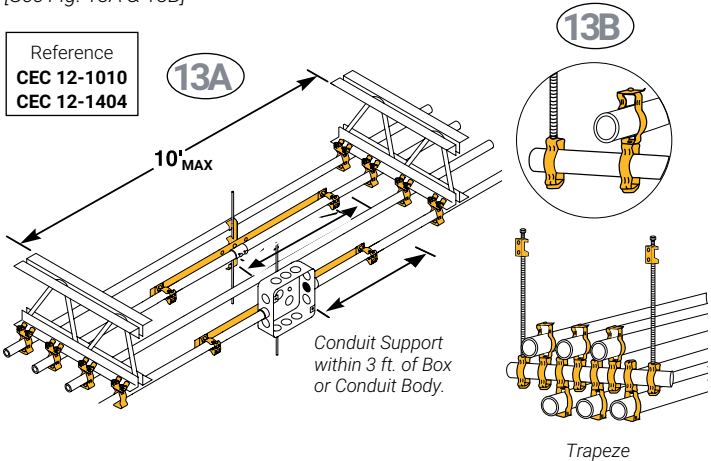

### 2020 NEC Article 362 Electrical Nonmetallic Tubing: Type ENT

#### 362.2 Definition.

Electrical Nonmetallic Tubing (ENT). A nonmetallic pliable corrugated raceway of circular cross section with integral or associated couplings, connectors, and fittings for the installation of electric conductors. ENT is composed of a material that is resistant to moisture and chemical atmospheres and is flame retardant. A pliable raceway is a raceway that can be bent by hand with a reasonable force, but without other assistance.

#### 362.30 Securing and Supporting.

ENT shall be installed as a complete system in accordance with 300.18 and shall be securely fastened in place and supported in accordance with 362.30(A) and (B).

(A) **Securely Fastened.** ENT shall be securely fastened at intervals not exceeding 900 mm. (3 ft.). In addition, ENT shall be securely fastened in place within 900 mm. (3 ft.) of each outlet box, device box, junction box, cabinet, or fitting where it terminates. Where used, cable ties shall be listed as suitable for the application and for securing and supporting. [See Fig. 14]

# CODE COMPLIANCE

## NEC

### 2020 NEC Article 392 Cable Trays

#### 392.1 Scope.

This article covers cable tray systems, including ladder, ventilated trough, ventilated channel, solid bottom, and other similar structures.

#### 392.2 Definition.

**Cable Tray System.** A unit or assembly of units or sections and associated fittings forming a structural system used to securely fasten or support cables and raceways.

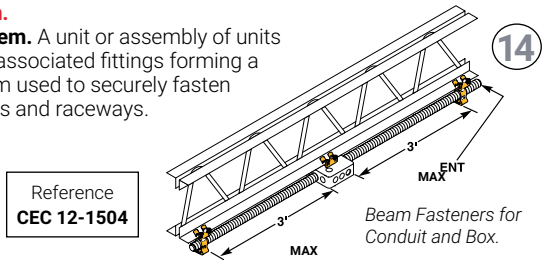

### 2020 NEC Article 410 Luminaires (Lighting Fixtures), Lampholders, and Lamps

#### 410.36 Means of Support.

(A) **Luminaires Supported By Outlet Boxes.** Luminaires shall be permitted to be supported by outlet boxes or fittings installed as required by 314.23. The installation shall comply with the following requirements:

- (1) The outlet boxes or fittings shall comply with 314.27(A)(1) and 314.27(A)(2).
- (2) Luminaires shall be permitted to be supported in accordance with 314.27(E).
- (3) Outlet boxes complying with 314.27(E) shall be considered lighting outlets as required by 210.70(A), (B), and (C).

(B) **Suspended Ceilings.** Suspended Ceilings. Framing members of suspended ceiling systems used to support luminaires shall be securely fastened to each other and shall be securely attached to the building structure at appropriate intervals. Luminaires shall be securely fastened to the ceiling framing member by mechanical means such as bolts, screws, or rivets. Listed clips identified for use with the type of ceiling framing member(s) and luminaire(s) shall also be permitted. [See Fig. 15, 16A, 16B & 17]

Outlet Box  
Not Shown

Reference  
CEC 30-302

15

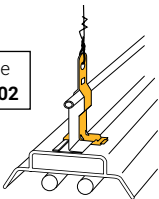

IDS Series Independent Support  
Clip for Surface-mounted Fixture.

16B

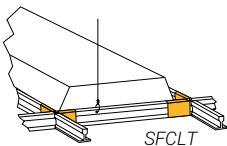

SFCLT

16A

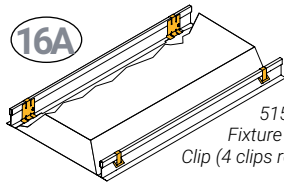

515A Lay-in  
Fixture Retainer  
Clip (4 clips required).

17

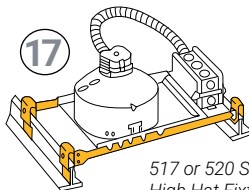

517 or 520 Series  
High Hat Fixture Support

# CODE COMPLIANCE

## NEC

### 410.36 Means of Support. (continued)

[Article 100-Definitions]

**\*Listed.** Equipment, materials, or services included in a list published by an organization that is acceptable to the authority having jurisdiction and concerned with evaluation of products or services, that maintains periodic inspection of production of listed equipment or materials or periodic evaluation of services, and whose listing states that either the equipment, material, or services meets appropriate designated standards or has been tested and found suitable for a specified purpose.

Informational Note: The means for identifying listed equipment may vary for each organization concerned with product evaluation, some of which do not recognize equipment as listed unless it is also labeled. Use of the system employed by the listing organization allows the authority having jurisdiction to identify a listed product.

**410.154 Fastening.** Lighting track shall be securely mounted so that each fastening will be suitable for supporting the maximum weight of luminaires that can be installed. Unless identified for supports at greater intervals, a single section 1.2 m. (4 ft.) or shorter in length shall have two supports, and, where installed in a continuous row, each individual section of not more than 1.2 m. (4 ft.) in length shall have one additional support.  
[See Fig. 18A & 18B]

### 590.4 General.

(J) **Support.** Cable assemblies and flexible cords and cables shall be supported in place at intervals that ensure that they will be protected from physical damage. Support shall be in the form of staples, cable ties, straps, or similar type fittings installed so as not to cause damage. Cable assemblies and flexible cords and cables installed as branch circuits or feeders shall not be installed on the floor or on the ground. Extension cords shall not be required to comply with 590.4(J). Vegetation shall not be used for support of overhead spans of branch circuits or feeders.

*Exception: For holiday lighting in accordance with 590.3(B), where the conductors or cables are arranged with strain relief devices, tension take-up devices, or other approved means to avoid damage from the movement of the live vegetation, trees shall be permitted to be used for support of overhead spans of branch circuit conductors or cables.*

### 604.7 Construction.

**Installation.** Manufactured wiring systems shall be secured and supported in accordance with the applicable cable or conduit article for the cable or conduit type employed.

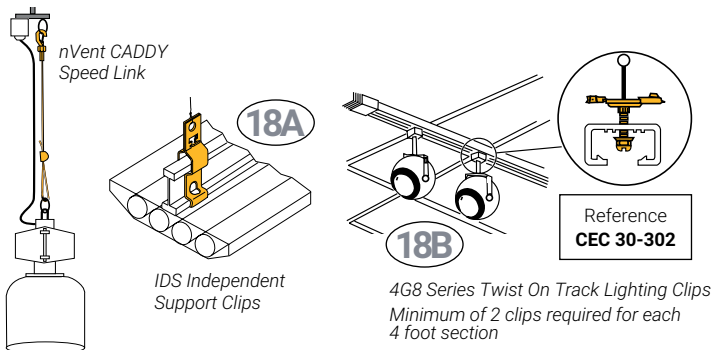

## CODE COMPLIANCE

### NEC

#### **NEC 2020 Article 725**

#### **Class 1, Class 2, and Class 3 Remote Control, Signaling, and Power-Limited Circuits**

##### **725.24 Mechanical Execution of Work.**

Class 1, Class 2, and Class 3 circuits shall be installed in a neat and workmanlike manner. Cables and conductors installed exposed on the surface of ceilings and sidewalls shall be supported by the building structure in such a manner that the cable will not be damaged by normal building use. Such cables shall be supported by straps, staples, hangers, cable ties, or similar fittings designed and installed so as not to damage the cable. The installation shall also conform with 300.4(D).

---

#### **NEC 2020 Article 760**

#### **Fire Alarms**

##### **760.24 Mechanical Execution of Work.**

(A) General. Fire alarm circuits shall be installed in a neat workmanlike manner. Cables and conductors installed exposed on the surface of ceilings and sidewalls shall be supported by the building structure in such a manner that the cable will not be damaged by normal building use. Such cables shall be supported by straps, staples, cable ties, hangers, or similar fittings designed and installed so as not to damage the cable. The installation shall also conform with 300.4(D).

(B) Circuit Integrity (CI) Cable. Circuit Integrity (CI) cables shall be supported at a distance not exceeding 610mm (24 in.). Where located within 2.1m (7 ft) of the floor, as covered in 760.53(A)(1) and 760.130(B)(1), as applicable, the cable shall be fastened in an approved manner at intervals of not more than 450mm (18 in.). Cable supports and fasteners shall be steel.

---

#### **NEC 2020 Article 770**

#### **Optical Fiber Cables and Raceways**

##### **770.24 Mechanical Execution of Work.**

Optical fiber cables shall be installed in a neat and workmanlike manner. Cables installed exposed on the surface of ceilings and sidewalls shall be supported by the building structure in such a manner that the cable will not be damaged by normal building use. Such cables shall be secured by hardware, including straps, staples, cable ties, hangers, or similar fittings, designed and installed so as not to damage the cable. The installation shall also conform to 300.4 and 300.11. Nonmetallic cable ties and other nonmetallic cable accessories used to secure and support cables in other spaces used for environmental air (plenums) shall be listed as having low smoke and heat release properties in accordance with 300.22(C).

Informational Note No. 1: Accepted industry practices are described in ANSI/NECA/FOA 301-2016, Standard for Installing and Testing Fiber Optic Cables; ANSI/TIA-568.0-D-2015, Generic Telecommunications Cabling for Customer Premises; and ANSI/TIA 568.3-D-2016, Optical Fiber Cabling and Components Standard.

# CODE COMPLIANCE

## NEC

### NEC 2020 Article 800 Communications Circuits

#### 800.24 Mechanical Execution of Work.

Circuits and equipment shall be installed in a neat and workmanlike manner. Cables installed exposed on the surface of ceilings and sidewalls shall be supported by the building structure in such a manner that the cable will not be damaged by normal building use. Such cables shall be secured by hardware, including straps, staples, cable ties, hangers, or similar fittings, designed and installed so as not to damage the cable. The installation shall also conform to 300.4 and 300.11. Nonmetallic cable ties and other nonmetallic cable accessories used to secure and support cable in other spaces used for environmental air (plenums) shall be listed as having low smoke and heat release properties in accordance with 805.170(C).

Informational Note No. 1: Accepted industry practices are described in ANSI/NECA/BICSI 568-2006, Standard for Installing Commercial Building Telecommunications Cabling; ANSI/TIA-568.1-D-2015, Commercial Building Telecommunications Infrastructure Standard; ANSI/TIA-569-D-2015, Telecommunications Pathways and Spaces; ANSI/TIA-570-C-2012, Residential Telecommunications Infrastructure Standard; ANSI/TIA-1005-A-2012, Telecommunications Infrastructure Standard for Industrial Premises; ANSI/TIA-1179-2010, Healthcare Facility Telecommunications Infrastructure Standard; ANSI/TIA-4966-2020, Telecommunications Infrastructure Standard for Educational Facilities; and other ANSI-approved installation standards.

#### 800.154 Applications of Listed Communications Wires, Cables and Raceways, and Listed Cable Routing Assemblies.

Permitted and nonpermitted applications of listed communications wires, cables, and raceways, and listed cable routing assemblies, shall be as indicated in Table 800-154(a), (b), (c). The permitted applications shall be subject to the installation requirements of 800-110 and 800-113.

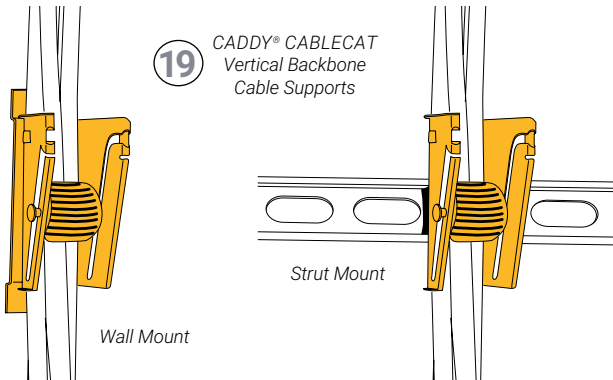

## Commentary from ERICO

Article 300-11 has resulted in more phone calls to nVent CADDY than ever regarding code compliance. As a result we have discussed the code with electricians and inspectors from coast to coast. The following is a summation of these conversations. Always check with your local inspectors prior to installation.

### Additional Drop-Wire and Drop-Rod Supports:

Although wiring can no longer be attached to drop wires/rods that support the suspended ceiling, additional dedicated wires/rods can be dropped separately to support wiring assembly. These drop wires/rods shall be properly secured (anchored) at both ends.

**Fig. 20** EC311 Independent Electrical Drop-Wire Securing Clip attaches to the ceiling grid. Its bright yellow color allows it to be distinguished from ceiling wires and easily identified by inspectors.

**Fig. 21** In case of a fire emergency in which the ceiling grid may be torn down, nVent CADDY recommends the use of a clip that will release without stress on the electrical system.

**Fig. 22** B18 Series: Using B18 series will reduce the number of drop wires needed. B18 series supports conduit on either side of a junction box. Holes in opposite ends of 18" bar accommodate 812M, 16M, 8P, 12P (etc.) conduit clips. A center hole accepts M24S, 4Z34, 6Z34 fasteners for attachment to threaded rod. Also complies with NEC Article 358.30. 2011 code now applies to low voltage cabling [See Fig. 21]

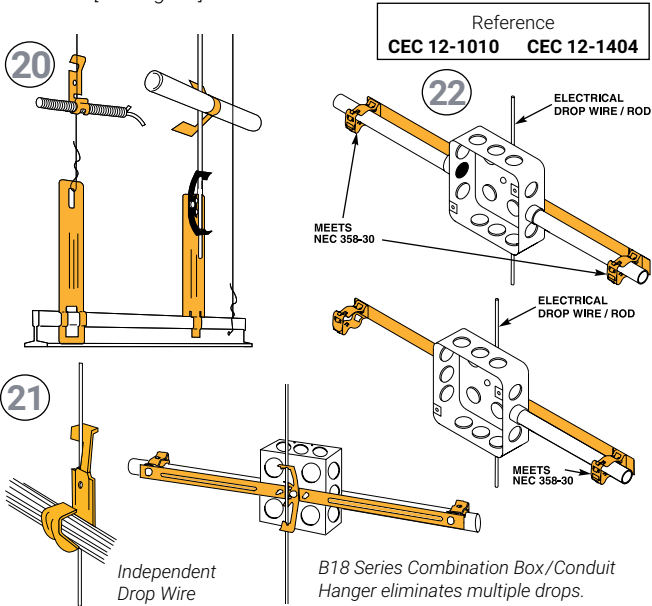

## Commentary (continued)

**Fig. 23** PCS Series: Supports wiring from independent drop wires/ rods. These will support MC/AC, 1/2 in. and 3/4 in. EMT and MC/AC cable. PCS will not bend the drop wire/rod, and is 25% faster to install than other methods.

**Fig. 24** Trapeze: First attach threaded rods to the support structure with the nVent CADDY BC Series. Then, support the trapeze by using nVent CADDY 16M4I series light weight trapeze clips. Use back-to-back M series to support 3/8 in. MC/AC cable through 1 in. conduits.

**Fig. 25 and 26** For purlin applications: AF14 or VF14 series is designed for "C" [Fig. 23] or "Z" [Fig. 24] purlin that fits flanges from 1/16 in. to 1/4 in. There is a special tool, VAFT, designed for installing these fasteners from the ground - eliminating the need for ladders.

**Fig. 27** Hammer-on clips can be installed directly to I-beams.

**Fig. 28** Angle brackets are available for hanging plain or threaded rod to support raceway systems.

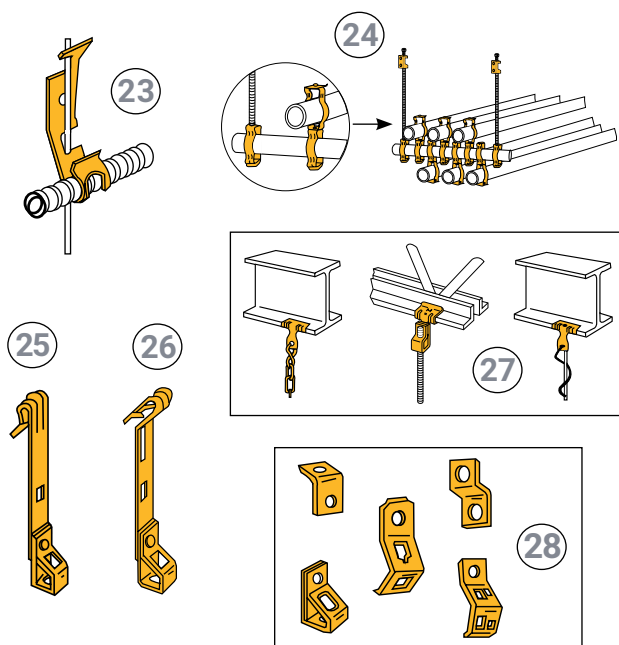

The following NFPA material is reprinted with permission from NFPA 70®-2020, National Electrical Code®, Copyright © 2019, National Fire Protection Association, Quincy, MA. This reprinted material is not the complete and official position of the NFPA on the referenced subject, which is represented only by the standard in its entirety.



# 2018 CANADIAN ELECTRICAL CODE

## CEC 2018 Section 12 Wiring Methods

### Nonmetallic Sheathed Cable

#### 12-510 Running of Cable Between Boxes and Fittings

- (1) Where the cable is run between boxes and fittings, it shall be supported by straps or other devices located within 300 mm. of every box or fitting and at intervals of not more than 1.5 m. throughout the run. [See Fig. 8A & 9]

#### 12-516 Protection for Cable in Concealed Installations

- (1) Where the cable is run through studs, joists, or similar members, the outer surfaces of the cable shall be kept to a distant of at least 32 mm. from the edges of the members or the cable shall be effectively protected from mechanical injury. [See Fig. 2]
- (2) Where the cable is run through or along metal studs, joists, sheathing, or cladding, it shall be:
  - (b) Protected where it passes through a member by an insert approved for the purpose and adequately secured in place; and [See Fig. 1]
- (3) Where the cable is installed immediately behind a baseboard, it shall be effectively protected from mechanical injury from driven nails. [See Fig. 2]

### Armoured Cable

#### 12-616 Concealed Armoured Cable Installation

- (1) Where armoured cable is run through studs, joists, or other members, the outer surfaces of the cable shall be:
  - (a) Located so that the outer circumference is at least 32 mm. from the nearest edge of the members; or
  - (b) Protected from mechanical injury where it passes through the holes in the members. [See Fig. 1 & 2]
- (2) Where armoured cable is installed immediately behind baseboards, it shall be protected from mechanical injury from driven nails. [See Fig. 2]

#### 12-618 Running of Cable Between Boxes, Etc.

Armoured cable shall be supported between boxes and fittings in accordance with Rule 12-510. [See Fig. 1, 8A & 9]

### Rigid and Flexible Metal Conduit

#### 12-1010 Maximum Spacing of Conduit Supports

- (1) All rigid metal conduit of one size shall be securely attached to hangers or to a solid surface with the maximum spacings of the points of support not greater than:
  - (a) 1.5 m. for 16 and 21 trade size conduit;
  - (b) 2 m. for 27 and 35 trade size conduit; and
  - (c) 3 m. for 41 trade size conduit and larger.
- (2) Where rigid metal conduits of mixed sizes are run in a group, the conduit supports shall be arranged so that the maximum support spacing will be that shown in Subrule (1) for the smallest conduit.
- (3) When flexible metal conduit is installed, it shall be secured at intervals not exceeding 1.5 m. and within 300 mm. on each side of every outlet box or fitting except where flexible metal conduit is fished and except for lengths of not over 900 mm. at terminals where flexibility is necessary. [See Fig. 8A, 8B, 8C, 13A & 22]

# 2018 CANADIAN ELECTRICAL CODE

## Rigid RTRC Conduit

### 12-1216 Conduit Supports

Where rigid RTRC conduit Type AG is run in accordance with Rule 12-1202(2) it shall be supported with hangers or clamps:

- (a) In such a manner as to permit adequate linear movement to allow for expansion and contraction due to temperature change; and
- (b) With spacings of the supports not greater than permitted by Rule 12-1010. [See Fig. 12]

## Electrical Metallic Tubing

### 12-1406 Supports

Electrical metallic tubing shall be installed as a complete system and shall be securely fastened in place within 1 m of each outlet box, junction box, cabinet, or fitting, and the spacing between supports shall be in accordance with Rule 12-1010. [See Fig. 8A, 8B, 8C, 13A, 13B & 22]

## Electrical Non-Metallic Tubing

### 12-1504 Supports

Electrical nonmetallic tubing shall be securely fastened in place within 1 m. of each outlet box, junction box, cabinet, coupling or fitting, and the spacing between supports shall be not more than 1 m. [See Fig. 14]

## Installations of Boxes, Cabinets, Outlets, and Terminal Fittings

### 12-3010 Outlet box Supports

- (1) Except as permitted by Subrule (6), boxes and fittings shall be firmly secured to studs, joists, or similar fixed structural units other than wooden, metal, or composition lath, in accordance with this Rule.
- (4) Where boxes are mounted on metal studs, additional support shall be provided to prevent movement of the box after the drywall is installed. [See Fig. 9 & 11]

---

## CEC 2018 Section 30 Installation of Lighting Equipment

### 30-302 Supports

- (1) Every luminaire shall be securely supported. [See Fig. 7A, 7B, 15, 16A, 18A & 18B]
- (3) Where the weight of a luminaire does not exceed 13 kg., the luminaire shall be permitted to be supported by a wall outlet box attached directly to the building structure or by a wall outlet box attached to a bar hanger. [See Fig. 7A]
- (4) Where the weight of a luminaire does not exceed 23 kg., the luminaire shall be permitted to be supported by a ceiling outlet box attached directly to the building structure or by a ceiling outlet box attached to a bar hanger. [See Fig. 7B & 16A]

With the permission of the Canadian Standards Association (operating as CSA Group), material is reproduced from CSA Group standard C22.1-12 - Canadian electrical code, part I (22nd edition), safety standard for electrical installations, which is copyrighted by CSA Group, 178 Rexdale Blvd., Toronto, ON, M9W1R3. This material is not the complete and official position of CSA Group on the referenced subject, which is represented solely by the standard in its entirety. While use of the material has been authorized, CSA Group is not responsible for the manner in which the data is presented, nor for any interpretations thereof.

## Cable/Conduit



## CABLE/CONDUIT

### Beam

#### BC200-CD CONDUIT TO BEAM CLAMP

- Eliminates offset bending conduit
- Threaded hole on back
- Ideal for electrical, mechanical, and HVAC applications



Material: Steel  
Finish: Electrogalvanized



Part #	Description	F ↓	☐
BC200CD0B	1/2" EMT, 1/2" Rigid, 1/2" Max Flange	100 lb	50 pc
BC200CD1B	3/4" EMT, 3/4" Rigid, 1/2" Max Flange	100 lb	50 pc
BC200CD2B	1" EMT, 1" Rigid, 1/2" Max Flange	100 lb	50 pc
BC200CD2.5B	1 1/4" EMT, 1/2" Max Flange	100 lb	50 pc
BC200CD3B	1 1/2" EMT, 1 1/4" Rigid, 1/2" Max Flange	100 lb	50 pc
BC200CD4B	1 1/2" Rigid, 1/2" Max Flange	100 lb	25 pc
BC200CD5B	2" EMT, 2" Rigid, 1/2" Max Flange	100 lb	25 pc

#### RA RIGHT ANGLE PIPE AND CONDUIT CLAMP

- Fix pipe or conduit perpendicular to a beam



Material: Cast Iron  
Finish: Hot-Dip Galvanized

Part #	Description	F ↓	☐
RA0050HD	1/2" Rigid, 1/2" Pipe, 3/4" Max Flange	250 lb	25 pc
RA0075HD	3/4" Rigid, 3/4" Pipe, 3/4" Max Flange	300 lb	25 pc
RA0100HD	1" Rigid, 1" Pipe, 3/4" Max Flange	400 lb	25 pc
RA0125HD	1 1/4" Rigid, 1 1/4" Pipe, 3/4" Max Flange	400 lb	25 pc
RA0150HD	1 1/2" Rigid, 1 1/2" Pipe, 3/4" Max Flange	500 lb	20 pc
RA0200HD	2" Rigid, 2" Pipe, 3/4" Max Flange	600 lb	20 pc

# CABLE/CONDUIT

## Beam

### PAR PARALLEL PIPE AND CONDUIT CLAMP

- Fix pipe or conduit parallel to a beam



Material: Cast Iron  
Finish: Hot-Dip Galvanized



Part #	Description	
PAR0050HD	1/2" Pipe, 3/4" Max Flange	25 pc
PAR0075HD	3/4" Pipe, 3/4" Max Flange	25 pc
PAR0100HD	1" Pipe, 3/4" Max Flange	25 pc
PAR0125HD	1 1/4" Pipe, 3/4" Max Flange	25 pc
PAR0150HD	1 1/2" Pipe, 3/4" Max Flange	25 pc
PAR0200HD	2" Pipe, 3/4" Max Flange	20 pc

### EM-P CONDUIT TO FLANGE CLIP

- Requires only a hammer to install
- Available for EMT, rigid, IMT and aluminum conduit
- Will pivot thru 360°



Material: Spring Steel  
Finish: nVent CADDY Armour

Part #	Description		
8P24	1/2" EMT, 0.709"-0.866" OD, 1/8"-1/4" Flange	25 lb	100 pc
8P58	1/2" EMT, 0.709"-0.866" OD, 5/16"-1/2" Flange	25 lb	100 pc
8P912	1/2" EMT, 0.709"-0.866" OD, 9/16"-3/4" Flange	25 lb	50 pc
12P24	3/4" EMT, 1/2" Rigid, 0.866"-1.181" OD, 1/8"-1/4" Flange	25 lb	100 pc
12P58	3/4" EMT, 1/2" Rigid, 0.866"-1.181" OD, 5/16"-1/2" Flange	25 lb	100 pc
12P912	3/4" EMT, 1/2" Rigid, 0.866"-1.181" OD, 9/16"-3/4" Flange	25 lb	100 pc
16P24	1" EMT, 3/4" Rigid, 1.181"-1.378" OD, 1/8"-1/4" Flange	25 lb	100 pc
16P58	1" EMT, 3/4" Rigid, 1.181"-1.378" OD, 5/16"-1/2" Flange	25 lb	50 pc
16P912	1" EMT, 3/4" Rigid, 1.181"-1.378" OD, 9/16"-3/4" Flange	25 lb	50 pc

# CABLE/CONDUIT

## Beam

### H-PSM CONDUIT TO FLANGE CLIP, SIDE MOUNT

- Requires only a hammer to install
- Available for EMT, rigid and aluminum conduit
- Will pivot thru 360°



Orientation: Side Mount  
Material: Spring Steel  
Finish: nVent CADDY Armour

Part #	Description	F	
8P24SM	1/2" EMT, 0.709"-0.866" OD, 0.125"-0.25" Flange	25 lb	100 pc
8P58SM	1/2" EMT, 0.709"-0.866" OD, 0.3125"-0.5" Flange	25 lb	100 pc
8P912SM	1/2" EMT, 0.709"-0.866" OD, 0.5625"-0.75" Flange	25 lb	100 pc
12P24SM	3/4" EMT, 0.866"-1.181" OD, 0.125"-0.25" Flange	25 lb	100 pc
12P58SM	3/4" EMT, 0.866"-1.181" OD, 0.3125"-0.5" Flange	25 lb	100 pc
12P912SM	3/4" EMT, 0.866"-1.181" OD, 0.5625"-0.75" Flange	25 lb	50 pc
16P24SM	1" EMT, 1.181"-1.378" OD, 0.125"-0.25" Flange	25 lb	100 pc
16P58SM	1" EMT, 1.181"-1.378" OD, 0.3125"-0.5" Flange	25 lb	100 pc
16P912SM	1" EMT, 1.181"-1.378" OD, 0.5625"-0.75" Flange	25 lb	50 pc

# CABLE/CONDUIT Beam

## BC-P CONDUIT TO BEAM CLAMP

- Easy installation to beam flanges
- Eliminates offset bending conduit



Material: Spring Steel  
Finish: nVent CADDY Armour

Part #	Description	F ↓	☐
BC8P	1/2" EMT, 0.5" Max Flange	25 lb	100 pc
BC12P	3/4" EMT, 1/2" Rigid, 0.5" Max Flange	25 lb	100 pc
BC16P	1" EMT, 3/4" Rigid, 1.181"–1.378" OD, 0.5" Max Flange	25 lb	100 pc

## BC-PSM CONDUIT TO BEAM CLAMP

- Easy installation to beam flanges
- Eliminates offset bending conduit



Material: Spring Steel  
Finish: nVent CADDY Armour

Part #	Description	☐
BC8PSM	1/2" EMT, 0.5" Max Flange	100 pc
BC12PSM	3/4" EMT, 0.5" Max Flange	100 pc
BC16PSM	1" EMT, 0.5" Max Flange	100 pc



## CABLE/CONDUIT

### Beam

#### EM-M CONDUIT/PIPE TO FLANGE CLIP

- Supports conduit/pipe or cable from beam flanges
- Snap close clip pivots a full 360°
- Requires only a hammer to install



Material: Spring Steel  
Finish: nVent CADDY Armour



Part #	Description	F ↓	☐
812M1318	1/2", 3/4" EMT, 13/16"-1 1/8" Flange	75 lb	50 pc
812M24	1/2", 3/4" EMT, 1/8"-1/4" Flange	75 lb	100 pc
812M58	1/2", 3/4" EMT, 5/16"-1/2" Flange	75 lb	100 pc
812M912	1/2", 3/4" EMT, 9/16"-3/4" Flange	75 lb	50 pc
16M24	1" EMT, 1/8"-1/4" Flange	75 lb	100 pc
16M58	1" EMT, 5/16"-1/2" Flange	75 lb	100 pc
16M912	1" EMT, 9/16"-3/4" Flange	75 lb	50 pc
20M24	1 1/4" EMT, 1/8"-1/4" Flange	75 lb	50 pc
20M58	1 1/4" EMT, 5/16"-1/2" Flange	75 lb	50 pc
20M912	1 1/4" EMT, 9/16"-3/4" Flange	75 lb	50 pc
24M24	1 1/2" EMT, 1/8"-1/4" Flange	75 lb	50 pc
24M58	1 1/2" EMT, 5/16"-1/2" Flange	75 lb	50 pc
24M912	1 1/2" EMT, 9/16"-3/4" Flange	75 lb	50 pc
32M24	2" EMT, 1/8"-1/4" Flange	75 lb	50 pc
32M58	2" EMT, 5/16"-1/2" Flange	75 lb	50 pc
32M912	2" EMT, 9/16"-3/4" Flange	75 lb	50 pc
6M24	14-2 to 12-3 MC/AC, 1/8"-1/4" Flange	75 lb	100 pc
6M58	14-2 to 12-3 MC/AC, 5/16"-1/2" Flange	75 lb	100 pc
6M912	14-2 to 12-3 MC/AC, 9/16"-3/4" Flange	75 lb	100 pc

\* Please refer to [nVent.com/CADDY](http://nVent.com/CADDY) for UL listings

# CABLE/CONDUIT Beam

## EM-MR CONDUIT TO FLANGE CLIP WITH RETAINER

- Only one piece to install
- Fast hammer-on installation
- Pre-riveted retainer strap is easily bent into position



Material: Spring Steel  
Finish: nVent CADDY Armour

Part #	EMT Conduit Size	Flange Thickness	Length	F ↓	☐
CM24812M	1/2", 3/4"	1/8" – 1/4"	7.85	75 lb	50 pc
CM58812M	1/2", 3/4"	5/16" – 1/2"	7.85	75 lb	50 pc
CM912812M	1/2", 3/4"	9/16" – 3/4"	7.85	75 lb	50 pc
CM2416M	1"	1/8" – 1/4"	13.00	75 lb	50 pc
CM5816M	1"	5/16" – 1/2"	13.00	75 lb	50 pc
CM91216M	1"	9/16" – 3/4"	13.00	75 lb	50 pc

# CABLE/CONDUIT

## Beam

### H-MSM CONDUIT/PIPE TO FLANGE CLIP, SIDE MOUNT

- Supports conduit/pipe or cable from beam flanges
- Snap close clip pivots a full 360°
- Requires only a hammer to install



Material: Spring Steel  
Finish: nVent CADDY Armour



Part #	Description	F ↓	↓
812M24SM	1/2", 3/4" EMT, 1/8"-1/4" Flange	25 lb	100 pc
812M58SM	1/2", 3/4" EMT, 5/16"-1/2" Flange	25 lb	100 pc
812M912SM	1/2", 3/4" EMT, 9/16"-3/4" Flange	25 lb	100 pc
16M24SM	1" EMT, 1/8"-1/4" Flange	25 lb	100 pc
16M58SM	1" EMT, 5/16"-1/2" Flange	25 lb	100 pc
16M912SM	1" EMT, 9/16"-3/4" Flange	25 lb	50 pc
20M24SM	1 1/4" EMT, 1/8"-1/4" Flange	25 lb	100 pc
20M58SM	1 1/4" EMT, 5/16"-1/2" Flange	25 lb	100 pc
20M912SM	1 1/4" EMT, 9/16"-3/4" Flange	25 lb	100 pc
24M24SM	1 1/2" EMT, 1/8"-1/4" Flange	25 lb	50 pc
24M58SM	1 1/2" EMT, 5/16"-1/2" Flange	25 lb	50 pc
24M912SM	1 1/2" EMT, 9/16"-3/4" Flange	25 lb	50 pc
32M24SM	2" EMT, 1/8"-1/4" Flange	25 lb	50 pc
32M58SM	2" EMT, 5/16"-1/2" Flange	25 lb	50 pc
32M912SM	2" EMT, 9/16"-3/4" Flange	25 lb	50 pc
6M24SM	14-2 to 12-3 MC/AC, 1/8"-1/4" Flange	25 lb	100 pc
6M58SM	14-2 to 12-3 MC/AC, 5/16"-1/2" Flange	25 lb	100 pc
6M912SM	14-2 to 12-3 MC/AC, 9/16"-3/4" Flange	25 lb	100 pc

\* Please refer to [nVent.com/CADDY](http://nVent.com/CADDY) for UL listings

# CABLE/CONDUIT

## Beam

### H-MSMR CONDUIT TO FLANGE CLIP WITH RETAINER, SIDE MOUNT

- Only one piece to install
- Fast hammer-on installation
- Pre-riveted retainer strap is easily bent into position
- Lightweight design



Material: Spring Steel  
Finish: nVent CADDY Armour

Part #	Description	F ↓	☐
C24812SM	1/2", 3/4" EMT, 1/8"-1/4" Flange	25 lb	50 pc
C58812SM	1/2", 3/4" EMT, 5/16"-1/2" Flange	25 lb	50 pc
C912812SM	1/2", 3/4" EMT, 9/16"-3/4" Flange	25 lb	50 pc
C2416SM	1" EMT, 1/8"-1/4" Flange	25 lb	50 pc
C5816SM	1" EMT, 5/16"-1/2" Flange	25 lb	50 pc
C91216SM	1" EMT, 9/16"-3/4" Flange	25 lb	50 pc

### BC-M CONDUIT TO BEAM CLAMP

- Easy installation to beam flanges
- Eliminates offset bending conduit
- Conduit clip rotates 360 degrees



Material: Spring Steel  
Finish: nVent CADDY Armour



Part #	Description	F ↓	☐
BC812M	1/2", 3/4" EMT, 1/2", 3/4" Rigid/Pipe, 0.709"-1.181" OD, 0.5" Max Flange	100 lb	100 pc
BC16M	1" EMT, 1" Rigid/Pipe, 0.5" Max Flange	100 lb	100 pc
BC20M	1 1/4" EMT, 1 1/4" Rigid/Pipe, 0.5" Max Flange	100 lb	100 pc
BC24M	1 1/2" EMT, 1 1/2" Rigid/Pipe, 0.5" Max Flange	100 lb	50 pc
BC32M	2" EMT, 2" Rigid/Pipe, 0.5" Max Flange	100 lb	50 pc

## CABLE/CONDUIT

### Beam

#### BC-MSM CONDUIT TO BEAM CLAMP, SIDE MOUNT

- Easy installation to beam flanges
- Eliminates offset bending conduit
- Conduit clip rotates 360 degrees



Material: Spring Steel  
Finish: nVent CADDY Armour



Part #	Description	F ↓	↓ ↓
BC812MSM	1/2", 3/4" EMT, 1/2", 3/4" Rigid/Pipe, 0.709"-1.181" OD, 0.5" Max Flange	25 lb	100 pc
BC16MSM	1" EMT, 1" Rigid/Pipe, 0.5" Max Flange	25 lb	100 pc
BC20MSM	1 1/4" EMT, 1 1/4" Rigid/Pipe, 0.5" Max Flange	25 lb	100 pc
BC24MSM	1 1/2" EMT, 1 1/2" Rigid/Pipe, 0.5" Max Flange	25 lb	50 pc
BC32MSM	2" EMT, 2" Rigid/Pipe, 0.5" Max Flange	25 lb	50 pc

# CABLE/CONDUIT

## Beam

### CABLE SNAP CLIP

- Clip snaps on flange and cable snaps into clip



Material: Spring Steel  
Finish: nVent CADDY Armour

Part #	Description	
SC2A	1/16"–3/16" Flange, 0.236"–0.276" OD	100 pc
SC2B	1/16"–3/16" Flange, 0.315"–0.354" OD	100 pc
SC2C	1/16"–3/16" Flange, 0.394"–0.433" OD	100 pc
SC2D	1/16"–3/16" Flange, 0.472"–0.551" OD	100 pc
SC2E	1/16"–3/16" Flange, 0.591"–0.709" OD	100 pc
SC2F	1/16"–3/16" Flange, 0.748"–0.945" OD	100 pc
SC2G	1/16"–3/16" Flange, 0.984"–1.26" OD	100 pc
SC4A	3/16"–9/32" Flange, 0.236"–0.276" OD	100 pc
SC4B	3/16"–9/32" Flange, 0.315"–0.354" OD	100 pc
SC4C	3/16"–9/32" Flange, 0.394"–0.433" OD	100 pc
SC4D	3/16"–9/32" Flange, 0.472"–0.551" OD	100 pc
SC4E	3/16"–9/32" Flange, 0.591"–0.709" OD	100 pc
SC4F	3/16"–9/32" Flange, 0.748"–0.945" OD	100 pc
SC4G	3/16"–9/32" Flange, 0.984"–1.26" OD	100 pc
SC8A	5/16"–1/2" Flange, 0.236"–0.276" OD	100 pc
SC8B	5/16"–1/2" Flange, 0.315"–0.354" OD	100 pc
SC8C	5/16"–1/2" Flange, 0.394"–0.433" OD	100 pc
SC8D	5/16"–1/2" Flange, 0.472"–0.551" OD	100 pc
SC8E	5/16"–1/2" Flange, 0.591"–0.709" OD	100 pc
SC8F	5/16"–1/2" Flange, 0.748"–0.945" OD	100 pc
SC8G	5/16"–1/2" Flange, 0.984"–1.26" OD	100 pc

## CABLE/CONDUIT

### Beam

#### SOLAR SNAP CLIP

- Supports up to two transmission cables on solar arrays
- Mounts in four orientations
- Flared edges to protect cable
- Gripping tab provides a secure fit to the frame

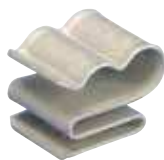

Material: Spring Steel  
Finish: nVent CADDY Armour

Part #	Description	
SCSOL1A	1/16"–5/64" Flange, 0.196"–0.275" OD	100 pc

#### MC/AC CABLE TO FLANGE CLIP, BOTTOM MOUNT

- Compliant with NEC® Article 300.4(d), allowing cable to be positioned a minimum of 1-1/4" from face of stud
- Compliant with CEC Rule 12-618 for support of MC/AC cable



Material: Spring Steel  
Finish: nVent CADDY Armour



Part #	Description	
MAC224	1/8"–1/4" Flange, 14-2 to 10-3 MC/AC	100 pc
MAC258	5/16"–1/2" Flange, 14-2 to 10-3 MC/AC	100 pc
MAC2912	9/16"–3/4" Flange, 14-2 to 10-3 MC/AC	100 pc

Assemblies allow for support from most main and substructures.

# CABLE/CONDUIT

## Beam

### MC/AC CABLE TO FLANGE CLIP, SIDE MOUNT

- No tools required for installation
- Compliant with NEC® Article 300.4(d), allowing cable to be positioned a minimum of 1-1/4" from face of stud
- Compliant with CEC Rule 12-618 for support of MC/AC cable



Material: Spring Steel  
Finish: nVent CADDY Armour



Part #	Description	
MAC224SM	1/8"–1/4" Flange, 14-2 to 10-3 MC/AC	100 pc
MAC258SM	5/16"–1/2" Flange, 14-2 to 10-3 MC/AC	100 pc
MAC2912SM	9/16"–3/4" Flange, 14-2 to 10-3 MC/AC	100 pc

Assemblies allow for support from most main and substructures.

### MC/AC CABLE TO BEAM CLAMP

- Compliant with NEC® Article 300.4(d), allowing cable to be positioned a minimum of 1-1/4" from face of stud
- Compliant with CEC Rule 12-618 for support of MC/AC cable



Material: Spring Steel  
Finish: nVent CADDY Armour



Part #	Description	
MAC2BC	1/8"–1/2" Flange, 14-2 to 10-3 MC/AC	100 pc

Assemblies allow for support from most main and substructures.



## CABLE/CONDUIT

### Beam

#### MC/AC CABLE SUPPORT BRACKET WITH FLANGE CLIP

- Neatly isolates, supports and secures MC/AC cables
- Properly spaces MC/AC cable to help eliminate bundling and NEC® & CEC derating issues
- Results in a “neat and workmanlike” installation



Material: Steel  
Finish: Electrogalvanized



Part #	Description	
Isolated Ground Cable Size: 12-3 to 8-2 MC/AC Cable Size: 10-3 to 8-3 Super Neutral Cable Size: 12-3 to 10-2:		
MCS10124	10-3 to 8-3 MC/AC, 7 Cable, 1/8"–1/4" Flange	25 pc
MCS10158	10-3 to 8-3 MC/AC, 7 Cable, 5/16"–1/2" Flange	25 pc
MCS101912	10-3 to 8-3 MC/AC, 7 Cable, 9/16"–3/4" Flange	25 pc
MC/AC Cable Size: 14-3 to 10-2 Super Neutral Cable Size: 10-2		
MCS5024	14-3 to 10-2 MC/AC, 4 Cable, 1/8"–1/4" Flange	25 pc
MCS5058	14-3 to 10-2 MC/AC, 4 Cable, 5/16"–1/2" Flange	25 pc
MCS50912	14-3 to 10-2 MC/AC, 4 Cable, 9/16"–3/4" Flange	25 pc
MCS10024	14-3 to 10-2 MC/AC, 8 Cable, 1/8"–1/4" Flange	25 pc
MCS10058	14-3 to 10-2 MC/AC, 8 Cable, 5/16"–1/2" Flange	25 pc
MCS100912	14-3 to 10-2 MC/AC, 8 Cable, 9/16"–3/4" Flange	25 pc

#### MC/AC CABLE SUPPORT BRACKET WITH BEAM CLAMP

- Neatly isolates, supports and secures MC/AC cables
- Properly spaces MC/AC cable to help eliminate bundling and NEC® & CEC derating issues
- Results in a “neat and workmanlike” installation



Material: Steel  
Finish: Electrogalvanized



Part #	Description	
Isolated Ground Cable Size: 12-3 to 8-2 MC/AC Cable Size: 10-3 to 8-3 Super Neutral Cable Size: 12-3 to 10-2:		
MCS101BC200	10-3 to 8-3 MC/AC, 7 Cable, 1/8"–5/8" Flange	25 pc
MC/AC Cable Size: 14-3 to 10-2 Super Neutral Cable Size: 10-2		
MCS50BC200	14-3 to 10-2 MC/AC, 4 Cable, 1/8"–5/8" Flange	25 pc
MCS100BC200	14-3 to 10-2 MC/AC, 8 Cable, 1/8"–5/8" Flange	25 pc

# CABLE/CONDUIT

## Beam

### MC/AC CABLE SUPPORT BRACKET WITH SPRING STEEL BEAM CLAMP

- Neatly isolates, supports and secures MC/AC cables
- Properly spaces MC/AC cable to help eliminate bundling and NEC® & CEC derating issues
- Results in a “neat and workmanlike” installation



Material: Steel  
Finish: Electrogalvanized

Part #	Description	
Isolated Ground Cable Size: 12-3 to 8-2 MC/AC Cable Size: 10-3 to 8-3 Super Neutral Cable Size: 12-3 to 10-2		
MCS101BC	10-3 to 8-3 MC/AC, 7 Cable, 1/8"–1/2" Flange	50 pc
MC/AC Cable Size: 14-3 to 10-2 Super Neutral Cable Size: 10-2		
MCS50BC	14-3 to 10-2 MC/AC, 4 Cable, 1/8"–1/2" Flange	25 pc
MCS100BC	14-3 to 10-2 MC/AC, 8 Cable, 1/8"–1/2" Flange	25 pc

### NM CABLE TO BEAM CLAMP

- Supports non-metallic sheathed cable with ground wire



Material: Spring Steel  
Finish: nVent CADDY Armour



Part #	Description	
RMXBC	14-2, 12-2 NM, 0.28"–0.32" OD, 1/2" Max Flange	100 pc

Assemblies allow support from most main and substructures.

## CABLE/CONDUIT

### Beam

#### NM CABLE TO FLANGE CLIP

- Supports non-metallic sheathed cable with ground wire



Material: Spring Steel  
Finish: nVent CADDY Armour



Part #	Description	
RMX24	14-2, 12-2 NM, 0.28"–0.32" OD, 1/8"–1/4" Flange	100 pc
RMX58	14-2, 12-2 NM, 0.28"–0.32" OD, 5/16"–1/2" Flange	100 pc

Assemblies allow support from most main and substructures.

#### CABLE RETAINER STRAP WITH FLANGE CLIP

- Fastens cables to top of flange
- Requires only a hammer to install



Material: Spring Steel  
Finish: nVent CADDY Armour

Part #	Description	
4H24ST3	1/8"–1/4" Flange	100 pc
4H58ST3	5/16"–1/2" Flange	100 pc

# CABLE/CONDUIT

## Deck

### SNAP CLOSE CONDUIT/PIPE CLAMP WITH SHOT-FIRE BRACKET

- Eliminates need for offset bending conduit
- Finger closure, no tools required
- Complete with shot-fire bracket and pre-assembled drive pin
- Quickly and easily attaches to concrete, steel or composite metal decking
- Integrated pin installs easily using powder-actuated or single-shot gas-actuated tools
- ICC-ES ESR-2024 evaluation report available for drive pin



Material: Steel, Spring Steel  
Finish: Electrogalvanized, nVent CADDY Armour

Part #	Description	F ↓	☐
6MSF	3/8" Flexible, 14-2 to 12-3 MC/AC	25 lb	50 pc
812MSF	1/2", 3/4" EMT, 1/2", 3/4" Rigid/Pipe	25 lb	50 pc
16MSF	1" EMT, 1" Rigid/Pipe	25 lb	50 pc

### SNAP CLOSE CONDUIT CLAMP WITH Z SHOT-FIRE BRACKET

- Eliminates need for offset bending conduit
- Finger closure, no tools required
- Complete with shot-fire bracket and pre-assembled drive pin
- Quickly and easily attaches to concrete, steel or composite metal decking
- Integrated pin installs easily using powder-actuated or single-shot gas-actuated tools
- ICC-ES ESR-2024 evaluation report available for drive pin



Material: Steel, Spring Steel  
Finish: Electrogalvanized, nVent CADDY Armour

Part #	Description	F ↓	☐
6MZSF	3/8" Flexible, 14-2 to 12-3 MC/AC	100 lb	50 pc
812MZSF	1/2", 3/4" EMT, 1/2", 3/4" Rigid/Pipe	100 lb	50 pc
16MZSF	1" EMT, 1" Rigid/Pipe	100 lb	50 pc

## CABLE/CONDUIT

### Deck

#### PUSH IN CONDUIT CLAMP WITH SHOT-FIRE BRACKET

- Push-in installation of conduit
- Eliminates need for offset bending conduit
- Complete with shot-fire bracket and pre-assembled drive pin
- Quickly and easily attaches to concrete, steel or composite metal decking
- Integrated pin installs easily using powder-actuated or single-shot gas-actuated tools
- ICC-ES ESR-2024 evaluation report available for drive pin



Material: Steel, Spring Steel

Finish: Electrogalvanized, nVent CADDY Armour

Part #	Description	F	
8PSF	1/2" EMT, 0.709"-0.866" OD	15 lb	50 pc
12PSF	3/4" EMT, 0.866"-1.181" OD	15 lb	50 pc
16PSF	1" EMT, 1.181"-1.378" OD	15 lb	50 pc

#### PUSH IN CONDUIT CLAMP WITH Z SHOT-FIRE BRACKET

- Push-in installation of conduit
- Eliminates need for offset bending conduit
- Complete with shot-fire bracket and pre-assembled drive pin
- Quickly and easily attaches to concrete, steel or composite metal decking
- Integrated pin installs easily using powder-actuated or single-shot gas-actuated tools
- ICC-ES ESR-2024 evaluation report available for drive pin



Material: Steel, Spring Steel

Finish: Electrogalvanized, nVent CADDY Armour

Part #	Description	F	
12PZSF	3/4" EMT, 0.866"-1.181" OD	25 lb	50 pc
16PZSF	1" EMT, 1.181"-1.378" OD	25 lb	50 pc

# CABLE/CONDUIT

## Deck

### BOLT CLOSE CONDUIT/PIPE CLAMP WITH SHOT-FIRE BRACKET

- Retained bolt and built-in nut means there are less parts to handle or drop
- Combo head bolt works with slotted, hex, #3 phillips or #2 robertson drivers
- Complete with shot-fire bracket and pre-assembled drive pin
- Quickly and easily attaches to concrete, steel or composite metal decking
- Integrated pin installs easily using powder-actuated or single-shot gas-actuated tools
- ICC-ES ESR-2024 evaluation report available for drive pin



Material: Steel

Finish: Electrogalvanized

Part #	Description	F	Box
CD0BSF	0.67"–0.84" OD, 1/2" EMT, 1/2" Rigid/Pipe	100 lb	50 pc
CD1BSF	0.74"–1.05" OD, 3/4" EMT, 3/4" Rigid/Pipe	100 lb	50 pc
CD2BSF	1"–1.315" OD, 1" EMT, 1" Rigid/Pipe	100 lb	50 pc

### BOLT CLOSE CONDUIT/PIPE CLAMP WITH Z SHOT-FIRE BRACKET

- Retained bolt and built-in nut means there are less parts to handle or drop
- Combo head bolt works with slotted, hex, #3 phillips or #2 robertson drivers
- Complete with shot-fire bracket and pre-assembled drive pin
- Quickly and easily attaches to concrete, steel or composite metal decking
- Integrated pin installs easily using powder-actuated or single-shot gas-actuated tools
- ICC-ES ESR-2024 evaluation report available for drive pin



Material: Steel

Finish: Electrogalvanized

Part #	Description	F	Box
CD0BZSF	0.67"–0.84" OD, 1/2" EMT, 1/2" Rigid/Pipe	100 lb	50 pc
CD2BZSF	1"–1.315" OD, 1" EMT, 1" Rigid/Pipe	100 lb	50 pc

## CABLE/CONDUIT

### Deck

#### M-TDH CONDUIT TO DECK HANGER

- Meets the requirements of NEC® Section 300.4(E)
- Supports conduit or pipe 1-1/2" (38 mm) under the roof decking to prevent potential damage from nails or screws



Material: Spring Steel  
Finish: nVent CADDY Armour

Part #	Description	
812MTDH	1/2", 3/4" EMT	50 pc
16MTDH	1" EMT	50 pc
20MTDH	1 1/4" EMT	50 pc

#### SBT-TDH MULTIPLE CONDUIT MOUNTING PLATE WITH DECK HANGER

- Meets the requirements of NEC® Section 300.4(E)
- Supports conduit or pipe 1-1/2" (38 mm) under the roof decking to prevent potential damage from nails or screws



Material: Spring Steel  
Finish: nVent CADDY Armour

Part #	Description	
SBT18TDH	SBT-TDH Multiple Conduit Mounting Plate with Deck Hanger	50 pc

# CABLE/CONDUIT

## Deck

### M-CPNAM CONDUIT TO DECK ANGLE BRACKET

- Meets the requirements of NEC® Section 300.4(E)
- Supports conduit or pipe 1-1/2" (38 mm) under the roof decking to prevent potential damage from nails or screws



Material: Steel  
Finish: Plain

Part #	Description	
812MCPNAM	1/2", 3/4" EMT	50 pc
16MCPNAM	1" EMT	50 pc
20MCPNAM	1 1/4" EMT	50 pc
24MCPNAM	1 1/2" EMT	50 pc
6MCPNAM	3/8" Flexible, 14-2 to 12-3 MC/AC	50 pc

### CD-CPNAM CONDUIT/PIPE TO DECK ANGLE BRACKET

- Meets the requirements of NEC® Section 300.4(E)
- Supports conduit or pipe 1-1/2" (38 mm) under the roof decking to prevent potential damage from nails or screws



Material: Steel  
Finish: Electrogalvanized

Part #	Description	
CD0BCPNAM	1/2" EMT, 1/2" Rigid/Pipe	50 pc
CD1BCPNAM	3/4" EMT, 3/4" Rigid/Pipe	50 pc



## CABLE/CONDUIT

### Deck

#### SNAP CLOSE METAL DECK CONDUIT CLAMP

- Provides spacing between conduit and deck surface
- Easily attached with screw gun or power tool
- Permits conduit to be laid out and then attached
- Eliminates need for offset bending conduit



Material: Spring Steel, Steel  
Finish: nVent CADDY Armour, Pregalvanized

Part #	Description	
AOL812M	1/2", 3/4" EMT, 1/2", 3/4" Rigid	100 pc

No load rating, for positioning only.

#### PUSH-IN METAL DECK CONDUIT CLAMP

- Provides spacing between conduit and deck surface
- Easily attached with screw gun or power tool
- Permits conduit to be laid out and then attached
- Eliminates need for offset bending conduit



Material: Spring Steel, Steel  
Finish: nVent CADDY Armour, Pregalvanized

Part #	Description	
AOL8P	1/2" EMT, 0.709" Min, 0.866" Max, 0.5" Nom OD	100 pc
AOL12P	3/4" EMT, 1/2" Rigid, 0.866" Min, 1.181" Max, 0.752" Nom OD	100 pc
AOL16P	1" EMT, 3/4" Rigid, 1.181" Min, 1.378" Max, 1" Nom OD	100 pc

No load rating, for positioning only.

# CABLE/CONDUIT

## Deck

### SNAP CLOSE CONDUIT CLAMP WITH NAIL BRACKET

- Used to attach conduit to wood, steel or concrete
- Eliminates need for offset bending conduit
- Works with power tools, screw guns or nails
- May be attached after positioning conduit



Material: Spring Steel  
Finish: nVent CADDY Armour



Part #	Description	
CNB812M	1/2", 3/4" EMT, 1/2", 3/4" Rigid	100 pc

No load rating, for positioning only.

### PUSH IN CONDUIT CLAMP WITH NAIL BRACKET

- Used to attach conduit to wood, steel or concrete
- Eliminates need for offset bending conduit
- Works with power tools, screw guns or nails
- May be attached after positioning conduit



Material: Spring Steel  
Finish: nVent CADDY Armour

Part #	Description	
CNB8P	1/2" EMT	100 pc
CNB12P	3/4" EMT	100 pc

No load rating, for positioning only.

## CABLE/CONDUIT

### Deck

#### WMX CABLE HANGER WITH SHOT-FIRE BRACKET

- Bundle runs of MC or AC (refer to local authorities and NEC® Article 310 for derating ampacity when flexible power cables are used)
- Complete with shot-fire bracket and pre-assembled drive pin
- Quickly and easily attaches to concrete, steel or composite metal decking
- Integrated pin installs easily using powder-actuated or single-shot gas-actuated tools
- ICC-ES evaluation report available for drive pin



Material: Steel

Finish: Electrogalvanized

Part #	Description		
WMX6SF	1 3/4" dia	75 lb	100 pc

#### MC/AC CABLE SUPPORT WITH NAIL GUN BRACKET

- Neatly isolates, supports and secures MC/AC cables
- Properly spaces MC/AC cable to help eliminate bundling and NEC® & CEC derating issues
- Results in a "neat and workmanlike" installation
- Complete with concrete nail gun insert bracket
- Clips onto nozzle of gas or battery-actuated nail guns allowing for hands-off installation at structure or from the floor using a pole
- Longer leg angle bracket for tool clearance
- Quickly and easily attaches to concrete, steel or composite metal decking



Material: Steel, Nylon

Finish: Electrogalvanized

Part #	Description	
MCS100GBSF	MC/AC Cable Support with Nail Gun Bracket	25 pc

Nail gun insert is compatible with BeA® CN60-688ES, Hilti® BX 3, GX 3, DEWALT® Trak-It C3, SPIT® PULSA 800E, 700, 1000 or equivalent nailers.

# CABLE/CONDUIT

## Deck

### MC/AC CABLE SUPPORT WITH SHOT-FIRE BRACKET

- Neatly isolates, supports and secures MC/AC cables
- Properly spaces MC/AC cable to help eliminate bundling and NEC® & CEC derating issues
- Results in a “neat and workmanlike” installation
- Complete with shot-fire bracket and pre-assembled drive pin
- Quickly and easily attaches to concrete, steel or composite metal decking
- Integrated pin installs easily using powder-actuated or single-shot gas-actuated tools
- ICC-ES ESR-2024 evaluation report available for drive pin



Material: Steel  
Finish: Electrogalvanized

Part #	Description	
MCS100SF	14-3 to 10-2 MC/AC, 10-2 Super Neutral, 8 Cable	25 pc
MCS101SF	10-3 to 8-3 MC/AC, 12-3 to 10-2 Super Neutral, 7 Cable	25 pc

### MC/AC CABLE CLIP WITH SHOT-FIRE BRACKET

- Provides easy snap-in installation of up to two MC/AC cables
- Complete with shot-fire bracket and pre-assembled drive pin
- Quickly and easily attaches to concrete, steel or composite metal decking
- Integrated pin installs easily using powder-actuated or single-shot gas-actuated tools
- ICC-ES ESR-2024 evaluation report available for drive pin



Material: Steel, Spring Steel  
Finish: Electrogalvanized, nVent CADDY Armour

Part #	Description	
MAC2SF	14-2 to 10-3 MC/AC	100 pc

# CABLE/CONDUIT

## Deck

### NM CABLE CLIP WITH SHOT-FIRE BRACKET

- Supports non-metallic sheathed cable with ground wire
- Complete with shot-fire bracket and pre-assembled drive pin
- Quickly and easily attaches to concrete, steel or composite metal decking
- Integrated pin installs easily using powder-actuated or single-shot gas-actuated tools
- ICC-ES ESR-2024 evaluation report available for drive pin



Material: Steel, Spring Steel  
Finish: Electrogalvanized, nVent CADDY Armour

Part #	Description	
RMXSF	NM Cable Clip with Shot-Fire Bracket	100 pc

### NM CABLE WITH ANGLE BRACKET

- Supports non-metallic sheathed cable with ground wire



Material: Spring Steel  
Finish: nVent CADDY Armour



Part #	Description	
RMXAB	14-2, 12-2 NM, 0.28"–0.32" OD	100 pc

Assemblies allow support from most main and substructures.

# CABLE/CONDUIT

## Purlin

### 123-M CONDUIT TO Z PURLIN CLIP

- Snap-close conduit support
- Conduit clip rotates 360 degrees
- Supports conduit from purlin



Material: Spring Steel  
Finish: nVent CADDY Armour



Part #	Description	F ↓	☐
1236M	3/8" Flexible, 14-2 to 12-3 MC/AC, 0.551"-0.709" OD, 0.06"-0.1" Flange	100 lb	100 pc
123812M	1/2", 3/4" EMT, 0.709"-1.181" OD, 0.06"-0.1" Flange	100 lb	100 pc
12316M	1" EMT, 1.181"-1.378" OD, 0.06"-0.1" Flange	100 lb	100 pc
12320M	1 1/4" EMT, 1.378"-1.654" OD, 0.06"-0.1" Flange	100 lb	100 pc

### 123-P CONDUIT TO Z PURLIN CLIP

- Push-in conduit support
- Conduit clip rotates 360 degrees
- Supports conduit from purlin



Material: Spring Steel  
Finish: nVent CADDY Armour

Part #	Description	F ↓	☐
12312P	3/4" EMT, 1/2" Rigid, 0.866"-1.181" OD, 0.06"-0.1" Flange	25 lb	100 pc
12316P	1" EMT, 3/4" Rigid, 1.181"-1.378" OD, 0.06"-0.1" Flange	25 lb	100 pc

## CABLE/CONDUIT

### Purlin

#### MC/AC CABLE TO C PURLIN CLIP

- No tools required for installation
- Compliant with NEC® Article 300.4(d), allowing cable to be positioned a minimum of 1-1/4" from face of stud
- Compliant with CEC Rule 12-618 for support of MC/AC cable



Material: Spring Steel  
Finish: nVent CADDY Armour



Part #	Description	
--------	-------------	---

MAC2VF14	14-2 to 10-3 MC/AC, 1/16"-1/4" Flange	100 pc
----------	--	--------

Assemblies allow for support from most main and substructures.

#### MC/AC CABLE TO Z PURLIN CLIP

- Compliant with CEC Rule 12-618 for support of MC/AC cable



Material: Spring Steel  
Finish: nVent CADDY Armour



Part #	Description	
--------	-------------	---

MAC2123	14-2 to 10-3 MC/AC, 0.06"-0.1" Flange	100 pc
---------	--	--------

Assemblies allow for support from most main and substructures.

# CABLE/CONDUIT

## Purlin

### MC/AC CABLE SUPPORT BRACKET WITH C PURLIN CLIP

- Neatly isolates, supports and secures MC/AC cables
- Properly spaces MC/AC cable to help eliminate bundling and NEC® & CEC derating issues
- Results in a "neat and workmanlike" installation



Material: Steel  
Finish: Electrogalvanized



Part #	Description	
Isolated Ground Cable Size: 12-3 to 8-2 MC/AC Cable Size: 10-3 to 8-3 Super Neutral Cable Size: 12-3 to 10-2		
MCS101VF14	10-3 to 8-3 MC/AC, 7 Cable, 1/16"-1/4" Flange	25 pc
MC/AC Cable Size: 14-3 to 10-2 Super Neutral Cable Size: 10-2		
MCS50VF14	14-3 to 10-2 MC/AC, 4 Cable, 1/16"-1/4" Flange	25 pc
MCS100VF14	14-3 to 10-2 MC/AC, 8 Cable, 1/16"-1/4" Flange	25 pc

### MC/AC CABLE SUPPORT BRACKET WITH Z PURLIN CLIP

- Neatly isolates, supports and secures MC/AC cables
- Properly spaces MC/AC cable to help eliminate bundling and NEC® & CEC derating issues
- Results in a "neat and workmanlike" installation



Material: Steel  
Finish: Electrogalvanized



Part #	Description	
Isolated Ground Cable Size: 12-3 to 8-2 MC/AC Cable Size: 10-3 to 8-3 Super Neutral Cable Size: 12-3 to 10-2		
MCS101AF14	10-3 to 8-3 MC/AC, 7 Cable, 1/16"-1/4" Flange	25 pc
MC/AC Cable Size: 14-3 to 10-2 Super Neutral Cable Size: 10-2		
MCS50AF14	14-3 to 10-2 MC/AC, 4 Cable, 1/16"-1/4" Flange	25 pc
MCS100AF14	14-3 to 10-2 MC/AC, 8 Cable, 1/16"-1/4" Flange	25 pc



## CABLE/CONDUIT

### Purlin

#### NM CABLE TO C PURLIN CLIP

- Supports non-metallic sheathed cable with ground wire



Material: Spring Steel  
Finish: nVent CADDY Armour



Part #	Description	
RMXVF14	14-2, 12-2 NM, 0.28"–0.32" OD, 1/16"–1/4" Flange	100 pc

Assemblies allow support from most main and substructures.

#### NM CABLE TO Z PURLIN CLIP

- Supports non-metallic sheathed cable with ground wire



Material: Spring Steel  
Finish: nVent CADDY Armour



Part #	Description	
RMXAF14	14-2, 12-2 NM, 0.28"–0.32" OD, 1/16"–1/4" Flange	100 pc

Assemblies allow support from most main and substructures.

# CABLE/CONDUIT Rod/Wire



## CABLE/CONDUIT CLIP

- Supports conduit to rod, wire or flange
- Can also be used for flexible metallic tubing, armored cable, portable cables, control tubes and communications cable
- Available for EMT, rigid, ENT, IMT, MC/AC and aluminum conduit
- No installation tools required



Material: Spring Steel  
Finish: nVent CADDY Armour



Part #	Description			
K8	1/2" EMT, 1/2" Rigid, 12-3 MC/AC, 0.709" Max OD	50 lb	100 lb	100 pc
K12	1/2", 3/4" EMT, 1/2", 3/4" Rigid, 0.945" Max OD	50 lb	100 lb	100 pc
K16	3/4", 1" EMT, 1/2", 3/4" Rigid, 1.181" Max OD	50 lb	100 lb	100 pc
K20	1", 1 1/4" EMT, 3/4", 1" Rigid, 1.654" Max OD	50 lb	100 lb	100 pc
KX	14-2 to 12-3 MC/AC, 0.472" Max OD			100 pc

May require dedicated drop wire/rod and EC311. Consult local authority.  
For horizontal application only when installing conduit.

Conduit Size	#10 or #12 Wire	#8 or #10 Wire	3/16" or 1/4" Rod	1/8" - 1/4" Flange	5/16" - 3/8" Flange	7/16" - 1/2" Flange
1/2" EMT	K8	K8	K8	K8	K12	K12
1/2" Rigid	K8	K12	K12	K12	K12	K16
3/4" EMT	K12	K12	K12	K12	K16	K16
3/4" Rigid	K12	K12	K16	K16	K20	K20
1" EMT	-	K12	K16	K16	K20	K20
1" Rigid	-	-	-	K20	K20	K20
1 1/4" EMT	-	K20	K20	K20	-	-

Cable Size	#12 Wire	#8, #9, #10 Wire
14-2 (.433" - .475" OD)	KX	KX
14-3 (.453" - .500" OD)	KX	KX
12-2 (.467" - .510" OD)	KX	KX
12-3 (.489" - .535" OD)	KX	K8

## CABLE/CONDUIT

### Rod/Wire

#### CABLE/CONDUIT TO WIRE CLIP

- Supports cable and conduit without bending drop wire
- Faster installation than traditional methods



Material: Spring Steel  
Finish: nVent CADDY Armour



Part #	Description	F ↓	☐
PCS1	14-2 to 10-3 MC/AC, 0.45"–0.6" OD, #8–#12 Wire	25 lb	100 pc
PCS2	1/2", 3/4" EMT, 10-3 to 6-3 MC/AC, 0.601"–0.9" OD, #8–#12 Wire	25 lb	100 pc

NEC® 300.11 requires dedicated drop wire/rod and EC311.

#### SNAP CLOSE CONDUIT TO ROD/WIRE CLIP

- Provides attachment of conduit and boxes



Material: Spring Steel  
Finish: nVent CADDY Armour



Part #	Description	☐
4Z34812M	1/2", 3/4" EMT, 0.71"–1.18" OD, 1/4" Rod, #12 Wire	100 pc
6Z34812M	1/2", 3/4" EMT, 0.71"–1.18" OD, 3/8" Rod	100 pc
8Z34812M	1/2", 3/4" EMT, 0.71"–1.18" OD, 1/2", 5/8" Rod	100 pc
4Z3416M	1" EMT, 1.18"–1.38" OD, 1/4" Rod, #12 Wire	100 pc
6Z3416M	1" EMT, 1.18"–1.38" OD, 3/8" Rod	100 pc
4Z346M	14-2 to 12-3 MC/AC, 0.55"–0.71" OD, 1/4" Rod, #12 Wire	100 pc
6Z346M	14-2 to 12-3 MC/AC, 0.55"–0.71" OD, 3/8" Rod	50 pc

1/2" and 5/8" rod sizes are to be installed on threaded rod only.

NEC® 300.11 requires dedicated drop wire/rod and EC311.

# CABLE/CONDUIT

## Rod/Wire

### PUSH IN CONDUIT TO ROD/WIRE CLIP

- Provides attachment of conduit and boxes



Material: Spring Steel  
Finish: nVent CADDY Armour

Part #	Description	
4Z348P	1/2" EMT, 1/4" Rod, #12 Wire, 1/8"-3/8" Flange	100 pc
6Z348P	1/2" EMT, 3/8" Rod, 3/8"-7/16" Flange	100 pc
4Z3412P	3/4" EMT, 1/2" Rigid, 1/4" Rod, #12 Wire, 1/8"-3/8" Flange	100 pc
6Z3412P	3/4" EMT, 1/2" Rigid, 3/8" Rod, 3/8"-7/16" Flange	100 pc
4Z3416P	1" EMT, 3/4" Rigid, 1/4" Rod, #12 Wire, 1/8"-3/8" Flange	100 pc
6Z3416P	1" EMT, 3/4" Rigid, 3/8" Rod, 3/8"-7/16" Flange	100 pc

NEC® 300.11 requires dedicated drop wire/rod and EC311.

### MC/AC CABLE TO ROD/WIRE CLIP

- No tools required for installation
- Compliant with NEC® Article 300.4(d), allowing cable to be positioned a minimum of 1-1/4" from face of stud
- Compliant with CEC Rule 12-618 for support of MC/AC cable



Material: Spring Steel  
Finish: nVent CADDY Armour



Part #	Description	
MAC24Z34	1/4" Rod, #12 Wire, 14-2 to 10-3 MC/AC	100 pc
MAC26Z34	3/8" Rod, 14-2 to 10-3 MC/AC	100 pc

Assemblies allow for support from most main and substructures.

# CABLE/CONDUIT

## Rod/Wire

### MC/AC CABLE SUPPORT BRACKET WITH ROD/WIRE CLIP

- Neatly isolates, supports and secures MC/AC cables
- Properly spaces MC/AC cable to help eliminate bundling and NEC® & CEC derating issues
- Results in a “neat and workmanlike” installation



Material: Steel  
Finish: Electrogalvanized





Part #	Description	
Isolated Ground Cable Size: 12-3 to 8-2		
MC/AC Cable Size: 10-3 to 8-3		
Super Neutral Cable Size: 12-3 to 10-2		
MCS1014Z	10-3 to 8-3 MC/AC, 7 Cable, 1/4" Rod, #8 Wire	25 pc
MCS1016Z	10-3 to 8-3 MC/AC, 7 Cable, 3/8" Rod	25 pc
MC/AC Cable Size: 14-3 to 10-2		
Super Neutral Cable Size: 10-2		
MCS504Z	14-3 to 10-2 MC/AC, 4 Cable, 1/4" Rod, #8 Wire	25 pc
MCS506Z	14-3 to 10-2 MC/AC, 4 Cable, 3/8" Rod	25 pc
MCS1004Z	14-3 to 10-2 MC/AC, 8 Cable, 1/4" Rod, #8 Wire	25 pc
MCS1006Z	14-3 to 10-2 MC/AC, 8 Cable, 3/8" Rod	25 pc
MCS1008Z	14-3 to 10-2 MC/AC, 8 Cable, 1/2", 5/8" Rod	25 pc

### SBT-Z MULTIPLE CONDUIT MOUNTING PLATE WITH ROD/WIRE CLIP

- Single point structure attachment and easy “snap-in” field assembly of up to three conduit clips
- No tools necessary for installation of clips
- Eliminates need for offset bending conduit
- Helps eliminate multiple beam clamps or strut assemblies



Material: Spring Steel  
Finish: nVent CADDY Armour

Part #	Description		
SBT184Z34	1/4" Rod, #12 Wire	20 lb	50 pc
SBT186Z34	3/8" Rod	20 lb	50 pc

Static Load represents the maximum load limit of the assembly.

# CABLE/CONDUIT Strut

## NM CABLE TO ROD/WIRE CLIP

- Supports non-metallic sheathed cable with ground wire



Material: Spring Steel  
Finish: nVent CADDY Armour



Part #	Description	
RMX4Z34	14-2, 12-2 NM, 0.28"–0.32" OD, 1/4" Rod, #12 Wire	100 pc
RMX6Z34	14-2, 12-2 NM, 0.28"–0.32" OD, 3/8" Rod	100 pc

Assemblies allow support from most main and substructures.



## ESC-M CONDUIT TO STRUT CLIP

- Attaches to open side of a strut channel
- Includes easy close pipe and conduit clamp



Material: Spring Steel  
Finish: nVent CADDY Armour



Part #	Description		
ESC6M	3/8" Rigid/Pipe, 14-2 to 12-3 MC/AC, 3/8" Flexible	25 lb	100 pc
ESC812M	1/2", 3/4" EMT, 1/2", 3/4" Rigid/Pipe	25 lb	100 pc

## CABLE/CONDUIT

### Strut

#### ESC-P CONDUIT TO STRUT CLIP

- Attaches to open side of a strut channel
- Provides means to support conduit running perpendicular to strut



Material: Spring Steel  
Finish: nVent CADDY Armour

Part #	Description			
ESC12P	3/4" EMT, 3/4" Rigid/Pipe	15 lb	25 lb	100 pc



#### SCH1 SINGLE PIECE STRUT CLAMP FOR CONDUIT

- One-piece conduit clamp
- No screws or bolts to drop
- Requires only a screwdriver or nutdriver for installation
- Fits into open side of strut channel



Material: Steel  
Finish: Electrogalvanized



Part #	Description		
SCH8	0.34"–0.71" OD, 1/2" EMT	200 lb	100 pc
SCH12	0.57"–0.92" OD, 3/4" EMT, 1/2" Rigid/Pipe	200 lb	100 pc
SCH16	0.72"–1.16" OD, 1" EMT, 3/4" Rigid/Pipe	200 lb	100 pc
SCH20	1"–1.51" OD, 1 1/4" EMT, 1" Rigid/Pipe	200 lb	100 pc

# CABLE/CONDUIT Strut

## SCH2 SINGLE PIECE STRUT CLAMP FOR CABLE/CONDUIT

- One-piece cable/conduit clamp with protective boot
- No screws or bolts to drop
- Requires only a screwdriver or nutdriver for installation
- Fits into open side of strut channel
- FM® Specification Tested (from 1/2" to 4" of EMT Conduit Size)



Material: Steel  
Finish: Electrogalvanized



Part #	Description	F1	F2	Box
SCH6B	0.1"–0.63" OD	200 lb	75 lb	100 pc
SCH8B	0.34"–0.71" OD, 1/2" EMT	200 lb	75 lb	100 pc
SCH12B	0.57"–0.92" OD, 3/4" EMT	200 lb	75 lb	100 pc
SCH16B	0.72"–1.16" OD, 1" EMT	200 lb	75 lb	100 pc
SCH20B	1"–1.51" OD, 1 1/4" EMT	200 lb	75 lb	100 pc
SCH24B	1.25"–1.74" OD, 1 1/2" EMT	350 lb	75 lb	50 pc
SCH32B	1.74"–2.2" OD, 2" EMT	350 lb	75 lb	50 pc
SCH40B	2"–2.38" OD	350 lb	75 lb	25 pc
SCH48B	2.38"–2.88" OD, 2 1/2" EMT	350 lb	75 lb	25 pc
SCH56B	2.72"–3.5" OD, 3" EMT	350 lb	75 lb	25 pc
SCH64B	3.25"–4" OD, 3 1/2" EMT	350 lb	75 lb	10 pc
SCH72B	3.85"–4.5" OD, 4" EMT	350 lb	75 lb	10 pc



## CABLE/CONDUIT

### Clamps and Clips

#### SK SINGLE PIECE STRUT CLAMP FOR CONDUIT

- One piece break apart strut clamp for EMT and Rigid conduit
- Includes thread impression and captured screw



Part #	Description	F ↓	☐	Cert
Material: Aluminum				
SK8ALA	1/2" EMT, 1/2" Rigid/Pipe	150 lb	100 pc	
SK12ALA	3/4" EMT, 3/4" Rigid/Pipe	150 lb	100 pc	
SK16ALA	1" EMT, 1" Rigid/Pipe	150 lb	100 pc	
SK20ALA	1 1/4" EMT, 1 1/4" Rigid/Pipe	150 lb	50 pc	
SK24ALA	1 1/2" EMT, 1 1/2" Rigid/Pipe	150 lb	50 pc	
SK32ALA	2" EMT, 2" Rigid/Pipe	150 lb	50 pc	
Material: Steel – Finish: Electrogalvanized				
SK85I	EG, 1/2" EMT, 1/2" Rigid/Pipe	200 lb	100 pc	cULus
SK125I	EG, 3/4" EMT, 3/4" Rigid/Pipe	200 lb	100 pc	cULus
SK165I	EG, 1" EMT, 1" Rigid/Pipe	200 lb	100 pc	cULus
SK205I	EG, 1 1/4" EMT, 1 1/4" Rigid/Pipe	200 lb	50 pc	cULus
SK245I	EG, 1 1/2" EMT, 1 1/2" Rigid/Pipe	200 lb	50 pc	cULus
SK325I	EG, 2" EMT, 2" Rigid/Pipe	200 lb	50 pc	cULus
SK405I	EG, 2 1/2" EMT, 2 1/2" Rigid/Pipe	350 lb	50 pc	cULus
SK485I	EG, 3" EMT, 3" Rigid/Pipe	350 lb	50 pc	cULus
SK565I	EG, 3 1/2" EMT, 3 1/2" Rigid/Pipe	350 lb	50 pc	cULus
SK645I	EG, 4" EMT, 4" Rigid/Pipe	350 lb	50 pc	cULus

# CABLE/CONDUIT

## Clamps and Clips

### PUSH IN CONDUIT CLAMP

- Push-in installation of conduit
- Eliminates need for offset bending conduit
- May be used for either vertical or horizontal installations



Material: Spring Steel  
 Finish: nVent CADDY Armour

Part #	Description	F1	F2	Icon
8P4I	1/2" EMT, 0.709" Min, 0.866" Max, 0.5" Nom OD, 1/4" Hole, Threaded	25 lb	15 lb	100 pc
8P	1/2" EMT, 0.709"-0.866" OD, 9/32" Hole, Plain	25 lb	15 lb	100 pc
12P	3/4" EMT, 0.866"-1.181" OD, 9/32" Hole, Plain	25 lb	15 lb	100 pc
12P4I	3/4" EMT, 0.866" Min, 1.181" Max, 0.752" Nom OD, 1/4" Hole, Threaded	25 lb	15 lb	100 pc
16P	1" EMT, 1.181"-1.378" OD, 9/32" Hole, Plain	25 lb	15 lb	100 pc
16P4I	1" EMT, 1.181" Min, 1.378" Max, 1" Nom OD, 1/4" Hole, Threaded	25 lb	15 lb	100 pc

# CABLE/CONDUIT

## Clamps and Clips

### SNAP CLOSE CONDUIT/PIPE CLAMP

- May be used for either vertical or horizontal installations
- Eliminates need for offset bending conduit
- Finger closure, no tools required



Material: Spring Steel  
Finish: nVent CADDY Armour



Part #	Description	F1	F2	Box
6M4I	3/8" Flexible, 14-2 to 12-3 MC/AC, 0.551"-0.709" OD, 1/4" Hole, Threaded	100 lb	25 lb	100 pc
6M	3/8" Flexible, 14-2 to 12-3 MC/AC, 0.551"-0.709" OD, 9/32" Hole, Plain	100 lb	25 lb	100 pc
812M4I	1/2", 3/4" EMT, 1/2", 3/4" Rigid/Pipe, 0.709"-1.181" OD, 1/4" Hole, Threaded	100 lb	25 lb	100 pc
812M	1/2", 3/4" EMT, 1/2", 3/4" Rigid/Pipe, 0.709"-1.181" OD, 9/32" Hole, Plain	100 lb	25 lb	100 pc
16M4I	1" EMT, 1" Rigid/Pipe, 1/4" Hole, Threaded	100 lb	25 lb	100 pc
16M	1" EMT, 1" Rigid/Pipe, 1.181"-1.378" OD, 9/32" Hole, Plain	100 lb	25 lb	100 pc
20M4I	1 1/4" EMT, 1 1/4" Rigid/Pipe, 1/4" Hole, Threaded	100 lb	25 lb	100 pc
20M	1 1/4" EMT, 1 1/4" Rigid/Pipe, 1.378"-1.654" OD, 9/32" Hole, Plain	100 lb	25 lb	100 pc
24M4I	1 1/2" EMT, 1 1/2" Rigid/Pipe, 1/4" Hole, Threaded	100 lb	25 lb	100 pc
24M	1 1/2" EMT, 1 1/2" Rigid/Pipe, 1.654"-1.969" OD, 9/32" Hole, Plain	100 lb	25 lb	100 pc
32M4I	2" EMT, 2" Rigid/Pipe, 1/4" Hole, Threaded	100 lb	25 lb	100 pc
32M	2" EMT, 2" Rigid/Pipe, 1.969"-2.362" OD, 9/32" Hole, Plain	100 lb	25 lb	100 pc

# CABLE/CONDUIT

## Clamps and Clips

### BOLT CLOSE CONDUIT/PIPE CLAMP

- Retained bolt and built-in nut means there are less parts to handle or drop
- Combo head bolt works with slotted, hex, #3 phillips or #2 robertson drivers



Part #	Description	F1	F2	
Material: Steel; Finish: Electrogalvanized; Nut Type: Built-In Nut				
CD0B	1/2" EMT, 1/2" Rigid/Pipe, 1/4" Hole	200 lb	50 lb	100 pc
CD0B37	1/2" EMT, 1/2" Rigid/Pipe, 3/8" Hole	200 lb	50 lb	100 pc
CD1B	3/4" EMT, 3/4" Rigid/Pipe, 1/4" Hole	200 lb	50 lb	100 pc
CD1B37	3/4" EMT, 3/4" Rigid/Pipe, 3/8" Hole	200 lb	50 lb	100 pc
CD2B	1" EMT, 1" Rigid/Pipe, 1/4" Hole	200 lb	50 lb	100 pc
CD2B37	1" EMT, 1" Rigid/Pipe, 3/8" Hole	200 lb	50 lb	100 pc
CD2.5B	1 1/4" EMT, 1/4" Hole	200 lb	50 lb	100 pc
CD2.5B37	1 1/4" EMT, 3/8" Hole	200 lb	50 lb	100 pc
CD3B	1 1/2" EMT, 1 1/4" Rigid/Pipe, 1/4" Hole	200 lb	50 lb	100 pc
CD3B37	1 1/2" EMT, 1 1/4" Rigid/Pipe, 3/8" Hole	200 lb	50 lb	100 pc
CD4B	1 1/2" Rigid/Pipe, 5/16" Hole	200 lb	50 lb	50 pc
CD4B37	1 1/2" Rigid/Pipe, 3/8" Hole	200 lb	50 lb	50 pc
CD5B	2" EMT, 2" Rigid/Pipe, 5/16" Hole	200 lb	50 lb	50 pc
CD5B37	2" EMT, 2" Rigid/Pipe, 3/8" Hole	200 lb	50 lb	50 pc
Material: Steel; Finish: Electrogalvanized; Nut Type: Hex Nut				
CD6B	2 1/2" EMT, 2 1/2" Rigid/Pipe, 5/16" Hole	350 lb	50 lb	25 pc
CD7B	3" EMT, 3" Rigid/Pipe, 5/16" Hole	350 lb	50 lb	25 pc
CD8B	3 1/2" EMT, 3 1/2" Rigid/Pipe, 5/16" Hole	350 lb	50 lb	10 pc
CD9B	4" EMT, 4" Rigid/Pipe, 5/16" Hole	350 lb	50 lb	10 pc
Material: Stainless Steel 304 (EN 1.4301); Nut Type: Hex Nut				
CD0BSS	S304, 1/2" EMT, 1/2" Rigid/Pipe, 1/4" Hole	200 lb	50 lb	100 pc
CD1BSS	S304, 3/4" EMT, 3/4" Rigid/Pipe, 1/4" Hole	200 lb	50 lb	100 pc
CD2BSS	S304, 1" EMT, 1" Rigid/Pipe, 1/4" Hole	200 lb	50 lb	100 pc
CD2.5BSS	S304, 1 1/4" EMT, 1/4" Hole	200 lb	50 lb	100 pc
CD3BSS	S304, 1 1/2" EMT, 1 1/4" Rigid/Pipe, 1/4" Hole	200 lb	50 lb	100 pc
CD4BSS	S304, 1 1/2" Rigid/Pipe, 5/16" Hole	200 lb	50 lb	50 pc
CD5BSS	S304, 2" EMT, 2" Rigid/Pipe, 5/16" Hole	350 lb	50 lb	50 pc
CD6BSS	S304, 2 1/2" EMT, 2 1/2" Rigid/Pipe, 5/16" Hole	350 lb	50 lb	25 pc
CD7BSS	S304, 3" EMT, 3" Rigid/Pipe, 5/16" Hole	350 lb	50 lb	25 pc
CD8BSS	S304, 3 1/2" EMT, 3 1/2" Rigid/Pipe, 5/16" Hole	350 lb	50 lb	10 pc
CD9BSS	S304, 4" EMT, 4" Rigid/Pipe, 5/16" Hole	350 lb	50 lb	10 pc

\* Please refer to [nVent.com/CADDY](http://nVent.com/CADDY) for UL listings

## CABLE/CONDUIT

### Clamps and Clips

#### PUSH IN CONDUIT TO CONDUIT CLAMP

- Ideal as spacer between same or different size conduit
- No tools required for installation
- Top conduit to be used for support only, not a raceway



Material: Spring Steel  
Finish: nVent CADDY Armour

Part #	Description	F ↓	☐
8P8P	1/2" EMT1, 1/2" EMT2, 0.709"-0.866" OD1, 0.709"-0.866" OD2	25 lb	100 pc
8P12P	1/2" EMT1, 3/4" EMT2, 1/2" Rigid2, 0.709"-0.866" OD1, 0.866"-1.18" OD2	25 lb	100 pc
8P16P	1/2" EMT1, 1" EMT2, 3/4" Rigid2, 0.709"-0.866" OD1, 1.18"-1.378" OD2	25 lb	50 pc
12P12P	3/4" EMT1, 3/4" EMT2, 1/2" Rigid1, 1/2" Rigid2, 0.866"-1.18" OD1, 0.866"-1.18" OD2	25 lb	100 pc
12P16P	3/4" EMT1, 1" EMT2, 1/2" Rigid1, 3/4" Rigid2, 0.866"-1.18" OD1, 1.18"-1.378" OD2	25 lb	100 pc
16P16P	1" EMT1, 1" EMT2, 3/4" Rigid1, 3/4" Rigid2, 1.18"-1.378" OD1, 1.18"-1.378" OD2	25 lb	100 pc

#### SNAP CLOSE CONDUIT TO CONDUIT CLAMP

- Fast and easy assembly for lightweight loads
- No screws or bolts required



Material: Spring Steel  
Finish: nVent CADDY Armour



Part #	Description	F ↓	☐
166M	1" EMT1, 3/8" EMT2, 3/8" Flexible, 14-2 to 12-3 MC/AC, 1.181"-1.378" OD1, 0.551"-0.709" OD2	100 lb	100 pc
16812M	1" EMT1, 1/2", 3/4" EMT2, 1.181"-1.378" OD1, 0.709"-1.181" OD2	100 lb	100 pc
1616M	1" EMT1, 1" EMT2, 1" Min OD1, 1" Min OD2	100 lb	100 pc
1620M	1" EMT1, 1 1/4" EMT2, 1.181"-1.378" OD1, 1.378"-1.654" OD2	100 lb	50 pc

For 14-2 through 12-3 MC/AC cable, use part 166M.  
Total load of trapeze must not exceed 100 lb.

# CABLE/CONDUIT

## Clamps and Clips

### WALL MOUNT CONDUIT CLIP

- Ideal for EMT support between wall studs with SGB/TSGB series brackets
- Quickly attaches pipe, conduit, MC/ AC and tube to wall surfaces
- Push-in installation of conduit
- Eliminates need for offset bending conduit
- Low-profile design minimizes snag potential
- Secure with powder-actuated tools, self-tapping concrete anchors or screw guns



Material: Spring Steel  
Finish: nVent CADDY Armour

Part #	Description	
WC812	1/2", 3/4" EMT, 1/4" Hole	100 pc

### ONE HOLE STRAP FOR EMT CONDUIT

- Recommended for supporting horizontal runs of conduit from the face of a structural member
- Fastening hole in strap may be above or below conduit



Material: Steel  
Finish: Electrogalvanized

Part #	Description	
EPS0050EG	1/2" EMT	100 pc
EPS0075EG	3/4" EMT	1 pc
EPS0100EG	1" EMT	100 pc
EPS0125EG	1 1/4" EMT	1 pc

## CABLE/CONDUIT Brackets and Hangers

### NM CABLE CLIP

- Supports non-metallic sheathed cable with ground wire



Material: Spring Steel  
Finish: nVent CADDY Armour



Part #	Description	
RMX	14-2, 12-2 NM, 0.28"–0.32" OD	100 pc

Assemblies allow support from most main and substructures.

### MC/AC CABLE SUPPORT BRACKET

- Neatly isolates, supports and secures MC/AC cables
- Properly spaces MC/AC cable to help eliminate bundling and NEC® & CEC derating issues
- Results in a "neat and workmanlike" installation



Material: Steel  
Finish: Electrogalvanized



Part #	Description	
Isolated Ground Cable Size: 12-3 to 8-2 MC/AC Cable Size: 10-3 to 8-3 Super Neutral Cable Size: 12-3 to 10-2		
MCS101	10-3 to 8-3 MC/AC, 7 Cable	50 pc
MC/AC Cable Size: 14-3 to 10-2 Super Neutral Cable Size: 10-2		
MCS50	14-3 to 10-2 MC/AC, 4 Cable	100 pc
MCS100	14-3 to 10-2 MC/AC, 8 Cable	50 pc

# CABLE/CONDUIT

## Brackets and Hangers

### WMX CABLE HANGER

- Bundle runs of MC or AC (refer to local authorities and NEC® Article 310 for derating ampacity when flexible power cables are used)
- Can be used with 4H series flange clips, DH2 / TDH deck clips, AO or AB nail brackets, VF14 vertical flange, AF14/122/123 Z purlin



Material: Steel  
Finish: Electrogalvanized



Part #	Description	F ↓	
WMX3	1 1/8" dia	50 lb	100 pc
WMX6	1 3/4" dia	75 lb	100 pc

### NM CABLE WITH OFFSET BRACKET

- Supports non-metallic sheathed cable with ground wire



Material: Spring Steel  
Finish: nVent CADDY Armour



Part #	Description	
RMXA0	14-2, 12-2 NM, 0.28"-0.32" OD	100 pc

Assemblies allow support from most main and substructures.



## CABLE/CONDUIT Brackets and Hangers

### SBT MULTIPLE CONDUIT MOUNTING PLATE

- Single point structure attachment and easy “snap-in” field assembly of up to three conduit clips
- No tools necessary for installation of clips
- Eliminates need for offset bending conduit
- Available in a variety of riveted assemblies
- Helps eliminate multiple beam clamps or strut assemblies



Material: Spring Steel  
Finish: nVent CADDY Armour

Part #	Description	F	
SBT18	SBT Multiple Conduit Mounting Plate	150 lb	50 pc

Static Load represents the maximum load limit of the assembly. Static load limit of each locking tab is 50 lb (220 N). The combined loads of the locking tabs shall not exceed the maximum load limit of the assembly.

### SBT MULTIPLE CONDUIT MOUNTING PLATE WITH THREAD IMPRESSION

- Single point structure attachment and easy “snap-in” field assembly of up to three conduit clips
- No tools necessary for installation of clips
- Eliminates need for offset bending conduit
- Available in a variety of riveted assemblies
- Helps eliminate multiple beam clamps or strut assemblies



Part #	
SBT18TI	100 pc

Static Load represents the maximum load limit of the assembly. Static load limit of each locking tab is 50 lb (220 N). The combined loads of the locking tabs shall not exceed the maximum load limit of the assembly.

# CABLE/CONDUIT

## Combination Box/Conduit

### B18 COMBINATION BOX/CONDUIT HANGER

- One assembly provides support for horizontal electrical box and/or conduit from threaded rod
- Eliminates need for offset bending conduit
- 66% less Drop Wires (rod/wire application)
- NEC® & CEC compliant



Material: Spring Steel  
Finish: nVent CADDY Armour



Part #	Description	
6MB18A	3/8" Flexible, 14-2 to 12-3 MC/AC, 1/4" Hole, Plain	25 pc
812MB18A	1/2", 3/4" EMT, 1/4" Hole, Plain	25 pc
812MB18S	1/2", 3/4" EMT, w/Screw	25 pc
16MB18A	1" EMT, 1/4" Hole, Plain	25 pc

NEC® 300.11 requires dedicated drop wire/rod. For single and multiple runs of conduit.

### B18-SBT BOX/MULTIPLE CONDUIT HANGER

- One assembly provides support for electrical box and/or conduit
- Single point structure attachment and easy "snap-in" field assembly of up to three conduit clips
- Eliminates need for offset bending conduit
- 66% less Drop Wires (rod/wire application)
- NEC® & CEC compliant



Material: Spring Steel  
Finish: nVent CADDY Armour

Part #	Description	
B18SBT18	1/4" Hole	25 pc

NEC® 300.11 requires dedicated drop wire/rod. For single and multiple runs of conduit. Hole Size value refers to mounting hole.

## CABLE/CONDUIT

### Combination Box/Conduit

#### **B18-SBT BOX/MULTIPLE CONDUIT HANGER WITH THREAD IMPRESSION**

- One assembly provides support for electrical box and/or conduit
- Single point structure attachment and easy “snap-in” field assembly of up to three conduit clips
- Eliminates need for offset bending conduit
- 66% less Drop Wires (rod/wire application)
- NEC® & CEC compliant



Part #



B18SBT18TI

25 pc

NEC® 300.11 requires dedicated drop wire/rod. For single and multiple runs of conduit. Hole Size value refers to mounting hole.

#### **B18-CO BOX/MULTIPLE CONDUIT HANGER**

- One assembly provides support for electrical box and/or conduit
- Comes with one conduit clip attached to each side with the ability to attach up to two more per side
- Eliminates need for offset bending conduit
- 66% less Drop Wires (rod/wire application)
- NEC® & CEC compliant



Material: Spring Steel

Finish: nVent CADDY Armour

Part #	Description	
6MB18ACO	3/8" Flexible, 14-2 to 12-3 MC/AC, 1/4" Hole, Plain	25 pc
812MB18ACO	1/2", 3/4" EMT, 1/4" Hole, Plain	25 pc
812MB18SCO	1/2", 3/4" EMT, w/Screw	25 pc
16MB18ACO	1" EMT, 1/4" Hole, Plain	25 pc

# CABLE/CONDUIT

## Combination Box/Conduit

### B18-C03 BOX/MULTIPLE CONDUIT HANGER

- One assembly provides support for electrical box and/or conduit
- Comes with three conduit clips attached to each side
- Eliminates need for offset bending conduit
- 66% less Drop Wires (rod/wire application)
- NEC® & CEC compliant



Material: Spring Steel  
Finish: nVent CADDY Armour

Part #	Description	
6M3B18AC0	3/8" Flexible, 14-2 to 12-3 MC/AC	25 pc

### B18-EM BOX/CONDUIT HANGER WITH FLANGE CLIP

- One assembly provides support for electrical box and/or conduit from beam flanges
- Eliminates need for offset bending conduit
- 66% less Drop Wires (rod/wire application)
- NEC® & CEC compliant



Material: Spring Steel  
Finish: nVent CADDY Armour



Part #	Description	
812MB1824	1/2", 3/4" EMT, 1/8"-1/4" Flange	25 pc
812MB1858	1/2", 3/4" EMT, 5/16"-1/2" Flange	25 pc
16MB1824	1" EMT, 1/8"-1/4" Flange	25 pc
16MB1858	1" EMT, 5/16"-1/2" Flange	25 pc
6MB1824	1/8"-1/4" Flange, 3/8" Flexible, 14-2 to 12-3 MC/AC	25 pc
6MB1858	5/16"-1/2" Flange, 3/8" Flexible, 14-2 to 12-3 MC/AC	25 pc

NEC® 300.11 requires dedicated drop wire/rod. For single and multiple runs of conduit.

## CABLE/CONDUIT

### Combination Box/Conduit

#### B18-MCS BOX/MC/AC CABLE HANGER

- One assembly provides support for horizontal electrical box and/or MC/AC cable from rod or wire
- Properly spaces MC/AC cable to help eliminate bundling and NEC® & CEC derating issues
- Neatly isolates, supports and secures MC/AC cables
- Results in a “neat and workmanlike” installation
- 66% less Drop Wires (rod/wire application)
- NEC® & CEC compliant



Material: Steel

Finish: Electrogalvanized

Part #	Description	
MCS50B18A	B18-MCS Box/MC/AC Cable Hanger	25 pc

#### B18-CO-EM BOX/MULTIPLE CONDUIT HANGER WITH FLANGE CLIP

- One assembly provides support for electrical box and/or conduit from beam flanges
- Comes with one conduit clip attached to each side with the ability to attach up to two more per side
- Eliminates need for offset bending conduit
- 66% less Drop Wires (rod/wire application)
- NEC® & CEC compliant

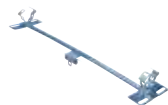

Material: Spring Steel

Finish: nVent CADDY Armour

Part #	Description	
812MB1824CO	1/2", 3/4" EMT, 1/8"–1/4" Flange	25 pc
812MB1858CO	1/2", 3/4" EMT, 5/16"–1/2" Flange	25 pc
16MB1824CO	1" EMT, 1/8"–1/4" Flange	25 pc
16MB1858CO	1" EMT, 5/16"–1/2" Flange	25 pc
6MB1824CO	14-2 to 12-3 MC/AC, 1/8"–1/4" Flange, 3/8" Flexible	25 pc
6MB1858CO	14-2 to 12-3 MC/AC, 5/16"–1/2" Flange, 3/8" Flexible	25 pc

## CABLE/CONDUIT Combination Box/Conduit

### B18-Z BOX/CONDUIT HANGER WITH ROD/WIRE CLIP

- One assembly provides support for electrical box and/or conduit from drop wire or rod
- Eliminates need for offset bending conduit
- 66% less Drop Wires (rod/wire application)
- NEC® & CEC compliant

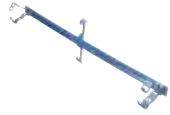

Material: Spring Steel  
Finish: nVent CADDY Armour



Part #	Description	
6MB18	3/8" Flexible, 14-2 to 12-3 MC/AC, 1/4" Rod, #12 Wire	25 pc
6MB186	3/8" Flexible, 14-2 to 12-3 MC/AC, 3/8" Rod	25 pc
812MB18	1/2", 3/4" EMT, 1/4" Rod, #12 Wire	25 pc
812MB186	1/2", 3/4" EMT, 3/8" Rod	25 pc
812MB188Z	1/2", 3/4" EMT, 1/2", 5/8" Rod	25 pc
16MB18	1" EMT, 1/4" Rod, #12 Wire	25 pc
16MB186	1" EMT, 3/8" Rod	25 pc

1/2" and 5/8" rod sizes are to be installed on threaded rod only.  
NEC® 300.11 requires dedicated drop wire/rod. For single and multiple runs of conduit.

### B18-SBT-Z BOX/MULTIPLE CONDUIT HANGER WITH ROD/WIRE CLIP

- One assembly provides support for electrical box and/or conduit from drop wire or rod
- Single point structure attachment and easy "snap-in" field assembly of up to three conduit clips
- Eliminates need for offset bending conduit
- 66% less Drop Wires (rod/wire application)
- NEC® & CEC compliant



Material: Spring Steel  
Finish: nVent CADDY Armour

Part #	Description	
B18SBT184Z	1/4" Rod, #12 Wire	25 pc

NEC® 300.11 requires dedicated drop wire/rod. For single and multiple runs of conduit.

## CABLE/CONDUIT

### Combination Box/Conduit

#### **B18-CO-Z BOX/MULTIPLE CONDUIT HANGER WITH ROD/WIRE CLIP**

- One assembly provides support for electrical box and/or conduit from drop wire or rod
- Comes with one conduit clip attached to each side with the ability to attach up to two more per side
- Eliminates need for offset bending conduit
- 66% less Drop Wires (rod/wire application)
- NEC® & CEC compliant

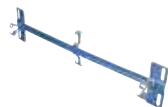

Material: Spring Steel

Finish: nVent CADDY Armour

Part #	Description	
812MB18CO	1/2", 3/4" EMT, 1/4" Rod, #12 Wire	25 pc
812MB186CO	1/2", 3/4" EMT, 3/8" Rod	25 pc
812M6MB18CO	1/2", 3/4" EMT, 14-2 to 12-3 MC/AC, 1/4" Rod, #12 Wire, 3/8" Flexible	25 pc
16MB18CO	1" EMT, 1/4" Rod, #12 Wire	25 pc
16MB186CO	1" EMT, 3/8" Rod	25 pc
6MB18CO	14-2 to 12-3 MC/AC, 1/4" Rod, #8 Min, #12 Nom Wire, 3/8" Flexible	25 pc
6MB186CO	14-2 to 12-3 MC/AC, 3/8" Rod, 3/8" Flexible	25 pc

#### **B18-CO3-Z BOX/MULTIPLE CONDUIT HANGER**

- One assembly provides support for electrical box and/or conduit from drop wire or rod
- Comes with three conduit clips attached to each side
- Eliminates need for offset bending conduit
- 66% less Drop Wires (rod/wire application)
- NEC® & CEC compliant

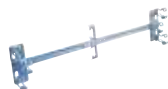

Material: Spring Steel

Finish: nVent CADDY Armour

Part #	Description	
6M3B18CO	B18-CO3-Z Box/Multiple Conduit Hanger	25 pc

## CABLE/CONDUIT

### Combination Box/Conduit

#### **B18-MCS-Z BOX/MC/AC CABLE HANGER WITH ROD/WIRE CLIP**

- One assembly provides support for horizontal electrical box and/or MC/AC cable from threaded rod
- Properly spaces MC/AC cable to help eliminate bundling and NEC® & CEC derating issues
- Neatly isolates, supports and secures MC/AC cables
- Results in a “neat and workmanlike” installation
- 66% less Drop Wires (rod/wire application)
- NEC® & CEC compliant



Material: Steel

Finish: Electrogalvanized

Part #	Description	
MCS50B18	14-2 to 12-3 MC/AC, 4 Cable	25 pc
MCS100B18	14-3 to 10-2 MC/AC, 8 Cable	25 pc

#### **B18-CPNAM BOX/CONDUIT WITH DECK ANGLE BRACKET**

- Meets the requirements of NEC® Section 300.4(E)
- Supports conduit or pipe 1-1/2” (38 mm) under the roof decking to prevent potential damage from nails or screws
- Supports box and conduit with one attachment point



Material: Steel, Spring Steel

Finish: nVent CADDY Armour, Plain

Part #	Description	
812MB18CPNAM	1/2”, 3/4” EMT	25 pc
16MB18CPNAM	1” EMT	25 pc
6MB18CPNAM	14-2 to 12-3 MC/AC, 3/8” Flexible	25 pc



## CABLE/CONDUIT

### Combination Box/Conduit

#### **B18-SBT-CPNAM BOX/MULTIPLE CONDUIT WITH DECK ANGLE BRACKET**

- Meets the requirements of NEC® Section 300.4(E)
- Supports conduit or pipe 1-1/2" (38 mm) under the roof decking to prevent potential damage from nails or screws
- Supports box and conduit with one attachment point



Material: Steel  
Finish: Plain

Part #	Description	
B18SBT18CPNAM	B18-SBT-CPNAM Box/Multiple Conduit with Deck Angle Bracket	25 pc

#### **B18-TDH BOX/CONDUIT WITH DECK HANGER**

- Meets the requirements of NEC® Section 300.4(E)
- Supports conduit or pipe 1-1/2" (38 mm) under the roof decking to prevent potential damage from nails or screws
- Supports box and conduit with one attachment point



Material: Spring Steel  
Finish: nVent CADDY Armour

Part #	Description	
812MB18TDH	1/2", 3/4" EMT	25 pc

## CABLE/CONDUIT

### Cable Tray and Accessories

#### **B18-SBT-TDH BOX/MULTIPLE CONDUIT WITH DECK HANGER**

- Meets the requirements of NEC® Section 300.4(E)
- Supports conduit or pipe 1-1/2" (38 mm) under the roof decking to prevent potential damage from nails or screws
- Supports box and conduit with one attachment point



Material: Spring Steel  
Finish: nVent CADDY Armour

Part #	Description	
B18SBT18TDH	B18-SBT-TDH Box/Multiple Conduit with Deck Hanger	25 pc

#### **CABLE TRAY SUPPORT FOR AIR HANDLING SPACES**

- Provides an easy method for supporting cable tray below raised floors



Material: Steel  
Finish: Polyester  
Static Load Safety Factor: 3:1

Part #	Description		
RPS50AHGP	2 5/16" x 10 1/2" x 3 5/16"	50 lb	10 pc



# Structural Attachments



# STRUCTURAL ATTACHMENTS

## Beam/Purlin



### 300 UNIVERSAL BEAM CLAMP

- Conforms with Federal Specification WW-H-171 (Type 23), Manufacturers Standardization Society ANSI®/MSS-SP-58 (Type 19 and 23)



Material: Cast Iron



Part #	Description	 F1	 F2		Cert
Finish: Electrogalvanized					
3000037EG	EG, 3/8" Rod, 3/4" Max Flange	500 lb	250 lb	100 pc	cULus, FM
3000050EG	EG, 1/2" Rod, 3/4" Max Flange	950 lb	760 lb	50 pc	cULus, FM
3000062EG	EG, 5/8" Rod, 3/4" Max Flange	950 lb	760 lb	50 pc	cULus
3000075EG	EG, 3/4" Rod, 3/4" Max Flange	950 lb	760 lb	50 pc	cULus
3000087EG	EG, 7/8" Rod, 3/4" Max Flange	950 lb	760 lb	50 pc	cULus
Finish: Plain					
3000037PL	3/8" Rod, 3/4" Max Flange	500 lb	250 lb	100 pc	cULus, FM
3000050PL	1/2" Rod, 3/4" Max Flange	950 lb	760 lb	50 pc	cULus, FM
3000062PL	5/8" Rod, 3/4" Max Flange	950 lb	760 lb	50 pc	cULus
3000075PL	3/4" Rod, 3/4" Max Flange	950 lb	760 lb	50 pc	cULus
3000087PL	7/8" Rod, 3/4" Max Flange	950 lb	760 lb	50 pc	cULus

Setscrew must be tightened and torqued onto the sloped side of the I-beam. Recognizing that torque wrenches are generally not used or available on many job sites, the setscrew should be tightened so it contacts the I-beam and then an additional 1/4 to 1/2 turn added.



Beam Clamps with nVent CADDY Rod Lock "push-to-install" technology for threaded rod applications are available on page 6-2.

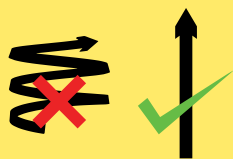

"Push-to-install" Technology

- Prefabricated assemblies easily lift and lock into place, helping to save time and money
- Easy "push-to-install" design allows installers to simply push the threaded rod through the mounting hole, instantly holding it in position
- Lock nut can be finger tightened, locking the rod in place
- Works with slightly damaged threads and minor burrs on the threaded rod

# STRUCTURAL ATTACHMENTS

## Beam/Purlin



### 310 UNIVERSAL BEAM CLAMP, THICK FLANGE

- Universal beam clamp for thick beams
- Conforms with Federal Specification WW-H-171 (Type 23), Manufacturers Standardization Society ANSI®/MSS-SP-58 (Type 19 and 23)



Material: Cast Iron



Part #	Description			
Finish: Electrogalvanized				
3100037EG	EG, 3/8" Rod, 1 1/4" Max Flange	500 lb	250 lb	50 pc
3100050EG	EG, 1/2" Rod, 1 1/4" Max Flange	950 lb	760 lb	50 pc
Finish: Plain				
3100037PL	3/8" Rod, 1 1/4" Max Flange	500 lb	250 lb	50 pc
3100050PL	1/2" Rod, 1 1/4" Max Flange	950 lb	760 lb	50 pc

Setscrew must be tightened and torqued onto the sloped side of the I-beam. Recognizing that torque wrenches are generally not used or available on many job sites, the setscrew should be tightened so it contacts the I-beam and then an additional 1/4 to 1/2 turn added.

### BC26 UNIVERSAL BEAM CLAMP WITH TAPPED HOLE

- One thru-hole for easier installation of threaded rod
- Conforms with Federal Specification WW-H-171 (Type 23), Manufacturers Standardization Society ANSI®/MSS-SP-58 (Type 19 and 23)



Material: Cast Iron

Finish: Electrogalvanized

Part #	Description			
BC260025EG	1/4" Rod, 13/16" Max Flange, 1/4" Hole, Threaded	250 lb	100 lb	100 pc

Setscrew must be tightened and torqued onto the sloped side of the I-beam. Recognizing that torque wrenches are generally not used or available on many job sites, the setscrew should be tightened so it contacts the I-beam and then an additional 1/4 to 1/2 turn added.

# STRUCTURAL ATTACHMENTS

## Beam/Purlin

### 305 STAINLESS STEEL BEAM CLAMP, TOP MOUNT

- Pressed steel beam clamp
- Structural attachment to top flange of metal beams, purlins, channel, or angle iron
- Conforms with Federal Specification WW-H-171 (Type 23), Manufacturers Standardization Society ANSI®/MSS-SP-58 (Type 19)



Material: Stainless Steel 304 (EN 1.4301)



Part #	Description	F ↓	☐
3050037S4	3/8" Rod, 5/8" Max Flange	500 lb	100 pc
3050050S4	1/2" Rod, 5/8" Max Flange	1,130 lb	100 pc

Set screw must be tightened and torqued onto the sloped side of the I-beam, channel, or angle iron flange. Recognizing that torque wrenches are generally not used or available on many job sites, the setscrew should be tightened so it contacts the I-beam and then an additional 1/4 to 1/2 turn added.

### SBC STAMPED BEAM CLAMP, TOP MOUNT

- Allows structural attachment to metal beams, bar joist, channel, or angle iron in top mount position only unless used on a parallel flange
- Lightweight, one-piece stamped body provides superior strength and eliminates deficiencies associated with castings
- Spins onto threaded rod and allows for easy adjustment
- Conforms with Federal Specification WW-H-171 (Type 23), Manufacturers Standardization Society ANSI®/MSS-SP-58 (Type 19)



Material: Steel  
Finish: Pregalvanized



Part #	Description	F ↓	☐
SBC037	3/8" Rod, 3/4" Max Flange	500 lb	50 pc

Set screw must be tightened and torqued onto the sloped side of the I-beam, channel, or angle iron flange. Recognizing that torque wrenches are generally not used or available on many job sites, the setscrew should be tightened so it contacts the I-beam and then an additional 1/4 to 1/2 turn added.

# STRUCTURAL ATTACHMENTS

## Beam/Purlin

### BC BEAM CLAMP

- Easy installation to beam flanges



Material: Spring Steel  
Finish: nVent CADDY Armour



Part #	Description	F ↓	↓ Cube
BC	1/4" Rod 1, #10 Rod 2, 1/2" Max Flange	100 lb	100 pc

Setscrew must be tightened and torqued onto the sloped side of the I-beam.

### BC200/BC400 BEAM CLAMP

- Threaded hole on back and bottom



Material: Steel  
Finish: ElectroGalvanized



Part #	Description	F ↓	↓ Cube
BC200	1/4" Rod, 0.5" Max Flange	100 lb	50 pc
BC400	3/8" Rod, 0.75" Max Flange	200 lb	25 pc

Setscrew must be tightened and torqued onto the sloped side of the I-beam.



# STRUCTURAL ATTACHMENTS

## Beam/Purlin

### BC10 MULTI-FUNCTION BEAM CLAMP

- Structural attachment to beams to support threaded rod



Material: Steel  
Finish: Electrogalvanized

Part #	Description			
BC100000EG	3/8", 1/2" Rod, 3/4" Max Flange	500 lb	300 lb	25 pc

Setscrew must be tightened and torqued onto the sloped side of the I-beam.

### BC10 BEAM CLAMP WITH BC15 SWIVEL

- Swivel attachment suitable for sloped beams



Material: Steel  
Finish: Electrogalvanized

Part #	Description		
BC101500EG	3/8", 1/2" Rod, 3/4" Max Flange	500 lb	25 pc

Setscrew must be tightened and torqued onto the sloped side of the I-beam. Recognizing that torque wrenches are generally not used or available on many job sites, the setscrew should be tightened so it contacts the I-beam and then an additional 1/4 to 1/2 turn added.

# STRUCTURAL ATTACHMENTS

## Beam/Purlin

### BC11/BC12 MULTI-FUNCTION CLAMP WITH J-BOLT

- Structural attachment to beams to support threaded rod
- J-bolt provides additional stability in high vibration environments



Material: Steel  
Finish: Electrogalvanized

Part #	Description			
BC110000EG	3/8", 1/2" Rod, 3/4" Max Flange	500 lb	300 lb	25 pc
BC120000EG	3/8", 1/2" Rod, 3/4" Max Flange	500 lb	300 lb	25 pc



Setscrew must be tightened and torqued onto the sloped side of the I-beam.

### BC13 WELDED BEAM CLAMP, STANDARD DUTY

- Structural attachment to beams to support threaded rod



Material: Steel  
Finish: Electrogalvanized

Part #	Description		
BC130025EG	1/4" Rod, 7/8" Max Flange	650 lb	20 pc
BC130037EG	3/8" Rod, 7/8" Max Flange	650 lb	20 pc
BC130050EG	1/2" Rod, 7/8" Max Flange	1,100 lb	20 pc

Setscrew must be tightened and torqued onto the sloped side of the I-beam. Recognizing that torque wrenches are generally not used or available on many job sites, the setscrew should be tightened so it contacts the I-beam and then an additional 1/4 to 1/2 turn added.

# STRUCTURAL ATTACHMENTS

## Beam/Purlin

### BC14 WELDED BEAM CLAMP, HEAVY DUTY

- Structural attachment to beams to support threaded rod



Material: Steel  
Finish: Electrogalvanized

Part #	Description	F ↓	↓ Cube
BC140037EG	3/8" Rod, 1 5/8" Max Flange	800 lb	20 pc
BC140050EG	1/2" Rod, 1 5/8" Max Flange	1,300 lb	20 pc
BC140062EG	5/8" Rod, 1 5/8" Max Flange	1,900 lb	10 pc

Setscrew must be tightened and torqued onto the sloped side of the I-beam. Recognizing that torque wrenches are generally not used or available on many job sites, the setscrew should be tightened so it contacts the I-beam and then an additional 1/4 to 1/2 turn added.

### C-CLAMP

- Pressed steel beam clamp
- Conforms with Federal Specification WW-H-171 (Type 23), Manufacturers Standardization Society ANSI®/MSS-SP-58 (Type 23)



Material: Steel  
Finish: Electrogalvanized  
Static Load Safety Factor: 3.5:1

Part #	Description	F ↓	↓ Cube
2000037EG	EG, 3/8" Rod, 3/4" Max Flange	250 lb	100 pc

Setscrew must be tightened and torqued onto the sloped side of the I-beam. Recognizing that torque wrenches are generally not used or available on many job sites, the setscrew should be tightened so it contacts the I-beam and then an additional 1/4 to 1/2 turn added.

Setscrew must be tightened and torqued onto the sloped side of the I-beam. Load rating is per fastener with a 3X safety factor. Actual installation must be evaluated to determine load on the individual fastener. Recognizing that torque wrenches are generally not used or available on many job sites, the setscrew should be tightened so it contacts the I-beam and then an additional 1/4 to 1/2 turn added.

# STRUCTURAL ATTACHMENTS

## Beam/Purlin

### RS RETROFIT RETAINER STRAP

- Ideal for both new and existing applications
- Can be installed without disassembly of the hanging system and/or removing the clamp
- Compatible with all standard nVent CADDY beam clamps and can be secured to either the set screw or threaded rod
- Large teardrop-shaped opening is compatible with multiple threaded rod diameters, reducing inventory by 50%
- Coined edge on teardrop-shaped opening locks into rod, eliminating shifting during install
- Provides a secure attachment in seismic zones and complies with NFPA® requirements
- Meets the UL® load test for retainer straps (3/8" and 1/2" rod sizes)



Material: Steel  
Finish: Pregalvanized



Part #	Description	
RS06	6 1/2"	100 pc
RS08	8 1/2"	100 pc
RS10	10 1/2"	100 pc
RS12	12 1/2"	100 pc
RS14	14 1/2"	100 pc
RS16	16 1/2"	100 pc
RS18	18 1/2"	50 pc

Add 2" to width of flange to determine minimum length strap required.

# STRUCTURAL ATTACHMENTS

## Beam/Purlin

### 35RS TWO HOLE RETAINER STRAP

- Retainer strap for beam clamps



Material: Steel  
Finish: Pregalvanized

Part #	Description	
035RS0600EG	6"	100 pc
035RS0800EG	8"	100 pc
035RS1000EG	10"	100 pc
035RS1200EG	12"	100 pc
035RS1400EG	14"	100 pc
035RS1600EG	16"	100 pc
035RS1800EG	18"	100 pc

Field bend and use jam nut over hanger rod to secure.

### BC09 RETAINER STRAP FOR BC13/14 SERIES

- Retainer strap for BC13/BC14 beam clamps

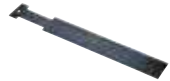

Material: Steel  
Finish: Electrogalvanized

Part #	Description	
BC090900EG	9"	50 pc
BC091200EG	12"	50 pc
BC091500EG	15"	25 pc

# STRUCTURAL ATTACHMENTS

## Beam/Purlin



### NVENT CADDY TRUSS-T BAR JOIST HANGER, BOTTOM CHORD

- Easily installs on the bottom chord of engineered open web bar joists from underneath, limiting overhead work
- Innovative attachment effortlessly slides through the middle slot of open web bar joists and quickly locks into place when put under load
- Installation of the complete, self-contained system can be accomplished with one hand and requires no additional special tools
- The unique design of the nVent CADDY Truss-T hanger does not need to be tightened like a traditional beam clamp, providing greater adjustability and speed during system alignment
- Prefabricated single pipe hanger and multi-pipe/tube trapeze assemblies can be prefabricated on the ground or in the shop, and easily hung by the installer
- Concentrically loading the bar joist chord eliminates torsion and/or distortion, adhering to the strict rules established by the Steel Joist Institute (SJI)
- The increased load carrying capacity results in the product being UL listed to support a maximum of 8" Schedule 40 pipe
- Included square washer with integrated threaded nut eliminates the need for loose hardware
- Made in the USA



Material: Steel  
Finish: Pregalvanized  
Static Load Safety Factor: 3.5:1



Part #	Description		
CTH037BC	3/8" Rod	1,200 lb	25 pc
CTH050BC	1/2" Rod	1,200 lb	25 pc

# STRUCTURAL ATTACHMENTS

## Beam/Purlin



### **nVent CADDY TRUSS-T BAR JOIST HANGER, TOP CHORD**

- Easily installs on the top chord of engineered open web bar joists from underneath, limiting overhead work
- Innovative attachment effortlessly slides through the middle slot of open web bar joists and quickly locks into place when put under load
- Installation of the complete, self-contained system can be accomplished with one hand and requires no additional special tools
- The unique design of the nVent CADDY Truss-T hanger does not need to be tightened like a traditional beam clamp, providing greater adjustability and speed during system alignment
- Prefabricated single pipe hanger and multi-pipe/tube trapeze assemblies can be prefabricated on the ground or in the shop, and easily hung by the installer
- Concentrically loading the bar joist chord eliminates torsion and/or distortion, adhering to the strict rules established by the Steel Joist Institute (SJI)
- The increased load carrying capacity results in the product being UL listed to support a maximum of 8" Schedule 40 pipe
- Included square washer with integrated threaded nut eliminates the need for loose hardware
- Made in the USA



Material: Steel  
Finish: Pregalvanized  
Static Load Safety Factor: 3.5:1



Part #	Description		
CTH037TC	3/8" Rod	1,200 lb	25 pc
CTH050TC	1/2" Rod	1,200 lb	25 pc

# STRUCTURAL ATTACHMENTS

## Beam/Purlin

### PH MULTI-PURPOSE PURLIN CLAMP

- Attaches to bottom of purlins and beams to support threaded rod



Material: Steel  
Finish: Electrogalvanized



Part #	Description	Static Load 1	Static Load 2	
PH4	1/4" Rod, 1/4" Max Flange	200 lb	160 lb	25 pc
PH6	3/8" Rod, 1/4" Max Flange	200 lb	160 lb	25 pc
PH6FP	3/8" Rod, 1/4" Max Flange	200 lb		25 pc

A jam nut is required for fire protection applications. Refer to Static Load 1 when attaching to C and Z purlins. Refer to Static Load 2 when attaching to a flat flange. Recognizing that torque wrenches are generally not used or available on many job sites, the setscrew should be tightened so it contacts the I-beam and then an additional 1/4 to 1/2 turn added.

### PHSW MULTI-PURPOSE PURLIN CLAMP WITH SWIVEL

- Attachment to bottom of purlins and beams to support threaded rod
- Swivel feature option for attachment to purlins under sloped roofs



Material: Steel  
Finish: Electrogalvanized



Part #	Description	Static Load 1	Static Load 2	
PHSW4	1/4" Rod, 1/4" Max Flange	200 lb	160 lb	25 pc
PHSW6	3/8" Rod, 1/4" Max Flange	200 lb	160 lb	25 pc
PHSW6FP	3/8" Rod, 1/4" Max Flange	200 lb		25 pc

A jam nut is required for fire protection applications. Refer to Static Load 1 when attaching to C and Z purlins. Refer to Static Load 2 when attaching to a flat flange. Recognizing that torque wrenches are generally not used or available on many job sites, the setscrew should be tightened so it contacts the I-beam and then an additional 1/4 to 1/2 turn added.



## STRUCTURAL ATTACHMENTS

### Beam/Purlin

#### 315 MALLEABLE IRON PURLIN CLAMP

- Attaches to lower flange of metal beams or purlins
- Supports 45° flanges up to 2" long, and 90° flanges up to 1-1/2" high
- Conforms with Federal Specification WW-H-171 (Type 23), Manufacturers Standardization Society ANSI®/MSS-SP-58 (Type 23)



Material: Cast Iron



Part #	Description	F ↓	↓
Finish: Electrogalvanized			
3150037EG	EG, 3/8" Rod, 1" Max Flange	400 lb	25 pc
Finish: Plain			
3150037PL	3/8" Rod, 1" Max Flange	400 lb	25 pc

Setscrew must be tightened and torqued onto the sloped side of the I-beam. Install in accordance with applicable code. Recognizing that torque wrenches are generally not used or available on many job sites, the setscrew should be tightened so it contacts the I-beam and then an additional 1/4 to 1/2 turn added.

#### 122 SERIES Z PURLIN CLIP

- Hammer-on clip compensates for angle of purlin
- Provides a portable hole
- Side mount



Material: Spring Steel  
Finish: nVent CADDY Armour



Part #	Description	F ↓	↓
122	1/4" Hole, 1/16" Max Flange	100 lb	100 pc

# STRUCTURAL ATTACHMENTS

## Beam/Purlin

### 123 SERIES Z PURLIN CLIP

- Hammer-on clip compensates for angle of purlin
- Provides method for attaching conduit and boxes to purlin
- Bottom mount



Material: Spring Steel  
Finish: nVent CADDY Armour



Part #	Description	F ↓	☐
123	1/4" Hole, 0.06"-0.1" Flange	100 lb	100 pc

### AF SERIES Z PURLIN CLIP

- Angle flange clip for wire or chain suspensions from Z purlins
- Installs from floor with VAFT tool and conduit



Material: Spring Steel  
Finish: nVent CADDY Armour



Part #	Description	F ↓	☐
AF14	1/4" Hole, 1/16"-1/4" Flange	100 lb	100 pc

### VF SERIES C PURLIN CLIP

- Provides an attachment for nVent CADDY Speed Link assemblies, wire, S-hooks, or chain from purlin and bar joist
- Installs from floor with VAFT tool and conduit



Material: Spring Steel  
Finish: nVent CADDY Armour



Part #	Description	F ↓	☐
VF14	1/16"-1/4" Flange, 1/4" Hole	160 lb	100 pc

# STRUCTURAL ATTACHMENTS

## Beam/Purlin

### VAFT INSTALLATION TOOL FOR PURLIN CLIPS

- Installation tool for VF & AF assemblies
- Used to install the AF or VF rod clips from the floor



Material: Steel

Part #	Description	
VAFT	Installation Tool	1 pc
VAFTR	Replacement Parts	1 pc

### HAMMER-ON FLANGE CLIP, BOTTOM MOUNT

- Can be used to support boxes, fixtures or other applications from beam flanges
- Assorted attachment points provided to reduce inventory
- Requires only a hammer to install



Material: Spring Steel  
Finish: nVent CADDY Armour



Part #	Flange Thickness FT	Rod Size	F1	F2	F3	
M24	1/8"–1/4"	1/4"	100 lb	25 lb	75 lb	100 pc
M58	5/16"–1/2"	1/4"	100 lb	25 lb	75 lb	100 pc
M912	9/16"–3/4"	1/4"	100 lb	25 lb	75 lb	100 pc
M1318	13/16"–1 1/8"	1/4"	100 lb	25 lb	75 lb	50 pc

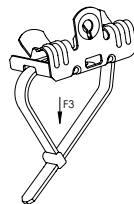
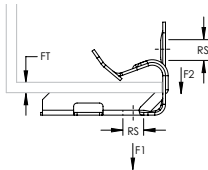

# STRUCTURAL ATTACHMENTS

## Beam/Purlin

### HAMMER-ON FLANGE CLIP, BOTTOM MOUNT WITH STUD

- Can be used to support boxes, fixtures or other applications from beam flanges
- Captive threaded stud minimizes the need for additional hardware
- Assorted attachment points provided to reduce inventory
- Requires only a hammer to install



Material: Spring Steel  
Finish: nVent CADDY Armour



Part #	Flange Thickness FT	Rod Size	Screw Dia. SC	Screw Length L	F1	F2	F3	
M24S	1/8"-1/4"	1/4"	1/4"	3/8"	100 lb	75 lb	25 lb	100 pc
M58S	5/16"-1/2"	1/4"	1/4"	3/8"	100 lb	75 lb	25 lb	100 pc
M912S	9/16"-3/4"	1/4"	1/4"	3/8"	100 lb	75 lb	25 lb	100 pc
M1318S	13/16"-1 1/8"	1/4"	1/4"	3/8"	100 lb	75 lb	25 lb	50 pc

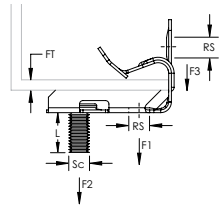

### HAMMER-ON FLANGE CLIP, BOTTOM MOUNT WITH RETAINER

- Pre-riveted retainer strap is easily bent into position
- Requires only a hammer to install
- 4WN washer wing nut included



Material: Spring Steel  
Finish: nVent CADDY Armour

Part #	Description		
CM24S	1/8"-1/4" Flange, 8.5" Strap	75 lb	50 pc
CM58S	5/16"-1/2" Flange, 13" Strap	75 lb	50 pc
CM912S	9/16"-3/4" Flange, 13" Strap	75 lb	50 pc

## STRUCTURAL ATTACHMENTS

### Beam/Purlin

#### HAMMER-ON FLANGE CLIP, SIDE MOUNT

- Provides an attachment for wire, S-hooks, chain, nVent CADDY Speed Link or other assemblies to flanges and profiles
- Fits most beams
- Installs with just a hammer



Part #	Description	F		Cert
Material: Spring Steel – Finish: nVent CADDY Armour				
2H4	3/32"–9/64" Flange	160 lb	100 pc	cULus
4H24	1/8"–1/4" Flange	200 lb	100 pc	CE, 4H, EM, EBC, cULus
4H58	5/16"–1/2" Flange	200 lb	100 pc	
4H912	9/16"–3/4" Flange	200 lb	100 pc	
4H1318	13/16"–1 1/8" Flange	200 lb	50 pc	cULus
Material: Stainless Steel 301 (EN 1.4310)				
4H24SS	S301, 1/8"–1/4" Flange	140 lb	100 pc	
4H58SS	S301, 5/16"–1/2" Flange	140 lb	100 pc	
4H912SS	S301, 9/16"–3/4" Flange	140 lb	100 pc	

#### H-TI/T ROD TO FLANGE CLIP

- Suspends threaded rod from beam flanges
- Threaded rod hanger can swivel to provide a vertical dropdown
- Requires only a hammer to install



Material: Spring Steel  
Finish: nVent CADDY Armour



Part #	Description	F	
4TI24	0.25" Hole, Threaded, 0.125"–0.25" Flange	200 lb	100 pc
4TI58	0.25" Hole, Threaded, 0.3125"–0.5" Flange	200 lb	100 pc
4TI912	0.25" Hole, Threaded, 0.5625"–0.75" Flange	200 lb	100 pc
6TA24	0.375" Hole, Plain, 0.125"–0.25" Flange	200 lb	100 pc
6TA58	0.375" Hole, Plain, 0.3125"–0.5" Flange	200 lb	100 pc
6TA912	0.375" Hole, Plain, 0.5625"–0.75" Flange	200 lb	100 pc
6TI24	0.375" Hole, Threaded, 0.125"–0.25" Flange	200 lb	100 pc
6TI58	0.375" Hole, Threaded, 0.3125"–0.5" Flange	200 lb	100 pc
6TI912	0.375" Hole, Threaded, 0.5625"–0.75" Flange	200 lb	100 pc

# STRUCTURAL ATTACHMENTS

## Beam/Purlin

### **nVENT CADDY ROD LOCK SPRING STEEL ROD HANGER TO FLANGE CLIP**

- Suspends threaded rod from beam flanges
- Threaded rod hanger can swivel to provide a vertical dropdown
- Requires only a hammer to install
- Easy “push-to-install” design allows installers to simply push the threaded rod through the mounting hole, instantly holding it in position
- Prefabricated assemblies easily lift and lock into place, helping to save time and money
- Works with slightly damaged threads and minor burrs on threaded rod ends
- Design includes a release mechanism that works with pliers



**Innovative  
Solution**

Material: Spring Steel  
Finish: nVent CADDY Armour

Part #	Description	F ↓	☐
4QT124	1/4" Rod, 1/8"–1/4" Flange	75 lb	100 pc
4QT158	1/4" Rod, 5/16"–1/2" Flange	75 lb	100 pc
4QT1912	1/4" Rod, 9/16"–3/4" Flange	75 lb	100 pc

### **H-6A ROD TO FLANGE CLIP**

- Requires only a hammer to install



Material: Spring Steel  
Finish: nVent CADDY Armour



Part #	Description	F ↓	☐
6A24	1/8"–1/4" Flange, 3/8" Rod	200 lb	100 pc
6A58	5/16"–1/2" Flange, 3/8" Rod	200 lb	100 pc
6A912	9/16"–3/4" Flange, 3/8" Rod	200 lb	100 pc

## STRUCTURAL ATTACHMENTS

### Beam/Purlin

#### H-708 ROD/WIRE TO FLANGE CLIP

- Requires only a hammer to install



Material: Spring Steel  
Finish: nVent CADDY Armour



Part #	Description	F ↓	☐
70824	1/8"–1/4" Flange, 1/4" Rod, #8 Wire	200 lb	100 pc
70858	5/16"–1/2" Flange, 1/4" Rod, #8 Wire	200 lb	100 pc
708912	9/16"–3/4" Flange, 1/4" Rod, #8 Wire	200 lb	100 pc

#### NVENT CADDY ROD LOCK SPRING STEEL ROD HANGER TO BEAM CLAMP

- Suspends threaded rod from beam flanges
- Threaded rod hanger can swivel to provide a vertical dropdown
- Easy "push-to-install" design allows installers to simply push the threaded rod through the mounting hole, instantly holding it in position
- Prefabricated assemblies easily lift and lock into place, helping to save time and money
- Works with slightly damaged threads and minor burrs on threaded rod ends
- Design includes a release mechanism that works with pliers



**Innovative  
Solution**

Material: Spring Steel  
Finish: nVent CADDY Armour

Part #	Description	F ↓	☐
4QTIBC	1/4" Rod	75 lb	100 pc

# STRUCTURAL ATTACHMENTS

## Beam/Purlin

### 122-6A ROD TO Z PURLIN CLIP

- Hammer-on clip compensates for angle of purlin
- Provides method for attaching rod to Z purlin



Material: Spring Steel  
Finish: nVent CADDY Armour



Part #	Description	F ↓	↓ ↓
1226A	3/8" Rod, 1/16"-1/4" Flange	100 lb	100 pc

Loads indicated are for nVent CADDY Fasteners only.

### 122-708 ROD/WIRE TO Z PURLIN CLIP

- Hammer-on clip compensates for angle of purlin
- Provides method for attaching rod to Z purlin



Material: Spring Steel  
Finish: nVent CADDY Armour



Part #	Description	F ↓	↓ ↓
122708	1/4" Rod, #8 Wire, 1/16"-1/4" Flange	100 lb	100 pc



## STRUCTURAL ATTACHMENTS

### Beam/Purlin

#### 122-TI/T ROD TO Z PURLIN CLIP

- Hammer-on clip compensates for angle of purlin
- Provides method for attaching rod to purlin



Material: Spring Steel  
Finish: nVent CADDY Armour



Part #	Description	F ↓	☐
1224T1	0.25" Hole, Threaded, 0.0625"-0.25" Flange	100 lb	100 pc
1226T	0.375" Hole, Plain, 0.0625"-0.25" Flange	100 lb	100 pc
1226T1	0.375" Hole, Threaded, 0.0625"-0.25" Flange	100 lb	100 pc

#### AF-6A ROD TO Z-PURLIN CLIP

- Hammer-on or install from the floor with the VAFT tool
- Supports plain rod from bar joist and Z-Purlin



Material: Spring Steel  
Finish: nVent CADDY Armour



Part #	Description	F ↓	☐
AF146A	3/8" Rod, 1/16"-1/4" Flange	100 lb	100 pc

## STRUCTURAL ATTACHMENTS

### Beam/Purlin

#### AF-708 ROD/WIRE TO Z PURLIN CLIP

- Hammer-on or install from the floor with the VAFT tool
- Provides an attachment for nVent CADDY Speed Link assemblies, wire, S-hooks, or chain from purlin and bar joist



Material: Spring Steel  
Finish: nVent CADDY Armour



Part #	Description	F ↓	↓ Cube
AF14708	1/4" Rod, #8 Wire, 1/16"-1/4" Flange	100 lb	100 pc

#### AF-TI/T ROD TO Z PURLIN CLIP

- Used to support 1/4" and 3/8" threaded rod from purlin beam flanges 1/16" thru 1/4" thick
- Hammer-on or install from the floor with the VAFT tool
- Provides method for attaching rod to Z purlin



Material: Spring Steel  
Finish: nVent CADDY Armour



Part #	Description	F ↓	↓ Cube
AF144TI	1/4" Hole, Threaded, 1/16"-1/4" Flange	100 lb	100 pc
AF146T	3/8" Hole, Plain, 1/16"-1/4" Flange	100 lb	100 pc
AF146TI	3/8" Hole, Threaded, 1/16"-1/4" Flange	100 lb	100 pc

## STRUCTURAL ATTACHMENTS

### Beam/Purlin

#### VF-6A ROD TO C-PURLIN CLIP

- Hammer-on or install from the floor with the VAFT tool
- Supports plain rod from bar joist and C-Purlin



Material: Spring Steel  
Finish: nVent CADDY Armour



Part #	Description	F	
VF146A	3/8" Rod, 1/16"-1/4" Flange	160 lb	100 pc

#### VF-708 ROD/WIRE TO C PURLIN CLIP

- Supports wire or rod from bar joist and C purlin
- Hammer-on or install from the floor with the VAFT tool



Material: Spring Steel  
Finish: nVent CADDY Armour



Part #	Description	F	
VF14708	1/4" Rod, #8 Wire, 1/16"-1/4" Flange	160 lb	100 pc

# STRUCTURAL ATTACHMENTS

## Beam/Purlin

### VF-TI/T ROD TO C-PURLIN CLIP

- Hammer-on or install from the floor with the VAFT tool
- Provides an attachment for nVent CADDY Speed Link assemblies, wire, S-hooks, or chain from purlin and bar joist



Material: Spring Steel  
Finish: nVent CADDY Armour



Part #	Description	F ↓	☐
VF144TI	1/4" Hole, Threaded, 1/16"-1/4" Flange	160 lb	100 pc
VF146T	3/8" Hole, Plain, 1/16"-1/4" Flange	160 lb	100 pc
VF146TI	3/8" Hole, Threaded, 1/16"-1/4" Flange	160 lb	100 pc

### BULB TEE CLIP

- Provides means of support from underside of bulb tee
- Ceiling material not defaced when correctly applied
- Requires only a hammer to install



Material: Spring Steel  
Finish: nVent CADDY Armour

Part #	Description	F ↓	☐
4J2438	3/16" Max Flange	135 lb	100 pc
4J2438S	3/16" Max Flange, 1/4" Screw	135 lb	100 pc

## STRUCTURAL ATTACHMENTS

### Deck

#### TDH TRAPEZOIDAL DECK HANGER

- Easy install
- If thread connection is required, use square nut THHM and snap in
- Use TDHP perforation tool to punch hole in decking



Material: Spring Steel  
Finish: nVent CADDY Armour

Part #	Description	Cert	
TDH	Spring Steel	ITB	50 pc

Ceiling Thickness	Static Load
.0248" - .0276"	130 lb
.0277" - .0315"	150 lb
.0316" - .0394"	180 lb
.0395" - .0472"	225 lb

#### TDHT TRAPEZOIDAL DECK HANGER WITH NUT

- Easy install
- Use TDHP perforation tool to punch hole in decking



Material: Spring Steel  
Finish: nVent CADDY Armour

Part #	Description	
TDHT4	1/4" Rod	50 pc
TDHT6	3/8" Rod	50 pc

Ceiling Thickness	Static Load
.0248" - .0276"	130 lb
.0277" - .0315"	150 lb
.0316" - .0394"	180 lb
.0395" - .0472"	225 lb

# STRUCTURAL ATTACHMENTS

## Deck

### TDHP TRAPEZOIDAL DECK HOLE PUNCH

- Includes springs for quick release
- Height adjustable
- Replacement die set available



Material: Steel

Part #	Description	
TDHP2	TDHP Trapezoidal Deck Hole Punch	1 pc

### REPLACEMENT DIE FOR TDHP TRAPEZOIDAL DECK HOLE PUNCH

- Includes two punches with springs, nuts and washers



Material: Steel

Part #	Description	
TDHP2PR10	Replacement Die for TDHP Trapezoidal Deck Hole Punch	1 pc



### CELLULAR FLOOR DECK HANGER

- Positive locking through deck tab
- Prevents twisting or loosening due to vibration



Material: Spring Steel  
Finish: nVent CADDY Armour



Part #	Description		
DH2	Cellular Floor Deck Hanger	160 lb	100 pc

Check with deck manufacturer for recommended load capacity.

## STRUCTURAL ATTACHMENTS

### Deck

#### CELLULAR FLOOR DECK HANGER FOR THREADED ROD

- Positive locking through deck tab
- Prevents twisting or loosening due to vibration



Material: Spring Steel  
Finish: nVent CADDY Armour



Part #	Description	F ↓	☐
DH4TI	1/4" Hole, Threaded	160 lb	100 pc
DH6TI	3/8" Hole, Threaded	160 lb	100 pc

Check with deck manufacturer for recommended load capacity.

#### STANDOFF DECK ANGLE BRACKET

- Meets the requirements of NEC® Section 300.4(E)
- Supports conduit or pipe 1-1/2" (38 mm) under the roof decking to prevent potential damage from nails or screws



Material: Steel  
Finish: Plain

Part #	Description	☐
CPNAM	1 1/2"	100 pc

# STRUCTURAL ATTACHMENTS

## Wall/Ceiling

### 365 STEEL WALL OR CEILING PLATE

- Structural attachment to support hanger rod from a ceiling or a wall



Material: Steel

Part #	Description	F ↓	↓ Cube
Finish: Copper Electroplated			
3650037CP	CP, 3/8" Rod	100 lb	250 pc
Finish: Electrogalvanized			
3650037EG	EG, 3/8" Rod	100 lb	250 pc
Finish: Plain			
3650037PL	3/8" Rod	100 lb	250 pc

Follow fastener manufacturer's recommended shear and pull-out strength when fastening to the structure. Fastener not included.

### 365M MALLEABLE IRON WALL OR CEILING PLATE

- Structural attachment to support hanger rod from a ceiling or a wall



Material: Cast Iron

Part #	Description	F ↓	↓ Cube
Finish: Copper Electroplated			
365M0037CP	CP, 3/8" Rod	180 lb	100 pc
365M0050CP	CP, 1/2" Rod	180 lb	100 pc
Finish: Electrogalvanized			
365M0037EG	EG, 3/8" Rod	180 lb	100 pc
365M0050EG	EG, 1/2" Rod	180 lb	100 pc
Finish: Plain			
365M0037PL	3/8" Rod	180 lb	100 pc
365M0050PL	1/2" Rod	180 lb	100 pc

Follow fastener manufacturer's recommended shear and pull-out strength when fastening to the structure. Fastener not included.



## STRUCTURAL ATTACHMENTS

### Wall/Ceiling

#### 352 STANDARD DUTY WELDED WALL BRACKET

- Wall attachment to support or suspend static piping
- Conforms with Federal Specification WW-H-171 (Type 32), Manufacturers Standardization Society ANSI®/MSS-SP-58 (Type 32)



Material: Steel  
Finish: Plain

Part #	Description	F ↓	☐
3520100PL	18"	1,500 lb	1 pc
3520200PL	24"	1,500 lb	1 pc
3520300PL	30"	1,500 lb	1 pc

Follow fastener manufacturer's recommended shear and pull-out strength when fastening to the structure. Fastener not included. Install in accordance with applicable code.

#### DROP SMOOTH ROD WITH SHOT-FIRE BRACKET

- Quickly and easily attaches to concrete, steel or composite metal decking
- Integrated pin installs easily using powder-actuated or single-shot gas-actuated tools
- Works with most standard nVent CADDY spring steel fasteners designed for rod attachments
- Rod is rigid and does not require secondary attachment to ceiling grid per NEC 300.11
- Stocked inventory - available when you need it
- Includes pre-assembled end-cap
- Specialized packaging simplifies material handling and minimizes sorting
- Rods are ready to install out of the box



Material: Steel  
Finish: Electrogalvanized



Part #	Description	F ↓	☐
DR4SF12	12", 0.215" dia	95 lb	50 pc
DR4SF24	24", 0.215" dia	95 lb	50 pc
DR4SF36	36", 0.215" dia	95 lb	50 pc
DR4SF48	48", 0.215" dia	95 lb	25 pc

Works with Powers® C4CZ, Simpson® GCN-MEPKT, SPIT® P1000, P200, P2201, P3500 / PA3500, P35s, P45, P60, P7201, Sniper; Ramset® 721, Cobra, D45 / D60 / D60L, M70, SA270, T3SS, TS750P, TS60P, Viper; Hilti® DX35, DX350 / DX351 / DX36M, DX100 / DX200, DX460, DXA40, DXA41, DXE72 / DX400; Würth® Diva-1, BST-1, BST-2 or equivalent nailers. For shot-fired supports in seismic design category D, E, or F, maximum load is the lesser of 90 lb (400 N) or the published load. Exempt from seismic design when supporting conduits less than 2-1/2" (64 mm) trade size, regardless of Ip.

# STRUCTURAL ATTACHMENTS

## Rod/Wire

### DROP THREADED ROD WITH SHOT-FIRE BRACKET

- Quickly and easily attaches to concrete, steel or composite metal decking
- Integrated pin installs easily using powder-actuated or single-shot gas-actuated tools
- Works with most standard nVent CADDY spring steel fasteners designed for rod attachments
- Rod is rigid and does not require secondary attachment to ceiling grid per NEC 300.11
- Stocked inventory - available when you need it
- Includes pre-assembled end-cap
- Specialized packaging simplifies material handling and minimizes sorting
- Rods are ready to install out of the box



Material: Steel  
Finish: Electrogalvanized



Part #	Description	F ↓	📦
DR4TSF12	12", 1/4" Rod	95 lb	50 pc
DR4TSF24	24", 1/4" Rod	95 lb	50 pc
DR4TSF36	36", 1/4" Rod	95 lb	50 pc
DR4TSF48	48", 1/4" Rod	95 lb	25 pc
DR4TSF60	60", 1/4" Rod	95 lb	500/pallet
DR4TSF72	72", 1/4" Rod	95 lb	500/pallet

Works with Powers® C4CZ, Simpson® GCN-MEPKT, SPIT® P1000, P200, P2201, P3500 / PA3500, P35s, P45, P60, P7201, Sniper; Ramset® 721, Cobra, D45 / D60 / D60L, M70, SA270, T3SS, TS750P, TS60P, Viper; Hilti® DX35, DX350 / DX351 / DX36M, DX100 / DX200, DX460, DXA40, DXA41, DXE72 / DX400; Würth® Diva-1, BST-1, BST-2 or equivalent nailers. For shot-fired supports in seismic design category D, E, or F, maximum load is the lesser of 90 lb (400 N) or the published load. Exempt from seismic design when supporting conduits less than 2-1/2" (64 mm) trade size, regardless of lp.

### PUSH INSTALL ROD HANGER

- Suspends plain rod from vertical structures such as laminated wood or concrete beams, joists, ceilings and walls



Material: Spring Steel  
Finish: nVent CADDY Armour



Part #	Description	F ↓	📦
6A	3/8" Rod	160 lb	100 pc

# STRUCTURAL ATTACHMENTS

## Rod/Wire

### PUSH INSTALL ROD HANGER WITH SHOT-FIRE BRACKET

- Suspends plain rod from horizontal structures
- Complete with shot-fire bracket and pre-assembled drive pin
- Quickly and easily attaches to concrete, steel or composite metal decking
- Integrated pin installs easily using powder-actuated or single-shot gas-actuated tools
- ICC-ES ESR-2024 evaluation report available for drive pin



Material: Steel, Spring Steel

Finish: Electrogalvanized, nVent CADDY Armour

Part #	Description	F	
6ASF	3/8" Rod	100 lb	100 pc

Works with Powers® C4CZ, Simpson® GCN-MEPKT, SPIT® P1000, P200, P2201, P3500 / PA3500, P35s, P45, P60, P7201, Sniper; Ramset® 721, Cobra, D45 / D60 / D60L, M70, SA270, T3SS, TS750P, TS60P, Viper; Hilti® DX35, DX350 / DX351 / DX36M, DX100 / DX200, DX460, DXA40, DXA41, DXE72 / DX400; Würth® Diva-1, BST-1, BST-2 or equivalent nailers. For shot-fired supports in seismic design category D, E, or F, maximum load is the lesser of 90 lb (400 N) or the published load.

### PUSH INSTALL ROD HANGER WITH ANGLE BRACKET

- Suspends plain rod from horizontal structures such as laminated wood or concrete beams, joists, ceilings and walls



Material: Spring Steel, Steel

Finish: nVent CADDY Armour, Pregalvanized



Part #	Description	F	
6AB	3/8" Rod, 0.25" Hole	160 lb	100 pc

Loads indicated are for nVent CADDY Fasteners only. Method of attachment to structure must be evaluated separately.

# STRUCTURAL ATTACHMENTS

## Rod/Wire

### PUSH INSTALL ROD/WIRE HANGER

- Permits pre-assembly of wire or plain rod



Material: Spring Steel  
Finish: nVent CADDY Armour



Part #	Description	F	
708	1/4" Rod, #8 Wire	160 lb	100 pc

### PUSH INSTALL ROD/WIRE HANGER WITH SHOT-FIRE BRACKET

- Permits pre-assembly of wire or plain rod
- Suspends wire or plain rod from horizontal structures
- Complete with shot-fire bracket and pre-assembled drive pin
- Quickly and easily attaches to concrete, steel or composite metal decking
- Integrated pin installs easily using powder-actuated or single-shot gas-actuated tools
- ICC-ES ESR-2024 evaluation report available for drive pin



Material: Steel, Spring Steel  
Finish: Electrogalvanized, nVent CADDY Armour

Part #	Description	F	
708SF	1/4" Rod	100 lb	100 pc

Works with Powers® C4CZ, Simpson® GCN-MEPKT, SPIT® P1000, P200, P2201, P3500 / PA3500, P35s, P45, P60, P7201, Sniper, Ramset® 721, Cobra, D45 / D60 / D60L, M70, SA270, T3SS, TS750P, TS60P, Viper; Hilti® DX35, DX350 / DX351 / DX36M, DX100 / DX200, DX460, DXA40, DXA41, DXE72 / DX400; Würth® Diva-1, BST-1, BST-2 or equivalent nailers. For shot-fired supports in seismic design category D, E, or F, maximum load is the lesser of 90 lb (400 N) or the published load.

## STRUCTURAL ATTACHMENTS

### Rod/Wire

#### PUSH INSTALL ROD/WIRE HANGER WITH NAIL GUN BRACKET

- Permits pre-assembly of wire or plain rod
- Suspends wire or plain rod from horizontal structures
- Complete with concrete nail gun insert bracket
- Clips onto nozzle of gas or battery-actuated nail guns allowing for hands-off installation at structure or from the floor using a pole
- Longer leg angle bracket for tool clearance
- Quickly and easily attaches to concrete, steel or composite metal decking



Material: Steel, Spring Steel  
Finish: Electrogalvanized, nVent CADDY Armour

Part #	Description	F ↓	📦
708GBSF	1/4" Rod	100 lb	100 pc

Static Load represents the static load of the nail gun insert assembly. Please consult with the nail manufacturer to evaluate the static load of the nail and type of concrete used for the installation. Maximum load is the lesser of the static load from the nail manufacturer or the published load for the assembly. Nail gun insert is compatible with BeA® CN60-688ES, Hilti® BX 3, GX 3, DEWALT® Trak-It C3, SPIT® PULSA 800E, 700, 1000 or equivalent nailers.

#### PUSH INSTALL ROD/WIRE HANGER WITH ANGLE BRACKET

- Suspends wire or plain rod from horizontal structures such as laminated wood or concrete beams, joists, ceilings and walls



Material: Steel, Spring Steel  
Finish: Pregalvanized, nVent CADDY Armour



Part #	Description	F ↓	📦
708AB	1/4" Rod, #8 Wire	160 lb	100 pc

Loads indicated are for nVent CADDY Fasteners only. Method of attachment to structure must be evaluated separately.

# STRUCTURAL ATTACHMENTS

## Rod/Wire

### PUSH INSTALL ROD/WIRE HANGER WITH OFFSET BRACKET

- Suspends plain rod, threaded rod or wire drops from vertical structures such as laminated wood or concrete beams, joists, ceilings and walls



Material: Steel, Spring Steel  
Finish: Pregalvanized, nVent CADDY Armour



Part #	Description	F	⊞
708AO	1/4" Rod, #8 Wire	160 lb	100 pc

Loads indicated are for nVent CADDY Fasteners only. Method of attachment to structure must be evaluated separately.

### PUSH INSTALL ROD/WIRE HANGER WITH PIN DRIVEN ANGLE BRACKET

- Longer leg angle bracket for tool clearance
- Designed to fit a variety of pin drivers
- Improved for easier installation with pin drivers



Material: Steel, Spring Steel  
Finish: Pregalvanized, nVent CADDY Armour

Part #	Description	F	⊞
708AFAB3	1/4" Rod, #8 Wire	160 lb	100 pc

Load limits apply to nVent CADDY Fasteners only. Pin must be evaluated separately.

## STRUCTURAL ATTACHMENTS

### Rod/Wire

#### THREAD INSTALL ROD HANGER

- Supports wire or rod from block or concrete walls



Material: Spring Steel  
Finish: nVent CADDY Armour



Part #	Description	F	
4TI	0.25" Hole 1, Threaded, 0.25" Hole 2	160 lb	100 pc
6T	0.375" Hole 1, Plain, 0.25" Hole 2	160 lb	100 pc
6TI	0.375" Hole 1, Threaded, 0.25" Hole 2	160 lb	100 pc

#### THREAD INSTALL ROD HANGER WITH ANGLE BRACKET

- Suspends threaded rod from horizontal structures such as laminated wood or concrete beams, joists, ceilings and walls



Material: Spring Steel, Steel  
Finish: nVent CADDY Armour, Pregalvanized



Part #	Description	F	
4TIB	0.25" Hole 1, Plain, 0.25" Hole 2, Threaded	160 lb	100 pc
6TB	0.25" Hole 1, Plain, 0.375" Hole 2, Plain	160 lb	100 pc
6TIB	0.25" Hole 1, Plain, 0.375" Hole 2, Threaded	160 lb	100 pc

Loads indicated are for nVent CADDY Fasteners only. Method of attachment to structure must be evaluated separately.

# STRUCTURAL ATTACHMENTS

## Rod/Wire

### THREAD INSTALL ROD HANGER WITH SHOT-FIRE BRACKET

- Suspends threaded rod without the need for additional hardware
- Complete with shot-fire bracket and pre-assembled drive pin
- Quickly and easily attaches to concrete, steel or composite metal decking
- Integrated pin installs easily using powder-actuated or single-shot gas-actuated tools
- ICC-ES ESR-2024 evaluation report available for drive pin



Material: Steel, Spring Steel

Finish: Electrogalvanized, nVent CADDY Armour

Part #	Description	F	Box
4TIBSF	EG, CADDY ARMOUR, 1/4" Rod, 2.35" x 2.31"	100 lb	100 pc
6TIBSF	EG, CADDY ARMOUR, 3/8" Rod, 2.35" x 2.31"	100 lb	100 pc

Works with Powers® C4CZ, Simpson® GCN-MEPKT, SPIT® P1000, P200, P2201, P3500 / PA3500, P35s, P45, P60, P7201, Sniper; Ramset® 721, Cobra, D45 / D60 / D60L, M70, SA270, T3SS, TS750P, TS60P, Viper; Hilti® DX35, DX350 / DX351 / DX36M, DX100 / DX200, DX460, DXA40, DXA41, DXE72 / DX400; Würth® Diva-1, BST-1, BST-2 or equivalent nailers. For shot-fired supports in seismic design category D, E, or F, maximum load is the lesser of 90 lb (400 N) or the published load.

### THREAD INSTALL ROD HANGER WITH NAIL GUN BRACKET

- Suspends threaded rod without the need for additional hardware
- Complete with concrete nail gun insert bracket
- Clips onto nozzle of gas or battery-actuated nail guns allowing for hands-off installation at structure or from the floor using a pole
- Longer leg angle bracket for tool clearance
- Quickly and easily attaches to concrete, steel or composite metal decking



Material: Steel, Spring Steel, Nylon

Finish: nVent CADDY Armour, Electrogalvanized

Part #	Description	F	Box
4TIBGBSF	1/4" Rod	100 lb	100 pc
6TIBGBSF	3/8" Rod	100 lb	100 pc

Static Load represents the static load of the nail gun insert assembly. Please consult with the nail manufacturer to evaluate the static load of the nail and type of concrete used for the installation. Maximum load is the lesser of the static load from the nail manufacturer or the published load for the assembly. Nail gun insert is compatible with BeA® CN60-688ES, Hilti® BX 3, GX 3, DEWALT® Trak-It C3, SPIT® PULSA 800E, 700, 1000 or equivalent nailers.



## STRUCTURAL ATTACHMENTS

### Rod/Wire

#### THREAD INSTALL ROD HANGER WITH OFFSET BRACKET

- Suspends plain rod, threaded rod or wire drops from vertical structures such as laminated wood or concrete beams, joists, ceilings and walls



Material: Steel, Spring Steel  
Finish: nVent CADDY Armour, Electrogalvanized



Part #	Description	F ↓	☐
4TIO	1/4" Hole, Threaded	160 lb	100 pc
6TIO	3/8" Hole, Threaded	160 lb	100 pc
6TO	3/8" Hole, Plain	160 lb	100 pc

Loads indicated are for nVent CADDY Fasteners only. Method of attachment to structure must be evaluated separately.

#### THREAD INSTALL ROD HANGER WITH PIN DRIVEN ANGLE BRACKET

- Longer leg angle bracket for tool clearance
- Designed to fit a variety of pin drivers
- Improved for easier installation with pin drivers



Material: Steel, Spring Steel  
Finish: Pregalvanized, nVent CADDY Armour

Part #	Description	F ↓	☐
4TIAFAB3	1/4" Hole 1, Threaded	160 lb	100 pc
6TAFAB3	3/8" Hole 1, Plain	160 lb	100 pc
6TIAFAB3	3/8" Hole 1, Threaded	160 lb	100 pc

Load limits apply to nVent CADDY Fasteners only. Pin must be evaluated separately.

# STRUCTURAL ATTACHMENTS

## Rod/Wire

### THREADED ANGLE BRACKET WITH SHOT-FIRE BRACKET

- Provides an attachment point for nVent CADDY Speed Link assemblies, wire, S-hooks, or chain
- Complete with shot-fire bracket and pre-assembled drive pin
- Quickly and easily attaches to concrete, steel or composite metal decking
- Integrated pin installs easily using powder-actuated or single-shot gas-actuated tools
- ICC-ES ESR-2024 evaluation report available for drive pin



Part #



ABTSF

100 pc

Works with Powers® C4CZ, Simpson® GCN-MEPKT, SPIT® P1000, P200, P2201, P3500 / PA3500, P35s, P45, P60, P7201, Sniper, Ramset® 721, Cobra, D45 / D60 / D60L, M70, SA270, T3SS, TS750P, TS60P, Viper; Hilti® DX35, DX350 / DX351 / DX36M, DX100 / DX200, DX460, DXA40, DXA41, DXE72 / DX400; Würth® Diva-1, BST-1, BST-2 or equivalent nailers. For shot-fired supports in seismic design category D, E, or F, maximum load is the lesser of 90 lb (400 N) or the published load.

### NVENT CADDY ROD LOCK SPRING STEEL ROD HANGER

- Supports rod from block or concrete walls
- Easy “push-to-install” design allows installers to simply push the threaded rod through the mounting hole, instantly holding it in position
- Prefabricated assemblies easily lift and lock into place, helping to save time and money
- Works with slightly damaged threads and minor burrs on threaded rod ends
- Design includes a release mechanism that works with pliers



**Innovative Solution**

Material: Spring Steel  
Finish: nVent CADDY Armour

Part #

Description



4QT1

1/4" Rod

75 lb

100 pc

## STRUCTURAL ATTACHMENTS

### Rod/Wire

#### **nVENT CADDY ROD LOCK SPRING STEEL ROD HANGER WITH ANGLE BRACKET**

- Suspends threaded rod from horizontal structures such as laminated wood or concrete beams, joists, ceilings and walls
- Easy “push-to-install” design allows installers to simply push the threaded rod through the mounting hole, instantly holding it in position
- Prefabricated assemblies easily lift and lock into place, helping to save time and money
- Works with slightly damaged threads and minor burrs on threaded rod ends
- Design includes a release mechanism that works with pliers



**Innovative  
Solution**

Material: Spring Steel, Steel  
Finish: nVent CADDY Armour, Pregalvanized

Part #	Description		
4QTIB	1/4" Rod	75 lb	100 pc

Loads indicated are for nVent CADDY Fasteners only. Method of attachment to structure must be evaluated separately.

# STRUCTURAL ATTACHMENTS

## Rod/Wire



### nVENT CADDY ROD LOCK SPRING STEEL ROD HANGER WITH SHOT-FIRE BRACKET

- Suspends threaded rod without the need for additional hardware
- Complete with shot-fire bracket and pre-assembled drive pin
- Quickly and easily attaches to concrete, steel or composite metal decking
- Integrated pin installs easily using powder-actuated or single-shot gas-actuated tools
- ICC-ES ESR-2024 evaluation report available for drive pin
- Easy "push-to-install" design allows installers to simply push the threaded rod through the mounting hole, instantly holding it in position
- Prefabricated assemblies easily lift and lock into place, helping to save time and money
- Works with slightly damaged threads and minor burrs on threaded rod ends
- Design includes a release mechanism that works with pliers



**Innovative  
Solution**

Material: Spring Steel, Steel  
Finish: nVent CADDY Armour, Electrogalvanized

Part #	Description		
4QTBSF	1/4" Rod	75 lb	100 pc

# STRUCTURAL ATTACHMENTS

## Rod/Wire

### **nVENT CADDY ROD LOCK SPRING STEEL ROD HANGER WITH NAIL GUN BRACKET**

- Suspends threaded rod without the need for additional hardware
- Complete with concrete nail gun insert bracket
- Clips onto nozzle of gas or battery-actuated nail guns allowing for hands-off installation at structure or from the floor using a pole
- Longer leg angle bracket for tool clearance
- Quickly and easily attaches to concrete, steel or composite metal decking
- Easy "push-to-install" design allows installers to simply push the threaded rod through the mounting hole, instantly holding it in position
- Prefabricated assemblies easily lift and lock into place, helping to save time and money
- Works with slightly damaged threads and minor burrs on threaded rod ends
- Design includes a release mechanism that works with pliers



**Innovative  
Solution**

Material: Spring Steel, Steel, Nylon  
Finish: nVent CADDY Armour, ElectroGalvanized

Part #	Description	F	
4QTIGBSF	1/4" Rod	75 lb	100 pc

Static Load represents the static load of the nail gun insert assembly. Please consult with the nail manufacturer to evaluate the static load of the nail and type of concrete used for the installation. Maximum load is the lesser of the static load from the nail manufacturer or the published load for the assembly. Nail gun insert is compatible with BeA® CN60-688ES, Hilti® BX 3, GX 3, DEWALT® Trak-It C3, SPIT® PULSA 800E, 700, 1000 or equivalent nailers.

# STRUCTURAL ATTACHMENTS

## Rod/Wire

### NVENT CADDY ROD LOCK SPRING STEEL ROD HANGER WITH OFFSET BRACKET

- Suspends threaded rod from vertical structures such as laminated wood or concrete beams, joists, ceilings and walls
- Easy "push-to-install" design allows installers to simply push the threaded rod through the mounting hole, instantly holding it in position
- Prefabricated assemblies easily lift and lock into place, helping to save time and money
- Works with slightly damaged threads and minor burrs on threaded rod ends
- Design includes a release mechanism that works with pliers



**Innovative Solution**



Material: Spring Steel, Steel  
Finish: nVent CADDY Armour, ElectroGalvanized

Part #	Description	F	Box
4QT10	1/4" Rod	75 lb	100 pc

Loads indicated are for nVent CADDY Fasteners only. Method of attachment to structure must be evaluated separately.

### NVENT CADDY ROD LOCK SPRING STEEL ROD HANGER WITH PIN DRIVEN ANGLE BRACKET

- Longer leg angle bracket for tool clearance
- Designed to fit a variety of pin drivers
- Improved for easier installation with pin drivers
- Quickly and easily attaches to concrete, steel or composite metal decking
- Easy "push-to-install" design allows installers to simply push the threaded rod through the mounting hole, instantly holding it in position
- Prefabricated assemblies easily lift and lock into place, helping to save time and money
- Works with slightly damaged threads and minor burrs on threaded rod ends
- Design includes a release mechanism that works with pliers

**Innovative Solution**



Material: Spring Steel, Steel  
Finish: nVent CADDY Armour, Pregalvanized

Part #	Description	F	Box
4QT1AFAB3	1/4" Rod	75 lb	100 pc

Load limits apply to nVent CADDY Fasteners only. Pin must be evaluated separately.

## STRUCTURAL ATTACHMENTS

### Rod/Wire

#### ANGLE BRACKET WITH SHOT-FIRE BRACKET

- Provides an attachment point for nVent CADDY Speed Link assemblies, wire, S-hooks, or chain
- Complete with shot-fire bracket and pre-assembled drive pin
- Quickly and easily attaches to concrete, steel or composite metal decking
- Integrated pin installs easily using powder-actuated or single-shot gas-actuated tools
- ICC-ES ESR-2024 evaluation report available for drive pin



Material: Steel

Finish: Electrogalvanized

Part #	Description	F	
ABSF	Angle Bracket with Shot-Fire Bracket	100 lb	100 pc

Works with Powers® C4CZ, Simpson® GCN-MEPKT, SPIT® P1000, P200, P2201, P3500 / PA3500, P35s, P45, P60, P7201, Sniper, Ramset® 721, Cobra, D45 / D60 / D60L, M70, SA270, T3SS, TS750P, TS60P, Viper; Hilti® DX35, DX350 / DX351 / DX36M, DX100 / DX200, DX460, DXA40, DXA41, DXE72 / DX400; Würth® Diva-1, BST-1, BST-2 or equivalent nailers. For shot-fired supports in seismic design category D, E, or F, maximum load is the lesser of 90 lb (400 N) or the published load.

#### ANGLE BRACKET WITH NAIL GUN INSERT

- Provides an attachment point for nVent CADDY Speed Link assemblies, wire, S-hooks, or chain
- Complete with concrete nail gun insert bracket
- Clips onto nozzle of gas or battery-actuated nail guns allowing for hands-off installation at structure or from the floor using a pole
- Longer leg angle bracket for tool clearance
- Quickly and easily attaches to concrete, steel or composite metal decking



Material: Steel, Nylon

Finish: Electrogalvanized

Part #	Description	F	
ABGBSF	Angle Bracket with Nail Gun Insert	100 lb	100 pc

Static Load represents the static load of the nail gun insert assembly. Please consult with the nail manufacturer to evaluate the static load of the nail and type of concrete used for the installation. Maximum load is the lesser of the static load from the nail manufacturer or the published load for the assembly. Nail gun insert is compatible with BeA® CN60-688ES, Hilti® BX 3, GX 3, DEWALT® Trak-It C3, SPIT® PULSA 800E, 700, 1000 or equivalent nailers.

# STRUCTURAL ATTACHMENTS

## Rod/Wire

### ANGLE BRACKET

- Provides an attachment for nVent CADDY Speed Link assemblies, wire, threaded rod, S-hooks, or chain from concrete or wood

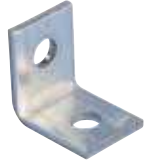

Material: Steel  
Finish: Pregalvanized



Part #	Description	F ↓	☐
AB	PG, 0.25" Hole 1, 0.25" Hole 2	160 lb	100 pc
AB375	PG, 0.25" Hole 1, 0.375" Hole 2	160 lb	100 pc

### PIN DRIVEN ANGLE BRACKET

- Longer leg angle bracket for tool clearance
- Designed to fit a variety of pin drivers
- Improved for easier installation with pin drivers
- Preassembly options available for rod, wire, strap and cable applications



Material: Steel  
Finish: Pregalvanized



Part #	Description	F ↓	☐
AFAB3	3/16" Hole 1	160 lb	100 pc
AFAB4	1/4" Hole 1	350 lb	100 pc
AFAB6	3/8" Hole 1	350 lb	100 pc

Load limits apply to nVent CADDY Fasteners only. Pin must be evaluated separately.



## STRUCTURAL ATTACHMENTS

### Rod/Wire

#### OFFSET BRACKET

- Permits wire or chain drops from concrete or wood



Material: Steel  
Finish: Pregalvanized



Part #	Description	
AO	1/4" Hole	100 pc

#### MULTI-FUNCTION CLIP

- Provides attachment of conduit and boxes
- Supports #10-24 and 1/4-20 threaded bridle rings



Material: Spring Steel  
Finish: nVent CADDY Armour



Part #	Description			
4Z34	1/4" Rod, #12-#8 Wire, 1/8"-3/8" Flange, 1/4" Hole	25 lb	20 lb	100 pc
4Z4S	1/4" Rod, #12-#8 Wire, 1/8"-3/8" Flange, 1/4" Screw	25 lb	20 lb	100 pc
6Z34	5/16", 3/8" Rod, 3/8"-7/16" Flange, 1/4" Hole	25 lb	20 lb	100 pc
6Z4S	5/16", 3/8" Rod, 3/8"-7/16" Flange, 1/4" Screw	25 lb	20 lb	100 pc
8Z34	1/2", 5/8" Rod, 1/4" Hole		50 lb	100 pc
8Z4S	1/2", 5/8" Rod, 1/4" Screw		50 lb	100 pc

1/2" and 5/8" rod sizes are to be installed on threaded rod only.  
NEC® 300.11 requires dedicated drop wire/rod and EC311.

# STRUCTURAL ATTACHMENTS

## Fasteners/Hardware

### THREADED ROD

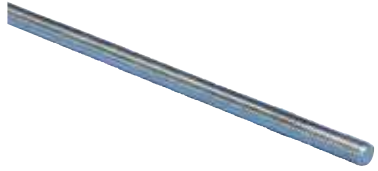

Material: Steel  
Finish: Electrogalvanized  
Tensile Strength: 58,000 psi  
Yield Strength: 36,000 psi

Part #	Description	F ↓	
0502506EG	EG, 1/4" Rod, 6'	240 lb	6'
0502510EG	EG, 1/4" Rod, 10'	240 lb	10'
0503706EG	EG, 3/8" Rod, 6'	600 lb	6'
0503710EG	EG, 3/8" Rod, 10'	610 lb	10'
0503712EG	EG, 3/8" Rod, 12'	600 lb	12'
0505006EG	EG, 1/2" Rod, 6'	1,130 lb	6'
0505010EG	EG, 1/2" Rod, 10'	1,130 lb	10'
0505012EG	EG, 1/2" Rod, 12'	1,130 lb	12'
0506206EG	EG, 5/8" Rod, 6'	1,810 lb	6'
0506210EG	EG, 5/8" Rod, 10'	1,810 lb	10'
0506212EG	EG, 5/8" Rod, 12'	1,810 lb	12'
0507510EG	EG, 3/4" Rod, 10'	2,710 lb	10'
0507512EG	EG, 3/4" Rod, 12'	2,710 lb	12'
0508706EG	EG, 7/8" Rod, 6'	3,770 lb	6'
0508710EG	EG, 7/8" Rod, 10'	3,770 lb	10'

Load based on Max. 650 degrees F.

# STRUCTURAL ATTACHMENTS

## Fasteners/Hardware

### THREADED STUD

- Pre-cut lengths of threaded rod



Material: Steel  
Finish: Plain  
Tensile Strength: 58,000 psi  
Yield Strength: 36,000 psi

Part #	Description	F ↓	☐
0513702PL	3/8" Rod, 2"	600 lb	100 pc

### EM-HEX ROD COUPLER



Material: Steel  
Finish: Electrogalvanized

Part #	Description	F ↓	☐
0250025EG	1/4" Rod	240 lb	100 pc
0250037EG	3/8" Rod	600 lb	100 pc
0250050EG	1/2" Rod	1,130 lb	100 pc
0250062EG	5/8" Rod	1,810 lb	100 pc
0250075EG	3/4" Rod	2,710 lb	100 pc
0250087EG	7/8" Rod	3,770 lb	50 pc

# STRUCTURAL ATTACHMENTS

## Fasteners/Hardware

### 25R HEX ROD REDUCER

- Threaded rod reducing coupling



Material: Steel  
Finish: Electrogalvanized

Part #	Description	F ↓	☐
025R3725EG	3/8" Rod 1, 1/4" Rod 2	240 lb	100 pc
025R5037EG	1/2" Rod 1, 3/8" Rod 2	600 lb	100 pc
025R6250EG	5/8" Rod 1, 1/2" Rod 2	1,130 lb	100 pc

Never use smaller rod sizes than the minimum rod sizes defined by applicable code.

### SWFF SWIVEL FEMALE-FEMALE

- Attachment with the capability to swivel



Material: Steel  
Finish: Electrogalvanized

Part #	Description	F ↓	☐
SWFF0037EG	3/8" Rod	1,000 lb	50 pc
SWFF0050EG	1/2" Rod	1,800 lb	50 pc

## STRUCTURAL ATTACHMENTS



### Fasteners/Hardware

#### **SWMF SWIVEL MALE-FEMALE**

- Attachment with the capability to swivel



Material: Steel  
Finish: Electrogalvanized

Part #	Description		
SWMF0037EG	3/8" Rod	1,000 lb	50 pc
SWMF0050EG	1/2" Rod	1,800 lb	50 pc

#### **FIXTURE SUPPORT FROM PLAIN ROD/WIRE**

- No tools required for installation
- Eliminates the use of nut and allows the use of plain rod



Material: Spring Steel  
Finish: nVent CADDY Armour

Part #	Description	
4EBN	1/4" Rod	100 pc

# STRUCTURAL ATTACHMENTS

## Fasteners/Hardware

### THREADED ROD HANGER FROM BAR JOIST

- Fits open web joists with round bottom chords
- Permits accurate centering



Material: Spring Steel  
Finish: nVent CADDY Armour



Part #	Description	F ↓	↓ ↓
4TW	1/4" Rod, Threaded	100 lb	100 pc
6W	3/8" Rod, Plain	200 lb	100 pc

### 41 COACH SCREW

- Light duty hanger rod for wood structures



Material: Steel  
Finish: Plain

Part #	Description	F ↓	↓ ↓
0413704PL	3/8" Rod, 4"	390 lb	100 pc
0413706PL	3/8" Rod, 6"	390 lb	100 pc
0413708PL	3/8" Rod, 8"	390 lb	100 pc
0413710PL	3/8" Rod, 10"	390 lb	100 pc
0415004PL	1/2" Rod, 4"	640 lb	100 pc
0415006PL	1/2" Rod, 6"	640 lb	100 pc
0415008PL	1/2" Rod, 8"	640 lb	100 pc

## STRUCTURAL ATTACHMENTS

### Fasteners/Hardware

#### 42 HEX HEAD LAG SCREW

- For use with wood structures



Material: Steel

Finish: Electrogalvanized

Part #	Description	
0422515EG	1/4" Screw, 1 1/2" Screw	100 pc
0422520EG	1/4" Screw, 2" Screw	100 pc
0423715EG	3/8" Screw, 1 1/2" Screw	100 pc
0423720EG	3/8" Screw, 2" Screw	100 pc
0423725EG	3/8" Screw, 2 1/2" Screw	100 pc
0423730EG	3/8" Screw, 3" Screw	50 pc
0425020EG	1/2" Screw, 2" Screw	50 pc
0425025EG	1/2" Screw, 2 1/2" Screw	50 pc
0425030EG	1/2" Screw, 3" Screw	50 pc

#### 43 WOOD DRIVE SCREW

- Light duty fastener for mounting various structural attachments onto wood



Material: Steel

Finish: Electrogalvanized

Part #	Description	
0431602EG	#16 Screw, 2" Screw	100 pc

Install only in shear, never use under pull-out configuration.

# STRUCTURAL ATTACHMENTS

## Fasteners/Hardware

### A33 SCREW

- Long indented hex washer head, self tapping screw with pierce point



Material: Steel  
Finish: Electrogalvanized

Part #	Description	
A3308AP100	#10 Screw, 1" Screw	100 pc

### COMBI DOME SCREW

- Cross recess combi screw for use with both Slot and Phillips driver



Material: Steel  
Finish: Black Oxide

Part #	Description	
S3575BP100	1/4" Screw, 3/8" Screw	100 pc
S3575BP50	1/4" Screw, 3/8" Screw	50 pc
S3575DP100	1/4" Screw, 3/4" Screw	100 pc

### FLAT HEAD CARRIAGE BOLT



Material: Steel  
Finish: Electrogalvanized

Part #	Description	
S31199P100	1/4" Screw, 9/16" Screw	50 pc



## STRUCTURAL ATTACHMENTS

### Fasteners/Hardware

#### HEX HEAD BOLT

- Fully threaded hexagon head bolt



Material: Steel

Finish: Electrogalvanized

Part #	Description	
HSCR3710EG	EG, 3/8" Screw, 1" Screw	100 pc
HSCR3712EG	EG, 3/8" Screw, 1.25" Screw	100 pc
HSCR3715EG	EG, 3/8" Screw, 1.5" Screw	100 pc
HSCR3720EG	EG, 3/8" Screw, 2" Screw	100 pc
HSCR5010EG	EG, 1/2" Screw, 1" Screw	100 pc
HSCR5012EG	EG, 1/2" Screw, 1.25" Screw	100 pc
HSCR5015EG	EG, 1/2" Screw, 1.5" Screw	100 pc

#### HEX NUT

- Internally threaded with a hex drive for many applications



Material: Steel

Part #	Description	
Finish: Electrogalvanized		
0100025EG	EG, 1/4" Rod	100 pc
0100037EG	EG, 3/8" Rod	100 pc
0100050EG	EG, 1/2" Rod	100 pc
0100062EG	EG, 5/8" Rod	50 pc
0100075EG	EG, 3/4" Rod	50 pc
0100087EG	EG, 7/8" Rod	50 pc
Finish: Plain		
0100025PL	1/4" Rod	100 pc
0100037PL	3/8" Rod	100 pc
0100050PL	1/2" Rod	100 pc
0100062PL	5/8" Rod	50 pc
0100075PL	3/4" Rod	50 pc

# STRUCTURAL ATTACHMENTS

## Fasteners/Hardware

### HEAVY DUTY HEX NUT

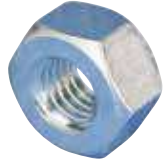

Material: Steel  
Finish: Electrogalvanized

Part #	Description	
010H0037EG	EG, 3/8" Rod	100 pc
010H0050EG	EG, 1/2" Rod	100 pc
010H0062EG	EG, 5/8" Rod	50 pc
010H0075EG	EG, 3/4" Rod	50 pc

### FLAT WASHER

- Use under the head of a bolt or nut in order to distribute the fastener load over a wider surface area



Material: Steel

Part #	Description	
Finish: Electrogalvanized		
0110025EG	EG, 0.313" Hole	100 pc
0110037EG	EG, 0.438" Hole	100 pc
0110050EG	EG, 0.563" Hole	100 pc
0110062EG	EG, 0.688" Hole	50 pc
0110075EG	EG, 0.813" Hole	50 pc
0110087EG	EG, 0.938" Hole	50 pc
Finish: Plain		
0110025PL	0.313" Hole	100 pc
0110037PL	0.438" Hole	100 pc
0110050PL	0.563" Hole	100 pc
0110062PL	0.688" Hole	50 pc
0110075PL	0.813" Hole	50 pc

## STRUCTURAL ATTACHMENTS

### Fasteners/Hardware

#### LARGE WASHER

---



Material: Steel  
Finish: Electrogalvanized

Part #	Description	
0120025EG	0.313" Hole, 1.063" dia	100 pc
0120037EG	0.438" Hole, 1.5" dia	100 pc
0120050EG	0.563" Hole, 2" dia	100 pc

#### 740 PIPE SLEEVE POSITIONER

---

- Used to position pipe sleeves and prevent movement during concrete pours
- Requires only a hammer to install
- Can be used for Schedule 40 pipe with sleeve diameter of 2" through 6"
- Can be used for wall thicknesses of 5/16" and under with all sleeve diameters



Material: Spring Steel  
Finish: nVent CADDY Armour

Part #	Description	
740	740 Pipe Sleeve Positioner	100 pc

No load rating, for positioning only.  
For pipe sizes 6" to 14" use 4H Hammer-On Flange Clip, Side Mount

## STRUCTURAL ATTACHMENTS

### Anchors

#### WEDGE EXPANSION ANCHOR BOLT

- ICC® approved for use in cracked and uncracked concrete
- Includes nut and washer
- Meets NFPA® 13 as pre-qualified for seismic applications



Material: Steel

Finish: Electrogalvanized

Part #	Description	
CSBCAB030037EG	3/8" Screw, 3"	50 pc
CSBCAB037550EG	1/2" Screw, 3 3/4"	50 pc
CSBCAB045050EG	1/2" Screw, 4 1/2"	50 pc
CSBCAB055050EG	1/2" Screw, 5 1/2"	25 pc
CSBCAB047562EG	5/8" Screw, 4 3/4"	25 pc
CSBCAB060062EG	5/8" Screw, 6"	25 pc
CSBCAB055075EG	3/4" Screw, 5 1/2"	20 pc
CSBCAB062575EG	3/4" Screw, 6 1/4"	20 pc

#### CONCRETE ANCHOR SCREW

- For use with screw drill bits
- ICC® approved for use in cracked and uncracked concrete
- Meets NFPA® 13 as pre-qualified for seismic applications



Material: Steel

Finish: Electrogalvanized

Part #	Description	
CSBCAS025037EG	3/8" Screw, 2 1/2" Screw, 3/8" Drill Bit Diameter	50 pc
CSBCAS030050EG	1/2" Screw, 3" Screw, 1/2" Drill Bit Diameter	50 pc
CSBCAS040050EG	1/2" Screw, 4" Screw, 1/2" Drill Bit Diameter	50 pc
CSBCAS050050EG	1/2" Screw, 5" Screw, 1/2" Drill Bit Diameter	25 pc
CSBCAS040062EG	5/8" Screw, 4" Screw, 5/8" Drill Bit Diameter	25 pc
CSBCAS050062EG	5/8" Screw, 5" Screw, 5/8" Drill Bit Diameter	25 pc
CSBCAS050075EG	3/4" Screw, 5" Screw, 3/4" Drill Bit Diameter	20 pc

## STRUCTURAL ATTACHMENTS

### Anchors

#### DROP-IN ANCHOR

- Internal thread provides easy removal and serviceability
- Installs flush or below the base surface
- Fire resistance class R30-R120 for design of anchorages under exposure to fire



Material: Steel

Finish: Electrogalvanized

Part #	Description	
CA0025EG	EG, 1/4" Hole, 1"	100 pc
CA0037EG	EG, 3/8" Hole, 1.563"	50 pc
CA0050EG	EG, 1/2" Hole, 2"	50 pc

The maximum load per fixing point for multiple use for non-structural applications may, depending on national regulations, be below the approved load of the anchor. The approved loads per fixing point are regulated for their respective countries in the ETAG 001, Part 6. Total safety factor as per ETAG 001 included ( $Y_m$  and  $Y_f$ ).

#### FLANGED DROP-IN ANCHOR

- Internal thread provides easy removal and serviceability
- Installs flush for standard embedment
- Fire resistance class R30-R120 for design of anchorages under exposure to fire
- Lip makes the flush installation easier by helping achieve consistent anchor depth and easy threaded rod alignment



Material: Steel

Finish: Electrogalvanized

Part #	Description	
LA0025EG	1/4" Hole	100 pc
LA0037EG	3/8" Hole	50 pc
LA0050EG	1/2" Hole	50 pc

The maximum load per fixing point for multiple use for non-structural applications may, depending on national regulations, be below the approved load of the anchor. The approved loads per fixing point are regulated for their respective countries in the ETAG 001, Part 6. Total safety factor as per ETAG 001 included ( $Y_m$  and  $Y_f$ ).

# STRUCTURAL ATTACHMENTS

## Anchors

### SPIKE ANCHOR

- Use in concrete with threaded rod
- Vibration resistant
- Pre-expanded anchor design allows for easy installation
- Mushroom and flat head spike anchors are tamper-proof
- Removable forming spike can be used for temporary installations
- Pipe spike is an easy to install alternative to direct fastening



Material: Steel  
Finish: Electrogalvanized



Part #	Description	
RAWL3758	3/8" Rod, 1/4" Drill Bit Diameter	50 pc

### HANGER MATE® VERTICAL MOUNT SCREW FOR STEEL

- Convenient design allows fast and easy installation
- Eliminates the need for labor-intensive operations, such as pre-punching or drilling of steel components
- Only one driver needed for all anchor sizes
- Tapped head permits in-line mounting of threaded rod systems



Material: Steel  
Finish: Electrogalvanized

Part #	Description	
HMZG160	1/4" Rod, 0.06"-0.25" Flange	50 pc
HMZG470	3/8" Rod, 0.06"-0.25" Flange	50 pc

## STRUCTURAL ATTACHMENTS

### Anchors

#### **HANGERMATE® VERTICAL MOUNT SCREW FOR STEEL WITH LOCK NUT**

- Convenient design allows fast and easy installation
- Eliminates the need for labor-intensive operations, such as pre-punching or drilling of steel components
- Only one driver needed for all anchor sizes
- Tapped head permits in-line mounting of threaded rod systems



Material: Steel  
Finish: Electrogalvanized

Part #	Description	
HMZG471	3/8" Rod, 0.06"-0.25" Flange	50 pc

#### **HANGERMATE® HORIZONTAL MOUNT SCREW FOR STEEL**

- Convenient design allows fast and easy installation
- Eliminates the need for labor-intensive operations, such as pre-punching or drilling of steel components
- Only one driver needed for all anchor sizes
- Cross-drilled and tapped head permits horizontal mounting of threaded rod systems



Material: Steel  
Finish: Electrogalvanized

Part #	Description	
HMZH475	3/8" Rod, 0.06"-0.25" Flange	50 pc

#### **HANGERMATE® HORIZONTAL MOUNT SCREW FOR STEEL WITH LOCK NUT**

- Convenient design allows fast and easy installation
- Eliminates the need for labor-intensive operations, such as pre-punching or drilling of steel components
- Only one driver needed for all anchor sizes
- Cross-drilled and tapped head permits horizontal mounting of threaded rod systems



Material: Steel  
Finish: Electrogalvanized

Part #	Description	
HMZH476	3/8" Rod, 0.06"-0.25" Flange	50 pc

# STRUCTURAL ATTACHMENTS

## Anchors

### HANGERMATE® VERTICAL MOUNT SCREW FOR WOOD

- Convenient design allows fast and easy installation
- Only one driver needed for all anchor sizes
- Tapped head permits in-line mounting of threaded rod systems



Material: Steel  
Finish: Electrogalvanized

Part #	Description	
HMZG315	1/4" Rod, 5/16" Screw, 2 1/4" Screw	50 pc
HMZG650	3/8" Rod, 5/16" Screw, 2 1/4" Screw	50 pc

### HANGERMATE® HORIZONTAL MOUNT SCREW FOR WOOD

- Convenient design allows fast and easy installation
- Only one driver needed for all anchor sizes
- Cross-drilled and tapped head permits horizontal mounting of threaded rod systems



Material: Steel  
Finish: Electrogalvanized



Part #	Description	
HMZH665	3/8" Rod, 5/16" Screw, 2 1/4" Screw	50 pc

### HANGERMATE® VERTICAL MOUNT SCREW FOR CONCRETE

- End-drilled and tapped for attaching threaded components to concrete
- Solid, one piece cold formed part; head cannot spin off or unscrew from body
- Tapered threads allow for easy starting in pre-drilled hole



Material: Steel  
Finish: Electrogalvanized

Part #	Description		
HMZG365	1/4" Rod, 5/16" Screw, 2 1/4" Screw	2,188 lb	50 pc
HMZG730	3/8" Rod, 5/16" Screw, 2 1/4" Screw	2,188 lb	50 pc

Tested in 3650 psi concrete. Appropriate safety factors should be applied for design purposes.



## STRUCTURAL ATTACHMENTS

### Anchors

#### HANGERMATE® HEX DRIVE SOCKET

- Installs anchors quickly and easily
- Automatically disengages when anchor is seated



Material: Steel  
Finish: Electrogalvanized

Part #	Description	
HMZE215	HangerMate Hex Drive Socket	1 pc

#### HANGERMATE® SDS DRILL BIT FOR HAMMER DRILLS

- Engineered for accurate drilling in concrete applications



Material: Steel  
Finish: Plain

Part #	Description	
HMZE350	1/4" Drill Bit Diameter	1 pc

#### 145 SPRING TOGGLE

- Used with threaded rod in hollow wall applications



Material: Steel  
Finish: Electrogalvanized

Part #	Description	
1450037EG	3/8" Rod	100 pc
1450050EG	1/2" Rod	50 pc

# nVent CADDY All-In-One



# NVENT CADDY ALL-IN-ONE ELECTRICAL ASSEMBLIES

## nVent CADDY All-in-One Stud-Mounted Assemblies

### ALL-IN-ONE STUD-MOUNTED WITH REMOVABLE MUD RING

- Features the patented Open Back Box to simplify on site wiring process
- Removable mud ring provides front access to the interior of the box
- Box remains fixed in place when mud ring is removed
- Includes multiple knockouts on each side of the box
- Assemblies keyed for precise alignment when installed on both sides of a stud
- Made in the USA



Material: Steel  
Finish: Pregalvanized



Part #	Description	
Knockout Sizes: (5) 1/2", 3/4", (1) 1/2", (3) 1"		
A1SD1NS	1 Gang, No Ground, 5/8" Drywall, 2 1/2"	20 pc
A1SD1N	1 Gang, No Ground, 5/8" Drywall, 3 5/8"	20 pc
Knockout Sizes: (8) 1/2", 3/4"		
A1SF1GS	1 Gang, w/Ground, 5/8" Drywall, 2 1/2"	20 pc
A1SF1G	1 Gang, w/Ground, 5/8" Drywall, 3 5/8"	20 pc
A1SF1GSP250	1 Gang, w/Ground, 5/8" Drywall, 3 5/8"	250 pc
A1SF3G	1 Gang, w/Ground, 1 1/4" Drywall, 3 5/8"	20 pc
A1SF2GS	2 Gang, w/Ground, 5/8" Drywall, 2 1/2"	20 pc
A1SF2G	2 Gang, w/Ground, 5/8" Drywall, 3 5/8"	20 pc

Ground wire pigtail is 10".

# NVENT CADDY ALL-IN-ONE ELECTRICAL ASSEMBLIES

## nVent CADDY All-in-One Stud-Mounted Assemblies

### ALL-IN-ONE STUD-MOUNTED WITH ADJUSTABLE MUD RING

- Features the patented Open Back Box to simplify on site wiring process
- Adjustable mud ring accommodates various thicknesses of drywall
- Can be adjusted after the installation of drywall
- Box remains fixed in place when mud ring is removed
- Includes multiple knockouts on each side of the box
- Assemblies keyed for precise alignment when installed on both sides of a stud



Material: Steel  
Finish: Pregalvanized  
Knockout Sizes: (8) 1/2", 3/4"; (3) 1/2"



Part #	Description	
A1SFV1G	1 Gang, 3/4"-1 1/2" Drywall, 3 5/8"	20 pc
A1SFV1GS	1 Gang, 3/4"-1 1/2" Drywall, 2 1/2"	20 pc
A1SFV2G	2 Gang, 5/8"-1 1/2" Drywall, 3 5/8"	20 pc
A1SFV2GS	2 Gang, 5/8"-1 1/2" Drywall, 2 1/2"	20 pc

Ground wire pigtail is 10".

# NVENT CADDY ALL-IN-ONE ELECTRICAL ASSEMBLIES

## nVent CADDY All-in-One Stud-Mounted Assemblies

### ALL-IN-ONE STUD-MOUNTED WITHOUT MUD RING

- Features the patented Open Back Box to simplify on site wiring process
- Provides the flexibility to add a mud ring for non-standard drywall thicknesses
- Box remains fixed in place when mud ring is removed
- Includes multiple knockouts on each side of the box
- Assemblies keyed for precise alignment when installed on both sides of a stud
- Works with standard US and Canadian mud rings
- Made in the USA



Material: Steel  
Finish: Pregalvanized



Part #	Description	
Knockout Sizes: (5) 1/2", 3/4", (1) 1/2", (3) 1"		
A1SD0G	w/Ground, 3 5/8"	20 pc
A1SD0NS	No Ground, 2 1/2"	20 pc
A1SD0N	No Ground, 3 5/8"	20 pc
Knockout Sizes: (8) 1/2", 3/4", (3) 1/2"		
A1SF0GS	w/Ground, 2 1/2"	20 pc
A1SF0G	w/Ground, 3 5/8"	20 pc
A1SF0GSBUSP250	w/Ground, 2 1/2"	250 pc
A1SF0NS	No Ground, 2 1/2"	20 pc
A1SF0N	No Ground, 3 5/8"	20 pc

Ground wire pigtail is 10".

# nVENT CADDY ALL-IN-ONE ELECTRICAL ASSEMBLIES

## nVent CADDY All-in-One Between-Stud Assemblies

### ALL-IN-ONE BETWEEN-STUD WITH REMOVABLE MUD RING, SINGLE BOX

- Features the patented Open Back Box to simplify on site wiring process
- Removable mud ring provides front access to the interior of the box
- Box remains fixed in place when mud ring is removed
- Pre-bent tabs on support bracket help to quickly square assembly to stud
- Center marks provide easy height positioning
- Includes multiple 1/2" and 3/4" knockouts on each side of the box
- Made in the USA



Material: Steel  
Finish: Pregalvanized  
Knockout Sizes: (8) 1/2", 3/4"; (3) 1/2"



Part #	Description	
A1BF1GS	1 Gang, w/Ground, 5/8" Drywall, 2 1/2"	5 pc
A1BF1G	1 Gang, w/Ground, 5/8" Drywall, 3 5/8"	5 pc
A1BF3G	1 Gang, w/Ground, 1 1/4" Drywall, 3 5/8"	5 pc
A1BF2GS	2 Gang, w/Ground, 5/8" Drywall, 2 1/2"	5 pc
A1BF2G	2 Gang, w/Ground, 5/8" Drywall, 3 5/8"	5 pc

Ground wire pigtail is 10".24" stud spacing requires use of three mounting screws.  
Use only with nVent CADDY All-in-One box assemblies.

# NVENT CADDY ALL-IN-ONE ELECTRICAL ASSEMBLIES

## nVent CADDY All-in-One Between-Stud Assemblies

### ALL-IN-ONE BETWEEN-STUD WITH REMOVABLE MUD RING, MULTI-BOX

- Features the patented Open Back Box to simplify on site wiring process
- Comes with multiple boxes pre-assembled for side by side power and data applications
- Removable mud ring provides front access to the interior of the box
- Pre-bent tabs on support bracket help to quickly square assembly to stud
- Center marks provide easy height positioning
- Includes multiple knockouts on each side of the box
- Made in the USA



Material: Steel

Finish: Pregalvanized

Knockout Sizes, Box 1: (8) 1/2", 3/4"; (3) 1/2"



Part #	Description	
A1BF1G41NAO	1 Gang, 5/8" Drywall, 3 5/8"	5 pc
A1BF2G41NAO	2 Gang, 5/8" Drywall, 3 5/8"	5 pc
Knockout Sizes, Box 2: (4) 1", (4) 1 1/4"		
A1BF1G41N	(1 Gang, 42 in <sup>3</sup> Box, 5/8" Drywall, 3 5/8"	5 pc
A1BF1G51N	1 Gang, 64 in <sup>3</sup> Box, 5/8" Drywall, 3 5/8"	5 pc
A1BF2G41N	(2 Gang, 42 in <sup>3</sup> Box, 5/8" Drywall, 3 5/8"	5 pc
A1BF2G51N	(2 Gang, 64 in <sup>3</sup> Box, 5/8" Drywall, 3 5/8"	5 pc
Knockout Sizes, Box 2: (5) 1/2", 3/4", (1) 1/2", (3) 1"		
A1BF1GD1NS	1 Gang, 32.8 in <sup>3</sup> Box, 5/8" Drywall, 2 1/2"	5 pc
A1BF1GD1N	1 Gang, 32.8 in <sup>3</sup> Box, 5/8" Drywall, 3 5/8"	5 pc
A1BF2GD1N	2 Gang, 32.8 in <sup>3</sup> Box, 5/8" Drywall, 3 5/8"	5 pc
Knockout Sizes, Box 2: (8) 1/2", 3/4", (3) 1/2"		
A1BF1GF1N	1 Gang, 32.8 in <sup>3</sup> Box, 5/8" Drywall, 3 5/8"	5 pc

Ground wire pigtail is 10". 24" stud spacing requires use of three mounting screws. Use only with nVent CADDY All-in-One box assemblies.

# nVENT CADDY ALL-IN-ONE ELECTRICAL ASSEMBLIES

## nVent CADDY All-in-One Between-Stud Assemblies

### ALL-IN-ONE BETWEEN-STUD WITH ADJUSTABLE MUD RING, SINGLE BOX

- Features the patented Open Back Box to simplify on site wiring process
- Adjustable mud ring accommodates various thicknesses of drywall
- Can be adjusted after the installation of drywall
- Box remains fixed in place when mud ring is removed
- Pre-bent tabs on support bracket help to quickly square assembly to stud
- Center marks provide easy height positioning
- Includes multiple 1/2" and 3/4" knockouts on each side of the box



Material: Steel  
Finish: Pregalvanized  
Knockout Sizes: (8) 1/2", 3/4"; (3) 1/2"



Part #	Description	
A1BFV1GS	1 Gang, 2 1/2"	5 pc
A1BFV1G	1 Gang, 3 5/8"	5 pc
A1BFV2G	2 Gang, 3 5/8"	5 pc

Ground wire pigtail is 10".24" stud spacing requires use of three mounting screws.  
Use only with nVent CADDY All-in-One box assemblies.

### ALL-IN-ONE BETWEEN-STUD WITH ADJUSTABLE MUD RING, MULTI-BOX

- Features the patented Open Back Box to simplify on site wiring process
- Comes with multiple boxes pre-assembled for side by side power and data applications
- Adjustable mud ring accommodates various thicknesses of drywall
- Can be adjusted after the installation of drywall
- Pre-bent tabs on support bracket help to quickly square assembly to stud
- Center marks provide easy height positioning
- Includes multiple knockouts on each side of the box



Material: Steel  
Finish: Pregalvanized  
Knockout Sizes, Box 1: (8) 1/2", 3/4"; (3) 1/2"  
Knockout Sizes, Box 2: (5) 1/2", 3/4"; (1) 1/2"; (3) 1"



Part #	Description	
A1BFV1GDV1NS	2 1/2"	5 pc
A1BFV1GDV1N	3 5/8"	5 pc

Ground wire pigtail is 10".24" stud spacing requires use of three mounting screws.  
Use only with nVent CADDY All-in-One box assemblies.



# NVENT CADDY ALL-IN-ONE ELECTRICAL ASSEMBLIES

## nVent CADDY All-in-One Between-Stud Assemblies

### ALL-IN-ONE BETWEEN-STUD WITHOUT MUD RING, SINGLE BOX

- Features the patented Open Back Box to simplify on site wiring process
- Provides the flexibility to add a mud ring for non-standard drywall thicknesses
- Box remains fixed in place when mud ring is removed
- Pre-bent tabs on support bracket help to quickly square assembly to stud
- Center marks provide easy height positioning
- Includes multiple 1/2" and 3/4" knockouts on each side of the box
- Works with standard US and Canadian mud rings
- Made in the USA

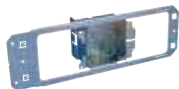

Material: Steel  
Finish: Pregalvanized



Part #	Description	
Knockout Sizes: (5) 1/2", 3/4", (1) 1/2", (3) 1"		
A1BD0N	Single Box, No Ground, 3 5/8"	5 pc
Knockout Sizes: (8) 1/2", 3/4", (3) 1/2"		
A1BF0G	Single Box, w/Ground, 3 5/8"	5 pc
A1BF0GS	Single Box, w/Ground, 2 1/2"	5 pc

Ground wire pigtail is 10". 24" stud spacing requires use of three mounting screws.  
Use only with nVent CADDY All-in-One box assemblies.

# nVENT CADDY ALL-IN-ONE ELECTRICAL ASSEMBLIES

## nVent CADDY All-in-One Between-Stud Assemblies

### ALL-IN-ONE BETWEEN-STUD WITHOUT MUD RING, MULTI-BOX

- Features the patented Open Back Box to simplify on site wiring process
- Comes with multiple boxes pre-assembled for side by side power and data applications
- Provides the flexibility to add a mud ring for non-standard drywall thicknesses
- Box remains fixed in place when mud ring is removed
- Pre-bent tabs on support bracket help to quickly square assembly to stud
- Center marks provide easy height positioning
- Includes multiple knockouts on each side of the box
- Works with standard US and Canadian mud rings
- Made in the USA



Material: Steel  
Finish: Pregalvanized



Part #	Description	
Knockout Sizes, Box 1: (8) 1/2", 3/4"		
Knockout Sizes, Box 2: (5) 1/2", 3/4", (1) 1/2"		
A1BF0GD0N	3 5/8"	5 pc
A1BF0GD0NS	2 1/2"	5 pc
Knockout Sizes, Box 1: (8) 1/2", 3/4", (3) 1/2"		
A1BF0G40NAO	3 5/8"	5 pc
Knockout Sizes, Box 1: (8) 1/2", 3/4", (3) 1/2"		
Knockout Sizes, Box 2: (4) 1", (4) 1 1/4"		
A1BF0G40N	3 5/8"	5 pc

Ground wire pigtail is 10".24" stud spacing requires use of three mounting screws.  
Use only with nVent CADDY All-in-One box assemblies.

# NVENT CADDY ALL-IN-ONE ELECTRICAL ASSEMBLIES

## nVent CADDY All-in-One Between-Stud Assemblies

### NVENT CADDY ALL-IN-ONE BETWEEN-STUD BRACKET

- Versatile bracket for mounting nVent CADDY All-in-One box assemblies
- Provides excellent rigidity and reduces issues at trim out
- nVent CADDY All-in-One box assemblies simply slide and lock in to place with provided screws
- Perfect for jobs when specifications require precise box location
- 24" stud spacing requires use of three mounting screws.
- Made in the USA



Material: Steel  
Finish: Pregalvanized



Part #	Description	
A1B1624	nVent CADDY All-in-One Between-Stud Bracket	50 pc
A1B1624SP250	nVent CADDY All-in-One Between-Stud Bracket	250 pc

Use only with nVent CADDY All-in-One box assemblies.

# NVENT CADDY ALL-IN-ONE ELECTRICAL ASSEMBLIES

## nVent CADDY All-in-One Floor-Mounted Assemblies

### ALL-IN-ONE FLOOR-MOUNTED WITH REMOVABLE MUD RING

- Features the patented Open Back Box to simplify on site wiring process
- Preset to a finish height of 18" from the floor (adjustable to 12" or 15")
- Removable mud ring provides front access to the interior of the box
- Box remains fixed in place when mud ring is removed
- Integrated first means of support accepts conduit or MC/AC cable
- Accommodates additional nVent CADDY All-in-One box assemblies, support brackets and low-voltage mounting plates
- Includes multiple 1/2" and 3/4" knockouts on each side of the box
- Made in the USA



Material: Steel  
 Finish: Pregalvanized  
 EMT Conduit Size: 1/2"; 3/4"  
 MC/AC Cable Size: 14-2 to 12-3  
 Knockout Sizes: (8) 1/2", 3/4"; (3) 1/2"



Part #	Description	
A1FF1GS	1 Gang, w/Ground, 5/8" Drywall, 2 1/2"	5 pc
A1FF1G	1 Gang, w/Ground, 5/8" Drywall, 3 5/8"	5 pc
A1FF2GS	2 Gang, w/Ground, 5/8" Drywall, 2 1/2"	5 pc
A1FF2G	2 Gang, w/Ground, 5/8" Drywall, 3 5/8"	5 pc

Ground wire pigtail is 10".

# NVENT CADDY ALL-IN-ONE ELECTRICAL ASSEMBLIES

## nVent CADDY All-in-One Floor-Mounted Assemblies

### ALL-IN-ONE FLOOR-MOUNTED WITH ADJUSTABLE MUD RING

- Features the patented Open Back Box to simplify on site wiring process
- Preset to a finish height of 18" from the floor (adjustable to 12" or 15")
- Adjustable mud ring accommodates various thicknesses of drywall
- Can be adjusted after the installation of drywall
- Box remains fixed in place when mud ring is removed
- Integrated first means of support accepts conduit or MC/AC cable
- Accommodates additional nVent CADDY All-in-One box assemblies, support brackets and low-voltage mounting plates
- Includes multiple 1/2" and 3/4" knockouts on each side of the box



Material: Steel  
Finish: Pregalvanized  
EMT Conduit Size: 1/2"; 3/4"  
MC/AC Cable Size: 14-2 to 12-3  
Knockout Sizes: (8) 1/2", 3/4"; (3) 1/2"



Part #	Description	
A1FFV1G	1 Gang, 3/4"-1 1/2" Drywall	5 pc
A1FFV2G	2 Gang, 5/8"-1 1/2" Drywall	5 pc

Ground wire pigtail is 10".

# NVENT CADDY ALL-IN-ONE ELECTRICAL ASSEMBLIES

## nVent CADDY All-in-One Floor-Mounted Assemblies

### NVENT CADDY ALL-IN-ONE FLOOR-MOUNTED WITHOUT MUD RING

- Features the patented Open Back Box to simplify on site wiring process
- Preset to a finish height of 18" from the floor (adjustable to 12" or 15")
- Integrated first means of support accepts conduit or MC/AC cable
- Provides the flexibility to add a mud ring for non-standard drywall thicknesses
- Box remains fixed in place when mud ring is removed
- Accommodates additional nVent CADDY All-in-One box assemblies, support brackets and low-voltage mounting plates
- Includes multiple 1/2" and 3/4" knockouts on each side of the box
- Works with standard US and Canadian mud rings
- Made in the USA



Material: Steel  
 Finish: Pregalvanized  
 EMT Conduit Size: 1/2"; 3/4"  
 MC/AC Cable Size: 14-2 to 12-3  
 Knockout Sizes: (8) 1/2", 3/4"; (3) 1/2"



Part #	Description	
A1FF0G	w/Ground, 3 5/8"	5 pc
A1FF0GS	w/Ground, 2 1/2"	5 pc

Ground wire pigtail is 10".

# NVENT CADDY ALL-IN-ONE ELECTRICAL ASSEMBLIES

## nVent CADDY All-in-One Floor-Mounted Assemblies

### NVENT CADDY ALL-IN-ONE FLOOR-MOUNTED BRACKET

- Versatile bracket for mounting nVent CADDY All-in-One box assemblies
- Positions box a fixed distance from the floor eliminating the need to measure and promoting consistent placement
- Provides excellent rigidity and reduces issues at trim out
- Dual mounting tabs allow bracket to be installed on either side of the stud
- Integrated first means of support accepts conduit or MC/AC cable
- Accommodates additional nVent CADDY All-in-One box assemblies, support brackets and low-voltage mounting plates
- Made in the USA



Material: Steel  
Finish: Pregalvanized  
EMT Conduit Size: 1/2"; 3/4"  
MC/AC Cable Size: 14-2 to 12-3



Part #	Description	
A1F1218	nVent CADDY All-in-One Floor-Mounted Bracket	15 pc

### ADAPTER PLATE

- Supports 4-11/16" box to nVent CADDY All-in-One Between-Stud Bracket
- Allows 4" mud ring to be attached to a 4-11/16" box



Material: Steel  
Finish: Electrogalvanized



Part #	Description	
TBSBA4	Adapter Plate	25 pc

# NVENT CADDY ALL-IN-ONE ELECTRICAL ASSEMBLIES

## nVent CADDY All-in-One Accessories

### ADJUSTABLE MUD RING

- Adjustable mud ring accommodates various thicknesses of drywall
- Can be adjusted after the installation of drywall



Material: Steel  
Finish: Pregalvanized



Part #	Description	
AMR1020SG	1 Gang, 5/8"–1 1/4" Drywall	20 pc
AMR1224SG	1 Gang, 3/4"–1 1/2" Drywall	20 pc
AMR1024DG	2 Gang, 5/8"–1 1/2" Drywall	20 pc
AMR1224TG	3 Gang, 3/4"–1 1/2" Drywall	20 pc

### ADJUSTABLE ROUND MUD RING

- Adjustable mud ring accommodates various thicknesses of drywall
- Can be adjusted after the installation of drywall



Material: Steel  
Finish: Pregalvanized



Part #	Description	
AMR1224R0	Adjustable Round Mud Ring	25 pc



# NVENT CADDY ALL-IN-ONE ELECTRICAL ASSEMBLIES

## nVent CADDY All-in-One Accessories

### PROTECTOR PLATE

- Protects electrical devices during drywall installation
- Gangable
- Use with Switch Protector Plate Insert (sold separately) to protect toggle switches



Material: Steel  
Finish: Pregalvanized

Part #	Description	
PRP1G	Protector Plate	50 pc

### SWITCH PROTECTOR PLATE INSERT

- For use with Protector Plate to protect toggle switches during drywall installation



Material: Steel  
Finish: Pregalvanized

Part #	Description	
PRPDH	Switch Protector Plate Insert	50 pc

# Stud Wall



## STUD WALL

### Adjustable Far-Side Box Supports

#### ADJUSTABLE FAR-SIDE BOX SUPPORT

- Provides far side electrical box support in various stud wall depths



Material: Steel  
Finish: Pregalvanized



Part #	Description	
766	2 1/2", 3 5/8", 4" Wall Depth	100 pc

No load rating, for positioning only.

#### ADJUSTABLE FAR-SIDE BOX SUPPORT, SPRING STEEL

- Prevents boxes from being pushed back into the stud cavity, reducing costly trim out issues
- Attaches quickly and securely to the side of the box
- Installs without the use of tools or screws



Material: Spring Steel  
Finish: nVent CADDY Armour



Part #	Description	
J1A35	2 1/2", 3 5/8" Stud	100 pc

No load rating, for positioning only.

#### ADJUSTABLE FAR-SIDE BOX SUPPORT, BACK MOUNT

- Provides far side electrical box support in various stud wall depths



Material: Steel  
Finish: Pregalvanized



Part #	Description	
766A	2 1/2", 3 1/2", 4", 6" Wall Depth	100 pc

No load rating, for positioning only.

## STUD WALL

### Adjustable Far-Side Box Supports

#### ADJUSTABLE FAR-SIDE BOX SUPPORT, PLASTIC

- Prevents boxes from being pushed back into the stud cavity, reducing costly trim out issues
- Easily snaps into existing box holes
- Provides rigid support near the center of the box
- No adjustment needed in a 3-5/8" wall
- Can be stacked or trimmed for any stud wall depth



Material: Acrylonitrile Butadiene Styrene  
Finish: Plain



Part #	Description	
766PM	1 1/2" Box Depth	100 pc
766PMD	2 1/8" Box Depth	100 pc

No load rating, for positioning only.

#### FAR-SIDE BOX SUPPORT EXTENSION



Material: Steel  
Finish: Pregalvanized



Part #	Description	
TEB6XT	6" Wall Depth	100 pc

# STUD WALL

## Between Stud Box Mounting Brackets

### HEAVY DUTY RIGID BOX SUPPORT

- Heavy duty design with increased strength that is twice as strong than the first generation rigid box support
- Supports electrical boxes, plaster rings or low voltage devices from one bracket
- Accepts vertically or horizontally mounted single and double gang adjustable mud rings
- Designed to work with snap in place first means of support for conduit and cables



Material: Steel  
Finish: Pregalvanized



Part #	Description	
RBS16HD	3 Box	25 pc
RBS24HD	4 Box	25 pc

### RIGID BOX SUPPORT

- Eliminates the need for an electrical box on low voltage applications
- Supports electrical boxes, plaster rings or low voltage devices from one bracket

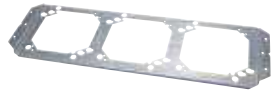

Material: Steel  
Finish: Pregalvanized



Part #	Description	
RBS16	3 Box	25 pc
RBS24	4 Box	25 pc

## STUD WALL

### Between Stud Box Mounting Brackets

#### FLAT RIGID BOX SUPPORT

- Created from one single piece of steel with no offset resulting in a completely flat bracket
- Accepts any mud ring shape in either vertical or horizontal orientation
- Extruded holes allow mounting of mud rings for both power and data applications
- Stamped with A- and B-side markings that allow mounting for all box types and configurations – no need for removal of screws – simply flip and it's ready to use

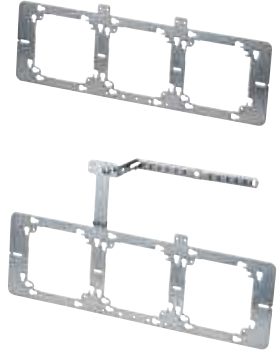

Material: Steel  
Finish: Pregalvanized



Part #	Description	
FB16	Flat Rigid Box Support	25 pc

#### FLOOR STAND FOR FLAT RIGID BOX SUPPORT

- Positions boxes 18-1/2" from the floor eliminating the need to measure and promoting consistent placement
- Meets ADA (Americans with Disabilities Act) accessibility guidelines providing a 15" height minimum for "forward reach" from a wheelchair
- Attaches to Flat Rigid Box Support with rivets or screws
- Finder tab helps locate electrical box behind drywall
- Innovative design allows floor stand to be easily installed onto floor track



Material: Steel  
Finish: Pregalvanized

Part #	Description	
FB16FS	Positions boxes 18-1/2" from the floor	20 pc

## STUD WALL

### Between Stud Box Mounting Brackets

#### FIRST MEANS OF SUPPORT FOR FLAT RIGID BOX SUPPORT

- Provides reliable, rigid, support when mounted to the top of the Flat Rigid Box Support
- Securely holds within the stud space and is compatible with the "Colorado Jim" Cable Support
- Allows you to install any box, regardless of depth
- Use self drilling/tapping screws for mounting onto bracket

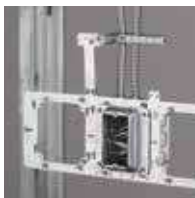

Material: Steel  
Finish: Pregalvanized

Part #	Description	
FB16FM	First Means of Support for Flat Rigid Box Support	50 pc

#### TELESCOPING RIGID BOX SUPPORT

- Accommodates up to 6-gang box in 16" stud spacing or up to 10-gang in 24" stud spacing
- Will support four electrical boxes in 24" stud spacing
- Open design allows a variety of positions for box location
- Easy to adjust after the electrical box is installed
- For use with 4" square and 4-11/16" boxes and mud rings
- Unique, one-piece, break apart design



Material: Steel  
Finish: Pregalvanized



Part #	Description	
TSRBS1625	16"-24" Stud Spacing	25 pc

## STUD WALL

### Between Stud Box Mounting Brackets

#### HEAVY DUTY TELESCOPING BRACKET

- Innovative design allows boxes to be added or removed without removing bracket from studs
- Attach boxes quickly and easily with snap-on box mounting plates (sold separately)
- Box mounting plates can be securely snapped in any position along fully extended bracket
- Rigid design eliminates need for far-side support
- Ready to use out of the box, saving installation time and labor
- Works with wood or metal studs

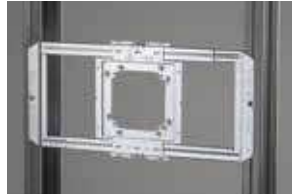

Material: Steel  
Finish: Pregalvanized



Part #	Description	
TB1624HD	14 1/2"–25" Stud Spacing	25 pc

#### BOX MOUNTING PLATE

- Snap-on installation to Heavy Duty Telescoping Bracket allows for easy positioning along bracket
- Can also be mounted directly to metal or wood studs
- Key holes provide ease of installation and positive location when mounting boxes
- Extruded holes allow mounting of mud rings for both power and data applications
- Screws can be removed and reinstalled in extruded holes multiple times without compromising holding strength
- Accepts vertically or horizontally mounted single and double gang adjustable mud rings



Material: Steel  
Finish: Pregalvanized



Part #	Description	
TB45P	4", 4 11/16", 5" Box	25 pc



## STUD WALL

### Between Stud Box Mounting Brackets

#### UNIVERSAL BOX MOUNTING PLATE

- Snap-on installation to Heavy Duty Telescoping Bracket allows for easy positioning along bracket
- Can also be mounted directly to metal or wood studs
- Keyhole pattern designed to accommodate both mounting screw orientations for 4-11/16" boxes
- 4-11/16" boxes can be rotated for top, bottom and side knockouts without moving box mounting screws
- Holes for mounting mud rings without electrical box for low voltage applications
- Accepts vertically or horizontally mounted single and double gang adjustable mud rings
- Bracket, plate and box can be preassembled to save time on the jobsite
- Ideal for pre-fab assemblies



Material: Steel  
Finish: Pregalvanized



Part #	Description	
TB4PU	4", 4 11/16" Box	25 pc

#### BOX MOUNTING PLATE WITH FAR SIDE SUPPORT

- Snap-on installation to Heavy Duty Telescoping Bracket allows for easy positioning along bracket
- Can also be mounted directly to metal or wood studs
- Innovative far side support allows bracket to be installed on virtually any stud depth and up to 3" wide studs
- Key holes provide ease of installation and positive location when mounting boxes
- Extruded holes allow mounting of mud rings for both power and data applications
- Screws can be removed and reinstalled in extruded holes multiple times without compromising holding strength
- Accepts vertically or horizontally mounted single and double gang adjustable mud rings



Material: Steel  
Finish: Pregalvanized



Part #	Description	
TB45PK	4", 4 11/16", 5" Box	25 pc

## STUD WALL

### Between Stud Box Mounting Brackets

#### NVENT CADDY FIRE ALARM BOX WITH HEAVY DUTY BRACKET

- Adjustable depth Fire Alarm Box with mounting plate that snaps on to TB1624HD
- Easily adjusts from 1/2" to 1 1/2" for multiple depth walls and ceiling applications
- Can be mounted directly to stud for on stud application
- Design provides built in far side support for 3 5/8" stud depths



Material: Steel

Finish: Pregalvanized, Powder Coat

Part #	Description	
TB435FB	4" square box, 3 1/2" deep. Multiple KO's - dual 1/2" and 3/4"	10 pc

#### NVENT CADDY FIRE ALARM BOX WITH MULTIPLE KNOCKOUTS

- Powder coating inside and outside of box.
- Deep box for over-sized alarm devices
- 16 ga. Welded construction



#### NVENT CADDY ELECTRICAL BOX WITH MULTIPLE KNOCKOUTS

- Extra deep design
- 16 ga. Welded construction



Material: Steel

Finish: Pregalvanized, Powder Coat

Material: Steel

Finish: Pregalvanized

Part #	Description		Part #	Description	
BX435RD	4" sq. box, 3 1/2" deep. Dual 1/2" and 3/4" KO's	20 pc	BX435	4" sq. box, 3 1/2" deep. Dual 1/2" and 3/4" KO's	20 pc

#### FIRST MEANS OF SECUREMENT FOR HEAVY DUTY BOX BRACKET

- Provides first means of securement for MC/AC and EMT conduit
- Works with Heavy Duty Rigid Box Support and Heavy Duty Telescoping Bracket
- Snaps into channel and locks into place without screws
- Rigid locking tab securely locks into place when closed and opens for easy conduit placement



Material: Steel

Finish: Pregalvanized



Part #	Box Size	EMT Conduit Size	MC/AC Cable Size	
FM4	4"	3/4"	14-2 to 12-3	20 pc
FM411	4 11/16"	3/4"	14-2 to 12-3	20 pc

## STUD WALL

### Stud Mounted Box Brackets

#### SNAP TO STUD ELECTRICAL BOX BRACKET

- Snap to stud function makes installation fast and easy, saving time and increasing productivity
- Self-leveling feature ensures the electrical box is always square to the stud, for a consistent and professional installation
- Mounts to either side of the stud and can be mounted side by side on the same stud
- Accommodates all stud depths
- Works with standard or adjustable single and double gang mud rings
- Rigid design delivers consistency and quality during the trim out phase, helping reduce call backs and costly repairs
- Additional mounting tabs allow the bracket to be secured to the front and inside face of the stud for extra stability
- Specially shaped key holes help keep the box assembled even when the mud ring is removed, providing greater access to the box in the field



Material: Steel

Finish: Electrogalvanized

Part #	Description	
STS2346	2 1/2", 3 5/8", 4", 6" Wall Depth, 4", 4 11/16" Box	25 pc

#### UNIVERSAL ELECTRICAL BOX BRACKET

- Can be pre-fabricated prior to attaching box to the bracket
- Box locking tabs securely lock electrical boxes in place to prevent disassembly during shipment
- Mounts electrical boxes
- Mounts plaster rings for low voltage applications
- Easily identify mounting orientation of electrical boxes
- Feet on the far-side supports help prevent damage to the drywall
- Can be mounted to stud on all four sides
- Designed with two far-side supports for added stability
- Allows any box size to be used

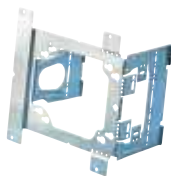

Material: Steel

Finish: Pregalvanized



Part #	Description	
TEB23	2 1/2", 3 5/8" Wall Depth	50 pc
TEB4	4" Wall Depth	50 pc

Octagonal keyholes for 4" boxes, round keyholes for 4-11/16" boxes.

# STUD WALL

## Stud Mounted Box Brackets

### “MOUNTS ELECTRICAL BOXES” BRACKET

- Design simplifies handling, reduces inventory and saves space
- Requires only a screw gun to install
- V-notched on center allows for consistent positioning
- Built-in support legs reduce box movement
- Can be used with EMT; ideal for flexible conduit, MC/AC or non-metallic sheathed cable
- Can be pre-assembled in the shop to allow for greater efficiency at the job site
- Plaster rings can be mounted separately eliminating the need for an electrical box for low-voltage applications
- MP Series brackets can be attached in-line to the MEB1 for low voltage applications
- Mounts on either side of stud without need to reposition box

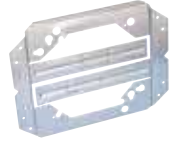

Material: Steel  
Finish: Pregalvanized



Part #	Description	
MEB1	2 1/2", 3 1/2", 4" Wall Depth	25 pc

### C SERIES ELECTRICAL BOX BRACKET TO STUD

- Replaces H-Brackets with improved design
- Thicker steel to significantly increase rigidity and help prevent box movement and trim out issues
- Works with both standard and adjustable single and double gang mud rings
- Mounts plaster rings for low voltage applications
- Additional bend points on C4 and C6 brackets for greater versatility



Material: Steel  
Finish: Pregalvanized



Part #	Description	
C23	2 1/2", 3 5/8" Wall Depth, 3.51"	100 pc
C4	2 1/2", 3 5/8", 4" Wall Depth, 3.89"	100 pc
C6	2 1/2", 3 5/8", 5 1/2", 6" Wall Depth, 5.89"	50 pc

## STUD WALL

### Stud Mounted Box Brackets

#### SCREW-ON BOX SUPPORT

- Permits positioning of metal electrical box anywhere on metal or wood stud, regardless of stud size
- Securely held in place with screws



Material: Spring Steel  
Finish: nVent CADDY Armour



Part #	Description	
350	4", 4 11/16" Box	100 pc

#### MSF SNAP-ON BOX SUPPORT

- Spring steel for press-on attachment
- Center hole assists in consistent alignment, exact positioning and screw attachment
- Requires hammer to attach clip to box



Material: Spring Steel  
Finish: nVent CADDY Armour



Part #	Description	
MSF	MSF Snap-On Box Support	100 pc

#### ADJUSTABLE DEPTH SNAP-ON SWITCH BOX SUPPORT

- Allows the switch box to protrude through any size drywall
- Fits most drywall studding



Material: Spring Steel  
Finish: nVent CADDY Armour



Part #	Description	
MFS	1 3/8"-1 1/2" x 1/4"-3/4"	100 pc

## STUD WALL

### Stud Mounted Switch Box Brackets

#### FIXED DEPTH SNAP-ON SWITCH BOX SUPPORT

- Allows the switch box to protrude through any size drywall
- Fits most drywall studding



Material: Spring Steel  
Finish: nVent CADDY Armour



Part #	Description	
MF625	5/8" Drywall	100 pc
MF750	3/4" Drywall	100 pc
MFO	Fixed Depth Snap-On Switch Box Support	100 pc

When attaching flush to stud face, use part MFO.

#### BETWEEN STUD PANEL MOUNTING BRACKET

- Panel bracket attaches to panel box providing a rigid surface to
- quickly and easily secure flexible conduit
- Ideal for contractors wanting to pre-fab panel boxes
- Fasten and protect cables during assembly, shipping, and installation
- Makes installing panel box between studs easier saving time and labor
- Can be used in combination with MC/AC Cable to Metal Stud Clip to securely attach 14-2 to
- 12-3 MC/AC size cables creating a tool free attachment process



Material: Steel  
Finish: Pregalvanized

Part #	Description	
PB16	16" Stud Spacing	5 pc

Panel box sold separately.

# STUD WALL

## Cable/Conduit to Stud

### STUD SPANNER BAR

- Secures EMT, MC/AC, and flexible conduit between metal studs
- Innovative clip securely attaches to metal studs in pre-punched holes
- Roll-formed bar for increased strength and rigidity
- Use with Cable/Conduit Clip to secure conduit and cable to bar
- Adjustable for non-standard stud spacing
- No tools required for installation



Material: Steel, Spring Steel  
Finish: Pregalvanized, nVent CADDY Armour



Part #	Description	
BG16	16" Stud Spacing	25 pc
BG24	24" Stud Spacing	25 pc

### STUD SPANNER BAR CLIP

- Attaches to smooth or threaded rod to secure EMT, MC/AC, and flexible conduit between metal studs
- Innovative clip securely attaches to metal studs in pre-punched holes
- Adjustable for non-standard stud spacing
- No tools required for installation



Material: Spring Steel  
Finish: nVent CADDY Armour



Part #	Description	
BGC	Stud Spanner Bar Clip	100 pc

# STUD WALL

## Cable/Conduit to Stud

### MC/AC AND NON-METALLIC SHEATHED CABLE SUPPORT

- Effectively supports non-metallic sheathed and MC/AC cables
- Secures cables 1-1/4" from the face of the stud
- Flared edges prevent damage to the cable jacket
- Holds up to four MC/AC cables or four 12-3 non-metallic sheathed cables with ground
- Unique "stop-bend" design helps prevent cables from being installed too far from face of stud



Material: Steel  
Finish: Pregalvanized



Part #	Description					
CER4	MC/AC and Non-Metallic Sheathed Cable Support					100 pc
Cable Size	MC/AC 14-2 w/ground	MC/AC 12-3 w/ground	MC/AC 12-4 through 10-4	MC/AC single cables up to 6-3 stranded	Non-metallic sheathed cables up to 12-3 w/ground	
# of Cables	4	3	2	1	4	



## STUD WALL Cable/Conduit to Stud

### SNAP TO STUD CABLE SUPPORT

- Snap to stud function makes installation fast and easy, saving time and increasing productivity
- No tools or fasteners needed for installation
- Easy-to-use locking tab
- Cable locating ribs to maintain cable separation
- Flared edges for cable protection
- NEC® 300.4D applicable



Material: Steel  
Finish: Pregalvanized



Part #



CJ6STS

100 pc

Cable Type	Cable Size	Cables Per Fastener
Non-Metallic Sheathed Cable	14-2, 12-2, 10-2, 14-3, 12-3 and 10-3 w/ground	6 Max
	8-2 and 6-2 w/ground	4 Max
Metal Clad (MC)	14-2, 12-2, 10-2, 14-3, 12-3, 10-3, 14-4, 12-4 and 10-4 w/ground	4 Max
Armored Cable (AC)	14-2, 12-2, 10-2, 14-3, 12-3, 10-3, 14-4, 12-4 and 10-4 w/ground	4 Max
Flexible Metal Conduit (BX)	3/8"	4 Max

# STUD WALL

## Cable/Conduit to Stud

### "COLORADO JIM" CABLE SUPPORT

- Easy-to-use locking tab
- Cable locating ribs to maintain cable separation
- Flared edges for cable protection
- NEC® 300.4D applicable
- For wood or metal stud



Material: Steel  
Finish: Pregalvanized



Part #	Description	
CJ6	"Colorado Jim" Cable Support	100 pc
CJ6IN (Canada)	"Colorado Jim" Cable Support	100 pc

### "COLORADO JIM" CABLE SUPPORT WITH STANDOFF

- Easy-to-use locking tab
- Cable locating ribs to maintain cable separation
- Flared edges for cable protection
- NEC® 300.4D applicable
- AC or Flexible Cable to Furring strip and hat channel



Material: Steel  
Finish: Pregalvanized



Part #	Description	
CJ6S	"Colorado Jim" Cable Support with Standoff	100 pc

Part #	Cable Type	Cable Size	Cables Per Fastener
CJ6 to Wood	Non-Metallic	14-2, 12-2, 10-2, 14-3, 12-3 and 10-3 w/ground	Max 6
		8-2 and 6-2 w/ground	Max 4
CJ6 to Metal Stud	Metal Clad (MC)	14-2, 12-2, 10-2, 14-3, 12-3, 10-3, 14-4, 12-4 and 10-4 w/ground	Max 4
CJ6S to Furring Strip and Hat Channel	Armored Cable (AC)	14-4, 12-2, 10-2, 8-2, 14-3, 12-3, 10-3, 14-4, 12-4 and 10-4 w/ground	Max 4
		Flexible Conduit (BX)	5/16", 3/8"
CJ6IN to Metal Stud (Canada only)	Non-Metallic Sheathed Cable	14-2, 12-2, 10-2, 14-3, 12-3 and 10-3 w/ground	Max 4

## STUD WALL

### Cable/Conduit to Stud

#### CS812 CABLE/CONDUIT TO STUD ATTACHMENT

- Accommodates EMT conduit and MC/AC cable
- Easily locate the fastener on the stud, keeping your conduit in line with box knock out and H-series brackets
- For wood or metal stud
- Eliminates offset bending of conduit
- Compliant with NEC® Article 358.30(A), which requires conduit support within 36" of an electrical box
- Compliant with CEC Rule 12-1404, which requires conduit support within 1 m of an electrical box
- Compliant with CEC Rule 12-618, which requires support of armoured cable within 300 mm (12") of an electrical box



Material: Spring Steel  
Finish: nVent CADDY Armour



Part #	Description	
CS812	1/2", 3/4" EMT, 1 1/2" Box Depth	100 pc
CS812D	1/2", 3/4" EMT, 2 1/8" Box Depth	100 pc
CS16	1" EMT, 2 1/8" Box Depth	100 pc

#### CABLE SUPPORT TO STUD

- Provides secure support of NMC or MC/AC to metal/wood stud in seconds
- One fastener, four applications
- Delivers compliance with NEC® 300.4(d), CEC 12-618 and CEC 12-510
- No installation tools required



Material: Spring Steel  
Finish: nVent CADDY Armour



Part #	Description	
FXC20	7/16"–9/16" OD, 14-2 to 12-3 MC/AC, 14-2 to 12-3 NM	100 pc

# STUD WALL

## Cable/Conduit to Stud

### MC/AC CABLE TO STUD CLIP

- Manufactured with stabilizer legs for virtually “wobble-free” support
- Snaps into place on metal stud and beam flange
- No tools required for installation
- Pre-punched holes in clip allow it to be screwed to wood stud, concrete or block
- Compliant with NEC® Article 300.4(d), allowing cable to be positioned a minimum of 1-1/4” from face of stud
- Compliant with CEC Rule 12-618 for support of MC/AC cable
- Factory riveted assemblies are available for installation on flange, purlin, acoustical tee, drop wire, concrete, block or wood and metal stud
- MAC2 snaps in half to accommodate single run of cable effectively making two clips from one



Material: Spring Steel  
Finish: nVent CADDY Armour



Part #	Description	
MAC2	1/8" Max Flange, 14-2 to 10-3 MC/AC	100 pc

Assemblies allow for support from most main and substructures.

### MC/AC DOUBLE CABLE TO STUD CLIP

- Manufactured with stabilizer legs for virtually “wobble-free” support
- No tools required for installation
- Compliant with NEC® Article 300.4(d), allowing cable to be positioned a minimum of 1-1/4” from face of stud
- Compliant with CEC Rule 12-618 for support of MC/AC cable



Material: Spring Steel  
Finish: nVent CADDY Armour



Part #	Description	
MAC2T	14-2 to 10-3 MC/AC	100 pc

Assemblies allow for support from most main and substructures.

## STUD WALL

### Cable/Conduit to Stud

#### MC/AC CABLE TO METAL STUD CLIP

- Easily attaches MC or AC to metal stud
- No tools required for installation
- Provides fast installation



Material: Spring Steel  
Finish: nVent CADDY Armour



Part #	Description	
449	14-2 to 12-3 MC/AC	100 pc

#### 350-M CONDUIT TO STUD ATTACHMENT

- Permits positioning of conduit anywhere on metal or wood stud, regardless of stud size
- Securely held in place with screws



Material: Spring Steel  
Finish: nVent CADDY Armour



Part #	Description	Cert	
350812M	1/2", 3/4" EMT, 0.709"–1.181" OD	cULus	100 pc
35016M	1" EMT, 1.181"–1.378" OD		100 pc

# STUD WALL

## Cable/Conduit to Stud

### 350-P CONDUIT TO STUD ATTACHMENT

- Permits positioning of conduit anywhere on metal or wood stud, regardless of stud size
- Securely held in place with screws



Material: Spring Steel  
Finish: nVent CADDY Armour

Part #	Description	
3508P	1/2" EMT, 0.709" Min, 0.866" Max, 0.706" Nom OD	100 pc
35012P	3/4" EMT, 0.866" Min, 1.181" Max, 0.922" Nom OD	100 pc
35016P	1" EMT, 1.181" Min, 1.378" Max, 1.163" Nom OD	100 pc

### MF-M CONDUIT TO STUD ATTACHMENT

- Easily snaps onto stud
- Snap-close conduit support
- Fasten to stud with screw for additional support



Material: Spring Steel  
Finish: nVent CADDY Armour



Part #	Description		Cert
812MF	1/2", 3/4" EMT, 0.709"-1.181" OD	100 pc	cULus
16MF	1" EMT	100 pc	cULus
20MF	1 1/4" EMT	50 pc	
6MF	3/8" Flexible, 14-2 to 12-3 MC/AC	100 pc	cULus

## STUD WALL

### Cable/Conduit to Stud

#### MF-P CONDUIT TO STUD ATTACHMENT

- Easily snaps onto stud
- Push-in conduit support
- Fasten to stud with screw for additional support



Material: Spring Steel  
Finish: nVent CADDY Armour

Part #	Description	
8PF	1/2" EMT, 0.709"–0.866" OD	100 pc
12PF	3/4" EMT, 0.866"–1.181" OD	100 pc
16PF	1" EMT, 1.181"–1.378" OD	100 pc

#### MFI CONDUIT TO STUD ATTACHMENT

- Thread impression provides means to attach any size conduit clip
- Easily snaps onto stud
- Fasten to stud with screw for additional support



Material: Spring Steel  
Finish: nVent CADDY Armour



Part #	Description	
MFI	1/4" Hole	100 pc

## STUD WALL

### Cable/Conduit to Stud

#### CABLE GRIPPER

- Attaches to existing holes in metal studs without tools or with Metal Stud Punch (MSP20)
- Delivers compliance with NEC® 300.4(d), CEC 12-510 and CEC 12-516
- Installs easily to metal and wood studs
- Provides secure installation of multiple cables with unique locking/ unlocking system
- Staples, nails or screws to wood stud
- Supports four NMC or eight 4-pair UTP, Category 5 and higher (electrical and datacomm cannot be combined)

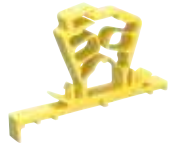

Material: Polypropylene  
Finish: Plain

Part #	Description	
CG4	Cable Gripper	100 pc

#### DEVICE LEVELER AND RETAINER

- Use for oversize drywall openings
- Helps prevent broken cover plates
- Helps prevent device from being pushed back in wall
- Makes floating device rigid



Material: Steel  
Finish: Plain



Part #	Description	
RLC	Device Leveler and Retainer	100 pc



## STUD WALL

### Floor Mounted Box Supports

#### FOOTED BOX SUPPORT

- Supports electrical boxes from floor or concrete forms
- Slot provides for 8" (203 mm) height adjustment
- Use with Multiple Conduit Support for conduits in concrete pours



Material: Steel  
Finish: Pregalvanized

Part #	Description	
FBS12	12" Above Floor	50 pc
FBS16	16" Above Floor	50 pc
FBS18	18" Above Floor	50 pc

#### FMBS1824 FLOOR MOUNTED BOX SUPPORT

- Meets ADA (Americans with Disabilities Act) accessibility Guidelines Standards; 15" height minimum for "forward reach" from a wheelchair
- Quick, easy and efficient compliance to construction requirements
- Mounts inside (use mounting tabs) or under floor track
- Versatile positioning - independent of wall stud location
- Built-in far-side back support
- Reduces stocking different size brackets
- Accommodates additional brackets for multiple box and device mounting
- Mounts plaster rings for low voltage applications



Material: Steel  
Finish: Pregalvanized



Part #	Description	
FMBS1824	FMBS1824 Floor Mounted Box Support	10 pc

# STUD WALL

## Floor Mounted Box Supports

### FMBS18 FLOOR MOUNTED BOX SUPPORT

- Meets ADA (Americans with Disabilities Act) accessibility Guidelines Standards; 15" height minimum for "forward reach" from a wheelchair
- Quick, easy and efficient compliance to construction requirements
- Mounts inside (use mounting tabs) or under floor track
- Versatile positioning - independent of wall stud location
- Built-in far-side back support
- Reduces stocking different size brackets
- Accommodates additional brackets for multiple box and device mounting
- Mounts plaster rings for low voltage applications



Material: Steel  
Finish: Pregalvanized



Part #	Description	
FMBS18	18 1/2" Above Floor	25 pc

### SNAP-ON NAIL PLATE

- Protects electrical and mechanical installation through studs
- For wood and metal studs
- Press-on installation
- No tools required
- Breakable tabs permit multiple plates to be ganged together
- Holes on legs and surface of plate are provided to secure with nail or screw



Material: Steel  
Finish: nVent CADDY Armour



Part #	Description	
304B2	3 1/8" x 1 1/2"	100 pc

## STUD WALL

### Old Work Box Mounts

#### DSI OLD WORK BOX MOUNT

- One-piece, break-apart design is easy to handle
- Works on drywall, lath and plaster; only a drywall saw required

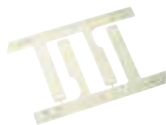

Material: Steel  
Finish: Pregalvanized



Part #	Description	
DSI2A	1/4"–1 1/2" Drywall	100 pc

#### SNAP TO STUD TELESCOPING SCREW GUN BOX BRACKET

- Snap to stud function makes installation fast and easy, saving time and increasing productivity
- Self-leveling feature ensures the bracket is always square to the stud, for a consistent and professional installation
- Pre-configured for 2-1/8" deep boxes and only a simple adjustment needed for 1-1/2" deep boxes
- Can mount multiple boxes
- Requires only two screws to install



Material: Steel  
Finish: Pregalvanized



Part #	Description	
TSGB1624S	Snap to Stud Telescoping Screw Gun Box Bracket	50 pc

# STUD WALL

## Screw Gun Brackets and Accessories

### TELESCOPING SCREW GUN BOX BRACKET

- Can mount multiple boxes
- Notched and marked for easy identification and bending
- Improved design with stamped inch markings and pilot holes accelerates precise box conduit mounting between studs
- Pilot holes allow easy box attachment with a screwdriver
- Requires only a screw gun to install
- Can be mounted to face or inside of stud
- Adjustable for non-standard stud spacing
- Interlocking tab prevents accidental disassembly
- Unique, one-piece, break apart design
- Reduces movement of the box when used with flexible conduit, ENT, MC, AC or non-metallic sheathed cable

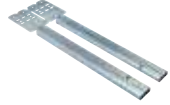

Material: Steel  
Finish: Pregalvanized



Part #	Description	
TSGB16	11"–18" Stud Spacing, 1 1/2", 2 1/8" Box Depth	50 pc
TSGB1624	15 3/4"–25" Stud Spacing, 1 1/2", 2 1/8", 2 1/2" Box Depth	50 pc
TSGB24	17"–26" Stud Spacing, 1 1/2", 2 1/8", 2 1/2" Box Depth	50 pc

### SCREW GUN BRACKET

- Can be pre-assembled by the contractor to allow for greater productivity at the job site
- Pre-set for studs widths



Material: Steel  
Finish: Plain



Part #	Description	
SGB16A	16" Stud Spacing	50 pc
SGB24A	24" Stud Spacing	50 pc

# STUD WALL

## Screw Gun Brackets and Accessories

### NVENT CADDY GLIDER ELECTRICAL BOX ATTACHMENT, SCREWLESS

- Secures electrical boxes to the TSGB without tools or screws
- Innovative design securely clips onto electrical box eliminating attachment screw
- Electrical boxes can be easily positioned along TSGB
- Allows closer installation of multiple boxes between or against the studs
- Allows for easy repositioning of electrical boxes
- Ideal for pre-fab assemblies



Material: Spring Steel  
Finish: nVent CADDY Armour



Part #	Description	
TSGLDR2	nVent CADDY Glider Electrical Box Attachment, Screwless	100 pc

### NVENT CADDY GLIDER ELECTRICAL BOX ATTACHMENT

- Attaches electrical boxes to the TSGB with a single screw, without tools and without need for disassembly
- Allows closer installation of multiple boxes between or against the studs
- Allows for easy repositioning of electrical boxes
- Ideal for pre-fab assemblies



Material: Spring Steel  
Finish: nVent CADDY Armour



Part #	Description	
TSGLDR1	Electrical Box Attachment, Spring Steel, #10 Hole	100 pc

# STUD WALL

## Screw Gun Brackets and Accessories

### MULTIPLE CONDUIT SUPPORT

- Use with screw gun brackets to support conduit between studs
- Use with Footed Box Support for conduits in concrete pours
- Eliminates offset bending of conduit



Material: Steel  
Finish: Pregalvanized

Part #	Description	
CCS812	1/2", 3/4" EMT, 1/2" Rigid	100 pc

### ELECTRICAL BOX MOUNTING STRAP

- Can be used as a height gauge for box center lines of 12", 15" or 18"
- Pre-punched holes provide easy screw insertion
- Keyholes allow simple premounting and installation of screws
- Replaces multiple SKUs compared to competitor products
- Marked centerline for 16" and 24" stud spacing
- Ideal for use with TEB23 and CER4 for box mounting
- Works with TSRBS1625 as a floor mounted box support



Material: Steel  
Finish: Pregalvanized



Part #	Description	
TEBS1624	24" Max Stud Spacing	50 pc

## STUD WALL

### Screw Gun Brackets and Accessories

#### SMS8 SELF-DRILLING AND TAPPING SCREW

- Suitable for screw gun use
- Thin "wafer-head" type



Material: Steel  
Finish: Electrogalvanized

Part #	Description	
SMS8	#8 Screw, 1/2" Screw	1,000 pc

#### THROUGH STUD CABLE/CONDUIT CLIP

- Eliminates conduit rattling
- Provides a quick means of support for horizontal runs of Rigid, EMT, MC/AC or ENT through metal stud
- One-piece spring steel design snaps onto stud



Material: Spring Steel  
Finish: nVent CADDY Armour

Part #	Description	
459	0.433"–0.535" OD, 14-2 to 12-3 MC/AC	100 pc
AR812	0.7"–0.925" OD, 1/2", 3/4" EMT, 1/2" Rigid, 5/8", 3/4" Copper Tube	100 pc

## STUD WALL

### Through Stud Cable/Conduit Supports

#### EASY SNAP GROMMET

- Provides 360° protection for cable, conduit, plumbing and fire sprinkler plumbing in metal studs
- Snap one grommet into standard 1-11/32" field punched hole, or snap two together into any shape factory-punched hole
- Grommet can be split for use on pre-existing installations
- Compliant with UL® 2043 and suitable for use in air handling (plenum) spaces



Material: Polyethylene

Part #	Description	
ESG1	1.315" OD	100 pc
ESG1M	1.315" OD	1,000 pc

#### EASY SNAP GROMMET WITH ANTI-RATTLE PROTECTION

- Provides anti-rattle protection
- Snap one grommet into standard 1-11/32" field punched hole, or snap two together into any shape factory-punched hole
- Grommet can be split for use on pre-existing installations
- Compliant with UL® 2043 and suitable for use in air handling (plenum) spaces



Material: Polyethylene

Part #	Description	
ESGP	1" Max Copper Tube, 1/2", 3/4" EMT, 1/2", 3/4" Rigid/Pipe	100 pc



## STUD WALL

### Through Stud Cable/Conduit Supports

#### EASY SNAP GROMMET FOR FACTORY PUNCHED HOLES

- Snap grommet into a factory punched hole of any shape
- Provides anti-rattle protection
- Provides 360° protection of conduit, plumbing and fire sprinkler plumbing in metal studs
- Compliant with UL® 2043 and suitable for use in air handling (plenum) spaces

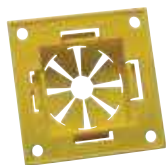

Material: Polyethylene

Part #	Description	
ESGFP	1" Max Copper Tube, 1/2", 3/4", 1" EMT, 1/2", 3/4", 1" Rigid/Pipe	100 pc

#### MSP20 METAL STUD PUNCH FOR EASY SNAP GROMMET

- Punches standard sized holes in metal studs
- Easy Snap Grommet snaps easily into punched hole
- Cushioned handles mean less operator fatigue and more comfortable handling
- Tool design with offset handles allows punch to work in confined locations and near perpendicular walls
- Lightweight punch makes accurate location of holes easier
- Hardened steel components keep tool sharp longer – less replacement



Material: Steel

Part #	Description	
MSP20	MSP20 Metal Stud Punch for Easy Snap Grommet	1 pc

## STUD WALL

### Through Stud Cable/Conduit Supports

#### ANTI-RATTLE SUPPORT

- Permits EMT, MC and AC to be pulled through metal stud
- Requires a self-tapping screw to install



Material: Steel  
Finish: Plain



Part #	Description	
781	Anti-Rattle Support	100 pc

#### FB-M THROUGH STUD CABLE/CONDUIT CLAMP

- Eliminates conduit rattling
- Provides a quick means of support for horizontal runs of Rigid, EMT, MC/AC or ENT through metal stud
- Installs with screw gun



Material: Spring Steel  
Finish: nVent CADDY Armour



Part #	Description	
FB812M	1/2", 3/4" EMT, 1/2", 3/4" Rigid	100 pc
FB6M	14-2 to 12-3 MC/AC, 3/8" Flexible	100 pc

#### FB-P THROUGH STUD CONDUIT CLAMP

- Eliminates conduit rattling
- Provides a quick means of support for horizontal runs of Rigid, EMT, MC/AC or ENT through metal stud
- Installs with screw gun



Material: Spring Steel  
Finish: nVent CADDY Armour

Part #	Description	
FB8P	1/2" EMT	100 pc
FB12P	3/4" EMT	100 pc

# STUD WALL

## nVent CADDY Prefab Solutions

CADDY Prefab Solutions configures electrical assemblies and delivers them on time to the job site, enabling an efficient, seamless installation. Through a manufactured wiring solution that incorporates needed accessories, our process can incorporate last-minute design changes while eliminating on-site storage requirements and minimizing the risk of theft.

Customers experience benefits of labor savings and improved material management, while the flexible engineering and manufacturing methodologies of CADDY Prefab Solutions help to reduce lead times and improve schedule attainment.

The organization was founded by experienced electrical contractors who work daily with our customers to deliver customized, quality systems. Our team is proud to serve as a trusted partner for contractors who strive to efficiently meet tight budgets and construction schedules for a variety of commercial projects.



### Developed by Electricians for Electricians.

Reduce Labor Cost - Improve Material Management - Stay On Schedule

### Our Process

From start to finish, our process ensures that CADDY Prefab Solutions are manufactured in an efficient manner and utilize innovative CADDY components for a superior installation.

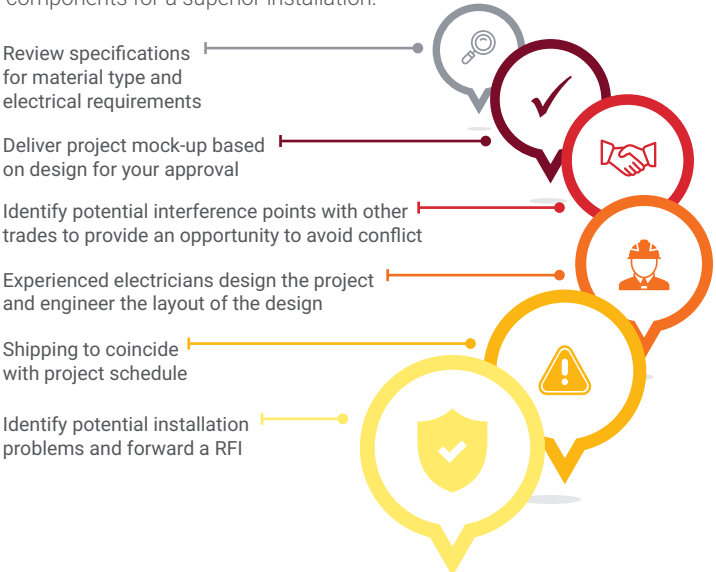

## Our Impact

Our solutions give contractors the ability to better control their overall project costs, improve material management and meet the challenging schedule demands in today's construction environment. CADDY Prefab Solutions are developed by electricians for electricians.

See our impact and learn the nVent CADDY difference below.

### 1 PROJECT COST SAVINGS

Solution is 90% complete when the system arrives. Delivery is direct to the job site, as product is needed.

### 2 LOWER INSTALLATION SKILL LEVEL REQUIRED

Keep experienced staff where they belong: working on more technical tasks.

### 3 ELIMINATION OF SPOT BUYING

Everything is preassembled and shipped complete, eliminating lost or missing items during install.

### 4 MATERIAL MANAGEMENT

Material purchasing and tracking is reduced to one supplier and is limited to releasing product as the schedule requires.

## The CADDY Prefab Difference

### DESIGN

Design services are standard with every project.

### CONSULT

Every project is assigned a design engineer. We've got you covered from start to finish.

### ADVISE

Our design engineers are highly skilled electricians with decades of field experience.

### PROTECT

Everything we build is UL listed, including the system itself.

### DELIVER

We deliver direct to job site as product is needed, reducing waste.

### TRUST

We've been in business for over a decade and work to make your job easier.

## Developed by Electricians for Electricians

CADDY Prefab Solutions designs and manufactures UL Listed, prefabricated branch wiring systems and delivers those systems direct to the electrical contractor. Our system gives contractors the ability to better control their labor cost, improve material management and meet the challenging schedule demands in today's construction environment.



### BOX EXTENDER

---

- Ability to level devices after drywall is installed.



### KICK-IN

---

- Our kick-in fastener provides consistent device heights.
- Assembled to various heights.



### SB

---

- Superior rigidity.
- Multiple box solution in one assembly.
- Adjustable box location prior to final install.



### OPEN-BACK DESIGN

---

- Patented Open Back Box design provides superior accessibility for wiring when devices are installed in prefab assemblies increasing installation efficiency and quality of workmanship.



### PANEL DESIGN

---

- Fully prefabricated load centers available upon request.

# Datacom/Low Voltage

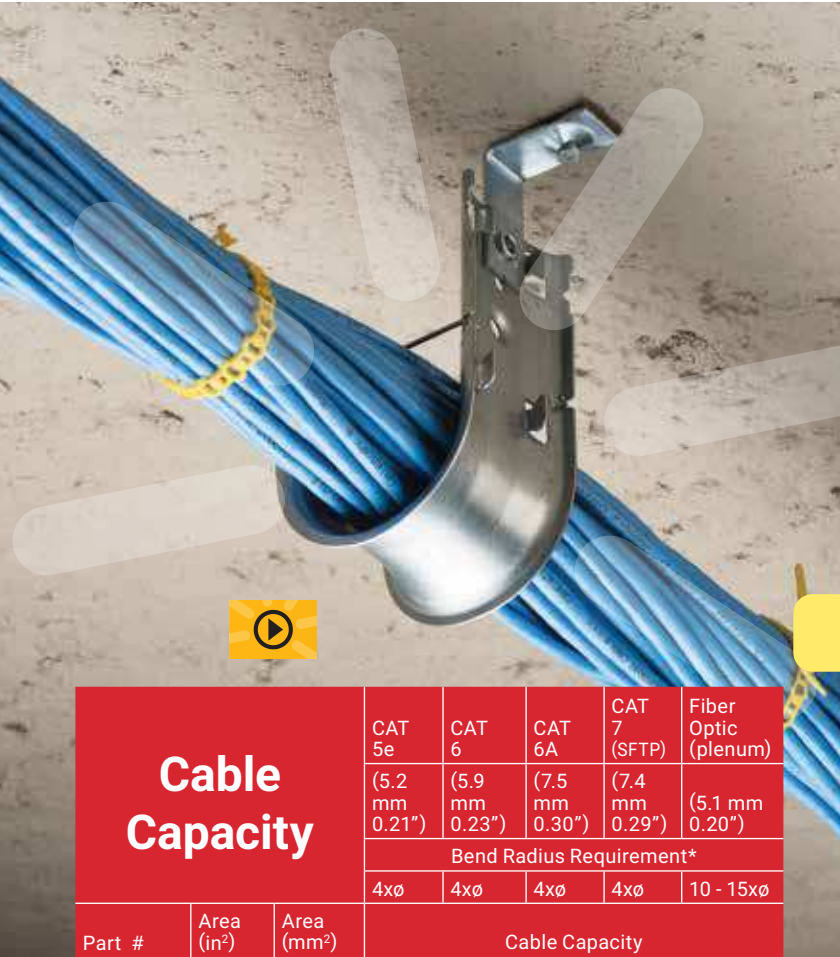

## Cable Capacity

CAT 5e	CAT 6	CAT 6A	CAT 7 (SFTP)	Fiber Optic (plenum)
(5.2 mm 0.21")	(5.9 mm 0.23")	(7.5 mm 0.30")	(7.4 mm 0.29")	(5.1 mm 0.20")
Bend Radius Requirement*				
4xø	4xø	4xø	4xø	10 - 15xø

Part #	Area (in <sup>2</sup> )	Area (mm <sup>2</sup> )	Cable Capacity				
CAT12	0.60	387	16	10	-	-	-
CAT16HP	1.07	690	20	15	10	10	20
CAT21HP	2.29	1,477	50	40	25	25	50
CAT32HP	3.97	2,561	90	60	35	35	90
CAT48HP	9.26	5,974	200	150	80	80	200
CAT64HP	15.48	9,987	330	220	140	140	330
CAT100CM	2 x 1.58	2 x 1,019	70	50	30	30	70
CAT200CM	21	13,548	450	350	215	215	450
CAT300CM	32	20,645	700	525	325	325	700
CAT425	20.43	13,181	425	325	210	210	425
CAT600	3.14	2,026	70	50	30	30	70
CATCR50	2.67	1,723	50	36	-	-	-

\* Verify bend radius requirements with cable manufacturer.  
 Non-continuous supports may not exceed spacing of 5' (1.5 m) per TIA 569-D.9.7.  
 Cable capacity is calculated based on a 70% fill rate.

# DATACOM/LOW VOLTAGE

## Cable Support Systems

### NVENT CADDY CAT HP J-HOOK

- Provides optimal support for high-performance data cable, up to and including Cat 5e, Cat 6, Cat 6A, Cat 7 and fibre optic
- Rounded edges on J-Hooks provide proper bend radius support for high performance data cables
- Multiple color options aid in the identification and organization of the pathway application
- Provides superior fill capacity and load rating over most other non-continuous cable support alternatives
- Compliant with UL® 2043 and suitable for use in air handling (plenum) spaces
- Tested according to DIN 4102-12
- Complies with EN 50174-2
- Meets ISO®/IEC 14763-2, ANSI®/TIA 568 and ANSI®/TIA 569



Material: Steel

Part #	Finish	Cable Capacity			F ↓	
		Cat 5e	Cat 6	Cat 6A		
<b>Ø Diameter 1"</b>						
CAT16HP	Pregalvanized					
CAT16HPBA	Painted: Black					
CAT16HPBU	Painted: Blue					
CAT16HPGR	Painted: Green	20	15	10	60 lb	50 pc
CAT16HPOR	Painted: Orange					
CAT16HPRD	Painted: Red					
CAT16HPWH	Painted: White					
CAT16HPYL	Painted: Yellow					
<b>Ø Diameter 1 5/16"</b>						
CAT21HP	Pregalvanized					
CAT21HPBA	Painted: Black					
CAT21HPBU	Painted: Blue					
CAT21HPGR	Painted: Green	50	40	25	60 lb	50 pc
CAT21HPOR	Painted: Orange					
CAT21HPRD	Painted: Red					
CAT21HPWH	Painted: White					
CAT21HPYL	Painted: Yellow					

# DATACOM/LOW VOLTAGE

## Cable Support Systems

Part #	Finish	Cable Capacity			F ↓	☐
		Cat 5e	Cat 6	Cat 6A		
<b>Ø Diameter 2"</b>						
CAT32HP	Pregalvanized					
CAT32HPBA	Painted: Black					
CAT32HPBU	Painted: Blue					
CAT32HPGR	Painted: Green	90	60	35	60 lb	50 pc
CAT32HPOR	Painted: Orange					
CAT32HPRD	Painted: Red					
CAT32HPWH	Painted: White					
CAT32HPYL	Painted: Yellow					
<b>Ø Diameter 3"</b>						
CAT48HP	Pregalvanized					
CAT48HPBA	Painted: Black					
CAT48HPBU	Painted: Blue					
CAT48HPGR	Painted: Green	200	150	80	60 lb	25 pc
CAT48HPOR	Painted: Orange					
CAT48HPRD	Painted: Red					
CAT48HPWH	Painted: White					
CAT48HPYL	Painted: Yellow					
<b>Ø Diameter 4"</b>						
CAT64HP	Pregalvanized					
CAT64HPBA	Painted: Black					
CAT64HPBU	Painted: Blue					
CAT64HPGR	Painted: Green	330	220	140	60 lb	25 pc
CAT64HPOR	Painted: Orange					
CAT64HPRD	Painted: Red					
CAT64HPWH	Painted: White					
CAT64HPYL	Painted: Yellow					

Non-continuous supports may not exceed spacing of 5' (1.5 m) per TIA 569-D.9.7 and EN 50174-2. Cable capacity is calculated based on a 70% fill rate.

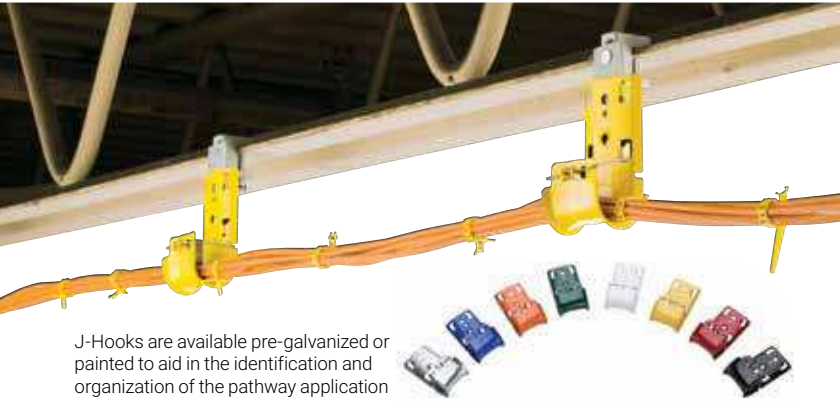

J-Hooks are available pre-galvanized or painted to aid in the identification and organization of the pathway application



# DATACOM/LOW VOLTAGE

## Cable Support Systems

### **NVENT CADDY CAT HP J-HOOK WITH BC200 BEAM CLAMP**

- Easy installation to beam flanges
- Provides optimal support for high-performance data cable, up to and including Cat 5e, Cat 6, Cat 6A, Cat 7 and fibre optic
- Provides superior fill capacity and load rating over most other non-continuous cable support alternatives
- Rounded edges on J-Hooks provide proper bend radius support for high performance data cables
- Cost effective alternative to expensive cable tray
- Complies with EN 50174-2
- Meets ISO®/IEC 14763-2, ANSI®/TIA 568 and ANSI®/TIA 569



Material: Steel  
 Finish: Pregalvanized, Electrogalvanized



Part #	Description	F ↓	☐
CAT16HPBC200	1" dia, 1/2" Max Flange	60 lb	50 pc
CAT21HPBC200	1 5/16" dia, 1/2" Max Flange	60 lb	50 pc
CAT32HPBC200	2" dia, 1/2" Max Flange	60 lb	50 pc
CAT48HPBC200	3" dia, 1/2" Max Flange	60 lb	25 pc
CAT64HPBC200	4" dia, 1/2" Max Flange	60 lb	25 pc

Setscrew must be tightened and torqued onto the sloped side of the I-beam. Non-continuous supports may not exceed spacing of 5' (1.5 m) per TIA 569-D.9.7 and EN 50174-2. Cable capacity is calculated based on a 70% fill rate.

# DATACOM/LOW VOLTAGE Cable Support Systems

## nVENT CADDY CAT HP J-HOOK WITH BC200 BEAM CLAMP, SWIVEL

- Easy installation to beam flanges
- Rotates 360 degrees to support various directional runs of cable
- Provides optimal support for high-performance data cable, up to and including Cat 5e, Cat 6, Cat 6A, Cat 7 and fibre optic
- Provides superior fill capacity and load rating over most other non-continuous cable support alternatives
- Rounded edges on J-Hooks provide proper bend radius support for high performance data cables
- Cost effective alternative to expensive cable tray
- Complies with EN 50174-2
- Meets ISO®/IEC 14763-2, ANSI®/TIA 568 and ANSI®/TIA 569



Material: Steel  
Finish: Pregalvanized, Electrogalvanized



Part #	Description	F ↓	↓ ↓
CAT16HPBC200B	1" dia, 1/2" Max Flange	60 lb	50 pc
CAT21HPBC200B	1 5/16" dia, 1/2" Max Flange	60 lb	50 pc
CAT32HPBC200B	2" dia, 1/2" Max Flange	60 lb	50 pc
CAT48HPBC200B	3" dia, 1/2" Max Flange	60 lb	25 pc
CAT64HPBC200B	4" dia, 1/2" Max Flange	60 lb	25 pc

Setscrew must be tightened and torqued onto the sloped side of the I-beam. Non-continuous supports may not exceed spacing of 5' (1.5 m) per TIA 569-D.9.7 and EN 50174-2. Cable capacity is calculated based on a 70% fill rate.

## DATACOM/LOW VOLTAGE

### Cable Support Systems

#### **nVent CADDY CAT HP DOUBLE J-HOOK WITH BC200 BEAM CLAMP, SWIVEL**

- Low-profile configuration providing double J-Hook capacity
- Easy installation to beam flanges
- Rotates 360 degrees to support various directional runs of cable
- Provides optimal support for high-performance data cable, up to and including Cat 5e, Cat 6, Cat 6A, Cat 7 and fibre optic
- Provides superior fill capacity and load rating over most other non-continuous cable support alternatives
- Rounded edges on J-Hooks provide proper bend radius support for high performance data cables
- Cost effective alternative to expensive cable tray
- Complies with EN 50174-2
- Meets ISO®/IEC 14763-2, ANSI®/TIA 568 and ANSI®/TIA 569



Material: Steel  
Finish: Pregalvanized, Electrogalvanized

Part #	Description	F ↓	↓ Cube
CAT21HPD1BC2	1 5/16" dia, 5 1/8"	100 lb	10 pc
CAT32HPD1BC2	2" dia, 6 1/2"	100 lb	10 pc
CAT48HPD1BC2	3" dia, 8 1/2"	100 lb	10 pc
CAT64HPD1BC2	4" dia, 10 1/2"	100 lb	10 pc

Static load limit of each J-Hook is 60 lb (270 N). Setscrew must be tightened and torqued onto the sloped side of the I-beam. Non-continuous supports may not exceed spacing of 5' (1.5 m) per TIA 569-D.9.7 and EN 50174-2.

# DATACOM/LOW VOLTAGE Cable Support Systems



## nVENT CADDY CAT HP J-HOOK WITH BC BEAM CLAMP

- Easy installation to beam flanges
- Provides optimal support for high-performance data cable, up to and including Cat 5e, Cat 6, Cat 6A, Cat 7 and fibre optic
- Provides superior fill capacity and load rating over most other non-continuous cable support alternatives
- Rounded edges on J-Hooks provide proper bend radius support for high performance data cables
- Cost effective alternative to expensive cable tray
- Complies with EN 50174-2
- Meets ISO®/IEC 14763-2, ANSI®/TIA 568 and ANSI®/TIA 569



Material: Steel, Spring Steel  
Finish: Pregalvanized, nVent CADDY Armour



Part #	Description		
CAT16HPBC	1" dia, 1/2" Max Flange	60 lb	50 pc
CAT21HPBC	1 5/16" dia, 1/2" Max Flange	60 lb	50 pc
CAT32HPBC	2" dia, 1/2" Max Flange	60 lb	50 pc
CAT48HPBC	3" dia, 1/2" Max Flange	60 lb	25 pc
CAT64HPBC	4" dia, 1/2" Max Flange	60 lb	25 pc

Non-continuous supports may not exceed spacing of 5' (1.5 m) per TIA 569-D.9.7 and EN 50174-2. Cable capacity is calculated based on a 70% fill rate.

# DATACOM/LOW VOLTAGE

## Cable Support Systems

### nVENT CADDY CAT HP J-HOOK WITH BC BEAM CLAMP, SWIVEL

- Easy installation to beam flanges
- Rotates 360 degrees to support various directional runs of cable
- Provides optimal support for high-performance data cable, up to and including Cat 5e, Cat 6, Cat 6A, Cat 7 and fibre optic
- Provides superior fill capacity and load rating over most other non-continuous cable support alternatives
- Rounded edges on J-Hooks provide proper bend radius support for high performance data cables
- Cost effective alternative to expensive cable tray
- Complies with EN 50174-2
- Meets ISO®/IEC 14763-2, ANSI®/TIA 568 and ANSI®/TIA 569



Material: Steel, Spring Steel  
 Finish: Pregalvanized, nVent CADDY Armour



Part #	Description	F	
CAT16HPBCB	1" dia, 1/2" Max Flange	60 lb	50 pc
CAT21HPBCB	1 5/16" dia, 1/2" Max Flange	60 lb	50 pc
CAT32HPBCB	2" dia, 1/2" Max Flange	60 lb	50 pc
CAT48HPBCB	3" dia, 1/2" Max Flange	60 lb	25 pc
CAT64HPBCB	4" dia, 1/2" Max Flange	60 lb	25 pc

Non-continuous supports may not exceed spacing of 5' (1.5 m) per TIA 569-D.9.7 and EN 50174-2. Cable capacity is calculated based on a 70% fill rate.

# DATACOM/LOW VOLTAGE Cable Support Systems

## nVENT CADDY CAT HP J-HOOK WITH HAMMER-ON FLANGE CLIP

- Requires only a hammer to install
- Provides optimal support for high-performance data cable, up to and including Cat 5e, Cat 6, Cat 6A, Cat 7 and fibre optic
- Provides superior fill capacity and load rating over most other non-continuous cable support alternatives
- Rounded edges on J-Hooks provide proper bend radius support for high performance data cables
- Cost effective alternative to expensive cable tray
- Complies with EN 50174-2
- Meets ISO®/IEC 14763-2, ANSI®/TIA 568 and ANSI®/TIA 569



Material: Steel, Spring Steel  
Finish: Pregalvanized, nVent CADDY Armour



Part #	Description	F ↓	↓ ↓
CAT16HP24SM	1" dia, 1/8"-1/4" Flange	60 lb	50 pc
CAT16HP58SM	1" dia, 5/16"-1/2" Flange	60 lb	50 pc
CAT16HP912SM	1" dia, 1/2"-3/4" Flange	60 lb	50 pc
CAT21HP24SM	1 5/16" dia, 1/8"-1/4" Flange	60 lb	50 pc
CAT21HP58SM	1 5/16" dia, 5/16"-1/2" Flange	60 lb	50 pc
CAT21HP912SM	1 5/16" dia, 1/2"-3/4" Flange	60 lb	50 pc
CAT32HP24SM	2" dia, 1/8"-1/4" Flange	60 lb	50 pc
CAT32HP58SM	2" dia, 5/16"-1/2" Flange	60 lb	50 pc
CAT32HP912SM	2" dia, 1/2"-3/4" Flange	60 lb	50 pc
CAT48HP24SM	3" dia, 1/8"-1/4" Flange	60 lb	25 pc
CAT48HP58SM	3" dia, 5/16"-1/2" Flange	60 lb	25 pc
CAT48HP912SM	3" dia, 1/2"-3/4" Flange	60 lb	25 pc
CAT64HP24SM	4" dia, 1/8"-1/4" Flange	60 lb	25 pc
CAT64HP58SM	4" dia, 5/16"-1/2" Flange	60 lb	25 pc
CAT64HP912SM	4" dia, 1/2"-3/4" Flange	60 lb	25 pc

Non-continuous supports may not exceed spacing of 5' (1.5 m) per TIA 569-D.9.7 and EN 50174-2. Cable capacity is calculated based on a 70% fill rate.

## DATACOM/LOW VOLTAGE

### Cable Support Systems

#### **nVENT CADDY CAT HP J-HOOK WITH HAMMER-ON FLANGE CLIP, SWIVEL**

- Requires only a hammer to install
- Rotates 360 degrees to support various directional runs of cable
- Provides optimal support for high-performance data cable, up to and including Cat 5e, Cat 6, Cat 6A, Cat 7 and fibre optic
- Provides superior fill capacity and load rating over most other non-continuous cable support alternatives
- Rounded edges on J-Hooks provide proper bend radius support for high performance data cables
- Cost effective alternative to expensive cable tray
- Complies with EN 50174-2
- Meets ISO®/IEC 14763-2, ANSI®/TIA 568 and ANSI®/TIA 569



Material: Steel, Spring Steel  
Finish: Pregalvanized, nVent CADDY Armour



Part #	Description	F ↓	☐
CAT16HP24	1" dia, 1/8"-1/4" Flange	60 lb	50 pc
CAT16HP58	1" dia, 5/16"-1/2" Flange	60 lb	50 pc
CAT16HP912	1" dia, 1/2"-3/4" Flange	60 lb	50 pc
CAT21HP24	1 5/16" dia, 1/8"-1/4" Flange	60 lb	50 pc
CAT21HP58	1 5/16" dia, 5/16"-1/2" Flange	60 lb	50 pc
CAT21HP912	1 5/16" dia, 1/2"-3/4" Flange	60 lb	50 pc
CAT32HP24	2" dia, 1/8"-1/4" Flange	60 lb	50 pc
CAT32HP58	2" dia, 5/16"-1/2" Flange	60 lb	50 pc
CAT32HP912	2" dia, 1/2"-3/4" Flange	60 lb	50 pc
CAT48HP24	3" dia, 1/8"-1/4" Flange	60 lb	25 pc
CAT48HP58	3" dia, 5/16"-1/2" Flange	60 lb	25 pc
CAT48HP912	3" dia, 1/2"-3/4" Flange	60 lb	25 pc
CAT64HP24	4" dia, 1/8"-1/4" Flange	60 lb	25 pc
CAT64HP58	4" dia, 5/16"-1/2" Flange	60 lb	25 pc
CAT64HP912	4" dia, 1/2"-3/4" Flange	60 lb	25 pc

Non-continuous supports may not exceed spacing of 5' (1.5 m) per TIA 569-D.9.7 and EN 50174-2. Cable capacity is calculated based on a 70% fill rate.

# DATACOM/LOW VOLTAGE Cable Support Systems

## **nVENT CADDY CAT HP J-HOOK WITH C PURLIN CLIP**

- Hammer-on or install from the floor with the VAFT tool
- Provides optimal support for high-performance data cable, up to and including Cat 5e, Cat 6, Cat 6A, Cat 7 and fibre optic
- Provides superior fill capacity and load rating over most other non-continuous cable support alternatives
- Rounded edges on J-Hooks provide proper bend radius support for high performance data cables
- Cost effective alternative to expensive cable tray
- Complies with EN 50174-2
- Meets ISO®/IEC 14763-2, ANSI®/TIA 568 and ANSI®/TIA 569



Material: Steel, Spring Steel  
Finish: Pregalvanized, nVent CADDY Armour



Part #	Description	F ↓	⊞
CAT16HPVF14	1" dia, 1/16"-1/4" Flange	60 lb	50 pc
CAT21HPVF14	1 5/16" dia, 1/16"-1/4" Flange	60 lb	50 pc
CAT32HPVF14	2" dia, 1/16"-1/4" Flange	60 lb	50 pc
CAT48HPVF14	3" dia, 1/16"-1/4" Flange	60 lb	25 pc
CAT64HPVF14	4" dia, 1/16"-1/4" Flange	60 lb	25 pc

Non-continuous supports may not exceed spacing of 5' (1.5 m) per TIA 569-D.9.7 and EN 50174-2. Cable capacity is calculated based on a 70% fill rate.



# DATACOM/LOW VOLTAGE

## Cable Support Systems

### **nVENT CADDY CAT HP J-HOOK WITH Z PURLIN CLIP**

- Hammer-on or install from the floor with the VAFT tool
- Provides optimal support for high-performance data cable, up to and including Cat 5e, Cat 6, Cat 6A, Cat 7 and fibre optic
- Provides superior fill capacity and load rating over most other non-continuous cable support alternatives
- Rounded edges on J-Hooks provide proper bend radius support for high performance data cables
- Cost effective alternative to expensive cable tray
- Complies with EN 50174-2
- Meets ISO®/IEC 14763-2, ANSI®/TIA 568 and ANSI®/TIA 569



Material: Steel, Spring Steel  
 Finish: Pregalvanized, nVent CADDY Armour



Part #	Description		
CAT16HPAF14	1" dia, 1/16"-1/4" Flange	60 lb	50 pc
CAT21HPAF14	1 5/16" dia, 1/16"-1/4" Flange	60 lb	50 pc
CAT32HPAF14	2" dia, 1/16"-1/4" Flange	60 lb	50 pc

Non-continuous supports may not exceed spacing of 5' (1.5 m) per TIA 569-D.9.7 and EN 50174-2. Cable capacity is calculated based on a 70% fill rate.

# DATAKOM/LOW VOLTAGE

## Cable Support Systems

### **nVENT CADDY CAT HP J-HOOK WITH Z PURLIN CLIP, SWIVEL**

- Requires only a hammer to install
- Rotates 360 degrees to support various directional runs of cable
- Provides optimal support for high-performance data cable, up to and including Cat 5e, Cat 6, Cat 6A, Cat 7 and fibre optic
- Provides superior fill capacity and load rating over most other non-continuous cable support alternatives
- Rounded edges on J-Hooks provide proper bend radius support for high performance data cables
- Cost effective alternative to expensive cable tray
- Complies with EN 50174-2
- Meets ISO®/IEC 14763-2, ANSI®/TIA 568 and ANSI®/TIA 569



Material: Steel, Spring Steel  
 Finish: Pregalvanized, nVent CADDY Armour



Part #	Description	F ↓	📦
CAT16HP123	1" dia, 0.06"–0.1" Flange	60 lb	50 pc
CAT21HP123	1 5/16" dia, 0.06"–0.1" Flange	60 lb	50 pc
CAT32HP123	2" dia, 0.06"–0.1" Flange	60 lb	50 pc
CAT48HP123	3" dia, 0.06"–0.1" Flange	60 lb	25 pc
CAT64HP123	4" dia, 0.06"–0.1" Flange	60 lb	25 pc

Non-continuous supports may not exceed spacing of 5' (1.5 m) per TIA 569-D.9.7 and EN 50174-2. Cable capacity is calculated based on a 70% fill rate.

## DATACOM/LOW VOLTAGE

### Cable Support Systems

#### **nVENT CADDY CAT HP J-HOOK WITH MULTI-FUNCTION CLIP**

- Quick attachment to threaded rod or wire
- Fully adjustable and easy to relocate to accommodate changes once installed
- Provides optimal support for high-performance data cable, up to and including Cat 5e, Cat 6, Cat 6A, Cat 7 and fibre optic
- Provides superior fill capacity and load rating over most other non-continuous cable support alternatives
- Rounded edges on J-Hooks provide proper bend radius support for high performance data cables
- Cost effective alternative to expensive cable tray
- Complies with EN 50174-2
- Meets ISO®/IEC 14763-2, ANSI®/TIA 568 and ANSI®/TIA 569



Material: Steel, Spring Steel

Part #	Description	F ↓	↓
Finish: Pregalvanized, nVent CADDY Armour			
CAT16HP4Z34	1" dia, 1/4" Rod, #12-#8 Wire	30 lb	50 pc
CAT16HP6Z34	1" dia, 3/8" Rod	30 lb	50 pc
CAT16HP8Z34	1" dia, 1/2", 5/8" Rod	50 lb	50 pc
CAT21HP4Z34	1 5/16" dia, 1/4" Rod, #12-#8 Wire	30 lb	50 pc
CAT21HP6Z34	1 5/16" dia, 3/8" Rod	30 lb	50 pc
CAT21HP8Z34	1 5/16" dia, 1/2", 5/8" Rod	50 lb	50 pc
CAT32HP4Z34	2" dia, 1/4" Rod, #12-#8 Wire	30 lb	50 pc
CAT32HP6Z34	2" dia, 3/8" Rod	30 lb	50 pc
CAT32HP8Z34	2" dia, 1/2", 5/8" Rod	50 lb	25 pc
CAT48HP4Z34	3" dia, 1/4" Rod, #12-#8 Wire	30 lb	25 pc
CAT48HP6Z34	3" dia, 3/8" Rod	30 lb	25 pc
CAT48HP8Z34	3" dia, 1/2", 5/8" Rod	50 lb	25 pc
CAT64HP4Z34	4" dia, 1/4" Rod, #12-#8 Wire	30 lb	25 pc
CAT64HP6Z34	4" dia, 3/8" Rod	30 lb	25 pc
CAT64HP8Z34	4" dia, 1/2", 5/8" Rod	50 lb	50 pc
Finish: Pregalvanized, Painted, nVent CADDY Armour — Color: Black			
CAT32HPBA4Z34	2" dia, 1/4" Rod, #12-#8 Wire	30 lb	50 pc
Finish: Pregalvanized, Painted, nVent CADDY Armour — Color: White			
CAT32HPWH4Z34	2" dia, 1/4" Rod, #12-#8 Wire	30 lb	50 pc

1/2" and 5/8" rod sizes are to be installed on threaded rod only. Non-continuous supports may not exceed spacing of 5' (1.5 m) per TIA 569-D.9.7 and EN 50174-2. Cable capacity is calculated based on a 70% fill rate.

# DATACOM/LOW VOLTAGE Cable Support Systems

## **NVENT CADDY CAT HP J-HOOK WITH SHOT-FIRE BRACKET**

- Provides optimal support for high-performance data cable, up to and including Cat 5e, Cat 6, Cat 6A, Cat 7 and fibre optic
- Complete with shot-fire bracket and pre-assembled drive pin
- Quickly and easily attaches to concrete, steel or composite metal decking
- Integrated pin installs easily using powder-actuated or single-shot gas-actuated tools
- Rounded edges on J-Hooks provide proper bend radius support for high performance data cables
- Provides superior fill capacity and load rating over most other non-continuous cable support alternatives
- Complies with EN 50174-2
- Meets ISO®/IEC 14763-2, ANSI®/TIA 568 and ANSI®/TIA 569
- ICC-ES ESR-2024 evaluation report available for drive pin



Material: Steel  
Finish: Electrogalvanized, Pregalvanized

Part #	Description	F ↓	☐
CAT16HPSF	1" dia	60 lb	50 pc
CAT21HPSF	1 5/16" dia	60 lb	50 pc
CAT32HPSF	2" dia	60 lb	50 pc
CAT48HPSF	3" dia	60 lb	25 pc
CAT64HPSF	4" dia	60 lb	25 pc

# DATACOM/LOW VOLTAGE

## Cable Support Systems

### **nVENT CADDY CAT HP J-HOOK WITH NAIL GUN BRACKET**

- Provides optimal support for high-performance data cable, up to and including Cat 5e, Cat 6, Cat 6A, Cat 7 and fibre optic
- Complete with concrete nail gun insert bracket
- Clips onto nozzle of gas or battery-actuated nail guns allowing for hands-off installation at structure or from the floor using a pole
- Longer leg angle bracket for tool clearance
- Quickly and easily attaches to concrete, steel or composite metal decking
- Rounded edges on J-Hooks provide proper bend radius support for high performance data cables
- Provides superior fill capacity and load rating over most other non-continuous cable support alternatives
- Complies with EN 50174-2
- Meets ISO®/IEC 14763-2, ANSI®/TIA 568 and ANSI®/TIA 569



Material: Steel, Nylon  
 Finish: Electrogalvanized, Pregalvanized

Part #	Description	F ↓	↓ Cube
CAT16HPGBSF	1" dia	60 lb	50 pc
CAT32HPGBSF	2" dia	60 lb	50 pc

# DATAKOM/LOW VOLTAGE Cable Support Systems

## nVENT CADDY CAT HP J-HOOK WITH ANGLE BRACKET

- Ideal for attaching to concrete, steel or wood surfaces
- Provides optimal support for high-performance data cable, up to and including Cat 5e, Cat 6, Cat 6A, Cat 7 and fibre optic
- Provides superior fill capacity and load rating over most other non-continuous cable support alternatives
- Rounded edges on J-Hooks provide proper bend radius support for high performance data cables
- Cost effective alternative to expensive cable tray
- Complies with EN 50174-2
- Meets ISO®/IEC 14763-2, ANSI®/TIA 568 and ANSI®/TIA 569



Material: Steel  
Finish: Pregalvanized



Part #	Description	F ↓	📦
CAT16HPAB	1" dia, 1/4" Hole	60 lb	50 pc
CAT21HPAB	1 5/16" dia, 1/4" Hole	60 lb	50 pc
CAT32HPAB	2" dia, 1/4" Hole	60 lb	50 pc
CAT48HPAB	3" dia, 1/4" Hole	60 lb	25 pc
CAT64HPAB	4" dia, 1/4" Hole	60 lb	25 pc

Non-continuous supports may not exceed spacing of 5' (1.5 m) per TIA 569-D.9.7 and EN 50174-2. Cable capacity is calculated based on a 70% fill rate.

## DATACOM/LOW VOLTAGE

### Cable Support Systems

#### **nVENT CADDY CAT HP J-HOOK WITH PIN DRIVEN ANGLE BRACKET**

- Longer leg angle bracket for tool clearance
- Designed to fit a variety of pin drivers
- Provides optimal support for high-performance data cable, up to and including Cat 5e, Cat 6, Cat 6A, Cat 7 and fibre optic
- Provides superior fill capacity and load rating over most other non-continuous cable support alternatives
- Rounded edges on J-Hooks provide proper bend radius support for high performance data cables
- Cost effective alternative to expensive cable tray
- Complies with EN 50174-2
- Meets ISO®/IEC 14763-2, ANSI®/TIA 568 and ANSI®/TIA 569



Material: Steel  
Finish: Pregalvanized



Part #	Description	F ↓	↓
CAT16HPAFAB3	1" dia, 3/16" Hole	60 lb	50 pc
CAT21HPAFAB3	1 5/16" dia, 3/16" Hole	60 lb	50 pc
CAT21HPAFAB4	1 5/16" dia, 1/4" Hole	60 lb	50 pc
CAT21HPAFAB6	1 5/16" dia, 3/8" Hole	60 lb	50 pc
CAT32HPAFAB3	2" dia, 3/16" Hole	60 lb	50 pc
CAT32HPAFAB4	2" dia, 1/4" Hole	60 lb	50 pc
CAT32HPAFAB6	2" dia, 3/8" Hole	60 lb	50 pc
CAT48HPAFAB3	3" dia, 3/16" Hole	60 lb	25 pc
CAT48HPAFAB4	3" dia, 1/4" Hole	60 lb	25 pc
CAT48HPAFAB6	3" dia, 3/8" Hole	60 lb	25 pc
CAT64HPAFAB3	4" dia, 3/16" Hole	60 lb	25 pc
CAT64HPAFAB4	4" dia, 1/4" Hole	60 lb	25 pc
CAT64HPAFAB6	4" dia, 3/8" Hole	60 lb	25 pc

Non-continuous supports may not exceed spacing of 5' (1.5 m) per TIA 569-D.9.7 and EN 50174-2. Cable capacity is calculated based on a 70% fill rate.

# DATAKOM/LOW VOLTAGE Cable Support Systems

## NVENT CADDY CAT HP J-HOOK WITH PEDESTAL CLAMP

- Easy installation to pedestals used under raised floors
- Provides optimal support for high-performance data cable, up to and including Cat 5e, Cat 6, Cat 6A, Cat 7 and fibre optic
- Provides superior fill capacity and load rating over most other non-continuous cable support alternatives
- Cost effective alternative to expensive cable tray
- Complies with EN 50174-2
- Meets ISO®/IEC 14763-2, ANSI®/TIA 568 and ANSI®/TIA 569



Material: Steel  
Finish: Pregalvanized



Part #	Description	
CAT16HPCD1B	1" dia, 3/4" Square, 7/8"-1 1/8" Round Pedestal	50 pc
CAT21HPCD1B	1 5/16" dia, 3/4" Square, 7/8"-1 1/8" Round Pedestal	50 pc
CAT32HPCD1B	2" dia, 3/4" Square, 7/8"-1 1/8" Round Pedestal	50 pc
CAT48HPCD1B	3" dia, 3/4" Square, 7/8"-1 1/8" Round Pedestal	25 pc
CAT64HPCD1B	4" dia, 3/4" Square, 7/8"-1 1/8" Round Pedestal	25 pc

Non-continuous supports may not exceed spacing of 5' (1.5 m) per TIA 569-D.9.7 and EN 50174-2. Cable capacity is calculated based on a 70% fill rate.



# DATACOM/LOW VOLTAGE

## Cable Support Systems

### **nVENT CADDY CAT HP J-HOOK WITH STRUT ATTACHMENT CLIP**

- Attaches to open side of a strut channel
- Provides optimal support for high-performance data cable, up to and including Cat 5e, Cat 6, Cat 6A, Cat 7 and fibre optic
- Provides superior fill capacity and load rating over most other non-continuous cable support alternatives
- Cost effective alternative to expensive cable tray
- Complies with EN 50174-2
- Meets ISO®/IEC 14763-2, ANSI®/TIA 568 and ANSI®/TIA 569



Material: Steel, Spring Steel  
Finish: Pregalvanized, nVent CADDY Armour



Part #	Description		
CAT16HPESC	1" dia	60 lb	50 pc
CAT21HPESC	1 5/16" dia	60 lb	50 pc
CAT32HPESC	2" dia	60 lb	50 pc

Non-continuous supports may not exceed spacing of 5' (1.5 m) per TIA 569-D.9.7 and EN 50174-2. Cable capacity is calculated based on a 70% fill rate.

# DATACOM/LOW VOLTAGE Cable Support Systems

## **nVENT CADDY CAT HP J-HOOK WITH T-GRID CLIP**

- No installation tools required for basic clip
- Provides optimal support for high-performance data cable, up to and including Cat 5e, Cat 6, Cat 6A, Cat 7 and fibre optic
- Provides superior fill capacity and load rating over most other non-continuous cable support alternatives
- Rounded edges on J-Hooks provide proper bend radius support for high performance data cables
- Cost effective alternative to expensive cable tray
- Complies with EN 50174-2
- Meets ISO®/IEC 14763-2, ANSI®/TIA 568 and ANSI®/TIA 569



Material: Steel, Spring Steel  
Finish: nVent CADDY Armour, Pregalvanized



Part #	Description	F	
CAT16HPTS	1" dia	60 lb	50 pc

Additional support wire required per NEC® 300.11. Non-continuous supports may not exceed spacing of 5' (1.5 m) per TIA 569-D.9.7 and EN 50174-2. Cable capacity is calculated based on a 70% fill rate.

# DATACOM/LOW VOLTAGE

## Cable Support Systems

### **NVENT CADDY CAT HP J-HOOK TREE, CEILING MOUNT**

- Ideal for attaching to concrete, steel or wood surfaces
- Provides optimal support for high-performance data cable, up to and including Cat 5e, Cat 6, Cat 6A, Cat 7 and fibre optic
- Ready to use out of the box, saving installation time and labor
- Requires no screws, rivets or special tools for assembly
- Single- or double-sided tree configurations provide multiple J-Hooks with one structural attachment
- Provides superior fill capacity and load rating over most other non-continuous cable support alternatives
- Complies with EN 50174-2
- Meets ISO®/IEC 14763-2, ANSI®/TIA 568 and ANSI®/TIA 569

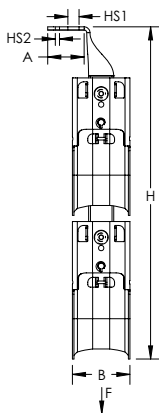

Material: Steel  
Finish: Pregalvanized

Part #	Description	Hole Size HS1	Hole Size HS2	Static Load F1	Static Load F2	
<b>Type: Double Sided</b>						
CAT32HPDCM2	2" dia, 2 Tier	0.405"	0.185"	240 lb	180 lb	5 pc
CAT32HPDCM3	2" dia, 3 Tier	0.405"	0.185"	360 lb	180 lb	5 pc
CAT32HPDCM4	2" dia, 4 Tier	0.405"	0.185"	480 lb	180 lb	5 pc
CAT64HPDCM2	4" dia, 2 Tier	0.405"	0.185"	240 lb	180 lb	5 pc
CAT64HPDCM3	4" dia, 3 Tier	0.405"	0.185"	360 lb	180 lb	5 pc
CAT64HPDCM4	4" dia, 4 Tier	0.405"	0.185"	240 lb	180 lb	5 pc
<b>Type: Single Sided</b>						
CAT32HPSCM2	2" dia, 2 Tier	0.405"	0.185"	120 lb	120 lb	5 pc
CAT32HPSCM3	2" dia, 3 Tier	0.405"	0.185"	180 lb	180 lb	5 pc
CAT32HPSCM4	2" dia, 4 Tier	0.405"	0.185"	240 lb	180 lb	5 pc
CAT64HPSCM2	4" dia, 2 Tier	0.405"	0.185"	120 lb	120 lb	5 pc
CAT64HPSCM3	4" dia, 3 Tier	0.405"	0.185"	180 lb	180 lb	5 pc
CAT64HPSCM4	4" dia, 4 Tier	0.405"	0.185"	240 lb	180 lb	5 pc

Static loads represent maximum load limit of J-Hook tree.

Static load limit of each J-Hook is 60 lb (270 N).

Refer to Static Load 1 when fastening J-Hook tree using Hole Size 1.

Refer to Static Load 2 when fastening J-Hook tree using Hole Size 2.

Non-continuous supports may not exceed spacing of 5' (1.5 m) per TIA 569-D.9.7 and EN 50174-2.

# DATACOM/LOW VOLTAGE



## Cable Support Systems

### **NVENT CADDY CAT HP J-HOOK TREE, FLANGE MOUNT**

- Easy installation to beam flanges
- Provides optimal support for high-performance data cable, up to and including Cat 5e, Cat 6, Cat 6A, Cat 7 and fibre optic
- Ready to use out of the box, saving installation time and labor
- Requires no screws, rivets or special tools for assembly
- Single- or double-sided tree configurations provide multiple J-Hooks with one structural attachment
- Provides superior fill capacity and load rating over most other non-continuous cable support alternatives
- Complies with EN 50174-2
- Meets ISO®/IEC 14763-2, ANSI®/TIA 568 and ANSI®/TIA 569



Material: Steel  
Finish: Pregalvanized

Part #	Description	Flange Thickness		
<b>Type: Double Sided</b>				
CAT32HPDFM2	2" dia, 2 Tier	13/16" Max	240 lb	5 pc
CAT32HPDFM3	2" dia, 3 Tier	13/16" Max	360 lb	5 pc
CAT32HPDFM4	2" dia, 4 Tier	13/16" Max	480 lb	5 pc
CAT64HPDFM2	4" dia, 2 Tier	13/16" Max	240 lb	5 pc
CAT64HPDFM3	4" dia, 3 Tier	13/16" Max	360 lb	5 pc
CAT64HPDFM4	4" dia, 4 Tier	13/16" Max	480 lb	5 pc
<b>Type: Single Sided</b>				
CAT32HPSFM2	2" dia, 2 Tier	13/16" Max	120 lb	5 pc
CAT32HPSFM3	2" dia, 3 Tier	13/16" Max	180 lb	5 pc
CAT32HPSFM4	2" dia, 4 Tier	13/16" Max	240 lb	5 pc
CAT64HPSFM2	4" dia, 2 Tier	13/16" Max	120 lb	5 pc
CAT64HPSFM3	4" dia, 3 Tier	13/16" Max	180 lb	5 pc
CAT64HPSFM4	4" dia, 4 Tier	13/16" Max	240 lb	5 pc

Static loads represent maximum load limit of J-Hook tree. Static load limit of each J-Hook is 60 lb (270 N). Setscrew must be tightened and torqued onto the sloped side of the I-beam. Non-continuous supports may not exceed spacing of 5' (1.5 m) per TIA 569-D.9.7 and EN 50174-2. Recognizing that torque wrenches are generally not used or available on many job sites, the setscrew should be tightened so it contacts the I-beam and then an additional 1/4 to 1/2 turn added.

## DATACOM/LOW VOLTAGE

### Cable Support Systems

#### **nVENT CADDY CAT HP J-HOOK TREE, WALL MOUNT**

- Ideal for attaching to concrete, steel or wood surfaces
- Provides optimal support for high-performance data cable, up to and including Cat 5e, Cat 6, Cat 6A, Cat 7 and fibre optic
- Ready to use out of the box, saving installation time and labor
- Requires no screws, rivets or special tools for assembly
- Provides superior fill capacity and load rating over most other non-continuous cable support alternatives
- Complies with EN 50174-2
- Meets ISO®/IEC 14763-2, ANSI®/TIA 568 and ANSI®/TIA 569



Material: Steel  
Finish: Pregalvanized  
Type: Single Sided

Part #	Description	F ↓	↓ ↓
CAT32HPSWM2	2" dia, 2 Tier	120 lb	5 pc
CAT32HPSWM3	2" dia, 3 Tier	180 lb	5 pc
CAT32HPSWM4	2" dia, 4 Tier	240 lb	5 pc
CAT64HPSWM2	4" dia, 2 Tier	120 lb	5 pc
CAT64HPSWM3	4" dia, 3 Tier	180 lb	5 pc
CAT64HPSWM4	4" dia, 4 Tier	240 lb	5 pc

Static loads represent maximum load limit of J-Hook tree. Static load limit of each J-Hook is 60 lb (270 N). Non-continuous supports may not exceed spacing of 5' (1.5 m) per TIA 569-D.9.7 and EN 50174-2.

**DATACOM/LOW VOLTAGE**  
**Cable Support Systems**

**NVENT CADDY CAT HP J-HOOK CLIP TO BC200 BEAM CLAMP**

- Easy installation to beam flanges
- Requires no screws, rivets or special tools for assembly
- J-Hooks feature bendable locking tabs that lock on to nVent CADDY Cat HP components to provide rigidity and stability
- Link to J-Hooks in one of multiple color options to aid in pathway identification and organization
- Customized J-Hook trees can be easily assembled with various J-Hook sizes, colors and configurations
- nVent CADDY Cat HP components easily attach to any size nVent CADDY Cat HP J-Hook



Material: Steel, Spring Steel  
 Finish: Electrogalvanized, nVent CADDY Armour



Part #	Description	F ↓	↓
CATHPBC200	1/8"–5/8" Flange	100 lb	25 pc

**NVENT CADDY CAT HP J-HOOK CLIP TO BC200 BEAM CLAMP, SWIVEL**

- Easy installation to beam flanges
- Rotates 360 degrees to support various directional runs of cable
- Requires no screws, rivets or special tools for assembly
- J-Hooks feature bendable locking tabs that lock on to nVent CADDY Cat HP components to provide rigidity and stability
- Link to J-Hooks in one of multiple color options to aid in pathway identification and organization
- Customized J-Hook trees can be easily assembled with various J-Hook sizes, colors and configurations
- nVent CADDY Cat HP components easily attach to any size nVent CADDY Cat HP J-Hook



Material: Steel, Spring Steel  
 Finish: Electrogalvanized, nVent CADDY Armour



Part #	Description	F ↓	↓
CATHPBC200B	1/8"–5/8" Flange	100 lb	25 pc

## DATACOM/LOW VOLTAGE

### Cable Support Systems

#### **NVENT CADDY CAT HP J-HOOK CLIP TO BC BEAM CLAMP**

- Easy installation to beam flanges
- Requires no screws, rivets or special tools for assembly
- J-Hooks feature bendable locking tabs that lock on to nVent CADDY Cat HP components to provide rigidity and stability
- Link to J-Hooks in one of multiple color options to aid in pathway identification and organization
- Customized J-Hook trees can be easily assembled with various J-Hook sizes, colors and configurations
- nVent CADDY Cat HP components easily attach to any size nVent CADDY Cat HP J-Hook



Material: Steel, Spring Steel  
Finish: Electrogalvanized, nVent CADDY Armour



Part #	Description	F ↓	
CATHPBC	1/8"–1/2" Flange	100 lb	50 pc

#### **NVENT CADDY CAT HP J-HOOK CLIP TO BC BEAM CLAMP, SWIVEL**

- Easy installation to beam flanges
- Rotates 360 degrees to support various directional runs of cable
- Requires no screws, rivets or special tools for assembly
- J-Hooks feature bendable locking tabs that lock on to nVent CADDY Cat HP components to provide rigidity and stability
- Link to J-Hooks in one of multiple color options to aid in pathway identification and organization
- Customized J-Hook trees can be easily assembled with various J-Hook sizes, colors and configurations
- nVent CADDY Cat HP components easily attach to any size nVent CADDY Cat HP J-Hook



Material: Steel, Spring Steel  
Finish: Electrogalvanized, nVent CADDY Armour



Part #	Description	F ↓	
CATHPBCB	1/8"–1/2" Flange	60 lb	25 pc

**DATACOM/LOW VOLTAGE**  
**Cable Support Systems**

**nVENT CADDY CAT HP J-HOOK CLIP TO HAMMER-ON FLANGE CLIP**

- Requires only a hammer to install
- Requires no screws, rivets or special tools for assembly
- J-Hooks feature bendable locking tabs that lock on to nVent CADDY Cat HP components to provide rigidity and stability
- Link to J-Hooks in one of multiple color options to aid in pathway identification and organization
- Customized J-Hook trees can be easily assembled with various J-Hook sizes, colors and configurations
- nVent CADDY Cat HP components easily attach to any size nVent CADDY Cat HP J-Hook



Material: Spring Steel  
 Finish: nVent CADDY Armour



Part #	Description	F ↓	↓ Cube
CATHP24SM	1/8"–1/4" Flange	200 lb	50 pc
CATHP58SM	5/16"–1/2" Flange	200 lb	50 pc
CATHP912SM	1/2"–3/4" Flange	200 lb	25 pc



# DATACOM/LOW VOLTAGE

## Cable Support Systems

### NVENT CADDY CAT HP J-HOOK CLIP TO HAMMER-ON FLANGE CLIP, SWIVEL

- Requires only a hammer to install
- Rotates 360 degrees to support various directional runs of cable
- Requires no screws, rivets or special tools for assembly
- J-Hooks feature bendable locking tabs that lock on to nVent CADDY Cat HP components to provide rigidity and stability
- Link to J-Hooks in one of multiple color options to aid in pathway identification and organization
- Customized J-Hook trees can be easily assembled with various J-Hook sizes, colors and configurations
- nVent CADDY Cat HP components easily attach to any size nVent CADDY Cat HP J-Hook



Material: Spring Steel  
 Finish: nVent CADDY Armour



Part #	Description	F ↓	📦
CATHP24	1/8"–1/4" Flange	75 lb	25 pc
CATHP58	5/16"–1/2" Flange	75 lb	25 pc
CATHP912	1/2"–3/4" Flange	75 lb	25 pc

# DATACOM/LOW VOLTAGE

## Cable Support Systems

### NVENT CADDY CAT HP J-HOOK CLIP TO C PURLIN CLIP

- Hammer-on or install from the floor with the VAFT tool
- Requires no screws, rivets or special tools for assembly
- J-Hooks feature bendable locking tabs that lock on to nVent CADDY Cat HP components to provide rigidity and stability
- Link to J-Hooks in one of multiple color options to aid in pathway identification and organization
- Customized J-Hook trees can be easily assembled with various J-Hook sizes, colors and configurations
- nVent CADDY Cat HP components easily attach to any size nVent CADDY Cat HP J-Hook



Material: Spring Steel  
Finish: nVent CADDY Armour



Part #	Description	F ↓	📦
CATHPVF14	1/16"–1/4" Flange	160 lb	50 pc

### NVENT CADDY CAT HP J-HOOK CLIP TO Z PURLIN CLIP

- Requires only a hammer to install
- Requires no screws, rivets or special tools for assembly
- J-Hooks feature bendable locking tabs that lock on to nVent CADDY Cat HP components to provide rigidity and stability
- Link to J-Hooks in one of multiple color options to aid in pathway identification and organization
- Customized J-Hook trees can be easily assembled with various J-Hook sizes, colors and configurations
- nVent CADDY Cat HP components easily attach to any size nVent CADDY Cat HP J-Hook



Material: Spring Steel  
Finish: nVent CADDY Armour



Part #	Description	F ↓	📦
CATHPAF14	1/16"–1/4" Flange	100 lb	50 pc

## DATACOM/LOW VOLTAGE

### Cable Support Systems

#### **NVENT CADDY CAT HP J-HOOK CLIP TO Z PURLIN CLIP, SWIVEL**

- Requires only a hammer to install
- Rotates 360 degrees to support various directional runs of cable
- Requires no screws, rivets or special tools for assembly
- J-Hooks feature bendable locking tabs that lock on to nVent CADDY Cat HP components to provide rigidity and stability
- Link to J-Hooks in one of multiple color options to aid in pathway identification and organization
- Customized J-Hook trees can be easily assembled with various J-Hook sizes, colors and configurations
- nVent CADDY Cat HP components easily attach to any size nVent CADDY Cat HP J-Hook



Material: Steel, Spring Steel  
Finish: Pregalvanized, nVent CADDY Armour



Part #	Description	F ↓	📦
CATHP123	0.06"–0.1" Flange	100 lb	50 pc

#### **NVENT CADDY CAT HP J-HOOK CLIP TO ROD/WIRE CLIP**

- Quick attachment to threaded rod or wire
- Requires no screws, rivets or special tools for assembly
- J-Hooks feature bendable locking tabs that lock on to nVent CADDY Cat HP components to provide rigidity and stability
- Link to J-Hooks in one of multiple color options to aid in pathway identification and organization
- Customized J-Hook trees can be easily assembled with various J-Hook sizes, colors and configurations
- nVent CADDY Cat HP components easily attach to any size nVent CADDY Cat HP J-Hook



Material: Spring Steel  
Finish: nVent CADDY Armour



Part #	Description	F ↓	📦
CATHP4Z34	1/4" Rod, #12–#8 Wire	30 lb	50 pc
CATHP6Z34	3/8" Rod	30 lb	50 pc
CATHP8Z34	1/2", 5/8" Rod	50 lb	100 pc

1/2" and 5/8" rod sizes are to be installed on threaded rod only. Recommended for use with nVent CADDY Cat HP J-Hooks with a diameter of 2" (50 mm) or less.

# DATACOM/LOW VOLTAGE

## Cable Support Systems



### **nVENT CADDY CAT HP J-HOOK CLIP TO STRUT CLIP**

- Easily attaches to the side of strut
- Requires no screws, rivets or special tools for assembly
- J-Hooks feature bendable locking tabs that lock on to nVent CADDY Cat HP components to provide rigidity and stability
- Link to J-Hooks in one of multiple color options to aid in pathway identification and organization
- Customized J-Hook trees can be easily assembled with various J-Hook sizes, colors and configurations
- nVent CADDY Cat HP components easily attach to any size nVent CADDY Cat HP J-Hook



Material: Steel, Spring Steel  
Finish: nVent CADDY Armour



Part #	Description		
CATHPESC	nVent CADDY Cat HP J-Hook Clip to Strut Clip	100 lb	50 pc

# DATACOM/LOW VOLTAGE

## Cable Support Systems

### **NVENT CADDY CAT HP J-HOOK CLIP TO PEDESTAL CLAMP**

- Easy installation to pedestals used under raised floors
- Requires no screws, rivets or special tools for assembly
- J-Hooks feature bendable locking tabs that lock on to nVent CADDY Cat HP components to provide rigidity and stability
- Link to J-Hooks in one of multiple color options to aid in pathway identification and organization
- Customized J-Hook trees can be easily assembled with various J-Hook sizes, colors and configurations
- nVent CADDY Cat HP components easily attach to any size nVent CADDY Cat HP J-Hook



Material: Steel, Spring Steel  
 Finish: ElectroGalvanized, nVent CADDY Armour



Part #	Description	F ↓	☐
CATHPCD0B	3/4" Round Pedestal	15 lb	25 pc
CATHPCD1B	3/4" Square, 7/8"-1 1/8" Round Pedestal	15 lb	25 pc
CATHPCD2B	7/8" Square Pedestal	15 lb	25 pc
CATHPCD2.5B	1" Square Pedestal	15 lb	25 pc
CATHPCD3B	1 1/2" Round Pedestal	15 lb	25 pc

# DATACOM/LOW VOLTAGE

## Cable Support Systems

### **nVENT CADDY CAT HP J-HOOK BRACKET WITH SHOT-FIRE BRACKET**

- Link to J-Hooks in one of multiple color options to aid in pathway identification and organization
- Complete with shot-fire bracket and pre-assembled drive pin
- Quickly and easily attaches to concrete, steel or composite metal decking
- Integrated pin installs easily using powder-actuated or single-shot gas-actuated tools
- J-Hooks feature bendable locking tabs that lock on to nVent CADDY Cat HP components to provide rigidity and stability
- Customized J-Hook trees can be easily assembled with various J-Hook sizes, colors and configurations
- nVent CADDY Cat HP components easily attach to any size nVent CADDY Cat HP J-Hook
- ICC-ES ESR-2024 evaluation report available for drive pin



Material: Steel, Spring Steel  
Finish: Electrogalvanized, nVent CADDY Armour

Part #	Description	F	
CATHPBSF	nVent CADDY Cat HP J-Hook Bracket with Shot-Fire Bracket	100 lb	50 pc

For shot-fired supports in seismic design category D, E, or F, maximum load is the lesser of 90 lb (400 N) or the published load.

## DATACOM/LOW VOLTAGE

### Cable Support Systems

#### **nVent CADDY CAT HP J-HOOK ANGLE BRACKET**

- Ideal for attaching to threaded rod, concrete, steel or wood surfaces
- Requires no screws, rivets or special tools for assembly
- J-Hooks feature bendable locking tabs that lock on to nVent CADDY Cat HP components to provide rigidity and stability
- Link to J-Hooks in one of multiple color options to aid in pathway identification and organization
- Customized J-Hook trees can be easily assembled with various J-Hook sizes, colors and configurations
- nVent CADDY Cat HP components easily attach to any size nVent CADDY Cat HP J-Hook



Material: Spring Steel  
Finish: nVent CADDY Armour



Part #	Description	F ↓	↓ Cube
CATHPAN	3/16" Hole	160 lb	50 pc
CATHPA4	1/4" Hole	150 lb	50 pc
CATHPA6	3/8" Hole	200 lb	50 pc

# DATACOM/LOW VOLTAGE

## Cable Support Systems

### NVENT CADDY CAT HP J-HOOK STRAIGHT BRACKET

- Can be attached to various nVent CADDY fasteners or screwed directly to a wall
- Ideal for attaching to concrete, steel or wood surfaces
- Requires no screws, rivets or special tools for assembly
- J-Hooks feature bendable locking tabs that lock on to nVent CADDY Cat HP components to provide rigidity and stability
- Link to J-Hooks in one of multiple color options to aid in pathway identification and organization
- Customized J-Hook trees can be easily assembled with various J-Hook sizes, colors and configurations
- nVent CADDY Cat HP components easily attach to any size nVent CADDY Cat HP J-Hook



Material: Spring Steel  
Finish: nVent CADDY Armour



Part #	Description	F ↓	📦
CATHPS4	1/4" Hole	200 lb	50 pc

### NVENT CADDY CAT HP J-HOOK TREE MOUNT BRACKET

- Requires no screws, rivets or special tools for assembly
- J-Hooks feature bendable locking tabs that lock on to nVent CADDY Cat HP components to provide rigidity and stability
- Link to J-Hooks in one of multiple color options to aid in pathway identification and organization
- Customized J-Hook trees can be easily assembled with various J-Hook sizes, colors and configurations
- nVent CADDY Cat HP components easily attach to any size nVent CADDY Cat HP J-Hook



Material: Spring Steel  
Finish: nVent CADDY Armour



Part #	Description	F ↓	📦
CATHPTM	nVent CADDY Cat HP J-Hook Tree Mount Bracket	200 lb	50 pc



## DATACOM/LOW VOLTAGE

### Cable Support Systems

#### **nVENT CADDY CAT HP CABLE PULLER KIT**

- Minimizes pulling tension per TIA 568-C.5.3.1 during the installation of high-performance data cables
- Includes retainer, screw, angle bracket, tree mount bracket, carabiner hook and beam clamp



Material: Steel, Spring Steel  
Finish: Pregalvanized, nVent CADDY Armour

Part #	Description	
CATHPLLR	nVent CADDY Cat HP Cable Puller Kit	2 pc

#### **nVENT CADDY CAT HP EXTENDED ANGLE BRACKET**

- Allows for quick installation of J-Hooks to ceiling at set heights
- Allows for field creation of custom J-Hook trees
- Secure fit to J-Hooks means no shifting or movement of the J-Hook during cable installation



Material: Steel  
Finish: Pregalvanized



Part #	Description	
CATHBA	1/4" Hole	40 pc
CATHBA3	3/16" Hole	40 pc
CATHBA6	3/8" Hole	40 pc
CATHBA8	1/2" Hole	40 pc

# DATACOM/LOW VOLTAGE Cable Support Systems

## NVENT CADDY CABLECAT J-HOOK

- Many sizes and designs available to attach to a variety of structures
- Cost effective alternative to expensive cable tray
- Galvanized finish on J-Hooks provide smoother cable pull and greater corrosion resistance
- cULus® Listed and complies with NEC® and TIA requirements for structured cabling systems



Material: Steel  
Finish: Pregalvanized



Part #	Description	
CAT12	PG, 0.75" dia	50 pc

## NVENT CADDY CABLECAT J-HOOK WITH BC BEAM CLAMP

- Beam clamp with attached nVent CADDY Cablecat J-Hook
- Supports low voltage cables



Material: Steel  
Finish: Pregalvanized, nVent CADDY Armour



Part #	Description	
CAT12BC	3/4" dia	40 pc

## DATACOM/LOW VOLTAGE

### Cable Support Systems

#### **NVENT CADDY CABLECAT J-HOOK WITH BC BEAM CLAMP, SWIVEL**

- Beam clamp with attached nVent CADDY Cablecat J-Hook
- Supports low voltage cables



Material: Steel  
Finish: Pregalvanized, nVent CADDY Armour



Part #	Description	
CAT12BCB	3/4" dia, 1/8"-1/2" Flange	40 pc

#### **NVENT CADDY CABLECAT J-HOOK WITH BC200 BEAM CLAMP**

- Beam clamp with attached nVent CADDY Cablecat J-Hook
- Supports low voltage cables



Material: Steel  
Finish: Pregalvanized



Part #	Description	
CAT12BC200	3/4" dia, 1/8"-1/2" Flange	40 pc

#### **NVENT CADDY CABLECAT J-HOOK WITH BC200 BEAM CLAMP, SWIVEL**

- Beam clamp with attached nVent CADDY Cablecat J-Hook
- Supports low voltage cables
- Rotates 360 degrees to support various directional runs of cable



Material: Steel  
Finish: Pregalvanized



Part #	Description	
CAT12BC200B	3/4" dia, 1/8"-1/2" Flange	40 pc

**DATACOM/LOW VOLTAGE**  
Cable Support Systems

**NVENT CADDY CABLECAT J-HOOK WITH HAMMER-ON FLANGE CLIP**

- Hammer-on beam clamp with attached nVent CADDY Cablecat J-Hook
- Supports low voltage cables



Material: Steel, Spring Steel  
Finish: Pregalvanized, nVent CADDY Armour



Part #	Description	
CAT1224SM	3/4" dia, 1/8"-1/4" Flange	40 pc
CAT1258SM	3/4" dia, 5/16"-1/2" Flange	40 pc
CAT12912SM	3/4" dia, 9/16"-3/4" Flange	40 pc

**NVENT CADDY CABLECAT J-HOOK WITH HAMMER-ON FLANGE CLIP, SWIVEL**

- Hammer-on beam clamp with attached nVent CADDY Cablecat J-Hook
- Supports low voltage cables
- Rotates 360 degrees to support various directional runs of cable



Material: Steel, Spring Steel  
Finish: Pregalvanized, nVent CADDY Armour



Part #	Description	
CAT1224	3/4" dia, 1/8"-1/4" Flange	40 pc
CAT1258	3/4" dia, 5/16"-1/2" Flange	40 pc
CAT12912	3/4" dia, 9/16"-3/4" Flange	20 pc

# DATACOM/LOW VOLTAGE

## Cable Support Systems

### NVENT CADDY CABLECAT J-HOOK WITH C PURLIN CLIP

- Purlin clip with attached nVent CADDY Cablecat J-Hook
- Supports low voltage cables



Material: Steel, Spring Steel  
Finish: Pregalvanized, nVent CADDY Armour



Part #	Description	
CAT12VF14	3/4" dia, 1/16"-1/4" Flange	40 pc

### NVENT CADDY CABLECAT J-HOOK WITH Z PURLIN CLIP

- Purlin clip with attached nVent CADDY Cablecat J-Hook
- Supports low voltage cables



Material: Steel, Spring Steel  
Finish: Pregalvanized, nVent CADDY Armour



Part #	Description	
CAT12AF14	3/4" dia, 1/16"-1/4" Flange	40 pc

### NVENT CADDY CABLECAT J-HOOK WITH PEDESTAL CLAMP

- Pedestal mount with attached nVent CADDY Cablecat J-Hook
- Supports low voltage cables



Material: Steel  
Finish: Pregalvanized



Part #	Description	
CAT12CD1B	3/4" dia, 3/4" Square, 7/8"-1 1/8" Round Pedestal	40 pc

# DATACOM/LOW VOLTAGE Cable Support Systems

## **nVENT CADDY CABLECAT J-HOOK WITH ROD/WIRE CLIP**

- Threaded rod attachment with attached nVent CADDY Cablecat J-Hook
- Supports low voltage cables



Material: Steel, Spring Steel  
Finish: Pregalvanized, nVent CADDY Armour



Part #	Description	
CAT124Z34	3/4" dia, 1/8"-3/8" Flange, 1/4" Rod	40 pc
CAT126Z34	3/4" dia, 3/8"-7/16" Flange, 3/8" Rod	60 pc
CAT128Z34	3/4" dia, 1/2", 5/8" Rod	50 pc

1/2" and 5/8" rod sizes are to be installed on threaded rod only.

## **nVENT CADDY CABLECAT T-GRID CLIP FOR J-HOOKS**

- T-Grid attachment for nVent CADDY Cablecat J-Hook support
- Supports low voltage cables



Material: Spring Steel  
Finish: nVent CADDY Armour



Part #	Description	
CATTS	nVent CADDY Cablecat T-Grid Clip for J-Hooks	100 pc

Additional support wire required per NEC® 300.11.

# DATACOM/LOW VOLTAGE Cable Support Systems

## **NVENT CADDY CABLECAT J-HOOK WITH SHOT-FIRE BRACKET**

- Cost effective alternative to expensive cable tray
- Galvanized finish on J-Hooks provide smoother cable pull and greater corrosion resistance
- Complete with shot-fire bracket and pre-assembled drive pin
- Quickly and easily attaches to concrete, steel or composite metal decking
- Integrated pin installs easily using powder-actuated or single-shot gas-actuated tools
- ICC-ES ESR-2024 evaluation report available for drive pin



Material: Steel  
Finish: Electrogalvanized, Pregalvanized

Part #	Description	
CAT12SF	3/4" dia	50 pc

## **NVENT CADDY CABLECAT J-HOOK WITH ANGLE BRACKET**

- Angle bracket support with attached nVent CADDY Cablecat J-Hook
- Supports low voltage cables



Material: Steel  
Finish: Pregalvanized



Part #	Description	
CAT12AB	3/4" dia, 1/4" Hole	40 pc

# DATAKOM/LOW VOLTAGE Cable Support Systems

## NVENT CADDY CABLECAT J-HOOK WITH PIN DRIVEN ANGLE BRACKET

- Angle bracket support with attached nVent CADDY Cablecat J-Hook
- Supports low voltage cables



Material: Steel  
Finish: Pregalvanized

Part #	Description	
CAT12AFAB3	3/4" dia, 3/16" Hole	50 pc



## NVENT CADDY CAT CM U-HOOK

- Provides optimal support for high-performance data cable, up to and including Cat 5e, Cat 6, Cat 6A, Cat 7 and fibre optic
- System offers a convenient pathway for wires and cables
- Specially designed U-Hooks have large-diameter, rounded support surfaces
- U-Hooks can be mounted vertically along the same drop rod to create a tree configuration
- Cantilever mounting allows U-Hooks to be mounted to walls and columns with brackets
- Rounded edges help prevent over-bending and kinking of cables
- Ideal for retrofit applications where cable runs need to be routed around existing building infrastructure
- Compliant with NEC® and ANSI®/TIA structured cabling systems standards



Material: Steel  
Finish: Electrogalvanized



Part #	Description		
CAT200CMLN	8"	100 lb	10 pc
CAT300CMLN	12"	100 lb	10 pc



# DATACOM/LOW VOLTAGE

## Cable Support Systems

### **nVENT CADDY CAT CM U-HOOK, STRUT MOUNT**

- Provides optimal support for high-performance data cable, up to and including Cat 5e, Cat 6, Cat 6A, Cat 7 and fibre optic
- Integrated quick-attach T-nut allows U-Hooks to be quickly mounted to strut
- System offers a convenient pathway for wires and cables
- Specially designed U-Hooks have large-diameter, rounded support surfaces
- Rounded edges help prevent over-bending and kinking of cables
- Ideal for retrofit applications where cable runs need to be routed around existing building infrastructure
- Compliant with NEC® and ANSI®/TIA structured cabling systems standards

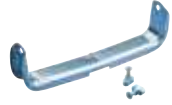

Material: Steel  
Finish: Electrogalvanized  
Included Components: Quick-Attach T-Nut



Part #	Description	F ↓	↓
CAT200CM	8"	100 lb	10 pc
CAT300CM	12"	100 lb	10 pc

# DATACOM/LOW VOLTAGE Cable Support Systems

## NVENT CADDY CAT CM DOUBLE U-HOOK, WALL MOUNT

- Provides high volume capacity with easy side-load cable installation
- Cantilever mounting allows U-Hooks to be mounted to walls and columns
- Provides optimal support for high-performance data cable, up to and including Cat 5e, Cat 6, Cat 6A, Cat 7 and fibre optic
- System offers a convenient pathway for wires and cables
- Cost effective alternative to expensive cable tray
- Specially designed U-Hooks have large-diameter, rounded support surfaces
- Rounded edges help prevent over-bending and kinking of cables
- Alternative support option for MC/AC cable
- Compliant with NEC® and ANSI®/TIA structured cabling systems standards



Material: Steel  
Finish: Electrogalvanized

Part #	Description	
UTS150CATCM	8"	10 pc
UTS200CATCM	8"	10 pc

Cable capacity represents the total cable capacity for the assembly. The cable capacity for each U-Hook should not exceed half of the published cable capacity. Non-continuous supports may not exceed spacing of 5' (1.5 m) per TIA 569-D.9.7 and EN 50174-2.

# DATACOM/LOW VOLTAGE

## Cable Support Systems

### **nVENT CADDY CAT CM DOUBLE J-HOOK**

- Provides optimal support for high-performance data cable, up to and including Cat 5e, Cat 6, Cat 6A, Cat 7 and fibre optic
- System offers a convenient pathway for wires and cables
- Double J-Hooks can be mounted vertically along the same drop rod to create a tree configuration
- Allows addition of cables even when fixed flush to overhead decking
- Specially designed double J-Hook has large-diameter, rounded support surfaces
- Rounded edges help prevent over-bending and kinking of cables
- Ideal for retrofit applications where cable runs need to be routed around existing building infrastructure
- Compliant with NEC® and ANSI®/TIA structured cabling systems standards



Material: Steel  
Finish: Electrogalvanized



Part #	Description	
CAT100CM	70 Cable Capacity, Cat 5e, 30 Cable Capacity, Cat 6A	20 pc

Area shown is the combined value for both sides. Divide by 2 for area of each side.

# DATACOM/LOW VOLTAGE Cable Support Systems

## NVENT CADDY CAT CM WIRE RETAINER

- Provides 360 degree containment for cables



Material: Steel  
Finish: Pregalvanized

Part #	Description	
CATRT200CM	9.525"	50 pc
CATRT300CM	13.5"	50 pc

## NVENT CADDY CAT CM PROTECTION TUBE

- Protects high performance data cables from coming in contact with threaded rod
- Minimizes the risk of cutting or abrading cable sheaths while pulling cable



Material: Steel  
Finish: Electrogalvanized

Part #	Description	
CATTBCM	5/8" dia	30 pc

## NVENT CADDY CAT CM WALL BRACKET

- Allows nVent CADDY Cat CM U-Hooks to be mounted to walls and columns



Material: Steel  
Finish: Pregalvanized

Part #	Description	
CATWMCM	8"	10 pc

## DATACOM/LOW VOLTAGE

### Cable Support Systems

#### **NVENT CADDY CAT 425 ADJUSTABLE CABLE SUPPORT**

- Provides optimal support for high-performance data cable, up to and including Cat 5e, Cat 6, Cat 6A, Cat 7 and fibre optic
- Simple unlocking and locking of bar allows for additional cables to be added easily after installation
- Adjustable strap allows for multiple support sizes to reduce inventory
- Cost effective alternative to expensive cable tray
- cULus® Listed and complies with NEC® and TIA requirements for structured cabling systems
- Suitable for air handling spaces (plenum)



Material: Steel, Polyethylene

Finish: Electrogalvanized



Part #	Description	F ↓	☐
CAT425	4", 6" dia, 1/4" Hole	100 lb	10 pc
CAT425A6	4", 6" dia, 3/8" Hole	100 lb	10 pc

#### **NVENT CADDY CAT 425 WALL MOUNT ADJUSTABLE CABLE SUPPORT**

- Provides optimal support for high-performance data cable, up to and including Cat 5e, Cat 6, Cat 6A, Cat 7 and fibre optic
- Simple unlocking and locking of bar allows for additional cables to be added easily after installation
- Adjustable strap allows for multiple support sizes to reduce inventory
- Cost effective alternative to expensive cable tray
- cULus® Listed and complies with NEC® and TIA requirements for structured cabling systems
- Suitable for air handling spaces (plenum)



Material: Steel, Polyethylene

Finish: Electrogalvanized



Part #	Description	F ↓	☐
CAT425WM	4", 6" dia	100 lb	10 pc

# DATACOM/LOW VOLTAGE

## Cable Support Systems

### NVENT CADDY CAT 425 ADJUSTABLE CABLE SUPPORT WITH BC BEAM CLAMP

- Easy installation to beam flanges
- Rotates 360 degrees to support various directional runs of cable
- Provides optimal support for high-performance data cable, up to and including Cat 5e, Cat 6, Cat 6A, Cat 7 and fibre optic
- Simple unlocking and locking of bar allows for additional cables to be added easily after installation
- Adjustable strap allows for multiple support sizes to reduce inventory
- Cost effective alternative to expensive cable tray
- cULus® Listed and complies with NEC® and TIA requirements for structured cabling systems
- Suitable for air handling spaces (plenum)



Material: Steel, Polyethylene  
 Finish: nVent CADDY Armour, ElectroGalvanized



Part #	Description	F ↓	☐
CAT425BC	4", 6" dia	100 lb	10 pc

### NVENT CADDY CAT 425 ADJUSTABLE CABLE SUPPORT WITH BC200 BEAM CLAMP

- Easy installation to beam flanges
- Rotates 360 degrees to support various directional runs of cable
- Provides optimal support for high-performance data cable, up to and including Cat 5e, Cat 6, Cat 6A, Cat 7 and fibre optic
- Simple unlocking and locking of bar allows for additional cables to be added easily after installation
- Adjustable strap allows for multiple support sizes to reduce inventory
- Cost effective alternative to expensive cable tray
- cULus® Listed and complies with NEC® and TIA requirements for structured cabling systems
- Suitable for air handling spaces (plenum)



Material: Steel, Polyethylene  
 Finish: ElectroGalvanized



Part #	Description	F ↓	☐
CAT425BC200	4", 6" dia	100 lb	10 pc

## DATACOM/LOW VOLTAGE

### Cable Support Systems

#### **nVENT CADDY CAT 425 ADJUSTABLE CABLE SUPPORT WITH PEDESTAL CLAMP**

- Easy installation to pedestals used under raised floors
- Provides optimal support for high-performance data cable, up to and including Cat 5e, Cat 6, Cat 6A, Cat 7 and fibre optic
- Simple unlocking and locking of bar allows for additional cables to be added easily after installation
- Adjustable strap allows for multiple support sizes to reduce inventory
- Cost effective alternative to expensive cable tray
- cULus® Listed and complies with NEC® and TIA requirements for structured cabling systems
- Suitable for air handling spaces (plenum)



Material: Steel, Polyethylene  
Finish: Electrogalvanized



Part #	Description	F ↓	📦
CAT425WMCD1B	4", 6" dia	50 lb	10 pc

#### **THREADED BRIDLE RING**

- Combine bridle rings with other nVent CADDY fasteners to support cables from flange, purlin, drop wire, t-grid, etc.



Material: Steel  
Finish: Electrogalvanized



Part #	Description	F ↓	📦
2BRT8	0.5" dia, #10 Screw, Metal	50 lb	100 pc
2BRT12	0.75" dia, #10 Screw, Metal	50 lb	100 pc
2BRT20	1.25" dia, #10 Screw, Metal	50 lb	100 pc
4BRT20WS	1.25" dia, #14 Screw, Wood	50 lb	100 pc
4BRT20	1.25" dia, 1/4" Screw, Metal	50 lb	100 pc
2BRT32	2" dia, #10 Screw, Metal	50 lb	100 pc
4BRT32WS	2" dia, #14 Screw, Wood	50 lb	100 pc
4BRT32	2" dia, 1/4" Screw, Metal	50 lb	100 pc
4BRT64	4" dia, 1/4" Screw, Metal	50 lb	50 pc

Bridle Rings not recommended for high performance cables.  
See nVent CADDY Cat HP J-Hook System.

# DATACOM/LOW VOLTAGE Bridle Rings

## MULTI-PURPOSE CLIP FOR BRIDLE RINGS

- Requires only a hammer to install
- Accommodates standard 1/4-20 or #10-24 threaded bridle rings, standard drive rings as well as unthreaded bridle rings
- Supports drive rings or bridle rings from flange



Material: Spring Steel  
Finish: nVent CADDY Armour



Part #	Description	
2FMP28	1/8"–1/2" Flange, 1/4", #10 Wire	100 pc

## BOX ELIMINATOR CONDUIT SUPPORT

- Eliminates need for electrical box when datacomm cables are run in conduit
- Easily attaches to the MP1S or MP2S low voltage mounting plates

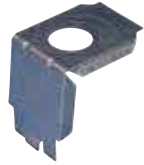

Material: Steel  
Finish: Pregalvanized



Part #	Description	
MPCB1220	Box Eliminator Conduit Support	25 pc

## BOX ELIMINATOR CONDUIT SUPPORT WITH MOUNTING PLATE

- Eliminates need for electrical box when datacomm cables are run in conduit
- Mounting plate kits include mounting plate, conduit support and screws



Material: Steel  
Finish: Pregalvanized



Part #	Description	
MP1SCB	1 Gang	25 pc
MP2SCB	2 Gang	25 pc



## DATACOM/LOW VOLTAGE Mounting Plates

### LOW VOLTAGE MOUNTING PLATE FOR NEW CONSTRUCTION

- Provides a bracket for mounting low voltage Class 2 communication outlets
- Reduces bulges in the dry wall caused by plaster rings
- May be installed to the front or the side of the metal or wood stud
- Side support provides for a rigid installation
- Attaches with self-tapping screws or nails
- Works with wood or metal studs



Material: Steel  
Finish: Pregalvanized



Part #	Description	
MP1S	1 Gang	25 pc
MP2S	2 Gang	25 pc

No load rating, for positioning only.

### LOW VOLTAGE MOUNTING PLATE WITH SCREWS

- Provides positive support with locking screws
- Makes wire "fishing" easier
- Install with a drywall saw and screwdriver
- Eliminates the need for an electrical box when installing low voltage Class 2 wiring



Material: Steel  
Finish: Plain



Part #	Description	
MPLS	1 Gang	100 pc
MPLS2	2 Gang	100 pc

For low voltage Class 2 use only.

# DATACOM/LOW VOLTAGE Mounting Plates

## LOW VOLTAGE MOUNTING PLATE

- Provides positive support with locking screws
- Makes wire "fishing" easier
- Install with a drywall saw and screwdriver
- Eliminates the need for an electrical box when installing low voltage Class 2 wiring



Material: Steel  
Finish: Pregalvanized



Part #	Description	
MP1	1 Gang	100 pc
MP2	2 Gang	100 pc

For low voltage Class 2 use only.

## PLASTIC LOW VOLTAGE MOUNTING PLATE

- No sharp metal edges with plastic design
- Fast, easy way to install
- No installation tools required to secure bracket in the drywall opening
- Serrated interlocking system secures tightly
- Template points on brackets help eliminate multiple measurement markings during installation
- Recessed design helps assure flush mount of device
- Eliminates the need for electrical boxes on low voltage class 2 applications



Material: Acrylonitrile Butadiene Styrene  
Finish: Plain



Part #	Description	
MP1P	1 Gang	100 pc
MPAL2	2 Gang	100 pc
MP34P	3, 4 Gang	2 pc

No load rating, for positioning only. For low voltage Class 2 use only.

## DATACOM/LOW VOLTAGE Mounting Plates

### VERSATILE THREAD IMPRESSION

- Support point for speakers, audio/video/security panels, EXIT signs, etc
- Use either #6-32 screw or #6 sheet metal screw
- Spring steel with corrosion protection finish



Material: Spring Steel  
Finish: nVent CADDY Armour



Part #	Description	
MPVT1	Versatile Thread Impression	20 pc

### NVENT CADDY CAT CR50 LOW-VOLTAGE CABLE RETAINER

- Complies with the NEC®, the CEC and TIA standards for cable management
- Allows for horizontal and vertical change of direction
- Installs easily
- Works with CAT 5e and higher, fibre optic and coaxial cable
- Residential application
- Suitable for air handling spaces (plenum)



Material: Polypropylene



Part #	Description		
CATCR50	2" dia	10 lb	25 pc

# DATAKOM/LOW VOLTAGE

## Clips, Clamps and Retainers

### NVENT CADDY MILLE-TIE

- Suitable for heavy duty applications
- Maintains cable properties and conductor configuration
- Protects cable from crimping with "Intelligent Grip Technology"
- Cushions vibration
- No sharp edges
- One size fits all
- Reusable



Material: Polyurethane  
Temperature: -4 to 140 °F

Part #	Description	
CATMTH	General Use, Black	100 pc
CATMTLS	Low-Smoke/Halogen Free, Yellow	100 pc
CATMTP	Plenum, Red	100 pc

### SIGNAL REFERENCE GRID WIRE CLAMP

- Provides a quick method to support a signal grid to computer floor pedestals
- Slots in fastener grip wire to provide positive contact with post
- Clamps grid wire directly to post allowing a low resistance connection across bare metal contacts
- Installs easily with a screwdriver or nut driver



Material: Steel  
Finish: Electrogalvanized

Part #	Description	
RGC	#8 Stranded-#4 Stranded	100 pc

RGC can be installed on 3/4" to 1" round or square pedestals.

# DATACOM/LOW VOLTAGE

## Clips, Clamps and Retainers

### METAL PRESSURE CLIP

- Ideal for smaller runs of cables
- Flexible clip retains shape and allows for cables to be inserted after installation
- Rounded edges help prevent cable damage
- Cables are neatly installed providing a consistent and professional appearance
- Low-profile allows for installations in tight spaces



Material: Spring Steel  
Finish: nVent CADDY Armour

Part #	Description	
PKM10H3	10 Cable, 0.19" Hole	50 pc
PKM10H6	10 Cable, 0.28" Hole	50 pc
PKM16H3	16 Cable, 0.19" Hole	50 pc
PKM16H6	16 Cable, 0.28" Hole	50 pc

Supports cable diameters up to 1/2" (13 mm) when installed with a standard 1/4" (6 mm) washer.

### METAL PRESSURE CLIP WITH NAIL GUN INSERT

- Clips onto nozzle of gas or battery-actuated nail guns allowing for hands-off installation at structure or from the floor using a pole
- Ideal for smaller runs of cables
- Flexible clip retains shape and allows for cables to be inserted after installation
- Rounded edges help prevent cable damage
- Cables are neatly installed providing a consistent and professional appearance
- Low-profile allows for installations in tight spaces



Material: Spring Steel, Nylon  
Finish: nVent CADDY Armour

Part #	Description	
PKM10H3GBSF	10 Cable	50 pc
PKM16H3GBSF	16 Cable	50 pc

# DATACOM/LOW VOLTAGE

## Clips, Clamps and Retainers

### NAIL GUN INSERT

- Clips onto nozzle of gas or battery-actuated nail guns allowing for hands-off installation at structure or from the floor using a pole
- Ideal for fastening junction boxes, electrical boxes and cable trunking
- Helps prevent damage when fastening to brittle materials
- Works with nVent CADDY Metal Pressure Clip
- Halogen free



Material: Nylon

Part #	Description	
IGBSF	Nail Gun Insert	100 pc

### LOW VOLTAGE ACCESSORY CLIP

- Ideal for low voltage applications, such as security, video, Wireless Access Protocol (WAP), Power over Ethernet (PoE), fire, and control wire
- Tool-free installation to existing wire basket pathway made easy with side retaining flaps
- Designed to fit commonly available wire basket tray with bottom and side mount applications
- Modular ganging feature for ease of installation expansion
- Compliant with UL® 2043 and suitable for use in air handling (plenum) spaces
- Meets ISO®/IEC 14763-2, ANSI®/TIA 568 and ANSI®/TIA 569



Material: Polypropylene



Part #	Description	
LVACBA	Black	50 pc
LVACRD	Red	50 pc

Non-continuous supports may not exceed spacing of 5' (1.5 m) per TIA 569-D.9.7 and EN 50174-2. Cable capacity is calculated based on a 70% fill rate.

## DATACOM/LOW VOLTAGE

### Vertical Cable Supports

#### **nVENT CADDY CAT 600R STRUT MOUNT VERTICAL CABLE SUPPORT KIT**

- Kit includes four nVent CADDY Cat 600R cable supports and a pre-cut section of strut
- Makes vertical cable pulling easier - locking mechanism opens during pull and re-engages when cable is released
- Rounded edges help prevent cable damage
- Valuable space savings within telecomm closets
- Reduces installation time
- Allows cable installation to start at the bottom floor



Material: Steel

Finish: Electrogalvanized

Part #	Description	
CAT600RKIT	nVent CADDY Cat 600R Strut Mount Vertical Cable Support Kit	1 pc

#### **nVENT CADDY CAT 600R STRUT MOUNT VERTICAL CABLE SUPPORT**

- Makes vertical cable pulling easier - locking mechanism opens during pull and re-engages when cable is released
- Includes pre-riveted assembly that twist-locks into the strut
- Rounded edges help prevent cable damage
- Valuable space savings within telecomm closets
- More versatile allowing future additions of cable runs
- Reduces installation time
- Allows cable installation to start at the bottom floor



Material: Steel

Finish: Electrogalvanized



Part #	Description	
CAT600R	nVent CADDY Cat 600R Strut Mount Vertical Cable Support	2 pc

# DATAKOM/LOW VOLTAGE

## Security Camera Mounting Kits

### nVENT CADDY CAT 600WM WALL MOUNT VERTICAL CABLE SUPPORT

- Makes vertical cable pulling easier - locking mechanism opens during pull and re-engages when cable is released
- Accepts wide range of cable sizes: (75) 4-pair UTP Cat 5e, (47) Cat 6, (10) 25-pair UTP, (1) each 100-pair through 600-pair
- Rounded edges help prevent cable damage
- Valuable space savings within telecomm closets
- More versatile allowing future additions of cable runs
- Reduces installation time
- Allows cable installation to start at the bottom floor



Material: Steel  
Finish: Electrogalvanized





Part #	Description	
CAT600WM	nVent CADDY Cat 600WM Wall Mount Vertical Cable Support	2 pc

### SECURITY CAMERA BETWEEN T-GRID MOUNTING KIT

- Ideal for mounting analog cameras, wireless access points, speakers, monitors and other small electronics
- Designed to meet the requirements of NEC® 300.11



Material: Steel  
Finish: Pregalvanized

Part #	Description		
SCMKC	Security Camera Between T-Grid Mounting Kit	50 lb	20 pc



## CABLE/CONDUIT

### Cable Tray and Accessories

#### WIRE BASKET TRAY CLIP

- Attaches wire basket tray to strut without additional hardware
- No tools required



Material: Spring Steel  
Finish: nVent CADDY Armour

Part #	Description	
KBT	3/16"–5/16" Wire	100 pc

Use two clips per strut support for trays up to 12" (300mm). Use three clips per strut support for trays up to 18" (457mm) and add one clip per strut support for each additional 6" (150mm) of tray width. No load rating, for positioning only.

#### UNIVERSAL TRAY SUPPORT

- Universal design to accommodate various cable tray hanging methods including ceiling, wall, threaded rod, or cable hanging systems
- C-shape maintains accessibility to cables after installation is completed
- Strut profile on both arms allow for two runs of cable trays per bracket
- Top tab can be bent allowing for extra wide cable trays to be installed when two brackets are fastened back-to-back
- Key holes provided for wall mount applications
- Works with the KBT Wire Basket Tray Clip for securing wire basket cable tray or J-bolts for securing cable ladder



Material: Steel

Part #	Description	Static Load 1	Static Load 2	
Finish: Electrogalvanized				
UTS150	EG, 6.5"	100 lb	200 lb	20 pc
UTS200	EG, 8.8"	100 lb	200 lb	20 pc
UTS300	EG, 12.7"	100 lb	200 lb	10 pc
Finish: Pregalvanized, Painted – Color: Black				
UTS150BA	PG, , , 6.5"	100 lb	200 lb	20 pc
UTS200BA	PG, , , 8.8"	100 lb	200 lb	20 pc
UTS300BA	PG, , , 12.7"	100 lb	200 lb	10 pc

Refer to Static Load 1 for installations with threaded rod.  
Refer to Static Load 2 for wall mount and 3 mm nVent CADDY Speed Link installations.

# CABLE/CONDUIT

## Cable Tray and Accessories

### WIRE BASKET SUPPORT CLIP

- Allows wire basket to be suspended from threaded rod without the need of a strut trapeze
- Securing fingers provides superior stability, preventing damage to the cables in the basket
- Allows for pre-fabrication off site



Material: Spring Steel  
Finish: nVent CADDY Armour

Part #	Description	F ↓	☐
WBS2	0.54" Hole	120 lb	50 pc

### WIRE BASKET SUPPORT CLIP WITH NUT

- Allows wire basket to be suspended from threaded rod without the need of a strut trapeze
- Pre-riveted nut eliminates the need for additional hardware
- Securing fingers provides superior stability, preventing damage to the cables in the basket
- Allows for pre-fabrication off site

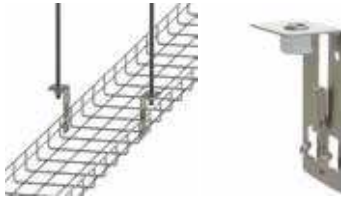

Material: Spring Steel, Steel  
Finish: nVent CADDY Armour, ElectroGalvanized

Part #	Description	F ↓	☐
WBS37	3/8" Rod	120 lb	20 pc

# CABLE/CONDUIT

## Cable Tray and Accessories

### WIRE BASKET SUPPORT CLIP, RETROFIT

- Allows wire basket to be suspended from threaded rod without the need of a strut trapeze
- Slotted design allows wire basket to be installed above an existing trapeze
- Securing fingers provides superior stability, preventing damage to the cables in the basket
- Allows for pre-fabrication off site



Material: Spring Steel  
Finish: nVent CADDY Armour

Part #	Description	F	
WBS1	0.4" Hole	120 lb	20 pc

### WIRE BASKET SIDE MOUNT CLIP

- Threaded hole allows for attachment of J-Hooks or electrical boxes
- Securing fingers provides superior stability, preventing damage to the cables in the basket
- Allows for pre-fabrication off site



Material: Spring Steel  
Finish: nVent CADDY Armour

Part #	Description	F	
WBSH25	1/4" Hole	120 lb	50 pc

# nVent CADDY WBT Performance Cable Tray System

The nVent CADDY WBT Performance Cable Tray System is an industry leading continuous cable tray and pathway support solution for today's high-performance cabling systems. Highly engineered features help ensure a secure installation that complies with industry codes and standards for high-performance cables. This robust solution gives confidence to the specifier their data installations are ideally supported with the innovative Shaped Tray, Form liners, and accessory exits and drop outs. Clever design allows the installer to maximize field efficiency with the PreForm and the No Splice. The nVent CADDY WBT Performance Cable Tray System provides the perfect combination of performance, time savings and versatility required by today's datacom and electrical contractors.



**DATA & NETWORKING SOLUTIONS**  
Featuring the nVent CADDY Cat HP J-Hook System  
& WBT Performance Cable Tray

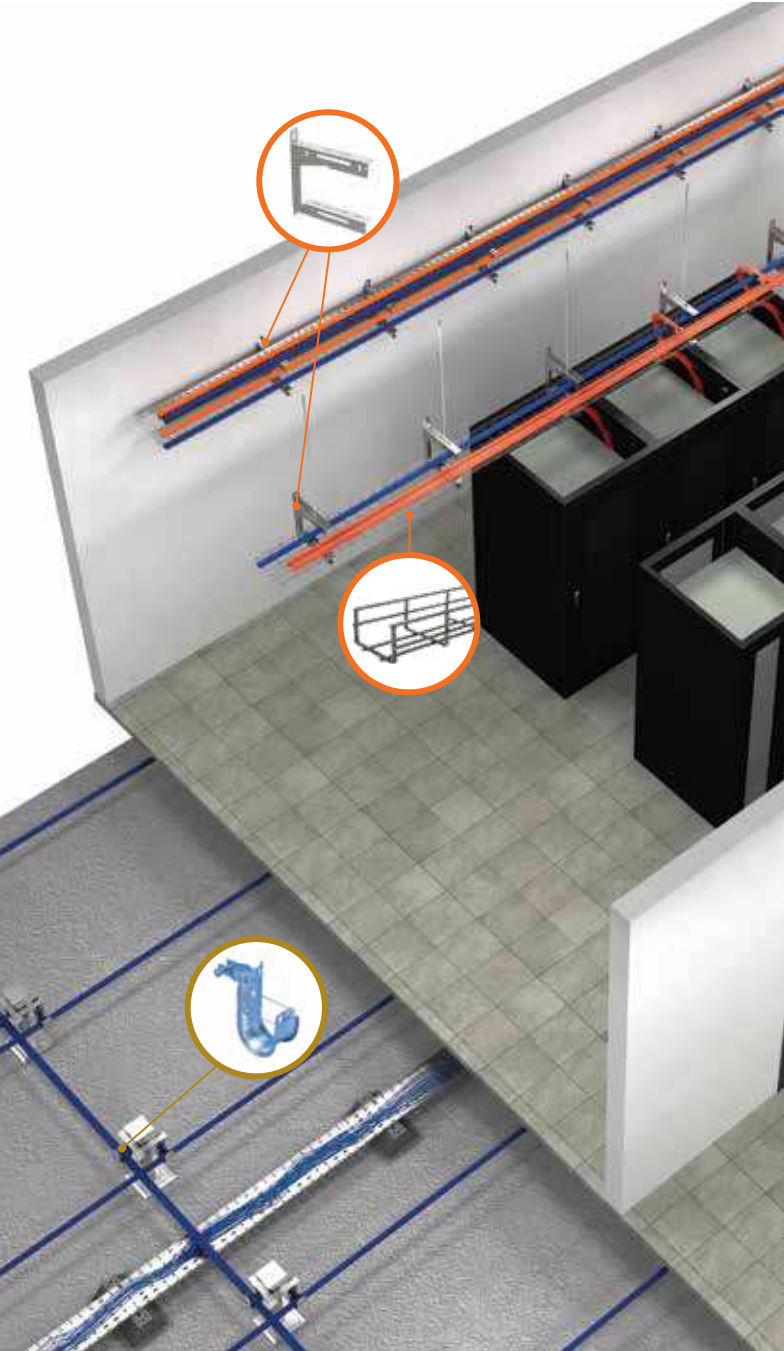

# DATA & NETWORKING SOLUTIONS

Featuring the nVent CADDY Cat HP J-Hook System & WBT Performance Cable Tray

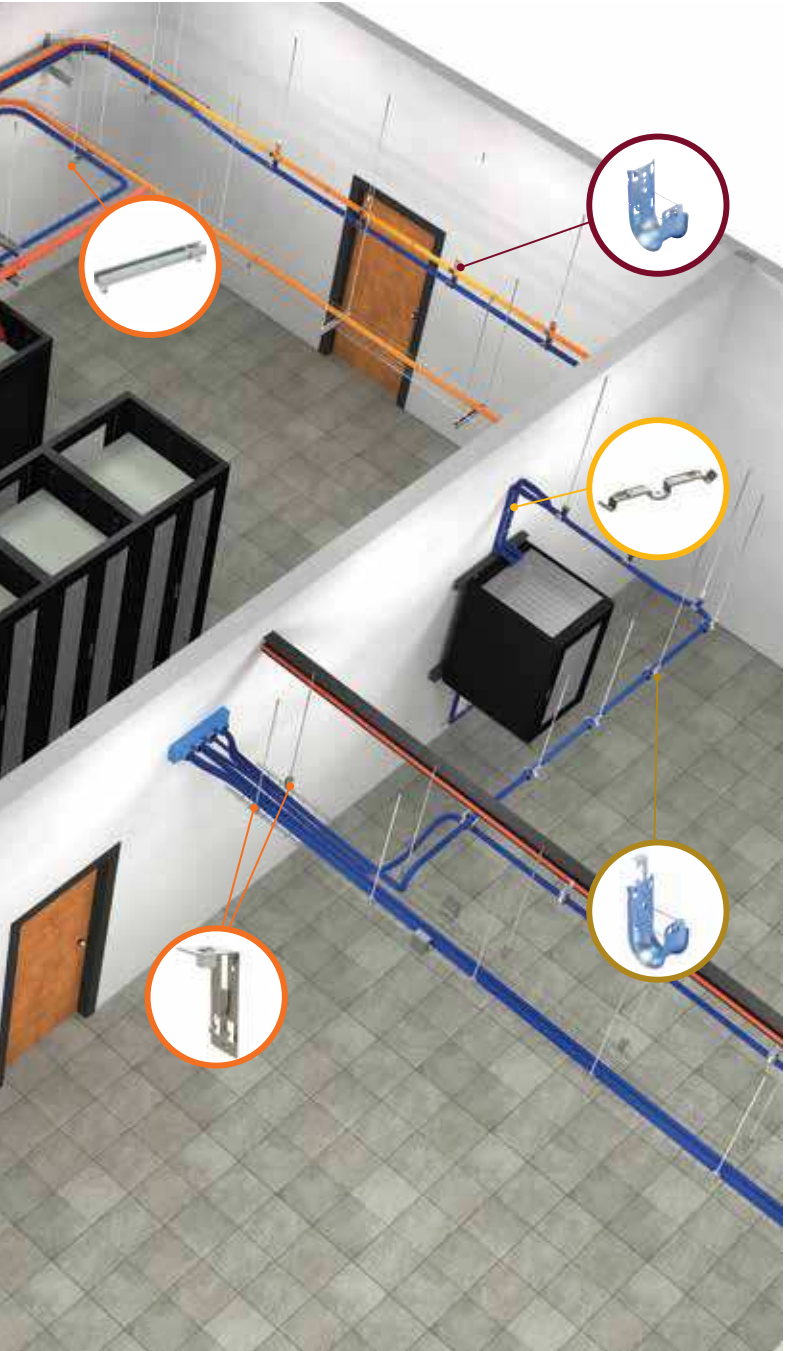

## DATA & NETWORKING SOLUTIONS







Featuring the nVent CADDY Cat HP J-Hook System  
& WBT Performance Cable Tray

From single wire to large bundle and cable tray, nVent CADDY has products and engineered solutions to fit any datacom need.

Our problem-solving, time-saving solutions include products you know and trust from J-Hooks to Telescoping Strut Replacement to the NEW nVent CADDY WBT Performance Cable Tray. All designed to work together and make your cable installation easier.

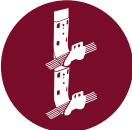
Trust nVent CADDY for datacom solutions that bring you the highest quality for the lowest total installed cost

nVent CADDY offers products for any cabling installation need – single wire to large bundle and cable tray. Learn more about our products and find your ideal solution mix with our convenient guide.

Installation Need	Featured Products
 <b>Wire Basket Tray and Ladder Supports</b>	WBT Performance Cable Tray Universal Tray Support Wire Basket Support Clip Rod Lock Telescoping Strut 
 <b>Large Bundle</b>	Cat HP J-Hook Tree Cat Adjustable Cable Supports Cat CM 
 <b>Medium Bundle</b>	Cat HP J-Hook Low Voltage Accessory Clip 
 <b>Small Bundle and Single Cable</b>	Metal Pressure Clip Cable Snap Clip 

# nVent CADDY Rod Lock

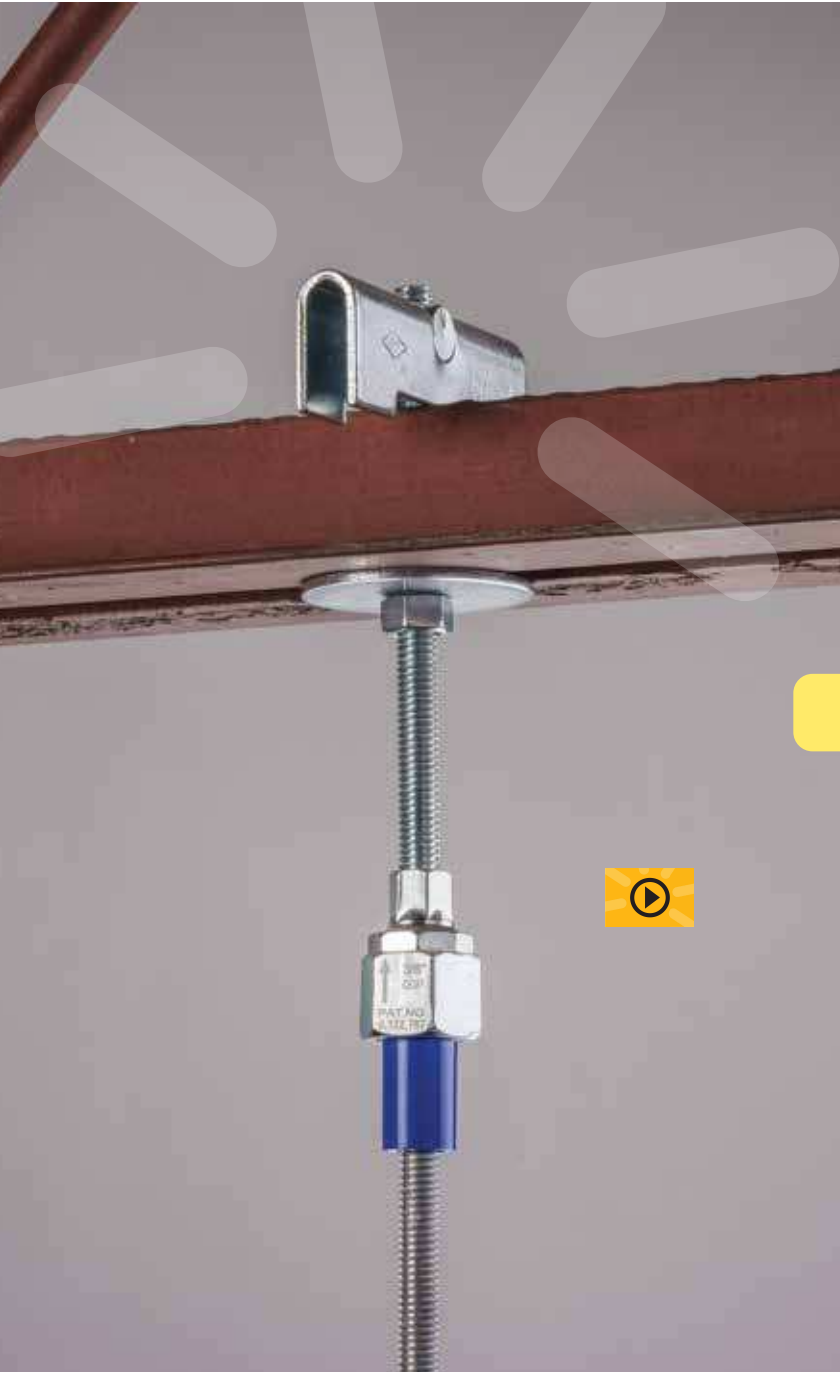



# nVENT CADDY ROD LOCK THREADED ROD MOUNTING SYSTEM

## nVent CADDY Rod Lock Structural Attachments

### ROD LOCK BEAM CLAMP

- Prefabricated assemblies easily lift and lock into place, helping to save time and money
- Easy “push-to-install” design allows installers to simply push the threaded rod through the mounting hole, instantly holding it in position
- Lock nut can be finger tightened, locking the rod in place
- Works with slightly damaged threads and minor burrs on the threaded rod
- Conforms with Federal Specification WW-H-171 (Type 23), Manufacturers Standardization Society ANSI®/MSS-SP-58 (Type 19 and 23)



Material: Cast Iron  
Finish: Electrogalvanized



Part #	Description	Static Load 1	Static Load 2	
CRLB37EG	3/8" Rod, 0.125"–0.375" Flange	250 lb	500 lb	25 pc

For use on plain and electro zinc plated hardware only. Static Load 1 represents 1/8" to 3/16" (3 mm to 5 mm) flange thickness. Static Load 2 represents 1/4" to 3/8" (6 mm to 10 mm) flange thickness. Recognizing that torque wrenches are generally not used or available on many job sites, the setscrew should be tightened so it contacts the I-beam and then an additional 1/2 turn added.

### ROD LOCK BEAM CLAMP, THICK FLANGE

- Prefabricated assemblies easily lift and lock into place, helping to save time and money
- Easy “push-to-install” design allows installers to simply push the threaded rod through the mounting hole, instantly holding it in position
- Lock nut can be finger tightened, locking the rod in place
- Works with slightly damaged threads and minor burrs on the threaded rod
- Conforms with Federal Specification WW-H-171 (Type 23), Manufacturers Standardization Society ANSI®/MSS-SP-58 (Type 19 and 23)



Material: Cast Iron  
Finish: Electrogalvanized



Part #	Description		
CRLB50EG	1/2" Rod, 0.375"–0.75" Flange	1,100 lb	25 pc

For use on plain and electro zinc plated hardware only. FM® Approved in the bottom mount orientation only. Recognizing that torque wrenches are generally not used or available on many job sites, the setscrew should be tightened so it contacts the I-beam and then an additional 1/2 turn added.

# NVENT CADDY ROD LOCK THREADED ROD MOUNTING SYSTEM

## nVent CADDY Rod Lock Structural Attachments

### ROD LOCK BAR JOIST HANGER

- Easily installs from underneath the bar joist
- Easily installs on lower or upper truss chord of the bar joist
- Plastic protection cap prevents dirt or structural coatings from obstructing the “push-to-install” mechanism
- Prefabricated assemblies easily lift and lock into place, helping to save time and money
- Easy “push-to-install” design allows installers to simply push the threaded rod through the mounting hole, instantly holding it in position
- Works with slightly damaged threads and minor burrs on the threaded rod



Material: Steel  
Finish: Electrogalvanized  
Static Load Safety Factor: 3.5:1

Part #	Description		
CRLJ37EG	3/8" Rod	1,000 lb	25 pc

# NVENT CADDY ROD LOCK THREADED ROD MOUNTING SYSTEM

## nVent CADDY Rod Lock Structural Attachments

### ROD LOCK ANCHOR SCREW

- For use with concrete and solid brick
- Prefabricated assemblies easily lift and lock into place, helping to save time and money
- Works with slightly damaged threads and minor burrs on the threaded rod



Material: Steel  
Finish: Electrogalvanized



Part #	Description	F	Box
CRLA37EG	3/8" Rod, 2.875" x 1.25" x 0.875"	652 lb	25 pc

For use on plain and electro zinc plated hardware only.  
Tested in 3,000 psi (20.68 MPa) concrete and soft or hard wood with a 9/32" pilot hole.

### ROD LOCK ANCHOR SCREW DRIVE SOCKET

- Drive socket for quick installation of nVent CADDY Rod Lock Anchor Screw



Material: Steel

Part #	Description	Box
CRLAKITA	nVent CADDY Rod Lock Anchor Screw Drive Socket	10 pc

# nVENT CADDY ROD LOCK THREADED ROD MOUNTING SYSTEM

## nVent CADDY Rod Lock Structural Attachments



### ROD LOCK METAL DECKING PRESET ANCHOR

- Set in place through a drilled hole in the metal decking before the concrete is poured
- Eliminate overhead drilling into building structure
  - nVent CADDY Rod Lock Preset Anchors are cast in place
- Can be used in lower and upper flute installations
- Works with slightly damaged threads and minor burrs on the threaded rod
- Prefabricated assemblies easily lift and lock into place, helping to save time and money
- Plastic flange acts as insert locator when the forms are removed
- Rated for cracked concrete per ICC-ES AC446 according to ICC-ES ESR-3864 evaluation report
- Suitable for seismic bracing according to ICC-ES ESR-3864 evaluation report



Material: Steel  
Finish: Electrogalvanized



Part #	Description		
CRLM37EG	3/8" Rod	830 lb	25 pc
CRLM50EG	1/2" Rod	830 lb	25 pc

### ROD LOCK METAL DECKING PRESET ANCHOR INSERT

- Allows for the installation of leveled nVent CADDY Rod Lock Metal Decking Preset Anchors anywhere between the metal decking ribs
- Symmetrical design with two insert holes for each size of Rod Lock Metal Decking Preset Anchors
- Compatible with a very wide range of metal decking
- Rod Lock Metal Decking Preset Anchors can be easily inserted through the insert plate while maintaining a tight positioning of the anchor
- Holes on each end of the insert for fixing to metal deck with self-tapping screws or nail gun
- Quick and easy installation



Material: Steel  
Finish: Pregalvanized

Part #	Description	
CRLMIP	nVent CADDY Rod Lock Metal Decking Preset Anchor Insert	25 pc

# NVENT CADDY ROD LOCK THREADED ROD MOUNTING SYSTEM

## nVent CADDY Rod Lock Structural Attachments

### ROD LOCK PLYWOOD FORM PRESET ANCHOR

- Eliminate overhead drilling into building structure – nVent CADDY Rod Lock Preset Anchors are cast in place
- Nails hold the anchor in place during the pour and easily break off with a strike of a hammer once the plywood forms are removed
- Works with slightly damaged threads and minor burrs on the threaded rod
- Prefabricated assemblies easily lift and lock into place, helping to save time and money
- Plastic flange acts as insert locator when the forms are removed
- Rated for cracked concrete per ICC-ES AC446 according to ICC-ES ESR-3864 evaluation report
- Suitable for seismic bracing according to ICC-ES ESR-3864 evaluation report



Material: Steel  
Finish: Electrogalvanized



Part #	Description	F	
CRLW37EG	3/8" Rod	1,407 lb	25 pc
CRLW50EG	1/2" Rod	1,618 lb	25 pc

### ROD LOCK L-BRACKET

- Easy "push-to-install" design allows installers to simply push the threaded rod through the mounting hole, instantly holding it in position
- Prefabricated assemblies easily lift and lock into place, helping to save time and money
- Multiple attachment holes support the use of either self-drilling screws or bolts, offering installation options for concrete, wood, and steel structures
- Lock nut can be finger tightened, locking the rod in place
- Integrated adjustment nut enables fine tuning the system height up or down
- Extremely useful in tight spaces where wrenches are difficult to use
- Conforms with Federal Specification WW-H-171 (Type 23), Manufacturers Standardization Society ANSI/MSS-SP-58 (Type 19 and 23)



Material: Steel  
Finish: Electrogalvanized



Part #	Description	
CRL37EG	3/8" Rod	25 pc

Follow fastener manufacturer's recommended shear and pull-out strength when fastening to the structure. Fastener not included. Install in accordance with applicable code.

# nVENT CADDY ROD LOCK THREADED ROD MOUNTING SYSTEM

## nVent CADDY Rod Lock Structural Attachments

### ROD LOCK COUPLER

- Joins two sections of threaded rod by an easy “push-to-install” mechanism
- Can be easily installed at the end of a threaded rod, or to any existing male thread
- Plastic protection cap prevents dirt or structural coatings from obstructing the “push-to-install” mechanism
- Prefabricated assemblies easily lift and lock into place, helping to save time and money
- Works with slightly damaged threads and minor burrs on the threaded rod



Material: Steel  
Finish: Electrogalvanized  
Static Load Safety Factor: 3.5:1

Part #	Description		
CRLC37EG	3/8" Rod	1,000 lb	25 pc

### ROD LOCK COUPLER WITH ROD

- Easily installs into any traditional structural threaded rod attachment
- Allows simple installation of threaded rod assemblies by an easy “push-to-install” mechanism
- Plastic protection cap prevents dirt or structural coatings from obstructing the “push-to-install” mechanism
- Prefabricated assemblies easily lift and lock into place, helping to save time and money
- Works with slightly damaged threads and minor burrs on the threaded rod



Material: Steel  
Finish: Electrogalvanized  
Static Load Safety Factor: 3.5:1

Part #	Description		
CRLC37L1	3/8" Rod	1,000 lb	25 pc

# NVENT CADDY ROD LOCK THREADED ROD MOUNTING SYSTEM

## nVent CADDY Rod Lock Supports

### ROD LOCK STRUT

- Allows for the quick creation, installation, and adjustment of multi-level trapeze assemblies
- Ready to use out of the box and eliminates the need for cutting and preparing sections of strut
- Easy “push-to-install” design allows installers to simply push the threaded rod through the mounting hole, instantly holding it in position
- Integrated adjustment nut enables fine tuning the system height up or down
- Accommodates slight variances in rod-to-rod position of the trapeze
- No loose parts or special tools needed for installation
- Lock nut can be finger tightened, locking the rod in place
- Works with all accessories that fit standard A or C type strut channels



Material: Steel  
Finish: Electrogalvanized, Pregalvanized

Part #	Description	F ↓	☐
<b>Strut Type: A (1 5/8" x 1 5/8")</b>			
CRLP237L14	A Strut, 3/8" Rod, 16"	2,668 lb	5 pc
CRLP237L18	A Strut, 3/8" Rod, 20"	2,075 lb	5 pc
CRLP237L22	A Strut, 3/8" Rod, 24"	1,698 lb	5 pc
CRLP237L26	A Strut, 3/8" Rod, 28"	1,437 lb	5 pc
CRLP237L38	A Strut, 3/8" Rod, 40"	983 lb	5 pc
CRLP237L50	A Strut, 3/8" Rod, 52"	642 lb	5 pc
CRLP250L18	A Strut, 1/2" Rod, 20"	2,075 lb	5 pc
CRLP250L22	A Strut, 1/2" Rod, 24"	1,698 lb	5 pc
CRLP250L26	A Strut, 1/2" Rod, 28"	1,437 lb	5 pc
CRLP250L38	A Strut, 1/2" Rod, 40"	983 lb	5 pc
CRLP250L50	A Strut, 1/2" Rod, 52"	642 lb	5 pc
<b>Strut Type: C (13/16" x 1 5/8")</b>			
CRLP137L14	C Strut, 3/8" Rod, 16"	789 lb	5 pc
CRLP137L18	C Strut, 3/8" Rod, 20"	613 lb	5 pc
CRLP137L22	C Strut, 3/8" Rod, 24"	494 lb	5 pc
CRLP137L26	C Strut, 3/8" Rod, 28"	354 lb	5 pc
CRLP137L38	C Strut, 3/8" Rod, 40"	166 lb	5 pc

Ultimate load ratings for nVent CADDY Rod Lock Strut assumes a uniformly distributed load and includes a hole factor of 0.92. It is based on the material yield and maximum allowable deflection; an additional Safety Factor of 2 is recommended. nVent CADDY Rod Lock Strut must be installed with the open side of the channel facing up. For indoor applications only.

# NVENT CADDY ROD LOCK THREADED ROD MOUNTING SYSTEM

## nVent CADDY Rod Lock Supports

### ROD LOCK TELESCOPING STRUT REPLACEMENT

- Easy “push-to-install” design allows installers to simply push the threaded rod through the mounting hole, instantly holding it in position
- Telescopes to the desired length and is locked in place by snapping closed a spring retainer clip
- Standard strut profile runs the entire length of the part, allowing most standard fittings to be placed anywhere between the rods
- Allows installers to prefabricate complex assemblies and quickly lift and lock them into place
- Lock nut can be finger tightened, locking the rod in place
- Allows for the quick creation, installation, and adjustment of multi-level trapeze assemblies
- Captive threaded nuts enable fastening to threaded rod supports without loose parts
- Integrated ruler displays space between hanger rods in inches and centimeters
- Supports up to seven 2” (50 DN) conduits, six 2” (50 DN) water filled pipes at 10’ (3 m) spacing, or up to 18” (450 mm) cable tray
- Conduit can be supported on the top and bottom, eliminating the need for double sided strut
- Conduit and pipe can be placed directly on the strut profile, saving vertical space in buildings with limited room for installation
- Meets requirements of the Buy American Act



Material: Steel  
Finish: Pregalvanized

Part #	Description	Static Load 1	Static Load 2	
TSR122038RL	3/8" Rod	300 lb	200 lb	20 pc

Static Load 1 represents a distributed load for 12" - 20" (300 - 500 mm) installations and a point load for 12" - 16" (300 - 400 mm) installations. Static Load 2 represents a point load for 16" - 20" (400 - 500 mm) installations.



# NVENT CADDY ROD LOCK THREADED ROD MOUNTING SYSTEM

## nVent CADDY Rod Lock Supports

### ROD LOCK CHANNEL NUT

- Provides fast universal attachment of threaded rod and hardware to standard strut profiles
- Can be used to prefabricate assemblies which can be quickly pushed onto previously installed threaded rods
- Works with slightly damaged threads and minor burrs on the threaded rod



Material: Cast Iron  
Finish: Electrogalvanized

Part #	Description	F ↓	↓ ↓
CRLS37EG	3/8" Rod	750 lb	100 pc

For use on plain and electro zinc plated hardware only.

### ROD LOCK HEIGHT-ADJUSTABLE STRUT NUT

- Allows for the quick creation, installation, and adjustment of multi-level trapeze assemblies
- Installs in strut profiles without the need to insert fingers or tools into the strut
- Easy "push-to-install" design allows installers to simply push the threaded rod through the mounting hole, instantly holding it in position
- Integrated adjustment nut enables fine tuning the system height up or down
- Lock nut can be finger tightened, locking the rod in place
- Accommodates slight variances in rod-to-rod position of the trapeze
- Can be used to prefabricate assemblies which can be quickly pushed onto previously installed threaded rods
- Works with slightly damaged threads and minor burrs on the threaded rod



Material: Steel  
Finish: Electrogalvanized

Part #	Description	Static Load 1	Static Load 2	↓ ↓
CRLSL37EG	A Strut, 3/8" Rod	1,500 lb	900 lb	20 pc

Static Load 1 represents 12 GA strut channel type A.  
Static Load 2 represents 14 GA strut channel type C.  
Must be installed with the open side of the strut channel facing up.  
nVent CADDY Rod Lock Strut Nuts must be installed at a minimum of 1" (25.4 mm) from both ends of the strut channel.

# NVENT CADDY ROD LOCK THREADED ROD MOUNTING SYSTEM

## nVent CADDY Rod Lock Hardware

### ROD LOCK NUT

- Easy “push-to-install” design allows installers to simply push the threaded rod through the mounting hole, instantly holding it in position
- Fast installation onto long threaded rods – push the nut in place instead of threading it up the rod
- Excellent alignment and easy fine adjustment by spinning the nut
- Extremely useful in tight spaces where wrenches are difficult to use

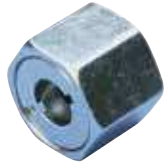

Material: Steel  
Finish: Electrogalvanized

Part #	Description	F ↓	📦
CRLN37EG	3/8" Rod	1,350 lb	25 pc

Static Load based on Grade 2 threaded rod.

### SN SERIES NUT

- Allows side mounting of nut to threaded rod
- Reduces the need for threading compared to standard nuts and washers
- Ideal for retrofit projects, such as trapeze installations, where disassembly of the support system is not desired
- Works with slightly damaged threads and minor burrs on the threaded rod
- Reduces installation time up to 50%



Material: Steel  
Finish: Electrogalvanized

Part #	Description	F ↓	📦
SN25	1/4" Rod	500 lb	100 pc
SN37	3/8" Rod	1,350 lb	100 pc
SN50	1/2" Rod	2,250 lb	100 pc

For use on plain and electro zinc plated hardware only.

# NVENT CADDY ROD LOCK THREADED ROD MOUNTING SYSTEM

## nVent CADDY Rod Lock Hardware

### SNSW FLANGED NUT

- Ideal for retrofit projects, such as trapeze installations, where disassembly of the support system is not desired
- Use as a stopper when installing nVent CADDY Rod Lock assemblies
- Can be easily installed, removed, and repositioned at any location along the threaded rod
- Ready to use out of the box and eliminates multiple pieces of standard hardware
- Functions as a hex nut and flat washer combined
- Washer is wide enough to work with standard strut channel profiles



Material: Steel  
Finish: Electrogalvanized  
Static Load Safety Factor: 3:1

Part #	Description	F ↓	📦
SNSW37	3/8" Rod, 1.67" dia	300 lb	20 pc
SNSW50	1/2" Rod, 1.9" dia	300 lb	20 pc

For use on plain and electro zinc plated hardware only.

# nVent CADDY Speed Link



# NVENT CADDY SPEED LINK UNIVERSAL SUPPORT SYSTEM

## nVent CADDY Speed Link SLK System

### SPEED LINK SLK WITH ANGLE BRACKET

- Complete system includes wire, locking device and pre-assembled angle bracket end fitting
- Ideal for attaching to concrete, steel or wood surfaces
- Simple alternative to jack chain and additional hardware



Material: Steel, Zinc Alloy, Polypropylene  
Finish: Electrogalvanized  
Static Load Safety Factor: 5:1  
Complies With: SMACNA HVAC-DCS



Part #	Description	F ↓	☐
Wire Rope Diameter: 1.5 mm			
SLK15L1AB	1.5 mm Wire, 3.3' Length	44 lb	20 pc
SLK15L2AB	1.5 mm Wire, 6.6' Length	44 lb	20 pc
SLK15L3AB	1.5 mm Wire, 9.9' Length	44 lb	20 pc
SLK15L5AB	1.5 mm Wire, 16.4' Length	44 lb	20 pc
Wire Rope Diameter: 2.0 mm			
SLK2L2AB	2 mm Wire, 6.6' Length	100 lb	10 pc
SLK2L3AB	2 mm Wire, 9.9' Length	100 lb	10 pc
SLK2L5AB	2 mm Wire, 16.4' Length	100 lb	10 pc

# NVENT CADDY SPEED LINK UNIVERSAL SUPPORT SYSTEM

## nVent CADDY Speed Link SLK System

### SPEED LINK SLK WITH SHOT-FIRE BRACKET

- Complete system includes wire, locking device and shot-fire bracket with pre-assembled drive pin from Powers Fasteners, Inc.
- Quickly and easily attaches to concrete, steel or composite metal decking
- Integrated pin installs easily using powder-actuated or single-shot gas-actuated tools
- ICC-ES ESR-2024 evaluation report available for drive pin from DEWALT®



Material: Steel, Zinc Alloy, Polypropylene  
 Finish: Electrogalvanized  
 Static Load Safety Factor: 5:1  
 Complies With: SMACNA HVAC-DCS



Part #	Description	F	
Wire Rope Diameter: 1.5 mm			
SLK15L1SF	1.5 mm Wire, 3.3' Length	44 lb	20 pc
SLK15L2SF	1.5 mm Wire, 6.6' Length	44 lb	20 pc
SLK15L3SF	1.5 mm Wire, 9.9' Length	44 lb	20 pc
SLK15L5SF	1.5 mm Wire, 16.4' Length	44 lb	20 pc
Wire Rope Diameter: 2.0 mm			
SLK2L2SF	2 mm Wire, 6.6' Length	100 lb	10 pc
SLK2L3SF	2 mm Wire, 9.9' Length	100 lb	10 pc

Uses Powers Fasteners, Inc. part number 50032. Static load was established based on a 1" (25.4 mm) embedment depth and 3,000 psi (20.68 MPa) lightweight concrete. For variations in embedment and material please consult [anchors.dewalt.com](http://anchors.dewalt.com). Pre-assembled drive pin from Powers Fasteners, Inc. works with Powers® C4CZ, Simpson® GCN-MEPKT, SPIT® P1000, P200, P2201, P3500 / PA3500, P35s, P45, P60, P7201, Sniper; Ramset® 721, Cobra, D45 / D60 / D60L, M70, SA270, T3SS, TS750P, TS60P, Viper; Hilti® DX35, DX350 / DX351 / DX36M, DX100 / DX200, DX460, DXA40, DXA41, DXE72 / DX400; Würth® Diva-1, BST-1, BST-2 or equivalent nailers. For shot-fired supports in seismic design category D, E, or F, maximum load is the lesser of 90 lb (400 N) or the published load.

# NVENT CADDY SPEED LINK UNIVERSAL SUPPORT SYSTEM

## nVent CADDY Speed Link SLK System

### SPEED LINK SLK WITH NAIL GUN BRACKET

- Complete system includes wire, locking device and concrete nail gun insert bracket
- Clips onto nozzle of gas or battery-actuated nail guns allowing for hands-off installation at structure or from the floor using a pole
- Longer leg angle bracket for tool clearance
- Quickly and easily attaches to concrete, steel or composite metal decking



Material: Steel, Zinc Alloy, Polypropylene  
 Finish: Electrogalvanized  
 Static Load Safety Factor: 5:1

Part #	Description	F ↓	☐
Wire Rope Diameter: 1.5 mm			
SLK15L2GBSF	1.5 mm Wire, 6.6' Length	44 lb	20 pc
SLK15L3GBSF	1.5 mm Wire, 9.9' Length	44 lb	20 pc
Wire Rope Diameter: 2.0 mm			
SLK2L2GBSF	2 mm Wire, 6.6' Length	100 lb	10 pc
SLK2L3GBSF	2 mm Wire, 9.9' Length	100 lb	10 pc

Static Load represents the static load of the nail gun insert assembly. Please consult with the nail manufacturer to evaluate the static load of the nail and type of concrete used for the installation. Maximum load is the lesser of the static load from the nail manufacturer or the published load for the assembly. Nail gun insert is compatible with BeA® CN60-688ES, Hilti® BX 3, GX 3, DEWALT® Trak-It C3, SPIT® PULSA 800E, 700, 1000 or equivalent nailers.

# nVent CADDY SPEED LINK UNIVERSAL SUPPORT SYSTEM

## nVent CADDY Speed Link SLK System

### SPEED LINK SLK WITH DECKING HOOK

- Complete system includes wire, locking device and pre-assembled decking hook end fitting
- Quickly and easily attaches to hollow metal decking
- Spring-loaded ends snap into decking hole and lock into place
- Innovative design helps protect the wire from sharp edges of decking hole, minimizing risk of damage to wire



Material: Steel, Zinc Alloy, Polypropylene  
 Finish: Electrogalvanized  
 Static Load Safety Factor: 5:1  
 Complies With: SMACNA HVAC-DCS



Part #	Description	F	Box
Wire Rope Diameter: 1.5 mm			
SLK15L3DH	1.5 mm Wire, 9.9' Length	44 lb	20 pc
SLK15L5DH	1.5 mm Wire, 16.4' Length	44 lb	20 pc
Wire Rope Diameter: 2.0 mm			
SLK2L3DH	2 mm Wire, 9.9' Length	100 lb	10 pc
SLK2L5DH	2 mm Wire, 16.4' Length	100 lb	10 pc

Load rating is only applicable if the load-bearing capacity of the supporting element (steel decking) is adequate. Check with deck manufacturer for recommended load capacity.

### SPEED LINK SLK WITH HAMMER-ON FLANGE CLIP

- Complete system includes wire, locking device and pre-assembled nVent CADDY Hammer-On Flange Clip end fitting
- Installs with just a hammer
- Fits most beams



Material: Steel, Polypropylene, Zinc Alloy  
 Finish: Electrogalvanized  
 Static Load Safety Factor: 5:1  
 Complies With: SMACNA HVAC-DCS



Part #	Description	F	Box
Wire Rope Diameter: 1.5 mm			
SLK15L34H24	1.5 mm Wire, 9.9' Length, 1/8"–1/4" Flange	44 lb	20 pc
SLK15L34H58	1.5 mm Wire, 9.9' Length, 5/16"–1/2" Flange	44 lb	20 pc
Wire Rope Diameter: 2.0 mm			
SLK2L34H24	2 mm Wire, 9.9' Length, 1/8"–1/4" Flange	100 lb	10 pc
SLK2L34H58	2 mm Wire, 9.9' Length, 5/16"–1/2" Flange	100 lb	10 pc



# NVENT CADDY SPEED LINK UNIVERSAL SUPPORT SYSTEM

## nVent CADDY Speed Link SLK System

### SPEED LINK SLK WITH HOOK

- Complete system includes wire, locking device and pre-assembled hook end fitting
- Hooks to a wide range of nVent CADDY fasteners
- Fastens to the building structure or hanging services by looping around and hooking to wire rope
- Easy to remove for applications requiring maintenance
- Spring latch helps provide secure connection
- Insert cable through hole and use bottom side of hook as an end stop
- Also available in Y-hook configuration



Material: Steel, Polypropylene, Zinc Alloy  
 Finish: Electrogalvanized  
 Static Load Safety Factor: 5:1



Part #	Description	F		Cert
<b>Wire Rope Diameter: 1.5 mm</b>				
SLK15L1	1.5 mm Wire, 3.3' Length	44 lb	20 pc	
SLK15L2	1.5 mm Wire, 6.6' Length	44 lb	20 pc	
SLK15L2R2	1.5 mm Wire, 6.6' Length	44 lb	15 x 2 pc	
SLK15L3	1.5 mm Wire, 9.9' Length	44 lb	20 pc	cULus, SMACNA
SLK15L3R2	1.5 mm Wire, 9.9' Length	44 lb	15 x 2 pc	
SLK15L5	1.5 mm Wire, 16.4' Length	44 lb	20 pc	
SLK15L5R2	1.5 mm Wire, 16.4' Length	44 lb	15 x 2 pc	
SLK15L7	1.5 mm Wire, 22.9' Length	44 lb	20 pc	
SLK15L10	1.5 mm Wire, 32.8' Length	44 lb	20 pc	
<b>Wire Rope Diameter: 2.0 mm</b>				
SLK2L1	2 mm Wire, 3.3' Length	100 lb	10 pc	
SLK2L2	2 mm Wire, 6.6' Length	100 lb	10 pc	
SLK2L2R2	2 mm Wire, 6.6' Length	100 lb	15 x 2 pc	cULus, SMACNA
SLK2L3	2 mm Wire, 9.9' Length	100 lb	10 pc	
SLK2L3R2	2 mm Wire, 9.9' Length	100 lb	15 x 2 pc	
SLK2L5	2 mm Wire, 16.4' Length	100 lb	10 pc	
SLK2L10	2 mm Wire, 32.8' Length	100 lb	10 pc	
<b>Wire Rope Diameter: 3.0 mm</b>				
SLK3L1	3 mm Wire, 3.3' Length	200 lb	10 x 10 pc	
SLK3L2	3 mm Wire, 6.6' Length	200 lb	10 x 10 pc	
SLK3L3	3 mm Wire, 9.9' Length	200 lb	5 x 10 pc	
SLK3L3R2	3 mm Wire, 9.9' Length	200 lb	15 x 2 pc	SMACNA
SLK3L5	3 mm Wire, 16.4' Length	200 lb	5 x 10 pc	
SLK3L5R2	3 mm Wire, 16.4' Length	200 lb	15 x 2 pc	
SLK3L10	3 mm Wire, 32.8' Length	200 lb	5 x 5 pc	

# nVent CADDY SPEED LINK UNIVERSAL SUPPORT SYSTEM

## nVent CADDY Speed Link SLK System

### SPEED LINK SLK WITH LOOP

- Complete system includes wire, locking device and pre-assembled loop end fitting
- Easy and flexible solution attaches to building structures
- Wire rope wraps around structure and through loop for quick installation
- Ideal for attaching to purlins, beams and other structural members
- Works well in tight or confined spaces
- Loop attaches directly to pipe, ductwork or other hanging assemblies



Material: Steel, Polypropylene, Zinc Alloy  
 Finish: Electrogalvanized  
 Static Load Safety Factor: 5:1



Part #	Description	F		Cert
<b>Wire Rope Diameter: 1.5 mm</b>				
SLK15L1LP	1.5 mm Wire, 3.3' Length	44 lb	20 pc	cULus, SMACNA
SLK15L2LP	1.5 mm Wire, 6.6' Length	44 lb	20 pc	
SLK15L3LP	1.5 mm Wire, 9.9' Length	44 lb	20 pc	
SLK15L5LP	1.5 mm Wire, 16.4' Length	44 lb	20 pc	
SLK15L10LP	1.5 mm Wire, 32.8' Length	44 lb	20 pc	
<b>Wire Rope Diameter: 2.0 mm</b>				
SLK2L1LP	2 mm Wire, 3.3' Length	100 lb	10 pc	cULus, SMACNA
SLK2L2LP	2 mm Wire, 6.6' Length	100 lb	10 pc	
SLK2L3LP	2 mm Wire, 9.9' Length	100 lb	10 pc	
SLK2L5LP	2 mm Wire, 16.4' Length	100 lb	10 pc	
SLK2L7LP	2 mm Wire, 22.9' Length	100 lb	5 pc	
SLK2L10LP	2 mm Wire, 32.8' Length	100 lb	5 pc	
<b>Wire Rope Diameter: 3.0 mm</b>				
SLK3L2LP	3 mm Wire, 6.6' Length	200 lb	10 x 10 pc	SMACNA
SLK3L5LP	3 mm Wire, 16.4' Length	200 lb	5 x 10 pc	
SLK3L10LP	3 mm Wire, 32.8' Length	200 lb	5 x 5 pc	

# NVENT CADDY SPEED LINK UNIVERSAL SUPPORT SYSTEM

## nVent CADDY Speed Link SLK System

### SPEED LINK SLK WITH THREADED STUD END

- Complete system includes wire, locking device and pre-assembled threaded stud end fitting
- Attaches to structures with threaded anchors or devices with threaded hole
- Connects directly to threaded devices in trapeze assemblies, light fixtures, HVAC assemblies or signage



Material: Steel, Polypropylene, Zinc Alloy  
 Finish: Electrogalvanized  
 Static Load Safety Factor: 5:1  
 Complies With: SMACNA HVAC-DCS



Part #	Description	F		Cert
Wire Rope Diameter: 1.5 mm				
SLK15L2SE250	1.5 mm Wire, 6.6' Length, 1/4" Rod	44 lb	20 pc	cULus
SLK15L3SE250	1.5 mm Wire, 9.9' Length, 1/4" Rod	44 lb	20 pc	cULus
SLK15L5SE250	1.5 mm Wire, 16.4' Length, 1/4" Rod	44 lb	20 pc	cULus
Wire Rope Diameter: 2.0 mm				
SLK2L2SE250	2 mm Wire, 6.6' Length, 1/4" Rod	100 lb	10 pc	cULus
SLK2L5SE250	2 mm Wire, 16.4' Length, 1/4" Rod	100 lb	10 pc	cULus
Wire Rope Diameter: 3.0 mm				
SLK3L3SE375	3 mm Wire, 9.9' Length, 3/8" Rod	200 lb	5 x 10 pc	

# NVENT CADDY SPEED LINK UNIVERSAL SUPPORT SYSTEM

## nVent CADDY Speed Link SLK System

### SPEED LINK SLK WITH WEDGE ANCHOR

- Complete system includes wire, locking device and wedge anchor from Powers Fasteners, Inc.
- Quickly and easily attaches into cracked and non-cracked concrete
- No special tools required



Material: Steel, Polypropylene, Zinc Alloy

Finish: Electrogalvanized

Static Load Safety Factor: 5:1

Complies With: SMACNA HVAC-DCS

Part #	Description	F	☐
Wire Rope Diameter: 1.5 mm			
SLK15L2WA6	1.5 mm Wire, 6.6' Length	44 lb	10 x 10 pc
SLK15L5WA6	1.5 mm Wire, 16.4' Length	44 lb	5 x 10 pc
Wire Rope Diameter: 2.0 mm			
SLK2L2WA6	2 mm Wire, 6.6' Length	100 lb	10 pc
SLK2L5WA6	2 mm Wire, 16.4' Length	100 lb	10 pc
Wire Rope Diameter: 3.0 mm			
SLK3L2WA6	3 mm Wire, 6.6' Length	200 lb	10 pc
SLK3L5WA6	3 mm Wire, 16.4' Length	200 lb	10 pc
SLK3L10WA6	3 mm Wire, 32.8' Length	200 lb	5 pc

# NVENT CADDY SPEED LINK UNIVERSAL SUPPORT SYSTEM

## nVent CADDY Speed Link SLK System

### SPEED LINK SLK WITH TOGGLE

- Complete system includes wire, locking device and pre-assembled toggle end fitting
- Attaches to clearance holes in a variety of structures or hanging devices
- Ideal for supporting lighting fixtures
- Also available in Y-toggle configuration



Material: Steel, Zinc Alloy, Polypropylene  
Finish: Electrogalvanized  
Static Load Safety Factor: 5:1  
Complies With: SMACNA HVAC-DCS  
Wire Rope Diameter: 1.5 mm



Part #	Description	F ↓	📦
SLK15L1T	1.5 mm Wire, 3.3' Length	44 lb	20 pc
SLK15L1TR2	1.5 mm Wire, 3.3' Length	44 lb	15 x 2 pc
SLK15L2T	1.5 mm Wire, 6.6' Length	44 lb	20 pc
SLK15L2TR2	1.5 mm Wire, 6.6' Length	44 lb	15 x 2 pc
SLK15L3T	1.5 mm Wire, 9.9' Length	44 lb	20 pc
SLK15L5T	1.5 mm Wire, 16.4' Length	44 lb	20 pc
SLK15L10T	1.5 mm Wire, 32.8' Length	44 lb	20 pc

# nVENT CADDY SPEED LINK UNIVERSAL SUPPORT SYSTEM

## nVent CADDY Speed Link SLK System

### SPEED LINK SLK WITH Y-HOOK

- Complete system includes wire, locking device and two pre-assembled hook end fittings
- Fastens to the building structure and hooks to hanging services and tray
- Spring latch helps provide secure connection
- Convenient design allows one hook to be temporarily detached for maintenance or to add cables to the tray
- Single drop with double hook provides increased stability to the system
- Also available in a single-hook end fitting configuration



Material: Steel, Zinc Alloy, Polypropylene  
 Finish: Electrogalvanized  
 Static Load Safety Factor: 5:1  
 Complies With: SMACNA HVAC-DCS  
 Wire Rope Diameter: 2 mm



Part #	Description	F ↓	↓ Cube
SLK2YH500L2	6.6' Length, 19.6" Y-Length	100 lb	10 pc
SLK2YH500L2R2	6.6' Length, 19.6" Y-Length	100 lb	15 x 2 pc
SLK2YH500L3	9.9' Length, 19.6" Y-Length	100 lb	10 pc
SLK2YH500L3R2	9.9' Length, 19.6" Y-Length	100 lb	15 x 2 pc
SLK2YH500L7	22.3' Length, 19.6" Y-Length	100 lb	10 pc

# NVENT CADDY SPEED LINK UNIVERSAL SUPPORT SYSTEM

## nVent CADDY Speed Link SLK System

### SPEED LINK SLK WITH Y-TOGGLE

- Complete system includes wire, locking device and two pre-assembled toggle end fittings
- Attaches to clearance holes in a variety of structures or hanging devices
- Ideal for supporting lighting fixtures



Material: Steel, Zinc Alloy, Polypropylene

Finish: Electrogalvanized

Static Load Safety Factor: 5:1

Complies With: SMACNA HVAC-DCS



Part #	Description	F ↓	☐
Wire Rope Diameter: 1.5 mm			
SLK15Y300L3	1.5 mm Wire, 9.9' Length, 11.8" Y-Length	44 lb	20 pc
SLK15Y300L3R2	1.5 mm Wire, 9.9' Length, 11.8" Y-Length	44 lb	20 x 2 pc
SLK15Y500L3	1.5 mm Wire, 9.9' Length, 19.6" Y-Length	44 lb	20 pc
SLK15Y500L3R2	1.5 mm Wire, 9.9' Length, 19.6" Y-Length	44 lb	15 x 2 pc
SLK15Y300L5	1.5 mm Wire, 16.4' Length, 11.8" Y-Length	44 lb	20 pc
Wire Rope Diameter: 2.0 mm			
SLK2Y300L2	2 mm Wire, 6.6' Length, 11.8" Y-Length	100 lb	10 pc
SLK2Y300L3	2 mm Wire, 9.9' Length, 11.8" Y-Length	100 lb	10 pc
SLK2Y300L3R2	2 mm Wire, 9.9' Length, 11.8" Y-Length	100 lb	15 x 2 pc
SLK2Y500L3	2 mm Wire, 9.9' Length, 19.6" Y-Length	100 lb	10 pc
SLK2Y300L5	2 mm Wire, 16.4' Length, 11.8" Y-Length	100 lb	10 pc
SLK2Y300L7	2 mm Wire, 22.9' Length, 11.8" Y-Length	100 lb	10 pc
SLK2Y300L10	2 mm Wire, 32.8' Length, 11.8" Y-Length	100 lb	10 pc

# nVENT CADDY SPEED LINK UNIVERSAL SUPPORT SYSTEM

## nVent CADDY Speed Link SLS System

### SPEED LINK SLS WITH DECKING HOOK

- Complete system includes wire, locking device and pre-assembled decking hook end fitting
- Quickly and easily attaches to hollow metal decking
- Spring-loaded ends snap into decking hole and lock into place
- Innovative design helps protect the wire from sharp edges of decking hole, minimizing risk of damage to wire
- Finger tightening of nut secures the locking device into position without tools
- Installs in strut profiles without the need to insert fingers or tools into the strut



Material: Steel, Zinc Alloy, Polypropylene  
 Finish: Electrogalvanized  
 Static Load Safety Factor: 5:1  
 Complies With: SMACNA HVAC-DCS  
 Wire Rope Diameter: 2 mm



Part #	Description	F ↓	↓ Cube
SLS2L3DH	2 mm Wire, 9.9' Length	60 lb	10 pc
SLS2L7DH	2 mm Wire, 22.9' Length	60 lb	10 pc

The 2 mm locking device is compatible with C-Channel Types E0 and E0L.  
 Total load per wire on a multi-tier trapeze must not exceed static load.  
 Load rating is only applicable if the load-bearing capacity of the supporting element (steel decking) is adequate. Check with deck manufacturer for recommended load capacity.



# NVENT CADDY SPEED LINK UNIVERSAL SUPPORT SYSTEM

## nVent CADDY Speed Link SLS System

### SPEED LINK SLS WITH HOOK

- Complete system includes wire, locking device and pre-assembled hook end fitting
- Hooks to a wide range of nVent CADDY fasteners
- Fastens to the building structure or hanging services by looping around and hooking to wire rope
- Easy to remove for applications requiring maintenance
- Spring latch helps provide secure connection
- Insert cable through hole and use bottom side of hook as an end stop
- Finger tightening of nut secures the locking device into position without tools
- Installs in strut profiles without the need to insert fingers or tools into the strut



Material: Steel, Zinc Alloy, Polypropylene  
 Finish: Electrogalvanized  
 Static Load Safety Factor: 5:1  
 Complies With: SMACNA HVAC-DCS



Part #	Description	F	
Wire Rope Diameter: 2 mm			
SLS2L2	2 mm Wire, 6.6' Length	60 lb	10 pc
SLS2L10	2 mm Wire, 32.8' Length	60 lb	10 pc
Wire Rope Diameter: 3 mm			
SLS3L2	3 mm Wire, 6.6' Length	150 lb	10 x 10 pc
SLS3L5	3 mm Wire, 16.4' Length	150 lb	10 x 5 pc
SLS3L10	3 mm Wire, 32.8' Length	150 lb	5 x 5 pc

The 2 mm locking device is compatible with C-Channel Types E0 and E0L.  
 The 3 mm locking device is compatible with C-Channel Types E1, E2, E2L, E3, E4, E5, Strut Channel Type C, Slotted, Strut Channel Type A, Slotted, Strut Channel Type AS, Perforated, Strut Channel Type CC, Slotted, Strut Channel Type AA, Slotted. Total load per wire on a multi-tier trapeze must not exceed static load.

# NVENT CADDY SPEED LINK UNIVERSAL SUPPORT SYSTEM

## nVent CADDY Speed Link SLS System

### SPEED LINK SLS WITH THREADED STUD END

- Complete system includes wire, locking device and pre-assembled threaded stud end fitting
- Attaches to structures with threaded anchors or devices with threaded hole
- Finger tightening of nut secures the locking device into position without tools
- Installs in strut profiles without the need to insert fingers or tools into the strut



Material: Steel, Polypropylene, Zinc Alloy  
 Finish: Electrogalvanized  
 Static Load Safety Factor: 5:1  
 Complies With: SMACNA HVAC-DCS  
 Wire Rope Diameter: 2 mm



Part #	Description	F	Box
SLS2L2SE250	2 mm Wire, 6.6' Length, 1/4" Rod	60 lb	10 pc
SLS2L5SE250	2 mm Wire, 16.4' Length, 1/4" Rod	60 lb	10 pc

The 2 mm locking device is compatible with C-Channel Types E0 and E0L.  
 Total load per wire on a multi-tier trapeze must not exceed static load.

# NVENT CADDY SPEED LINK UNIVERSAL SUPPORT SYSTEM

## nVent CADDY Speed Link SLS System

### SPEED LINK SLS WITH WEDGE ANCHOR

- Complete system includes wire, locking device and wedge anchor from Powers Fasteners, Inc.
- Quickly and easily attaches into cracked and non-cracked concrete
- Installs in strut profiles without the need to insert fingers or tools into the strut
- Finger tightening of nut secures the locking device into position without tools
- No special tools required
- ETA-13/0106 assessment available for wedge anchor from Powers Fasteners, Inc



Material: Steel, Polypropylene, Zinc Alloy  
Finish: Electrogalvanized  
Static Load Safety Factor: 5:1  
Complies With: SMACNA HVAC-DCS  
Wire Rope Diameter: 2 mm



Part #	Description	F	
SLS2L3WA6	2 mm Wire, 9.9' Length	60 lb	10 pc
SLS2L5WA6	2 mm Wire, 16.4' Length	60 lb	10 pc

The 2 mm locking device is compatible with C-Channel Types E0 and E0L.  
Total load per wire on a multi-tier trapeze must not exceed static load.

# nVent CADDY SPEED LINK UNIVERSAL SUPPORT SYSTEM

## nVent CADDY Speed Link SLS System

### SPEED LINK SLS TRAPEZE KIT

- Out of the box trapeze solution includes Telescoping Strut Replacement, wire rope with pre-assembled hook end-fitting, and two nVent CADDY Speed Link SLS locking devices
- Telescopes to the desired length and is locked in place by snapping closed a spring retainer clip
- Standard strut profile runs the entire length of the Telescoping Strut Replacement, allowing most standard fittings to be placed anywhere between the wire rope supports
- Supports up to seven 2" (50 DN) conduits, six 2" (50 DN) water filled pipes at 10' (3 m) spacing, or up to 18" (450 mm) cable tray
- Conduit and pipe can be placed directly on the strut profile, saving vertical space in buildings with limited room for installation
- Fastens to the building structure or hanging services by looping around and hooking to wire rope
- Hooks to a wide range of nVent CADDY fasteners
- Finger tightening of nut secures the locking device into position without tools
- Installs in telescoping strut replacement without the need to insert fingers or tools into the channel
- Easy to remove for applications requiring maintenance



Material: Steel, Zinc Alloy, Polyamide  
Finish: Electrogalvanized, Pregalvanized  
Wire Rope Diameter: 3 mm

Part #	Description	Static Load 1	Static Load 2	
TSR1220SLS3	nVent CADDY Speed Link SLS Trapeze Kit	300 lb	200 lb	10 pc

Static Load 1 represents a distributed load for 12" - 20" (300 - 500 mm) installations and a point load for 12" - 16" (300 - 400 mm) installations. Static Load 2 represents a point load for 16" - 20" (400 - 500 mm) installations.

# NVENT CADDY SPEED LINK UNIVERSAL SUPPORT SYSTEM

## nVent CADDY Speed Link LD System

### SPEED LINK LD WITH HOOK

- Complete system includes wire, locking device and pre-assembled hook end fitting
- Hooks to a wide range of nVent CADDY fasteners
- Fastens to the building structure or hanging services by looping around and hooking to wire rope
- Easy to remove for applications requiring maintenance
- Spring latch helps provide secure connection
- Insert cable through hole and use bottom side of hook as an end stop



Material: Stainless Steel 304 (EN 1.4301)  
 Static Load Safety Factor: 5:1  
 Wire Rope Diameter: 1.5 mm



Part #	Description	F	Box
SLD15L2S	S304, 1.5 mm Wire, 6.6' Length	44 lb	20 x 2 pc
SLD15L5S	S304, 1.5 mm Wire, 16.4' Length	44 lb	20 x 2 pc
SLD15L10S	S304, 1.5 mm Wire, 32.8' Length	44 lb	20 x 2 pc

### SPEED LINK Y-HOOK WITH EYELET EXTENSION

- Double hook offers easy attachment to basket tray, cable tray or lighting
- Convenient design allows one hook to be temporarily detached for maintenance or to add cables to the tray
- Y-design provides improved stability
- Spring latch helps provide secure connection

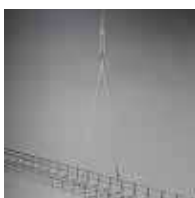

Material: Steel  
 Finish: Electrogalvanized  
 Static Load Safety Factor: 5:1



Part #	Description	F	Box
Wire Rope Diameter: 2 mm			
SLD2YH500	2 mm Wire, 19.6" Y-Length	100 lb	10 pc
Wire Rope Diameter: 3 mm			
SLD3YH500	3 mm Wire, 19.6" Y-Length	200 lb	10 pc

nVent CADDY Speed Link locking device not included.

# nVENT CADDY SPEED LINK UNIVERSAL SUPPORT SYSTEM

## nVent CADDY Speed Link Extensions

### SPEED LINK Y-TOGGLE WITH EYELET EXTENSION

- Attaches to clearance holes in a variety of structures or hanging devices
- Ideal for supporting lighting fixtures
- Y-design provides improved stability



Material: Steel  
 Finish: Electrogalvanized  
 Static Load Safety Factor: 5:1



Part #	Description	F ↓	↓	Cert
Wire Rope Diameter: 1.5 mm				
SLD15Y200	1.5 mm Wire, 7.8" Y-Length	44 lb	20 pc	cULus
SLD15Y300	1.5 mm Wire, 11.8" Y-Length	44 lb	20 pc	cULus
SLD15Y500	1.5 mm Wire, 19.6" Y-Length	44 lb	20 pc	
Wire Rope Diameter: 2.0 mm				
SLD2Y300	2 mm Wire, 11.8" Y-Length	100 lb	20 pc	cULus

nVent CADDY Speed Link locking device not included.

### SPEED LINK QUAD-TOGGLE WITH EYELET EXTENSION

- Secure hanging solution for use on control access points, projectors, etc.



Material: Steel  
 Finish: Electrogalvanized  
 Static Load Safety Factor: 5:1



Part #	Description	F ↓	↓
SLD15QT250	1.5 mm Wire, 9.8" Y-Length	44 lb	20 pc

nVent CADDY Speed Link locking device not included.

# nVENT CADDY SPEED LINK UNIVERSAL SUPPORT SYSTEM

## nVent CADDY Speed Link Locking Devices and Wire Rope

### SPEED LINK SLK SPOOL KIT

- Kit includes spool of nVent CADDY Speed Link steel wire and nVent CADDY Speed Link SLK locking devices
- Wire spool and locking devices are packaged together, simplifying transportation to the jobsite and reducing inventory
- Packaging allows end-users to pull and cut any length of wire that is needed without having to take the spool out of the box
- Ideal for rework and installations where custom lengths of wire may be needed
- Wire rope constructed from seven bundles of seven strands each of steel aircraft wire
- Push/pull keyless release allows easy adjustments
- Low-profile locking device minimizes visual impact
- Cable spread of 90 degrees allows positioning the device closer to the load
- Keyless release tubes are easy to operate while wearing gloves
- Double-sided locking mechanism enables simple height adjustment



Material: Steel  
Finish: Electrogalvanized

Part #	Description
SLK15L500PACK	1.5 mm Wire, 500', 100 Locking Devices
SLK15L50MPACK	1.5 mm Wire, 164', 25 Locking Devices
SLK2L100PACK	2 mm Wire, 328', 50 Locking Devices

# NVENT CADDY SPEED LINK UNIVERSAL SUPPORT SYSTEM

## nVent CADDY Speed Link Locking Devices and Wire Rope

### SPEED LINK SLK LOCKING DEVICE

- Push/pull keyless release allows easy adjustments
- Low-profile locking device minimizes visual impact
- Cable spread of 90 degrees allows positioning the device closer to the load
- Keyless release tubes are easy to operate while wearing gloves
- Double-sided locking mechanism enables simple height adjustment



Material: Steel, Polypropylene, Zinc Alloy



Part #	Description		Cert
SLK2C200	1.5–2 mm Wire	200 pc	cULus
SLK2C50	1.5–2 mm Wire	50 pc	cULus
SLK3C200	3 mm Wire	200 pc	
SLK3C50	3 mm Wire	50 pc	

Locking devices are only to be used with nVent CADDY Speed Link wire spools and accessories with the same specified Wire Rope Diameter as the locking device. Do not use with any other wires.



# NVENT CADDY SPEED LINK UNIVERSAL SUPPORT SYSTEM

## nVent CADDY Speed Link Locking Devices and Wire Rope

### SPEED LINK SLS LOCKING DEVICE

- Single barrel locking device allows for quickprefabrication of strut or brackets
- Push-on nut quickly and securely installs to strut or bracket to keep the locking device in position and eases installation
- Finger tightening of nut secures the locking device into position without tools
- Installs in strut profiles without the need to insert fingers or tools into the strut
- Push-on nut guides the cable into the locking device and brings stability to the support
- Installs with open side of the strut channel facing up or down for more flexibility



Material: Steel, Polypropylene, Zinc Alloy



Part #	Description	
SLS2C50	2 mm Wire	50 pc
SLS3C50	3 mm Wire	50 pc

The 2 mm locking device is compatible with C-Channel Types E0 and E0L.

The 3 mm locking device is compatible with C-Channel Types E1, E2, E2L, E3, E4, E5, Strut Channel Type C, Slotted, Strut Channel Type A, Slotted, Strut Channel Type AS, Perforated, Strut Channel Type CC, Slotted, Strut Channel Type AA, Slotted. Locking devices are only to be used with nVent CADDY Speed Link wire spools and accessories with the same specified Wire Rope Diameter as the locking device. Do not use with any other wires.

### SPEED LINK LD LOCKING DEVICE

- Low-profile locking device minimizes visual impact
- Suitable for 1.5 mm nVent CADDY Speed Link cable



Material: Stainless Steel 304 (EN 1.4301)

Part #	Description	
SLJR200	1.5 mm Wire	200 pc

The 1.5 mm locking devices are only to be used with the SLC15L1000SP and SLC15L50MSP wire spools, or any other 1.5 mm nVent CADDY Speed Link accessories. Do not use with any other wires.

# nVent CADDY SPEED LINK UNIVERSAL SUPPORT SYSTEM

## nVent CADDY Speed Link Locking Devices and Wire Rope

### WIRE SPOOL

- Spool with nVent CADDY Speed Link steel wire
- Wire rope constructed from seven bundles of seven strands each of steel aircraft wire



Material: Steel  
Finish: Electrogalvanized

Part #	Description	F ↓	☐
SLC15L50MSP	1.5 mm Wire, 164'	44 lb	1 pc
SLC15L1000SP	1.5 mm Wire, 1,000'	44 lb	1 pc
SLC2L1000SP	2 mm Wire, 1,000'	100 lb	1 pc
SLC3L1000SP	3 mm Wire, 1,000'	200 lb	1 pc

### WIRE ROPE CUTTER

- Designed to reduce wire rope fraying



Material: Steel

Part #	Description	☐
SLWC	Wire Rope Cutter	1 pc

# NVENT CADDY SPEED LINK UNIVERSAL SUPPORT SYSTEM

## nVent CADDY Speed Link Accessories

### AIR DUCT CORNER PROTECTOR

- Includes rib to keep the wire rope in place
- Prevents the wire rope from damaging the duct

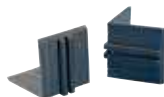

Material: Polyvinylchloride  
Color: Black

Part #	Description	
SLADCP	Air Duct Corner Protector	10 pc

### AIR DUCT SUPPORT ATTACHMENT

- Angled bracket for installation on to round or square duct
- Designed to accept nVent CADDY Speed Link wire rope or hook



Material: Steel  
Finish: Electrogalvanized



Part #	Description	
SLADS	Air Duct Support Attachment	100 pc

### CONCRETE FIXING EYEBOLT SCREW

- For use in concrete and brick
- Includes drill bit adapter for easy installation



Material: Steel  
Finish: Electrogalvanized

Part #	Description		
CFEB05	0.256" Hole, H6 Screw	160 lb	100 pc

# nVENT CADDY SPEED LINK UNIVERSAL SUPPORT SYSTEM

## nVent CADDY Speed Link Accessories

### WOOD FIXING EYE SCREW

- Designed to accept nVent CADDY Speed Link wire rope or hook



Material: Steel  
Finish: Electrogalvanized

Part #	Description	
SLEBWS	Wood Fixing Eye Screw	100 pc

### EYE SCREW

- Designed to accept nVent CADDY Speed Link wire rope or hook



Material: Steel  
Finish: Electrogalvanized

Part #	Description	
SLEB250	1/4" Screw	100 pc
SLEB375	3/8" Screw	100 pc

### LIGHT DUTY LIGHT FIXTURE EYELET

- Inserts into openings of light fixture
- Hook or loop through lighting clip to suspend lighting from wire rope or chain



Material: Stainless Steel 302 (EN 1.4324)

Part #	Description		
SLLC250	Light Duty Light Fixture Eyelet	12 lb	200 pc

Do not use light fixture eyelet as a lifting device.

# NVENT CADDY SPEED LINK UNIVERSAL SUPPORT SYSTEM

## nVent CADDY Speed Link Accessories

### MC/AC CABLE CLIP

- Spring steel cable attachment
- Allows for electrical cable to be attached to nVent CADDY Speed Link wire rope



Material: Spring Steel  
Finish: nVent CADDY Armour

Part #	Description	
SL1214	0.468"–0.562" OD	100 pc
SL1518	0.5"–0.718" OD	100 pc

### ANGLE BRACKET WITH OBLONG HOLE

- 90° angle mounting bracket
- Suitable for shot firing or screw fixing
- With oblong hole to allow nVent CADDY Speed Link hook



Material: Steel  
Finish: Pregalvanized

Part #	Description		
SLAFAB3	3/16" Hole	200 lb	50 pc

# Ceiling/Acoustical



## CEILING/ACOUSTICAL Acoustical Lighting Hangers

### LAY-IN AND TROFFER SUPPORT CLIP, STRAIGHT/UPTURNED LIP

- Provides a positive method for securing troffers, lay-ins, and air diffusers
- Four clips per fixture required by code



Material: Spring Steel

Part #	Description		Cert
Finish: GEOMET® 321			
515A	NEC Article 410.36 Complies With	100 pc	UL
Finish: Painted — Color: White			
515AWHA	White	100 pc	

No load rating, for positioning only.

### LAY-IN AND TROFFER SUPPORT CLIP, STRAIGHT LIP

- Provides a positive method for securing troffers, lay-ins, and air diffusers
- Complies with The National Electrical Code, Article 410.36 Means of Support
- Four clips per fixture required by code



Material: Spring Steel  
Finish: nVent CADDY Armour

Part #	Description	
515	Lay-In and Troffer Support Clip, Straight Lip	100 pc

No load rating, for positioning only.

# CEILING/ACOUSTICAL

## Acoustical Lighting Hangers

### LIGHT FIXTURE SUSPENSION BAR FOR T-GRID

- Reduces installation time
- No tools required for installation
- End clips rotate for mounting horizontal or vertical base plates
- Position of fixture is adjustable, simply slide to location
- Applicable to a wide variety of light fixtures
- Measure width of bar to find appropriate bar for fixture
- No center clips required
- Replaces fixture bar



Material: Spring Steel  
Finish: nVent CADDY Armour

Part #	517B	517A	517C
Replacement Bar Type	Narrow 1/2" x 1/8"	Standard 5/8" x 1/4"	Wide 3/4" x 1/8"
Light Fixtures	Capri HSG Halo H7 Lightolier 711	Capri PR-751CX Capri R-10C Capri R-10X Capri R-9X Halo H17 Juno AP Juno APT Juno IC Juno ICT Juno J Juno SC Juno TC Thomas RI-IC	Marco Progress P-7

Standard Packaging Quantity 10 pc

No load rating, for positioning only.

### SUSPENSION BAR FOR LIGHTOLIER® CALCULITE®

- Reduces installation time
- Only a screwdriver required
- Position of fixture is adjustable with span



Material: Spring Steel  
Finish: nVent CADDY Armour

Part #	Description	
520	24" T-Grid Span	10 pc

No load rating, for positioning only.





## CEILING/ACOUSTICAL Acoustical Lighting Hangers

### FLUORESCENT LIGHT FIXTURE HANGER

- Provides an easy method of supporting an industrial class fluorescent light fixture from S-Hooks and Jack Chain
- Fits most fluorescent light fixtures
- Reduces the need to modify Jack Chain for fixture installation
- No tools required for installation



Material: Steel  
Finish: Plain

Part #	Description		
LFC	Side Mount	50 lb	100 pc
LFC90	Top Mount	50 lb	100 pc

### SEISMIC LIGHTING FIXTURE CLAMP

- Secures fluorescent light fixtures to the ceiling frame members
- Requires no additional chains, cables or slack wires attached to the fixture
- Helps strengthen integrity of the T-Grid system
- Holds in place against the force of standard fire-hose pressure
- Meets U.S. building code and electrical code specifications
- Also satisfies NEC® 410.16(C) positive attachment for secure fastening of luminaires (fixtures) complying with Building Code Reference AC184
- Reusable and cost effective

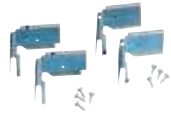

Material: Steel  
Finish: Plain



Part #	Description	
SFCLT	One Standard Tapered 2' x 4' Fixture	25 x 4 pc
SFCLTCF	One 2' x 2' Fixture	50 x 2 pc
SFCLTCFS	Reinforcement of T-Bar Main Runner/Cross Runner Connections	50 x 2 pc
SFCLTE	Two Standard Tapered 2' x 4' Fixtures End-to-End	25 x 2 pc
SFCLTS	Two Standard Tapered 2' x 4' Fixtures Side-by-Side	25 x 2 pc

Tested for compliance to the UBC, NEC®, NBC, and CEC.

## CEILING/ACOUSTICAL

### Adjustable Box Components and Conduit Supports

#### ADJUSTABLE BOX AND CONDUIT SUPPORT

- Supports boxes and conduit above acoustical T-Grid
- Allows attachment of conduit clips with thread impressions at required height
- No tools required for installation



Material: Spring Steel  
Finish: nVent CADDY Armour

Part #	Description	
528	4 1/4"-7 1/4"	50 pc

Additional support wire required per NEC® 300.11. No load rating, for positioning only.

#### T-GRID RIVET TO HANGER ASSEMBLY

- Supports boxes and conduit above acoustical T-Grid
- Allows attachment of conduit clips with thread impressions at required height
- No tools required for installation



Material: Spring Steel  
Finish: nVent CADDY Armour

Part #	Description	
5288P	1/2' EMT	25 pc

Additional support wire required per NEC® 300.11. No load rating, for positioning only. Comes with P-series with THD impression screw assembled to top hole location (adjustable).

## CEILING/ACOUSTICAL

### Adjustable Box Components and Conduit Supports

#### CONDUIT/BOX TO T-GRID SUPPORT

- Provides a method for attaching above acoustical tee bars
- Thread impression hole for direct attachment to an outlet box or conduit clips
- Provides an exact alignment when used in combination with a conduit clip and outlet box, eliminating an offset bend in the conduit



Material: Spring Steel  
Finish: nVent CADDY Armour



Part #	Description	
4ACS	1/4" Hole, Threaded	100 pc

Consult local authority for application approval. Not to be used to hang Tee Grid.

#### T-GRID CLIP, TOP MOUNT

- Clips on acoustical tee bar providing a threaded hole for securing conduit, boxes, or bridle rings
- Eliminates need for offset bending conduit



Material: Spring Steel  
Finish: nVent CADDY Armour

Part #	Description	
ATA4I	1/4" Hole, Threaded	100 pc

No load rating, for positioning only.

## CEILING/ACOUSTICAL

### Adjustable Box Components and Conduit Supports

#### T-GRID CLIP, SIDE MOUNT

- Clips on acoustical tee bar providing a threaded hole for securing conduit, boxes, or bridge rings
- Eliminates need for offset bending conduit



Material: Spring Steel  
Finish: nVent CADDY Armour

Part #	Description	
ATS4I	1/4" Hole, Threaded	100 pc

No load rating, for positioning only. Additional support required per NEC® 300.11.

#### MC/AC CABLE TO T-GRID CLIP

- Manufactured with stabilizer legs for virtually “wobble-free” support
- No tools required for installation
- Compliant with NEC® Article 300.4(d), allowing cable to be positioned a minimum of 1-1/4” from face of stud
- Compliant with CEC Rule 12-618 for support of MC/AC cable



Material: Spring Steel  
Finish: nVent CADDY Armour

Part #	Description	
MAC2ATA	14-2 to 10-3 MC/AC	100 pc

Assemblies allow for support from most main and substructures.

## CEILING/ACOUSTICAL

### Adjustable Box Components and Conduit Supports

#### NM CABLE TO T-GRID CLIP

- Supports non-metallic sheathed cable with ground wire



Material: Spring Steel  
Finish: nVent CADDY Armour



Part #	Description	
RMXATS	14-2, 12-2 NM, 0.28"–0.32" OD	100 pc

Assemblies allow support from most main and substructures.

#### MATA CONDUIT TO T-GRID CLIP

- Provides a method of securing conduit above acoustical tee bar
- No tools required for installation
- Eliminates need for offset bending conduit



Material: Spring Steel  
Finish: nVent CADDY Armour

Part #	Description	
812MATA	1/2", 3/4" EMT, 0.709"–1.181" OD	100 pc
16MATA	1" EMT	100 pc
6MATA	14-2 to 12-3 MC/AC, 0.551" Min, 0.709" Max, 0.552" Nom OD, 3/8" Flexible	100 pc

No load rating, for positioning only. Additional support required per NEC® 300.11.

# CEILING/ACOUSTICAL

## Adjustable Box Components and Conduit Supports

### MATS CONDUIT TO T-GRID CLIP

- Provides a method of securing conduit above acoustical tee bar
- Clip rotates for securing conduit in either horizontal or vertical orientation
- No tools required for installation
- Eliminates need for offset bending conduit



Material: Spring Steel  
Finish: nVent CADDY Armour

Part #	Description	
812MATS	1/2", 3/4" EMT, 0.709"–1.181" OD	100 pc
16MATS	1" EMT	100 pc
6MATS	14-2 to 12-3 MC/AC, 0.551" Min, 0.709" Max, 0.552" Nom OD, 3/8" Flexible	100 pc

No load rating, for positioning only. Additional support required per NEC® 300.11.

### PATA CONDUIT TO T-GRID CLIP

- Provides a method of supporting conduit above acoustical tee bar
- No tools required for installation
- Eliminates need for offset bending conduit



Material: Spring Steel  
Finish: nVent CADDY Armour  
Orientation: Top Mount

Part #	Description	
8PATA	1/2" EMT	100 pc
12PATA	3/4" EMT	100 pc
16PATA	1" EMT	100 pc

No load rating, for positioning only. Additional support required per NEC® 300.11.

## CEILING/ACOUSTICAL

### Adjustable Box Components and Conduit Supports

#### PATS CONDUIT TO T-GRID CLIP

- Provides a method of supporting conduit above acoustical tee bar
- Clip rotates for securing conduit in either horizontal or vertical orientation
- No tools required for installation
- Eliminates need for offset bending conduit



Material: Spring Steel  
Finish: nVent CADDY Armour  
Orientation: Side Mount

Part #	Description	
8PATS	1/2" EMT	100 pc
12PATS	3/4" EMT	100 pc

No load rating, for positioning only. Additional support required per NEC® 300.11.

#### S HOOK

- For suspending chains, perforated bands, and similar items



Material: Steel  
Finish: Plain

Part #	Description		
771	0.12" dia	29 lb	50 pc

# CEILING/ACOUSTICAL

## Chain and Hooks

### JACK CHAIN

- Used to support lighting fixtures



Material: Steel  
Finish: Plain

Part #	Description	 F ↓	
770	Jack Chain	30 lb	100'

### T-GRID FAN/FIXTURE MOUNT

- 2-1/8" electrical box is premounted and centered on bracket and is fully adjustable up to 8" in either direction
- Electrical box has three open knockouts for quick installation
- Each kit includes screws to mount fan, nVent CADDY Speed Link to support from building structure and two Fixture Mount Stabilizer Clips (FMSBC1) to stabilize ceiling tiles



Material: Steel  
Finish: Pregalvanized



Part #	Description	
512HDFM35	Fan/Fixture Mount, 35 lb Working Load	2 pc
512HDFM70	Fan/Fixture Mount, 70 lb Working Load	1 pc



## CEILING/ACOUSTICAL Fan/Fixture Mounts

### TELESCOPING CEILING BRACKET

- Supports fans, fixtures and luminaires from ceilings
- Can also be used in stud wall applications to support sconces and electrical boxes
- Allows for infinite positions for box location
- Easy to adjust after the electrical box is installed
- Installs on wood beams or metal studs
- Requires only a screw gun to install



Material: Steel  
Finish: Pregalvanized



Part #	Description			
TCB	Telescoping Ceiling Bracket	35 lb	50 lb	25 pc

Refer to Static Load 1 when used as a fan support. Refer to Static Load 2 when used as a fixture or luminaire support.

### ELECTRICAL DROP WIRE SECURING CLIP

- Helps prevent sway of dedicated electrical drop wire/rod
- Will not affect ceiling grid systems negatively
- No tools required for installation
- Forgiving design doesn't require exact cutting of rod/wire
- Painted yellow for easy identification by the inspector



Material: Steel  
Finish: Painted

Part #	Description	
EC311	#8 Wire	100 pc

Consult local authority for application approval. Refer to NEC® 300.13.

## CEILING/ACOUSTICAL

### Independent Electrical Drop Wire/Rod Securing Clips

#### ELECTRICAL DROP WIRE/ROD SECURING CLIP

- Helps prevent sway of dedicated electrical drop wire/rod
- Will not affect ceiling grid systems negatively
- No tools required for installation
- Forgiving design doesn't require exact cutting of rod/wire
- Painted yellow for easy identification by the inspector



Material: Steel  
Finish: Painted

Part #	Description	
EC3114Z34	1/4" Rod, #8 Wire	100 pc
EC3116Z34	3/8" Rod	100 pc

Consult local authority for application approval. Refer to NEC® 300.13.

#### PLASTIC ELECTRICAL DROP WIRE SECURING CLIP

- Helps prevent sway of dedicated electrical drop wire/rod
- Will not affect ceiling grid systems negatively
- No tools required for installation
- Forgiving design doesn't require exact cutting of rod/wire
- Yellow plastic for easy identification by the inspector
- Plenum rated



Material: Polypropylene  
Finish: Plain

Part #	Description	
EC311P	1/4" Hole	100 pc

Consult local authority for application approval. Refer to NEC® 300.13.

## CEILING/ACOUSTICAL

### INDEPENDENT SUPPORT CLIP

- Provides a means of independent support of fixtures
- No tools required for installation
- Includes mounting hardware



Material: Spring Steel  
Finish: nVent CADDY Armour



Part #	Description	F ↓	📦	Cert
IDS	15/16" T-Grid, 0.563" Screw, Washer-Wing Nut	65 lb	100 pc	UL
IDS15	15/16" T-Grid, 1.5" Screw, Washer-Wing Nut	65 lb	100 pc	UL
IDS2	15/16" T-Grid, 2" Screw, Washer-Wing Nut	65 lb	100 pc	UL
IDS9	9/16" T-Grid, 0.563" Screw, Washer-Wing Nut	65 lb	100 pc	UL
IDS915	9/16" T-Grid, 1.5" Screw, Washer-Wing Nut	65 lb	100 pc	
IDS95	9/16" T-Grid, 0.563" Screw, Washer-Wing Nut	65 lb	100 pc	UL
IDS95LN	9/16" T-Grid, 0.563" Screw	65 lb	100 pc	
IDS95T	9/16" T-Grid, 0.563" Screw, Pal Nut	65 lb	100 pc	
IDS95TWB	9/16" T-Grid, 0.563" Screw, Brass Barrel Nut	65 lb	100 pc	
IDS9LN	9/16" T-Grid, 0.563" Screw	65 lb	100 pc	
IDS9T	9/16" T-Grid, 0.563" Screw, Pal Nut	65 lb	100 pc	
IDS9TWB	9/16" T-Grid, 0.563" Screw, Brass Barrel Nut	65 lb	100 pc	
IDSLN	15/16" T-Grid, 0.563" Screw	65 lb	100 pc	
IDST	15/16" T-Grid, 0.563" Screw, Pal Nut	65 lb	100 pc	
IDSTWB	15/16" T-Grid, 0.563" Screw, Brass Barrel Nut	65 lb	100 pc	

IDS9 for use with Ultra Line 3500, AWW Ultra Line 3600 (a trademark product of Chicago Metallics Corp.)

# CEILING/ACOUSTICAL Lathers Channel Hangers

## LATHERS CHANNEL CONDUIT CLIP

- No tools required for installation



Material: Steel  
Finish: Plain



Part #	Description	F ↓	📦	Cert
8D15L	1/2" EMT, 1 1/2" Channel	50 lb	100 pc	cULus
12D15L	3/4" EMT, 1 1/2" Channel	50 lb	100 pc	cULus
16D15L	1" EMT, 1 1/2" Channel	50 lb	100 pc	
20D15L	1 1/4" EMT, 1 1/2" Channel	50 lb	100 pc	

Static Load is applicable for installations where conduit hangs below lathers channel.

## LATHERS CHANNEL TO ROD CLIP, CENTER MOUNT

- Provides pre-leveling of channel
- No tools required for installation
- Use with plain rod



Material: Spring Steel  
Finish: nVent CADDY Armour



Part #	Description	F ↓	📦
4B15L	1 1/2' Channel, 1/4" Rod	200 lb	100 pc

## CEILING/ACOUSTICAL Lathers Channel Hangers

### LATHERS CHANNEL TO ROD/WIRE CLIP, SIDE MOUNT

- Provides pre-leveling of channel
- No tools required for installation
- Use with plain rod or wire



Material: Spring Steel  
Finish: nVent CADDY Armour



Part #	Description	F ↓	☐
4B15LS	1 1/2" Channel, 1/4" Rod	200 lb	100 pc
2B15LS	1 1/2" Channel, #8 Wire	160 lb	100 pc
4B2LS	2" Channel, 1/4" Rod	160 lb	100 pc

### LATHERS CHANNEL TO T-GRID CLIP

- Allows 6" drop space providing area for light fixtures
- Installs quickly and easily



Material: Spring Steel  
Finish: nVent CADDY Armour

Part #	Description	F ↓	☐
LTGH	1 1/2" Channel, 1/2"-5/8" Flange	100 lb	100 pc

# CEILING/ACOUSTICAL Lathers Channel Hangers

## LATHERS CHANNEL BOX MOUNT

- Provides attachment of conduit and outlet boxes directly to lathers channel with furnished screw
- Can be applied to the top or bottom flange of the channel
- Eliminates offset bending conduit



Material: Spring Steel  
Finish: nVent CADDY Armour

Part #	Description	
4LCB	5/8" Max Flange Width, 3/4", 1 1/2", 2" Channel	100 pc

## SUPPORT BOX FROM LATHERS CHANNEL

- Provides a convenient method of supporting an electrical box from lathers channel
- "One piece/two piece" construction helps prevent dropping of loose parts
- Built-in thread impressions eliminate the need for nuts
- Multiple pre-punched holes allow for box height adjustability
- Screw and nut are provided



Material: Steel  
Finish: Pregalvanized

Part #	Description	
LCSB12	3/4", 1 1/2", 2" Channel	50 pc

No load rating, for positioning only.

## CEILING/ACOUSTICAL

### T-Grid Box Hangers

#### T-GRID BOX HANGER

- Dual height feature permits 1-1/2" (38 mm) deep electrical box to be mounted flush with tile or offset 3/4" (19 mm) for plaster ring
- Allows 2-1/8" (54 mm) deep electrical box to be mounted flush with tile
- Snaps easily onto T-Grid
- Hanger comes complete with box mounting clip and screw



Material: Steel, Spring Steel  
Finish: Pregalvanized, nVent CADDY Armour



Part #	Description	F ↓		Cert
51212	12" T-Grid Span	20 lb	50 pc	cULus
51220	20" T-Grid Span	20 lb	50 pc	
512	24" T-Grid Span	20 lb	50 pc	
512TC (Canada Only)	24" T-Grid Span	20 lb	50 pc	
51230	30" T-Grid Span	20 lb	50 pc	

Not to exceed static load without independent wire support to box mounting clip.  
Not permitted for paddle fans.

#### ADJUSTABLE T-GRID BOX HANGER

- Adjustable height allows installation of double deep boxes, speaker cases and emergency light fixtures above T-Grid
- Snaps easily onto T-Grid
- Hanger comes complete with box mounting clip and screw



Material: Steel, Spring Steel  
Finish: Pregalvanized, nVent CADDY Armour

Part #	Description	F ↓	
51220A	20" T-Grid Span	20 lb	50 pc
512A	24" T-Grid Span	20 lb	50 pc
512ATC (Canada Only)	24" T-Grid Span	20 lb	50 pc

Not to exceed static load without independent wire support to box mounting clip.  
Not permitted for paddle fans.

# CEILING/ACOUSTICAL T-Grid Box Hangers



## HEAVY DUTY T-GRID BOX HANGER

- Quickly mounts a box to T-grid
- Adjustable height for various electrical box depths
- Mounts flush with face of tile
- Installs by hand
- Drop wire for independent support from clip and/or bar
- Screws easily to tee bar for added stability
- Supports multiple box installations



Material: Steel, Spring Steel  
Finish: Pregalvanized, nVent CADDY Armour



Part #	Description		
512HD	Includes Mounting Clip	50 lb	25 pc
512HDTC (Canada Only)	Includes Mounting Clip	50 lb	25 pc
512HDEEP	Includes Mounting Clip, Extension Bracket	50 lb	25 pc
512HDEEPTC (Canada Only)	Includes Mounting Clip, Extension Bracket	50 lb	25 pc

Standard bar mounts 2 1/8" box. Break off tabs for 1 1/2" deep box. Mounts flush with face of tile. 512HDEEP Series with additional 512HDXT mounts 2 1/8" deep box with 1 1/2" extension ring. Not permitted for paddle fans.

## MOUNTING CLIP FOR T-GRID BOX HANGER WITH SCREW

- Provides secure attachment of electrical boxes to T-Grid Box Hangers



Material: Spring Steel  
Finish: nVent CADDY Armour



Part #	Description	
BHC	1/4" Screw	100 pc



## CEILING/ACOUSTICAL

### T-Grid Box Hangers

#### MOUNTING CLIP FOR T-GRID BOX HANGER

- Attaches to 512 T-Grid Box Hanger to secure electrical box



Material: Spring Steel  
Finish: nVent CADDY Armour

Part #	Description	
CHB	Mounting Clip for T-Grid Box Hanger	100 pc
CHBTC (Canada Only)	Mounting Clip for T-Grid Box Hanger	100 pc

#### MOUNTING CLIP SCREW FOR T-GRID BOX HANGER



Material: Steel  
Finish: Black Oxide

Part #	Description	
S102438BP50	#10 Screw	50 pc

#### EXTENSION BRACKET FOR HEAVY DUTY T-GRID BOX HANGER

- Attaches to T-Grid Box Hanger to accommodate double deep boxes
- Tall grid compatible
- Installs by hand



Material: Steel  
Finish: Pregalvanized



Part #	Description	
512HDXT	3 5/8"	50 pc

# CEILING/ACOUSTICAL T-Grid Box Hangers

## MOUNTING CLIP FOR HEAVY DUTY T-GRID BOX HANGER

- Attaches electrical box to 512HD Heavy Duty T-Grid Box Hanger
- Installs by hand



Material: Spring Steel  
Finish: nVent CADDY Armour



Part #	Description	
510HD	CADDY ARMOUR	100 pc
510HDTC (Canada Only)	CADDY ARMOUR	100 pc

## FIXTURE MOUNT STABILIZER CLIP

- Levels signage
- Secures ceiling tile during installation of trim rings
- Helps eliminate bulges in ceiling tiles
- Works with square or hex-shaped electrical boxes
- Can be used on boxes with or without plaster rings
- No installation tools required
- Easy to adjust and maintains shape after installation



Material: Steel  
Finish: Plain

Part #	Description	
FMSBC1	Fixture Mount Stabilizer Clip	100 pc

## CEILING/ACOUSTICAL

### T-GRID MOUNTING CLIP FOR HEAVY DUTY TELESCOPING BOX BRACKET

- For use with Heavy Duty Telescoping Box Bracket (TB1624HD) and Box Mounting Plate (TB45P) to install electrical boxes between T-grid
- Snap-on design eliminates the need for attachment screw to T-grid
- Boxes can be easily positioned between T-grid by sliding across TB1624HD
- Accommodates ceiling tile up to 1-1/4" thick
- Clip snaps onto TB1624HD and fastens with one screw (not included)



See page 4-7 for the Heavy Duty Telescoping Box Bracket

Material: Spring Steel  
Finish: Electrogalvanized



Part #	Description	
TBTG	T-grid mounting clip for TB1624HD	50 pc

Not to be used for fixture/luminaire or fan support per UL 514A.

### T-GRID PERIMETER CLIP

- Attaches T-Grid to edge trim without riveting
- Can be used to accommodate partial tiles
- Clip is easily repositioned along T-Grid or edge trim

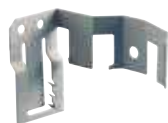

Material: Spring Steel  
Finish: nVent CADDY Armour

Part #	Description	
TGE	T-Grid Perimeter Clip	100 pc

# CEILING/ACOUSTICAL T-Grid Twist Clips

## 4G16 TWIST CLIP

- Fast, easy and secure twist-on installation
- No special tools required



Material: Spring Steel  
Finish: nVent CADDY Armour

Part #	Description	F ↓	☐
4G16LS	15/16" T-Grid	50 lb	100 pc

## 4G16 TWIST CLIP WITH STUD

- Supports electrical fixtures from acoustical T-grid
- No tools required for installation
- Fast, easy and secure twist-on installation
- Nut sold separately



Material: Spring Steel, Steel  
Finish: nVent CADDY Armour

Part #	Description	F ↓	☐
4G16LN	CADDY ARMOUR, 15/16" T-Grid, 1/4" Screw, 0.563" Screw	50 lb	100 pc

## CEILING/ACOUSTICAL T-Grid Twist Clips

### 4G16 TWIST CLIP WITH WING NUT

- Supports electrical fixtures from acoustical T-grid
- No tools required for installation
- Fast, easy and secure twist-on installation
- Wing nut included



Material: Spring Steel

Part #	Description	F ↓	☐	Cert
Finish: nVent CADDY Armour				
4G16	0.563" Screw	50 lb	100 pc	UL
4G162	2" Screw	50 lb	100 pc	UL
Finish: Painted – Color: White				
4G16WH	0.563" Screw	50 lb	100 pc	
4G162WH	2" Screw	50 lb	100 pc	

### 4G16H TWIST CLIP WITH 90° PLAIN HOLE

- Provides an attachment for nVent CADDY Speed Link assemblies, wire, S-hooks, or chain from T-Grid
- Fast, easy and secure twist-on installation
- No tools required for installation



Material: Spring Steel

Part #	Description	F ↓	☐
Finish: nVent CADDY Armour – Color: Gray			
4G16H	CADDY ARMOUR, , 1/4" Hole, 1/16" Max Flange, 15/16" T-Grid	40 lb	100 pc
Finish: Painted – Color: White			
4G16HWH	1/4" Hole, 1/16" Max Flange, 15/16" T-Grid	40 lb	100 pc

# CEILING/ACOUSTICAL

## T-Grid Twist Clips

### 4G24 TWIST CLIP WITH WING NUT, WIDE GRID

- Supports electrical fixtures from acoustical T-grid
- No tools required for installation
- Fast, easy and secure twist-on installation
- Wing nut included



Material: Spring Steel  
Finish: nVent CADDY Armour  
Color: Gray

Part #	Description	F ↓	☐
4G24	5/8" Screw	40 lb	100 pc

### 4G9 TWIST CLIP

- Fast, easy and secure twist-on installation
- No special tools required



Material: Spring Steel  
Finish: nVent CADDY Armour

Part #	Description	F ↓	☐
4G9LS	9/16" T-Grid, 1/4" Hole	40 lb	100 pc

### 4G9 TWIST CLIP WITH WING NUT, NARROW GRID

- Fast, easy and secure twist-on installation
- No special tools required
- Wing nut included



Material: Spring Steel  
Finish: nVent CADDY Armour



Part #	Description	F ↓	☐
4G9	9/16" T-Grid, 1/4" Screw, 5/8" Screw	40 lb	100 pc

## CEILING/ACOUSTICAL T-Grid Twist Clips

### 4G8 TWIST CLIP FOR TRACK LIGHTING

- Fast, easy and secure twist-on installation
- No special tools required



Material: Spring Steel, Steel



Part #	Description	F ↓	📦	Cert
Finish: nVent CADDY Armour				
4G8S7	CADDY ARMOUR, 15/16" T-Grid, #8 Screw, 7/16" Screw, Pal Nut	25 lb	100 pc	UL
4G8WB	CADDY ARMOUR, 15/16" T-Grid, #8 Screw, 5/8" Screw, Brass Barrel Nut	25 lb	100 pc	
4G8	CADDY ARMOUR, 15/16" T-Grid, #8 Screw, 5/8" Screw, Pal Nut	25 lb	100 pc	UL
Finish: Painted — Color: White				
4G8S7WH	15/16" T-Grid, #8 Screw, 7/16" Screw, Pal Nut	25 lb	100 pc	UL
4G8WHWB	15/16" T-Grid, #8 Screw, 5/8" Screw, Brass Barrel Nut	25 lb	100 pc	
4G8WH	15/16" T-Grid, #8 Screw, 5/8" Screw, Pal Nut	25 lb	100 pc	UL

### 2G9 TWIST CLIP FOR TRACK LIGHTING, NARROW GRID

- Fast, easy and secure twist-on installation
- No special tools required



Material: Spring Steel, Steel  
Finish: nVent CADDY Armour



Part #	Description	F ↓	📦	Cert
2G9WB	7/16" Screw, Brass Barrel Nut	25 lb	100 pc	
2G9	7/16" Screw, Pal Nut	25 lb	100 pc	UL
2G9S10WB	5/8" Screw, Brass Barrel Nut	25 lb	100 pc	
2G9S10	5/8" Screw, Pal Nut	25 lb	100 pc	UL

# CEILING/ACOUSTICAL T-Grid Twist Clips

## PT16 TWIST CLIP FOR WALL PARTITION

- Fast, easy and secure twist-on installation
- No special tools required
- Designed to reduce scratching of T-grid



Material: Spring Steel, Steel  
Finish: nVent CADDY Armour

Part #	Description	F ↓	↓ Cube
PT16LN	3/4" Screw	50 lb	100 pc

## PT16 TWIST CLIP FOR WALL PARTITION WITH WING NUT

- Fast, easy and secure twist-on installation
- No special tools required
- Designed to reduce scratching of T-grid



Material: Spring Steel, Steel

Part #	Description	F ↓	↓ Cube
Finish: nVent CADDY Armour			
PT16	CADDY ARMOUR, 3/4" Screw	50 lb	100 pc
Finish: nVent CADDY Armour, Felt-Lined			
PT16FP	CADDY ARMOUR, , 3/4" Screw	50 lb	100 pc



## CEILING/ACOUSTICAL T-Grid Twist Clips

### TWIST CLIP SPACER FOR RECESSED T-GRID

- Provides a mounting surface level with recessed grid systems
- No tools required for installation
- For use with studded Twist Clips



Material: Spring Steel  
Finish: nVent CADDY Armour

Part #	Description	
4TGS	1/4" Hole	100 pc

### WING NUT FOR TWIST CLIPS

- Large diameter allows the use of knock-outs as mounting points
- Combination wing nut and washer



Material: Spring Steel  
Finish: nVent CADDY Armour

Part #	Description		
4WN	1/4" Hole, Threaded	100 lb	100 pc

When using with other fasteners refer to the lowest load rating.

### PLASTIC SPACER FOR PT16 TWIST CLIP

- Spacer for use with recessed grid systems
- Ensures recessed grid systems remain flush when surface mounting fixtures



Material: Acrylonitrile Butadiene Styrene

Part #	Description	
PT16SPCR	15/16" T-Grid	100 pc

# (Mechanical) Pipe and Tube Fixings



## MECHANICAL

### Pipe/Tube to Strut

#### USC UNIVERSAL STRUT CLAMP FOR PIPE/CONDUIT

- Consists of two clamps, nut and bolt
- Fits into open side of strut channel
- Conforms with Manufacturers Standardization Society (MSS) SP-58 (Type 59)





Material: Steel

Part #	Description	F	
Finish: Electrogalvanized			
USC006EG	EG, 0.25" OD	450 lb	100 pc
USC010EG	EG, 0.38" OD	450 lb	100 pc
USC013EG	EG, 0.5"-0.54" OD	450 lb	100 pc
USC016EG	EG, 0.58"-0.63" OD, 3/8" EMT	450 lb	100 pc
USC017EG	EG, 0.65"-0.7" OD, 3/8" Pipe	450 lb	100 pc
USC020EG	EG, 0.71"-0.79" OD, 1/2" EMT	450 lb	100 pc
USC021EG	EG, 0.81"-0.84" OD, 1/2" Pipe	450 lb	100 pc
USC022EG	EG, 0.85"-0.88" OD	450 lb	100 pc
USC025EG	EG, 0.92"-1" OD, 3/4" EMT	450 lb	100 pc
USC026EG	EG, 1"-1.06" OD, 3/4" Pipe	450 lb	100 pc
USC028EG	EG, 1.1"-1.14" OD	450 lb	100 pc
USC031EG	EG, 1.16"-1.26" OD, 1" EMT	450 lb	100 pc
USC033EG	EG, 1.29"-1.32" OD, 1" Pipe	450 lb	50 pc
USC036EG	EG, 1.33"-1.5" OD	600 lb	50 pc
USC040EG	EG, 1.51"-1.6" OD, 1 1/4" EMT	600 lb	50 pc
USC042EG	EG, 1.63"-1.67" OD, 1 1/4" Pipe	600 lb	50 pc
USC046EG	EG, 1.69"-1.77" OD, 1 1/2" EMT	600 lb	50 pc
USC048EG	EG, 1.87"-1.97" OD, 1 1/2" Pipe	600 lb	50 pc
USC053EG	EG, 1.98"-2.11" OD	850 lb	50 pc
USC054EG	EG, 2.12"-2.17" OD	850 lb	50 pc
USC058EG	EG, 2.2"-2.25" OD, 2" EMT	850 lb	50 pc
USC060EG	EG, 2.34"-2.45" OD, 2" Pipe	850 lb	50 pc
USC063EG	EG, 2.45"-2.54" OD	850 lb	50 pc
USC068EG	EG, 2.6"-2.72" OD	850 lb	50 pc
USC073EG	EG, 2.75"-2.88" OD, 2 1/2" Pipe, 2 1/2" EMT	850 lb	50 pc
USC076EG	EG, 2.96"-3" OD	850 lb	25 pc
USC080EG	EG, 3.04"-3.25" OD	850 lb	25 pc
USC086EG	EG, 3.31"-3.5" OD, 3" Pipe, 3" EMT	850 lb	25 pc
USC093EG	EG, 3.54"-3.75" OD	850 lb	25 pc
USC101EG	EG, 3.87"-4.04" OD, 3 1/2" Pipe, 3 1/2" EMT	850 lb	25 pc
USC107EG	EG, 4.1"-4.33" OD	850 lb	25 pc

# MECHANICAL

## Pipe/Tube to Strut

Part #	Description		
USC113EG	EG, 4.37"–4.54" OD, 4" Pipe, 4" EMT	850 lb	25 pc
USC121EG	EG, 4.63"–4.87" OD	850 lb	25 pc
USC129EG	EG, 5"–5.13" OD	850 lb	25 pc
USC135EG	EG, 5.25"–5.37" OD	850 lb	25 pc
USC143EG	EG, 5.5"–5.75" OD, 5" Pipe	900 lb	25 pc
USC152EG	EG, 5.87"–6.1" OD	900 lb	25 pc
USC159EG	EG, 6.13"–6.38" OD	900 lb	25 pc
USC168EG	EG, 6.5"–6.75" OD, 6" Pipe	900 lb	25 pc
USC178EG	EG, 6.87"–7.13" OD	900 lb	25 pc
USC191EG	EG, 7.5" OD	900 lb	25 pc
USC200EG	EG, 7.75"–8" OD	900 lb	25 pc
USC208EG	EG, 8.04"–8.37" OD	900 lb	25 pc
USC218EG	EG, 8.5"–8.63" OD, 8" Pipe	900 lb	25 pc
USC228EG	EG, 8.86"–9.1" OD	900 lb	25 pc
USC254EG	EG, 9.84"–10.13" OD	900 lb	25 pc
USC277EG	EG, 10.7"–11.02" OD, 10" Pipe	900 lb	25 pc
USC324EG	EG, 12.75" OD, 12" Pipe	900 lb	25 pc
USC400EG	EG, 15.75" OD	900 lb	25 pc
<b>Finish: Hot-Dip Galvanized</b>			
USC017HD	HD, 0.65"–0.7" OD, 3/8" Pipe	450 lb	100 pc
USC020HD	HD, 0.71"–0.79" OD, 1/2" EMT	450 lb	100 pc
USC021HD	HD, 0.81"–0.84" OD, 1/2" Pipe	450 lb	100 pc
USC026HD	HD, 1"–1.06" OD, 3/4" Pipe	450 lb	100 pc
USC031HD	HD, 1.16"–1.26" OD, 1" EMT	450 lb	100 pc
USC033HD	HD, 1.29"–1.32" OD, 1" Pipe	450 lb	100 pc
USC040HD	HD, 1.51"–1.6" OD, 1 1/4" EMT	600 lb	50 pc
USC042HD	HD, 1.63"–1.67" OD, 1 1/4" Pipe	600 lb	50 pc
USC046HD	HD, 1.69"–1.77" OD, 1 1/2" EMT	600 lb	50 pc
USC048HD	HD, 1.87"–1.97" OD, 1 1/2" Pipe	600 lb	50 pc
USC054HD	HD, 2.12"–2.17" OD	850 lb	50 pc
USC058HD	HD, 2.2"–2.25" OD, 2" EMT	850 lb	50 pc
USC060HD	HD, 2.34"–2.45" OD, 2" Pipe	850 lb	50 pc
USC073HD	HD, 2.75"–2.88" OD, 2 1/2" Pipe, 2 1/2" EMT	850 lb	50 pc
USC086HD	HD, 3.31"–3.5" OD, 3" Pipe, 3" EMT	850 lb	25 pc
USC101HD	HD, 3.87"–4.04" OD, 3 1/2" Pipe, 3 1/2" EMT	850 lb	25 pc
USC113HD	HD, 4.37"–4.54" OD, 4" Pipe, 4" EMT	850 lb	25 pc
USC143HD	HD, 5.5"–5.75" OD, 5" Pipe	900 lb	25 pc
USC168HD	HD, 6.5"–6.75" OD, 6" Pipe	900 lb	25 pc
USC218HD	HD, 8.5"–8.63" OD, 8" Pipe	900 lb	25 pc
USC277HD	HD, 10.7"–11.02" OD, 10" Pipe	900 lb	25 pc
USC324HD	HD, 12.75" OD, 12" Pipe	900 lb	25 pc

## MECHANICAL

### Pipe/Tube to Strut

#### RIGD SINGLE PIECE STRUT CLAMP FOR PIPE/RIGID CONDUIT

- One piece break apart strut clamp (1/2" thru 4" pipe size)
- Includes thread impression and captured screw (1/2" thru 4" pipe size)
- Fits into open side of strut channel
- Conforms with Manufacturers Standardization Society (MSS) SP-58 (Type 59)



Part #	Description	F ↓	☐
Material: Stainless Steel 304 (EN 1.4301)			
RIGD0050S4	S304, 1/2" Pipe, 0.84" OD	400 lb	100 pc
RIGD0075S4	S304, 3/4" Pipe, 1.05" OD	600 lb	100 pc
RIGD0100S4	S304, 1" Pipe, 1.315" OD	600 lb	100 pc
RIGD0125S4	S304, 1 1/4" Pipe, 1.66" OD	600 lb	50 pc
RIGD0150S4	S304, 1 1/2" Pipe, 1.9" OD	800 lb	50 pc
RIGD0200S4	S304, 2" Pipe, 2.375" OD	800 lb	50 pc
RIGD0250S4	S304, 2 1/2" Pipe, 2.875" OD	800 lb	25 pc
RIGD0300S4	S304, 3" Pipe, 3.5" OD	800 lb	25 pc
RIGD0400S4	S304, 4" Pipe, 4.5" OD	1,000 lb	25 pc
Material: Steel – Finish: Electrogalvanized			
RIGD0050EG	EG, 1/2" Pipe, 0.84" OD	400 lb	100 pc
RIGD0075EG	EG, 3/4" Pipe, 1.05" OD	600 lb	100 pc
RIGD0100EG	EG, 1" Pipe, 1.315" OD	600 lb	100 pc
RIGD0125EG	EG, 1 1/4" Pipe, 1.66" OD	600 lb	50 pc
RIGD0150EG	EG, 1 1/2" Pipe, 1.9" OD	800 lb	50 pc
RIGD0200EG	EG, 2" Pipe, 2.375" OD	800 lb	50 pc
RIGD0250EG	EG, 2 1/2" Pipe, 2.875" OD	800 lb	25 pc
RIGD0300EG	EG, 3" Pipe, 3.5" OD	800 lb	25 pc
RIGD0350EG	EG, 3 1/2" Pipe, 4" OD	1,000 lb	25 pc
RIGD0400EG	EG, 4" Pipe, 4.5" OD	1,000 lb	25 pc

# MECHANICAL

## Pipe/Tube to Strut

### NVENT CADDY SUPERKLIP

- Closes and locks automatically when the pipe, tube or cable is inserted
- One-piece clamp for fast and convenient installation
- Fasten with either wood screw, dual threaded screw with or without collar, nail with collar, threaded rod, mounting plate or shot-fire bracket



Material: Xenoy®  
 Temperature: -13 to 194 °F

Part #	Description	F ↓	📦
389017	0.31"–0.37" OD, 1/4" Copper Tube	30 lb	100 pc
389018	0.37"–0.46" OD, 1/4" Copper Tube	33 lb	100 pc
389001	0.46"–0.56" OD, 3/8" Copper Tube	35 lb	100 pc
389002	0.56"–0.66" OD, 1/2" Copper Tube	40 lb	100 pc
389003	0.66"–0.77" OD, 3/8" Rigid, 3/8" Pipe, 5/8" Copper Tube	43 lb	100 pc
389004	0.77"–0.86" OD, 1/2" Rigid, 1/2" Pipe	50 lb	100 pc
389005	0.86"–0.98" OD, 3/4" Copper Tube	48 lb	100 pc
389006	0.98"–1.09" OD, 3/4" Rigid, 3/4" Pipe	54 lb	50 pc
389007	1.09"–1.23" OD, 1" Copper Tube	58 lb	50 pc
389008	1.23"–1.4" OD, 1" Rigid, 1" Pipe, 1 1/4" Copper Tube	67 lb	50 pc
389009	1.4"–1.56" OD, 1 1/4" Copper Tube	72 lb	50 pc
389011	1.56"–1.71" OD, 1 1/4" Rigid, 1 1/4" Pipe, 1 1/2" Copper Tube	80 lb	25 pc
389012	1.83"–2" OD, 1 1/2" Rigid, 1 1/2" Pipe	84 lb	25 pc
389013	2"–2.19" OD, 2" Copper Tube	90 lb	25 pc
389014	2.3"–2.52" OD, 2" Rigid, 2" Pipe	92 lb	25 pc

### NVENT CADDY SUPERKLIP BP1 BASE PLATE FOR TWO CLIPS

- Mounting plate accepts two SUPERKLIP clamps with outer diameters up to 1" (25 mm)



Material: Xenoy®

Part #	Description	📦
389015	3/16" Hole	50 pc

# MECHANICAL

## Pipe Fixings

### NVENT CADDY SUPERKLIP CA CONCRETE ATTACHMENT

- Steel clip which fits in the side of the nVent CADDY Superklip
- Steel clip can be shot fired to concrete or steel



Material: Steel  
Finish: Electrogalvanized

Part #	Description	
389071	3/16" Hole	100 pc

### NVENT CADDY SUPERKLIP IN INSERT NUT

- Steel channel nut fits in the side of the nVent CADDY Superklip



Material: Steel  
Finish: Electrogalvanized

Part #	Description	
389069	1/4" Rod	100 pc

# MECHANICAL

## Pipe Fixings

### nVENT CADDY SWIFT CLIP THREADED ROD ATTACHMENT

- Snap-on and twist installation requires no tools
- Easily adjusts by rotating up or down on the threaded rod
- For support and positioning of refrigeration, A/C tubing, PEX piping, conduit and cabling
- Secures pipe and insulation without any breaks
- Compliant with UL® 2043 and suitable for use in air handling (plenum) spaces



Material: Polyamide

Working Temperature: -40 to 284 °F

Part #	Description	
TRC062	5/8" OD, 1/2" Copper Tube, 3/8" Rod	25 pc
TRC075	3/4" OD, 5/8" Copper Tube, 3/8" Rod	25 pc
TRC087	7/8" OD, 3/4" Copper Tube, 1/2" Pipe, 3/8" Rod	25 pc
TRC100	1" OD, 3/4" Pipe, 3/8" Rod	25 pc
TRC112	1 1/8" OD, 1" Copper Tube, 3/8" Rod	25 pc
TRC125	1 1/4" OD, 1" Pipe, 3/8" Rod	25 pc
TRC137	1 3/8" OD, 1 1/4" Copper Tube, 3/8" Rod	25 pc
TRC150	1 1/2" OD, 3/8" Rod	25 pc
TRC162	1 5/8" OD, 1 1/2" Copper Tube, 3/8" Rod	25 pc
TRC200	2" OD, 3/8" Rod	25 pc
TRC212	2 1/8" OD, 2" Copper Tube, 3/8" Rod	25 pc

Clip must be installed with temperature at or above 14 °F (-10 °C).

### TPC TUBE AND PIPE CLAMP

- Positions pipe or tube in stud wall applications
- Flexible clamping design accommodates multiple supply line sizes using one clamp
- May be used with the nVent CADDY Telescoping Screw Gun Bracket (TSGB) for an adjustable pipe bracket and clamping system



Material: Nylon

Part #	Description	
TPC112	3/8"–1 1/8" OD	100 pc
TPC238	5/8"–2 3/8" OD	50 pc



## MECHANICAL

### Pipe Fixings

#### ONE HOLE STRAP FOR PIPE AND CONDUIT

- Recommended for supporting horizontal runs of piping from the face of a structural member
- Fastening hole in strap may be above or below pipe



Material: Steel  
Finish: Pregalvanized

Part #	Description	
0070037EG	0.675" OD, 3/8" Rigid, 3/8" Pipe	100 pc
0070050EG	0.84" OD, 1/2" Rigid, 1/2" Pipe	100 pc
0070075EG	1.05" OD, 3/4" Rigid, 3/4" Pipe	100 pc
0070100EG	1.315" OD, 1" Rigid, 1" Pipe	100 pc
0070125EG	1.66" OD, 1 1/4" Rigid, 1 1/4" Pipe	100 pc
0070150EG	1.9" OD, 1 1/2" Rigid, 1 1/2" Pipe	100 pc
0070200EG	2.375" OD, 2" Rigid, 2" Pipe	50 pc

# nVent CADDY Pyramid



# NVENT CADDY PYRAMID ROOFTOP SYSTEMS

## nVent CADDY Pyramid ST Strut-Based Supports

### NVENT CADDY PYRAMID ST FIXED STRUT SUPPORT

- Provides superior support for pipe, conduit, duct, cable tray and equipment
- Foam bottom offers low abrasion interface for better roof membrane protection
- Compatible with roof surfaces including single ply, bituminous, metal and spray foam
- Provides superior load distribution, even with varying rooftop surfaces
- Ready to use out of the box, saving installation time and labor
- Multiple sizes and load ratings offer the ability to tailor the solution to the application
- Easy to transport to the roof
- Hot-dip galvanized and UV stabilized for long lasting performance
- Supports green building requirements; thermoplastic bases are made from recycled material and can contribute to earning LEED credits



Material: Polyethylene, Polypropylene, Steel  
Finish: Hot-Dip Galvanized  
Temperature: -50 to 150 °F  
Static Load Safety Factor: 3:1

Part #	Description	F ↓	📦
PSF6C	6" x 4.8"	300 lb	20 pc
PSF10C	10" x 4.8"	1,000 lb	10 pc
PSF10D	10" x 6.4"	1,000 lb	5 pc
PSF16C	16" x 4.8"	1,500 lb	5 pc
PSF16D	16" x 6.4"	1,500 lb	5 pc

Static load at 73.1 kPa (10.6 psi) roof loading. Contact project or roofing engineer for maximum allowable load on individual project roof system.

# NVENT CADDY PYRAMID ROOFTOP SYSTEMS

## nVent CADDY Pyramid ST Strut-Based Supports

### NVENT CADDY PYRAMID ST ADJUSTABLE STRUT SUPPORT

- Height adjustability provides effective navigation of pipe, conduit, duct and cable tray around obstructions
- Foam bottom offers low abrasion interface for better roof membrane protection
- Compatible with roof surfaces including single ply, bituminous, metal and spray foam
- Provides superior load distribution, even with varying rooftop surfaces
- Ready to use out of the box, saving installation time and labor
- Multiple sizes and load ratings offer the ability to tailor the solution to the application
- Hot-dip galvanized and UV stabilized for long lasting performance
- Supports green building requirements; thermoplastic bases are made from recycled material and can contribute to earning LEED credits



Material: Polyethylene, Polypropylene, Steel  
 Finish: Hot-Dip Galvanized  
 Temperature: -50 to 150 °F  
 Static Load Safety Factor: 3:1

Part #	Description	F ↓	↓ Cube
PSA10CH13	10" x 6"-13"	1,000 lb	5 pc
PSA16AH18	16" x 7"-18"	1,500 lb	5 pc

# NVENT CADDY PYRAMID ROOFTOP SYSTEMS

## nVent CADDY Pyramid ST Strut-Based Supports

### NVENT CADDY PYRAMID ST BRIDGE ASSEMBLY

- Ideal for supporting multiple pipe runs, cable tray and air handling units
- Foam bottom offers low abrasion interface for better roof membrane protection
- Compatible with roof surfaces including single ply, bituminous, metal and spray foam
- Provides superior load distribution, even with varying rooftop surfaces
- Ready to use out of the box, saving installation time and labor
- Multiple sizes and load ratings offer the ability to tailor the solution to the application
- Hot-dip galvanized and UV stabilized for long lasting performance
- Supports green building requirements; thermoplastic bases are made from recycled material and can contribute to earning LEED credits



Material: Polyethylene, Polypropylene, Steel  
Finish: Hot-Dip Galvanized  
Temperature: -50 to 150 °F  
Static Load Safety Factor: 3:1

Part #	Description	F ↓	📦
PSB24A	24"	2,000 lb	2 pc
PSB30A	30"	2,000 lb	2 pc
PSB36A	36"	2,000 lb	2 pc
PSB42A	42"	3,000 lb	2 pc
PSB48A	48"	3,000 lb	2 pc
PSB60A	60"	3,000 lb	2 pc

Static loads are assumed to be uniformly distributed.

# NVENT CADDY PYRAMID ROOFTOP SYSTEMS



## nVent CADDY Pyramid RL Roller-Based Supports

### NVENT CADDY PYRAMID RL FIXED ROLLER SUPPORT

- Roller-based support designed specifically for rooftop applications
- Roller capability allows longitudinal movement of pipe, resulting from thermal expansion or contraction
- Polymeric rollers ensure corrosion free rotation
- Foam bottom offers low abrasion interface for better roof membrane protection
- Compatible with roof surfaces including single ply, bituminous, metal and spray foam
- Ready to use out of the box, saving installation time and labor
- Hot-dip galvanized and UV stabilized for long lasting performance
- Supports green building requirements; thermoplastic bases are made from recycled material and can contribute to earning LEED credits



Material: Polyethylene, Polypropylene, Steel  
 Finish: Hot-Dip Galvanized  
 Temperature: -50 to 150 °F  
 Static Load Safety Factor: 3:1

Part #	Description		
PRF2	2" Max Pipe	100 lb	20 pc
PRF3	3" Max Pipe	250 lb	5 pc
PRF6	6" Max Pipe	600 lb	5 pc

# NVENT CADDY PYRAMID ROOFTOP SYSTEMS

## nVent CADDY Pyramid RL Roller-Based Supports

### NVENT CADDY PYRAMID RL ADJUSTABLE ROLLER SUPPORT

- Height-adjustable roller-based support designed specifically for rooftop applications
- Height adjustability allows for effective navigation of pipe around obstructions
- Polymeric rollers ensure corrosion free rotation
- Foam bottom offers low abrasion interface for better roof membrane protection
- Compatible with roof surfaces including single ply, bituminous, metal and spray foam
- Ready to use out of the box, saving installation time and labor
- Hot-dip galvanized and UV stabilized for long lasting performance
- Supports green building requirements; thermoplastic bases are made from recycled material and can contribute to earning LEED credits



Material: Polyethylene, Polypropylene, Steel

Finish: Hot-Dip Galvanized

Temperature: -50 to 150 °F

Static Load Safety Factor: 3:1

Part #	Description	F ↓	☐
PRA3H12	3" Max Pipe, 6"-12"	250 lb	5 pc
PRA6H16	6" Max Pipe, 6 1/2"-16"	600 lb	5 pc

### RETAINER STRAP

- Prevents pipe from being dislodged from roller supports
- Innovative twist-lock design allows for easy installation without requiring hardware removal



Material: Steel

Finish: Hot-Dip Galvanized

Part #	Description	☐
PRS2	2" Max Pipe	25 pc
PRS3	3" Max Pipe	25 pc
PRS6	6" Max Pipe	25 pc

Retainer straps must be used with roller supports that have an equivalent pipe size.

# NVENT CADDY PYRAMID ROOFTOP SYSTEMS



## nVent CADDY Pyramid H-Frame

### NVENT CADDY PYRAMID H-FRAME POST BASE

- Foam or rubber bottom offers low abrasion interface for better roof membrane protection
- Compatible with roof surfaces including single ply, bituminous, metal and spray foam
- Provides superior load distribution, even with varying rooftop surfaces
- Rubber rooftop interface ideal for solar panel array installations
- Mounting hardware pre-installed in bases
- Hot-dip galvanized and UV stabilized for long lasting performance
- Accepts standard strut channels
- Supports green building requirements; thermoplastic bases are made from recycled material and can contribute to earning LEED credits



Material: Steel, Polypropylene, Polyethylene  
Finish: Hot-Dip Galvanized  
Temperature: -30 to 130 °F  
Static Load Safety Factor: 3:1

Part #	Description		
PHB	Foam	750 lb	1 pc
PHBR	Rubber	750 lb	1 pc



# NVENT CADDY PYRAMID ROOFTOP SYSTEMS

## nVent CADDY Pyramid H-Frame

### NVENT CADDY PYRAMID H-FRAME KIT

- Foam or rubber bottom offers low abrasion interface for better roof membrane protection
- Compatible with roof surfaces including single ply, bituminous, metal and spray foam
- Provides superior load distribution, even with varying rooftop surfaces
- Rubber rooftop interface ideal for solar panel array installations
- Kit includes 2 post bases with pre-installed mounting hardware, 6 bolts, 6 strut nuts, and 2 L-brackets to complete H-frame
- Hot-dip galvanized and UV stabilized for long lasting performance
- Accepts standard strut channels
- Supports green building requirements; thermoplastic bases are made from recycled material and can contribute to earning LEED credits

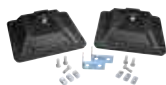

Material: Polypropylene, Polyethylene

Temperature: -30 to 130 °F

Static Load Safety Factor: 3:1

Part #	Description	F	
PHK	Foam	1,500 lb	1 pc
PHKR	Rubber	1,500 lb	1 pc

Static load represents 750 lb (3,335 N) per post base. The end user must select and evaluate the strut framing to ensure the assembled H-frame can properly support the applied load.

### NVENT CADDY PYRAMID H-FRAME HARDWARE KIT

- Kit includes six bolts, six strut nuts, and two L-brackets to build custom multi-tier H-frame assemblies



Material: Steel

Finish: Hot-Dip Galvanized

Part #	Description	
HFRMHDW	nVent CADDY Pyramid H-Frame Hardware Kit	1 pc

# NVENT CADDY PYRAMID ROOFTOP SYSTEMS

## nVent CADDY Pyramid Equipment Supports

### **NVENT CADDY PYRAMID EQUIPMENT SUPPORT KIT, 4 POST BASE**

- Kit includes post-base assemblies, frame and equipment-support clamps
- Assembles and adjusts to size and height in minutes by one person with one tool
- Innovative crossbar and equipment-support clamps enable quick assembly
- Integral foam pad provides gentle interface for all roof types
- Hot-dip galvanized and UV stabilized for long lasting performance
- Assembled support can be lifted as one unit and easily relocated
- Supports green building requirements; thermoplastic bases are made from recycled material and can contribute to earning LEED credits

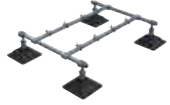

Material: Steel, Polypropylene, Polyethylene  
 Finish: Hot-Dip Galvanized  
 Temperature: -30 to 130 °F  
 Height: 12" – 18"  
 Length: 49 1/2"

Part #	Description		
PEK4B	49 1/2"	1,120 lb	1 pc

Static load must be stable and uniformly distributed across frame.

# NVENT CADDY PYRAMID ROOFTOP SYSTEMS

## nVent CADDY Pyramid Equipment Supports

### NVENT CADDY PYRAMID EQUIPMENT SUPPORT KIT, 6 POST BASE

- Kit includes post-base assemblies, frame and equipment-support clamps
- Assembles and adjusts to size and height in minutes by one person with one tool
- Innovative crossbar and equipment-support clamps enable quick assembly
- Integral foam pad provides gentle interface for all roof types
- Hot-dip galvanized and UV stabilized for long lasting performance
- Assembled support can be lifted as one unit and easily relocated
- Supports green building requirements; thermoplastic bases are made from recycled material and can contribute to earning LEED credits



Material: Steel, Polypropylene, Polyethylene  
Finish: Hot-Dip Galvanized  
Temperature: -30 to 130 °F  
Height: 12" – 18"  
Length: 85 1/2"

Part #	Description	F ↓	↓ Cube
PEK6B	85 1/2"	2,240 lb	1 pc

Static load must be stable and uniformly distributed across frame.

# NVENT CADDY PYRAMID ROOFTOP SYSTEMS

## nVent CADDY Pyramid Equipment Supports

### NVENT CADDY PYRAMID EQUIPMENT SUPPORT FRAME EXTENSION KIT

- Allows creation of custom equipment support lengths by attaching the nVent CADDY Pyramid Extension Kit in series to a nVent CADDY Pyramid Equipment Support Kit
- Kit includes two post-base assemblies, frame and equipment-support clamps for easy attachment to a nVent CADDY Pyramid Equipment Support Kit
- Square tube and cross bars provide superior load and deflection capabilities over standard strut profiles
- Assembles and adjusts to size and height in minutes by one person with one tool
- Innovative crossbar and equipment-support clamps enable quick assembly
- Integral foam pad provides gentle interface for all roof types
- Hot-dip galvanized and UV stabilized for long lasting performance
- Supports green building requirements; thermoplastic bases are made from recycled material and can contribute to earning LEED credits



Material: Steel, Polypropylene, Polyethylene  
Finish: Hot-Dip Galvanized  
Temperature: -30 to 130 °F  
Height: 12" – 18"  
Length: 62 1/2"

Part #	Description		
PEKEF	nVent CADDY Pyramid Equipment Support Frame Extension Kit	1,120 lb	1 pc

Static load must be stable and uniformly distributed across frame. nVent CADDY Pyramid Equipment Support Frame Extension must be used in conjunction with a nVent CADDY Pyramid Equipment Support Kit.

## NVENT CADDY PYRAMID ROOFTOP SYSTEMS

### nVent CADDY Pyramid Equipment Supports

#### NVENT CADDY PYRAMID EQUIPMENT SUPPORT POST

- Individual height adjustable leg gives the flexibility to customize the equipment support solution
- Accepts standard strut channels



Material: Steel  
Finish: Hot-Dip Galvanized

Part #	Description	
RPSC34	nVent CADDY Pyramid Equipment Support Post	2 pc

#### NVENT CADDY PYRAMID EQUIPMENT SUPPORT SQUARE TUBE

- Individual square tube gives the flexibility to customize the equipment support solution



Material: Steel  
Finish: Hot-Dip Galvanized

Part #	Description	
RPSC24	42"	2 pc
RPSC25	78"	2 pc

#### NVENT CADDY PYRAMID EQUIPMENT SUPPORT CROSSBAR

- Includes innovative support clamps



Material: Steel  
Finish: Hot-Dip Galvanized

Part #	Description	
RPSC28	nVent CADDY Pyramid Equipment Support Crossbar	2 pc

# NVENT CADDY PYRAMID ROOFTOP SYSTEMS

## nVent CADDY Pyramid Equipment Supports

### NVENT CADDY PYRAMID EQUIPMENT SUPPORT HEIGHT EXTENSION

- Increases the height between the equipment support frame and roof deck
- Inserts directly into nVent CADDY Pyramid Equipment Support Bases



Material: Steel  
 Finish: Hot-Dip Galvanized



Part #	Description	
PEH31	nVent CADDY Pyramid Equipment Support Height Extension	1 pc

### NVENT CADDY PYRAMID EQUIPMENT SUPPORT POST BASE

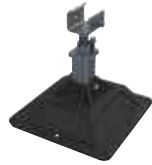
- Ideal for use with strut channel type A and U-shaped brackets to create custom equipment supports
- Height adjustable
- Foam bottom offers low abrasion interface for better roof membrane protection
- Compatible with roof surfaces including single ply, bituminous, metal and spray foam
- Provides superior load distribution, even with varying rooftop surfaces
- Hot-dip galvanized and UV stabilized for long lasting performance
- Supports green building requirements; thermoplastic bases are made from recycled material and can contribute to earning LEED credits



Material: Steel, Polypropylene, Polyethylene  
 Finish: Hot-Dip Galvanized  
 Temperature: -30 to 130 °F  
 Static Load Safety Factor: 3:1

Part #	Description		
PEB	nVent CADDY Pyramid Equipment Support Post Base	750 lb	2 pc

The end user must select and evaluate the strut framing to ensure the custom assembled equipment support can properly support the applied load.

## NVENT CADDY PYRAMID ROOFTOP SYSTEMS

### nVent CADDY Pyramid Equipment Supports

#### NVENT CADDY PYRAMID EQUIPMENT SUPPORT CLAMP

- Ideal for use with strut channel type A and square tube to create custom equipment supports
- Slotted design offers fast and easy installation



Material: Steel  
Finish: Hot-Dip Galvanized



Part #	Description	
PEC	nVent CADDY Pyramid Equipment Support Clamp	20 pc

#### NVENT CADDY PYRAMID CROSSOVER LADDER, 50°

- Standard angle ladders provide easy changes in elevation
- Interchangeable components are easily assembled yielding labor-saving and quick installations
- nVent CADDY Pyramid bases provide superior load distribution and roof membrane compatibility
- Foam bottom offers low abrasion interface for better roof membrane protection
- Aluminum construction designed to withstand harsh environments
- Walking surfaces with serrated tread provides maximum slip resistance and drainage
- Compliant with OSHA, Cal/OSHA and ANSI® standards



Material: Aluminum, Polypropylene, Polyethylene

Part #	Description		
PCL50S2	20" Walkway Height, 2 Steps	500 lb	1 pc
PCL50S3	30" Walkway Height, 3 Steps	500 lb	1 pc
PCL50S4	40" Walkway Height, 4 Steps	500 lb	1 pc
PCL50S5	50" Walkway Height, 5 Steps	500 lb	1 pc
PCL50S6	60" Walkway Height, 6 Steps	500 lb	1 pc

Clearance of walkway is 3" less than the walkway height.

# NVENT CADDY PYRAMID ROOFTOP SYSTEMS

## nVent CADDY Pyramid Crossovers and Walkways

### NVENT CADDY PYRAMID CROSSOVER LADDER, 90°

- Vertical ladders ideal for tight spaces
- Interchangeable components are easily assembled yielding labor-saving and quick installations
- nVent CADDY Pyramid bases provide superior load distribution and roof membrane compatibility
- Foam bottom offers low abrasion interface for better roof membrane protection
- Aluminum construction designed to withstand harsh environments
- Walking surfaces with serrated tread provides maximum slip resistance and drainage
- Compliant with OSHA, Cal/OSHA and ANSI® standards



Material: Aluminum, Polypropylene, Polyethylene

Part #	Description	F ↓	📦
PCL90S2	20" Walkway Height, 2 Steps	500 lb	1 pc
PCL90S3	30" Walkway Height, 3 Steps	500 lb	1 pc
PCL90S4	40" Walkway Height, 4 Steps	500 lb	1 pc
PCL90S5	50" Walkway Height, 4 Steps	500 lb	1 pc
PCL90S6	60" Walkway Height, 5 Steps	500 lb	1 pc

Clearance of walkway is 3" less than the walkway height.





# NVENT CADDY PYRAMID ROOFTOP SYSTEMS

## nVent CADDY Pyramid Crossovers and Walkways

### NVENT CADDY PYRAMID CROSSOVER SUPPORT TOWER

- Additional support towers ideal for supporting long walkways at varying heights
- Interchangeable components are easily assembled yielding labor-saving and quick installations
- nVent CADDY Pyramid bases provide superior load distribution and roof membrane compatibility
- Foam bottom offers low abrasion interface for better roof membrane protection
- Aluminum construction designed to withstand harsh environments
- Walking surfaces with serrated tread provides maximum slip resistance and drainage
- Compliant with OSHA, Cal/OSHA and ANSI® standards



Material: Aluminum, Polypropylene, Polyethylene

Part #	Description	F ↓	☐
PCT20	20" Walkway Height	500 lb	1 pc
PCT30	30" Walkway Height	500 lb	1 pc
PCT40	40" Walkway Height	500 lb	1 pc
PCT50	50" Walkway Height	500 lb	1 pc
PCT60	60" Walkway Height	500 lb	1 pc

Walkway height represents the height of the walkway when a nVent CADDY Pyramid Crossover Bridge is attached to the support tower. Clearance of walkway is 3" less than the walkway height.

# NVENT CADDY PYRAMID ROOFTOP SYSTEMS

## nVent CADDY Pyramid Crossovers and Walkways

### NVENT CADDY PYRAMID CROSSOVER BRIDGE

- Standard bridge spans that can be combined to create custom pathway lengths
- Interchangeable components are easily assembled yielding labor-saving and quick installations
- Aluminum construction designed to withstand harsh environments
- Walking surfaces with serrated tread provides maximum slip resistance and drainage
- Compliant with OSHA, Cal/OSHA and ANSI® standards



Material: Aluminum

Part #	Description	F ↓	☐
PCB36X12	12"	500 lb	1 pc
PCB36	40"	500 lb	1 pc

Bridge spans require support on each end. Bridge spans exceeding 90" require an additional support tower.

### NVENT CADDY PYRAMID CROSSOVER BRIDGE TURN KIT

- Turn bridges allow for configurations beyond a straight pathway, "L", "U" or "Z" pathways can be created by using turn bridges
- Interchangeable components are easily assembled yielding labor-saving and quick installations
- nVent CADDY Pyramid bases provide superior load distribution and roof membrane compatibility
- Foam bottom offers low abrasion interface for better roof membrane protection
- Aluminum construction designed to withstand harsh environments
- Walking surfaces with serrated tread provides maximum slip resistance and drainage
- Compliant with OSHA, Cal/OSHA and ANSI® standards



Material: Aluminum, Polypropylene, Polyethylene

Part #	Description	F ↓	☐
PCB36H20	20" Walkway Height	500 lb	1 pc
PCB36H30	30" Walkway Height	500 lb	1 pc
PCB36H40	40" Walkway Height	500 lb	1 pc
PCB36H50	50" Walkway Height	500 lb	1 pc
PCB36H60	60" Walkway Height	500 lb	1 pc

Clearance of walkway is 3" less than the walkway height.

# NVENT CADDY PYRAMID ROOFTOP SYSTEMS

## nVent CADDY Pyramid Crossovers and Walkways

### NVENT CADDY PYRAMID CROSSOVER GUARDRAIL KIT

- Use an extra guardrail kit to block off the end of a pathway or create custom pathway configurations while ensuring all safety criteria are met
- Interchangeable standard components for flexibility while providing safe access over piping, duct, equipment or other utilities on a roof surface
- Aluminum construction designed to withstand harsh environments
- Compliant with OSHA, Cal/OSHA and ANSI® standards



Material: Aluminum

Part #	Description	
PCGK	nVent CADDY Pyramid Crossover Guardrail Kit	1 pc

### NVENT CADDY PYRAMID CROSSOVER PLATFORM

- Height adjustable interlocking platforms allow for quick and easy installation of a custom pathway across rooftop surfaces
- Protect roof surfaces by providing a clearly defined pathway
- Modular design allows for easily configurable heights and lengths to address varying applications
- nVent CADDY Pyramid bases provide superior load distribution and roof membrane compatibility
- Foam bottom offers low abrasion interface for better roof membrane protection
- Aluminum construction designed to withstand harsh environments
- Walking surfaces with serrated tread provides maximum slip resistance and drainage

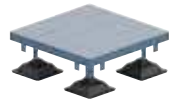

Material: Aluminum, Polypropylene, Polyethylene

Part #	Description		
PCP36	nVent CADDY Pyramid Crossover Platform	500 lb	1 pc

# NVENT CADDY PYRAMID ROOFTOP SYSTEMS

## NVENT CADDY PYRAMID 50 FOAM-BASED SUPPORT

- Replaces slow and labor-intensive installation methods
- Supports pipe, conduit, cable tray and equipment on roofs and below raised floors
- Easily increase load capacity by combining similar nVent CADDY Pyramid supports
- Protects the roof membrane while absorbing shock and vibration, without absorbing water
- Metal cover protects against weather and other environmental conditions, such as bird damage

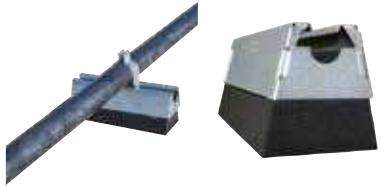

Material: Steel, Polyethylene  
Static Load Safety Factor: 3:1

Part #	Description	F ↓	
Finish: Electrogalvanized			
RPS50H4EG	EG, 4"	50 lb	10 pc
RPS50H6EG	EG, 6"	50 lb	10 pc
Finish: Hot-Dip Galvanized			
RPS50H6HD	HD, 6"	50 lb	10 pc

# NVENT CADDY PYRAMID ROOFTOP SYSTEMS

## nVent CADDY Pyramid Rooftop Anchor System

### NVENT CADDY PYRAMID ROOFTOP ANCHOR

- Anchors require minimal roof membrane penetration
- System preserves membrane manufacturers' warranty
- Matching membrane material allows for consistent performance and aesthetic
- Installation creates a watertight seal, eliminating water intrusion and damage to the structure



Part #	Description	
Material: EPDM-SBR Rubber		
CRAU24EB1C	EPDM-SBR, CARLISLE Membrane, 11 3/4"	10 pc
CRAU24EB1CR2	EPDM-SBR, CARLISLE Membrane, 11 3/4"	2 pc
Material: Modified Asphalt		
CRAU26ST2F	FIRESTONE Membrane, 18"	10 pc
CRAU26ST2FR2	FIRESTONE Membrane, 18"	2 pc
CRAU26STCR2F	FIRESTONE Membrane, 18"	10 pc
CRAU26STCR2FR2	FIRESTONE Membrane, 18"	2 pc
CRAU26SW12C	CERTAINTEED Membrane, 18"	10 pc
CRAU26SW12CR2	CERTAINTEED Membrane, 18"	2 pc
Material: Polyvinylchloride		
CRAU24PW3J	JOHNS MANVILLE Membrane, 11 3/4"	10 pc
CRAU24PW3JR2	JOHNS MANVILLE Membrane, 11 3/4"	2 pc
CRAU24PW8S	SIKA SARNAFIL Membrane, 11 3/4"	10 pc
CRAU24PW8SR2	SIKA SARNAFIL Membrane, 11 3/4"	2 pc
Material: Thermoplastic Polyolefin (TPO)		
CRAU24TW1C	CARLISLE Membrane, 11 3/4"	10 pc
CRAU24TW1CR2	CARLISLE Membrane, 11 3/4"	2 pc
CRAU24TW2F	FIRESTONE Membrane, 11 3/4"	10 pc
CRAU24TW2FR2	FIRESTONE Membrane, 11 3/4"	2 pc
CRAU24TW3J	JOHNS MANVILLE Membrane, 11 3/4"	10 pc
CRAU24TW3JR2	JOHNS MANVILLE Membrane, 11 3/4"	2 pc
CRAU24TW4G	GAF Membrane, 11 3/4"	10 pc
CRAU24TW4GR2	GAF Membrane, 11 3/4"	2 pc

Anchor system must be installed by a certified roofing contractor according to membrane manufacturer's guidelines to preserve membrane warranty.

# NVENT CADDY PYRAMID ROOFTOP SYSTEMS

## nVent CADDY Pyramid Rooftop Anchor System

### NVENT CADDY PYRAMID ROOFTOP ANCHOR CABLE BRACING

- Stainless steel components of cable assembly provides superior corrosion performance
- Multiple length configurations provide flexibility for various installations
- Pre-assembled cable terminations enable easy installation



Material: Stainless Steel 316 (EN 1.4401)



Part #	Description	
CRA36SS38L2	6.6'	2 pc x 5
CRA36SS38L3	9.8'	2 pc x 5
CRA36SS38L4	13.1'	2 pc x 5

### DECK SCREW

- Secures nVent CADDY Pyramid Rooftop Anchors to various roof substrate materials



Material: Steel  
 Finish: Epoxy Coated  
 Color: Black

Part #	Description		Part #	Description	
A927W001P100	#14, 2" Screw	100 pc	A927W008P100	#15, 2" Screw	100 pc
A927W002P100	#14, 3" Screw	100 pc	A927W009P100	#15, 3" Screw	100 pc
A927W003P100	#14, 4" Screw	100 pc	A927W010P100	#15, 4" Screw	100 pc
A927W004P100	#14, 5" Screw	100 pc	A927W011P100	#15, 5" Screw	100 pc
A927W005P100	#14, 6" Screw	100 pc	A927W012P100	#15, 6" Screw	100 pc
A927W006P100	#14, 7" Screw	100 pc	A927W013P100	#15, 7" Screw	100 pc
A927W007P100	#14, 8" Screw	100 pc	A927W014P100	#15, 8" Screw	100 pc
A927W016P100	#14, 10" Screw	100 pc	A927W019P100	#15, 9" Screw	100 pc
A927W018P100	#14, 12" Screw	100 pc	A927W020P100	#15, 10" Screw	100 pc
			A927W021P100	#15, 12" Screw	100 pc
			A927W022P100	#15, 14" Screw	100 pc

#14 deck screws are for general purpose use.  
 #15 deck screws are specially suited for OSB and light gauge steel.

# NVENT CADDY PYRAMID ROOFTOP SYSTEMS

## nVent CADDY Pyramid EZ Rubber-Based Supports

### NVENT CADDY PYRAMID EZ RUBBER-BASED ADJUSTABLE SUPPORT

- Quick height adjustment accommodates for uneven roofs or sloped condensate lines
- No tools or fasteners needed; fast snap-on installation
- Design sheds water and helps reduce pipe corrosion
- Roof-friendly; made of UV-stabilized EPDM material



Material: EPDM-SBR Rubber

Part #	Description	F ↓	☐
RPSE1H24	1" Rigid/Pipe, 1.315" OD, 1 3/4"-4"	170 lb	20 pc
RPSE1H57	1" Rigid/Pipe, 1.315" OD, 5"-7"	170 lb	10 pc
RPSE2H46	2" Rigid/Pipe, 2.37" OD, 4"-6"	250 lb	10 pc
RPSE4H46	4" Rigid/Pipe, 4.5" OD, 4"-6"	400 lb	5 pc

Ultimate load at 1/4" (6.35 mm) deflection. Contact project or roofing engineer for maximum allowable load on individual project roof system.

### NVENT CADDY PYRAMID EZ RUBBER-BASED SUPPORT

- No tools or fasteners needed; fast snap-on installation
- Design sheds water and helps reduce pipe corrosion
- Roof-friendly; made of UV-stabilized EPDM material



Material: EPDM-SBR Rubber

Part #	Description	F ↓	☐
RPSE1H	1" Rigid/Pipe, 1.315" OD, 1"	170 lb	20 pc

Ultimate load at 1/4" (6.35 mm) deflection. Contact project or roofing engineer for maximum allowable load on individual project roof system.

# NVENT CADDY PYRAMID ROOFTOP SYSTEMS

## NVENT CADDY PYRAMID UNIVERSAL SUPPORT

- Captive stainless steel nuts allow for custom attachment methods to the support base including easy attachment of stainless steel strut, threaded rod or other project-specific hardware
- Foam bottom offers low abrasion interface for better roof membrane protection
- Compatible with roof surfaces including single ply, bituminous, metal and spray foam
- Provides superior load distribution, even with varying rooftop surfaces
- Multiple sizes and load ratings offer the ability to tailor the solution to the application
- Includes square holes for creating an H-Frame with a 12" (305 mm) cross support (PBU16 only)
- Base is manufactured from UV-stabilized thermoplastic material
- Supports green building requirements; thermoplastic bases are made from recycled material and can contribute to earning LEED credits



Material: Polyethylene, Polypropylene, Stainless Steel 18-8 (EN 1.4305)  
Temperature: -50 to 150 °F  
Static Load Safety Factor: 3:1

Part #	Description	
PBU6	5 1/2" x 4"	20 pc
PBU10	10" x 4"	10 pc
PBU16	16" x 4"	5 pc



# NVENT CADDY PYRAMID ROOFTOP SYSTEMS

## nVent CADDY Pyramid Tool-Free Supports

### NVENT CADDY PYRAMID TOOL-FREE PIPE SUPPORT KIT

- Push-in clamps install without the need for additional tools or strut clamps
- Ready to use out of the box, saving installation time and labor
- Plastic clamps and base will not corrode pipe
- Clamps come in two different sizes to fit project needs
- Base includes multiple holes to accommodate a variety of clamp sizes and configurations
- Additional clamps can be purchased separately for additional pipe runs
- Foam bottom offers low abrasion interface for better roof membrane protection
- Provides superior load distribution, even with varying rooftop surfaces
- Compatible with roof surfaces including single ply, bituminous, metal and spray foam
- Multiple sizes and load ratings offer the ability to tailor the solution to the application
- Easy to transport to the roof
- Supports green building requirements; thermoplastic bases are made from recycled material and can contribute to earning LEED credits



Material: Polyethylene, Polypropylene, Nylon

Temperature: -50 to 150 °F

Static Load Safety Factor: 3:1

Part #	Description	Number of Clamps Included		Maximum Clamp Capacity		F ↓	📦
		PTF1C	PTF2C	PTF1C	PTF2C		
PTF6	8" L, 4" H	1	1	3	1	300 lb	20 pc
PTF10	12 1/2" L, 4" H	-	2	5	2	1,000 lb	10 pc
PTF16	19" L, 4" H	-	2	7	3	1,500 lb	5 pc

### NVENT CADDY PYRAMID TOOL-FREE PIPE CLAMP

- Push-in clamps install without the need for additional tools or strut clamps
- Clamps come in two different sizes to fit project needs
- Plastic clamps and base will not corrode pipe



Material: Nylon

Temperature: -50 to 150 °F

Part #	Description	📦
PTF1C	0.5"–1.32" OD	100 pc
PTF2C	0.84"–2.38" OD	100 pc

# NVENT CADDY PYRAMID ROOFTOP SYSTEMS



## nVent CADDY Pyramid Tool-Free Supports

### NVENT CADDY PYRAMID TOOL-FREE CABLE TRAY SUPPORT KIT

- Push-in pins install without the need for additional tools
- Plastic pins and base will not corrode
- Pins and mounting holes accommodate most perforated cable tray
- Ready to use out of the box, saving installation time and labor
- Additional pins can be purchased separately
- Foam bottom offers low abrasion interface for better roof membrane protection
- Provides superior load distribution, even with varying rooftop surfaces
- Compatible with roof surfaces including single ply, bituminous, metal and spray foam
- Multiple sizes and load ratings offer the ability to tailor the solution to the application
- Easy to transport to the roof
- Supports green building requirements; thermoplastic bases are made from recycled material and can contribute to earning LEED credits



Material: Polyethylene, Polypropylene, Nylon  
Temperature: -50 to 150 °F  
Static Load Safety Factor: 3:1

Part #	Description		
PTF6P	8"	300 lb	20 pc
PTF10P	12 1/2"	1,000 lb	10 pc
PTF16P	19"	1,500 lb	5 pc

### NVENT CADDY PYRAMID TOOL-FREE CABLE TRAY PIN

- Push-in pins install without the need for additional tools
- Plastic pins and base will not corrode
- Pins and mounting holes accommodate most perforated cable tray
- Supports green building requirements; thermoplastic bases are made from recycled material and can contribute to earning LEED credits



Material: Nylon  
Temperature: -50 to 150 °F

Part #	Description	
PTFP	nVent CADDY Pyramid Tool-Free Cable Tray Pin	10 x 20 pc

# NVENT CADDY PYRAMID ROOFTOP SYSTEMS

## NVENT CADDY PYRAMID 25 PIPE AND CONDUIT SUPPORT, PLASTIC

- Simple solution for supporting small pipes or conduit runs
- Lightweight plastic construction
- UV resistant, designed and tested for outdoor use
- No tools or fasteners needed for installation
- Rounded edges to help protect the roof membrane



Material: Acrylonitrile Butadiene Styrene

Part #	Description	F ↓	↓ C
PPRPS25H4	4 7/16"	25 lb	25 pc
PPRPS25H6	6 7/16"	25 lb	20 pc

# Metal Framing



# METAL FRAMING

## Telescoping Support Brackets

### TELESCOPING STRUT REPLACEMENT

- Captive threaded nuts enable fastening to threaded rod supports without loose parts
- Telescopes to the desired length and is locked in place by snapping closed a spring retainer clip
- Standard strut profile runs the entire length of the part, allowing most standard fittings to be placed anywhere between the rods
- Integrated ruler displays space between hanger rods in inches and centimeters
- Supports up to seven 2" (50 DN) conduits, six 2" (50 DN) water filled pipes at 10' (3 m) spacing, or up to 18" (450 mm) cable tray
- Conduit can be supported on the top and bottom, eliminating the need for double sided strut
- Conduit and pipe can be placed directly on the strut profile, saving vertical space in buildings with limited room for installation
- Meets requirements of the Buy American Act



Material: Steel

Finish: Pregalvanized

Part #	Description	Static Load 1	Static Load 2	
TSR122025	1/4" Rod	300 lb	200 lb	20 pc
TSR1220	3/8" Rod	300 lb	200 lb	20 pc

Static Load 1 represents a distributed load for 12" - 20" (300 - 500 mm) installations and a point load for 12" - 16" (300 - 400 mm) installations. Static Load 2 represents a point load for 16" - 20" (400 - 500 mm) installations.



Telescoping Strut Replacement with CADDY Rod Lock "push-to-install" technology is available on page 6-9.

- Easy "push-to-install" design allows installers to simply push the threaded rod through the mounting hole, instantly holding it in position
- Telescopes to the desired length and is locked in place by snapping closed a spring retainer clip
- Standard strut profile runs the entire length of the part, allowing most standard fittings to be placed anywhere between the rods
- Allows installers to prefabricate complex assemblies and quickly lift and lock them into place
- Lock nut can be finger tightened, locking the rod in place

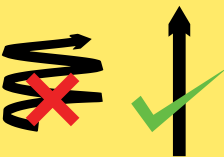

"Push-to-install" Technology

# METAL FRAMING

## Telescoping Support Brackets

### TELESCOPING STRUT REPLACEMENT, NO NUT

- Can be attached directly to a wall for wall-mounted applications
- Telescopes to the desired length and is locked in place by snapping closed a spring retainer clip
- Standard strut profile runs the entire length of the part, allowing most standard fittings to be placed anywhere between the rods
- Integrated ruler displays space between hanger rods in inches and centimeters
- Supports up to seven 2" (50 DN) conduits, six 2" (50 DN) water filled pipes at 10' (3 m) spacing, or up to 18" (450 mm) cable tray
- Conduit can be supported on the top and bottom, eliminating the need for double sided strut
- Conduit and pipe can be placed directly on the strut profile, saving vertical space in buildings with limited room for installation
- Meets requirements of the Buy American Act



Material: Steel  
Finish: Pregalvanized

Part #	Description	Static Load 1	Static Load 2	
TSR1220N	Telescoping Strut Replacement, No Nut	300 lb	200 lb	25 pc

Static Load 1 represents a distributed load for 12" - 20" (300 - 500 mm) installations and a point load for 12" - 16" (300 - 400 mm) installations. Static Load 2 represents a point load for 16" - 20" (400 - 500 mm) installations.

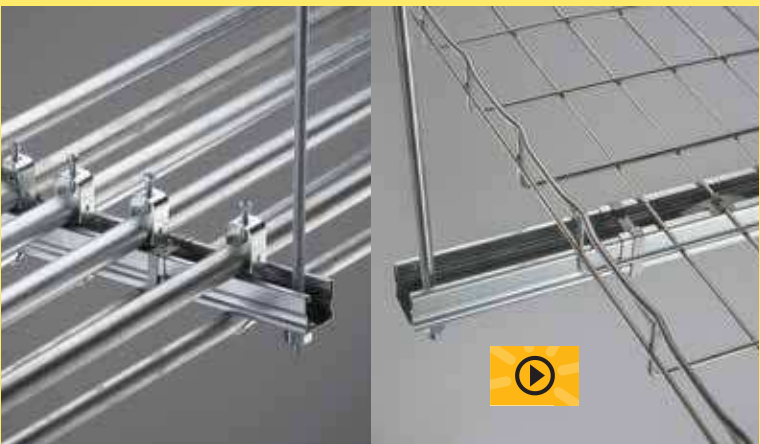

# METAL FRAMING

## Telescoping Support Brackets

### TELESCOPING STRUT REPLACEMENT, RETROFIT

- Slotted ends allow the bracket to be installed with four nVent CADDY SN Nuts on threaded rod above an existing trapeze, saving contractor time and limiting building downtime
- Telescopes to the desired length and is locked in place by snapping closed a spring retainer clip
- Standard strut profile runs the entire length of the part, allowing most standard fittings to be placed anywhere between the rods
- Integrated ruler displays space between hanger rods in inches and centimeters
- Supports up to seven 2" (50 DN) conduits, six 2" (50 DN) water filled pipes at 10' (3 m) spacing, or up to 18" (450 mm) cable tray
- Conduit can be supported on the top and bottom, eliminating the need for double sided strut
- Conduit and pipe can be placed directly on the strut profile, saving vertical space in buildings with limited room for installation
- Winner of the EC&M 2017 Product of the Year Platinum Award
- Meets requirements of the Buy American Act



Material: Steel

Finish: Pregalvanized

Part #	Description	Static Load 1	Static Load 2	
TSR1220R	3/8" Rod	300 lb	200 lb	25 pc

Static Load 1 represents a distributed load for 12" - 20" (300 - 500 mm) installations and a point load for 12" - 16" (300 - 400 mm) installations. Static Load 2 represents a point load for 16" - 20" (400 - 500 mm) installations.

# METAL FRAMING

## nVent CADDY Eristrut Strut Channel System

### STRUT CHANNEL TYPE A, SLOTTED

- Cold formed channel, slotted
- Strut channels for heavy applications
- For individual fastening or for efficiently constructing pipe or tube routes



Part #	Description	
Material: Stainless Steel 304 (EN 1.4301)		
A12H1000S4	S304, 10' x 1.625" x 1.625" x 12 GA	10'
Material: Steel – Finish: Hot-Dip Galvanized		
A12H1000HD	HD, 10' x 1.625" x 1.625" x 12 GA	10'
A12H2000HD	HD, 20' x 1.625" x 1.625" x 12 GA	10'
Material: Steel – Finish: Painted – Color: Green		
A12H1000GN	10' x 1.625" x 1.625" x 12 GA	500'
A14H1000GN	10' x 1.625" x 1.625" x 14 GA	500'
A12H2000GN	20' x 1.625" x 1.625" x 12 GA	500'
A14H2000GN	20' x 1.625" x 1.625" x 14 GA	500'
Material: Steel – Finish: Pregalvanized		
A12H1000PG	PG, 10' x 1.625" x 1.625" x 12 GA	500'
A14H1000PG	PG, 10' x 1.625" x 1.625" x 14 GA	500'
A12H2000PG	PG, 20' x 1.625" x 1.625" x 12 GA	500'
A14H2000PG	PG, 20' x 1.625" x 1.625" x 14 GA	500'

### STRUT CHANNEL TYPE A, SOLID

- Cold formed channel, solid
- Strut channels for heavy applications
- For individual fastening or for efficiently constructing pipe or tube routes

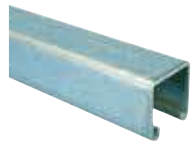

Material: Steel  
Finish: Pregalvanized

Part #	Description	
A121000PG	PG, 10' x 1.625" x 1.625"	500 pc
A141000PG	PG, 10' x 1.625" x 1.625"	500 pc



## METAL FRAMING

### nVent CADDY Eristrut Strut Channel System

#### STRUT CHANNEL TYPE AA, SLOTTED

- Cold formed channel, slotted
- Welded back to back
- Strut channels for heavy applications
- For individual fastening or for efficiently constructing pipe or tube routes



Material: Steel

Part #	Description	
Finish: Painted – Color: Green		
A12AH200GN	20' x 3.25" x 1.625" x 12 GA	20'
Finish: Pregalvanized		
A12AH100PG	PG, 10' x 3.25" x 1.625" x 12 GA	50 pc
A12AH200PG	PG, 20' x 3.25" x 1.625" x 12 GA	20'

#### STRUT CHANNEL TYPE C, SLOTTED

- Cold formed channel, slotted
- Strut channels for medium to heavy applications
- For individual fastening or for efficiently constructing pipe or tube routes



Part #	Description	
Material: Stainless Steel 304 (EN 1.4301)		
C14H1000S4	S304, 10' x 13/16" x 1 5/8" x 14 GA	10'
Material: Steel – Finish: Painted – Color: Green		
C12H1000GN	10' x 13/16" x 1 5/8" x 12 GA	10'
C14H1000GN	10' x 13/16" x 1 5/8" x 14 GA	10'
C12H2000GN	20' x 13/16" x 1 5/8" x 12 GA	20'
C14H2000GN	20' x 13/16" x 1 5/8" x 14 GA	20'
Material: Steel – Finish: Pregalvanized		
C12H1000PG	PG, 10' x 13/16" x 1 5/8" x 12 GA	10'
C14H1000PG	PG, 10' x 13/16" x 1 5/8" x 14 GA	10'
C12H2000PG	PG, 20' x 13/16" x 1 5/8" x 12 GA	20'
C14H2000PG	PG, 20' x 13/16" x 1 5/8" x 14 GA	20'

# METAL FRAMING

## nVent CADDY Eristrut Strut Channel System

### STRUT CHANNEL TYPE C, SOLID

- Cold formed channel, solid
- Strut channels for medium to heavy applications
- For individual fastening or for efficiently constructing pipe or tube routes

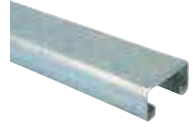

Material: Steel  
Finish: Pregalvanized

Part #	Description	
C121000PG	PG, 10" x 12 GA	500 pc
C141000PG	PG, 10" x 14 GA	500 pc

### STRUT CHANNEL TYPE D, SLOTTED

- Cold formed channel, slotted



Material: Steel  
Finish: Pregalvanized

Part #	Description	
D12H1000PG	PG, 10' x 2.438" x 1.625"	10'
D12H2000PG	PG, 20' x 2.438" x 1.625"	20'

### STRUT CHANNEL TYPE D, SOLID

- Cold formed channel, solid
- Strut channels for heavy applications
- For individual fastening or for efficiently constructing pipe or tube routes



Material: Steel  
Finish: Pregalvanized

Part #	Description	
D121000PG	2 7/16" x 1 5/8"	100 pc

## METAL FRAMING

### nVent CADDY Eristrut Strut Channel System

#### STRUT CHANNEL TYPE E, SLOTTED

- Cold formed channel, slotted



Material: Steel  
Finish: Pregalvanized

Part #	Description	
E12H1000PG	PG, 10' x 3.25" x 1.625" x 12 GA	10'
E12H2000PG	PG, 20' x 3.25" x 1.625" x 12 GA	20'

#### STRUT CHANNEL TYPE E, SOLID

- Cold formed channel, solid
- Strut channels for heavy applications
- For individual fastening or for efficiently constructing pipe or tube routes



Material: Steel  
Finish: Pregalvanized

Part #	Description	
E121000PG	PG, 10" x 3.25" x 12 GA x 1.625"	100 pc

#### STRUT CHANNEL CONCRETE INSERT

- Cold formed, with anchor legs
- Polystyrene filler prevents concrete from entering in the channel
- Complete with end caps

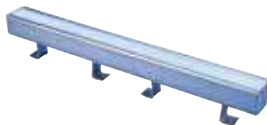

Material: Steel  
Finish: Pregalvanized

Part #	Description		
CONB122000PG	1 5/8" x 12 GA	1,000 lb	20'

# METAL FRAMING

## nVent CADDY Eristrut Strut Channel System

### STRUT TO STRUT CONNECTOR

- Consists of two halve castings, nut and bolt
- Allows for bolting two strut channels back to back through the slots



Material: Steel  
Finish: Electrogalvanized

Part #	Description	F ↓	☐
STS	Strut to Strut Connector	1,000 lb	100 pc

Minimum of 2 required. Maximum spacing 1 foot (300mm).  
Minimum half-slot dimensions 9/16" x 7/8" (14.3 mm x 22.2 mm).

### ADK STRUT END CAP

- Fits into ERISTRUT Type A channel
- When separated, provides two end caps for ERISTRUT Type C channel



Material: Polyethylene

Part #	Description	☐
ADK421	Blue	100 pc
ADK421GN	Green	100 pc
ADK421GY	Gray	100 pc
ADK421RD	Red	100 pc

## METAL FRAMING

### nVent CADDY Eristrut Strut Channel System

#### ENDC STRUT END CAP

- Fits into ERISTRUT Type A channel

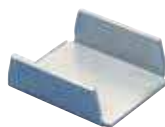

Material: Steel  
Finish: Electrogalvanized

Part #	Description	
ENDCA120EG	ENDC Strut End Cap	100 pc

#### STRUT CHANNEL COVER

- Easily snaps into any ERISTRUT strut channel



Part #	Description	
Material: Polystyrene		
CL100000PS	Polystyrene	10'
Material: Steel – Finish: Electrogalvanized		
CL100000EG	EG	10'

# METAL FRAMING

## nVent CADDY Eristrut Strut Channel System

### NVENT CADDY SLICK NUT

- Provides fast universal attachment of threaded rod and hardware to standard strut profiles



Material: Polyamide, Spring Steel  
Finish: nVent CADDY Armour

Part #	Description	F1	F2	F3	
SLICK250	1/4" Hole, Threaded	400 lb	100 lb	250 lb	100 pc
SLICK375	3/8" Hole, Threaded	600 lb	100 lb	250 lb	100 pc
SLICK500	1/2" Hole, Threaded	600 lb	100 lb	250 lb	100 pc

Indicated loads are independent of the threaded stud or rod. Indicated loads are applicable on 14 GA and 12 GA (2 mm and 2.5 mm) strut channels only.

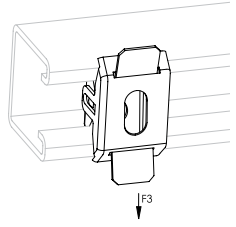
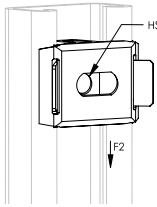
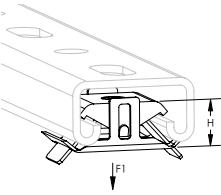

## METAL FRAMING

### nVent CADDY Eristrut Strut Channel System

#### STRUT NUT WITHOUT SPRING

- Used to create metal frames with nVent CADDY Eristrut channels



Static Load Safety Factor: 3:1

Part #	Description	Torque	
Material: Stainless Steel 316 (EN 1.4401)			
NUT0050S6	S316, 1/2" Rod, 0.5"	50 ft lb	100 pc
Material: Steel – Finish: Electrogalvanized			
NUT0025EG	EG, 1/4" Rod, 0.25"	6 ft lb	100 pc
NUT0037EG	EG, 3/8" Rod, 0.375"	19 ft lb	100 pc
NUT0050EG	EG, 1/2" Rod, 0.5"	50 ft lb	100 pc
NUT0062EG	EG, 5/8" Rod, 0.5"	50 ft lb	100 pc

Pull-Out Strength			
Part Number	Channel Type	Channel Thickness	
		12 GA	14 GA
NUT0025xx	A, C	450 lb	450 lb
	D, E	450 lb	–
NUT0025xx	A, C	1,100 lb	1,000 lb
	D, E	1,100 lb	–
NUT0025xx	A	2,000 lb	1,400 lb
	D, E	1,500 lb	–
NUT0025xx	A	2,000 lb	1,400 lb
	D, E	1,500 lb	–
NUT0025xx	A	2,000 lb	1,400 lb
	D, E	1,500 lb	–

## METAL FRAMING

### nVent CADDY Eristrut Strut Channel System

#### STRUT NUT WITH SPRING, CHANNEL TYPE A

- Used to create metal frames with nVent CADDY Eristrut channels
- Spring allows for easy installation



Material: Steel  
 Finish: Electrogalvanized  
 Static Load Safety Factor: 3:1

Part #	Description	Torque	
SPRA0025EG	EG, 1/4" Rod	6 ft lb	100 pc
SPRA0037EG	EG, 3/8" Rod	19 ft lb	100 pc
SPRA0050EG	EG, 1/2" Rod	50 ft lb	100 pc
SPRA0062EG	EG, 5/8" Rod	50 ft lb	100 pc

Pull-Out Strength		
Part Number	Channel Thickness	
	12 GA	14 GA
SPRA0025EG	450 lb	450 lb
SPRA0037EG	1,100 lb	1,000 lb
SPRA0050EG	2,000 lb	1,400 lb
SPRA0062EG	2,000 lb	1,400 lb

#### STRUT NUT WITH SPRING, CHANNEL TYPE C

- Used to create metal frames with nVent CADDY Eristrut channels
- Spring allows for easy installation



Material: Steel  
 Finish: Electrogalvanized  
 Static Load Safety Factor: 3:1

Part #	Description	Torque	
SPRC0025EG	EG, 1/4" Rod	6 ft lb	100 pc

Pull-Out Strength		
Part Number	Channel Thickness	
	12 GA	14 GA
SPRA0025EG	450 lb	450 lb



## METAL FRAMING

### nVent CADDY Eristrut Strut Channel System

#### STRUT NUT WITH TOP SPRING

- Used to create metal frames with nVent CADDY Eristrut channels
- Spring allows for easy installation

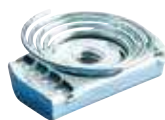

Material: Steel

Finish: Electrogalvanized

Static Load Safety Factor: 3:1

Part #	Description	Torque	
TSNT0025EG	EG, 1/4" Rod	6 ft lb	100 pc
TSNT0037EG	EG, 3/8" Rod	19 ft lb	100 pc
TSNT0050EG	EG, 1/2" Rod	50 ft lb	100 pc

Pull-Out Strength			
Part Number	Channel Type	Channel Thickness	
		12 GA	14 GA
TSNT0025EG	A, C	450 lb	450 lb
	D, E	450 lb	-
TSNT0037EG	A, C	1,100 lb	1,000 lb
	D, E	1,100 lb	-
TSNT0050EG	A	2,000 lb	1,400 lb
	D, E	1,500 lb	-

#### CLIP-ON STRUT NUT

- Easily snaps into strut using a screwdriver



Material: Spring Steel

Finish: nVent CADDY Armour



Part #	Description			
MFA4I	1/4" Hole, Threaded	100 lb	50 lb	100 pc
MFA625	1/4" Hole, w/Screw, 0.625" Screw	100 lb	50 lb	100 pc

# METAL FRAMING

## nVent CADDY Eristrut Strut Channel System

### STRUT CANTILEVER ARM TYPE A, SLOTTED

- Slotted channel
- Welded on flat mounting plate



Material: Steel  
Finish: Electrogalvanized

Part #	Description	
KA25H0150EG	EG, 6" x 1.625" x 1.625" x 0.098"	20 pc
KA25H0300EG	EG, 11.875" x 1.625" x 1.625" x 0.098"	10 pc
KA25H0450EG	EG, 17.75" x 1.625" x 1.625" x 0.098"	5 pc
KA25H0600EG	EG, 23.625" x 1.625" x 1.625" x 0.098"	1 pc

### SQUARE CHANNEL WASHER

- Use to secure objects to nVent CADDY Eristrut channels

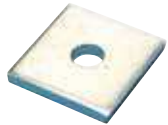

Material: Steel  
Finish: Electrogalvanized

Part #	Description	
F130000EG	EG, 5/16" Rod, 0.375" Hole	100 pc
F140000EG	EG, 3/8" Rod, 0.438" Hole	100 pc
F150000EG	EG, 1/2" Rod, 0.563" Hole	100 pc
F160000EG	EG, 5/8" Rod, 0.688" Hole	100 pc
F170000EG	EG, 3/4" Rod, 0.813" Hole	100 pc

## METAL FRAMING

### nVent CADDY Eristrut Strut Channel System

#### TWO HOLE FLAT BRACKET

- Used to create metal frames with nVent CADDY Eristrut channels



Material: Steel

Finish: Electrogalvanized

Part #	Description	
F090000EG	EG, 3.5"	50 pc
F220000EG	EG, 3.25"	50 pc

#### THREE HOLE FLAT BRACKET

- Used to create metal frames with nVent CADDY Eristrut channels



Material: Steel

Finish: Electrogalvanized

Part #	Description	
F200000EG	EG, 5.375"	25 pc

#### THREE HOLE FLAT CORNER BRACKET

- Used to create metal frames with nVent CADDY Eristrut channels



Material: Steel

Finish: Electrogalvanized

Part #	Description	
F360000EG	EG, 3.5" x 3.5"	25 pc

# METAL FRAMING

## nVent CADDY Eristrut Strut Channel System

### FOUR HOLE FLAT BRACKET

- Used to create metal frames with nVent CADDY Eristrut channels



Material: Steel  
Finish: Electrogalvanized

Part #	Description	
F230000EG	EG, 7.25"	25 pc

### FOUR HOLE FLAT CORNER BRACKET

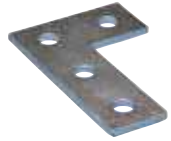

Material: Steel  
Finish: Electrogalvanized

Part #	Description	
F370000EG	3 1/2" x 5 3/8"	20 pc

### FOUR HOLE FLAT TEE PLATE

- Used to create metal frames with nVent CADDY Eristrut channels



Material: Steel  
Finish: Electrogalvanized

Part #	Description	
F250000EG	EG, 5.375" x 3.5"	20 pc

## METAL FRAMING

### nVent CADDY Eristrut Strut Channel System

#### FIVE HOLE FLAT CROSS BRACKET



Material: Steel  
Finish: Electrogalvanized

Part #	Description	
F280000EG	EG, 5.38" x 5.38"	15 pc

#### 1-1 HOLE ANGLE BRACKET

- Used to create metal frames with nVent CADDY Eristrut channels

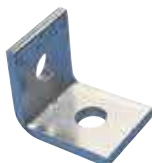

Material: Steel  
Finish: Electrogalvanized

Part #	Description	
L100000EG	EG, 2.25" x 1.625"	50 pc
L110000EG	EG, 2" x 1.875"	50 pc

#### 1-1 HOLE CLOSED CORNER ANGLE BRACKET

- Used to create metal frames with nVent CADDY Eristrut channels



Material: Steel  
Finish: Electrogalvanized

Part #	Description	
L470450EG	EG, 45° x 3.5" x 2.5"	25 pc

# METAL FRAMING

## nVent CADDY Eristrut Strut Channel System

### 1-1 HOLE OPEN CORNER ANGLE BRACKET

- Used to create metal frames with nVent CADDY Eristrut channels



Material: Steel  
Finish: Electrogalvanized

Part #	Description	
L460450EG	EG, 45°	25 pc

### 1-1 HOLE UNEQUAL LONG ANGLE BRACKET

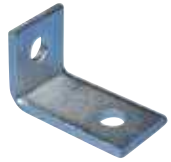

Material: Steel  
Finish: Electrogalvanized

Part #	Description	
L120300EG	3" x 1 7/8"	25 pc

### 1-2 HOLE CORNER ANGLE BRACKET

- Used to create metal frames with nVent CADDY Eristrut channels

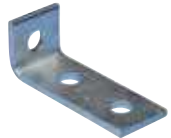

Material: Steel  
Finish: Electrogalvanized

Part #	Description	
L180000EG	EG, 3.5" x 2.5"	25 pc

## METAL FRAMING

### nVent CADDY Eristrut Strut Channel System

#### 1-2 HOLE CORNER SHORT ANGLE BRACKET

- Used to create metal frames with nVent CADDY Eristrut channels

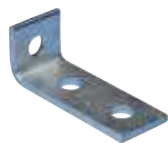

Material: Steel  
Finish: Electrogalvanized

Part #	Description	
L190000EG	EG, 3.875" x 1.875"	25 pc
L200000EG	EG, 4.125" x 1.625"	25 pc

#### 2-2 HOLE CORNER ANGLE BRACKET

- Used to create metal frames with nVent CADDY Eristrut channels



Material: Steel  
Finish: Electrogalvanized

Part #	Description	
L220000EG	EG, 4.125" x 3.5"	25 pc

#### 1-1 HOLE 45° ANGLE BRACE



Material: Steel  
Finish: Electrogalvanized

Part #	Description	
L441200EG	EG, 12" x 10.5"	20 pc
L441600EG	EG, 16" x 13.313"	1 pc

# METAL FRAMING

## nVent CADDY Eristrut Strut Channel System

### 3-3-1 HOLE CORNER GUSSET



Material: Steel  
Finish: Electrogalvanized

Part #	Description	
L23U0000EG	4 1/8" x 4 1/8"	15 pc

### SIX HOLE CORNER CONNECTOR, 3-WAY

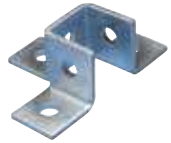

Material: Steel  
Finish: Electrogalvanized

Part #	Description	
W190000EG	1 5/8" x 5 7/16" x 2"	10 pc

### EIGHT HOLE DOUBLE CORNER CONNECTOR, 3-WAY

- Used to create metal frames with nVent CADDY Eristrut channels



Material: Steel  
Finish: Electrogalvanized

Part #	Description	
W170000EG	EG, 1.625" x 5.5" x 4"	10 pc



## METAL FRAMING

### nVent CADDY Eristrut Strut Channel System

#### NINE HOLE CORNER CONNECTOR, 3-WAY



Material: Steel  
Finish: Electrogalvanized



Part #	Description	
W200000EG	EG, 3.5" x 5.438" x 3.75"	25 pc

#### STRUT BEAM CLAMP WITH U-BOLT

- Complete with U-bolt and nuts
- Requires installation in pairs



Material: Steel  
Finish: Electrogalvanized

Part #	Description		
BC17A000EG	EG, A, C Strut	1,200 lb	25 pc
BC17D000EG	EG, AA, D, E Strut	1,200 lb	25 pc

Static Load is based on one pair of Strut Beam Clamps.

# METAL FRAMING

## nVent CADDY Eristrut Strut Channel System

### STRUT BEAM CLIP

- Beam Clip for clamping the open side of strut to a beam
- Suitable for all strut channels
- Requires installation in pairs
- Structural attachment to beams to support nVent CADDY Eristrut
- FM® Specification Tested

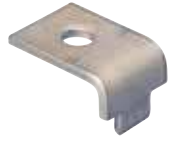

Material: Steel  
Finish: Electrogalvanized

Part #	Description	F	Box
BC200000EG	EG, 0.5" Flange, 0.563" Hole	460 lb	50 pc

Indicated loads are based on installation with 1/2" (M12) hardware and strut channel type A.

### STRUT BEAM CLAMP WITH BOLT, WINDOW SHAPE

- Complete with bolt
- Requires installation in pairs



Material: Steel  
Finish: Electrogalvanized

Part #	Description	F	Box
BC16A000EG	EG, A, CC Strut	740 lb	20 pc

## METAL FRAMING

### nVent CADDY Eristrut Strut Channel System

#### INTERNAL STRUT BEAM CLAMP WITH BOLT

- U-shaped clip for clamping the back of strut channel to a beam
- Hex bolt included
- Requires installation in pairs



Material: Steel

Finish: Electrogalvanized

Part #	Description	F	Box
BC180037EG	EG, 3/8" Screw	660 lb	25 pc

Static Load is based on one pair of Strut Beam Clamps. Include strut channel thickness when calculating flange thickness.

#### STRUT AND ROD BEAM CLAMP

- Multifunctional beam clamp suitable for strut channel or threaded rod
- Bolt included
- Requires installation in pairs



Material: Steel

Finish: Electrogalvanized



Part #	Description	F	Box
STCB6	3/8" Rod, 2" Max Flange	400 lb	10 pc

#### C-CLAMP FOR STRUT AND ROD

- Dual purpose beam clamp for rod and strut
- Conforms with Federal Specification WW-H-171 (Type 23), Manufacturers Standardization Society ANSI®/MSS-SP-58 (Type 23)



Material: Steel

Finish: Pregalvanized



Part #	Description	F	Box	Cert
200RS375	3/8" Rod, 5/8" Max Flange	250 lb	10 pc	cULus
200RS500	1/2" Rod, 5/8" Max Flange	360 lb	10 pc	

## METAL FRAMING

### nVent CADDY Eristrut Strut Channel System

#### BC23 INTERNAL STRUT BEAM CLAMP

- Kit of two inserts for A type channel
- Complete with pointed head hex bolts for easy installation



Material: Steel  
Finish: Electrogalvanized

Part #	Description	F ↓	☐
BC23A000EG	BC23 Internal Strut Beam Clamp	800 lb	25 pc

#### INC8 INTERNAL STRUT BEAM CLAMP

- Mounts strut within beams



Material: Spring Steel  
Finish: nVent CADDY Armour

Part #	Description	F ↓	☐
INC8T5	INC8 Internal Strut Beam Clamp	100 lb	100 pc

Strut channel must be cut 3/4" (20mm) shorter than the inner distance between the two beam flanges in order to accommodate the clamps.

#### POST BASE FOR STRUT TYPE A

- Post base to create metal frames for attachment to nVent CADDY Eristrut



Material: Steel  
Finish: Electrogalvanized

Part #	Description	☐
P11SQ000EG	EG, 6" x 6" x 3.5" x 0.81"	5 pc

## METAL FRAMING

### nVent CADDY Eristrut Strut Channel System

#### 45° POST BASE FOR STRUT TYPE A

- Post base to create metal frames for attachment to nVent CADDY Eristrut or nVent CADDY Pyramid

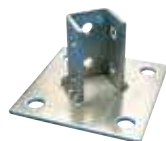

Material: Steel  
Finish: Electrogalvanized

Part #	Description	
P110000EG	EG, 6" x 6" x 3.5"	5 pc

#### 45° POST BASE FOR STRUT TYPE AA

- Post base to create metal frames for attachment to nVent CADDY Eristrut or nVent CADDY Pyramid

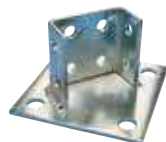

Material: Steel  
Finish: Electrogalvanized

Part #	Description	
P130000EG	EG, 6" x 3.5"	5 pc

#### RECTANGULAR POST BASE PLATE

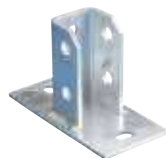

Material: Steel  
Finish: Hot-Dip Galvanized

Part #	Description	
ZGA512	3.94" x 6.3" x 3.15"	1 pc

# METAL FRAMING

## nVent CADDY Eristrut Strut Channel System

### FOUR HOLE EXTERNAL COUPLER

- Used to create metal frames with nVent CADDY Eristrut channels



Material: Steel  
Finish: Electrogalvanized

Part #	Description	
U24A0000EG	EG, A Strut	10 pc

### STRUT TRAPEZE ATTACHMENT PLATE

- Creates fast install trapeze brackets
- Includes hex bolt and strut nut



Material: Steel  
Finish: Electrogalvanized

Part #	Description	
ISSP375	3/8" Rod	100 pc

### STRUT TRAPEZE ATTACHMENT KIT

- Kit includes 2 strut trapeze attachment plates and 4 SN series nuts
- Creates fast install trapeze brackets

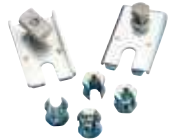

Material: Steel  
Finish: Electrogalvanized

Part #	Description		
ISSPK	3/8" Rod	500 lb	12 pc

Ultimate Static Load is based on one strut trapeze attachment plate supported by two SN Series Nuts. When evaluating the complete trapeze structure (Strut Trapeze Attachment Kit and strut member), deformation and material yield of the strut must be taken into consideration. The lesser of the loads should be used as the Ultimate Static Load.

## METAL FRAMING

### nVent CADDY Eristrut Strut Channel System

#### ESC STRUT ATTACHMENT CLIP

- Attaches to open side of a strut channel
- Designed to accept nVent CADDY Speed Link wire rope or hook



Material: Spring Steel  
Finish: nVent CADDY Armour



Part #	Description	F ↓	↓ Cube
ESC4	Plain	150 lb	100 pc

#### THREADED ROD TO STRUT CLIP

- Attaches to open side of a strut channel
- With threaded rod attachment



Material: Steel  
Finish: nVent CADDY Armour



Part #	Description	F ↓	↓ Cube
ESC4TI	1/4" Hole	150 lb	100 pc
ESC6TI	3/8" Hole	150 lb	100 pc

# Seismic Bracing Systems





# SEISMIC BRACING SYSTEMS

## Rigid Bracing

### STEEL FLANGE ADAPTER

- Meets requirements of the Buy American Act
- Installs on top or bottom flange of I-beams or bar joists Low profile easily fits between metal deck and steel structure
- Thumb spring retainer allows for ease of positioning
- Available pre-assembled to the Universal Structural Bracket, eliminating field assembly
- Snap-off bolt head helps enable easy installation and inspection of seismic sway braces
- Meets NFPA® 13 as pre-qualified for seismic applications
- FM® Specification Tested



Material: Steel  
Finish: Electrogalvanized



OSHPD

Part #	Description	
CSBS1	EG, 1/4"-3/4" Flange	10 pc
CSBS2	EG, 3/4"-1 1/4" Flange	10 pc

UL Loads			
Part Number	Flange Thickness	Perpendicular to Structure	Parallel to Structure
CSBS1xx	1/4" - 3/8"	3,000 lb	2,200 lb
	3/8" - 3/4"	3,000 lb	2,765 lb
CSBS2xx	3/4" - 1 1/4"	3,000 lb	2,500 lb

FM Loads								
Part Number	Horizontal Capacity per Installation Angle from Vertical							
	Perpendicular to Structure				Parallel to Structure			
	30° - 44°	45° - 59°	60° - 74°	75° - 90°	30° - 44°	45° - 59°	60° - 74°	75° - 90°
CSBS1xx	850 lb	1,780 lb	2,770 lb	2,840 lb	880 lb	1,430 lb	2,020 lb	2,410 lb
CSBS2xx	1,220 lb	2,140 lb	2,580 lb	2,870 lb	1,100 lb	1,820 lb	2,190 lb	2,680 lb

# SEISMIC BRACING SYSTEMS

## Rigid Bracing

### STEEL FLANGE ADAPTER ASSEMBLY

- Meets requirements of the Buy American Act
- Steel Flange Adapter and Universal Structural Bracket are preassembled, limiting work required in the field
- Installs on top or bottom flange of I-beams or bar joists. Low profile easily fits between metal deck and steel structure
- Thumb spring retainer allows for ease of positioning
- Integrated angle gauge easily displays brace member angle of installation
- Snap-off bolt head helps enable easy installation and inspection of seismic sway braces
- Works with 1" through 2" brace pipes to reduce inventory
- Meets NFPA® 13 as pre-qualified for seismic applications
- FM® Specification Tested



Material: Steel  
Finish: Electrogalvanized



Part #	Description	
CSBS1A	EG, 1/4"–3/4" Flange	5 pc

UL Loads			
Part Number	Flange Thickness	Perpendicular to Structure	Parallel to Structure
CSBS1A	1/4" - 3/8"	3,000 lb	2,200 lb
	3/8" - 3/4"	3,000 lb	2,765 lb

FM Loads								
Part Number	Horizontal Capacity per Installation Angle from Vertical							
	Perpendicular to Structure				Parallel to Structure			
	30° - 44°	45° - 59°	60° - 74°	75° - 90°	30° - 44°	45° - 59°	60° - 74°	75° - 90°
CSBS1A	850 lb	1,780 lb	2,770 lb	2,840 lb	880 lb	1,430 lb	2,020 lb	2,410 lb

# SEISMIC BRACING SYSTEMS

## Rigid Bracing

### ADJUSTABLE I-BEAM ADAPTER

- Meets requirements of the Buy American Act
- No loose parts
- No assembly required
- Snap-off bolt head helps enable easy installation and inspection of seismic sway braces
- Meets NFPA®-13 requirements for seismic sway bracing
- FM® Specification Tested



Material: Steel  
Finish: Electrogalvanized



Part #	Description	
CSBS3	EG, 1/4"-3/4" Flange, 4"-8 1/2"	10 pc
CSBS4	EG, 1/4"-3/4" Flange, 4"-14 1/2"	10 pc
CSBS5	EG, 3/4"-1 1/4" Flange, 4"-18"	5 pc

UL Loads			
Part Number	Flange Thickness	Perpendicular to Structure	Parallel to Structure
CSBS3	1/4" - 3/8"	3,000 lb	2,200 lb
	3/8" - 3/4"	3,000 lb	2,765 lb
CSBS4	1/4" - 3/8"	3,000 lb	2,200 lb
	3/8" - 3/4"	3,000 lb	2,765 lb
CSBS5	3/4" - 1 1/4"	3,000 lb	2,500 lb

FM Loads								
Part Number	Horizontal Capacity per Installation Angle from Vertical							
	Perpendicular to Structure				Parallel to Structure			
	30° - 44°	45° - 59°	60° - 74°	75° - 90°	30° - 44°	45° - 59°	60° - 74°	75° - 90°
CSBS3xx	1,180 lb	2,210 lb	2,830 lb	2,940 lb	820 lb	1,380 lb	2,080 lb	3,010 lb
CSBS4xx	1,180 lb	2,210 lb	2,830 lb	2,940 lb	820 lb	1,380 lb	2,080 lb	3,010 lb
CSBS5xx	1,220 lb	2,140 lb	2,580 lb	2,870 lb	1,100 lb	1,820 lb	2,190 lb	2,680 lb

# SEISMIC BRACING SYSTEMS

## Rigid Bracing

### MULTI ATTACHMENT

- Disperses load over two anchors
- Minimizes the number of installed braces needed for concrete and wood structures
- Ideal for deck installations
- Use for both lateral and longitudinal sway brace applications
- Meets NFPA®-13 requirements for seismic sway bracing



Material: Steel  
Finish: ElectroGalvanized



Part #	Description	
CSBMA050050EG	9/16" Hole 1, 9/16" Hole 2	10 pc
CSBMA050075EG	13/16" Hole 1, 9/16" Hole 2	10 pc

Mount to structure using holes indicated in HS1.

UL Loads		
Part Number	Service Pipe Size	Rating
CSBMA050050EG	1" - 12"	3,740 lb
CSBMA050075EG	1" - 12"	3,740 lb

FM Loads				
Part Number	Horizontal Capacity per Installation Angle from Vertical			
	30° - 44°	45° - 59°	60° - 74°	75° - 90°
CSBMA050050EG	3,290 lb	4,520 lb	5,540 lb	6,200 lb
CSBMA050075EG	3,290 lb	4,520 lb	5,540 lb	6,200 lb

# SEISMIC BRACING SYSTEMS

## Rigid Bracing

### STRUT SEISMIC HINGE

- Complete hinge assembly
- Ideal for attaching sway bracing to MEP system supports
- Attaches to strut trapezes and to structure



Material: Steel

Finish: Electrogalvanized

Part #	Description	
CSBSH00375EG	9/16" Hole 1, 7/16" Hole 2	10 pc
CSBSH00500EG	9/16" Hole 1, 9/16" Hole 2	10 pc
CSBSH00625EG	9/16" Hole 1, 11/16" Hole 2	10 pc
CSBSH00750EG	9/16" Hole 1, 13/16" Hole 2	10 pc

### STRUT SEISMIC HINGE BRACKET ASSEMBLY

- Used for installations where strut brace is parallel to structure
- One wrench size fits all required hardware, eliminating the need to change tools
- Shear-off head helps ensure correct torque and simplifies inspection
- Compatible with brace members of 12 GA strut type A



Material: Steel

Finish: Electrogalvanized



Part #	Description	
CSBUS1PA	9/16" Hole	20 pc
CSBUS2PA	13/16" Hole	20 pc

#### FM Loads – Brace Member: 12 GA Strut Channel

Part Number	Horizontal Capacity per Installation Angle from Vertical			
	30° - 44°	45° - 59°	60° - 74°	75° - 90°
CSBU1PA	1,690 lb	2,210 lb	2,660 lb	3,090 lb
CSBU2PA	1,480 lb	2,290 lb	2,860 lb	3,090 lb

# SEISMIC BRACING SYSTEMS

## Rigid Bracing

### UNIVERSAL STRUCTURAL BRACKET

- Meets requirements of the Buy American Act
- Universal design allows one product to attach directly to concrete, wood, bar joist or I-beam adapters
- Integrated angle gauge easily displays brace member angle of installation
- Snap-off bolt head helps enable easy installation and inspection of seismic sway braces
- Works with 1" through 2" brace pipes to reduce inventory
- Low profile minimizes prying effect on concrete fasteners
- Meets NFPA® 13 as pre-qualified for seismic applications
- FM® Specification Tested



Material: Steel  
Finish: Electrogalvanized



OSHPD



Part #	Description	
CSBU1	EG, 9/16" Hole	25 pc
CSBU2	EG, 13/16" Hole	25 pc

FM Loads				
Part Number	Horizontal Capacity per Installation Angle from Vertical			
	30° - 44°	45° - 59°	60° - 74°	75° - 90°
CSBU1xx	1,690 lb	2,210 lb	2,660 lb	3,090 lb
CSBU2xx	1,480 lb	2,290 lb	2,860 lb	3,090 lb

# SEISMIC BRACING SYSTEMS

## Rigid Bracing

### UNIVERSAL STRUCTURAL BRACKET, STRUT BRACE

- Meets requirements of the Buy American Act
- Used for installations where strut brace is perpendicular to structure
- One wrench size fits all required hardware, eliminating the need to change tools
- Shear-off head helps ensure correct torque and simplifies inspection
- Compatible with brace members of 12 GA strut type A



Material: Steel  
Finish: Electrogalvanized



Part #	Description	
CSBUS1	9/16" Hole	20 pc
CSBUS2	13/16" Hole	20 pc

Cut length for strut member is +/- 1" (25 mm) of measured length.

FM Loads – Brace Member: 12 GA Strut Channel				
Part Number	Horizontal Capacity per Installation Angle from Vertical			
	30° - 44°	45° - 59°	60° - 74°	75° - 90°
CSBUS1	2,010 lb	2,840 lb	3,420 lb	3,810 lb
CSBUS2	2,010 lb	2,840 lb	3,420 lb	3,810 lb

# SEISMIC BRACING SYSTEMS

## Rigid Bracing

### TRAPEZE SWAY BRACE, STRUT

- Meets requirements of the Buy American Act
- Seismically braces trapeze hangers
- Retrofit ability allows for the brace to be installed after the trapeze assembly is installed
- Compatible with brace members of 12 GA strut type A
- One wrench size fits all required hardware, eliminating the need to change tools
- Shear-off head helps ensure correct torque and simplifies inspection
- FM® Specification Tested



Material: Steel  
Finish: Electrogalvanized

Part #	Description	
CSBR2	3/8", 1/2", 5/8", 3/4" Rod	15 pc

Cut length for strut member is +/- 1" (25 mm) of measured length.

FM Loads — Brace Member: 12 GA Strut Channel				
Part Number	Horizontal Capacity per Installation Angle from Vertical			
	30° - 44°	45° - 59°	60° - 74°	75° - 90°
CSBR2	1,031 lb	1,812 lb	2,000 lb	2,231 lb



# SEISMIC BRACING SYSTEMS

## Rigid Bracing

### TRAPEZE SWAY BRACE, PIPE

- Meets requirements of the Buy American Act
- Seismically braces trapeze hangers
- Retrofit ability allows for the brace to be installed after the trapeze assembly is installed
- Works with brace members of schedule 40 pipe, EMT conduit, and rigid conduit
- One wrench size fits all required hardware, eliminating the need to change tools
- Shear-off head helps ensure correct torque and simplifies inspection
- FM® Specification Tested



Material: Steel  
Finish: Electrogalvanized

Part #	Description	
CSBR1	3/8", 1/2", 5/8", 3/4" Rod	15 pc

FM Loads					
Part Number	Brace Member	Horizontal Capacity per Installation Angle from Vertical			
		30° - 44°	45° - 59°	60° - 74°	75° - 90°
CSBR1	1" EMT Conduit	623 lb	881 lb	1,148 lb	1,148 lb
	1" Rigid Conduit	755 lb	1,109 lb	1,738 lb	1,738 lb
	1" Schedule 40 Pipe	755 lb	1,109 lb	1,738 lb	1,738 lb

# SEISMIC BRACING SYSTEMS

## Cable Bracing

### WIRE SPOOL

- Pre-stretched restraint cable



Material: Steel  
Finish: Pregalvanized, Painted



Part #	Description	Cable Length	F ↓
CSB12CBL	#12 Brace, Red	250'	600 lb
CSB18CBL	#18 Brace, White	250'	1,100 lb
CSB36CBL	#36 Brace, Blue	250'	2,800 lb

Cable is powder coated.

### WIRE SPOOL, STAINLESS STEEL

- Pre-stretched restraint cable



Material: Stainless Steel 316 (EN 1.4401)  
Static Load Safety Factor: 1.5:1

Part #	Description	Cable Length	F ↓
CSB12CBLSS	#12 Brace	250'	540 lb
CSB18CBLSS	#18 Brace	250'	1,040 lb
CSB36CBLSS	#36 Brace	250'	2,190 lb

# SEISMIC BRACING SYSTEMS

## Cable Bracing

### OVAL SLEEVE

- Creates secure loop ends
- Swage with swaging tools

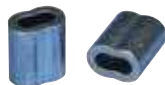

Part #	Description	
Material: Copper – Finish: Electrogalvanized		
CSB12SLVB	EG, #12 Brace	5 x 100 pc
CSB18SLVB	EG, #18 Brace	5 x 100 pc
CSB36SLVB	EG, #36 Brace	5 x 50 pc
Material: Stainless Steel 316 (EN 1.4401)		
CSB12SLVBSS	S316, #12 Brace	5 x 100 pc
CSB18SLVBSS	S316, #18 Brace	5 x 100 pc
CSB36SLVBSS	S316, #36 Brace	5 x 50 pc

Two side-by-side swages required on #12 and #18 cable. Three side-by-side swages required on #36 and #48 cable. Check swage with gauge (not included).

### UNIVERSAL RESTRAINT CLIP

- Attaches cable brace to structure



Part #	Description	Cert	
Material: Stainless Steel 316 (EN 1.4401)			
CSBURC38SS	S316, #12, #18, #36 Brace, 7/16" Hole		50 pc
CSBURC12SS	S316, #12, #18, #36 Brace, 9/16" Hole		50 pc
CSBURC58SS	S316, #12, #18, #36 Brace, 11/16" Hole		25 pc
Material: Steel – Finish: Electrogalvanized			
CSBURC38	EG, #12, #18, #36 Brace, 7/16" Hole	UL	50 pc
CSBURC12	EG, #12, #18, #36 Brace, 9/16" Hole	UL	50 pc
CSBURC58	EG, #12, #18, #36 Brace, 11/16" Hole	UL	25 pc

Mount to the structure using the center hole. Loop cable through the holes in the bent tabs and swage in place.

# SEISMIC BRACING SYSTEMS

## Cable Bracing

### UNIVERSAL RESTRAINT CLIP, SLOTTED

- Slotted design ideal for attaching to existing threaded rod on trapezes



Material: Steel  
Finish: Electrogalvanized

Part #	Description	
CSBURCR38	#12, #18 Brace, 3/8" Rod	50 pc
CSBURCR12	#12, #18 Brace, 1/2" Rod	50 pc
CSBURCR58	#12, #18 Brace, 5/8" Rod	25 pc

### NO PRY CLIP

- Eliminates prying effect on fasteners and anchors



Material: Steel  
Finish: Electrogalvanized



Part #	Description	
CSBNPC38	#12, #18, #36 Brace, 7/16" Hole	50 pc
CSBNPC12	#12, #18, #36 Brace, 9/16" Hole	50 pc
CSBNPC58	#12, #18, #36 Brace, 11/16" Hole	50 pc

# SEISMIC BRACING SYSTEMS

## Cable Bracing

### URC ATTACHMENT KIT

- Attaches cable brace to structure
- Two-way bracing kit with oval sleeves
- Wraps around structural steel members



Material: Steel  
Finish: ElectroGalvanized, Painted



Part #	Description	
Brace Size: #12 – Color: Red		
CSB2W12URC38L10	#12 Brace, , 7/16" Hole, 10' Brace Length	1 pc
CSB2W12URC38L20	#12 Brace, , 7/16" Hole, 20' Brace Length	1 pc
CSB2W12URC12L10	#12 Brace, , 9/16" Hole, 10' Brace Length	1 pc
CSB2W12URC12L20	#12 Brace, , 9/16" Hole, 20' Brace Length	1 pc
Brace Size: #18 – Color: White		
CSB2W18URC38L10	#18 Brace, , 7/16" Hole, 10' Brace Length	1 pc
CSB2W18URC38L20	#18 Brace, , 7/16" Hole, 20' Brace Length	1 pc
CSB2W18URC12L20	#18 Brace, , 9/16" Hole, 20' Brace Length	1 pc
Brace Size: #36 – Color: Blue		
CSB2W36URC12L10	#36 Brace, , 9/16" Hole, 10' Brace Length	1 pc
CSB2W36URC12L20	#36 Brace, , 9/16" Hole, 20' Brace Length	1 pc
CSB2W36URC58L10	#36 Brace, , 11/16" Hole, 10' Brace Length	1 pc
CSB2W36URC58L20	#36 Brace, , 11/16" Hole, 20' Brace Length	1 pc

### WIRE ROPE CUTTER

- Designed to reduce cable fraying



Material: Steel

Part #	Description
CSBC48	#36 Brace, 1/4" Max Cable Diameter

For brace sizes #12 and #18 use SLWC Wire Rope Cutter.

# SEISMIC BRACING SYSTEMS

## Cable Bracing

### MANUAL SWAGING TOOL



Material: Steel

Part #	Description
CSB12SBHS	#12 Brace

### MULTI-SIZE MANUAL SWAGING TOOL



Material: Steel

Part #	Description
CSB3346SB	#12, #18, #36 Brace

### BATTERY-OPERATED SWAGING TOOL

- Battery-operated tool provides consistent swaging
- Provides less strenuous installation when compared to manual swaging tools
- Cordless design allows installers to easily move around the job site
- Compatible with large diameter cables



Material: Steel



Part #	Description
CSBBS121836	#12, #18, #36 Brace

# SEISMIC BRACING SYSTEMS

## Branch Line Restraint System

### BRANCH LINE RESTRAINT STRUCTURE ATTACHMENT TO STEEL

- Swivel barrel nut accepts 3/8" or 1/2" (M10 or M12) threaded rod
- Attaches to steel members with self-drilling/tapping screw



Material: Steel  
Finish: Electrogalvanized



OSHPD



Part #	Description	
CSBBRS1EG	3/8", 1/2" Rod	50 pc

Branch line structural attachments are for restraint only and not for the hanging of fire sprinkler piping.

### BRANCH LINE RESTRAINT STRUCTURE ATTACHMENT TO WOOD/CONCRETE

- Swivel barrel nut accepts 3/8" or 1/2" (M10 or M12) threaded rod
- Attaches to wood or concrete where cracked concrete approval is not needed



Material: Steel  
Finish: Electrogalvanized



Part #	Description	
CSBBRS2EG	3/8", 1/2" Rod	50 pc

Branch line structural attachments are for restraint only and not for the hanging of fire sprinkler piping.

### BRANCH LINE RESTRAINT STRUCTURE ATTACHMENT TO THREADED HOLE

- Swivel barrel nut accepts 3/8" or 1/2" (M10 or M12) threaded rod
- Attaches to concrete anchors or structural attachments with female threads
- Can be used for bolting through steel



Material: Steel  
Finish: Electrogalvanized



OSHPD



Part #	Description	
CSBBRS3EG	3/8", 1/2" Rod	50 pc

Branch line structural attachments are for restraint only and not for the hanging of fire sprinkler piping.

# SEISMIC BRACING SYSTEMS

## Rod Stiffeners

### PIPE ROD STIFFENER

- For use with Schedule 40 or Schedule 10 pipe
- Secures pipe to threaded rod for stiffening



Material: Steel  
Finish: Electrogalvanized

Part #	Description	
CSBRS1	1" Brace Pipe, 3/8", 1/2", 5/8" Rod	10 x 10 pc

### STRUT ROD STIFFENER

- Secures strut channel to threaded rod for stiffening



Material: Steel  
Finish: Electrogalvanized

Part #	Description	
CSBRS37EG	3/8", 1/2", 5/8", 3/4" Rod	25 pc

### NVENT CADDY QUICK CLIP ROD STIFFENER

- Secures strut channel to threaded rod for stiffening
- One hand, snap-in place installation
- No tools or bolt tightening required



Material: Stainless Steel 316 (EN 1.4401)

Part #	Description	
CSBRS2	3/8" Rod	50 pc
CSBRS3	1/2" Rod	50 pc
CSBRS4	5/8" Rod	50 pc



# Bracing Systems Calculator

Now it's easier than ever to select the correct bracing products for use in fire protection applications. nVent has unveiled the Bracing Systems Calculator, a new web-based calculator which allows users to create and save designs for multiple projects while providing the necessary submittal forms. This time-saving calculator simplifies the selection of products and provides the necessary engineering calculations – providing a complete solution to support rigid bracing, cable bracing and branch line restraints.

## FEATURES

- No installation needed – access via a current web browser
- Offers dynamic design preview and uses visual design tools
- Generates a complete submittal and project materials list
- Create, manage, and re-use designs
- Supports NFPA® 13 including 2013 ed., IBC® and other building codes



Visual Design Tools

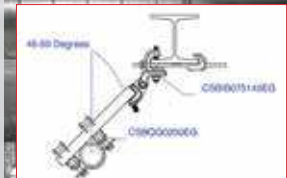

Dynamic Design Preview



Materials List

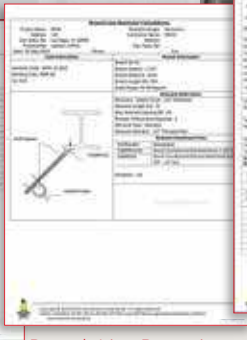

Branch Line Restraint Submittal



Seismic Brace Submittal

nVent is trusted for developing innovative and time-saving products for the fire and sprinkler bracing market. To request access to the Bracing Systems Calculator, contact your local nVent representative or visit [nVent.com/CADDY](http://nVent.com/CADDY)

# Reference



## REFERENCE

### Convenient Sizing Information

#### RIGID STEEL CONDUIT (Heavy-, or thick-Wall Conduit)

Nominal Conduit Size	Outside Diameter	Nominal Inside Diameter	Minimum Wt. Per 100 Ft. With Couplings Attached	Weight Of Conduit & Conductors Per 100 Ft.
3/8"	0.675 in.	0.493 in.	51.5 lbs.	65.1 lbs.
1/2"	0.840 in.	0.632 in.	79.0 lbs.	101.1 lbs.
3/4"	1.050 in.	0.836 in.	105.0 lbs.	145.8 lbs.
1"	1.315 in.	1.063 in.	153.0 lbs.	219.3 lbs.
1 1/4"	1.660 in.	1.394 in.	201.0 lbs.	318.3 lbs.
1 1/2"	1.900 in.	1.624 in.	249.0 lbs.	408.8 lbs.
2"	2.375 in.	2.083 in.	332.0 lbs.	593.8 lbs.
2 1/2"	2.875 in.	2.489 in.	527.0 lbs.	901.0 lbs.
3"	3.500 in.	3.090 in.	682.6 lbs.	1259.0 lbs.
3 1/2"	4.000 in.	3.570 in.	831.0 lbs.	1604.0 lbs.
4"	4.500 in.	4.050 in.	972.3 lbs.	1967.0 lbs.

#### INTERMEDIATE METAL CONDUIT

Nominal Conduit Size	Outside Diameter	Nominal Inside Diameter	Minimum Wt. Per 100 Ft. With Couplings Attached	Weight Of Conduit & Conductors Per 100 Ft.
1/2"	0.815 in.	0.745 in.	60.0 lbs.	82.1 lbs.
3/4"	1.029 in.	0.954 in.	82.0 lbs.	122.8 lbs.
1"	1.290 in.	1.205 in.	116.0 lbs.	182.3 lbs.
1 1/4"	1.638 in.	1.553 in.	150.0 lbs.	267.3 lbs.
1 1/2"	1.883 in.	1.793 in.	182.0 lbs.	341.8 lbs.
2"	2.360 in.	2.266 in.	242.0 lbs.	503.8 lbs.
2 1/2"	2.857 in.	2.727 in.	401.0 lbs.	775.0 lbs.
3"	3.476 in.	3.346 in.	493.0 lbs.	1069.0 lbs.
3 1/2"	3.971 in.	3.841 in.	573.0 lbs.	1346.0 lbs.
4"	4.466 in.	4.336 in.	638.0 lbs.	1632.0 lbs.

#### ELECTRICAL METALLIC TUBING (EMT) – (Thin-Wall Conduit)

Nominal Conduit Size	Outside Diameter	Nominal Inside Diameter	Minimum Wt. Per 100 Ft. With Couplings Attached	Weight Of Conduit & Conductors Per 100 Ft.
3/8"	0.577 in.	0.493 in.	23.0 lbs.	36.6 lbs.
1/2"	0.706 in.	0.622 in.	28.5 lbs.	50.6 lbs.
3/4"	0.922 in.	0.824 in.	43.5 lbs.	84.3 lbs.
1"	1.163 in.	1.049 in.	64.0 lbs.	130.3 lbs.
1 1/4"	1.510 in.	1.380 in.	95.0 lbs.	212.3 lbs.
1 1/2"	1.740 in.	1.610 in.	110.0 lbs.	269.8 lbs.
2"	2.197 in.	2.067 in.	140.0 lbs.	401.8 lbs.
2 1/2"	2.875 in.	2.731 in.	205.0 lbs.	579.0 lbs.
3"	3.500 in.	3.356 in.	250.0 lbs.	826.3 lbs.
3 1/2"	4.000 in.	3.834 in.	325.0 lbs.	1098.0 lbs.
4"	4.500 in.	4.334 in.	370.0 lbs.	1364.0 lbs.

Dimensions taken from ANSI™ C80.3-1977.

Conduit plus weight of heaviest conductor combination as specified by the National Electrical Code. ANSI is a trademark of American National Standards Institute, Inc.

## REFERENCE

### Convenient Sizing Information

#### RIGID ALUMINUM CONDUIT

Nominal Conduit Size	Outside Diameter	Nominal Inside Diameter	Minimum Wt. Per 100 Ft. With Couplings Attached	Weight Of Conduit & Conductors Per 100 Ft.
1/2"	0.840 in.	0.632 in.	27.4 lbs.	49.5 lbs.
3/4"	1.050 in.	0.836 in.	36.4 lbs.	77.2 lbs.
1"	1.315 in.	1.063 in.	53.0 lbs.	119.3 lbs.
1 1/4"	1.660 in.	1.394 in.	69.6 lbs.	186.9 lbs.
1 1/2"	1.900 in.	1.624 in.	82.2 lbs.	242.0 lbs.
2"	2.375 in.	2.083 in.	115.7 lbs.	377.5 lbs.
2 1/2"	2.875 in.	2.489 in.	182.5 lbs.	556.5 lbs.
3"	3.500 in.	3.090 in.	238.9 lbs.	815.2 lbs.
3 1/2"	4.000 in.	3.570 in.	287.7 lbs.	1061.0 lbs.
4"	4.500 in.	4.050 in.	340.0 lbs.	1334.0 lbs.
5"	5.563 in.	5.073 in.	465.4 lbs.	2028.0 lbs.
6"	6.625 in.	6.093 in.	612.5 lbs.	2870.0 lbs.

Dimensions taken from ANSI™ C80.5-1977. Conduit plus weight of heaviest conductor combination as specified by the National Electrical Code.

#### SCHEDULE 40 PVC PLASTIC PIPE

Nominal Pipe Size	Outside Diameter	Wall Thickness	Weight Of Pipe	Weight Of Water
1/8"	.405 in.	.068 in.	.04 lbs./ft.	.02 lbs./ft.
1/4"	.540 in.	.088 in.	.07 lbs./ft.	.04 lbs./ft.
3/8"	.675 in.	.091 in.	.10 lbs./ft.	.08 lbs./ft.
1/2"	.840 in.	.109 in.	.15 lbs./ft.	.1 lbs./ft.
3/4"	1.050 in.	.113 in.	.2 lbs./ft.	.2 lbs./ft.
1"	1.315 in.	.133 in.	.3 lbs./ft.	.4 lbs./ft.
1 1/4"	1.660 in.	.140 in.	.4 lbs./ft.	.6 lbs./ft.
1 1/2"	1.900 in.	.145 in.	.5 lbs./ft.	.9 lbs./ft.
2"	2.375 in.	.154 in.	.6 lbs./ft.	1.4 lbs./ft.
2 1/2"	2.875 in.	.203 in.	1.0 lbs./ft.	2.1 lbs./ft.
3"	3.500 in.	.216 in.	1.3 lbs./ft.	3.2 lbs./ft.
3 1/2"	4.000 in.	.226 in.	1.6 lbs./ft.	4.3 lbs./ft.
4"	4.500 in.	.237 in.	1.9 lbs./ft.	5.5 lbs./ft.

ANSI is a trademark of American National Standards Institute, Inc.

## REFERENCE

### Convenient Sizing Information

#### ALL THREADED ROD (ATR)

Nominal Size and Thread	Root Area		Design Load (SF = 5)	
1/4" - 20	0.027 in. <sup>2</sup>	0.174 cm <sup>2</sup>	240 lbs.	1.07 kN
5/16" - 18	0.045 in. <sup>2</sup>	0.290 cm <sup>2</sup>	400 lbs.	1.78 kN
3/8" - 16	0.068 in. <sup>2</sup>	0.438 cm <sup>2</sup>	610 lbs.	2.71 kN

Dimensions taken from ANSI™ B1.1-1982 Unified Inch Screw Threads.

All threads are UNCR series.

Tabulated loads are based on an allowable tensile stress of 12000 psi (82.7 MPa) reduced by 25% resulting in 9000 psi (62 MPa). From ANSI®/MSS SP-58, Table 3.

ANSI is a trademark of American National Standards Institute, Inc.

#### MC CABLE

AWG Size	Nominal Outer Diameter in Inches	
	Insulated Ground	Bare Ground
14-2 Solid	.450	.430
14-3 Solid	.480	.435
14-4 Solid	.510	.485
12-2 Solid	.495	.465
12-3 Solid	.530	.500
12-4 Solid	.565	.560
10-2 Solid	.560	.520
10-3 Solid	.600	.550
10-4 Solid	.645	.615
8-2 Strd.	.710	.675
8-3 Strd.	.770	.710
8-4 Strd.	.835	.770
6-2 Strd.	.795	.755
6-3 Strd.	.865	.800
6-4 Strd.	.945	.865
4-2 Strd.	.945	.895
4-3 Strd.	1.035	.945
4-4 Strd.	1.135	1.035
2-2 Strd.	1.075	1.015
2-3 Strd.	1.180	1.075
2-4 Strd.	1.295	1.180

# REFERENCE

## Convenient Sizing Information

### AC CABLE

Type Of Armored Cable	Type Of Circuit Conductor	AWG Size Of Circuit Conductors	Minimum External Diameter of Armor (Inches)					
			Cable with Two Circuit Conductors and No Grounding Conductor	Cable with Three Circuit Conductors and No Grounding Conductor and Cable with Two Circuit Conductors and Grounding Conductor	Cable with Four Circuit Conductors and No Grounding Conductor and Cable with Three Circuit Conductors and a Grounding Conductor	Cable with Four Circuit Conductors and a Grounding Conductor	Solid	Stranded
ACTMM	THHN	14	0.433	0.453	0.486	0.522	0.486	0.522
		12	0.467	0.489	0.520	0.545	0.520	0.545
		10	0.476	0.500	0.541	0.587	0.541	0.587
		8	0.570	0.604	0.654	0.714	0.654	0.714
		6	0.700	0.739	0.807	0.882	0.807	0.882
		4	0.836	0.885	0.970	1.066	0.970	1.066
		2	0.956	1.014	1.115	1.228	1.115	1.228

## REFERENCE

### The nVent CADDY Fastener Story

## QUALITY CONTROL

---

Fasteners, manufactured by nVent CADDY, are produced from spring steel, galvanized steel, plastic, as well as other materials. We are known in the industry as a leader in the design and production of Spring Steel Fasteners. The following is the story of how we manufacture these quality Spring Steel Fasteners.

## MANUFACTURING

---

The steel for Fasteners is procured in mill lots to AISI and nVent Standards; other materials are equally controlled.

## LOAD RATING

---

Fasteners are designed with two load limits:

- 1) Static load limit is a rated stationary load limit for a fastener. nVent Standards require that test samples with stand a load equal to three times this catalog rating.
- 2) The ultimate static load limit is the rated stationary load limit which, if exceeded, may cause failure of the fastener. nVent Standards require that test samples with stand this catalog rating. Some Fasteners also are designed with an undefined rating and are to be used for positioning only with no loading on them.
- 3) Applications and load ratings may change without notice. Refer to instruction sheet in box or contact nVent for current load and application information.

Static load limit and ultimate static load limit values specify maximum allowable installed loads for user applications. These values are for loads applied VERTICALLY to the normal fastener installation except as may be diagrammed otherwise. Where the load rating of the Fastener exceeds that of the structural member, the lowest rated item must set the load limit.

**NOTE:** Fasteners are intended for support of electrical components at stationary loads. Not to be used for dynamic loads such as fluid and gas distribution components, etc.

## IMPORTANT

Fasteners used with wire, rod, or threaded rod are designed for use with coarse round wire, hot rolled carbon steel bar, cold rolled carbon steel bar and threaded rod all meeting AISI specifications and tolerances.

## REFERENCE

### The nVent CADDY Fastener Story

## QUALITY ASSURANCE

---

Incoming steel is sampled and inspected for conformance to AISI specifications and nVent Standards. Test fixtures and procedures for development and quality control are designed to simulate normal field applications. Fasteners are tested, on a sample basis, to nVent Standards by certified inspectors. Testing of specific quantities of Fasteners to destruction in special statistical audits ensures a continuous high level of quality.

## HEAT TREATING

---

nVent CADDY Spring Steel Fasteners are heat treated in modern shaker hearth furnaces. Precision controls maintain heat treat operations within the established limits developed by nVent for Fasteners. nVent Standards incorporate consideration of fastener material and application.

Fasteners are conveyed directly from the high temperature furnace to the quench tank, through a cleaning cycle and into the tempering furnace. The complete heat treat cycle is automatically controlled.

## PRODUCTION PRESSES

---

Fasteners are produced with modern presses and precision tooling. Presses and tools are designed for close tolerance stamping.

## RESEARCH AND DEVELOPMENT

---

nVent Research and Development department is constantly working on new Fasteners and, at the same time, improving the present line. Starting with six basic Fasteners, the line now has several hundred basic types. The majority of the Fastener line is the result of nVent development of Fasteners to provide a solution for a customer's problem.

**NOTE:** Special applications not specified MUST be submitted to nVent for engineering approval and load rating.

All cULus Listed Fasteners meet the requirements of one of the following UL standards: UL1565, UL2239 or UL514B.



## REFERENCE

### Materials & Finishes

## MATERIALS – METALS

---

### Steel

Steel is an alloy of iron and other elements, the most common being Carbon. Varying the amount of alloying elements and the form of their presence in the steel controls qualities such as the hardness, ductility, tensile strength and corrosion resistance of the resulting steel.

### Stainless Steel

Stainless Steel is an alloy of iron and carbon that is more resistant to rust, staining and corrosion than regular steel.

### Stainless Steel 304 (1.4301)

The most familiar stainless steel is Type 304, containing 18-20% chromium and 8-10% nickel.

- Also referred to as 'A2'

### Stainless Steel 316 (1.4401)

The second most common stainless steel is 316, also called marine grade stainless, used primarily for its increased resistance to corrosion.

- Also referred to as 'A4'

### Spring Steel

Spring steel is an alloy of iron and Carbon. Spring steel alloys can be easily formed into complex shapes, and then heat-treated to greatly increase strength.

\*Note: Spring steel Fasteners are for indoor use in non-corrosive environments. Mild steel Fasteners can be used outdoors in humid or mildly corrosive environments. Not to be used in certain areas such as over indoor pools, etc.

### Stainless Spring Steel 301

A highly ductile steel used on formed products that hardens rapidly during mechanical working. Stainless 301 has better wear resistance and fatigue strength than Stainless 304 or standard Spring Steel.

### Cast Iron

Cast Iron is a commercial alloy of iron, carbon and silicon that is cast in a mold. This results in a product that is hard, brittle, non-malleable and incapable of being hammer-welded but more easily fusible than steel.

## REFERENCE

### Materials & Finishes

## MATERIALS – PLASTICS AND RUBBERS

---

### Plastics versus thermosets

- Thermoplastics will melt and flow when heated.
- Thermosets have undergone an irreversible chemical reaction and additional heat will not melt them further.

### Polyethylene (PE)

Polyethylene is a tough, light, flexible synthetic resin and is the most common thermoplastic. Many different grades exist with a broad range of physical properties.

### Polypropylene (PP)

Polypropylene is a thermoplastic that is light, rugged and resistant to many chemical solvents, bases and acids. It is typically tough and flexible.

### Polyvinyl Chloride (PVC)

Polyvinyl chloride (abbreviated PVC), is a thermoplastic made from a tough, chemically resistant synthetic resin. Unplasticized PVC is stiff and strong, but can be made softer and more flexible by the addition of plasticizers.

### EPDM Rubber

EPDM (Ethylene Propylene Diene Monomer) is a thermoset elastomer that is inherently resistant to ozone, water and weather, and characterized by a wide range of applications.

### SBR Rubber

SBR (Styrene Butadiene Rubber) is the most common type of synthetic rubber. This thermoset has good abrasion resistance, flexibility, and aging stability when protected by additives.

### Nylon

Nylon is part of a family of thermoplastics known generically as polyamides. It is generally characterized by its durability, high elongation and excellent abrasion resistance.

### Polyamide

See nylon

### Xenoy

Xenoy is a thermoplastic blend that offers good chemical resistance, great impact resistance (even at low temperatures), and some heat resistance in conditions that require a high degree of toughness.

### Polyisocyanurate

Polyisocyanurate (also called PIR, polyiso, or ISO) is a cellular, thermoset that is typically produced as a foam and used in rigid thermal insulation. As a result of its excellent thermal insulating efficiency, polyiso foam has become the standard for low temperature insulation applications.

### Hydrous Calcium Silicate

Hydrous calcium silicate is an asbestos-free insulating material that can be molded into rigid shapes and forms for applications where precise temperature control, personnel protection and energy savings are required.

## REFERENCE

### Materials & Finishes

## FINISHES

---

### Painted

Paint is any liquid composition, which after application to a surface in a thin layer, is converted to a solid film. It is most commonly used to protect, color or provide texture to objects.

### nVent CADDY ARMOUR

The Armour coating system features bi-metallic corrosion protection with an inorganic basecoat for sacrificial protection and an organic topcoat for barrier protection. The nVent standard for Armour includes at least 1,000 hours resistance against red rust when tested per the ASTM B117 and DIN 50021 salt spray tests. Armour is RoHS compliant.

### Electro-galvanized (EG)

ASTM B633

This corrosion protective coating is applied after the fabrication of steel or malleable iron parts and uses an electrolytic plating process that deposits zinc. A second passivation coating of chromate is then applied for additional protection. Zinc electroplate products are recommended for indoor and mildly corrosive applications.

### Pre-galvanized Zinc (PG)

ASTM A653/A653M

Pre-galvanized zinc is produced by continuously rolling steel coils or sheets through molten zinc at the mills. The coils or sheets are slit to size and fabricated by forming, shearing or punching to produce the finished product. During fabrication cut edges are not generally zinc coated; however, the zinc near the uncoated metal

becomes a sacrificial anode to protect the bare areas.

Pre-galvanized zinc products are generally recommended for indoor use on mildly corrosive environments.

### Hot Dip Galvanized Zinc (HDG)

ASTM A123

After a product has finished its fabrication process, it is dipped into a bath of molten zinc. The zinc completely coats all edges and surfaces. Zinc thickness is controlled by the time the part is immersed in the molten zinc bath. Hot dip galvanized zinc products are recommended for indoor, outdoor and mildly corrosive environments.

### Black Oxide

ASTM D769

Black oxide or blackening is a conversion coating for ferrous materials, copper and copper based alloys, zinc, powdered metals, and silver solder. It is used to add mild corrosion resistance and for appearance.

### Copper Electro-Plated

Copper plating is the process in which a thin layer of copper is deposited on an item via an electric current.

### Epoxy Powder Coated

Epoxy powder coating is applied electrostatically as a free-flowing, dry powder and finished by curing under heat to form a "skin". It is typically used to create a durable, hard wearing finish that is tougher than conventional paint.

# Index

<b>Part No.</b>	<b>Page</b>	<b>Part No.</b>	<b>Page</b>	<b>Part No.</b>	<b>Page</b>
0070037EG	9-8	035RS1600EG	2-10	4BRT20	5-50
0070050EG	9-8	035RS1800EG	2-10	4BRT20WS	5-50
0070075EG	9-8	0413704PL	2-51	4BRT32	5-50
0070100EG	9-8	0413706PL	2-51	4BRT32WS	5-50
0070125EG	9-8	0413708PL	2-51	4BRT64	5-50
0070150EG	9-8	0413710PL	2-51	4EBN	2-50
0070200EG	9-8	0415004PL	2-51	4G16	8-24
0100025EG	2-54	0415006PL	2-51	4G162	8-24
0100025PL	2-54	0415008PL	2-51	4G162WH	8-24
0100037EG	2-54	0422515EG	2-52	4G16H	8-24
0100037PL	2-54	0422520EG	2-52	4G16HWH	8-24
0100050EG	2-54	0423715EG	2-52	4G16LN	8-23
0100050PL	2-54	0423720EG	2-52	4G16LS	8-23
0100062EG	2-54	0423725EG	2-52	4G16WH	8-24
0100062PL	2-54	0423730EG	2-52	4G24	8-25
0100075EG	2-54	0425020EG	2-52	4G8	8-26
0100075PL	2-54	0425025EG	2-52	4G8S7	8-26
0100087EG	2-54	0425030EG	2-52	4G8S7WH	8-26
010H0037EG	2-55	0431602EG	2-52	4G8WB	8-26
010H0050EG	2-55	0502506EG	2-47	4G8WH	8-26
010H0062EG	2-55	0502510EG	2-47	4G8WHWB	8-26
010H0075EG	2-55	0503706EG	2-47	4G9	8-25
0110025EG	2-55	0503710EG	2-47	4G9LS	8-25
0110025PL	2-55	0503712EG	2-47	4H1318	2-18
0110037EG	2-55	0505006EG	2-47	4H24	2-18
0110037PL	2-55	0505010EG	2-47	4H24SS	2-18
0110050EG	2-55	0505012EG	2-47	4H24ST3	1-16
0110050PL	2-55	0506206EG	2-47	4H58	2-18
0110062EG	2-55	0506210EG	2-47	4H58SS	2-18
0110062PL	2-55	0506212EG	2-47	4H58ST3	1-16
0110075EG	2-55	0507510EG	2-47	4H912	2-18
0110075PL	2-55	0507512EG	2-47	4H912SS	2-18
0110087EG	2-55	0508706EG	2-47	4J2438	2-25
0120025EG	2-56	0508710EG	2-47	4J2438S	2-25
0120037EG	2-56	0513702PL	2-48	4LCB	8-17
0120050EG	2-56	2B15LS	8-16	4QTI	2-39
0250025EG	2-48	2BRT12	5-50	4QTI24	2-19
0250037EG	2-48	2BRT20	5-50	4QTI58	2-19
0250050EG	2-48	2BRT32	5-50	4QTI912	2-19
0250062EG	2-48	2BRT8	5-50	4QTIAFAB3	2-43
0250075EG	2-48	2FMP28	5-51	4QTIB	2-40
0250087EG	2-48	2G9	8-26	4QTIBC	2-20
025R3725EG	2-49	2G9S10	8-26	4QTIBSF	2-41
025R5037EG	2-49	2G9S10WB	8-26	4QTIGBSF	2-42
025R6250EG	2-49	2G9WB	8-26	4QTI0	2-43
035RS0600EG	2-10	2H4	2-18	4TGS	8-28
035RS0800EG	2-10	4ACS	8-6	4TI	2-36
035RS1000EG	2-10	4B15L	8-15	4TI24	2-18
035RS1200EG	2-10	4B15LS	8-16	4TI58	2-18
035RS1400EG	2-10	4B2LS	8-16	4TI912	2-18

# Index

Part No.	Page	Part No.	Page	Part No.	Page
4TIAFAB3	2-38	6TA58	2-18	12P58SM	1-4
4TIB	2-36	6TA912	2-18	12P912	1-3
4TIBGBSF	2-37	6TAFAB3	2-38	12P912SM	1-4
4TIBSF	2-37	6TB	2-36	12PATA	8-9
4TIO	2-38	6TI	2-36	12PATS	8-10
4TW	2-51	6TI24	2-18	12PF	4-22
4WN	8-28	6TI58	2-18	12PSF	1-18
4Z34	2-46	6TI912	2-18	12PZSF	1-18
4Z3412P	1-33	6TIAFAB3	2-38	16D15L	8-15
4Z3416M	1-32	6TIB	2-36	16M	1-40
4Z3416P	1-33	6TIBGBSF	2-37	16M24	1-6
4Z346M	1-32	6TIBSF	2-37	16M24SM	1-8
4Z34812M	1-32	6TIO	2-38	16M4I	1-40
4Z348P	1-33	6TO	2-38	16M58	1-6
4Z4S	2-46	6W	2-51	16M58SM	1-8
6A	2-31	6Z34	2-46	16M912	1-6
6A24	2-19	6Z3412P	1-33	16M912SM	1-8
6A58	2-19	6Z3416M	1-32	16MATA	8-8
6A912	2-19	6Z3416P	1-33	16MATS	8-9
6AB	2-32	6Z346M	1-32	16MB18	1-51
6ASF	2-32	6Z34812M	1-32	16MB1824	1-49
6M	1-40	6Z348P	1-33	16MB1824CO	1-50
6M24	1-6	6Z4S	2-46	16MB1858	1-49
6M24SM	1-8	8D15L	8-15	16MB1858CO	1-50
6M3B18ACO	1-49	8P	1-39	16MB186	1-51
6M3B18CO	1-52	8P12P	1-42	16MB186CO	1-52
6M4I	1-40	8P16P	1-42	16MB18A	1-47
6M58	1-6	8P24	1-3	16MB18ACO	1-48
6M58SM	1-8	8P24SM	1-4	16MB18CO	1-52
6M912	1-6	8P4I	1-39	16MB18CPNAM	1-53
6M912SM	1-8	8P58	1-3	16MCPNAM	1-21
6MATA	8-8	8P58SM	1-4	16MF	4-21
6MATS	8-9	8P8P	1-42	16MSF	1-17
6MB18	1-51	8P912	1-3	16MTDH	1-20
6MB1824	1-49	8P912SM	1-4	16MZSF	1-17
6MB1824CO	1-50	8PATA	8-9	16P	1-39
6MB1858	1-49	8PATS	8-10	16P16P	1-42
6MB1858CO	1-50	8PF	4-22	16P24	1-3
6MB186	1-51	8PSF	1-18	16P24SM	1-4
6MB186CO	1-52	8Z34	2-46	16P4I	1-39
6MB18A	1-47	8Z34812M	1-32	16P58	1-3
6MB18ACO	1-48	8Z4S	2-46	16P58SM	1-4
6MB18CO	1-52	12D15L	8-15	16P912	1-3
6MB18CPNAM	1-53	12P	1-39	16P912SM	1-4
6MCPNAM	1-21	12P12P	1-42	16PATA	8-9
6MF	4-21	12P16P	1-42	16PF	4-22
6MSF	1-17	12P24	1-3	16PSF	1-18
6MZSF	1-17	12P24SM	1-4	16PZSF	1-18
6T	2-36	12P4I	1-39	20D15L	8-15
6TA24	2-18	12P58	1-3	20M	1-40

# Index

Part No.	Page	Part No.	Page	Part No.	Page
20M24	1-6	515	8-2	812MF	4-21
20M24SM	1-8	515A	8-2	812MSF	1-17
20M4I	1-40	515AWHA	8-2	812MTDH	1-20
20M58	1-6	517A	8-3	812MZSF	1-17
20M58SM	1-8	517B	8-3	1224TI	2-22
20M912	1-6	517C	8-3	1226A	2-21
20M912SM	1-8	520	8-3	1226T	2-22
20MCPNAM	1-21	528	8-5	1226TI	2-22
20MF	4-21	708	2-33	1236M	1-27
20MTDH	1-20	708AB	2-34	1616M	1-42
24M	1-40	708AFAB3	2-35	1620M	1-42
24M24	1-6	708AO	2-35	51212	8-18
24M24SM	1-8	708GBSF	2-34	51220	8-18
24M4I	1-40	708SF	2-33	51230	8-18
24M58	1-6	766A	4-2	70824	2-20
24M58SM	1-8	766PM	4-3	70858	2-20
24M912	1-6	766PMD	4-3	122708	2-21
24M912SM	1-8	740	2-56	389001	9-5
24MCPNAM	1-21	766	4-2	389002	9-5
32M	1-40	770	8-11	389003	9-5
32M24	1-6	771	8-10	389004	9-5
32M24SM	1-8	781	4-33	389005	9-5
32M4I	1-40	812M	1-40	389006	9-5
32M58	1-6	812M1318	1-6	389007	9-5
32M58SM	1-8	812M24	1-6	389008	9-5
32M912	1-6	812M24SM	1-8	389009	9-5
32M912SM	1-8	812M4I	1-40	389011	9-5
122	2-14	812M58	1-6	389012	9-5
123	2-15	812M58SM	1-8	389013	9-5
166M	1-42	812M6MB18CO	1-52	389014	9-5
200RS375	11-24	812M912	1-6	389015	9-5
200RS500	11-24	812M912SM	1-8	389017	9-5
304B2	4-25	812MATA	8-8	389018	9-5
350	4-12	812MATS	8-9	389069	9-6
449	4-20	812MB18	1-51	389071	9-6
459	4-30	812MB1824	1-49	708912	2-20
510HD	8-21	812MB1824CO	1-50	12312P	1-27
510HDTC	8-21	812MB1858	1-49	12316M	1-27
51220A	8-18	812MB1858CO	1-50	12316P	1-27
512	8-18	812MB186	1-51	12320M	1-27
512A	8-18	812MB186CO	1-52	123812M	1-27
512ATC	8-18	812MB188Z	1-51	1450037EG	2-62
512HD	8-19	812MB18A	1-47	1450050EG	2-62
512HDEEP	8-19	812MB18ACO	1-48	16812M	1-42
512HDEEPTC	8-19	812MB18CO	1-52	2000037EG	2-8
512HDFM35	8-11	812MB18CPNAM	1-53	3000037EG	2-2
512HDFM70	8-11	812MB18S	1-47	3000037PL	2-2
512HDTC	8-19	812MB18SCO	1-48	3000050EG	2-2
512HDXT	8-20	812MB18TDH	1-54	3000050PL	2-2
512TC	8-18	812MCPNAM	1-21	3000062EG	2-2

# Index

Part No.	Page	Part No.	Page	Part No.	Page
3000062PL	2-2	A1BD0N	3-8	A1SF2GS	3-2
3000075EG	2-2	A1BF0G	3-8	A1SF3G	3-2
3000075PL	2-2	A1BF0G40N	3-9	A1SFV1G	3-3
3000087EG	2-2	A1BF0G40NAO	3-9	A1SFV1GS	3-3
3000087PL	2-2	A1BF0GD0N	3-9	A1SFV2G	3-3
3050037S4	2-4	A1BF0GD0NS	3-9	A1SFV2GS	3-3
3050050S4	2-4	A1BF0GS	3-8	A3308AP100	2-53
3100037EG	2-3	A1BF1G	3-5	A927W001P100	10-21
3100037PL	2-3	A1BF1G41N	3-6	A927W002P100	10-21
3100050EG	2-3	A1BF1G41NAO	3-6	A927W003P100	10-21
3100050PL	2-3	A1BF1G51N	3-6	A927W004P100	10-21
3150037EG	2-14	A1BF1GD1N	3-6	A927W005P100	10-21
3150037PL	2-14	A1BF1GD1NS	3-6	A927W006P100	10-21
35012P	4-21	A1BF1GF1N	3-6	A927W007P100	10-21
35016M	4-20	A1BF1GS	3-5	A927W008P100	10-21
35016P	4-21	A1BF2G	3-5	A927W009P100	10-21
350812M	4-20	A1BF2G41N	3-6	A927W010P100	10-21
3508P	4-21	A1BF2G41NAO	3-6	A927W011P100	10-21
3520100PL	2-30	A1BF2G51N	3-6	A927W012P100	10-21
3520200PL	2-30	A1BF2GD1N	3-6	A927W013P100	10-21
3520300PL	2-30	A1BF2GS	3-5	A927W014P100	10-21
3650037CP	2-29	A1BF3G	3-5	A927W016P100	10-21
3650037EG	2-29	A1BFV1G	3-7	A927W018P100	10-21
3650037PL	2-29	A1BFV1GDV1N	3-7	A927W019P100	10-21
365M0037CP	2-29	A1BFV1GDV1NS	3-7	A927W020P100	10-21
365M0037EG	2-29	A1BFV1GS	3-7	A927W021P100	10-21
365M0037PL	2-29	A1BFV2G	3-7	A927W022P100	10-21
365M0050CP	2-29	A1F1218	3-14	AB	2-45
365M0050EG	2-29	A1FF0G	3-13	AB375	2-45
365M0050PL	2-29	A1FF0GS	3-13	ABGBSF	2-44
51220A	8-18	A1FF1G	3-11	ABSF	2-44
5288P	8-5	A1FF1GS	3-11	ABTSF	2-39
A121000PG	11-5	A1FF2G	3-11	ADK421	11-9
A12AH100PG	11-6	A1FF2GS	3-11	ADK421GN	11-9
A12AH200GN	11-6	A1FFV1G	3-12	ADK421GY	11-9
A12AH200PG	11-6	A1FFV2G	3-12	ADK421RD	11-9
A12H1000GN	11-5	A1SD0G	3-4	AF14	2-15
A12H1000HD	11-5	A1SD0N	3-4	AF144TI	2-23
A12H1000PG	11-5	A1SD0NS	3-4	AF146A	2-22
A12H1000S4	11-5	A1SD1N	3-2	AF146T	2-23
A12H2000GN	11-5	A1SD1NS	3-2	AF146TI	2-23
A12H2000HD	11-5	A1SF0G	3-4	AF14708	2-23
A12H2000PG	11-5	A1SF0GS	3-4	AFAB3	2-45
A141000PG	11-5	A1SF0GSBUSP250	3-4	AFAB4	2-45
A14H1000GN	11-5	A1SF0N	3-4	AFAB6	2-45
A14H1000PG	11-5	A1SF0NS	3-4	AMR1020SG	3-15
A14H2000GN	11-5	A1SF1G	3-2	AMR1024DG	3-15
A14H2000PG	11-5	A1SF1GS	3-2	AMR1224RO	3-15
A1B1624	3-10	A1SF1GSP250	3-2	AMR1224SG	3-15
A1B1624SP250	3-10	A1SF2G	3-2	AMR1224TG	3-15

# Index

<b>Part No.</b>	<b>Page</b>	<b>Part No.</b>	<b>Page</b>	<b>Part No.</b>	<b>Page</b>
AO	2-46	BC24MSM	1-10	CAT12AF14	5-40
AOL12P	1-22	BC260025EG	2-3	CAT12AFAB3	5-43
AOL16P	1-22	BC32M	1-9	CAT12BC	5-37
AOL812M	1-22	BC32MSM	1-10	CAT12BC200	5-38
AOL8P	1-22	BC400	2-5	CAT12BC200B	5-38
AR812	4-30	BC812M	1-9	CAT12BCB	5-38
ATA4I	8-6	BC812MSM	1-10	CAT12CD1B	5-40
ATS4I	8-7	BC8P	1-5	CAT12SF	5-42
B18SBT18	1-47	BC8PSM	1-5	CAT12VF14	5-40
B18SBT184Z	1-51	BG16	4-14	CAT16HP	5-2
B18SBT18CPNAM	1-54	BG24	4-14	CAT16HP123	5-13
B18SBT18TDH	1-55	BGC	4-14	CAT16HP24	5-10
B18SBT18TI	1-48	BHC	8-19	CAT16HP24SM	5-9
BC	2-5	BX435	4-9	CAT16HP4Z34	5-14
BC090900EG	2-10	BX435RD	4-9	CAT16HP58	5-10
BC091200EG	2-10	C4	4-11	CAT16HP58SM	5-9
BC091500EG	2-10	C6	4-11	CAT16HP6Z34	5-14
BC100000EG	2-6	C121000PG	11-7	CAT16HP8Z34	5-14
BC101500EG	2-6	C12H1000GN	11-6	CAT16HP912	5-10
BC110000EG	2-7	C12H1000PG	11-6	CAT16HP912SM	5-9
BC120000EG	2-7	C12H2000GN	11-6	CAT16HPAB	5-17
BC12P	1-5	C12H2000PG	11-6	CAT16HPAF14	5-12
BC12PSM	1-5	C141000PG	11-7	CAT16HPAFAB3	5-18
BC130025EG	2-7	C14H1000GN	11-6	CAT16HPBA	5-2
BC130037EG	2-7	C14H1000PG	11-6	CAT16HPBC	5-7
BC130050EG	2-7	C14H1000S4	11-6	CAT16HPBC200	5-4
BC140037EG	2-8	C14H2000GN	11-6	CAT16HPBC200B	5-5
BC140050EG	2-8	C14H2000PG	11-6	CAT16HPBCB	5-8
BC140062EG	2-8	C23	4-11	CAT16HPBU	5-2
BC16A000EG	11-23	C2416SM	1-9	CAT16HPCD1B	5-19
BC16M	1-9	C24812SM	1-9	CAT16HPESC	5-20
BC16MSM	1-10	C5816SM	1-9	CAT16HPGBSF	5-16
BC16P	1-5	C58812SM	1-9	CAT16HPGR	5-2
BC16PSM	1-5	C91216SM	1-9	CAT16HPOR	5-3
BC17A000EG	11-22	C912812SM	1-9	CAT16HPRD	5-3
BC17D000EG	11-22	CA0025EG	2-58	CAT16HPSF	5-15
BC180037EG	11-24	CA0037EG	2-58	CAT16HPTS	5-21
BC200	2-5	CA0050EG	2-58	CAT16HPVF14	5-11
BC200000EG	11-23	CAT100CM	5-46	CAT16HPWH	5-3
BC200CD0B	1-2	CAT12	5-37	CAT16HPYL	5-3
BC200CD1B	1-2	CAT1224	5-39	CAT200CM	5-44
BC200CD2.5B	1-2	CAT1224SM	5-39	CAT200CMLN	5-43
BC200CD2B	1-2	CAT124Z34	5-41	CAT21HP	5-2
BC200CD3B	1-2	CAT1258	5-39	CAT21HP123	5-13
BC200CD4B	1-2	CAT1258SM	5-39	CAT21HP24	5-10
BC200CD5B	1-2	CAT126Z34	5-41	CAT21HP24SM	5-9
BC20M	1-9	CAT128Z34	5-41	CAT21HP4Z34	5-14
BC20MSM	1-10	CAT12912	5-39	CAT21HP58	5-10
BC23A000EG	11-25	CAT12912SM	5-39	CAT21HP58SM	5-9
BC24M	1-9	CAT12AB	5-42	CAT21HP6Z34	5-14



# Index

<b>Part No.</b>	<b>Page</b>	<b>Part No.</b>	<b>Page</b>	<b>Part No.</b>	<b>Page</b>
CAT21HP8Z34 . . . . .	5-14	CAT32HPD1BC2 . . . . .	5-6	CAT48HPCD1B . . . . .	5-19
CAT21HP912 . . . . .	5-10	CAT32HPDCM2 . . . . .	5-22	CAT48HPD1BC2 . . . . .	5-6
CAT21HP912SM . . . . .	5-9	CAT32HPDCM3 . . . . .	5-22	CAT48HPGR . . . . .	5-2
CAT21HPAB . . . . .	5-17	CAT32HPDCM4 . . . . .	5-22	CAT48HPOR . . . . .	5-3
CAT21HPAF14 . . . . .	5-12	CAT32HPDFM2 . . . . .	5-24	CAT48HPRD . . . . .	5-3
CAT21HPAFAB3 . . . . .	5-18	CAT32HPDFM3 . . . . .	5-24	CAT48HPSF . . . . .	5-15
CAT21HPAFAB4 . . . . .	5-18	CAT32HPDFM4 . . . . .	5-24	CAT48HPVF14 . . . . .	5-11
CAT21HPAFAB6 . . . . .	5-18	CAT32HPESC . . . . .	5-20	CAT48HPWH . . . . .	5-3
CAT21HPBA . . . . .	5-2	CAT32HPGBSF . . . . .	5-16	CAT48HPYL . . . . .	5-3
CAT21HPBC . . . . .	5-7	CAT32HPGR . . . . .	5-2	CAT600R . . . . .	5-58
CAT21HPBC200 . . . . .	5-4	CAT32HPOR . . . . .	5-3	CAT600RKIT . . . . .	5-58
CAT21HPBC200B . . . . .	5-5	CAT32HPRD . . . . .	5-3	CAT600WM . . . . .	5-59
CAT21HPBCB . . . . .	5-8	CAT32HPSCM2 . . . . .	5-22	CAT64HP . . . . .	5-2
CAT21HPBU . . . . .	5-2	CAT32HPSCM3 . . . . .	5-22	CAT64HP123 . . . . .	5-13
CAT21HPCD1B . . . . .	5-19	CAT32HPSCM4 . . . . .	5-22	CAT64HP24 . . . . .	5-10
CAT21HPD1BC2 . . . . .	5-6	CAT32HPSF . . . . .	5-15	CAT64HP24SM . . . . .	5-9
CAT21HPESC . . . . .	5-20	CAT32HPSFM2 . . . . .	5-24	CAT64HP4Z34 . . . . .	5-14
CAT21HPGR . . . . .	5-2	CAT32HPSFM3 . . . . .	5-24	CAT64HP58 . . . . .	5-10
CAT21HPOR . . . . .	5-3	CAT32HPSFM4 . . . . .	5-24	CAT64HP58SM . . . . .	5-9
CAT21HPRD . . . . .	5-3	CAT32HPVF14 . . . . .	5-11	CAT64HP6Z34 . . . . .	5-14
CAT21HPSF . . . . .	5-15	CAT32HPWH . . . . .	5-3	CAT64HP8Z34 . . . . .	5-14
CAT21HPVF14 . . . . .	5-11	CAT32HPWH4Z34 . . . . .	5-14	CAT64HP912 . . . . .	5-10
CAT21HPWH . . . . .	5-3	CAT32HPYL . . . . .	5-3	CAT64HP912SM . . . . .	5-9
CAT21HPYL . . . . .	5-3	CAT425 . . . . .	5-48	CAT64HPAB . . . . .	5-17
CAT300CM . . . . .	5-44	CAT425A6 . . . . .	5-48	CAT64HPAFAB3 . . . . .	5-18
CAT300CMLN . . . . .	5-43	CAT425BC . . . . .	5-49	CAT64HPAFAB4 . . . . .	5-18
CAT32HP . . . . .	5-2	CAT425BC200 . . . . .	5-49	CAT64HPAFAB6 . . . . .	5-18
CAT32HP123 . . . . .	5-13	CAT425WM . . . . .	5-48	CAT64HPBA . . . . .	5-2
CAT32HP24 . . . . .	5-10	CAT425WMCD1B . . . . .	5-50	CAT64HPBC . . . . .	5-7
CAT32HP24SM . . . . .	5-9	CAT48HP . . . . .	5-2	CAT64HPBC200 . . . . .	5-4
CAT32HP4Z34 . . . . .	5-14	CAT48HP123 . . . . .	5-13	CAT64HPBC200B . . . . .	5-5
CAT32HP58 . . . . .	5-10	CAT48HP24 . . . . .	5-10	CAT64HPBCB . . . . .	5-8
CAT32HP58SM . . . . .	5-9	CAT48HP24SM . . . . .	5-9	CAT64HPBU . . . . .	5-2
CAT32HP6Z34 . . . . .	5-14	CAT48HP4Z34 . . . . .	5-14	CAT64HPCD1B . . . . .	5-19
CAT32HP8Z34 . . . . .	5-14	CAT48HP58 . . . . .	5-10	CAT64HPD1BC2 . . . . .	5-6
CAT32HP912 . . . . .	5-10	CAT48HP58SM . . . . .	5-9	CAT64HPDCM2 . . . . .	5-22
CAT32HP912SM . . . . .	5-9	CAT48HP6Z34 . . . . .	5-14	CAT64HPDCM3 . . . . .	5-22
CAT32HPAB . . . . .	5-17	CAT48HP8Z34 . . . . .	5-14	CAT64HPDCM4 . . . . .	5-22
CAT32HPAF14 . . . . .	5-12	CAT48HP912 . . . . .	5-10	CAT64HPDFM2 . . . . .	5-24
CAT32HPAFAB3 . . . . .	5-18	CAT48HP912SM . . . . .	5-9	CAT64HPDFM3 . . . . .	5-24
CAT32HPAFAB4 . . . . .	5-18	CAT48HPAB . . . . .	5-17	CAT64HPDFM4 . . . . .	5-24
CAT32HPAFAB6 . . . . .	5-18	CAT48HPAFAB3 . . . . .	5-18	CAT64HPGR . . . . .	5-2
CAT32HPBA . . . . .	5-2	CAT48HPAFAB4 . . . . .	5-18	CAT64HPOR . . . . .	5-3
CAT32HPBA4Z34 . . . . .	5-14	CAT48HPAFAB6 . . . . .	5-18	CAT64HPRD . . . . .	5-3
CAT32HPBC . . . . .	5-7	CAT48HPBA . . . . .	5-2	CAT64HPSCM2 . . . . .	5-22
CAT32HPBC200 . . . . .	5-4	CAT48HPBA . . . . .	5-2	CAT64HPSCM3 . . . . .	5-22
CAT32HPBC200B . . . . .	5-5	CAT48HPBC . . . . .	5-7	CAT64HPSCM4 . . . . .	5-22
CAT32HPBCB . . . . .	5-8	CAT48HPBC200 . . . . .	5-4	CAT64HPSF . . . . .	5-15
CAT32HPBU . . . . .	5-2	CAT48HPBC200B . . . . .	5-5	CAT64HPSFM2 . . . . .	5-24
CAT32HPCD1B . . . . .	5-19	CAT48HPBCB . . . . .	5-8	CAT64HPSFM3 . . . . .	5-24
		CAT48HPBU . . . . .	5-2		

# Index

Part No.	Page	Part No.	Page	Part No.	Page
CAT64HPSFM4	5-24	CD0BSF	1-19	CM91216M	1-7
CAT64HPVF14	5-11	CD0BSS	1-41	CM912812M	1-7
CAT64HPWH	5-3	CD0BZSF	1-19	CM912S	2-17
CAT64HPYL	5-3	CD1B	1-41	CNB12P	1-23
CATCR50	5-54	CD1B37	1-41	CNB812M	1-23
CATHBA	5-35	CD1BCPNAM	1-21	CNB8P	1-23
CATHBA3	5-35	CD1BSF	1-19	CONB122000PG	11-8
CATHBA6	5-35	CD1BSS	1-41	CPNAM	2-28
CATHBA8	5-35	CD2.5B	1-41	CRA36SS38L2	10-21
CATHP123	5-30	CD2.5B37	1-41	CRA36SS38L3	10-21
CATHP24	5-28	CD2.5BSS	1-41	CRA36SS38L4	10-21
CATHP24SM	5-27	CD2B	1-41	CRAU24EB1C	10-20
CATHP4Z34	5-30	CD2B37	1-41	CRAU24EB1CR2	10-20
CATHP58	5-28	CD2BSF	1-19	CRAU24PW3J	10-20
CATHP58SM	5-27	CD2BSS	1-41	CRAU24PW3JR2	10-20
CATHP6Z34	5-30	CD2BZSF	1-19	CRAU24PW8S	10-20
CATHP8Z34	5-30	CD3B	1-41	CRAU24PW8SR2	10-20
CATHP912	5-28	CD3B37	1-41	CRAU24TW1C	10-20
CATHP912SM	5-27	CD3BSS	1-41	CRAU24TW1CR2	10-20
CATHPA4	5-34	CD4B	1-41	CRAU24TW2F	10-20
CATHPA6	5-34	CD4B37	1-41	CRAU24TW2FR2	10-20
CATHPABSF	5-33	CD4BSS	1-41	CRAU24TW3J	10-20
CATHPAF14	5-29	CD5B	1-41	CRAU24TW3JR2	10-20
CATHPAN	5-34	CD5B37	1-41	CRAU24TW4G	10-20
CATHPBC	5-26	CD5BSS	1-41	CRAU24TW4GR2	10-20
CATHPBC200	5-25	CD6B	1-41	CRAU26ST2F	10-20
CATHPBC200B	5-25	CD6BSS	1-41	CRAU26ST2FR2	10-20
CATHPBCB	5-26	CD7B	1-41	CRAU26STCR2F	10-20
CATHPCD0B	5-32	CD7BSS	1-41	CRAU26STCR2FR2	10-20
CATHPCD1B	5-32	CD8B	1-41	CRAU26SW12C	10-20
CATHPCD2.5B	5-32	CD8BSS	1-41	CRAU26SW12CR2	10-20
CATHPCD2B	5-32	CD9B	1-41	CRLA37EG	6-4
CATHPCD3B	5-32	CD9BSS	1-41	CRLAKITA	6-4
CATHPESC	5-31	CER4	4-15	CRLB37EG	6-2
CATHPLR	5-35	CFEB05	7-24	CRLB50EG	6-2
CATHPS4	5-34	CG4	4-23	CRLC37EG	6-7
CATHPTM	5-34	CHB	8-20	CRLC37L1	6-7
CATHPVF14	5-29	CHBTC	8-20	CRLJ37EG	6-3
CATMTH	5-55	CJ6	4-17	CRLM37EG	6-6
CATMTLS	5-55	CJ6IN	4-17	CRLM37EG	6-5
CATMTP	5-55	CJ6S	4-17	CRLM50EG	6-5
CATRT200CM	5-47	CJ6STS	4-16	CRLMIP	6-5
CATRT300CM	5-47	CL100000EG	11-10	CRLN37EG	6-11
CATTBCM	5-47	CL100000PS	11-10	CRLP137L14	6-8
CATTS	5-41	CM2416M	1-7	CRLP137L18	6-8
CATWMCM	5-47	CM24812M	1-7	CRLP137L22	6-8
CCS812	4-29	CM24S	2-17	CRLP137L26	6-8
CD0B	1-41	CM5816M	1-7	CRLP137L38	6-8
CD0B37	1-41	CM58812M	1-7	CRLP237L14	6-8
CD0BCPNAM	1-21	CM58S	2-17	CRLP237L18	6-8

# Index

Part No.	Page	Part No.	Page	Part No.	Page
CRLP237L22	6-8	CSBCAB055050EG	2-57	CTH050BC	2-11
CRLP237L26	6-8	CSBCAB055075EG	2-57	CTH050TC	2-12
CRLP237L38	6-8	CSBCAB060062EG	2-57	D121000PG	11-7
CRLP237L50	6-8	CSBCAB062575EG	2-57	D12H1000PG	11-7
CRLP250L18	6-8	CSBCAS025037EG	2-57	D12H2000PG	11-7
CRLP250L22	6-8	CSBCAS030050EG	2-57	DH2	2-27
CRLP250L26	6-8	CSBCAS040050EG	2-57	DH4TI	2-28
CRLP250L38	6-8	CSBCAS040062EG	2-57	DH6TI	2-28
CRLP250L50	6-8	CSBCAS050050EG	2-57	DR4SF12	2-30
CRLS37EG	6-10	CSBCAS050062EG	2-57	DR4SF24	2-30
CRLSL37EG	6-10	CSBCAS050075EG	2-57	DR4SF36	2-30
CRLW37EG	6-6	CSBMA050050EG	12-5	DR4SF48	2-30
CRLW50EG	6-6	CSBMA050075EG	12-5	DR4TSF12	2-31
CS16	4-18	CSBNPC12	12-13	DR4TSF24	2-31
CS812	4-18	CSBNPC38	12-13	DR4TSF36	2-31
CS812D	4-18	CSBNPC58	12-13	DR4TSF48	2-31
CSB12CBL	12-11	CSBR1	12-10	DR4TSF60	2-31
CSB12CBLSS	12-11	CSBR2	12-9	DR4TSF72	2-31
CSB12SBHS	12-15	CSBRS1	12-17	DSI2A	4-26
CSB12SLVB	12-12	CSBRS2	12-17	E121000PG	11-8
CSB12SLVBSS	12-12	CSBRS3	12-17	E12H1000PG	11-8
CSB18CBL	12-11	CSBRS37EG	12-17	E12H2000PG	11-8
CSB18CBLSS	12-11	CSBRS4	12-17	EC311	8-12
CSB18SLVB	12-12	CSBS1	12-2	EC3114Z34	8-13
CSB18SLVBSS	12-12	CSBS1A	12-3	EC3116Z34	8-13
CSB2W12URC12L10	12-14	CSBS2	12-2	EC311P	8-13
CSB2W12URC12L20	12-14	CSBS3	12-4	ENDCA120EG	11-10
CSB2W12URC38L10	12-14	CSBS4	12-4	EPS0050EG	1-43
CSB2W12URC38L20	12-14	CSBS5	12-4	EPS0075EG	1-43
CSB2W18URC12L20	12-14	CSBSH00375EG	12-6	EPS0100EG	1-43
CSB2W18URC38L10	12-14	CSBSH00500EG	12-6	EPS0125EG	1-43
CSB2W18URC38L20	12-14	CSBSH00625EG	12-6	ESC12P	1-36
CSB2W36URC12L10	12-14	CSBSH00750EG	12-6	ESC4	11-28
CSB2W36URC12L20	12-14	CSBU1	12-7	ESC4TI	11-28
CSB2W36URC58L10	12-14	CSBU2	12-7	ESC6M	1-35
CSB2W36URC58L20	12-14	CSBURC12	12-12	ESC6TI	11-28
CSB3346SB	12-15	CSBURC12SS	12-12	ESC812M	1-35
CSB36CBL	12-11	CSBURC38	12-12	ESG1	4-31
CSB36CBLSS	12-11	CSBURC38SS	12-12	ESG1M	4-31
CSB36SLVB	12-12	CSBURC58	12-12	ESGFP	4-32
CSB36SLVBSS	12-12	CSBURC58SS	12-12	ESGP	4-31
CSBBRS1EG	12-16	CSBURCR12	12-13	F090000EG	11-16
CSBBRS2EG	12-16	CSBURCR38	12-13	F130000EG	11-15
CSBBRS3EG	12-16	CSBURCR58	12-13	F140000EG	11-15
CSBBS121836	12-15	CSBUS1	12-8	F150000EG	11-15
CSBC48	12-14	CSBUS1PA	12-6	F160000EG	11-15
CSBCAB030037EG	2-57	CSBUS2	12-8	F170000EG	11-15
CSBCAB037550EG	2-57	CSBUS2PA	12-6	F200000EG	11-16
CSBCAB045050EG	2-57	CTH037BC	2-11	F220000EG	11-16
CSBCAB047562EG	2-57	CTH037TC	2-12	F230000EG	11-17

# Index

Part No.	Page	Part No.	Page	Part No.	Page
F250000EG	11-17	IDS9T	8-14	MAC2123	1-28
F280000EG	11-18	IDS9TWB	8-14	MAC224	1-12
F360000EG	11-16	IDSLN	8-14	MAC224SM	1-13
F370000EG	11-17	IDST	8-14	MAC24Z34	1-33
FB12P	4-33	IDSTWB	8-14	MAC258	1-12
FB16	4-5	IGBSF	5-57	MAC258SM	1-13
FB16FM	4-6	INC8T5	11-25	MAC26Z34	1-33
FB16FS	4-5	ISSP375	11-27	MAC2912	1-12
FB6M	4-33	ISSPK	11-27	MAC2912SM	1-13
FB812M	4-33	J1A35	4-2	MAC2ATA	8-7
FB8P	4-33	K12	1-31	MAC2BC	1-13
FBS12	4-24	K16	1-31	MAC2SF	1-25
FBS16	4-24	K20	1-31	MAC2T	4-19
FBS18	4-24	K8	1-31	MAC2VF14	1-28
FM4	4-9	KA25H0150EG	11-15	MCS100	1-44
FM411	4-9	KA25H0300EG	11-15	MCS10024	1-14
FMBS18	4-25	KA25H0450EG	11-15	MCS1004Z	1-34
FMBS1824	4-24	KA25H0600EG	11-15	MCS10058	1-14
FMSBC1	8-21	KBT	5-60	MCS1006Z	1-34
FXC20	4-18	KX	1-31	MCS1008Z	1-34
HFRMHDW	10-8	L100000EG	11-18	MCS100912	1-14
HMZE215	2-62	L110000EG	11-18	MCS100AF14	1-29
HMZE350	2-62	L120300EG	11-19	MCS100B18	1-53
HMZG160	2-59	L180000EG	11-19	MCS100BC	1-15
HMZG315	2-61	L190000EG	11-20	MCS100BC200	1-14
HMZG365	2-61	L200000EG	11-20	MCS100GBSF	1-24
HMZG470	2-59	L220000EG	11-20	MCS100SF	1-25
HMZG471	2-60	L23U0000EG	11-21	MCS100VF14	1-29
HMZG650	2-61	L441200EG	11-20	MCS101	1-44
HMZG730	2-61	L441600EG	11-20	MCS10124	1-14
HMZH475	2-60	L460450EG	11-19	MCS1014Z	1-34
HMZH476	2-60	L470450EG	11-18	MCS10158	1-14
HMZH665	2-61	LA0025EG	2-58	MCS1016Z	1-34
HSCR3710EG	2-54	LA0037EG	2-58	MCS101912	1-14
HSCR3712EG	2-54	LA0050EG	2-58	MCS101AF14	1-29
HSCR3715EG	2-54	LCSB12	8-17	MCS101BC	1-15
HSCR3720EG	2-54	LFC	8-4	MCS101BC200	1-14
HSCR5010EG	2-54	LFC90	8-4	MCS101SF	1-25
HSCR5012EG	2-54	LTGH	8-16	MCS101VF14	1-29
HSCR5015EG	2-54	LVACBA	5-57	MCS50	1-44
IDS	8-14	LVACRD	5-57	MCS5024	1-14
IDS15	8-14	M1318	2-16	MCS504Z	1-34
IDS2	8-14	M1318S	2-17	MCS5058	1-14
IDS9	8-14	M24	2-16	MCS506Z	1-34
IDS915	8-14	M24S	2-17	MCS50912	1-14
IDS95	8-14	M58	2-16	MCS50AF14	1-29
IDS95LN	8-14	M58S	2-17	MCS50B18	1-53
IDS95T	8-14	M912	2-16	MCS50B18A	1-50
IDS95TWB	8-14	M912S	2-17	MCS50BC	1-15
IDS9LN	8-14	MAC2	4-19	MCS50BC200	1-14

# Index

Part No.	Page	Part No.	Page	Part No.	Page
MCS50VF14.....	1-29	PCL50S2.....	10-14	PRS3.....	10-6
MEB1.....	4-11	PCL50S3.....	10-14	PRS6.....	10-6
MF625.....	4-13	PCL50S4.....	10-14	PSA10CH13.....	10-3
MF750.....	4-13	PCL50S5.....	10-14	PSA16AH18.....	10-3
MFA4I.....	11-14	PCL50S6.....	10-14	PSB24A.....	10-4
MFA625.....	11-14	PCL90S2.....	10-15	PSB30A.....	10-4
MFI.....	4-22	PCL90S3.....	10-15	PSB36A.....	10-4
MFO.....	4-13	PCL90S4.....	10-15	PSB42A.....	10-4
MFS.....	4-12	PCL90S5.....	10-15	PSB48A.....	10-4
MP1.....	5-53	PCL90S6.....	10-15	PSB60A.....	10-4
MP1P.....	5-53	PCP36.....	10-18	PSF10C.....	10-2
MP1S.....	5-52	PCS1.....	1-32	PSF10D.....	10-2
MP1SCB.....	5-51	PCS2.....	1-32	PSF16C.....	10-2
MP2.....	5-53	PCT20.....	10-16	PSF16D.....	10-2
MP2S.....	5-52	PCT30.....	10-16	PSF6C.....	10-2
MP2SCB.....	5-51	PCT40.....	10-16	PT16.....	8-27
MP34P.....	5-53	PCT50.....	10-16	PT16FP.....	8-27
MPAL2.....	5-53	PCT60.....	10-16	PT16LN.....	8-27
MPCB1220.....	5-51	PEB.....	10-13	PT16SPCR.....	8-28
MPLS.....	5-52	PEC.....	10-14	PTF10.....	10-24
MPLS2.....	5-52	PEH31.....	10-13	PTF10P.....	10-25
MPVTI.....	5-54	PEK4B.....	10-9	PTF16.....	10-24
MSF.....	4-12	PEK6B.....	10-10	PTF16P.....	10-25
MSP20.....	4-32	PEKEF.....	10-11	PTF1C.....	10-24
NUT0025EG.....	11-12	PH4.....	2-13	PTF2C.....	10-24
NUT0037EG.....	11-12	PH6.....	2-13	PTF6.....	10-24
NUT0050EG.....	11-12	PH6FP.....	2-13	PTF6P.....	10-25
NUT0050S6.....	11-12	PHB.....	10-7	PTFP.....	10-25
NUT0062EG.....	11-12	PHBR.....	10-7	RA0050HD.....	1-2
P110000EG.....	11-26	PHK.....	10-8	RA0075HD.....	1-2
P11SQ000EG.....	11-25	PHKR.....	10-8	RA0100HD.....	1-2
P130000EG.....	11-26	PHSW4.....	2-13	RA0125HD.....	1-2
PAR0050HD.....	1-3	PHSW6.....	2-13	RA0150HD.....	1-2
PAR0075HD.....	1-3	PHSW6FP.....	2-13	RA0200HD.....	1-2
PAR0100HD.....	1-3	PKM10H3.....	5-56	RAWL3758.....	2-59
PAR0125HD.....	1-3	PKM10H3GBSF.....	5-56	RBS16.....	4-4
PAR0150HD.....	1-3	PKM10H6.....	5-56	RBS16HD.....	4-4
PAR0200HD.....	1-3	PKM16H3.....	5-56	RBS24.....	4-4
PB16.....	4-13	PKM16H3GBSF.....	5-56	RBS24HD.....	4-4
PBU10.....	10-23	PKM16H6.....	5-56	RGC.....	5-55
PBU16.....	10-23	PPRPS25H4.....	10-26	RIGD0050EG.....	9-4
PBU6.....	10-23	PPRPS25H6.....	10-26	RIGD0050S4.....	9-4
PCB36.....	10-17	PRA3H12.....	10-6	RIGD0075EG.....	9-4
PCB36H20.....	10-17	PRA6H16.....	10-6	RIGD0075S4.....	9-4
PCB36H30.....	10-17	PRF2.....	10-5	RIGD0100EG.....	9-4
PCB36H40.....	10-17	PRF3.....	10-5	RIGD0100S4.....	9-4
PCB36H50.....	10-17	PRF6.....	10-5	RIGD0125EG.....	9-4
PCB36H60.....	10-17	PRP1G.....	3-16	RIGD0125S4.....	9-4
PCB36X12.....	10-17	PRPDH.....	3-16	RIGD0150EG.....	9-4
PCGK.....	10-18	PRS2.....	10-6	RIGD0150S4.....	9-4

# Index

<b>Part No.</b>	<b>Page</b>	<b>Part No.</b>	<b>Page</b>	<b>Part No.</b>	<b>Page</b>
RIGD0200EG	9-4	SBT186Z34	1-34	SK12ALA	1-38
RIGD0200S4	9-4	SBT18TDH	1-20	SK165I	1-38
RIGD0250EG	9-4	SBT18TI	1-46	SK16ALA	1-38
RIGD0250S4	9-4	SC2A	1-11	SK205I	1-38
RIGD0300EG	9-4	SC2B	1-11	SK20ALA	1-38
RIGD0300S4	9-4	SC2C	1-11	SK245I	1-38
RIGD0350EG	9-4	SC2D	1-11	SK24ALA	1-38
RIGD0400EG	9-4	SC2E	1-11	SK325I	1-38
RIGD0400S4	9-4	SC2F	1-11	SK32ALA	1-38
RLC	4-23	SC2G	1-11	SK405I	1-38
RMX	1-44	SC4A	1-11	SK485I	1-38
RMX24	1-16	SC4B	1-11	SK565I	1-38
RMX4Z34	1-35	SC4C	1-11	SK645I	1-38
RMX58	1-16	SC4D	1-11	SK85I	1-38
RMX6Z34	1-35	SC4E	1-11	SK8ALA	1-38
RMXAB	1-26	SC4F	1-11	SL1214	7-26
RMXAF14	1-30	SC4G	1-11	SL1518	7-26
RMXAO	1-45	SC8A	1-11	SLADCP	7-24
RMXATS	8-8	SC8B	1-11	SLADS	7-24
RMXBC	1-15	SC8C	1-11	SLAFAB3	7-26
RMXSF	1-26	SC8D	1-11	SLC15L1000SP	7-23
RMXVF14	1-30	SC8E	1-11	SLC15L50MSP	7-23
RPS50AHGP	1-55	SC8F	1-11	SLC2L1000SP	7-23
RPS50H4EG	10-19	SC8G	1-11	SLC3L1000SP	7-23
RPS50H6EG	10-19	SCH12	1-36	SLD15L10S	7-18
RPS50H6HD	10-19	SCH12B	1-37	SLD15L2S	7-18
RPSC24	10-12	SCH16	1-36	SLD15L5S	7-18
RPSC25	10-12	SCH16B	1-37	SLD15QT250	7-19
RPSC28	10-12	SCH20	1-36	SLD15Y200	7-19
RPSC34	10-12	SCH20B	1-37	SLD15Y300	7-19
RPSE1H	10-22	SCH24B	1-37	SLD15Y500	7-19
RPSE1H24	10-22	SCH32B	1-37	SLD2Y300	7-19
RPSE1H57	10-22	SCH40B	1-37	SLD2YH500	7-18
RPSE2H46	10-22	SCH48B	1-37	SLD3YH500	7-18
RPSE4H46	10-22	SCH56B	1-37	SLEB250	7-25
RS06	2-9	SCH64B	1-37	SLEB375	7-25
RS08	2-9	SCH6B	1-37	SLEBWS	7-25
RS10	2-9	SCH72B	1-37	SLICK250	11-11
RS12	2-9	SCH8	1-36	SLICK375	11-11
RS14	2-9	SCH8B	1-37	SLICK500	11-11
RS16	2-9	SCMKC	5-59	SLJR200	7-22
RS18	2-9	SCSOL1A	1-12	SLK15L1	7-6
S102438BP50	8-20	SFCLT	8-4	SLK15L10	7-6
S31199P100	2-53	SFCLTCF	8-4	SLK15L10LP	7-7
S3575BP100	2-53	SFCLTCFS	8-4	SLK15L10T	7-10
S3575BP50	2-53	SFCLTE	8-4	SLK15L1AB	7-2
S3575DP100	2-53	SFCLTS	8-4	SLK15L1LP	7-7
SBC037	2-4	SGB16A	4-27	SLK15L1SF	7-3
SBT18	1-46	SGB24A	4-27	SLK15L1T	7-10
SBT184Z34	1-34	SK125I	1-38	SLK15L1TR2	7-10

# Index

Part No.	Page	Part No.	Page	Part No.	Page
SLK15L2	7-6	SLK2L2SE250	7-8	SLS2L2	7-14
SLK15L2AB	7-2	SLK2L2SF	7-3	SLS2L2SE250	7-15
SLK15L2GBSF	7-4	SLK2L2WA6	7-9	SLS2L3DH	7-13
SLK15L2LP	7-7	SLK2L3	7-6	SLS2L3WA6	7-16
SLK15L2R2	7-6	SLK2L34H24	7-5	SLS2L5SE250	7-15
SLK15L2SE250	7-8	SLK2L34H58	7-5	SLS2L5WA6	7-16
SLK15L2SF	7-3	SLK2L3AB	7-2	SLS2L7DH	7-13
SLK15L2T	7-10	SLK2L3DH	7-5	SLS3C50	7-22
SLK15L2TR2	7-10	SLK2L3GBSF	7-4	SLS3L10	7-14
SLK15L2WA6	7-9	SLK2L3LP	7-7	SLS3L2	7-14
SLK15L3	7-6	SLK2L3R2	7-6	SLS3L5	7-14
SLK15L34H24	7-5	SLK2L3SF	7-3	SLWC	7-23
SLK15L34H58	7-5	SLK2L5	7-6	SMS8	4-30
SLK15L3AB	7-2	SLK2L5AB	7-2	SN25	6-11
SLK15L3DH	7-5	SLK2L5DH	7-5	SN37	6-11
SLK15L3GBSF	7-4	SLK2L5LP	7-7	SN50	6-11
SLK15L3LP	7-7	SLK2L5SE250	7-8	SNSW37	6-12
SLK15L3R2	7-6	SLK2L5WA6	7-9	SNSW50	6-12
SLK15L3SE250	7-8	SLK2L7LP	7-7	SPRA0025EG	11-13
SLK15L3SF	7-3	SLK2Y300L10	7-12	SPRA0037EG	11-13
SLK15L3T	7-10	SLK2Y300L2	7-12	SPRA0050EG	11-13
SLK15L5	7-6	SLK2Y300L3	7-12	SPRA0062EG	11-13
SLK15L500PACK	7-20	SLK2Y300L3R2	7-12	SPRC0025EG	11-13
SLK15L50MPACK	7-20	SLK2Y300L5	7-12	STCB6	11-24
SLK15L5AB	7-2	SLK2Y300L7	7-12	STS	11-9
SLK15L5DH	7-5	SLK2Y500L3	7-12	STS2346	4-10
SLK15L5LP	7-7	SLK2YH500L2	7-11	SWFF0037EG	2-49
SLK15L5R2	7-6	SLK2YH500L2R2	7-11	SWFF0050EG	2-49
SLK15L5SE250	7-8	SLK2YH500L3	7-11	SWMF0037EG	2-50
SLK15L5SF	7-3	SLK2YH500L3R2	7-11	SWMF0050EG	2-50
SLK15L5T	7-10	SLK2YH500L7	7-11	TB1624HD	4-7
SLK15L5WA6	7-9	SLK3C200	7-21	TB435FB	4-9
SLK15L7	7-6	SLK3C50	7-21	TB45P	4-7
SLK15Y300L3	7-12	SLK3L1	7-6	TB45PK	4-8
SLK15Y300L3R2	7-12	SLK3L10	7-6	TB4PU	4-8
SLK15Y300L5	7-12	SLK3L10LP	7-7	TBSBA4	3-14
SLK15Y500L3	7-12	SLK3L10WA6	7-9	TBTG	8-22
SLK15Y500L3R2	7-12	SLK3L2	7-6	TCB	8-12
SLK2C200	7-21	SLK3L2LP	7-7	TDH	2-26
SLK2C50	7-21	SLK3L2WA6	7-9	TDHP2	2-27
SLK2L1	7-6	SLK3L3	7-6	TDHP2PR10	2-27
SLK2L10	7-6	SLK3L3R2	7-6	TDHT4	2-26
SLK2L100PACK	7-20	SLK3L3SE375	7-8	TDHT6	2-26
SLK2L10LP	7-7	SLK3L5	7-6	TEB23	4-10
SLK2L1LP	7-7	SLK3L5LP	7-7	TEB4	4-10
SLK2L2	7-6	SLK3L5R2	7-6	TEB6XT	4-3
SLK2L2AB	7-2	SLK3L5WA6	7-9	TEBS1624	4-29
SLK2L2GBSF	7-4	SLLC250	7-25	TGE	8-22
SLK2L2LP	7-7	SLS2C50	7-22	TPC112	9-7
SLK2L2R2	7-6	SLS2L10	7-14	TPC238	9-7

# Index

Part No.	Page	Part No.	Page	Part No.	Page
TRC062	9-7	USC042EG	9-2	UTS150BA	5-60
TRC075	9-7	USC042HD	9-3	UTS150CATCM	5-45
TRC087	9-7	USC046EG	9-2	UTS200	5-60
TRC100	9-7	USC046HD	9-3	UTS200BA	5-60
TRC112	9-7	USC048EG	9-2	UTS200CATCM	5-45
TRC125	9-7	USC048HD	9-3	UTS300	5-60
TRC137	9-7	USC053EG	9-2	UTS300BA	5-60
TRC150	9-7	USC054EG	9-2	VAFT	2-16
TRC162	9-7	USC054HD	9-3	VAFTR	2-16
TRC200	9-7	USC058EG	9-2	VF14	2-15
TRC212	9-7	USC058HD	9-3	VF144TI	2-25
TSGB16	4-27	USC060EG	9-2	VF146A	2-24
TSGB1624	4-27	USC060HD	9-3	VF146T	2-25
TSGB1624S	4-26	USC063EG	9-2	VF146TI	2-25
TSGB24	4-27	USC068EG	9-2	VF14708	2-24
TSGLDR1	4-28	USC073EG	9-2	W170000EG	11-21
TSGLDR2	4-28	USC073HD	9-3	W190000EG	11-21
TSNT0025EG	11-14	USC076EG	9-2	W200000EG	11-22
TSNT0037EG	11-14	USC080EG	9-2	WBS1	5-62
TSNT0050EG	11-14	USC086EG	9-2	WBS2	5-61
TSR1220	11-2	USC086HD	9-3	WBS37	5-61
TSR122025	11-2	USC093EG	9-2	WBSH25	5-62
TSR122038RL	6-9	USC101EG	9-2	WC812	1-43
TSR1220N	11-3	USC101HD	9-3	WMX3	1-45
TSR1220R	11-4	USC107EG	9-2	WMX6	1-45
TSR1220SLS3	7-17	USC113EG	9-3	WMX6SF	1-24
TSRBS1625	4-6	USC113HD	9-3	ZGA512	11-26
U24A0000EG	11-27	USC121EG	9-3		
USC006EG	9-2	USC129EG	9-3		
USC010EG	9-2	USC135EG	9-3		
USC013EG	9-2	USC143EG	9-3		
USC016EG	9-2	USC143HD	9-3		
USC017EG	9-2	USC152EG	9-3		
USC017HD	9-3	USC159EG	9-3		
USC020EG	9-2	USC168EG	9-3		
USC020HD	9-3	USC168HD	9-3		
USC021EG	9-2	USC178EG	9-3		
USC021HD	9-3	USC191EG	9-3		
USC022EG	9-2	USC200EG	9-3		
USC025EG	9-2	USC208EG	9-3		
USC026EG	9-2	USC218EG	9-3		
USC026HD	9-3	USC218HD	9-3		
USC028EG	9-2	USC228EG	9-3		
USC031EG	9-2	USC254EG	9-3		
USC031HD	9-3	USC277EG	9-3		
USC033EG	9-2	USC277HD	9-3		
USC033HD	9-3	USC324EG	9-3		
USC036EG	9-2	USC324HD	9-3		
USC040EG	9-2	USC400EG	9-3		
USC040HD	9-3	UTS150	5-60		



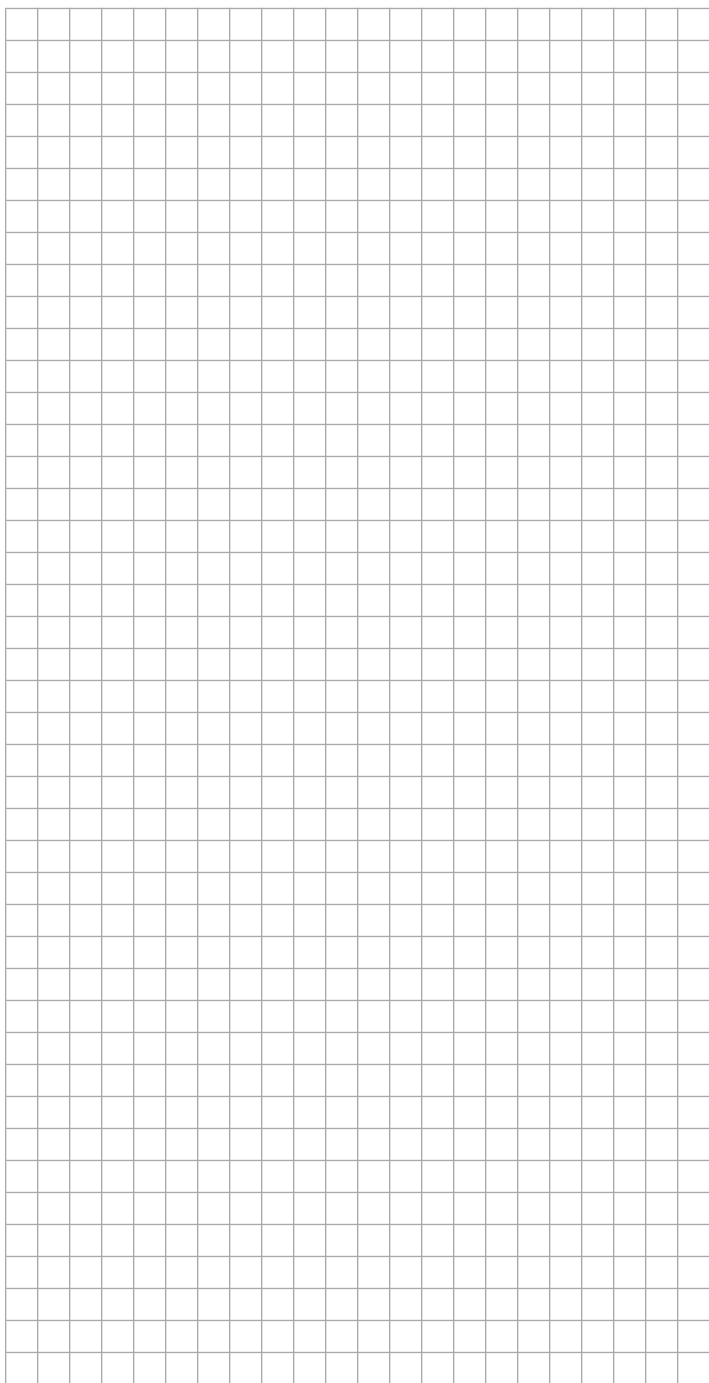

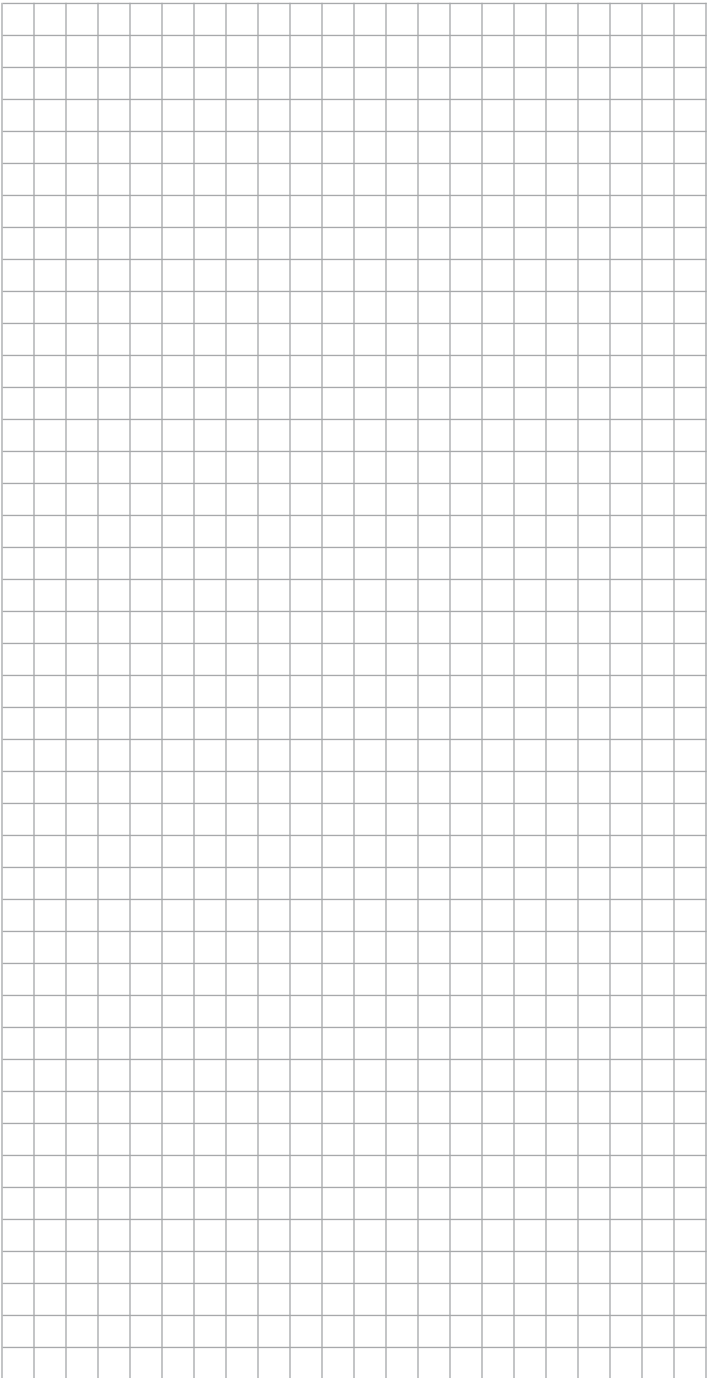

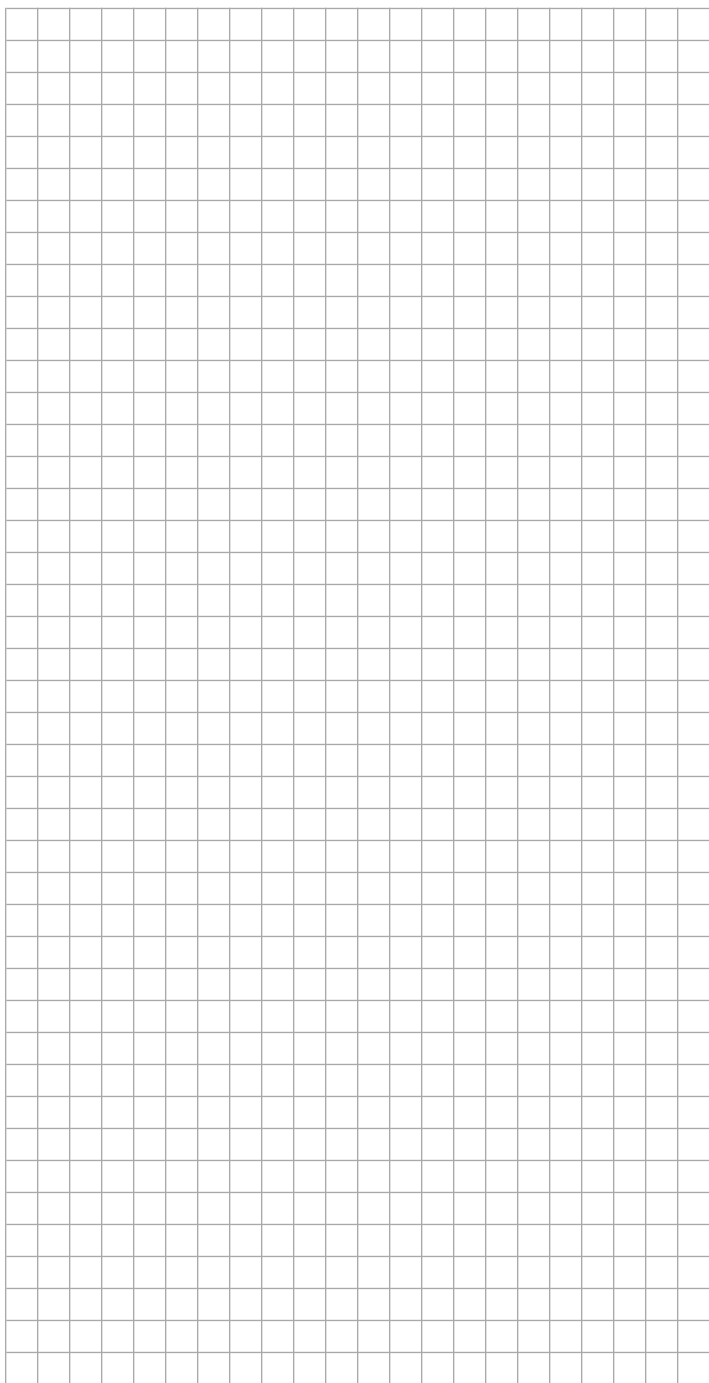

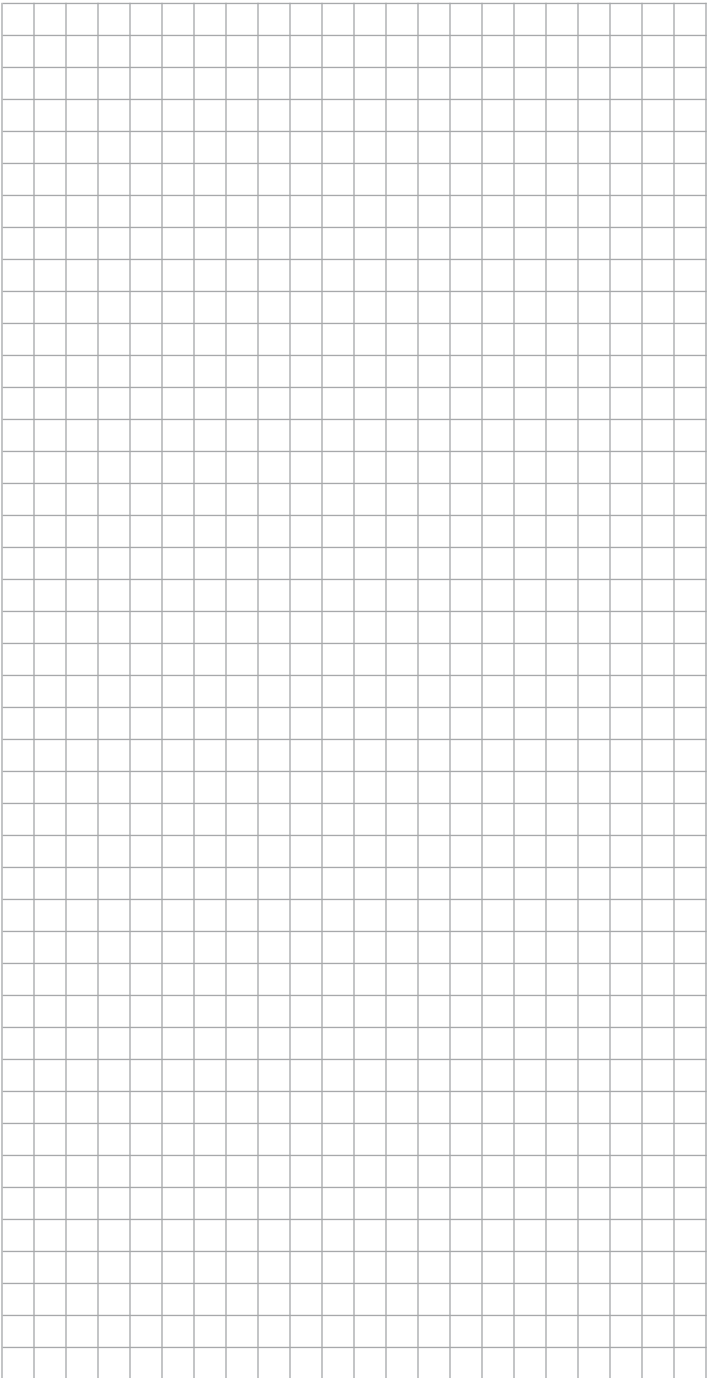



1  
2  
3  
4  
5  
6  
7  
8  
9  
10  
11  
12  
13  
14  
15  
16  
17  
18  
19  
20



Our powerful portfolio of brands:

**CADDY ERICO HOFFMAN RAYCHEM SCHROFF TRACER**



**[nVent.com/CADDY](https://nVent.com/CADDY)**

©2021 nVent. All nVent marks and logos are owned or licensed by nVent Services GmbH or its affiliates. All other trademarks are the property of their respective owners. nVent reserves the right to change specifications without notice. CADDY-CAT-CFC-Electrical-USEN-2101