



**Product Datasheet**

**ANDERSON FARGO**

**WTT2152020 -- Tee, Aluminum Weldment**



Tee, Aluminum Weldment, Angle, Tube to Two Tubes, 2 to 2 IPS/EHIPS tubes

**Product Specifications**

Family Image



Tees

Tees



**WTT2-15 Series**  
Tube to Two Tubes, 15 Degree  
Aluminum Weldment Tees

PDF Catalog Page

[Click HERE to view the web page.](#)

Dimension A

1.50 in (38.1 mm)

Dimension B

7.31 in (185.8 mm)

Dimension C

4.38 in (111.1 mm)

Dimension L

4.00 in (101.6 mm)

Material Type

Non-Standard

UPC Code

09635934338

Standard Package

1

Standard Package Unit

Each

Min Order Qty

1

Weight / Ea.

2.058 lbs

**Compressed Product Number**

WTT2152020

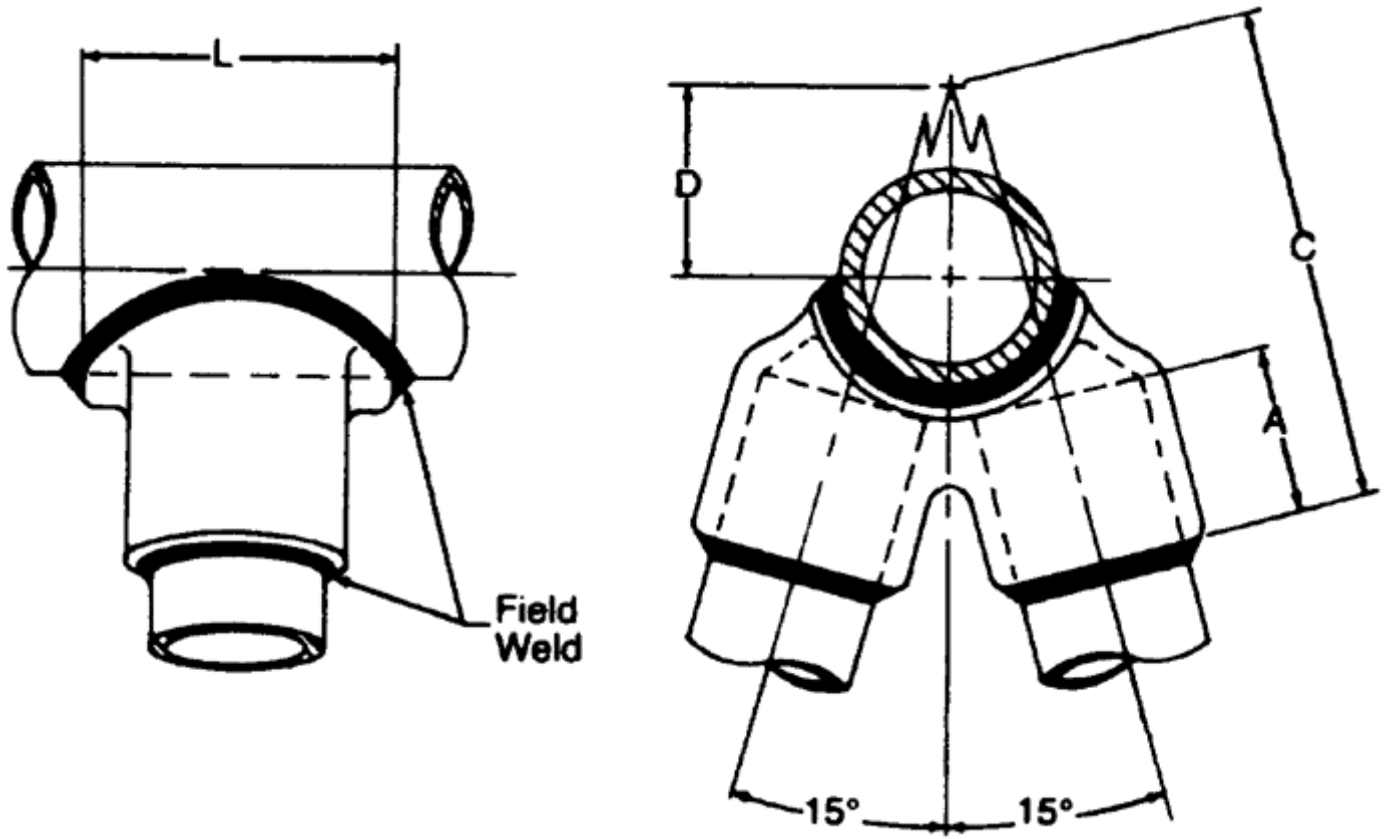

[Catalog Home](#)



[Warranty Info](#) | [Trademarks](#) | [Terms of Use](#)

*All contents Copyright © 2007 Hubbell Power Systems, Inc. All rights reserved.*

NOTE: Because Hubbell has a policy of continuous product improvement, we reserve the right to change design and specifications without notice.