

Zelio[®] Timing relays

Catalog
2010



■ Selection guide.....	page 4
■ Introduction	page 6
■ Definitions	page 6 and 7
■ Selection	page 8 and 9
■ Functions.....	page 10 to 15
■ Catalog numbers.....	page 16 to 25
■ Dimensions and wiring	page 26 to 36

For user guides and instruction sheets, visit www.schneider-electric.us.

Telemecanique® and Zelio® are registered trademarks of Schneider Electric.
Other trademarks used herein are the property of their respective owners.

Applications	Zelio timing relays enable simple automation cycles to be set up using wired logic. They can also be used to complement the functions of PLCs.	
Output	Solid state Timing relays with solid state output reduce the amount of wiring required (wired in series). The durability of these timing relays is independent of the number of operating cycles.	Relay Relay outputs provide isolation between the supply circuit and the output. It is possible to have several output circuits.



Type	Modular	Industrial	Modular	Industrial
Time ranges	□ 7 ranges: 1 s, 10 s, 1 min, 10 min, 1 h, 10 h, 100 h	□ 1 or 2 ranges depending on model: 10 s, 30 s, 300 s, 60 min	Depending on model: □ 6 ranges 1 s, 10 s, 1 min, 10 min, 1 h, 10 h □ 7 ranges: 1 s, 10 s, 1 min, 10 min, 1 h, 10 h	Depending on model: □ 4 ranges: 0.6 s, 2.5 s, 20 s, 160 s □ 7 ranges: 1 s, 10 s, 1 min, 10 min, 1 h, 10 h, 100 h □ 7 ranges: 1 s, 3 s, 10 s, 30 s, 100 s, 300 s, 10 min □ 10 ranges: 1 s, 3 s, 10 s, 30 s, 100 s, 300 s, 30 min, 300 min, 30 h, 300 h
Relay type	RE11L●●●	RE9	RE11R●●●	RE88865●●● RE7
See pages	16, 26	17, 28	16, 26	18, 19, 32, 28

Zelio timing relays enable simple automation cycles to be set up using wired logic. They can also be used to complement the functions of PLCs.

Relay
Relay outputs provide isolation between the supply circuit and the output. It is possible to have several output circuits.



Optimum	Plug-in		Panel mounted
	Universal	Miniature	Analog
<p>□ 1 range depending on model:</p> <p>0.5 s, 3 s, 10 s, 30 s, 300 s, 30 min</p>	<p>□ 7 ranges:</p> <p>1 s, 10 s, 1 min, 10 min, 1 h, 10 h, 100 h</p>	<p>□ 7 ranges:</p> <p>0.1–1 s, 1–10 s, 0.1–1 min, 1–10 min, 0.1–1 h, 1–10 h, 10–100 h</p>	<p>14 ranges:</p> <p>1.2 s, 3 s, 12 s, 30 s, 120 s, 300 s, 12 min, 30 min, 120 min, 300 min, 12 h, 30 h, 120 h, 300 h</p>
RE8	RE88867●●●	REXL●TM●●	RE48A●●●
20, 28	21, 22, 34	23, 33	24, 35

DIN rail mounted relays



RE11

RE7, RE8, RE9

REXL

Panel mounted relays



RE48A

Introduction

A timing relay is a component which is designed to time events in industrial automation systems by closing or opening contacts before, during, or after a set timing period.

There are two main families of timing relays:

- DIN rail mounted relays (**RE7, RE8, RE9, RE11, REXL...**) designed for mounting on DIN rails in an enclosure,

- Panel-mounted relays type **RE48A** designed for mounting on the front of a panel to give users easy access to the settings.

These relays have one, two, or four outputs. Sometimes the second output can be timed or instantaneous.

If the power is switched off during the timing period, the relay reverts to its initial position.

Application examples:

- opening automatic doors,
- alarm,
- lighting in toilets,
- car park barriers

Definitions

■ Relay output:

This is the most common type of output. When the relay is energized, the moving armature is attracted by the coil and so actuates the contacts, which change state. When the relay is de-energized, both the armature and the contacts revert to their initial position.

This type of output allows isolation between the supply and the output.

There are three types of outputs:

- **C/O**: changeover contact. When the relay is de-energized, the circuit between the common point C and N/C is closed. When the relay is operating (coil energized), the circuit between the common point C and N/O is closed.
- **N/C**: a contact that is closed without being actuated is called a **Normally Closed (N/C)** contact.
- **N/O**: a contact that closes when actuated is called a **Normally Open (N/O)** contact.



■ Solid state output:

These outputs are entirely electronic and involve no moving parts; service life is therefore increased.

■ Breaking capacity:

The current value that a contact is capable of breaking in specified conditions.

■ Mechanical durability:

The number of mechanical operating cycles of the contact or contacts.

■ Minimum switching capacity (or minimum breaking capacity):

The minimum required current which can flow through the contacts of a relay.

■ G (Gate) Input:

Gate input allows timing in progress to be interrupted without resetting it.

Definitions (continued)

Functions

Timing functions are identified by letters.

Main timing functions	Complementary functions (1)	Definitions
A (2)		Delay on energization
	Ac	Timing after closing and opening of control contact
	Ad	Timing on closing of control contact
	Ah	Flashing single cycle by operation of control contact
	Ak	Asymmetrical On-delay and Off-delay with external control
	At	Delay on energization with memory
	Aw	Off-delay on energization or on opening of control contact
B (2)		Timing on impulse, one shot
	Bw	Pulse output (width adjustable)
C (2)		Timing after opening of control contact
D (2)		Symmetrical flashing, start with output in rest position
	Di (2)	Symmetrical flashing, start with output in operating position
H (2)		Timing on energization
	He	Pulse-on de-energization
	Ht	Timing on energization with memory
K		Delay on de-energization (without auxiliary supply)
L (2)		Asymmetrical flashing, start with output in rest position
	Li (2)	Asymmetrical flashing, start with output in operating position
	Lt	Asymmetrical flashing with partial stop of timing
N		Safeguard
O		Delayed safeguard
P		Delayed fixed-length pulse
	Pt	Impulse counter (On-delay)
	Qc	Star-delta timing
	Qe	Star-delta timing
	Qg	Star-delta timing
	Qt	Star-delta timing
T		Bistable relay
	Tt	Timed impulse relay
W		On-delay after opening of control contact

(1) Complementary functions enhance the main timing functions.

Example: **Ac**: timing after closing and opening of control contact.

(2) The most commonly used timing functions.

Selection table

Selection criteria

- **Functions** (On-delay or Off-delay, counter, flashing)
 - **Supply voltage** (example: $\sim/\text{---}$ 12–240 V).
 - **Timing range** for a timing relay (example: 0.05 s–100 h)
 - **Type of output** (contact or solid state) and required **Number of contacts**.
 - **Breaking capacity** or **Rated current** of contacts, expressed in amperes.
- This is the maximum current which may flow through the contacts.

Functions	Timing range	Supply voltage	Type of output	Rated current	Relay		
A	0.1 s–100 h	--- 12 V	2 C/O contacts	5 A	REXL2TMJD		
			4 C/O contacts	3 A	REXL4TMJD		
	0.1 s–100 h	--- 24 V	2 C/O contacts	5 A	REXL2TMBD		
			4 C/O contacts	3 A	REXL4TMBD		
	0.1 s–100 h	\sim 24 V	2 C/O contacts	5 A	REXL2TMB7		
			4 C/O contacts	3 A	REXL4TMB7		
	0.1 s–100 h	\sim 120 V	2 C/O contacts	5 A	REXL2TMF7		
			4 C/O contacts	3 A	REXL4TMF7		
	0.1 s–100 h	\sim 230 V	2 C/O contacts	5 A	REXL2TMP7		
			4 C/O contacts	3 A	REXL4TMP7		
	0.1–10 s	$\sim/\text{---}$ 24–240 V	1 solid state output	0.7 A	RE9TA11MW		
				0.7 A	RE9TA31MW		
	3–300 s			0.7 A	RE9TA21MW		
	40 s–60 min			0.7 A	RE9TA51MW		
	1 s–100 h			0.7 A	RE11LAMW		
	0.02 s–300 h			2 timed C/O contacts	5 A	RE48ATM12MW	
	0.05 s–300 h	$\sim/\text{---}$ 24 V, \sim 110–240 V	1 C/O contact	8 A	RE7TL11BU		
				8 A	RE8TA61BUTQ		
				8 A	RE8TA11BUTQ		
				8 A	RE8TA31BUTQ		
8 A				RE8TA21BUTQ			
8 A				RE8TA41BUTQ			
0.05 s–300 h				$\sim/\text{---}$ 24 V, \sim 110–240 V, $\sim/\text{---}$ 42–48 V	2 C/O contacts	8 A	RE7TP13BU
A, Ac, At, B, Bw, C, D, Di, H, Ht	1 s–100 h	\sim 24–240 V	1 solid state output	0.7 A	RE11LMBM		
	1 s–100 h	$\sim/\text{---}$ 12 V	1 C/O contact	8 A	RE11RMJU		
	1 s–100 h	$\sim/\text{---}$ 12–240 V	1 C/O contact	8 A	RE11RMMW		
				8 A	RE11RMMWS		
1 s–100 h	--- 24 V, \sim 24–240 V	1 C/O contact	8 A	RE11RMMU			
A, At	1 s–100 h	--- 24 V, \sim 24–240 V	1 C/O contact	8 A	RE11RAMU		
A, At, Aw	0.05 s–300 h	\sim 110–240 V, $\sim/\text{---}$ 24 V, $\sim/\text{---}$ 42–48 V	1 C/O contact	8 A	RE7TM11BU		
A, At, B, C, D, Di, H, Ht	1 s–10 h	--- 24 V, \sim 24–240 V	1 C/O contact	5 A	RE11RMEMU		
A, B, C, Di	0.02 s–300 h	$\sim/\text{---}$ 24–240 V	2 C/O contacts	5 A	RE48AML12MW		
A, C, D, Di, H, Qg, Qt, W	0.05 s–300 h	\sim 110–240 V, $\sim/\text{---}$ 24 V, $\sim/\text{---}$ 42–48 V	2 C/O contacts	8 A	RE7MY13BU		
			2 C/O contacts	8 A	RE7MY13MW		
A, C, D, Di, H, W	0.05 s–300 h	\sim 110–240 V, $\sim/\text{---}$ 24 V, $\sim/\text{---}$ 42–48 V	1 C/O contact	8 A	RE7ML11BU		
A, D, Di, H	0.1–10 s and 3–300 s	$\sim/\text{---}$ 24–240 V \sim 24–240 V	1 solid state output	0.7 A	RE9MS21MW		
A1, A2, H1, H2	0.02 s–300 h	$\sim/\text{---}$ 24–240 V	2 C/O contacts	5 A	RE48AMH13MW		
Ac	0.05 s–300 h	\sim 110–240 V, $\sim/\text{---}$ 24 V, $\sim/\text{---}$ 42–48 V	1 C/O contact	8 A	RE7MA11BU		
			2 C/O contacts	8 A	RE7MA13BU		
Ad, Ah, N, O, P, Pt, T, Tt, W	1 s–100 h	--- 24 V, \sim 24–240 V	1 C/O contact	8 A	RE11RMXMU		
Ak	0.05 s–300 h	\sim 110–240 V, $\sim/\text{---}$ 24 V, $\sim/\text{---}$ 42–48 V	1 C/O contact	8 A	RE7MV11BU		

Selection table (continued)						
Functions	Timing range	Supply voltage	Type of output	Rated current	Relay	
B	1 s–100 h	⎓ 24 V, ~ 24–240 V	1 C/O contact	8 A	RE11RB MU	
C	0.1–10 s	~/⎓ 24 V	1 C/O contact	8 A	RE8RA11BTQ	
	0.3–30 s			8 A	RE8RA31BTQ	
	3–300 s			8 A	RE8RA21BTQ	
	1 s–100 h	⎓ 24 V, ~ 24–240 V	1 C/O contact	8 A	RE11RCMU	
	0.1–10 s	~ 110–240 V	1 C/O contact	8 A	RE8RA11FUTQ	
	0.3–30 s			8 A	RE8RA31FUTQ	
	3–300 s			8 A	RE8RA21FUTQ	
	20 s–30 min			8 A	RE8RA41FUTQ	
	0.05 s–300 h		~/⎓ 24 V, ~ 110–240 V, ~/⎓ 42–48 V	1 C/O contact	8 A	RE7RA11BU
					8 A	RE7RM11BU
				2 C/O contacts	8 A	RE7RL13BU
	0.1–10 s	~ 24–240 V	1 solid state output	0.7 A	RE9RA11MW7	
	0.3–30 s			0.7 A	RE9RA31MW7	
	3–300 s			0.7 A	RE9RA21MW7	
	40 s–60 min			0.7 A	RE9RA51MW7	
	1 s–100 h			0.7 A	RE11LCBM	
D	0.05 s–300 h	~/⎓ 24 V, ~ 110–240 V	1 C/O contact	8 A	RE7CL11BU	
	0.1–10 s			8 A	RE8CL11BUTQ	
	0.05 s–300 h	~/⎓ 24 V, ~ 110–240 V, ~/⎓ 42–48 V	2 C/O contacts	8 A	RE7CP13BU	
H	0.05 s–300 h	~/⎓ 24 V, ~ 110–240 V	1 C/O contact	8 A	RE7PE11BU	
	0.1–10 s			8 A	RE8PE11BUTQ	
	0.3–30 s			8 A	RE8PE31BUTQ	
	3–300 s			8 A	RE8PE21BUTQ	
	0.05 s–300 h	~/⎓ 24 V, ~ 110–240 V, ~/⎓ 42–48 V	2 C/O contacts	8 A	RE7PP13BU	
1 s–100 h	~ 24–240 V	1 solid state output	0.7 A	RE11LHBM		
H, Ht	1 s–100 h	⎓ 24 V, ~ 24–240 V	1 C/O contact	8 A	RE11RHMU	
He	0.05–0.5 s	~/⎓ 24 V, ~ 110–240 V	1 C/O contact	8 A	RE8PT01BUTQ	
K	0.05 s–10 min	~/⎓ 24–240 V	1 C/O contact	5 A	RE7RB11MW	
	0.05–0.5 s	~/⎓ 24 V, ~ 110–240 V	1 C/O contact	8 A	RE8RB51BUTQ	
	0.1–10 s			8 A	RE8RB11BUTQ	
	0.3–30 s			8 A	RE8RB31BUTQ	
	0.05 s–10 min	~/⎓ 24–240 V	2 C/O contacts	5 A	RE7RB13MW	
L, Li	1 s–100 h	⎓ 24 V, ~ 24–240 V	1 C/O contact	8 A	RE11RLMU	
	1 s–100 h	~ 24–240 V	1 solid state output	0.7 A	RE11LLBM	
	1 s–100 h	~/⎓ 12 V	1 C/O contact	8 A	RE11RLJU	
	0.02 s–300 h	~/⎓ 24–240 V	2 timed C/O contacts	5 A	RE48ACV12MW	
L, Li, Lt	0.05 s–300 h	~ 110–240 V, ~/⎓ 24 V, ~/⎓ 42–48 V	1 C/O contact	8 A	RE7CV11BU	
Qc	0.1–10 s	~/⎓ 24 V, ~ 110–240 V	1 C/O contact	8 A	RE8YG11BUTQ	
	0.3–30 s			8 A	RE8YG31BUTQ	
	3–300 s			8 A	RE8YG21BUTQ	
Qe	0.3–30 s	~/⎓ 24 V	1 N/O + 1 N/C	8 A	RE8YA32BTQ	
	0.3–30 s	~ 110–240 V	1 N/O + 1 N/C	8 A	RE8YA32FUTQ	
	0.3–30 s	~ 380–415 V	1 N/O + 1 N/C	8 A	RE8YA32QTQ	
Qg	0.05 s–300 h	~/⎓ 24 V, ~ 110–240 V, ~/⎓ 42–48 V	1 N/O + 1 N/C	8 A	RE7YR12BU	
Qt	0.05 s–300 h	~/⎓ 24 V, ~ 110–240 V, ~/⎓ 42–48 V	2 C/O contacts	8 A	RE7YA12BU	
W	0.1–10 s	~/⎓ 24 V	1 C/O contact	8 A	RE8PD11BTQ	
	0.3–30 s			8 A	RE8PD31BTQ	
	3–300 s			8 A	RE8PD21BTQ	
	0.1–10 s	~ 110–240 V	1 C/O contact	8 A	RE8PD11FUTQ	
	0.3–30 s			8 A	RE8PD31FUTQ	
	3–300 s			8 A	RE8PD21FUTQ	
	0.05 s–300 h	~/⎓ 24 V, ~ 110–240 V, ~/⎓ 42–48 V	2 C/O contacts	8 A	RE7PD13BU	
W, Ht	0.05 s–300 h	~/⎓ 24 V, ~ 110–240 V, ~/⎓ 42–48 V	1 C/O contact	8 A	RE7PM11BU	

Functions

- U:** Supply
- R:** Relay or solid state output
- R1/R2:** 2 timed outputs
- R2 inst.:** The second output can be configured to be instantaneous.
- T:** Timing period
- C:** Control contact
- G:** Gate
- Ta:** Adjustable On-delay
- Tr:** Adjustable Off-delay

- Function diagram :**
- Relay de-energized
 - Relay energized
 - Output open
 - Output closed

Function A: Delay on energization

1 output



2 outputs

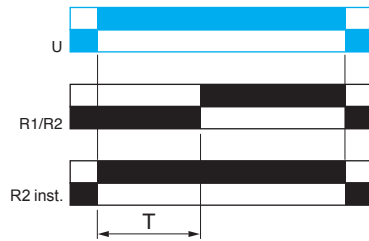

The timing period T begins on energization. After timing, the outputs R close. The second output can be either timed or instantaneous.

2 timed outputs (R1/R2) or 1 timed output (R1) and 1 instantaneous output (R2 inst.).

Function Ac: Timing after closing and opening of control contact

1 output

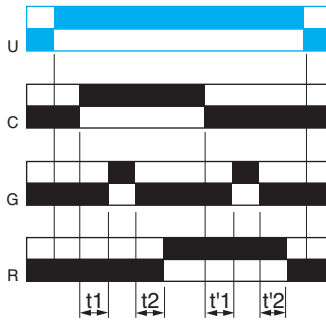

$$T = t_1 + t_2 + \dots$$

$$T = t'_1 + t'_2 + \dots$$

2 outputs

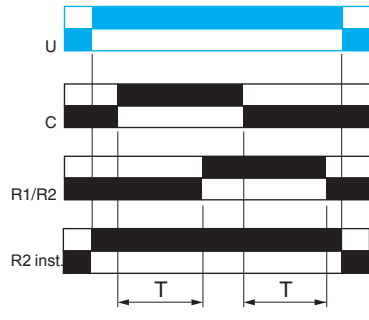

After power-up, closing of the control contact C causes the timing period T to start (timing can be interrupted by operating the Gate control contact G). At the end of this timing period, the relay closes. When control contact C re-opens, the timing period T starts. At the end of this timing period T, the outputs R revert to their initial position (timing can be interrupted by operating the Gate control contact G). The second output can be either timed or instantaneous.

2 timed outputs (R1/R2) or 1 timed output (R1) and 1 instantaneous output (R2 inst.).

Function Ad: Timing on closing of control contact

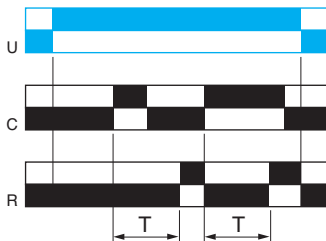

After power-up, pulsing or maintaining control contact C starts the timing period T. At the end of this timing period T, the output R closes. The output R will be reset the next time control contact C is pulsed or maintained.

Function Ah: Flashing single cycle by operation of control contact

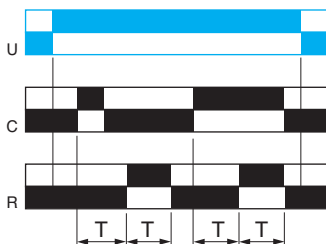

After power-up, pulsing or maintaining control contact C starts the timing period T. A single cycle then starts with 2 timing periods T of equal duration (start with output in rest position). Output R changes state at the end of the first timing period T and reverts to its initial position at the end of the second timing period T. Control contact C must be reset in order to re-start the single flashing cycle.

Functions (continued)

Function Ak: Asymmetrical On-delay and Off-delay with external control

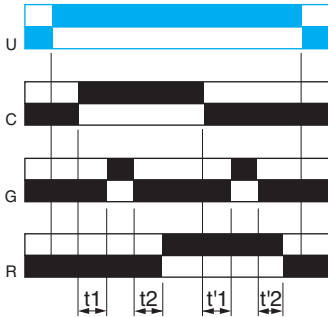

After power-up and closing of the control contact C, timing starts for a period T_a (timing can be interrupted by operating the Gate control contact G).
 At the end of this timing period T_a , the output R closes.
 Opening of control contact C causes a second timing period T_r to start (timing can be interrupted by operating the Gate control contact G).
 At the end of this timing period T_r , the output R reverts to its initial state.

$$T_a = t_1 + t_2 + \dots$$

$$T_r = t'_1 + t'_2 + \dots$$

Function At: Delay on energization with memory

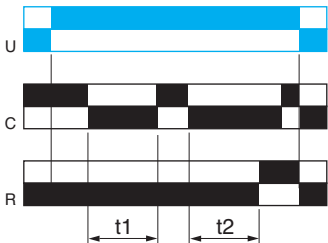

After power-up, the first opening of control contact C starts the timing. Timing can be interrupted each time control contact C closes. When the cumulative total of time periods elapsed reaches the pre-set value T, the output relay closes.

$$T = t_1 + t_2 + \dots$$

Function Aw: Off-delay on energization or on opening of control contact

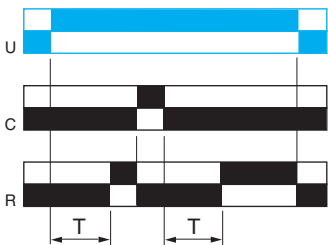

The timing period T starts on energization.
 At the end of the timing period T, the output R closes.
 Closing control contact C opens output R.
 Opening control contact C restarts the timing period T.
 At the end of the timing period T, the output R closes.

Function B: Timing on impulse, one shot

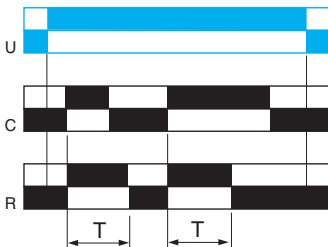

After power-up, pulsing or maintaining control contact C starts the timing period T.
 The output R closes for the duration of the timing period T, then reverts to its initial state.

Function Bw: Pulse output (width adjustable)

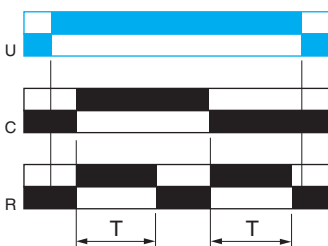

On closing and opening of control contact C, the output R closes for the duration of the timing period T.

Function C: Timing after opening of control contact

1 output

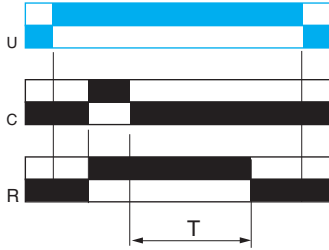

2 outputs

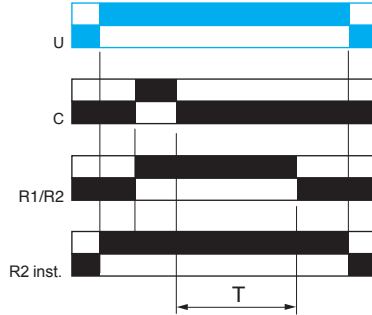

After power-up and closing of the control contact C, the outputs R close. When control contact C re-opens, timing period T starts. At the end of the timing period, the outputs R revert to their initial state. The second output can be either timed or instantaneous.

2 timed outputs (R1/R2) or 1 timed output (R1) and 1 instantaneous output (R2 inst.).

Function D: Symmetrical flashing, start with output in rest position

1 output

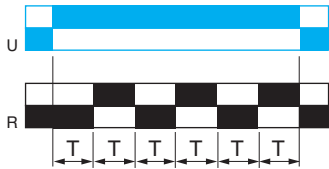

2 outputs

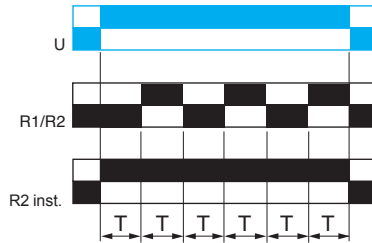

Repetitive cycle with two timing periods T of equal duration, with the outputs R changing their state at the end of each timing period T. The second output can be either timed or instantaneous.

2 timed outputs (R1/R2) or 1 timed output (R1) and 1 instantaneous output (R2 inst.).

Function Di: Symmetrical flashing, start with output in operating position

1 output



2 outputs

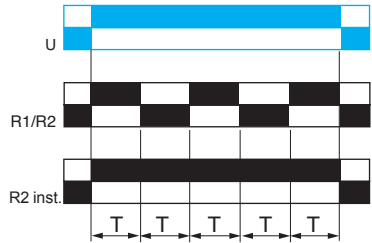

Repetitive cycle with two timing periods T of equal duration, with the outputs R changing their state at the end of each timing period T. The second output can be either timed or instantaneous.

2 timed outputs (R1/R2) or 1 timed output (R1) and 1 instantaneous output (R2 inst.).

Function H: Timing on energization

1 output

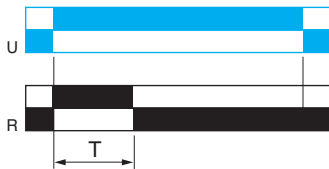

2 outputs

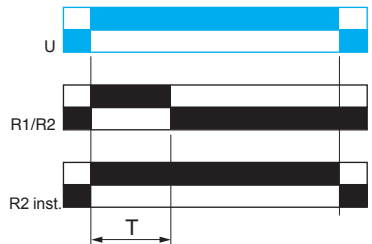

On energization of the relay, timing period T starts and the outputs R close. At the end of the timing period T, outputs R revert to their initial state. The second output can be either timed or instantaneous.

2 timed outputs (R1/R2) or 1 timed output (R1) and 1 instantaneous output (R2 inst.).

Function He: Pulse on de-energization

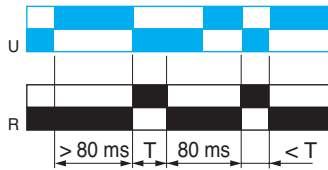

On de-energization, the output R closes for the duration of a timing period T.

Function Ht: Timing on energization with memory

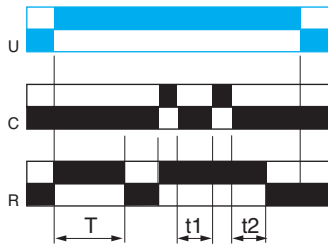

On energization, the output R closes for the duration of a timing period T, then reverts to its initial state.
Pulsing or maintaining control contact C will again close the output R.
Timing T is only active when control contact C is released and so the output R will not revert to its initial state until after a time $t_1 + t_2 + \dots$.
The relay memorizes the total, cumulative opening time of control contact C and, when the set time T is reached, output R reverts to its initial state.

$T = t_1 + t_2 + \dots$

Function K: Delay on de-energization (without auxiliary supply)

1 output



2 outputs

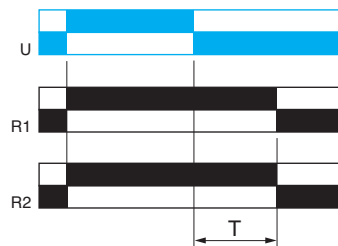

On energization, the outputs R close.
On de-energization, timing period T starts and, at the end of this period, the outputs R revert to their initial state.

Function L: Asymmetrical flashing, start with output in rest position

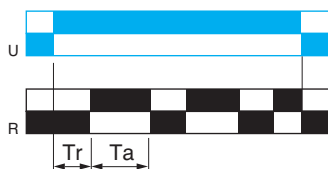

Repetitive cycle with two, independently adjustable timing periods T_a and T_r .
Each timing period corresponds to a different state of the output R.

Function Li: Asymmetrical flashing, start with output in operating position

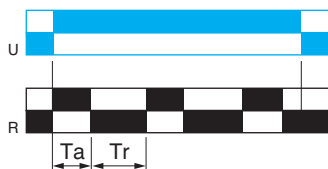

Repetitive cycle with two, independently adjustable timing periods T_a and T_r .
Each timing period corresponds to a different state of the output R.

Function Lt: Asymmetrical flashing with partial stop of timing

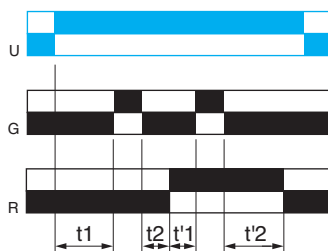

Repetitive cycle with two, independently adjustable timing periods T_a and T_r .
Each timing period corresponds to a different state of the output R.
Gate control contact G can be operated to partially stop timing periods T_a and T_r .

$T_r = t_1 + t_2 + \dots$
 $T_a = t'_1 + t'_2 + \dots$

Function N: Safeguard

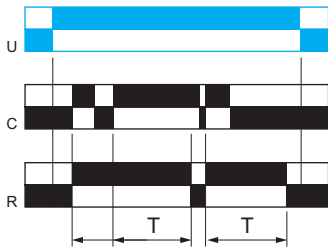

After power-up and an initial control pulse C, the output R closes. If the interval between two control pulses C is greater than the set timing period T, timing elapses normally and the output R opens at the end of the timing period. If the interval is not greater than the set timing period, the output R remains closed until this condition is met.

Function O: Delayed safeguard

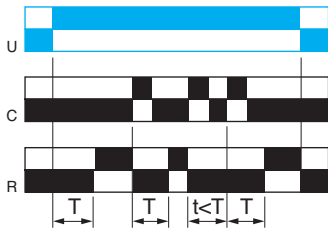

An initial timing period T begins on energization. At the end of this timing period, the output R closes. As soon as there is a control pulse C, the output R reverts to its initial state and remains in that state until the interval between two control pulses is less than the value of the set timing period T. Otherwise, the output R closes at the end of the timing period T.

Function P: Delayed fixed-length pulse

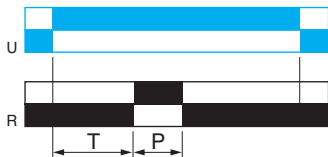

The timing period T starts on energization. At the end of this period, the output R closes for a fixed time P.

P = 500 ms

Function Pt: Impulse counter (On-delay)

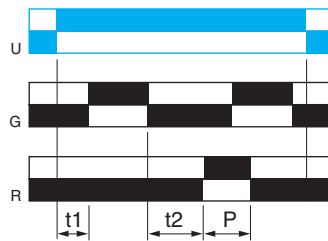

On energization, timing period T starts (it can be interrupted by operating the Gate control contact G). At the end of this period, the output R closes for a fixed time P.

T = t1 + t2 + ...
P = 500 ms

Function Qc: Star-delta timing

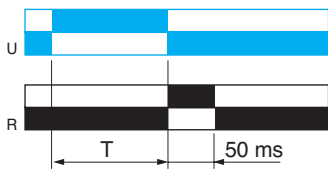

Timing for star delta starter with contact for switching to star connection.

Function Qe: Star-delta timing

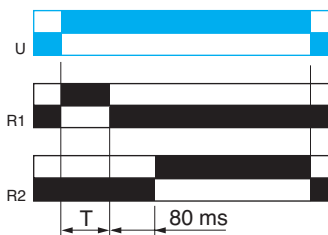

On energization, the star contact closes instantly and timing starts. At the end of the timing period, the star contact opens. After an 80 ms pause, the delta contact closes and remains in this position.

Function Qg: Star-delta timing

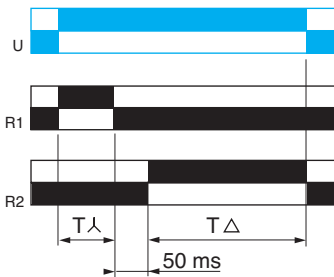

Timing for star delta starter with contact for switching to star connection.

Function Qt: Star-delta timing

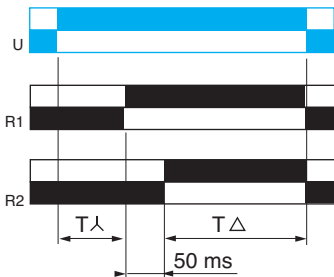

Timing for star-delta starter with double On-delay period.

Function T: Bistable relay

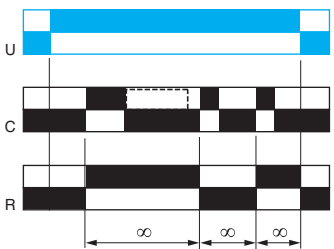

After power-up, pulsing or maintaining of control contact C turns on the output R. A second pulse on the control contact C turns off the output R.

Function Tt: Timed impulse relay

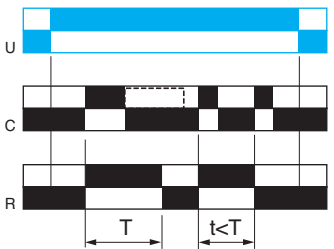

After power-up, pulsing or maintaining control contact C turns on output R and starts the timing. The output turns off at the end of the timing period T or following a second pulse on the control contact C.

Function W: On-delay after opening of control contact

1 output

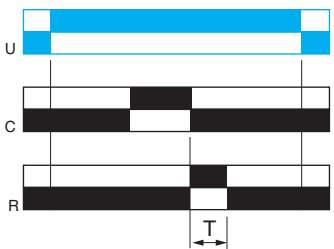

2 outputs

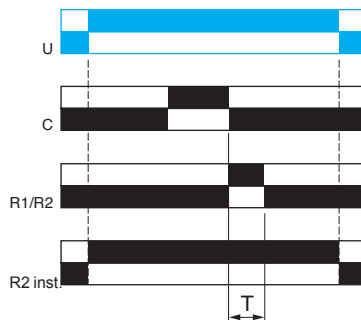

After power-up and opening of the control contact, the outputs R close for a timing period T. At the end of this timing period, the outputs revert to their initial state. The second output can be either timed or instantaneous.

2 timed outputs (R1/R2) or 1 timed output (R1) and 1 instantaneous output (R2 inst.).

Zelio® Timing Relays

Modular relays with solid state or relay output, width 17.5 mm (0.7 in.)

Solid state output

- Multifunction, dual function, or single function
- Multi-range (7 selectable ranges)
- Multivoltage
- Solid state output: 0.7 A
- Screw terminals



RE11LAMW



RE11LLBM

Relay output, 1 C/O contact

- Dual function or single function
- Multi-range (7 selectable ranges)
- Multivoltage
- 1 relay output: 8 A
- Screw terminals
- State indication by 1 LED
- Option of supplying a load in parallel
- 3-wire sensor control option



RE11RMM

Modular relays with solid state output 0.7 A

Single function				
Timing ranges	Functions	Voltages V	Catalog number	Weight kg (lb)
1 s, 10 s, 1 min, 10 min, 1 h, 10 h, 100 h	A	≈ 24–240	RE11LAMW	0.060 (0.13)
	H	~ 24–240	RE11LHBM	0.060 (0.13)
	C	~ 24–240	RE11LCBM	0.060 (0.13)
Dual function				
1 s, 10 s, 1 min, 10 min, 1 h, 10 h, 100 h	L, Li	~ 24–240	RE11LLBM	0.060 (0.13)
Multifunction				
1 s, 10 s, 1 min, 10 min, 1 h, 10 h, 100 h	A, At, B, C, H, Ht, D, Di, Ac, Bw	~ 24–240	RE11LMBM	0.060 (0.13)

Modular relays with relay output, 1 C/O contact

Single function				
Timing ranges	Functions	Voltages V	Catalog number	Weight kg (lb)
1 s, 10 s, 1 min, 10 min, 1 h, 10 h, 100 h	B	≈ 24–240	RE11RBMU	0.060 (0.13)
	C	≈ 24–240	RE11RCMU	0.060 (0.13)
Dual function				
1 s, 10 s, 1 min, 10 min, 1 h, 10 h, 100 h	A, At	≈ 24–240	RE11RAMU	0.060 (0.13)
	H, Ht	≈ 24–240	RE11RHMU	0.060 (0.13)
	L, Li	≈ 24–240	RE11RLMU	0.060 (0.13)
		≈ 12	RE11RLJU	0.060 (0.13)
Multifunction				
1 s, 10 s, 1 min, 10 min, 1 h, 10 h, 100 h	A, At, B, C, H, Ht, D, Di, Ac, Bw	≈ 12	RE11RMJU	0.060 (0.13)
		≈ 24–240	RE11RMMU	0.060 (0.13)
		≈ 12–240	RE11RMMW	0.060 (0.13)
			RE11RMMWS	0.060 (0.13)
	Ad, Ah, N, O, P, Pt, T, Tt, W	≈ 24–240	RE11RMXMU	0.060 (0.13)
1 s, 10 s, 1 min, 10 min, 1 h, 10 h	A, At, B, C, H, Ht, D, Di	≈ 24–240	RE11RMEMU	0.060 (0.13)

NOTE: Detailed function descriptions begin on page 10.
Dimensions and wiring diagrams begin on page 26.

Zelio® Timing Relays

Industrial single or multifunction relays,
solid state output, width 22.5 mm (0.9 in.)

Solid state output

- Multifunction or single function
- Multivoltage
- Screw terminals
- Transparent, hinged, and sealable flap on front panel



RE9A11MW



RE9MS21MW

Catalog numbers

Single function

Timing ranges	Functions	Voltages		Catalog number	Weight
		V			
0.1–10 s	A	~ 24–240 V		RE9TA11MW	0.110 (0.24)
	C	~ 24–240 V		RE9RA11MW7	0.110 (0.24)
0.3–30 s	A	~ 24–240 V		RE9TA31MW	0.110 (0.24)
	C	~ 24–240 V		RE9RA31MW7	0.110 (0.24)
3–300 s	A	~ 24–240 V		RE9TA21MW	0.110 (0.24)
	C	~ 24–240 V		RE9RA21MW7	0.110 (0.24)
40 s–60 min	A	~ 24–240 V		RE9TA51MW	0.110 (0.24)
	C	~ 24–240 V		RE9RA51MW7	0.110 (0.24)
Multifunction					
0.1–10 s, 0.3–30 s	A, H, D, Di	~ 24–240 V		RE9MS21MW	0.110 (0.24)

NOTE: Detailed function descriptions begin on page 10.
Dimensions and wiring diagrams begin on page 26.

Zelio® Timing Relays

Industrial single, dual, or multifunction relays, relay output, width 22.5 mm (0.9 in.)

Output 1 C/O and 2 C/O contacts

- Multifunction, dual function, or single function
- Multiple timing ranges (7 switchable ranges)
- Multivoltage
- 1 and 2 relay outputs: 8 A - 250 V (10 A UL)
- Screw or spring terminals
- State indication by 1 LED
- Option of supplying a load in parallel
- 3-wire sensor control option



RE88865125



RE88865155

Catalog numbers

Single function

Timing ranges	Functions	No. of relay outputs	Voltages	Catalog number	Weight
			V		kg (lb)
1 s, 10 s, 1 min, 10 min, 1 h, 10 h, 100 h	B	1	~ 24–240	RE88865125 (1)	0.090 (0.20)
	C	1	~ 24–240	RE88865135 (1)	0.090 (0.20)

0.6 s, 2.5 s, 20 s, 160 s	K	2	~ 24–240	RE88865265 (1)	0.090 (0.20)
------------------------------------	---	---	----------	-------------------	-----------------

Selectable interswitching time

Timing ranges	Functions	No. of relay outputs	Voltages	Catalog number	Weight
			V		kg (lb)
20 ms, 40 ms, 60 ms, 80 ms, 100 ms, 120 ms, 140 ms	Q	1	~ 24–240	RE88865175 (1)	0.090 (0.20)
			~ 230 / 380	RE88865176 (1)	0.090 (0.20)

Dual function

Timing ranges	Functions	No. of relay outputs	Voltages	Catalog number	Weight
			V		kg (lb)
1 s, 10 s, 1 min, 10 min, 1 h, 10 h, 100 h	A, At	2	~ 24–240	RE88865215 (1)	0.090 (0.20)
		1	~ 24–240	RE88865115 (1)	0.090 (0.20)
	H, Ht	1	~ 24–240	RE88865145 (1)	0.090 (0.20)
	L, Li	1	~ 24–240	RE88865155 (1)	0.090 (0.20)

Multifunction

1 s, 10 s, 1 min, 10 min, 1 h, 10 h, 100 h	A, At, B, C, H, Ht, Di, D, Ac, Bw	1	~ 24–240	RE88865105 (1)	0.090 (0.20)
		1	~ 12	RE88865100 (1)	0.090 (0.20)
		1	~ 12–240	RE88865103 (1)	0.090 (0.20)
				RE88865503 (2)	0.090 (0.20)
		2, of which 1 is convertible to instantaneous	~ 24–240	RE88865305 (1)	0.090 (0.20)
			~ 12	RE88865300 (1)	0.090 (0.20)
			~ 12–240	RE88865303 (1)	0.090 (0.20)
	Ad, Ah, N, O, P, Pt, Ti, Tt, W	1	~ 24–240	RE88865185 (1)	0.090 (0.20)
		2	~ 24–240	RE88865385 (1)	0.090 (0.20)

(1) Connection by screw terminals.
(2) Connection by spring terminals.

NOTE: Detailed function descriptions begin on page 10.
Dimensions and wiring diagrams begin on page 26.

Zelio® Timing Relays

Industrial single, dual, or multifunction relays, relay output, width 22.5 mm (0.9 in.)

Output 1 C/O and 2 C/O contacts

- Multifunction, dual function, or single function
- Multiple timing ranges
- Multivoltage
- Transparent, hinged, and sealable flap on front panel



RE7TM11BU



RE7MA11BU



RE7CV11BU

Catalog numbers					
Timing ranges	Functions	No. of relay outputs	Voltages	Catalog number	Weight
			V		kg (lb)
0.05 s–300 h (10 ranges)	A, Aw, At	1	~ 24, ~ 110–240, ~ 42–48	RE7TM11BU	0.150 (0.33)
	Ac	1	~ 24, ~ 110–240, ~ 42–48	RE7MA11BU	0.150 (0.33)
		2	~ 24, ~ 110–240, ~ 42–48	RE7MA13BU <i>(symmetrical)</i>	0.150 (0.33)
	Ak	1	~ 24, ~ 110–240, ~ 42–48	RE7MV11BU	0.150 (0.33)
		C	1	~ 24, ~ 110–240, ~ 42–48	RE7RA11BU
	1		~ 24, ~ 110–240, ~ 42–48	RE7RM11BU <i>(low level contact)</i>	0.150 (0.33)
		2	~ 24, ~ 110–240, ~ 42–48	RE7RL13BU <i>(low level contact)</i>	0.150 (0.33)
		Ht, W	1	~ 24, ~ 110–240, ~ 42–48	RE7PM11BU
	L, Li, Lt	1	~ 24, ~ 110–240, ~ 42–48	RE7CV11BU	0.150 (0.33)
	A, C, H, W, D, Di	1	~ 24, ~ 110–240, ~ 42–48	RE7ML11BU	0.150 (0.33)
		A	1	~ 24, ~ 110...240	RE7TL11BU
	2		~ 24, ~ 110–240, ~ 42–48	RE7TP13BU	0.150 (0.33)
	H	1	~ 24, ~ 110–240	RE7PE11BU	0.150 (0.33)
		2	~ 24, ~ 110–240, ~ 42–48	RE7PP13BU	0.150 (0.33)
	D	1	~ 24, ~ 110–240	RE7CL11BU	0.150 (0.33)
		2	~ 24, ~ 110–240, ~ 42–48	RE7CP13BU	0.150 (0.33)
	W	2	~ 24, ~ 110–240, ~ 42–48	RE7PD13BU	0.150 (0.33)
	Qt	2	~ 24, ~ 110–240, ~ 42–48	RE7YA12BU	0.150 (0.33)
Qg	2	~ 24, ~ 110–240, ~ 42–48	RE7YR12BU	0.150 (0.33)	
A, C, H, W, D, Di, Qg, Qt	2	~ 24, ~ 110–240, ~ 42–48	RE7MY13BU	0.150 (0.33)	
	2	~ 24–240	RE7MY13MW	0.150 (0.33)	
0.05 s–10 min (7 ranges)	K	1	~ 24–240	RE7RB11MW	0.150 (0.33)
		2	~ 24–240	RE7RB13MW	0.150 (0.33)

NOTE: Detailed function descriptions begin on page 10.
Dimensions and wiring diagrams begin on page 26.

Zelio® Timing Relays

Industrial single function relays, optimum, relay output, width 22.5 mm (0.9 in.)

- Single function
- Single timing range
- Output 1 C/O contact
- Transparent, hinged, and sealable flap on front panel



RE8TA●●●●●●●●

Catalog numbers				
Timing ranges	Functions	Voltages		Weight
			Catalog number	
		V	(1)	kg (lb)
0.05–0.5 s	K	⎯ 24, ~ 110–240	RE8RB51BUTQ	0.110 (0.24)
	He	⎯ 24, ~ 110–240	RE8PT01BUTQ	0.110 (0.24)
0.1–3 s	A	⎯ 24, ~ 110–240	RE8TA61BUTQ	0.110 (0.24)
0.1–10 s	A	⎯ 24, ~ 110–240	RE8TA11BUTQ	0.110 (0.24)
		⎯ 24	RE8RA11BTQ	0.110 (0.24)
	C	~ 110–240	RE8RA11FUTQ	0.110 (0.24)
		⎯ 24, ~ 110–240	RE8CL11BUTQ	0.110 (0.24)
	K	⎯ 24, ~ 110–240	RE8RB11BUTQ	0.110 (0.24)
	H	⎯ 24, ~ 110–240	RE8PE11BUTQ	0.110 (0.24)
	Qc	⎯ 24, ~ 110–240	RE8YG11BUTQ	0.110 (0.24)
	W	⎯ 24	RE8PD11BTQ	0.110 (0.24)
		~ 110–240	RE8PD11FUTQ	0.110 (0.24)
	0.3–30 s	A	⎯ 24, ~ 110–240	RE8TA31BUTQ
⎯ 24			RE8RA31BTQ	0.110 (0.24)
C		~ 110–240	RE8RA31FUTQ	0.110 (0.24)
		⎯ 24, ~ 110–240	RE8PE31BUTQ	0.110 (0.24)
K		⎯ 24, ~ 110–240	RE8RB31BUTQ	0.110 (0.24)
Qc		⎯ 24, ~ 110–240	RE8YG31BUTQ	0.110 (0.24)
Qe		⎯ 24	RE8YA32BTQ	0.110 (0.24)
		~ 110–240	RE8YA32FUTQ	0.110 (0.24)
W		~ 380–415	RE8YA32QTQ	0.110 (0.24)
		⎯ 24	RE8PD31BTQ	0.110 (0.24)
		~ 110–240	RE8PD31FUTQ	0.110 (0.24)
		3–300 s	A	⎯ 24, ~ 110–240
⎯ 24	RE8RA21BTQ			0.110 (0.24)
C	~ 110–240	RE8RA21FUTQ	0.110 (0.24)	
	⎯ 24, ~ 110–240	RE8PE21BUTQ	0.110 (0.24)	
Qc	⎯ 24, ~ 110–240	RE8YG21BUTQ	0.110 (0.24)	
W	⎯ 24	RE8PD21BTQ	0.110 (0.24)	
	~ 110–240	RE8PD21FUTQ	0.110 (0.24)	
20 s–30 min	A	⎯ 24, ~ 110–240	RE8TA41BUTQ	0.110 (0.24)
		~ 110–240	RE8RA41FUTQ	0.110 (0.24)

(1) These products are sold in packs of 10

NOTE: Detailed function descriptions begin on page 10.
Dimensions and wiring diagrams begin on page 26.

Zelio® Timing Relays

Universal plug-in relays, 11-pin,
relay output, width 35 mm (1.4 in.)

Output 2 C/O contacts

- Multifunction, dual function, or single function
- Multiple timing ranges (7 switchable ranges)
- Multivoltage
- 2 relay output: 8 A - 250 V (10 A UL)
- Plug-in
- State indication by 1 LED
- Option of supplying a load in parallel
- 3-wire sensor control option



RE88867415



RE88867305



RE88867300

Catalog numbers

Single function

Timing ranges	Functions	No. of relay outputs	Voltages	Catalog number	Weight
			V		kg (lb)
1 s, 10 s, 1 min, 10 min, 1 h, 10 h, 100 h	C	2	≈ 24–240	RE88867435	0.080 (0.18)

Dual function

1 s, 10 s, 1 min, 10 min, 1 h, 10 h, 100 h	A, At	2	≈ 24–240	RE88867415	0.080 (0.18)
	Li, L	2	≈ 24–240	RE88867455	0.080 (0.18)

Multifunction

1 s, 10 s, 1 min, 10 min, 1 h, 10 h, 100 h	A, At, B, C, H, Ht, Di, D, Ac, Bw	2, of which 1 is instantaneous	≈ 24–240 ≈ 12 ≈ 12–240	RE88867305 RE88867300 RE88867303	0.080 (0.18) 0.080 (0.18) 0.080 (0.18)
--	--	--------------------------------------	------------------------------	--	---

Sockets (1) for 11-pin relays

Contact terminal arrangement	For use with relays	Connection	Catalog number	Weight
				kg (lb)
Mixed (2)	RE88867●●●	Connector	RXZE2M114	0.054 (0.12)

(1) These products are sold in packs of 10

(2) The inputs are mixed with the relay's supply. The outputs are located on the opposite side of the socket.

NOTE: Detailed function descriptions begin on page 10.
Dimensions and wiring diagrams begin on page 26.

Zelio® Timing Relays

Universal plug-in relays, 8-pin,
relay output, width 35 mm (1.4 in.)

Output 1 C/O or 2 C/O contacts

- Multifunction, dual function, or single function
- Multiple timing ranges (7 switchable ranges)
- Multivoltage
- 1 or 2 relay outputs: 8 A - 250 V (10 A UL)
- Plug-in
- State indication by 1 LED
- Option of supplying a load in parallel
- 3-wire sensor control option



RE88867215



RE88867155



RE88867105

Catalog numbers

Single function

Timing ranges	Functions	No. of relay outputs	Voltages	Catalog number	Weight
			V		kg (lb)
1 s, 10 s, 1 min, 10 min, 1 h, 10 h, 100 h	A	2	~ 24–240	RE88867215	0.080 (0.18)
	C	1	~ 24–240	RE88867135	0.080 (0.18)

Dual function

1 s, 10 s, 1 min, 10 min, 1 h, 10 h, 100 h	Li, L	1	~ 24–240	RE88867155	0.080 (0.18)
--	----------	---	----------	------------	-----------------

Multifunction

1 s, 10 s, 1 min, 10 min, 1 h, 10 h, 100 h	A, At, B, C, H, Ht, Di, D, Ac, Bw	1	~ 24–240	RE88867105	0.080 (0.18)
			~ 12	RE88867100	0.080 (0.18)
			~ 12–240	RE88867103	0.080 (0.18)

Sockets (1) for 8-pin relays

Contact terminal arrangement	For use with relays	Catalog number	Weight
			kg (lb)
Mixed (2)	RE888671●●, RE888672●●	RUZC2M	0.054 (0.12)

(1) These products are sold in packs of 10.

(2) The inputs are mixed with the relay's supply. The outputs are located on the opposite side of the socket.

NOTE: Detailed function descriptions begin on page 10.
Dimensions and wiring diagrams begin on page 26.

Output, 2 C/O and 4 C/O contacts

- Miniature and plug-in (21 x 27 mm)
- Single function: function A = delay on energization
- Rated current ~ 5 A
- 7 timing ranges (0.1 s to 100 h)
- Multivoltage
- Excellent immunity to interference
- Power on and relay energized indication by 2 LEDs



REXL2TM●●



REXL4TM●●

Catalog numbers

Single function

Timing ranges	Functions	No. of relay outputs	Voltages		Catalog number	Weight	
				V			
0.1–1 s, 1–10 s, 0.1–1 min, 1–10 min, 0.1–1 h, 1–10 h, 10–100 h (7 switchable ranges)	A	2	⎓ 12		REXL2TMJD	0.050 (0.11)	
			⎓ 24		REXL2TMBD	0.050 (0.11)	
			~ 24 (50/60 Hz)	REXL2TMB7	0.050 (0.11)		
			~ 120 (50/60 Hz)	REXL2TMF7	0.050 (0.11)		
			~ 230 (50/60 Hz)	REXL2TMP7	0.050 (0.11)		
			4	⎓ 12		REXL4TMJD	0.050 (0.11)
				⎓ 24 (1)		REXL4TMBD	0.050 (0.11)
		~ 24 (50/60 Hz) (1)		REXL4TMB7	0.050 (0.11)		
		~ 120 (50/60 Hz)		REXL4TMF7	0.050 (0.11)		
		~ 230 (50/60 Hz)		REXL4TMP7	0.050 (0.11)		

Sockets (2) for relays

Contact terminal arrangement	For use with relays	Connection	Catalog number	Weight
				kg (lb)
Mixed (3)	REXL2TM●●, REXL4TM●●	Screw clamp	RXZE2M114 (5)	0.048 (0.11)
	REXL2TM●●, REXL4TM●●	Connector	RXZE2M114M (6)	0.056 (0.12)
Separate (4)	REXL2TM●●	Connector	RXZES108M	0.070 (0.15)
	REXL4TM●●	Connector	RXZE2S114M	0.058 (0.13)

(1) For ⎓ 48 V supply, additional resistor 560 Ω 2 W / ⎓ 24 V.
For ~ 48 V, additional resistor 390 Ω 4 W / ~ 24 V.

(2) These products are sold in packs of 10.

(3) The inputs are mixed with the relay's supply. The outputs are located on the opposite side of the socket.

(4) The inputs and outputs are separated from the relay supply.

(5) Thermal current I_{th}: 10 A.

(6) Thermal current I_{th}: 12 A.

NOTE: Detailed function descriptions begin on page 10.
Dimensions and wiring diagrams begin on page 26.

Zelio® Timing Relays

Analog, electronic relays,
relay output, 48 x 48

Output 2 C/O contacts

- Time unit selector knob
- Multifunction, single function, or dual function
- Multirange
- Multivoltage
- 2 relay outputs, 5 A
- Panel-mounted or plug-in
- LED indication



RE48ATM12MW



RE48AMH13MW

Catalog numbers

8-pin relay

Timing ranges	Function	No. of relay outputs	Voltages	Catalog number	Weight
			V		kg (lb)
1.2 s, 3 s, 12 s, 30 s, 120 s, 300 s, 12 min, 30 min, 120 min, 300 min, 12 h, 30 h, 120 h, 300 h	A	1	≈ 24–240	RE48ATM12MW	0.140 (0.31)
	A1, A2, H1, H2	2, of which 1 is instantaneous	≈ 24–240	RE48AMH13MW	0.140 (0.31)

11-pin relay

1.2 s, 3 s, 12 s, 30 s, 120 s, 300 s, 12 min, 30 min, 120 min, 300 min, 12 h, 30 h, 120 h, 300 h	L, Li	2	≈ 24–240	RE48ACV12MW	0.140 (0.31)
	A, B, C, Di	2	≈ 24–240	RE48AML12MW	0.140 (0.31)

NOTE: Detailed function descriptions begin on page 10.
Dimensions and wiring diagrams begin on page 26.

Zelio® Timing Relays

Analog, electronic relays,
relay output, 48 x 48



RUZC3M



RE48ASOC11AR



RE48ASOC8SOLD



RE48ASOC11SOLD



RE48ASETCOV



RE48AIPCOV

Sockets					
Description	Number of pins	For use with relays	Sold in packs of	Catalog number	Weight kg (lb)
IP20 sockets with connection by connector and mixed contact terminals (1)	8	RE48ATM12MW, RE48AMH13MW	10	RUZC2M	0.054 (0.12)
	11	RE48ACV12MW, RE48AML12MW	10	RUZC3M	0.054 (0.12)
IP20 socket with screw terminal connections on rear face	11	RE48ACV12MW, RE48AML12MW	1	RE48ASOC11AR	—
Connectors and protective cover					
IP20 solder connectors	8	RE48ATM12MW, RE48AMH13MW	1	RE48ASOC8SOLD	—
	11	RE48ACV12MW, RE48AML12MW	1	RE48ASOC11SOLD	—
Setting protection cover	—	RE48ATM12MW, RE48ACV12MW, RE48AML12MW, RE48AMH13MW	1	RE48ASETCOV	—
Protective cover IP64	—	RE48ATM12MW, RE48ACV12MW, RE48AML12MW, RE48AMH13MW	1	RE48AIPCOV	—

(1) The inputs are mixed with the relay's supply. The outputs are located on the opposite side of the socket.

NOTE: Detailed function descriptions begin on page 10.
Dimensions and wiring diagrams begin on page 26.

Zelio® Timing Relays

Modular relays with solid state or relay output, width 17.5 mm (0.7 in.)

Dimensions and terminal locations for RE11 models

RE11RAMU, RE11RHMU, RE11RLMU

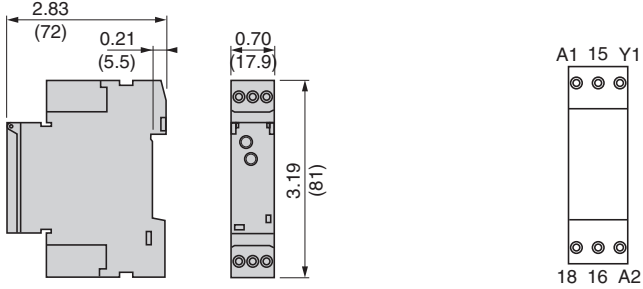

Dual dimensions = $\frac{\text{in.}}{\text{mm}}$

RE11RMMU, RE11RMMW, RE11RMJU

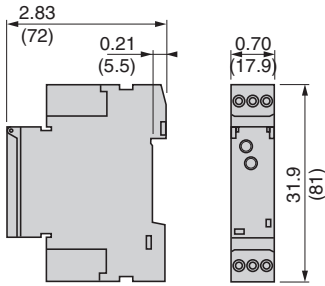

RE11RMMWS

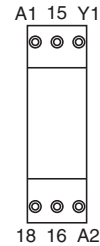
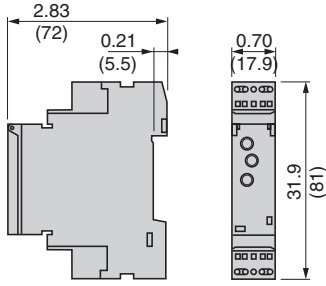

RE11LAMW, RE11LHBM, RE11LCBM, RE11LLBM, RE11LMBM

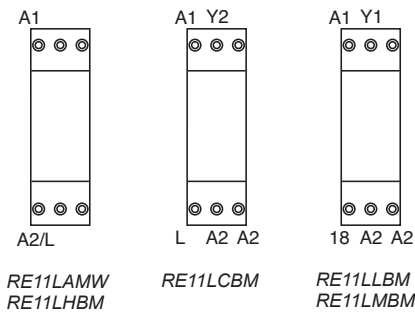
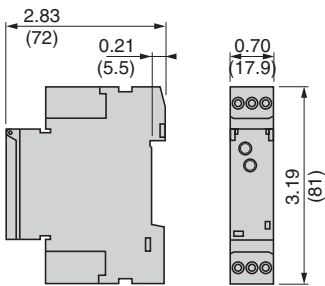

Wiring connection diagrams for RE11 models

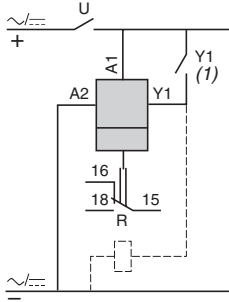

Contact Y1:

- Control for functions B, C, Ac, Bw, Ad, Ah, N, O, W, Tl, Tt
- Partial stop for functions At, Ht, and Pt
- Function D if Di selected
- Not used for functions A, H, and P

Functions A and At

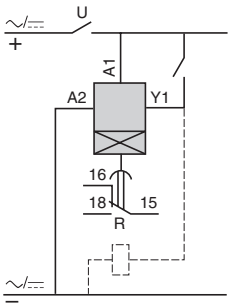

Functions H and Ht

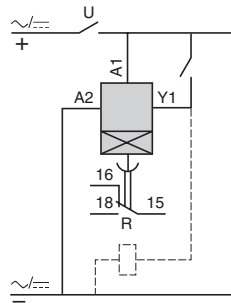

Functions L and Li

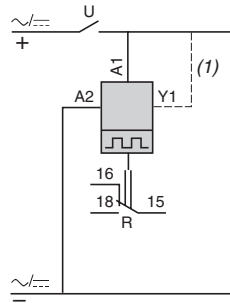

Functions B and C

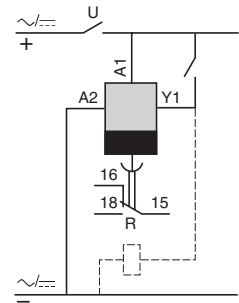

(1) Jumper A1-Y1 for function L only

Single function relay

Functions A and H

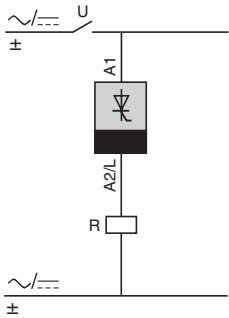

Function C

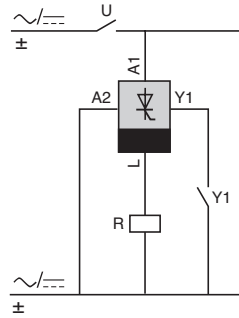

Multi-function relay

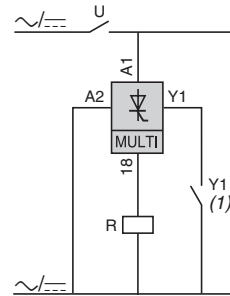

Flasher

Functions L and Li

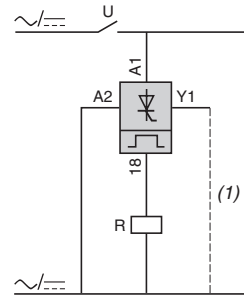

Contact Y1:

- Control for functions B, C, Ac, Bw
- Partial stop for functions At, Ht
- Function D if Di selected
- Not used for functions A and H

Dimensions and terminal locations for RE7, RE8, and RE9 models

RE7

RE8

RE9

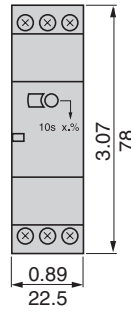
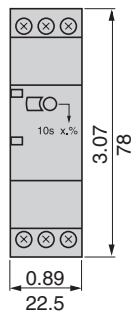
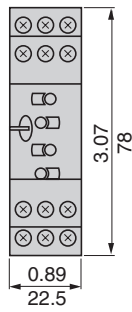
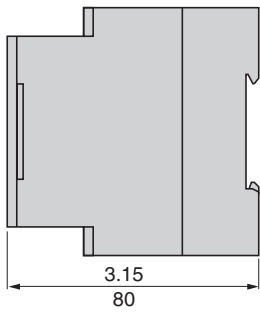

Dual dimensions = $\frac{\text{in.}}{\text{mm}}$

Rail mounting

RE7

RE8

RE9

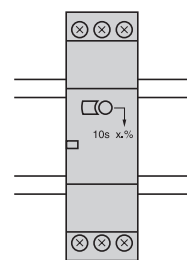
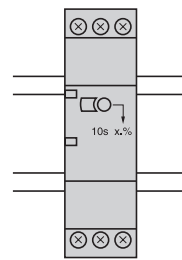
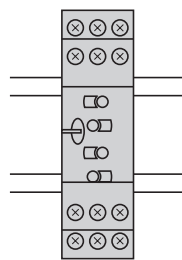
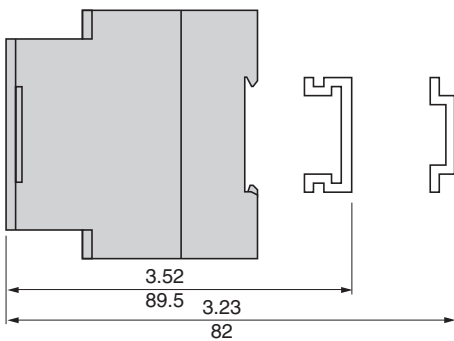

Direct panel mounting

RE7

RE8

RE9

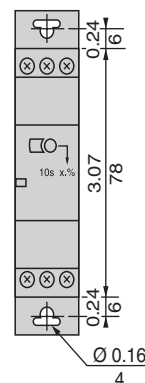
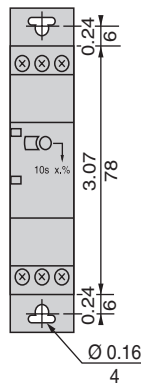
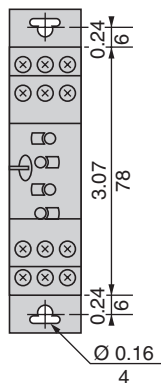
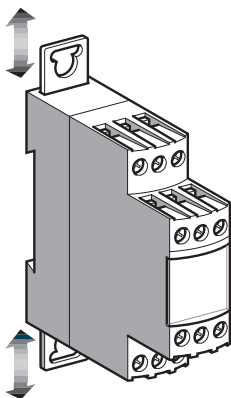

Wiring connection diagrams for RE7 models: Industrial multi-function timers

RE7ML11BU

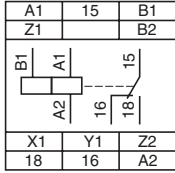

RE7MY13BU

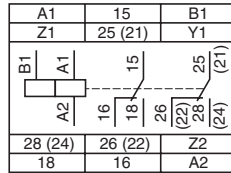

RE7MY13MW

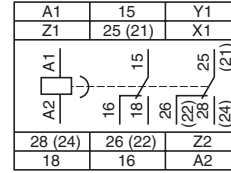

Recommended wiring diagrams

Start on energization

RE7ML11BU, RE7MY13BU, or RE7MY13MW

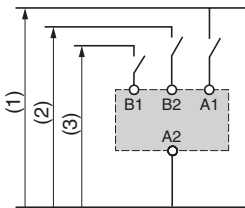

Start by external control

RE7ML11BU, RE7MY13BU, or RE7MY13MW

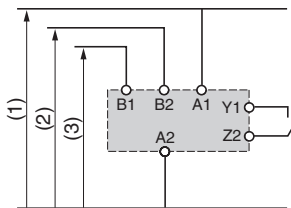

External control of partial stop

RE7ML11BU or RE7MY13MW

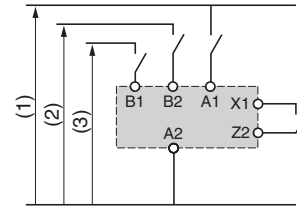

- (1) 110-240 Vac: RE7ML11BU or RE7MY13BU; 24-240 Vdc or Vac: RE7MY13MW
- (2) 42-48 Vac or Vdc: RE7ML11BU
- (3) 24 Vac or Vdc: RE7ML11BU or RE7MY13BU

Potentiometer wiring

RE7ML11BU, RE7MY13BU, or RE7MY13MW

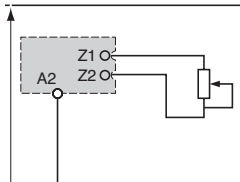

Wiring precautions

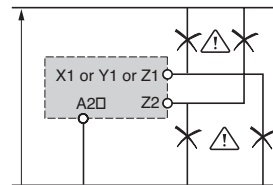

⚠ No electrical insulation between supply terminals A1, A2, B1, B2 and control inputs X1, Y1, Z1, Z2.

Wiring connection diagrams for RE8 models: Industrial single-function relay output timers

RE8TA, CL

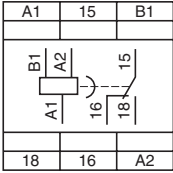

RE8RA

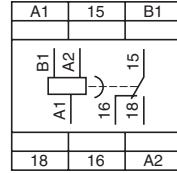

RE8RB

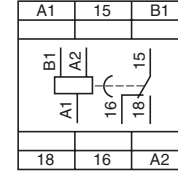

Recommended wiring diagrams

RE8TA, RB, CL

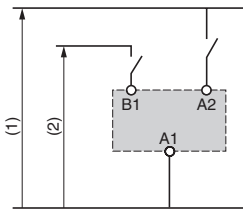

(1) 110-240 Vac

RE8RA

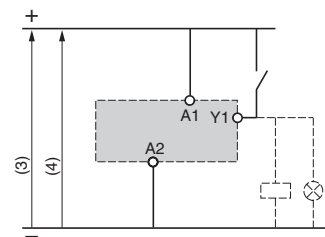

(2) 24 Vdc or Vac

(3) 24 Vdc

(4) 24 Vac or 110-240 Vac

RE8TPE

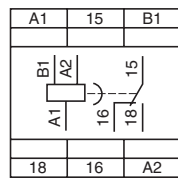

RE8PD

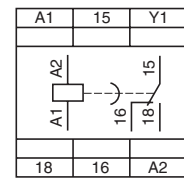

RE8PT

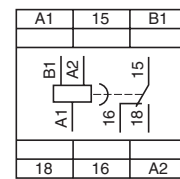

RE8YA

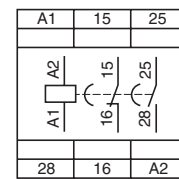

RE8YG

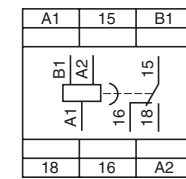

Recommended wiring diagrams - interval timers

RE8PE

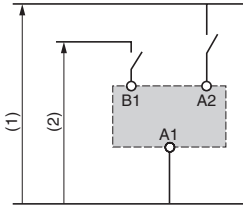

(1) 110-240 Vac

(2) 24 Vdc or Vac

RE8PD

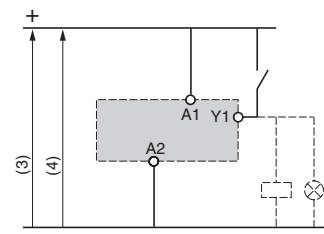

(3) 24 Vdc

(4) 24 Vac or 110-240 Vac

Recommended wiring diagrams - timers for star-delta starters

RE8YG, RE8YA

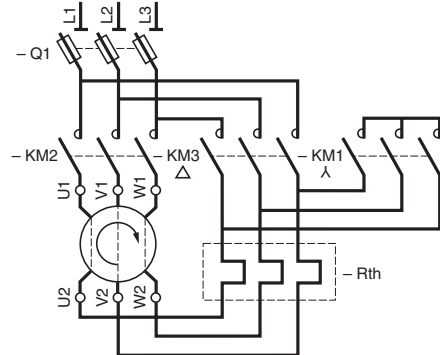

RE8YG

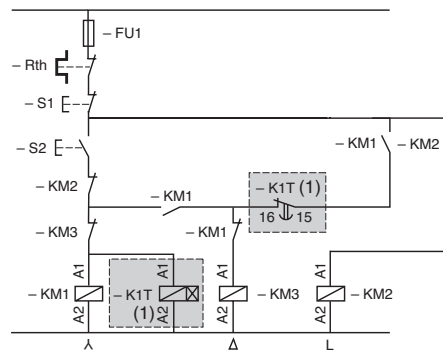

(1) K1T: RE8YG●1●●TQ

RE8YA

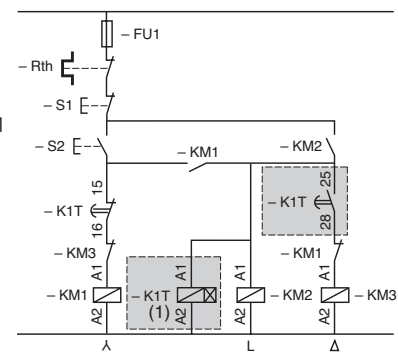

(1) K1T: RE8YA32●●TQ

NOTE: Correct operation of the star-delta starter associated with the RE8YG is only possible if the wiring diagram is strictly followed.

Control of several RE8 single-function relay output timers with a single external control contact

RE8RA, PD

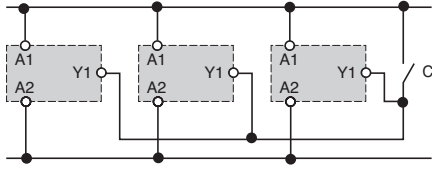

The external control contact C may be an electronic control device, for example, a 2-wire sensor. In this case, A1 - A2 = 24 Vdc and the control device can only control up to a maximum of 4 timers.

Connection of Telemecanique 2-wire VDC sensor

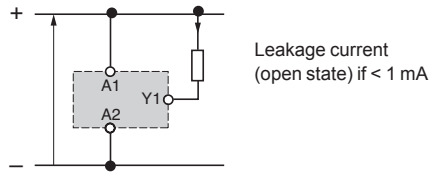

Wiring connection diagrams for RE9 models

RE9MS

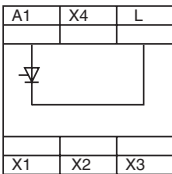

On-delay ☒

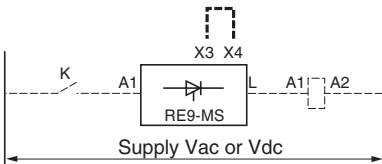

Interval ☒ ☒

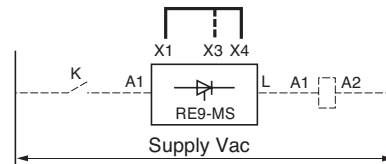

Jumper to be made between terminals X1 and X4

Selection of timing range:

X3-X4 not jumpered: range 3-300 s (factory configuration)

X3-X4 jumpered: range 0.1-10 s

Repeat cycle ☒ ☒

Start on energization of the load

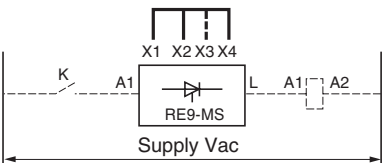

Repeat cycle ☒ ☒

Start on de-energization of the load

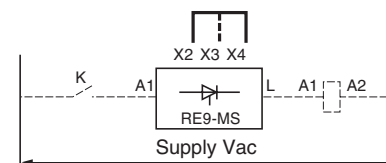

----- May need to be jumpered.
————— Must be jumpered

Jumper to be made between terminals X2 and X4 on one side and X1 and X2 on the other side.

Jumper to be made between terminals X2 and X4.

NOTE: For supply voltages greater than 30 V, the rated voltage of the load is equal to the supply voltage. For a supply voltage of 24 V, the voltage drop in the RE9 timer must be taken into account (about 3 V); select a coil with a nominal voltage of 21 V for the load.

Dimensions and terminal locations for RE88865 models

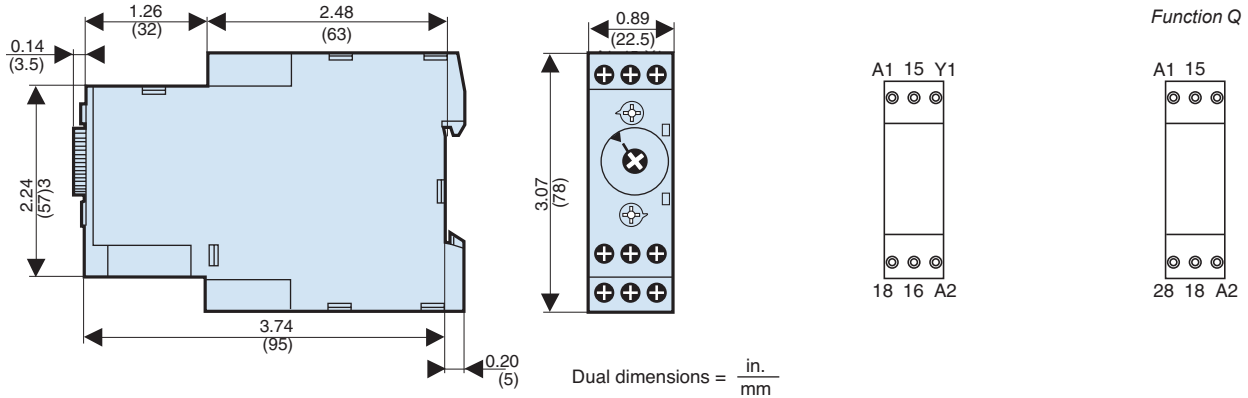

Wiring connection diagrams for RE88865 models

All functions except L and Li

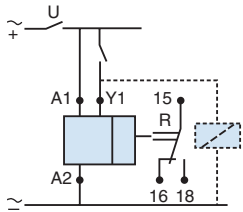

Functions L and Li

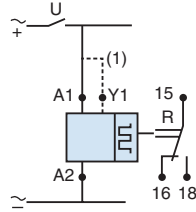

(1) Jumper A1-Y1 for function L only

All functions except K

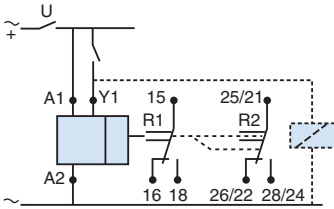

Function K

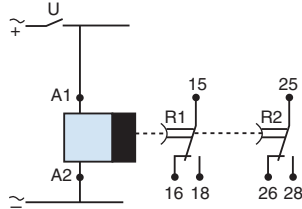

Function Q

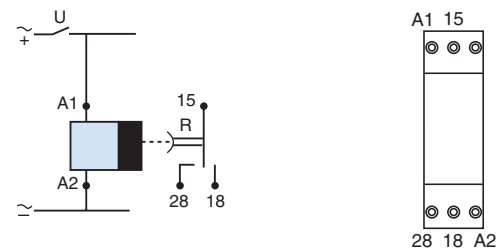

Dimensions and terminal locations for REXL models

Approximate dimensions

REXL4TM●●

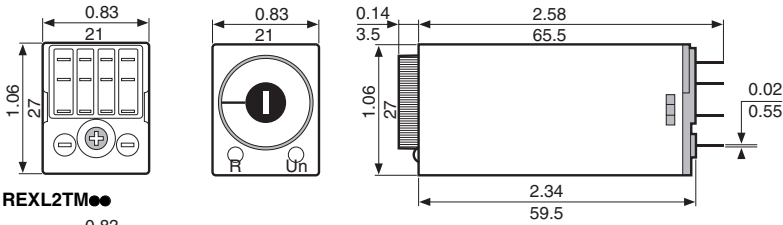

Dual dimensions = $\frac{\text{in.}}{\text{mm}}$

REXL2TM●●

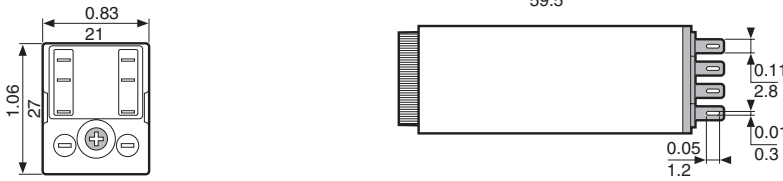

Terminal locations

REXL4TM●●

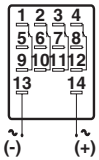

REXL2TM●●

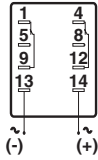

Wiring connection diagrams for REXL models

Timer with 4 C/O contacts

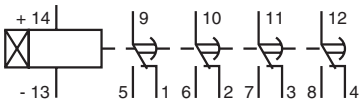

Timer with 2 C/O contacts

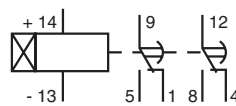

Dimensions and terminal locations for RE88867 plug-in timers (8-pin, relay output)

Approximate dimensions

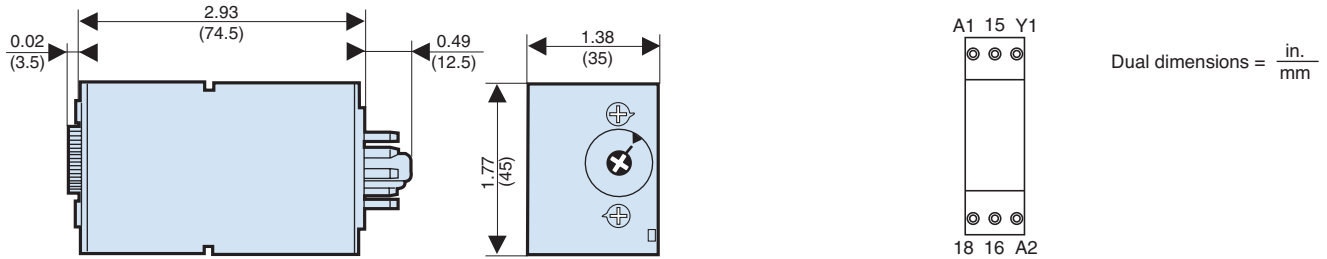

Dimensions and terminal locations for RE88867 plug-in timers (11-pin, relay output)

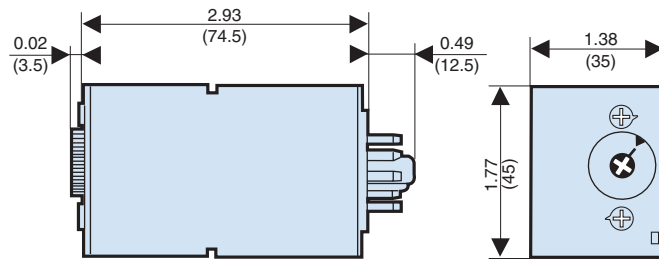

Wiring connection diagrams for RE88867 plug-in timers (8-pin, relay output)

Timing relays with 1 relay output All functions except L and Li

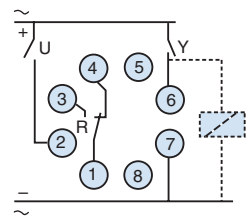

Functions L and Li

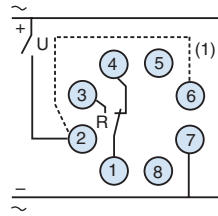

Timing relays with 2 relay outputs Function A

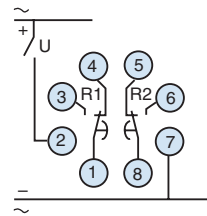

(1) Jumper between pins 2 and 6 for function L only

Wiring connection diagrams for RE88867 plug-in timers (11-pin, relay output)

All functions except L and Li

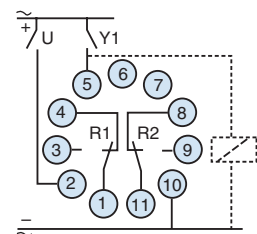

Functions L and Li

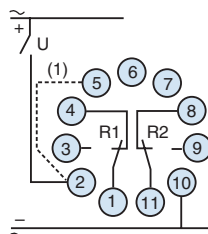

(1) Jumper between pins 2 and 5 for function L only

Dimensions for RE48 models

Approximate dimensions

RE48A●●1●MW

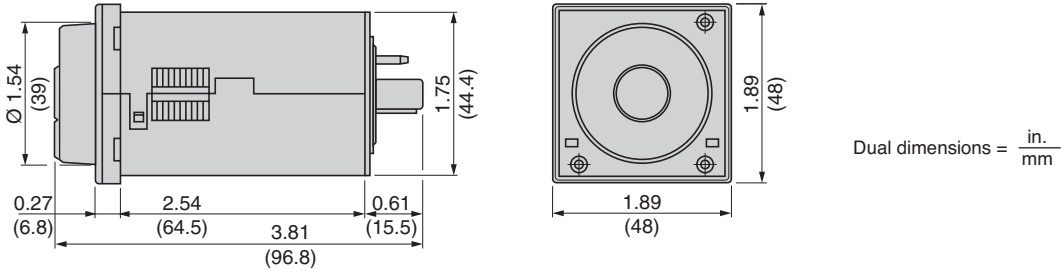

8-pin socket

8501NR51

8501NR52

11-pin socket

8501NR61

8501NR62

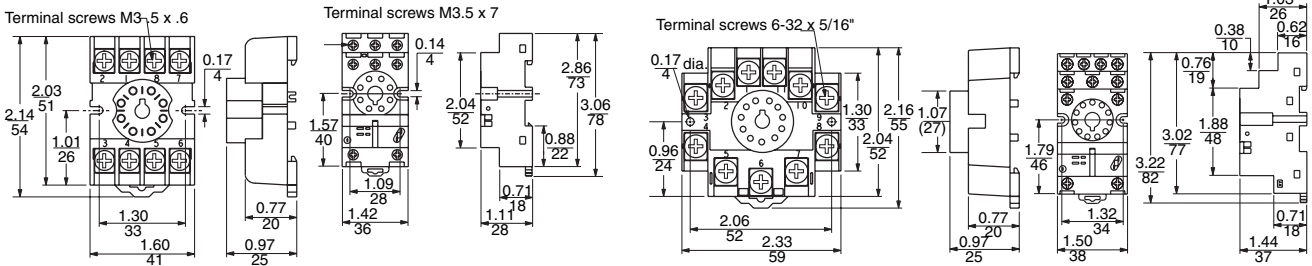

11-pin socket

RE48ASOC11AR

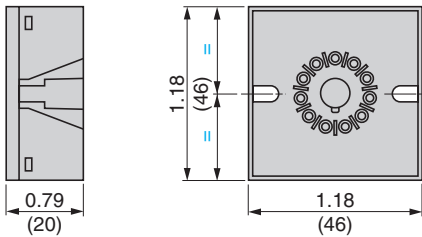

8-pin connector

RE48ASOC8SOLD

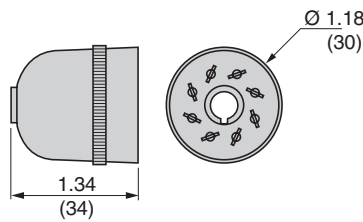

11-pin connector

RE48ASOC11SOLD

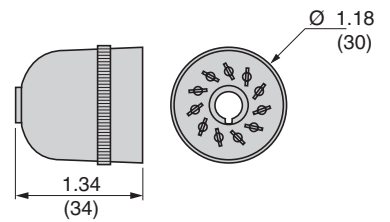

Mounting

Cover positioning and mounting

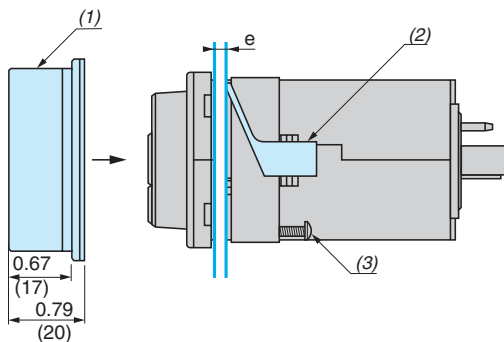

Panel cut-out

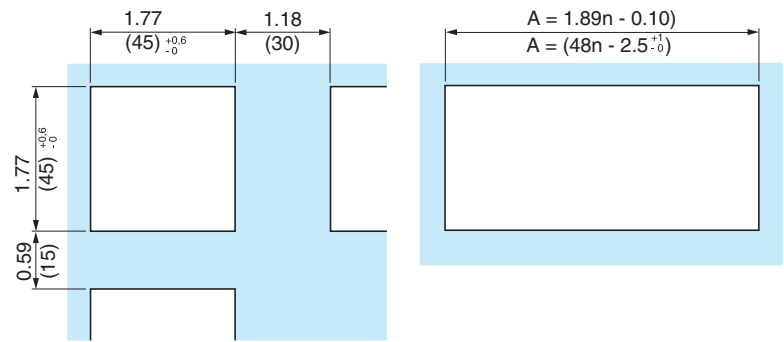

e: panel thickness
(1) IP64 protective cover: RE48AIPCOV
(2) Panel mounting frame
(3) Locating screw

n: number of devices mounted side-by-side

Wiring connection diagrams for RE48 panel-mount timers

RE48ATM12MW

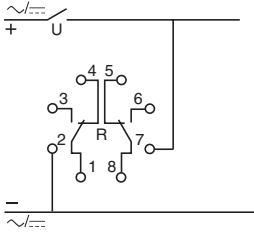

RE48ACV12MW

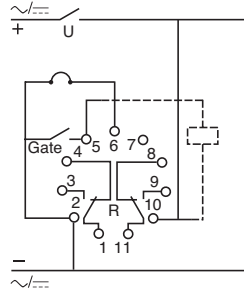

RE48AML12MW

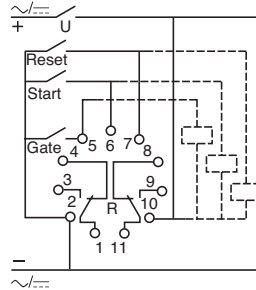

RE48AMH13MW

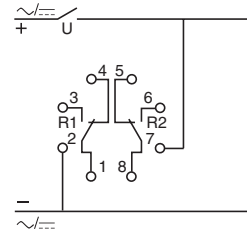

Schneider Electric USA, Inc.

8001 Knightdale Blvd.
Knightdale, NC 27545
USA
1-888-SquareD
1-888-778-2733

www.schneider-electric.us

The information and dimensions in this catalog are provided for the convenience of customers. While this information is believed to be accurate, Schneider Electric reserves the right to make updates and changes without prior notification and assumes no liability for any errors or omissions.

Design: Schneider Electric
Photos: Schneider Electric