

CANopen for machines

Catalog

September **2019**

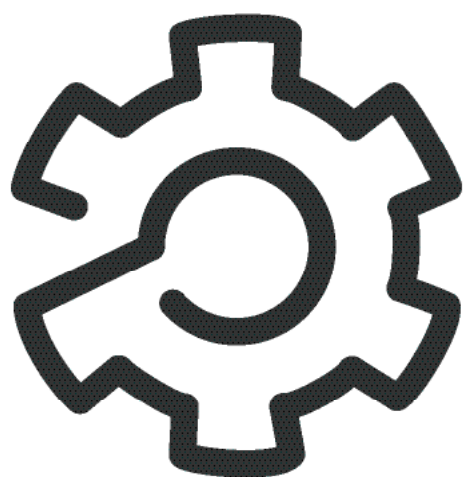

CANopen
CANopen

Schneider
Electric

General content

<i>Introduction to EcoStruxure Machine</i>	page 2
<i>Selection guide: controllers for industrial machines</i>	page 4
<i>Machine automation</i>	page 6

CANopen for machines

■ Integrated CANopen bus port on Modicon M241 and Modicon M251 logic controllers	
- Presentation	page 8
- References	page 9
■ Integrated CANopen bus port on Altivar IMC drive controller	
- Presentation	page 10
- References	page 12
■ CANopen bus master module for Magelis XBTGC controllers	
- Presentation	page 11
- References	page 12
■ Integrated CANopen bus port on Modicon M258 logic controllers	
- Presentation	page 14
- References	page 16
■ Integrated CANopen/CANmotion bus ports on Modicon LMC058 motion controllers	
- Presentation	page 15
- References	page 16
■ Interface modules for distributed I/O on CANopen bus with Modicon TM5 (IP20)	
- Presentation	page 18
- Description, References	page 19
■ Interface modules for distributed I/O on CANopen bus with Modicon TM7 interface blocks (IP67)	
- Selection guide	page 20
- Presentation	page 22
- Description	page 24
- References	page 25 to page 29
■ Product reference index	page 30

To be competitive in today's digital era, machine builders must be innovative. Smart machines, those that are better connected, more flexible, more efficient, and safe, are enabling machine builders to innovate in ways never before possible.

EcoStruxure, Schneider Electric's open, IoT-enabled architecture and platform, offers powerful solutions for the digital era. As part of this, EcoStruxure Machine brings powerful opportunities for machine builders and OEMs, empowering them to offer smart machines and compete in the new, digital era.

EcoStruxure Machine brings together key technologies for product connectivity and edge control on premises, and cloud technologies to provide analytics and digital services. EcoStruxure Machine helps you bring more innovation and added value to your customers throughout the entire machine life cycle.

Innovation at Every Level for Machines is full systems across three layers:

- Connected products
Our connected products for measuring, actuating, device level monitoring, and control adhere to open standards to provide unmatched integration opportunities and flexibility
- Edge Control
We are IIoT-ready with a proven set of tested and validated reference architectures that enable the design of end-to-end open, connected, and interoperable systems based on industry standards. Ethernet and OPC UA facilitates IT/OT convergence meaning machine builders reap benefits from web interfaces and cloud.

- Apps, Analytics & Services
Seamless integration of machines to the IT layer allows the collection and aggregation of data ready for analysis – for machine builders and end users alike this means increased uptime and the ability to find information faster for more efficient operations and maintenance.

These levels are completely integrated from shop floor to top floor. And we have cloud offers and end-to-end cybersecurity wrapped around.

EcoStruxure Machine makes it easier for OEMs/ machine builders to offer their customers smarter machines. The advent of smart machines is driven by the changing needs of end users:

- Evolving workforce
- Reducing costs
- Dynamic markets
- Shorter life cycles
- Prioritizing safety and cybersecurity

EcoStruxure Machine provides one solution for the whole machine life cycle:

- With Smart Design & Engineering the time to market is reduced by up to 30% using our automated engineering and the simulation capabilities
- During Commissioning & Operation of the machine, resources such as energy, material and loss can be improved, and with seamless integration to the IT world efficiency can be improved by up to 40%
- Smart Maintenance & Services reduces the time for corrective actions up to 50%

EcoStruxure™ Machine





Innovation At Every Level



* The Schneider Electric industrial software business and AVEVA have merged to trade as AVEVA Group plc, a UK listed company. The Schneider Electric and Life is On trademarks are owned by Schneider Electric and are being licensed to AVEVA by Schneider Electric.

CANopen for machines

Controllers for industrial machines

Applications		Logic controller			Logic/Motion controller		Motion controller
Type	Specification	For hardwired architectures	For performance-demanding applications		For modular and distributed architectures	IIoT ready for performance machines	For automating machines/lines with 0 - 130 servo or robot axes
							
Performance		0.2 µs/inst	22 ns/inst		22 ns/inst	3...5 ns/inst	0.5...2 ns/inst
Memory		640 KB RAM, 2 MB Flash	64 MB RAM, 128 MB Flash		64 MB RAM, 128 MB Flash	256 MB RAM, 256 MB Flash	128 KB to 256 KB NV RAM 512 MB DDR2 to 1 GB DDR3L
Supply voltage		24 V ~ or 100...240 V ~	24 V ~ or 100...240 V ~		24 V ~	24 V ~	24 V ~
Communication fieldbus and networks	Embedded	<ul style="list-style-type: none"> ■ EtherNet/IP ■ RS 232/RS 485 serial link ■ USB mini-B programming port 	<ul style="list-style-type: none"> ■ Ethernet ■ CANopen (master) and SAE J1939 ■ 2 serial links ■ USB mini-B programming port 		<ul style="list-style-type: none"> ■ EtherNet/IP ■ CANopen (master) and SAE J1939 ■ Serial link ■ USB mini-B programming port 	<ul style="list-style-type: none"> ■ EtherNet/IP ■ Sercos III ■ Modbus TCP ■ Serial link ■ USB mini-B programming port 	<ul style="list-style-type: none"> ■ EtherNet/IP ■ Sercos III ■ CANopen ■ Profibus ■ Profinet ■ EtherCAT
	Optional	<ul style="list-style-type: none"> ■ 1 Serial Line 	<ul style="list-style-type: none"> ■ Ethernet ■ Profibus DP 		<ul style="list-style-type: none"> ■ Ethernet ■ Profibus DP 	<ul style="list-style-type: none"> ■ Ethernet ■ CANopen 	<ul style="list-style-type: none"> ■ CANopen ■ Profibus DP ■ RT-Ethernet
Embedded I/O	Input types	Up to 40 logic inputs Up to 2 analog inputs	Up to 24 logic inputs		–	4 fast digital inputs	Up to 20 digital inputs Up to 16 touch probe inputs Up to 4 interrupt inputs Up to 2 analog inputs
	Output types	Up to 16 relay outputs Up to 16 transistor outputs	Up to 16 transistor outputs		–	4 fast digital outputs	Up to 16 digital outputs Up to 2 analog outputs
Synchronized axes		–	–		–	Up to 16 synchronized axes	Up to 130 synchronized axes
Configuration software		EcoStruxure Machine Expert-Basic (1)	EcoStruxure Machine Expert V1.1 (2)		EcoStruxure Machine Expert V1.1 (2)	EcoStruxure Machine Expert V1.1	EcoStruxure Machine Expert V1.1 (2)
Compatible expansion I/O module ranges (consult the catalog)	Local I/O	<ul style="list-style-type: none"> ● Modicon TM3 (DIA3ED2140109EN) ● Modicon TM3 (DIA3ED2140109EN) ● Modicon TM3 (DIA3ED2140109EN) 	<ul style="list-style-type: none"> ● Modicon TM3 (DIA3ED2140109EN) ● Modicon TM3 (DIA3ED2140109EN) ● Modicon TM3 (DIA3ED2140109EN) ● Modicon TM5 (DIA3ED2131204EN) 		<ul style="list-style-type: none"> ● Modicon TM3 (DIA3ED2140109EN) ● Modicon TM3 (DIA3ED2140109EN) ● Modicon TM3 (DIA3ED2140109EN) ● Modicon TM5 (DIA3ED2131204EN) 	<ul style="list-style-type: none"> ● Modicon TM3 (DIA3ED2140109EN) ● Modicon TM3 (DIA3ED2140109EN) ● Modicon TM3 (DIA3ED2140109EN) ● Modicon TM5 (DIA3ED2131204EN) ● Modicon TM7 (DIA3ED2140405EN) ● Modicon TM5 (DIA3ED2131204EN) 	–
	Remote I/O	–	–		–	<ul style="list-style-type: none"> ● Modicon TM5 (DIA3ED2131204EN) ● Modicon TM7 (DIA3ED2140405EN) 	–
	Distributed I/O on Ethernet	–	–		–	<ul style="list-style-type: none"> ● Modicon TM5 (DIA3ED2131204EN) ● Modicon TM7 (DIA3ED2140405EN) 	<ul style="list-style-type: none"> ● Modicon TM5 (DIA3ED2131204EN) ● Modicon TM7 (DIA3ED2140405EN)
	Distributed I/O on CANopen	–	–		–	<ul style="list-style-type: none"> ● Modicon TM5 (DIA3ED2131204EN) 	<ul style="list-style-type: none"> ● Modicon TM5 (DIA3ED2131204EN)
	Distributed I/O on Sercos	–	–		–	<ul style="list-style-type: none"> ● Modicon TM5 (DIA3ED2131204EN) 	<ul style="list-style-type: none"> ● Modicon TM5 (DIA3ED2131204EN)
Safety I/O	<ul style="list-style-type: none"> ◁ Modicon TM3 (DIA3ED2140109EN) 	<ul style="list-style-type: none"> ◁ Modicon TM3 (DIA3ED2140109EN) 		<ul style="list-style-type: none"> ◁ Modicon TM3 (DIA3ED2140109EN) 	<ul style="list-style-type: none"> ◁ Modicon TM3 (DIA3ED2140109EN) ◁ Modicon TM5 (DIA3ED2131204EN) ◁ Modicon TM7 (DIA3ED2140405EN) 	<ul style="list-style-type: none"> ◁ Modicon TM5 (DIA3ED2131204EN) ◁ Modicon TM7 (DIA3ED2140405EN) 	
Controller range		Modicon M221/M221 Book	Modicon M241		Modicon M251	Modicon M262	LMC Eco, LMC Pro2
More details in catalog		DIA3ED2140106EN	DIA3ED2140107EN		DIA3ED2140108EN	DIA3ED2180503EN	DIA7ED2160303EN

(1) Formerly named SoMachine Basic.

(2) Formerly named SoMachine, EcoStruxure Machine Expert merges both former software ranges, SoMachine and SoMachine Motion.

Machine Automation

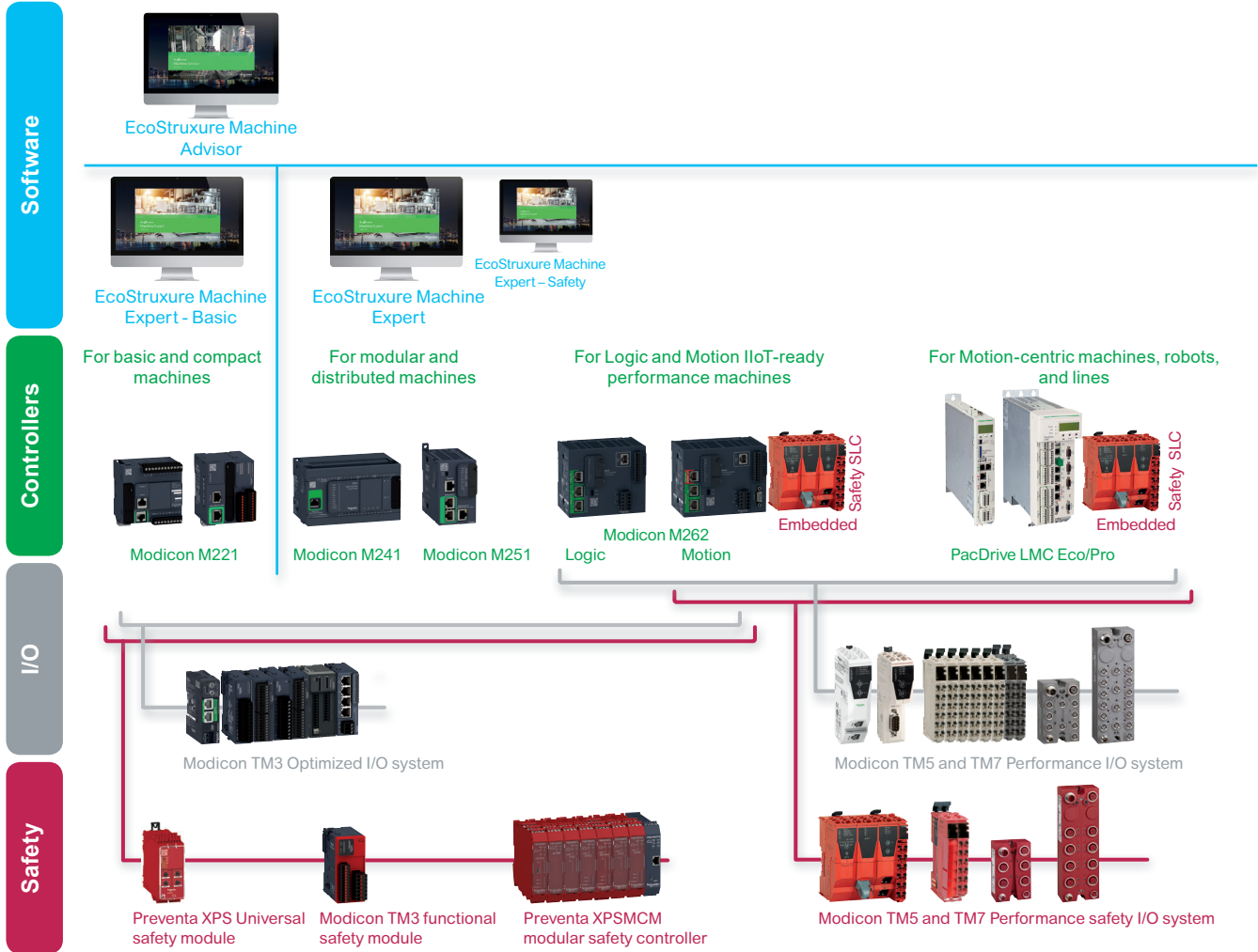

Machine control

The scalability and consistency of I/O ranges allow you to select the right offer depending on your needs

Embedded Safety provides holistic solutions to Modicon M262 and PacDrive LMC controllers, increasing overall safety demand in Machine Automation

All these devices are managed within a single software, EcoStruxure Machine Expert, a powerful and collaborative engineering environment

- > From basic to motion- and robot-centric machines with the PacDrive 3 offer, Modicon controllers and solutions bring a consistent and scalable response to achieving flexibility, performance, productivity, and digitization.
- > Modicon TM3 Optimized I/O system for more compact and modular machines
- > Modicon TM5 for more performance-demanding machines, with Modicon TM7 for harsh environments; Both Performance I/O ranges (Modicon TM5 and TM7) allow safety functions to be implemented using the Modicon TM5CSLC safety logic controller
- > Preventa XPS Universal safety modules cover a wide range of safety functions, suitable for small applications with 4-5 safety functions, with diagnostic information provided to controllers via a single wire connection
- > Modicon TM3 safety functional modules are suitable for small applications covering E-Stop functions and diagnostics via TM3 bus
- > Preventa XPSMCM modular safety controllers are suitable for medium size applications with up to 20 safety functions and diagnostics via Modbus TCP, EtherNet/IP, EtherCAT, or Profinet
- > **EcoStruxure Machine Expert – Safety** optional add-on for programming safety logic controllers
- > **EcoStruxure Machine Expert – Basic** software for programming Modicon M221 logic controllers: an intuitive standalone environment accessible to basic skilled technicians
- > **EcoStruxure Machine Advisor** is a cloud-based services platform designed for machine builders to track machines in operation worldwide, monitor performance data, and resolve exceptional events, while reducing support costs by up to 50%

Machine Automation

Comprehensive Schneider offers for machine builders

- > Lexium servo drives, motors, and robotics are designed to control applications ranging from a single independent axis up to high-performance synchronized multi-axis machines requiring high-speed and precise positioning and movements



[Robotics](#)



[Integrated drives](#)



[Servo Drives & Motors](#)



[Steppers Drives & Motors](#)

- > The Lexium offer is designed for a broad range of motion-centric machines in applications such as [Packaging](#), [Material Handling](#), [Material Working](#), [Food and Beverage](#), and [Electronics](#)
- > Schneider Electric has developed Tested Validated & Documented Architectures (TVDA) applicable for generic machine control applications as well as for dedicated segment applications such as Packaging, Material Handling, Hoisting, Pumping, or generic [Machine Control applications](#)

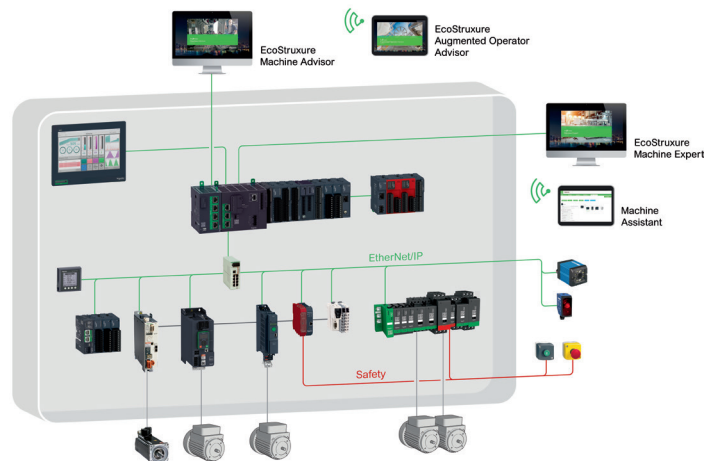

Choose Schneider Electric to help secure your investment and benefit from worldwide services at every step of your project

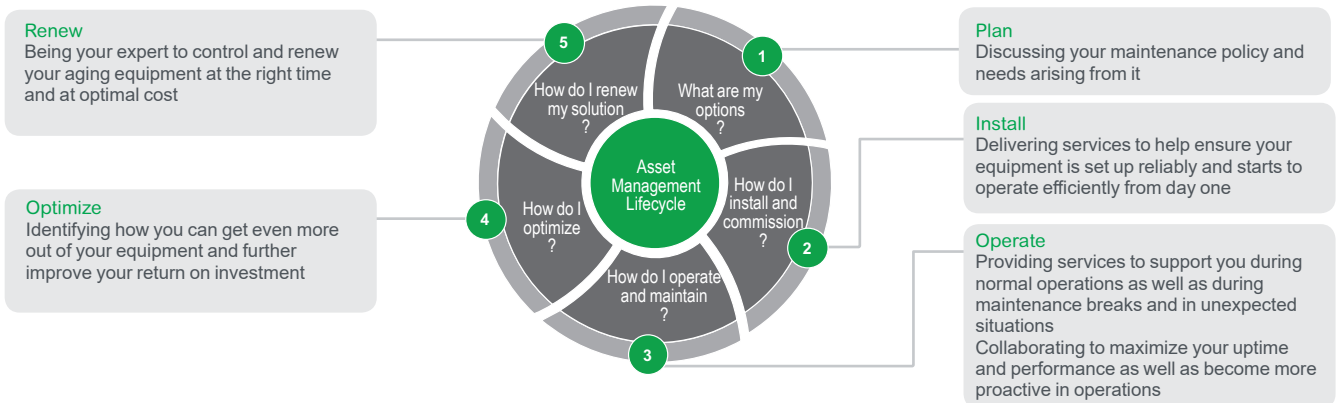

- > From planning and inception to modernization, we help ensure optimal technical and business performance. Our field service engineers combine 30+ years of manufacturer-level experience with the latest technology to bring innovation to every level of our offer, and every step of your project.
- > Our machine control dedicated services empower you to maximize your business infrastructure and face increasingly stringent demands on productivity, safety, equipment availability, and performance optimization.

CANopen for machines

Integrated CANopen bus port on Modicon M241 and Modicon M251 logic controllers

CANopen connection architecture

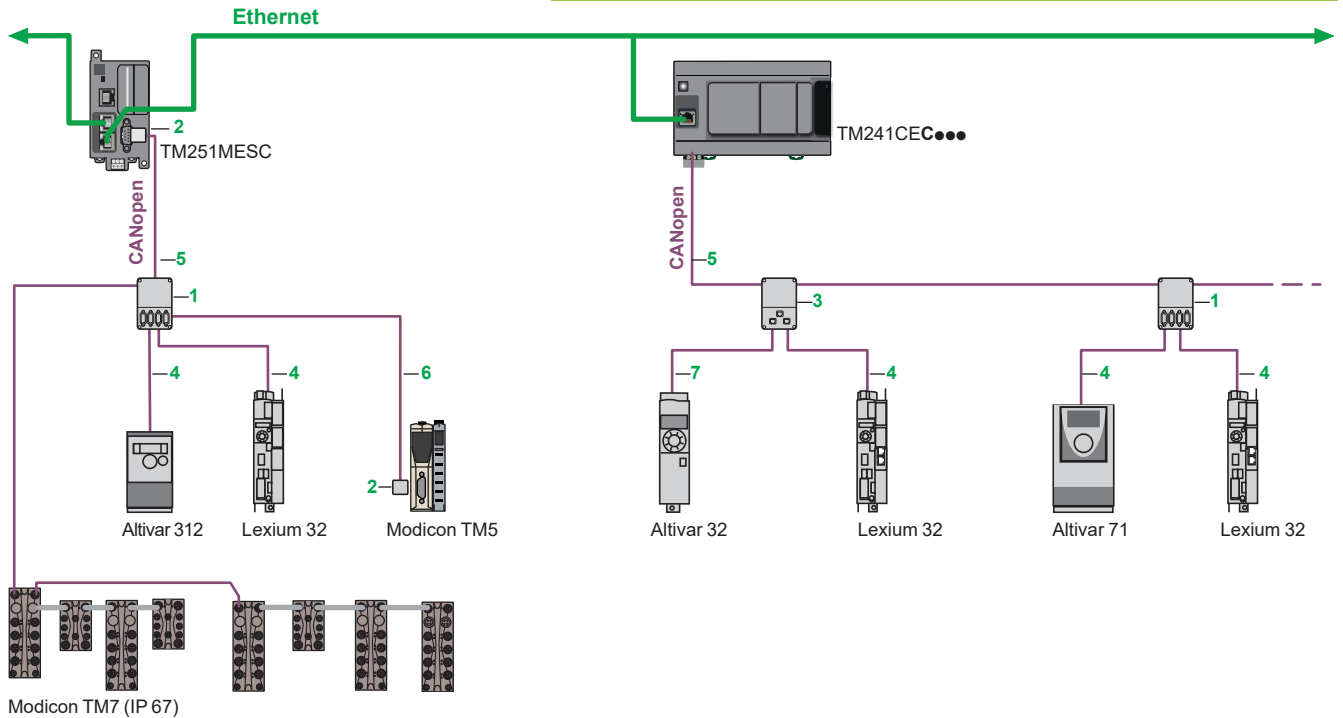

Schneider Electric has selected CANopen for its machines and installations because of its wealth of functions and its resulting benefits in the automation world.

This decision was based on the general acceptance of CANopen, and the fact that CANopen products are increasingly used in control system architectures.

CANopen is an open network supported by more than 400 companies worldwide, and promoted by CAN in Automation (CiA).

CANopen conforms to standards EN 50325-4 and ISO 15745-2.

Schneider Electric is heavily involved in working groups, which are important for machine and installation architectures, systems and products.

- The bus uses a double shielded twisted pair on which, with Modicon M241 and Modicon M251 logic controllers, a maximum of 63 devices are connected by daisy-chaining or by tap junctions.
- Each end of the bus must be fitted with a line terminator. On M241 controllers, this line terminator is already integrated on the master side and can be disconnected using a switch located next to the CAN connector.

CANopen port on M241 and M251 controllers

Type	M241: screw terminals M251: 9-way SUB-D							
Standards	DS 301 V4.02, DR 303-1							
Class	M10							
Data rate								
Max. length (m / ft.)	20/ 65.62	40/ 131.23	100/ 328.08	250/ 820.21	500/ 1640.42	1000/ 3280.84	2500/ 8202.1	5000/ 16404.2
Data rate (Kbps)	1000	800	500	250	125	50	20	10
Number of slaves	63 slaves max. with limit of: 252 RPDOs and 252 TPDOs							



TM241CEC controllers



TM251MESC controller



[DIA3ED2140107EN](#)



[DIA3ED2140108EN](#)

Description

CANopen port on M241 and M251 controllers

- The underside of Modicon **TM241CEC** logic controllers has:
- 1 a connector for linking to the CANopen bus (screw terminals).
 - 2 a CANopen line termination switch.

- The front of the Modicon **TM251MESC** logic controller has:
- 3 a connector for linking to the CANopen bus (9-way SUB-D).

CANopen for machines

Integrated CANopen bus port on Modicon M241 and Modicon M251 logic controllers

References

CANopen standard taps and connectors

Designation	Description	Item	Lgth. mm / ft	Unit reference	Weight kg / lb
IP20 CANopen tap junction	Line termination : 4 SUB-D ports. Screw terminals for connecting the trunk cables	1	–	TSXCANTDM4	0.196 / 0.432
IP 20 CANopen connectors 9-way female SUB-D Line end adapter switch	Right-angle	2	–	TSXCANKCDF90T	0.046 / 0.101
	Straight (for connection to the Altivar IMC integrated controller card)	2	–	TSXCANKCDF180T	0.049 / 0.108
	Right-angle with 9-way SUB-D for connecting a PC or diagnostic tool	2	–	TSXCANKCDF90TP	0.051 / 0.112
IP 20 CANopen tap junction for Altivar and Lexium 32	2 RJ45 ports	3	–	VW3CANTAP2	0.250 / 0.551
Daisy chain taps	Equipped with: □ 2 sets of spring terminals for daisy chain connection of the CANopen bus □ 1 preassembled cordset with RJ45 connector for connecting the drive	–	0.6 / 1.97	TCSCNTN026M16M	–
	Equipped with: □ 2 RJ45 connectors for daisy chain connection of the CANopen bus □ 1 preassembled cordset with RJ45 connector for connecting the drive	–	0.3 / 0.98	TCSCNTN023F13M03	–
CANopen line terminators	For RJ45 connector <i>Sold in lots of 2</i>	–	–	TCSCAR013M120	–
	For screw terminal connector <i>Sold in lots of 2</i>	–	–	TCSCAR01NM120	–



TSXCANTDM4

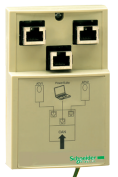

VW3CANTAP2



TSXCAN KCD F90T



TSXCAN KCD F180T



TSXCAN KCD F90TP



TCSCAR013M120



VW3CANA71

IP 20 standard cables and preassembled cordsets

Designation	Description	Item	Length	Unit reference	Weight kg / lb	
CANopen cables (2 x AWG 22 2 x AWG 24)	For standard environment (1), CE marking: Low smoke. Zero halogen. Non flame propagating (IEC 60332-1)	5	50 / 164.042	TSXCANCA50	4.930 / 10.869	
			100 / 328.08	TSXCANCA100	8.800 / 19.401	
			300 / 984.25	TSXCANCA300	24.560 / 54.146	
	For standard environment (1), UL certification, CE marking: Flame-retardant (IEC 60332-2)	5	50 / 164.04	TSXCANCB50	3.580 / 7.893	
			100 / 328.08	TSXCANCB100	7.840 / 17.284	
			300 / 984.25	TSXCANCB300	21.870 / 48.215	
	For harsh environment (1) or mobile installation, CE marking: Low smoke. Zero halogen. Non flame propagating (IEC 60332-1). Oil-resistant	5	50 / 164.04	TSXCANCD50	3.510 / 7.738	
			100 / 328.08	TSXCANCD100	7.770 / 17.130	
			300 / 984.25	TSXCANCD300	21.700 / 47.840	
CANopen preassembled cordsets	Cordsets with one 9-way female SUB-D connector at each end	For standard environment (1), CE marking: Low smoke. Zero halogen. Non flame propagating (IEC 60332-1)	6	0.3 / 0.98	TSXCANCADD03	0.091 / 0.201
				1 / 3.28	TSXCANCADD1	0.143 / 0.315
		For standard environment (1), UL certification, CE marking: Flame-retardant (IEC 60332-2)	6	0.3 / 0.98	TSXCANCBDD03	0.086 / 0.190
				1 / 3.28	TSXCANCBDD1	0.131 / 0.289
				3 / 9.84	TSXCANCBDD3	0.268 / 0.591
	Cordsets with one 9-way female SUB-D connector and one RJ45 connector		5 / 16.40	TSXCANCBDD5	0.400 / 0.882	
		4	0.5 / 1.64	TCSCCN4F3M05T	0.100 / 0.220	
			1 / 3.28	TCSCCN4F3M1T	0.100 / 0.220	
			3 / 9.843	VW3M3805R010 (2)	0.100 / 0.220	
			1 / 3.281	VW3M3805R030 (2)	0.300 / 0.661	
	Cordsets with two 9-way SUB-D connectors, one male and one female		3 / 9.84	TCSCCN4F3M3T	0.160 / 0.353	
		–	0.5 / 1.64	TLACDCBA005	0.100 / 0.220	
			1.5 / 4.92	TLACDCBA015	0.120 / 0.265	
			3 / 9.84	TLACDCBA030	0.190 / 0.419	
			5 / 16.40	TLACDCBA050	0.350 / 0.772	
Preassembled cordsets with one RJ 45 connector at each end	7	0.3 / 0.984	VW3CANCARR03	0.100 / 0.220		
		1 / 3.281	VW3CANCARR1	0.100 / 0.220		
Adapter for Altivar 71 speed drive	One RJ45 connector at each end	–	–	VW3CANA71	0.100 / 0.220	

Taps and IP 67 accessories

Please consult Modicon TM7 Performant and safe IP67 distributed I/O system [Please consult catalog ref DIA3ED2140405EN](#)

(1) Standard environment: no particular environmental constraints, operating temperature between + 5°C and + 60°C (+ 41°F and + 140°F), and in fixed installations.

Harsh environment: resistance to hydrocarbons, industrial oils, detergents, solder splashes, relative humidity up to 100%, saline atmosphere, significant temperature variations, operating temperature between - 10°C and + 70°C (+ 14°F and + 158°F), or in mobile installations.

(2) Cordset equipped with a line terminator.

CANopen for machines

Integrated CANopen bus port on Altivar IMC drive controller for ATV 61/71 variable speed drives

Tested Validated and Documented Architecture

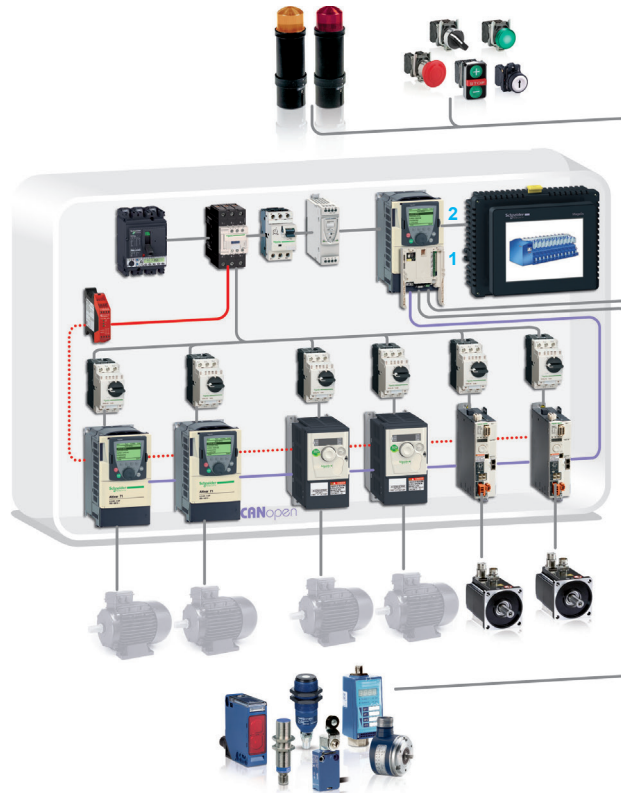

- 1 Altivar IMC card
- 2 Altivar 61/71 variable speed drive

Altivar IMC drive controller card CANopen port

The Altivar IMC drive controller card acts as the CANopen master. The bus consists of a master station, the Altivar IMC card, and slave stations. The master is in charge of configuration, exchanges and diagnostics to the slaves. The CANopen configurator is integrated in the SoMachine software and can also be used to import standard description files in EDS format.

The CANopen bus is used to manage a variety of slaves such as:

- Discrete slaves
- Analog slaves
- Variable speed drives
- Motor starters
- Etc.



CANopen machine bus port:
9-way male SUB-D
connector

CANopen port

Standards	DS 301 V4.02, DR 303-1						
Class	Conformity class M20, limited to 16 slaves						
Data rate	max. Length (m / ft.)	20/ 65.62	100/ 328.08	250/ 820.21	500/ 1640.42	1000/ 3280.84	2500/ 8202.1
	Data rate (kbps)	1000	500	250	125	50	20
Number of slaves	16 max. with max. limit of: 32 RPDOs and 32 TPDOs						
Connection	On 9-way male SUB-D port						

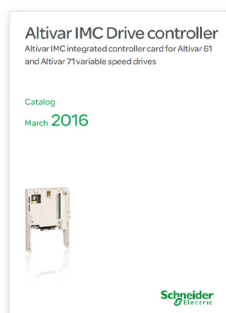

[DIA3ED2160103EN](#)

Tested Validated and Documented Architecture

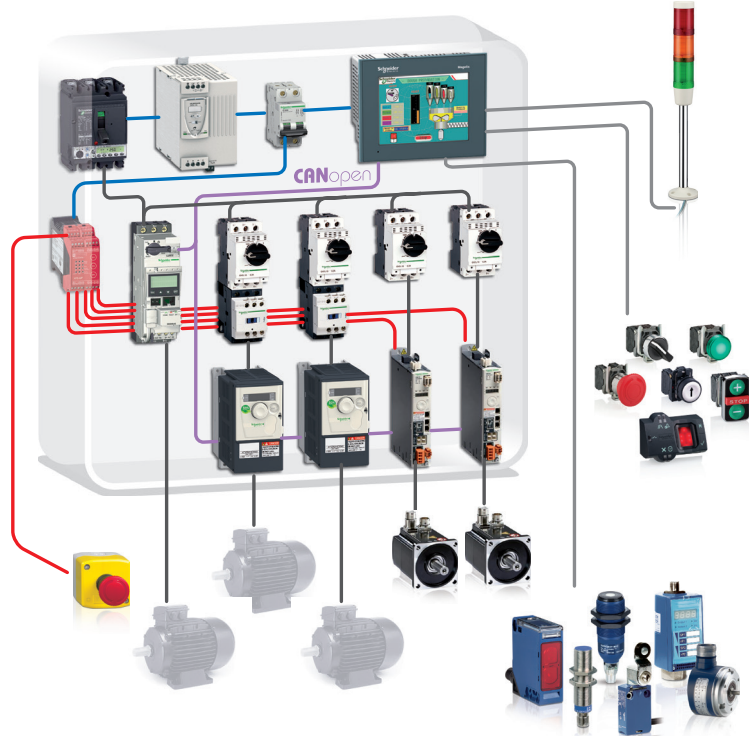

Magelis XBTGC controller
+ XBTZGCCAN CANopen bus
master module



CANopen machine bus port: 9-way male
SUB-D connector

XBTZGCCAN

Presentation

The **XBTZGCCAN** module provides the control function on Canopen bus to Magelis XBTGC (1) controllers and is configured with the SoMachine software (2).

The various services available are:

- One or more profiles are supplied for Schneider Electric slaves (ATV 312 variable speed drives, Lexium 32 servo drives). This makes it possible to configure the slave according to a predefined mode. Profiles provide a defined operating mode so that there is no need for users to configure the mode.
- For third-party slaves
 - The user can choose from a list which can be modified. This simply involves importing an EDS (Electronic Data Sheet) description file
 - The slave can be positioned on the bus: the slave number, speed, monitoring, etc. can be defined
 - The user can select variables from the list of variables managed by the slave
 - A link between variables and the data exchanged
 - Symbolization of data exchanged

Reference

Description	Reference	Weight kg / lb
CANopen bus master module for Magelis XBTGC controller Conformity class M10	XBTZGCCAN	0.100 0.220

(1) Magelis XBTGC offer, please consult catalog ref. [DIA5ED2130615EN](#)

(2) SoMachine configuration software, please consult catalog ref. [DIA3ED2140110EN](#)

CANopen Optimized architecture

Connection example of "Distributed CANopen Optimized" dedicated to modular machines and installations

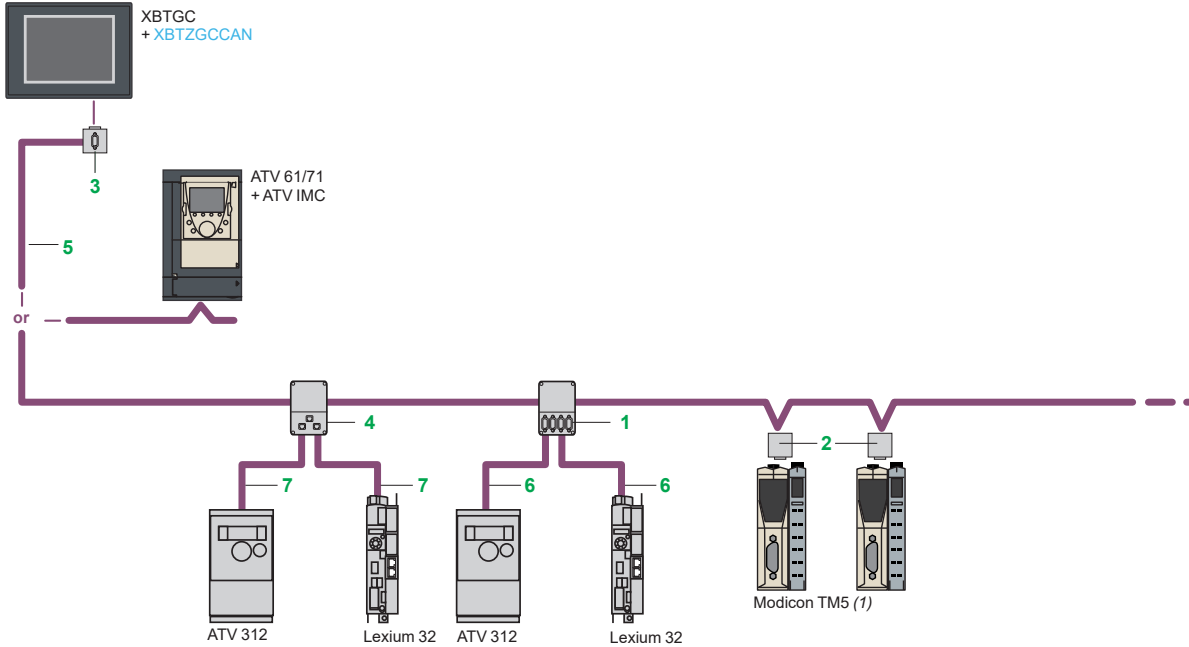

References



TSXCANTDM4

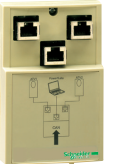

VW3CANTAP2



TSXCANKCD
F90T



TSXCANKCD
F180T



TSXCANKCD
F90TP



TCSCAR013M120

Standard junction boxes and connectors

Description	Composition	Item	Length m / ft	Unit reference	Weight kg lb
CANopen IP 20 tap junction box	4 SUB-D ports. Screw terminal blocks for connection of main cables Line end adapter	1	-	TSXCANTDM4	0.196/ 0.432
IP 20 connectors CANopen 9-way SUB-D female. Line end adapter switch	Elbowed (90°)	2	-	TSXCANKCDF90T	0.046/ 0.101
	Straight (For connection to an drive controller card Altivar IMC)	-	-	TSXCANKCDF180T	0.049/ 0.108
	Elbowed (90°) with 9-way SUB-D connector for connection to PC or diagnostic tool	3	-	TSXCANKCDF90TP	0.051/ 0.112
M12 connectors IP 67	Male	-	-	FTXCN12M5	0.050/ 0.110
	Female	-	-	FTXCN12F5	0.050/ 0.110
CANopen IP 20 tap junction box for Altivar and Lexium 05	2 x RJ45 ports	4	-	VW3CANTAP2	0.250/ 0.551
Daisy chain taps	Equipped with: - 2 spring terminal blocks for connecting the CANopen bus in a daisy chain - 1 preassembled cordset with an RJ45 connector for connecting the drive	-	0.6 / 1.969	TCSCNT026M16M	-
	Equipped with: - 2 RJ45 connectors for connecting the CANopen bus in a daisy chain - 1 preassembled cordset with an RJ45 connector for connecting the drive	-	0.3 / 0.984	TCSCNT023F13M03	-
CANopen line terminators	For RJ45 connector Sold in packs of 2	-	-	TCSCAR013M120	-
	For screw terminal connector Sold in packs of 2	-	-	TCSCAR01NM120	-

(1) Modicon TM5 offer, please consult catalog ref. [DIA3ED2131204EN](#)

CANopen for machines

Integrated CANopen bus port on Altivar IMC drive controller, Magelis XBTGC controllers

References (continued)

Standard IP 20 formed cables						
Description	Application	Item	Length m / ft	Unit reference	Weight kg / lb	
CANopen cables (2 x AWG 22 2 x AWG 24)	For standard environments (2), CE marking: low fume emission. Halogen-free. Non flame propagating (IEC 60332-1)	5	50 / 164.042	TSXCANCA50	4.930/ 10.869	
			100 / 328.08	TSXCANCA100	8.800/ 19.401	
			300 / 984.25	TSXCANCA300	24.560/ 54.146	
	For standard environments (2), UL certified, CE marking: non flame propagating (IEC 60332-2)	5	50 / 164.04	TSXCANCB50	3.580/ 7.893	
			100 / 328.08	TSXCANCB100	7.840/ 17.284	
			300 / 984.25	TSXCANCB300	21.870/ 48.215	
	For standard environments (2) or mobile installation, CE marking: low fume emission. Halogen-free. Non flame propagating (IEC 60332-1). Oil resistant	5	50 / 164.04	TSXCANCD50	3.510/ 7.738	
			100 / 328.08	TSXCANCD100	7.770/ 17.130	
			300 / 984.25	TSXCANCD300	21.700/ 47.840	
CANopen formed cables 1 x 9-way SUB-D female connector at each end.	For standard environments (2), CE marking: low fume emission. Halogen-free. Non flame propagating (IEC 60332-1)	-	0.3 / 0.98	TSXCANCADD03	0.091/ 0.201	
			1 / 3.28	TSXCANCADD1	0.143/ 0.315	
			3 / 9.84	TSXCANCADD3	0.295/ 0.650	
			5 / 16.40	TSXCANCADD5	0.440/ 0.970	
	For standard environments (2), UL certified, CE marking: non flame propagating (IEC 60332-2)	-	0.3 / 0.98	TSXCANCBDD03	0.086/ 0.190	
			1 / 3.28	TSXCANCBDD1	0.131/ 0.289	
			3 / 9.84	TSXCANCBDD3	0.268/ 0.591	
			5 / 16.40	TSXCANCBDD5	0.400/ 0.882	
	CANopen formed cables	Formed cables with 1 x 9-way SUB-D female connector and 1 x RJ45 connector	6	0.5 / 1.64	TCSCCN4F3M05T	0.100/ 0.220
				1 / 3.28	TCSCCN4F3M1T	0.100/ 0.220
				3 / 9.843	VW3M3805R010(2)	0.100/ 0.220
		Formed cables with 2 x 9-way SUB-D connectors, 1 female and 1 male		1 / 3.281	VW3M3805R030(2)	0.300/ 0.661
			3 / 9.84	TCSCCN4F3M3T	0.160/ 0.353	
			0.5 / 1.64	TLACDCBA005	0.100/ 0.220	
	1.5 / 4.92	TLACDCBA015	0.120/ 0.265			
	3 / 9.84	TLACDCBA030	0.190/ 0.419			
	5 / 16.40	TLACDCBA050	0.350/ 0.772			
IP 20 connection accessories						
CANopen connector for Altivar 71 (3)	9-way SUB-D female. Line end adapter switch. 180° cable entry	-	-	VW3CANKCDF180T	0.100/ 0.220	
Adapter for Altivar 71 variable speed controller	CANopen SUB-D to RJ45 adapter	-	-	VW3CANA71	0.100/ 0.220	
Formed CANopen cables	1 RJ45 connector at each end.	7	0.3 / 0.984	VW3CANCARR03	0.100/ 0.220	
			1 / 3.281	VW3CANCARR1	0.100/ 0.220	
CANopen bus adapter for Lexium 17D	Hardware interface for link conforming to the CANopen standard + 1 connector for connection of PC terminal	-	-	AM02CA001V000	0.110/ 0.243	
Y connector	CANopen/Modbus	-	-	TCSCCTN011M11F	0.100/ 0.220	



VW3CANA71



AM02CA001V000



FTXDP21●●

(1) Standard environment: without any particular environmental restrictions, operating temperature between + 5 °C and + 60 °C, (+ 41 °F and + 140 °F) and for fixed installation. Harsh environments: resistant to hydrocarbons, industrial oils, detergents, solder splashes, hygrometry up to 100%, saline environment, wide temperature variations, operating temperature between - 10 °C and + 70 °C (+ 14 °F and +158 °F), or mobile installation.

(2) Cable equipped with line end adapter.

(3) For variable speed controllers ATV71H●●●M3, ATV71HD11M3X, HD15M3X, ATV71H075N4... HD18N4, this connector can be replaced by connector TSXCAN KCDF180T.

CANopen for machines

Integrated CANopen bus port on Modicon M258 logic controllers

Tested Validated Documented Architectures

Modicon M258 logic controllers



CANopen port on M258 logic controllers

Modicon M258 logic controllers (referenced **TM258 LF●●●●**) include a 9-way male SUB-D CANopen port and act as the CANopen master.

The bus consists of a master station, M258 logic controller and slave stations. The master is in charge of configuration, exchanges and diagnostics to the slaves. The CANopen bus is a communication bus and is used to manage a variety of slaves, such as:

- Digital slaves
- Analog slaves
- Variable speed drives
- Motor starters
- Etc.



CANopen bus link connector

M258 logic controllers type **TM258 LF●●●●**

CANopen port

Standards	DS 301 V4.02, DR 303-1								
Class	Conformity class M10, limited to 63 slaves								
Data rate	Max. length (m/ ft)	20/ 65.62	40/ 131.23	100/ 328.08	250/ 820.21	500/ 1640.42	1000/ 3280.84	2500/ 8202.1	5000/ 16404.2
	Data rate (kbps)	1000	800	500	250	125	50	20	10
Number of slaves	63 max. with max. limit of: 64 TDPOs/64 RPDOs								
Connection	On 9-way male SUB-D port								



[DIA6ED2100402EN](#)

CANopen for machines

Integrated CANopen/CANmotion bus ports on Modicon LMC058 motion controllers

Tested Validated Documented Architectures

Modicon LMC058 motion controllers

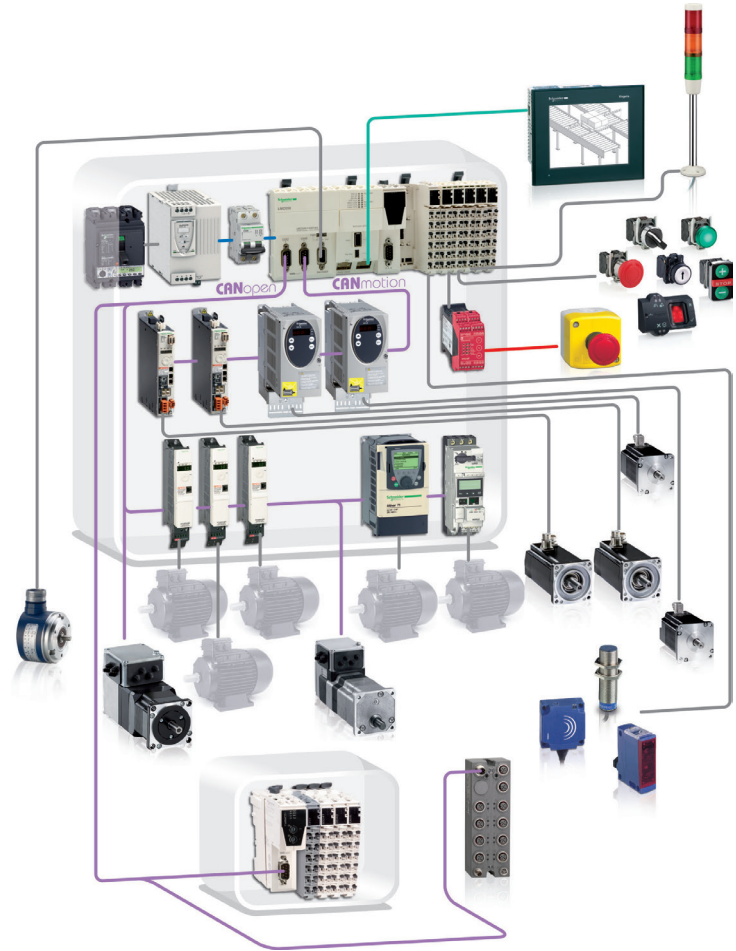

CANopen port on LMC058 motion controllers

Modicon LMC058 motion controllers include a 9-way male SUB-D CANopen port and act as the CANopen master.

The bus consists of a master station, LMC058 motion controller and slave stations. The master is in charge of configuration, exchanges and diagnostics to the slaves. The CANopen bus is a communication bus and is used to manage a variety of slaves, such as:

- Digital slaves
- Analog slaves
- Variable speed drives
- Motor starters
- Etc.

CANopen port

Standards	DS 301 V4.02, DR 303-1							
Class	Conformity class M10, limited to 63 slaves							
Data rate Max. length (m/ft)	20/ 65.62	40/ 131.23	100/ 328.08	250/ 820.21	500/ 1640.42	1000/ 3280.84	2500/ 8202.1	5000/ 16404.2
	Data rate (kbps)	1000	800	500	250	125	50	20
Number of slaves	63 max. with max. limit of: 64 TDPOs/64 RPDOs							
Connection	On 9-way male SUB-D port							

CANmotion port on LMC058 motion controllers

LMC058 motion controllers include a 9-way male SUB-D CANmotion port and act as the CANmotion master.

This CANmotion connection offers the option of configuring and controlling up to 8 Lexium 32 servo drives and/or Lexium SD3 stepper drives.

The CANmotion bus cycle time ensures that the axis positions will be refreshed.



9-way male SUB-D CANopen connector, marked CAN0, for connecting to CANopen bus
9-way male SUB-D CANopen connector, marked CAN1, for connecting to CANmotion bus

LMC058 motion controllers



DIA7ED2100803EN

CANopen for machines

Integrated CANopen bus port on Modicon M258 logic controllers and Modicon LMC058 motion controller

CANopen Performance architecture

Example of connection of a CANopen Performance architecture dedicated to machines and modular installations.

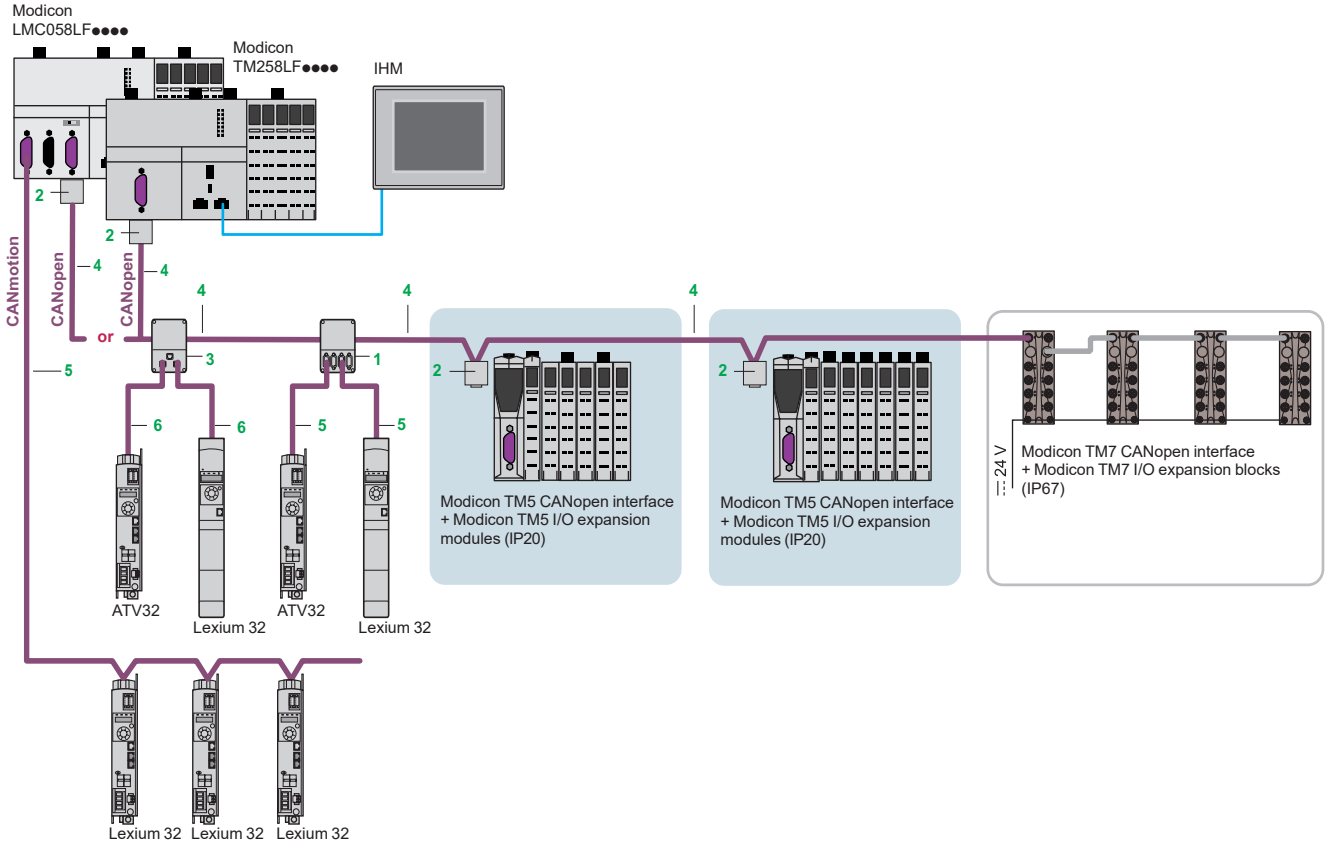

References

Standard tap junctions and connectors

Designation	Description	Item no.	Length	Reference	Weight kg / lb
IP 20 CANopen tap junction	4 SUB-D ports. Screw terminal block for connecting the trunk cables Line termination	1	–	TSXCANTDM4	0.196 / 0.432
IP 20 connectors CANopen 9-way female SUB-D. Switch for line termination	90° angled	2	–	TSXCANKCDF90T	0.046 / 0.101
	Straight (For connection to Altivar IMC drive controller card)	–	–	TSXCANKCDF180T	0.049 / 0.108
	90° angled with 9-way SUB-D for connecting a PC or diagnostic tool	–	–	TSXCANKCDF90TP	0.051 / 0.112
IP 20 CANopen tap junction for Altivar and Lexium	2 RJ45 ports	3	–	VW3CANTAP2	0.250 / 0.551



TSXCANTDM4

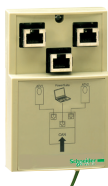

VW3CANTAP2



TSXCANKCDF90T



TSXCANKCDF180T



TSXCANKCDF90TP

CANopen for machines

Integrated CANopen bus port on Modicon M258 logic controllers and Modicon LMC058 motion controller

References (continued)							
IP 20 standard cables and preassembled cordsets							
Designation	Description	Item no.	Length m/ ft	Reference	Weight kg/ lb		
CANopen cables (2 x AWG 22 2 x AWG 24)	For standard environment (1), CE marking: low smoke. Zero halogen. Flame-retardant (IEC 60332-1)	4	50/ 164.042	TSXCANCA50	4.930/10.869		
			100/ 328.08	TSXCANCA100	8.800/19.401		
			300/ 984.25	TSXCANCA300	24.560/54.146		
	For standard environment (1), UL certification, CE marking: flame-retardant (IEC 60332-2)	4	50/ 164.042	TSXCANCB50	3.580/7.893		
			100/ 328.08	TSXCANCB100	7.840/17.284		
			300/ 984.25	TSXCANCB300	21.870/48.215		
	For harsh environments (1) or mobile installations, CE marking: low smoke. Zero halogen. Flame-retardant (IEC 60332-1). Oil-resistant	4	50/ 164.04	TSXCANCD50	3.510 / 7.738		
			100/ 328.08	TSXCANCD100	7.770 / 17.130		
			300/ 984.25	TSXCANCD300	21.700 / 47.840		
CANopen preassembled cordsets One 9-way female SUB-D connector at each end.	For standard environment (1), CE marking: low smoke. Zero halogen. Flame-retardant (IEC 60332-1)	-	0.3/ 0.98	TSXCANCADD03	0.091/0.201		
			1/ 3.28	TSXCANCADD1	0.143/0.315		
			3/ 9.84	TSXCANCADD3	0.295/0.650		
	For standard environment (1), UL certification, CE marking: flame-retardant (IEC 60332-2)	-	0.3/ 0.98	TSXCANCBDD03	0.086/0.190		
			1/ 3.28	TSXCANCBDD1	0.131/0.289		
			3/ 9.84	TSXCANCBDD3	0.268/0.591		
	For standard environment (1), UL certification, CE marking: flame-retardant (IEC 60332-2)	-	0.3/ 0.98	TSXCANCBDD03	0.086/0.190		
			1/ 3.28	TSXCANCBDD1	0.131/0.289		
			3/ 9.84	TSXCANCBDD3	0.268/0.591		
CANopen preassembled cordsets	Cordsets with one 9-way female SUB-D connector and one RJ45 connector	5	0.5/1.64	TCSCCN4F3M05T	0.100/0.220		
			1/ 3.28	TCSCCN4F3M1T	0.100/0.220		
			3/ 9.843	VW3M3805R010 (2)	0.100/0.220		
			3/ 9.843	TCSCCN4F3M3T	0.160/0.353		
	Cordsets with two 9-way SUB-D connectors, one female and one male	-	0.5/ 1.64	TLACDCBA005	0.100/0.220		
			1.5/ 4.92	TLACDCBA015	0.120/0.265		
			3/ 9.84	TLACDCBA030	0.190/0.419		
			5/ 16.40	TLACDCBA050	0.350/0.772		
IP 20 connection accessories							
CANopen connector for Altivar 71 (3)	9-way female SUB-D Switch for line termination. Cables exit at 180°	-	-	VW3CANKCDF180T	0.100/0.220		
Adaptor for Altivar 71 drive	SUB-D to RJ45 CANopen adaptor	-	-	VW3CANA71	0.100/0.220		
CANopen preassembled cordsets	1 RJ45 connector at each end	6	0.3/ 0.984	VW3CANCARR03	0.100/0.220		
			1/ 3.281	VW3CANCARR1	0.100/0.220		
CANopen bus adaptor for Lexium 17D	Hardware interface for CANopen- compliant link + 1 connector for a PC terminal	-	-	AM02CA001V000	0.110/0.243		
Y-connector	CANopen/Modbus	-	-	TCSCTN011M11F	0.100/0.220		



VW3 CAN A71



AM02 CA 001 V000

IP 67 cables and preassembled cordsets, IP 67 connection accessories for Modicon TM7 blocks

Please consult [Modicon TM7 IP 67 modular I/O system](#) catalog (DIA3ED2140405EN) or on our web site www.schneider-electric.com

(1) Standard environment: no particular environmental constraints, operating temperature between + 5°C and + 60°C, and in fixed installations

Harsh environment: resistance to hydrocarbons, industrial oils, detergents, solder splashes, relative humidity up to 100%, saline atmosphere, significant temperature variations, operating temperature between - 10°C and + 70°C, or in mobile installations.

(2) Cordset equipped with a line terminator.

(3) For ATV 71H●●M3, ATV 71HD11M3X, HD15M3X, ATV 71H075N4... HD18N4 drives, this connector can be replaced by the TSX CAN KCDF 180T connector.

CANopen for machines

Modicon TM5, High-Performance and Safe IP20

Modular I/O System

Interface module for distributed I/O on CANopen bus

CANopen bus



The CANopen fieldbus is specially designed to be integrated into control systems. It provides openness and interoperability for various devices (drives, motor starters, smart sensors, etc.).

Having CANopen connectivity at several levels can help to reduce costs and optimize creation of the control system.

It offers the following advantages:

- Quicker wiring time
- More reliable load
- Flexibility when adding or removing devices, as well as easier installation

Distributed I/O on CANopen bus

The TM5 interface module is designed for creating distributed I/O islands (IP20 and IP67) on the CANopen bus. It is compatible with Modicon M258 logic controllers, Modicon LMC058 and Modicon LMC078 motion controllers, and the Modicon M262 logic/motion controller (equipped with its **TM5NCO1** communication module for CANopen bus).

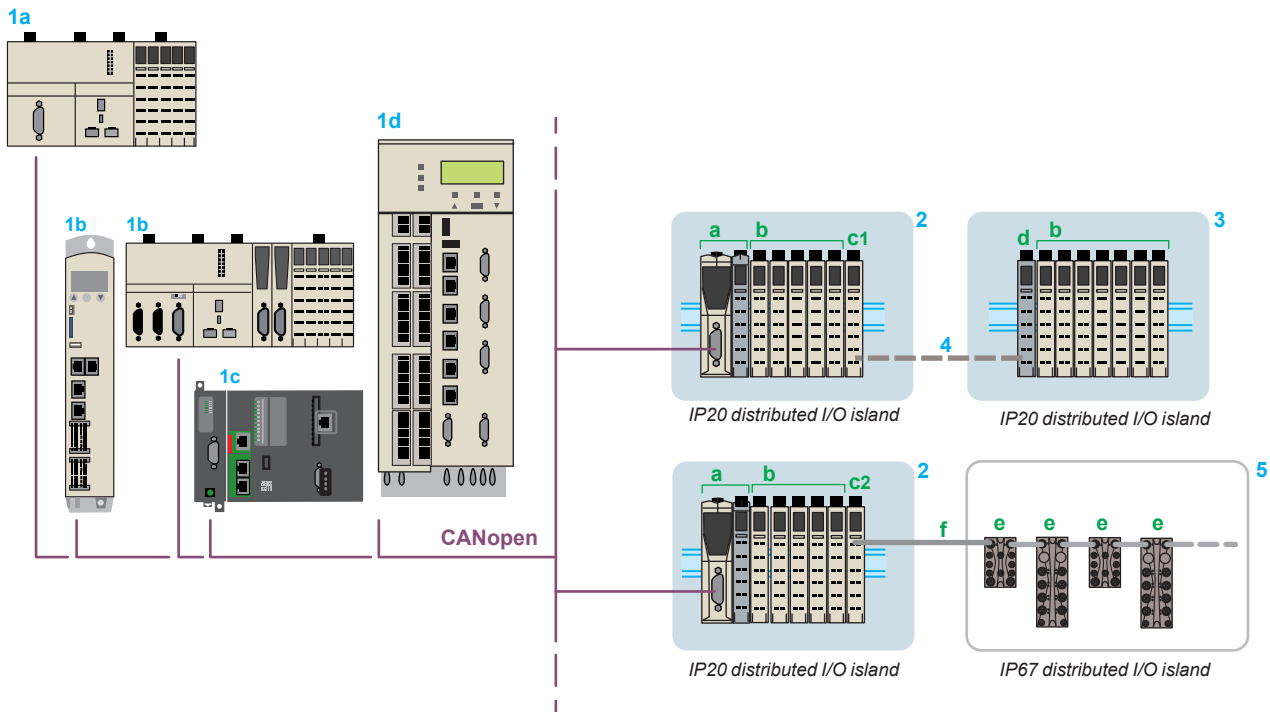

- 1 a M258 logic controller b Modicon LMC058 or Modicon LMC078 motion controller c **TM5NCO1** communication module and Modicon M262 logic/motion controller d PacDrive LMC Eco/Pro/Pro2 motion controllers: CANopen bus masters
- 2 TM5 CANopen interface module (slave) (a) + TM5 modules (b) + TM5SBET1 (c1)/TM5SBET7 (c2) transmitter modules
- 3 TM5SBER2 receiver module (d) + TM5 I/O modules (b)
- 4 TM5 expansion bus: TCSXCNNXN100 remote I/O connection cable
- 5 Modicon TM7 blocks (1) (digital or analog I/O) (e) + TM7TCSXC�E bus expansion cable (f)

(1) Modicon TM7, please refer to catalog ref. [DIA3ED2140405EN](#)

CANopen for machines

Modicon TM5, High-Performance and Safe IP20
Modular I/O System

Interface module for distributed I/O on CANopen bus

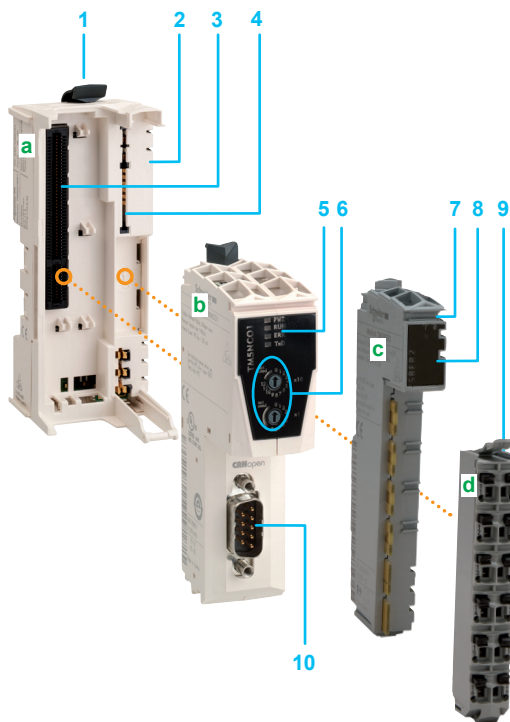

TM5NCO1

TM5SPS3



TM5ACBN1

TM5ACTB12PS



TM5NCO1K

Description

The TM5 CANopen interface module comprises four parts to be ordered separately:

- a **TM5ACBN1** bus base (a)
- a **TM5NCO1** CANopen electronic interface module (b)
- a **TM5SPS3** power distribution electronic module (c)
- a **TM5ACTB12PS** removable terminal block (d)

The CANopen interface module can also be ordered as a complete kit comprising all these parts.

These modules can be mechanically assembled on the bus base before mounting on a symmetrical rail.

They offer the following advantages:

- Removable connector
- Spring terminals that can be used for quick, tool-free connection of the power supply for the interface module and the I/O expansion modules (the quality of the spring terminals avoids the need for periodic retightening)

This assembly comprises:

- 1 A mechanical clip for locking onto a symmetrical rail
- 2 A bus expansion connection on the side of the base to provide the link with the adjacent module
- 3 A slot for the CANopen interface module with connector
- 4 A slot for the power distribution module with connector
- 5 An LED display block for the interface module channels and diagnostics
- 6 Two rotary switches for address selection on the bus
- 7 A slot for the plain text cover holder (label holder)
- 8 An LED display block for the power distribution module channels and diagnostics
- 9 A removable spring terminal block with locking clip and slots for colored ID markers
- 10 A 9-way male SUB-D connector for the CANopen bus connection

References

Description	Characteristics	Reference	Weight kg/lb
CANopen bus interface module	With CANopen protocol	TM5NCO1	0.050/ 0.110
Power distribution electronic module	Input power supply: 24 V \pm for CANopen bus, interface, and I/O expansion modules	TM5SPS3 (1)	0.025/ 0.055
Bus base	For TM5NCO1 and TM5SPS3 electronic modules Supplied with 2 protective plates, TM5ACPL10 and TM5ACPR10	TM5ACBN1	0.020/ 0.044
Terminal block	12 spring terminals For TM5SPS3 power distribution electronic module	TM5ACTB12PS	0.016/ 0.035

CANopen interface kit

Description	Composition	Reference	Weight kg/lb
Kit comprising:	TM5NCO1 + TM5SPS3 + TM5ACBN1 + TM5ACTB12PS	TM5NCO1K	0.120/ 0.264
- a CANopen interface module			
- a bus base			
- a power distribution electronic module			
- a terminal block			

(1) Supplied with 2 protective plates, TM5ACPL10 and TM5ACPR10

CANopen for machines

Modicon TM7, High-Performance and Safe IP67

Distributed I/O System

CANopen interface blocks

Applications	
Compatibility	Local and remote I/O
	Distributed I/O

CANopen bus interface with digital I/O
- Modicon M258 logic controller - Modicon LMC058 motion controller
- Modicon M258 logic controller - Modicon LMC058 motion controller - Modicon LMC078 motion controller - Modicon M262 logic/motion controller - PacDrive LMC Eco/Pro/Pro2 motion controllers



Degree of protection	IP67	
Housing type	Plastic	
Modularity (number of channels)	Max. number of digital channels	
	Digital inputs	
	Digital outputs	
Digital inputs	Voltage/Current	24 V \pm /4.4 mA
	Type	Sink (1)
	IEC 61131-2 conformity	Type 1
Digital outputs	Voltage	24 V \pm
	Type	Transistor/Source (2)
	Current per output	0.5 A max.
	Current per interface block	4 A max.
Sensor/actuator power supply	Voltage	24 V \pm
	Max. current	500 mA for all channels
	Protection against	Overloads, short-circuits, and reverse polarity
Connection	CANopen bus	Bus input connector
		Bus output connector
	TM7 expansion bus	Bus input connector
		Bus output connector
	Digital I/O channels	Sensor connector
		Actuator connector
	Interface block power supply	Input connector
		Output connector
Diagnostics	By interface block	Yes
	By channel	Yes
	By communication	On CANopen bus
		On TM7 bus
CANopen interface block	TM7NCOM08B	
	TM7NCOM16B	
Page	25	

	IP67	IP67
	Plastic	Plastic
	8 channels configurable as inputs or outputs	16 channels configurable as inputs or outputs
	0...8 according to software configuration	0...16 according to software configuration
	0...8 according to software configuration	0...16 according to software configuration
	24 V \pm /4.4 mA	24 V \pm /4.4 mA
	Sink (1)	Sink (1)
	Type 1	Type 1
	24 V \pm	24 V \pm
	Transistor/Source (2)	Transistor/Source (2)
	0.5 A max.	0.5 A max.
	4 A max.	4 A max.
	24 V \pm	24 V \pm
	500 mA for all channels	500 mA for all channels
	Overloads, short-circuits, and reverse polarity	Overloads, short-circuits, and reverse polarity
	A-coded 5-way male M12	A-coded 5-way male M12
	-	A-coded 5-way female M12
	-	-
	B-coded 4-way female M12	B-coded 4-way female M12
	3-way female M8, 1 channel per connector	3-way female M8, 1 channel per connector
	3-way female M8, 1 channel per connector	3-way female M8, 1 channel per connector
	4-way male M8	4-way male M8
	4-way female M8	4-way female M8
	Yes	Yes
	Yes	Yes
	Yes	Yes
	Yes	Yes
	TM7NCOM08B	TM7NCOM16B
	25	

(1) Sink inputs: positive logic
(2) Source outputs: positive logic

	IP67
	Plastic
	16 channels configurable as inputs or outputs
	0...16 according to software configuration
	0...16 according to software configuration
	24 V \pm /4.4 mA
	Sink (1)
	Type 1
	24 V \pm
	Transistor/Source (2)
	0.5 A max.
	4 A max.
	24 V \pm
	500 mA for all channels
	Overloads, short-circuits, and reverse polarity
	A-coded 5-way male M12
	A-coded 5-way female M12
	-
	B-coded 4-way female M12
	A-coded 5-way female M12, 2 channels per connector
	A-coded 5-way female M12, 2 channels per connector
	4-way male M8
	4-way female M8
	Yes
	Yes
	Yes
	Yes
	TM7NCOM16A
	25

CANopen for machines

Modicon TM7, High-Performance and Safe IP67

Distributed I/O System

CANopen interface blocks

Presentation



The Modicon TM7 CANopen interface blocks enable sensors and actuators distributed over machines to be connected via the CANopen fieldbus. These interface blocks communicate on the bus. They have one part for connecting sensors and actuators using M8 or M12 connectors and one part for connections to the CANopen fieldbus.

IP67 protection means that these blocks can be used within processes or machines in harsh environments (where there is a risk of splashing water, oil, or dust, etc.).

They have the following characteristics:

- Ingress protection
- Ruggedness and compactness
- Rapid wiring, economical use

The offer comprises:

- A CANopen interface block with 8 configurable I/O for connection via M8 connector
- Two Modicon TM7 CANopen interface blocks with 16 configurable I/O

The following components complete the offer:

- digital I/O expansion blocks
- analog input expansion blocks
- power distribution block
- connection accessories

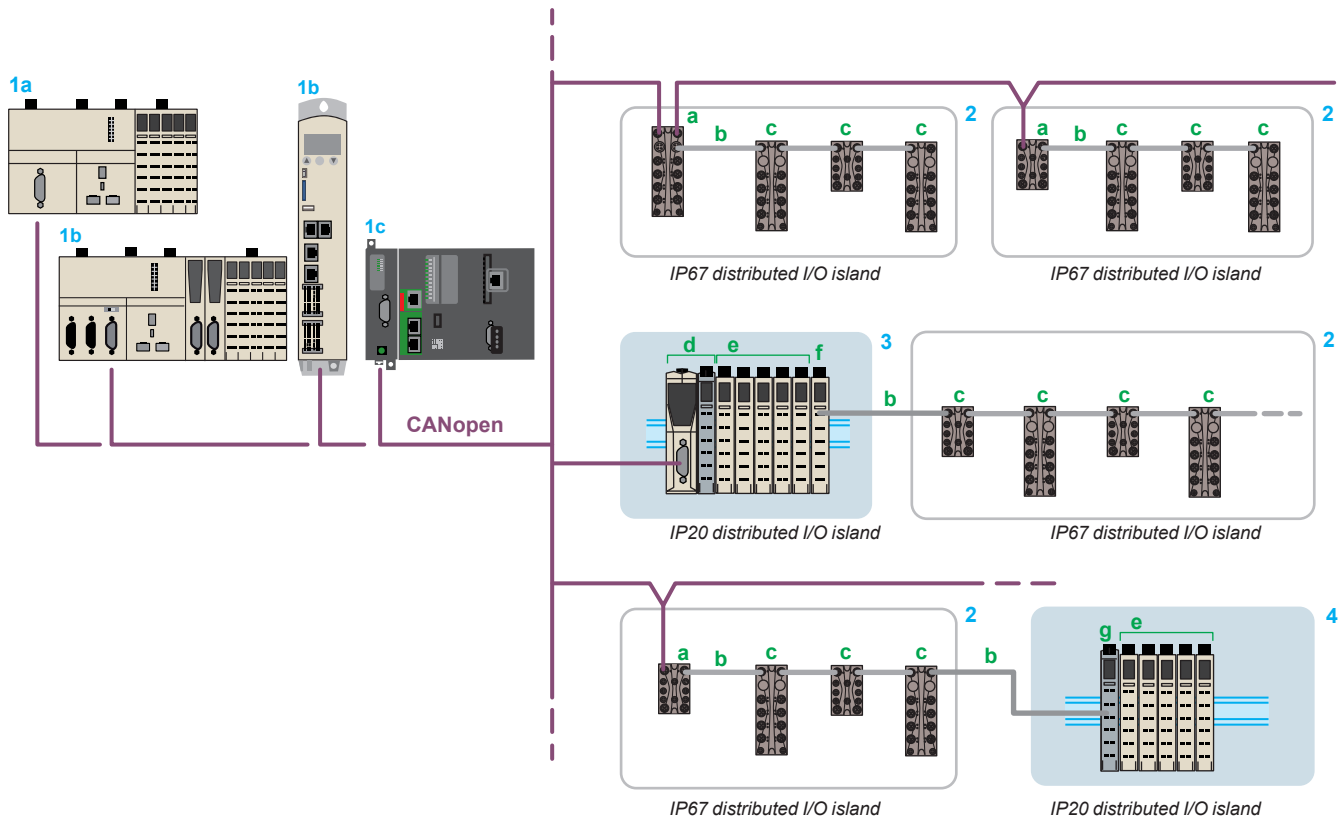

1 a Modicon M258 logic controller b Modicon LMC058 or Modicon LMC078 motion controller c TMSCO1 communication module on Modicon M262 logic/motion controller: CANopen bus masters

2 TM7 CANopen interface block (slave) with digital I/O (a) + TM7 bus expansion cable (b) + TM7 digital/analog blocks (c) (1)

3 TM5 CANopen interface module (slave) (d) + TM5 modules (e) (2) + TM5SBET7 transmitter module (f) (2)

4 TM5SBER2 receiver module (g) (2) + TM5 modules (e) (2)

(1) Modicon TM7 digital/analog blocks, please refer to catalog ref. [DIA3ED2140405EN](#)

(2) Modicon TM5: please refer to catalog ref. [DIA3ED2131204EN](#)

CANopen for machines

Modicon TM7, High-Performance and Safe IP67

Distributed I/O System

CANopen interface blocks

Diagnostic functions

The diagnostics for monitoring detected faults are indicated by LEDs on the Modicon TM7 CANopen interface blocks and inform the control system (Modicon M258 logic controller or Modicon LMC058 motion controller) via the TM7 bus.

Each Modicon TM7 interface block has LEDs for:

- displaying the status of the TM7 bus, channels, and power supply
- quick, precise location of a detected fault

Diagnostics are performed at the following levels:

- Channel diagnostics:

- State of inputs
- State of outputs

- Communication bus diagnostics:

- On CAN bus (CANopen interface block)
- On TM7 expansion bus (CANopen interface block and I/O expansion blocks)

CANopen for machines

Modicon TM7, High-Performance and Safe IP67

Distributed I/O System

CANopen interface blocks

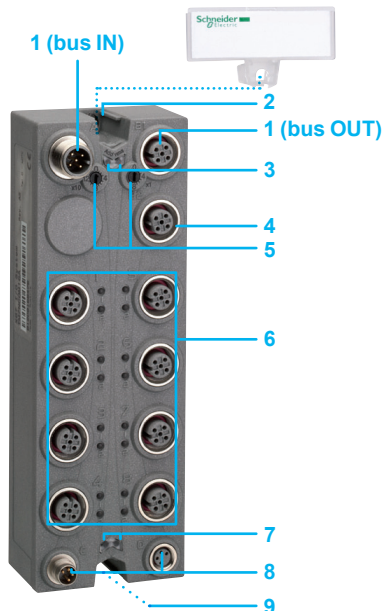
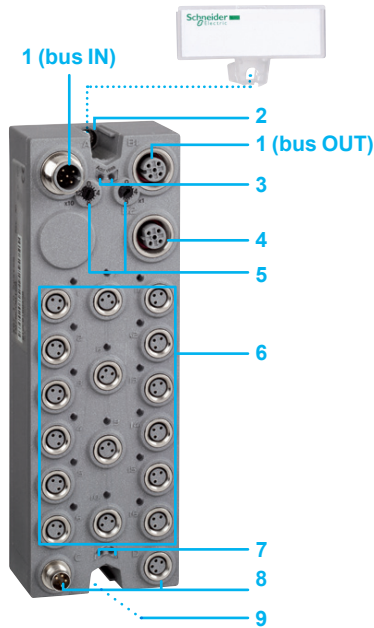
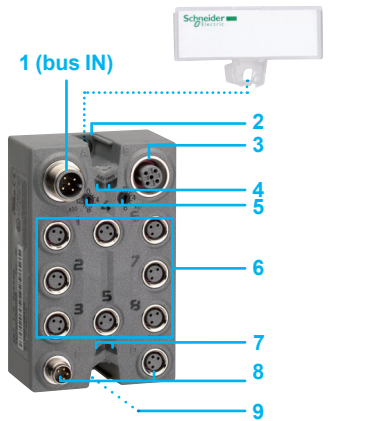

Description

Modicon TM7 CANopen interface blocks

Modicon TM7 **8-channel** CANopen interface blocks have the following on the front panel:

- 1 A male M12 connector (bus IN) for connecting the CANopen bus
- 2 A slot for the interface block label (1)
- 3 A female M12 connector for connecting the TM7 expansion bus
- 4 Two bus diagnostic LEDs
- 5 Thumbwheels for addressing on CANopen bus
- 6 Eight female M8 connectors for connecting sensors and actuators with eight channel status LEDs
- 7 Two LEDs indicating the status of the 24 V $\overline{\text{DC}}$ sensor and actuator power supplies
- 8 Two M8 connectors for connecting the 24 V $\overline{\text{DC}}$ sensor and actuator power supplies (male for PWR IN, female for PWR OUT)
- 9 Mounting using two \varnothing 4 screws (not supplied) and connection of the functional ground when block is mounted on a metal support

Modicon TM7 **16-channel** CANopen interface blocks have the following on the front panel:

- 1 A male M12 connector (bus IN) and a female M12 connector (bus OUT) for connecting the CANopen bus
- 2 A slot for the interface block label (1)
- 3 Two bus diagnostic LEDs
- 4 A female M12 connector for connecting the TM7 expansion bus
- 5 Thumbwheels for addressing on CANopen bus
- 6 Eight M12 connectors (2 channels per connector) or sixteen M8 connectors for connecting sensors and actuators with channel status LEDs
- 7 Two LEDs indicating the status of the 24 V $\overline{\text{DC}}$ sensor and actuator power supplies
- 8 Two M8 connectors for connecting the 24 V $\overline{\text{DC}}$ sensor and actuator power supplies (male for PWR IN, female for PWR OUT)
- 9 Mounting using two \varnothing 4 screws (not supplied) and connection of the functional ground when block is mounted on a metal support

(1) Label-holder supplied with IP67 block

CANopen for machines

Modicon TM7, High-Performance and Safe IP67

Distributed I/O System

CANopen interface blocks



TM7NCOM08B

Modicon TM7 CANopen interface blocks with digital I/O

Max. no. of channels	Number/type of inputs	Number/type of outputs	Sensor and actuator connection	Communication bus	Reference	Weight kg/lb
8 I/O	8, sink (1)	8, transistor/source (2)	8 female M8 connectors	CANopen, TM7 bus	TM7NCOM08B	0.195/ 0.430

16 I/O	16, sink (1)	16, transistor/source (2)	16 female M8 connectors	CANopen, TM7 bus	TM7NCOM16B	0.320/ 0.705
--------	--------------	---------------------------	-------------------------	------------------	----------------------------	-----------------



TM7NCOM16B



TM7NCOM16A

16, sink (1)	16, transistor/source (2)	8 female M12 connectors	CANopen, TM7 bus	TM7NCOM16A	0.320/ 0.705
--------------	---------------------------	-------------------------	------------------	----------------------------	-----------------

- (1) Sink inputs: positive logic
 (2) Source outputs: positive logic

Architecture and connection cables

[See page 26](#)

Separate parts

[See page 29](#)

Configuration software

- EcoStruxure Machine Expert software: please refer to catalog ref. [DIA3ED2180701EN](#)
- Performance distributed I/O configuration software: please visit our website www.schneider-electric.com

CANopen for machines

Modicon TM7, High-Performance and Safe IP67 Distributed I/O System

Connection components: CANopen and TM7 bus architecture

CANopen architecture

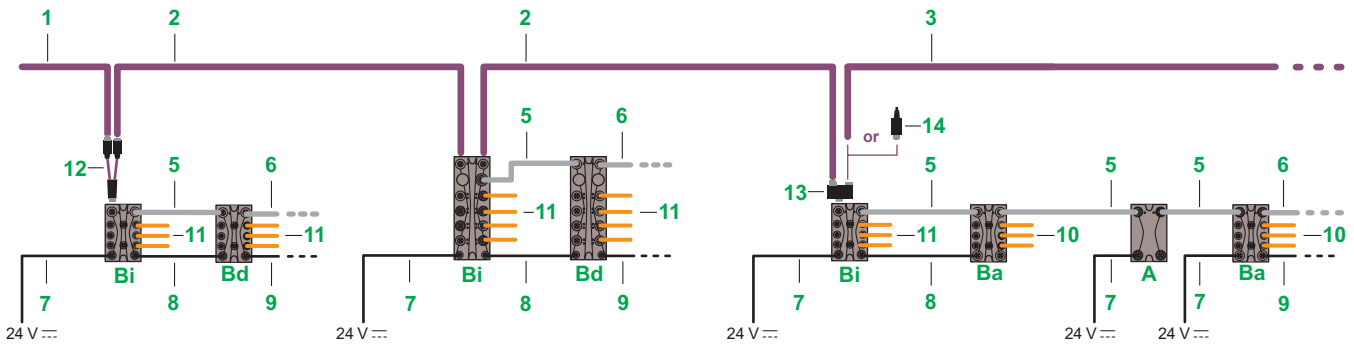

TM7 bus architecture

TM5NCO1 + TM5SBET7

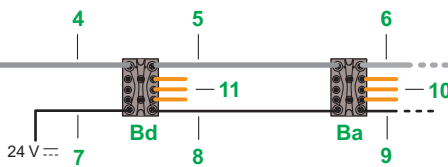
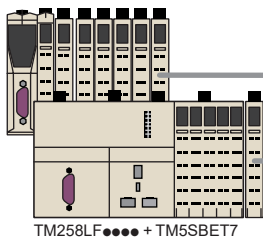

- A Power distribution block
- Ba Analog I/O expansion block
- Bd Digital I/O expansion block
- Bi CANopen interface block

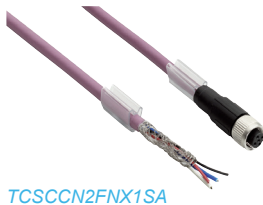

TCSCCN2FNX1SA

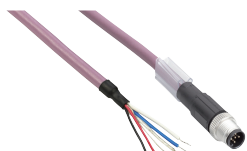

TCSCCN1MNX●●SA

Cables for connection to the CANopen bus

Designation	Description	Item	Length m/ft	Reference	Weight kg/lb		
CANopen bus connection cables (bus IN)	Equipped with 1 A-coded 5-way angled female M12 connector at one end and flying leads at the other	1	1/3.28	TCSCCN2FNX1SA	0.089/0.196		
			3/9.843	TCSCCN2FNX3SA	0.195/0.430		
			10/32.81	TCSCCN2FNX10SA	0.563/1.241		
			25/82.02	TCSCCN2FNX25SA	1.352/2.981		
	Equipped with 1 A-coded 5-way straight female M12 connector at one end and flying leads at the other	1	1/3.28	TCSCCN1FNX1SA	0.089/0.196		
			3/9.843	TCSCCN1FNX3SA	0.195/0.430		
			10/32.81	TCSCCN1FNX10SA	0.563/1.241		
			25/82.02	TCSCCN1FNX25SA	1.352/2.981		
		CANopen bus daisy chain cables	Equipped with 2 A-coded 5-way angled M12 connectors, 1 male and 1 female	2	0.3/0.98	TCSCCN2M2F03	0.090/0.198
					1/3.28	TCSCCN2M2F1	0.127/0.280
					2/6.56	TCSCCN2M2F2	0.179/0.395
					5/16.40	TCSCCN2M2F5	0.337/0.743
Equipped with 2 A-coded 5-way straight M12 connectors, 1 male and 1 female	2		0.3/0.98	TCSCCN1M1F03	0.090/0.198		
			1/3.28	TCSCCN1M1F1	0.127/0.280		
			2/6.56	TCSCCN1M1F2	0.179/0.395		
			5/16.40	TCSCCN1M1F5	0.337/0.743		
CANopen bus connection cables (bus OUT)	Equipped with 1 A-coded 5-way angled male M12 connector at one end and flying leads at the other	3	1/3.28	TCSCCN2MNX1SA	0.089/0.196		
			3/9.843	TCSCCN2MNX3SA	0.195/0.430		
			10/32.81	TCSCCN2MNX10SA	0.563/1.241		
			25/82.02	TCSCCN2MNX25SA	1.352/2.981		
	Equipped with 1 A-coded 5-way straight male M12 connector at one end and flying leads at the other	3	1/3.28	TCSCCN1MNX1SA	0.089/0.196		
			3/9.843	TCSCCN1MNX3SA	0.195/0.430		
			10/32.81	TCSCCN1MNX10SA	0.563/1.241		
			25/82.02	TCSCCN1MNX25SA	1.352/2.981		

TM7 bus expansion cables

TM7 bus expansion cables (bus IN)	Equipped with 1 B-coded 4-way angled female M12 connector at one end and flying leads at the other	4	1/3.28	TCSXCN2FNX1E	0.089/0.196
			3/9.843	TCSXCN2FNX3E	0.195/0.430
			10/32.81	TCSXCN2FNX10E	0.563/1.241
			25/82.02	TCSXCN2FNX25E	1.352/2.981
	Equipped with 1 B-coded 4-way straight female M12 connector at one end and flying leads at the other	4	1/3.28	TCSXCN1FNX1E	0.089/0.196
			3/9.843	TCSXCN1FNX3E	0.195/0.430
			10/32.81	TCSXCN1FNX10E	0.563/1.241
			25/82.02	TCSXCN1FNX25E	1.352/2.981

CANopen for machines

Modicon TM7, High-Performance and Safe IP67 Distributed I/O System

Connection components: CANopen and TM7 bus architecture

CANopen architecture

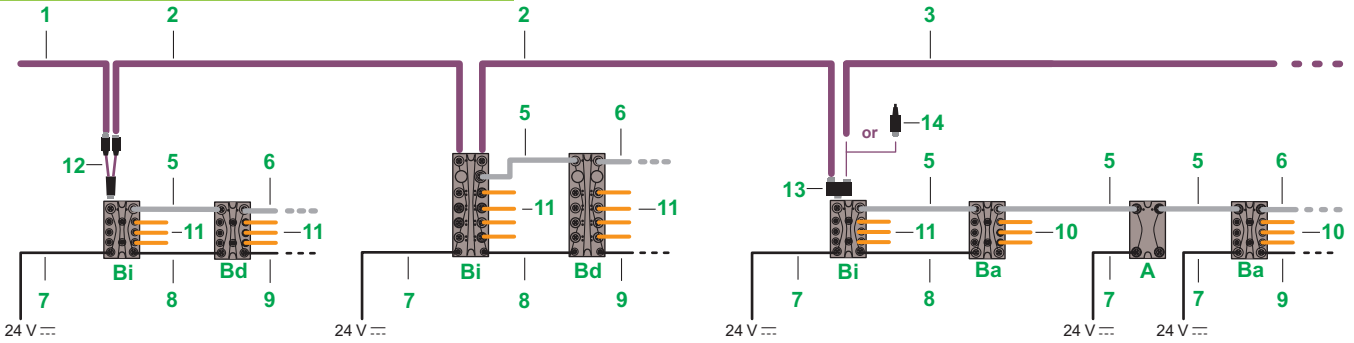

TM7 bus architecture

TM5NCO1 + TM5SBET7

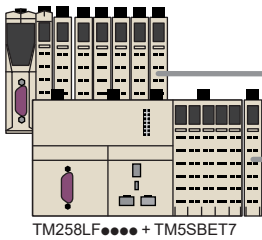

TM258LF... + TM5SBET7

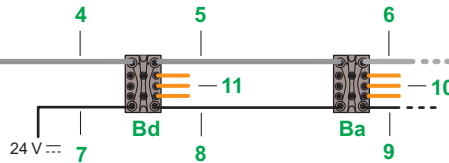

- A** Power distribution block
- Ba** Analog I/O expansion block
- Bd** Digital I/O expansion block
- Bi** CANopen interface block

TM7 bus expansion cables (continued)

Designation	Description	Item	Length m/ft	Reference	Weight kg/lb		
TM7 bus daisy chain cables	Equipped with 2 B-coded 4-way angled M12 connectors, 1 male and 1 female	5	0.3/0.98	TCSXCN2M2F03E	0.090/0.198		
			1/3.28	TCSXCN2M2F1E	0.127/0.280		
			2/6.56	TCSXCN2M2F2E	0.179/0.395		
			5/16.40	TCSXCN2M2F5E	0.337/0.743		
			10/32.81	TCSXCN2M2F10E	0.600/1.323		
	Equipped with 2 B-coded 4-way straight M12 connectors, 1 male and 1 female	5	0.3/0.98	TCSXCN1M1F03E	0.090/0.198		
			1/3.28	TCSXCN1M1F1E	0.127/0.280		
			2/6.56	TCSXCN1M1F2E	0.179/0.395		
			5/16.40	TCSXCN1M1F5E	0.337/0.743		
			10/32.81	TCSXCN1M1F10E	0.600/1.323		
TM7 bus expansion cables (bus OUT)	Equipped with 1 B-coded 4-way angled male M12 connector at one end and flying leads at the other	6	1/3.28	TCSXCN2MNX1E	0.089/0.196		
			3/9.843	TCSXCN2MNX3E	0.195/0.430		
			10/32.81	TCSXCN2MNX10E	0.563/1.241		
			25/82.02	TCSXCN2MNX25E	1.352/2.981		
			1/3.28	TCSXCN1MNX1E	0.089/0.196		
	Equipped with 1 B-coded 4-way straight male M12 connector at one end and flying leads at the other	6	3/9.843	TCSXCN1MNX3E	0.195/0.430		
			10/32.81	TCSXCN1MNX10E	0.563/1.241		
			25/82.02	TCSXCN1MNX25E	1.352/2.981		
			Power distribution cables				
			Power IN power distribution cables	Equipped with 1x 4-way angled female M8 connector at one end and flying leads at the other	7	1/3.28	TCSXCNEFNX1V
3/9.843	TCSXCNEFNX3V	0.105/0.231					
10/32.81	TCSXCNEFNX10V	0.329/0.725					
25/82.02	TCSXCNEFNX25V	0.809/1.784					
1/3.28	TCSXCNDFNX1V	0.041/0.090					
Equipped with 1x 4-way straight female M8 connector at one end and flying leads at the other	7	3/9.843	TCSXCNDFNX3V	0.105/0.231			
		10/32.81	TCSXCNDFNX10V	0.329/0.725			
		25/82.02	TCSXCNDFNX25V	0.809/1.784			
		Power daisy chain cables					
		Power daisy chain cables	Equipped with 2x 4-way angled M8 connectors, 1 male and 1 female	8	0.3/0.98	TCSXCNEMEF03V	0.028/0.062
1/3.28	TCSXCNEMEF1V				0.050/0.110		
2/6.56	TCSXCNEMEF2V				0.082/0.181		
5/16.40	TCSXCNEMEF5V				0.178/0.392		
10/32.81	TCSXCNEMEF10V				0.338/0.745		
Equipped with 2x 4-way straight M8 connectors, 1 male and 1 female	8	15/49.21	TCSXCNEMEF15V	0.498/1.098			
		0.3/0.98	TCSXCNDMDF03V	0.105/0.231			
		1/3.28	TCSXCNDMDF1V	0.329/0.725			
		2/6.56	TCSXCNDMDF2V	0.809/1.784			
		5/16.40	TCSXCNDMDF5V	0.105/0.231			
10/32.81	TCSXCNDMDF10V	0.329/0.725					
15/49.21	TCSXCNDMDF15V	0.809/1.784					



CANopen for machines

Modicon TM7, High-Performance and Safe IP67 Distributed I/O System

Connection components: CANopen and TM7 bus architecture

CANopen architecture

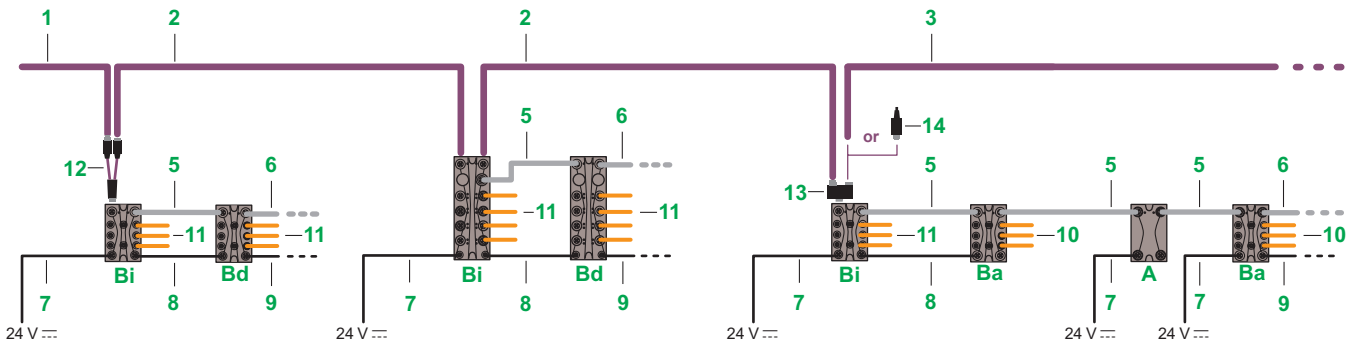

TM7 bus architecture

TM5NCO1 + TM5SBET7

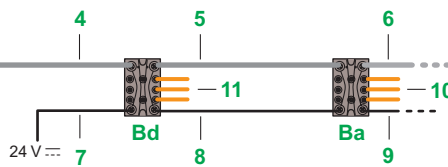
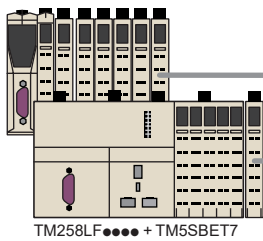

- A Power distribution block
- Ba Analog I/O expansion block
- Bd Digital I/O expansion block
- Bi CANopen interface block



Power distribution cables

Designation	Description	Item	Length m/ft	Reference	Weight kg/lb
Power OUT power distribution cables	Equipped with 1x 4-way angled male M8 connector at one end and flying leads at the other	9	1/3.28	TCSXCNEXX1V	0.041/0.090
			3/9.843	TCSXCNEXX3V	0.105/0.231
			10/32.81	TCSXCNEXX10V	0.329/0.725
			25/82.02	TCSXCNEXX25V	0.809/1.784
	Equipped with 1x 4-way straight male M8 connector at one end and flying leads at the other	9	1/3.28	TCSXCNDMNX1V	0.041/0.090
			3/9.843	TCSXCNDMNX3V	0.105/0.231
			10/32.81	TCSXCNDMNX10V	0.329/0.725
			25/82.02	TCSXCNDMNX25V	0.809/1.784

Cables for connecting analog sensors and actuators

Designation	Description	Item	Length m/ft	Reference	Weight kg/lb
Cables for connecting sensors and actuators	Equipped with 1 A-coded 5-way angled male M12 connector at one end and flying leads at the other	10	2/6.56	TCSXCN2M2SA	0.143/0.315
			5/16.40	TCSXCN2M5SA	0.258/0.569
			15/49.21	TCSXCN2M15SA	0.546/1.204
	Equipped with one A-coded 5-way straight male M12 connector at one end and flying leads at the other	10	2/6.56	TCSXCN1M2SA	0.143/0.315
			5/16.40	TCSXCN1M5SA	0.258/0.569
			15/49.21	TCSXCN1M15SA	0.546/1.204

Cables for connecting digital sensors and actuators

Please refer to the "Detection for OsiSense automation solutions" catalog, ref. [MKTED210041EN](#) 11

Accessories

Designation	Composition	Item	Reference	Weight kg/lb
CAN bus Y cable	Equipped with 2x 5-way M12 connectors, 1 male and 1 female at one end and 1x 5-way male M12 connector at the other end	12	TM7ACYCJ	0.031/0.068
CAN Y connector	For connecting 2x M12 connectors, 1 male and 1 female, to a male M12 connector on the expansion block	13	TM7ACYC	0.100/0.220
Line terminator (for end of bus)	Equipped with 1x 5-way male M12 connector	14	TM7ACTLA	0.023/0.051
Connector with temperature probe for measurement by thermocouple (1)	Equipped with 1x 5-way male M12 connector	-	TM7ACTHA	0.100/0.220

(1) For use with the TM7BAI4PLA expansion block for measuring the temperature of the connector with compensation

CANopen for machines

Modicon TM7, High-Performance and Safe IP67
Distributed I/O System

Separate parts



TM7ACMP

Separate parts

Description	Composition	Unit reference	Weight kg/lb
Sealing plugs (1)	For M8 connector on Modicon TM7 blocks Pack of 50	TM7ACCB	0.100/0.220
	For M12 connector on Modicon TM7 blocks Pack of 50	TM7ACCA	0.100/0.220
Plate for mounting on symmetrical DIN rail	For Modicon TM7 blocks	TM7ACMP	0.020/0.044
	For Modicon TM7 blocks Pack of 10	TM7ACMP10	0.200/0.441
Screwdrivers	For tightening the rings on M8 and M12 connectors to the correct torque Pack of 2	TM7ACTW	0.198/0.437

(1) The use of sealing plugs ensures that unused connectors on Modicon TM7 IP67 blocks have IP67 protection.

A					
AM02CA001V000	13	TCSXCN1M2SA	28	TM5NCO1	19
	17	TCSXCN1M5SA	28	TM5NCO1K	19
F		TCSXCN1MNX10E	27	TM5SPS3	19
FTXCN12F5	12	TCSXCN1MNX1E	27	TM7ACCA	29
FTXCN12M5	12	TCSXCN1MNX25E	27	TM7ACCB	29
T		TCSXCN1MNX3E	27	TM7ACMP	29
TCSCAR013M120	9	TCSXCN2FNX10E	26	TM7ACMP10	29
	12	TCSXCN2FNX1E	26	TM7ACTHA	28
TCSCAR01NM120	9	TCSXCN2FNX25E	26	TM7ACTLA	28
	12	TCSXCN2FNX3E	26	TM7ACTW	29
TCSCCN1FNX10SA	26	TCSXCN2M15SA	28	TM7ACYC	28
TCSCCN1FNX1SA	26	TCSXCN2M2F03E	27	TM7ACYCJ	28
TCSCCN1FNX25SA	26	TCSXCN2M2F10E	27	TM7NCOM08B	25
TCSCCN1FNX3SA	26	TCSXCN2M2F15E	27	TM7NCOM16A	25
TCSCCN1M1F03	26	TCSXCN2M2F1E	27	TM7NCOM16B	25
TCSCCN1M1F1	26	TCSXCN2M2F2E	27	TSXCANCA100	9
TCSCCN1M1F10	26	TCSXCN2M2F5E	27		13
TCSCCN1M1F15	26	TCSXCN2M2SA	28		17
TCSCCN1M1F2	26	TCSXCN2M5SA	28	TSXCANCA300	9
TCSCCN1M1F5	26	TCSXCN2MNX10E	27		13
TCSCCN1MNX10SA	26	TCSXCN2MNX1E	27		17
TCSCCN1MNX1SA	26	TCSXCN2MNX25E	27	TSXCANCA50	9
TCSCCN1MNX25SA	26	TCSXCN2MNX3E	27		13
TCSCCN1MNX3SA	26	TCSXCN2MNX10V	27		17
TCSCCN2FNX10SA	26	TCSXCNDFNX1V	27	TSXCANCADD03	9
TCSCCN2FNX1SA	26	TCSXCNDFNX25V	27		13
TCSCCN2FNX25SA	26	TCSXCNDFNX3V	27		17
TCSCCN2FNX3SA	26	TCSXCNDMDF03V	27	TSXCANCADD1	9
TCSCCN2M2F03	26	TCSXCNDMDF10V	27		13
TCSCCN2M2F1	26	TCSXCNDMDF15V	27		17
TCSCCN2M2F10	26	TCSXCNDMDF1V	27	TSXCANCADD3	9
TCSCCN2M2F15	26	TCSXCNDMDF2V	27		13
TCSCCN2M2F2	26	TCSXCNDMDF5V	27		17
TCSCCN2M2F5	26	TCSXCNDMNX10V	28	TSXCANCADD5	9
TCSCCN2MNX10SA	26	TCSXCNDMNX1V	28		13
TCSCCN2MNX1SA	26	TCSXCNDMNX25V	28		17
TCSCCN2MNX25SA	26	TCSXCNDMNX3V	28	TSXCANCB100	9
TCSCCN2MNX3SA	26	TCSXCNEFNX10V	27		13
TCSCCN4F3M05T	9	TCSXCNEFNX1V	27		17
	13	TCSXCNEFNX25V	27	TSXCANCB50	9
	17	TCSXCNEFNX3V	27		13
TCSCCN4F3M1T	9	TCSXCNEMEF03V	27		17
	13	TCSXCNEMEF10V	27	TSXCANCBDD03	9
	17	TCSXCNEMEF15V	27		13
TCSCCN4F3M3T	9	TCSXCNEMEF1V	27		17
	13	TCSXCNEMEF2V	27	TSXCANCBDD1	9
	17	TCSXCNEMEF5V	27		13
TCSCTN011M11F	13	TCSXCNEXX10V	28		17
	17	TCSXCNEXX1V	28	TSXCANCBDD3	9
TCSCTN023F13M03	9	TCSXCNEXX25V	28		13
	12	TCSXCNEXX3V	28		17
TCSCTN026M16M	9	TLACDCBA005	9	TSXCANCD100	9
	12		13		13
TCSXCN1FNX10E	26		17		17
TCSXCN1FNX1E	26	TLACDCBA015	9	TSXCANCD300	9
TCSXCN1FNX25E	26		13		13
TCSXCN1FNX3E	26		17		17
TCSXCN1M15SA	28	TLACDCBA030	9	TSXCANCD50	9
TCSXCN1M1F03E	27		13		13
TCSXCN1M1F10E	27		17	TSXCANCD180T	9
TCSXCN1M1F15E	27	TLACDCBA050	9		12
TCSXCN1M1F1E	27		13		16
TCSXCN1M1F2E	27		17	TSXCANKCDF90T	9
TCSXCN1M1F5E	27	TM5ACBN1	19		12
		TM5ACTB12PS	19		16
				TSXCANKCDF90TP	9
					12
					16
				TSXCANTDM4	9
					12
					16
				V	
				VW3CANA71	9
					13
					17
				VW3CANCARR03	9
					13
					17
				VW3CANCARR1	9
					13
					17
				VW3CANKCDF180T	13
					17
				VW3CANTAP2	9
					12
					16
				VW3M3805R010	9
					13
					17
				VW3M3805R030	9
					13
					17
				X	
				XBTZGCCAN	11



[www.schneider-electric.com/Machine control solutions](http://www.schneider-electric.com/Machine%20control%20solutions)

Schneider Electric Industries SAS

Head Office
35, rue Joseph Monier
F-92500 Rueil-Malmaison
France

The information provided in this documentation contains general descriptions and/or technical characteristics of the performance of the products contained herein. This documentation is not intended as a substitute for and is not to be used for determining suitability or reliability of these products for specific user applications. It is the duty of any such user or integrator to perform the appropriate and complete risk analysis, evaluation and testing of the products with respect to the relevant specific application or use thereof. Neither Schneider Electric nor any of its affiliates or subsidiaries shall be responsible or liable for misuse of the information contained herein.

Design: Schneider Electric
Photos: Schneider Electric

DIA3ED2160104EN