

Altivar® 61/71

Adjustable Speed Drives

Plastic Kits and Power Terminal Kit

Instruction Bulletin

30072-453-27

Retain for future use.



For Frame Sizes 2–5:

ATV61H075M3, -HU15M3, -HU22M3, -HU30M3, -HU40M3, -HU55M3,
-HU75M3, -HD11M3X, -HD15M3X, -H075N4, -HU15N4, -HU22N4,
-HU30N4, -HU40N4, -HU55N4, -HU75N4, -HD11N4, -HD15N4, -HD18N4

ATV71H037M3, -H075M3, -HU15M3, -HU22M3, -HU30M3, -HU40M3,
-HU55M3, -HU75M3, -HD11M3X, -HD15M3X, -H075N4, -HU15N4,
-HU22N4, -HU30N4, -HU40N4, -HU55N4, -HU75N4, -HD11N4, -HD15N4,
-HD18N4

Contents



| | |
|---|----|
| Hazard Categories and Special Symbols | 4 |
| Product Support | 4 |
| Before You Begin | 5 |
| Introduction | 6 |
| Related Documentation | 8 |
| Receiving, Handling, and Storage | 8 |
| Electrostatic Precautions | 8 |
| Inspecting the Spare Part Kits | 8 |
| Preliminary Recommendations | 9 |
| Qualified Personnel | 9 |
| Working Procedures | 9 |
| Tools Required | 10 |
| Installation Procedures | 10 |
| Power Removal and Bus Voltage Measurement | 10 |
| Discharging Stored Energy in Capacitors | 11 |
| Parts Identification | 12 |
| Replacing the Plastic Kits | 13 |
| Remove/Replace the Power Trap Cover | 13 |
| Remove/Replace the Wiring Trap Cover | 14 |
| Remove/Replace the IP4X Cover and the Top Cover | 15 |
| Remove/Replace the Front Cap | 16 |
| Remove/Replace the Side Caps | 17 |
| Replacing the Power Terminal Block | 18 |

Hazard Categories and Special Symbols

The following symbols and special messages may appear in this document or on the equipment to warn of potential hazards or to call attention to information that clarifies or simplifies a procedure.

A lightning bolt or ANSI man symbol in a “Danger” or “Warning” safety label on the equipment indicates an electrical hazard which, as indicated below, can or will result in personal injury if the instructions are not followed.

The exclamation point symbol in a safety message in a manual indicates potential personal injury hazards. Obey all safety messages introduced by this symbol to avoid possible injury or death.

| Symbol | Name |
|---|-------------------|
|  | Lightning Bolt |
|  | ANSI Man |
|  | Exclamation Point |

| |
|---|
| ⚠ DANGER |
| DANGER indicates an imminently hazardous situation which, if not avoided, will result in death or serious injury. |

| |
|---|
| ⚠ WARNING |
| WARNING indicates a potentially hazardous situation which, if not avoided, can result in death or serious injury. |

| |
|--|
| ⚠ CAUTION |
| CAUTION indicates a potentially hazardous situation which, if not avoided, can result in minor or moderate injury. |

| |
|---|
| CAUTION |
| CAUTION , used without the safety alert symbol, indicates a potentially hazardous situation which, if not avoided, can result in property damage. |

Product Support

For support and assistance, contact the Product Support Group. The Product Support Group is staffed from Monday through Friday, 8:00 am until 6:00 pm Eastern time, to assist with product selection, start-up, and diagnosis of product or application problems. Emergency phone support is available 24 hours a day, 365 days a year.

Toll free: 888-SquareD (888-778-2733)
 E-Mail: drive.products.support@us.schneider-electric.com
 Fax: 919-217-6508

Before You Begin

Read and follow these precautions before performing any procedure with this drive.

The word “drive” as used in this bulletin refers to the controller portion of the adjustable speed drive as defined in the National Electrical Code (NEC).

⚠ DANGER

HAZARD OF ELECTRIC SHOCK, EXPLOSION, OR ARC FLASH

- Read and understand this manual before installing or operating the Altivar 61 or 71 drive. Installation, adjustment, repair, and maintenance must be performed by qualified personnel.
- The user is responsible for compliance with all international and national electrical code requirements with respect to grounding of all equipment.
- Many parts of this drive, including the printed circuit boards, operate at the line voltage. **DO NOT TOUCH.** Use only electrically insulated tools.
- **DO NOT** touch unshielded components or terminal strip screw connections with voltage present.
- **DO NOT** short across terminals PA/+ and PC/- or across the DC bus capacitors.
- Before servicing the drive:
 - Disconnect all power, including external control power that may be present.
 - Place a “DO NOT TURN ON” label on all power disconnects.
 - Lock all power disconnects in the open position.
 - **WAIT 15 MINUTES** to allow the DC bus capacitors to discharge. Then follow the “Bus Voltage Measurement Procedure” on page 10 to verify that the DC voltage is less than 42 V. The drive LED is not an indicator of the absence of DC bus voltage.
- Install and close all covers before applying power or starting and stopping the drive.

Failure to follow these instructions will result in death or serious injury.

Introduction

This instruction bulletin contains replacement procedures for the Altivar® 61 (ATV61) and Altivar® 71 (ATV71) plastic kits identified in Table 1. Read and understand the instructions in this document and other referenced documents before installing the kits. For parts identification, refer to Figures 1 and 2 on page 12.

Table 1: Altivar® 61 and 71 Plastic Kits and Power Terminal Kit







| Kit Catalog No. | Description | For Use on Drive: | Kit Contents |
|-----------------|------------------------------|---|---|
| VY1A1202 | Plastic kit for frame size 2 | ATV61H075M3, ATV61HU15M3, ATV61H075N4, ATV61HU15N4, ATV61HU22N4, ATV71H075M3, ATV71HU15M3, ATV71H037M3, ATV71H075N4, ATV71HU15N4, ATV71HU22N4 |  <ul style="list-style-type: none"> (1) IP4X cover (1) Wiring trap cover (1) Power trap cover (2) Side caps (1) Top cap |
| VY1A1203 | Plastic kit for frame size 3 | ATV61HU22M3, ATV61HU30M3, ATV61HU40M3, ATV61HU30N4, ATV61HU40N4, ATV71HU22M3, ATV71HU30M3, ATV71H040M3, ATV71HU30N4, ATV71HU40N4 |  <ul style="list-style-type: none"> (1) IP4X cover (1) Front cap (1) Wiring trap cover (1) Power trap cover (2) Side caps (1) Top cap |
| VY1A1204 | Plastic kit for frame size 4 | ATV61HU55M3, ATV61HU55N4, ATV61HU75N4, ATV71HU55M3, ATV71HU55N4, ATV71HU75N4 |  <ul style="list-style-type: none"> (1) IP4X cover (1) Front cap (1) Wiring trap cover (1) Power trap cover (2) Side caps (1) Top cap |

Table 1: Altivar® 61 and 71 Plastic Kits and Power Terminal Kit

| Kit Catalog No. | Description | For Use on Drive: | For Use on Drive: | Kit Contents |
|-----------------|--|---|---|---|
| VY1A1205 | Plastic kit for frame size 5B | ATV61HD11M3X, ATV61HD15M3X, ATV61HD15N4, ATV61HD18N4, ATV71HD11M3X, ATV71HD15M3X, ATV71HD15N4, ATV71HD18N4 |  | (1) IP4X cover (1) Front cap (1) Wiring trap cover (1) Power trap cover (2) Side caps (1) Top cap |
| VZ3N1205 | Power terminal block kit for frame size 5B | ATV61HD11M3X, ATV61HD15M3X, ATV61HD15N4, ATV61HD18N4, ATV71HD11M3X, ATV71HD15M3X, ATV71HD15N4, ATV71HD18N4 |  | (1) Power terminal (1) DC warning label (1) Motor warning label (1) Input warning label (240 V) (1) Input warning label (480 V) |
| VY1A1215 | Plastic kit for frame size 5A | ATV61HU75M3, ATV61HD11N4, ATV71HU75M3, ATV71HD11N4 |  | (1) IP4X cover (1) Front cap (1) Wiring trap cover (1) Power trap cover (2) Side caps (1) Top cap |

Related Documentation

For drive installation instructions, refer to the following documents:

- *Altivar® 61 Installation Manual 0.5 to 100 HP*, module no. 1760643.
- *Supplementary Instructions to ATV61 Variable Speed Drives Installation Manual—Low Horsepower*, document no. 30072-452-63.
- *Altivar® 61 Installation Manual 75 to 900 HP*, module no. 1760655.
- *Supplementary Instructions to ATV61 Variable Speed Drives Installation Manual—High Horsepower*, document no. 30072-452-49.
- *Altivar® 71 Installation Manual 0.5 to 100 HP*, module no. 1755843.
- *Altivar® 71 Installation Manual 75 to 700 HP*, module no. 1755849.
- *Altivar® 71 Drive Controllers Errata to Bulletin atv71e_installation_manual_en_v3*, document no. 30072-452-25.

All documentation referenced in this bulletin is provided with the drive or on the CD-ROM included with the spare parts kits. You can also download the documentation from the Technical Library at www.schneider-electric.us.

Receiving, Handling, and Storage

Electrostatic Precautions

⚠ CAUTION

STATIC SENSITIVE COMPONENTS

Circuit boards and option cards can be damaged by static electricity. Observe the electrostatic precautions below when handling controller circuit boards or testing components.

Failure to follow these instructions can result in injury or equipment damage.

Observe the following precautions for handling static-sensitive components:

- Keep static-producing material such as plastic, upholstery, and carpeting out of the immediate work area.
- Store static-sensitive components in protective packaging when they are not installed in the drive.
- When handling a static-sensitive component, wear a conductive wrist strap connected to the component or drive through a minimum of 1 megohm resistance.
- Avoid touching exposed conductors and component leads with skin or clothing.

Inspecting the Spare Part Kits

After receiving the ATV61/ATV71 spare parts kit:

- Ensure that the catalog number printed on the kit label is the same as that on the packing slip and corresponding purchase order. Contact your Schneider Electric representative if there are any errors.
- Remove the kit from its packaging and inspect it for damage. If any damage is found, notify the carrier and your Schneider Electric representative.
- To store the kit, replace any static-sensitive parts in their protective packaging and store them at -25 to +70 °C (-13 to +158 °F).

⚠ WARNING

DAMAGED EQUIPMENT

Do not install or operate any equipment that appears damaged.

Failure to follow these instructions can result in death, serious injury, or equipment damage.

Preliminary Recommendations

Qualified Personnel

Before beginning the installation procedures, read and understand all the information in this section.

For the protection of personnel and equipment, a qualified person must perform the procedures detailed in this instruction bulletin.

A qualified person is one who has skills and knowledge related to the construction and operation of this electrical equipment and the installation, and has received safety training to recognize and avoid the hazards involved. Refer to the most current release of NFPA 70E[®], “Standard for Electrical Safety in the Workplace,” for safety training requirements.

In addition, the person must be:

- Able to read, interpret, and follow the instructions and precautions in this instruction bulletin and the other documentation referenced.
- Able to use the required tools listed in this instruction bulletin in a safe and correct manner.

Working Procedures

Observe the following working procedures:

- Use only the components provided with the kits listed in Table 1 on page 6. Do not attempt to repair the drive with other spare parts or equipment.
- If the part being replaced includes labels, ensure that the labels are applied to the replacement part. If the labels are not available in the kit, contact your Schneider Electric representative.
- Mount the spare parts only in the locations specified in the installation procedures.
- Route and position the wires as shown in the instructions. Use the wires and cables provided with the spare parts kits or with the drive. Do not modify the wires and cables. Do not route wires and cables outside of the drive enclosure.
- Observe the hardware and torque requirements specified in the installation procedures. Do not substitute hardware. Carefully segregate and label all removed hardware and parts for use in reassembly of the drive.
- Mount all panels and covers as specified in the installation procedures.

Tools Required

- Flathead screw driver, 2.5 mm width
- Torque wrench, 0–5 N•m (0–45 lb-in)
- Voltmeter, 1–1000 Vdc
- Socket wrench, 7 mm
- Driver bits:
 - T-20 Torx[®] driver
 - Size 2 magnetic tip Phillips[®] driver

Installation Procedures

Power Removal and Bus Voltage Measurement

⚠ DANGER

HAZARD OF ELECTRIC SHOCK, EXPLOSION, OR ARC FLASH

Read and understand the precautions in “Before You Begin” starting on page 5 before performing this procedure.

Failure to follow these instructions will result in death or serious injury.

The DC bus voltage can exceed 1,000 Vdc. Use a properly rated voltage-sensing device when performing this procedure. To measure the DC bus voltage:

1. Disconnect all power.
2. Wait 15 minutes to allow the DC bus to discharge.
3. Measure the voltage of the DC bus between the PA/+ and PC/- terminals to ensure that the voltage is less than 42 Vdc. These terminals are clearly labeled on each drive.
4. If the DC bus capacitors do not discharge completely, contact your local Schneider Electric representative. Do not repair or operate the drive.

⚠ CAUTION

IMPROPER DRIVE OPERATION

- If the drive is not turned on for a long period, the performance of its electrolytic capacitors will be reduced.
- If the drive is stopped for a prolonged period, turn the drive on every two years for at least 5 hours to restore the performance of the capacitors, then check its operation.
- Do not connect the drive directly to line voltage. Increase the voltage gradually using an adjustable AC source.

Failure to follow these instructions can result in injury or equipment damage.

Discharging Stored Energy in Capacitors

⚠ DANGER

HAZARD OF ELECTRIC SHOCK, EXPLOSION, OR ARC FLASH

- When the controller is damaged, voltage may remain on certain energy storage capacitors after de-energization of the controller and discharge of the main capacitor bank.
- Before working on or near assemblies containing energy storage capacitors, verify that the capacitor voltages are less than 42 Vdc.
- The following assemblies have energy-storing capacitors:
 - Filter board
- Always check for the presence of voltage using a voltmeter set to the 1000 Vdc scale. When voltage is present, allow the voltmeter to discharge the capacitor's stored charge.

Failure to follow these instructions will result in death or serious injury.

Capacitors are used throughout the drives as energy storage devices. Some of the capacitors can store potentially lethal amounts of energy during normal controller operation.

When power is removed from an undamaged controller, the stored energy in these capacitors is automatically discharged to nonhazardous levels. However, the discharge mechanisms in a damaged controller may not be operating properly, and stored energy may be present on printed circuit boards.

Do not touch traces on printed circuit boards, such as the filter board, unless you have first checked for voltage with a voltmeter!

To discharge line filter board capacitors, use a voltmeter set to the 1000 Vdc scale. It will take approximately 6.6 minutes for a 10 megohm input impedance voltmeter to discharge a 10 microfarad capacitor from 700 V to less than 42 V. It will take approximately 40 seconds for a 1 megohm input impedance voltmeter to discharge a 10 microfarad capacitor from 700 V to less than 50 V.

⚠ DANGER

HAZARD OF ELECTRIC SHOCK, EXPLOSION, OR ARC FLASH

- Do not use a voltmeter to discharge stored energy on the DC bus capacitors.
- If the energy on the DC bus capacitors remains greater than 42 Vdc after 15 minutes, contact Product Support.

Failure to follow these instructions will result in death or serious injury.

Parts Identification

Figure 1: Plastic Kit

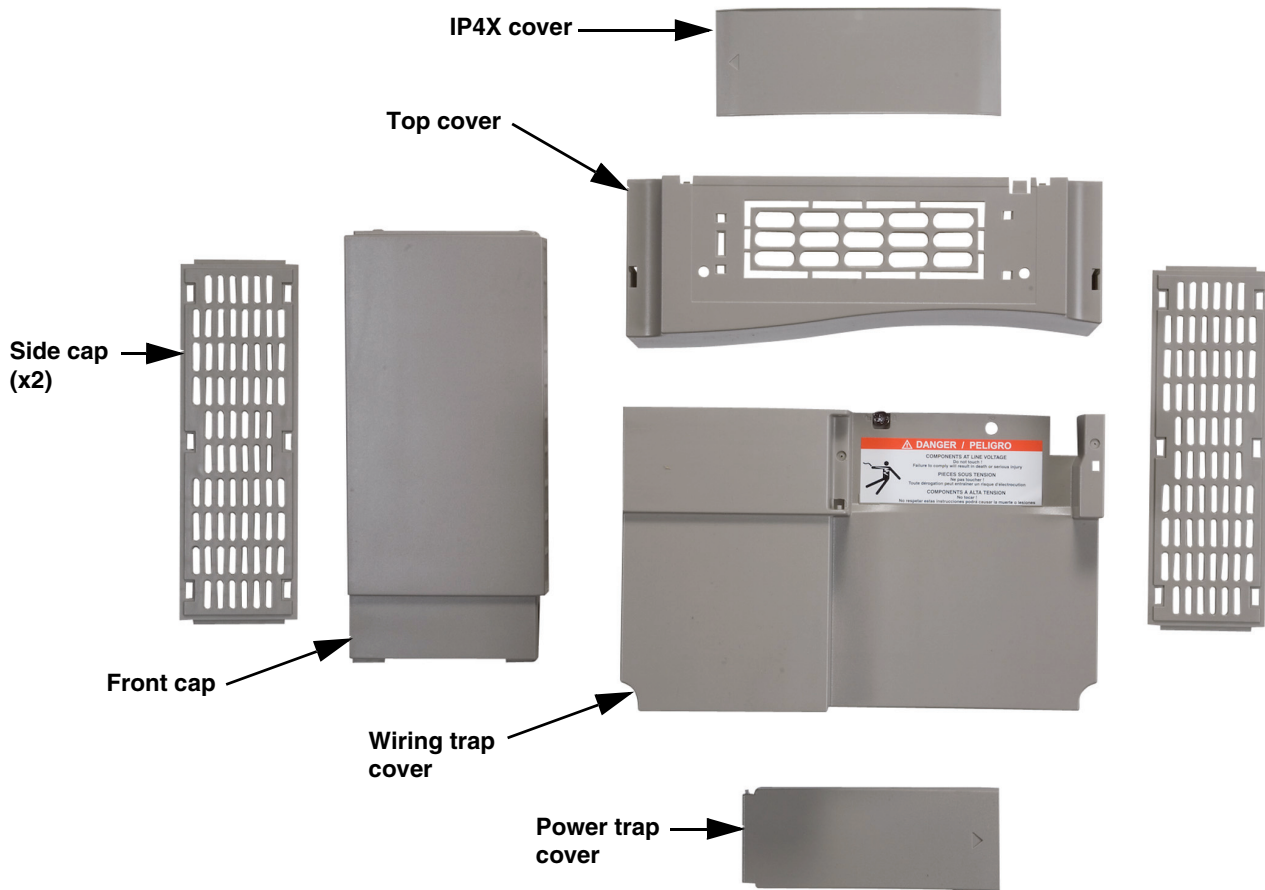

Figure 2: Power Terminal Block Kit

NOTE: The Power Terminal Block Kit is for frame size 5B only.



Replacing the Plastic Kit

IMPORTANT: Label and retain all removed hardware and cables for use in reassembly.

Remove/Replace the Power Trap Cover

⚠ DANGER

HAZARD OF ELECTRIC SHOCK, EXPLOSION, OR ARC FLASH

- Read and understand the precautions in “Before You Begin” starting on page 5 before performing this procedure.
- Before working on this equipment, turn off all power supplying it and perform the DC bus voltage measurement procedure on page 10.

Failure to follow these instructions will result in death or serious injury.

1. Open the power trap cover (see Figure 3) and unsnap it from the drive chassis at the left side.
NOTE: To assist with removal, a flathead screwdriver can be used to lift the bottom-left corner of the power trap cover.
2. If you are only replacing the power trap cover, discard the old piece and snap the new cover in place at the left side of the power trap opening. Close the power trap cover.

NEXT STEP: If you are also replacing the wiring trap cover, continue with Step 3 on page 14 before replacing the power trap cover.

Figure 3: Power Trap Cover (Frame Size 5B Shown)

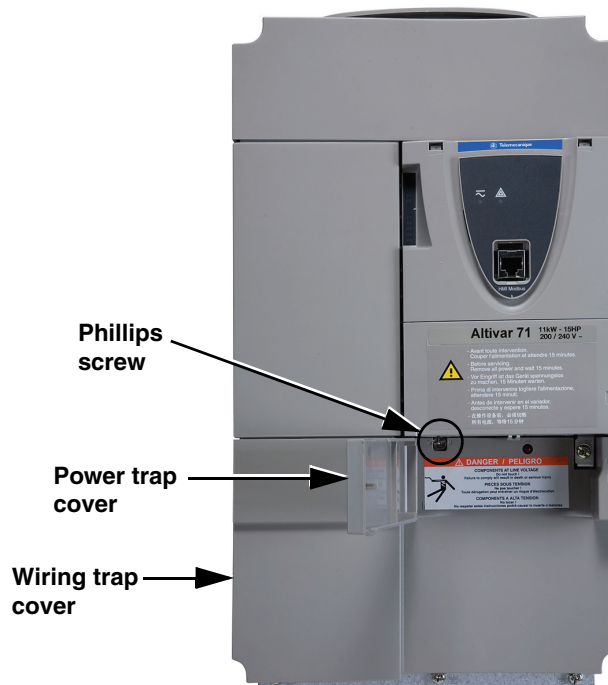

Remove/Replace the Wiring Trap Cover

3. With a 1/4 turn, loosen the size 2 Phillips screw (see Figure 3 on page 13) securing the wiring trap cover to the drive chassis, and remove the wiring trap cover.
4. If you are **only** replacing the wiring trap cover:
 - Remove the Phillips screw (see Figure 3 on page 13) from the old cover and install it in the new cover.
 - Position the new wiring trap cover over the drive chassis and secure it with the size 2 Phillips screw. Finger-tighten the screw 1/4 turn.
 - Replace and close the power trap cover. See “Remove/Replace the Power Trap Cover” on page 13.

NEXT STEP: If you are also replacing the front cap (see Figure 4), continue with Step 5 on page 15 before installing the power trap cover.

If you are replacing the power terminal block (see Figure 4), continue with “Replacing the Power Terminal Block” on page 18 before replacing the wiring trap cover.

Figure 4: Wiring Trap Cover Removed (Frame Size 5B Shown)

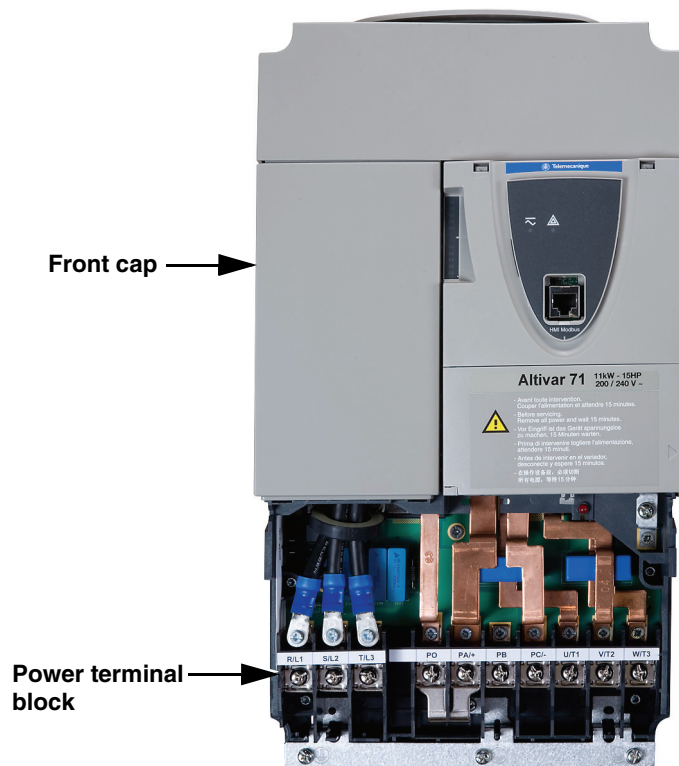

Remove/Replace the IP4X Cover and the Top Cover

5. The IP4X cover (see Figure 5) is attached to the top cover.
 - If you are **only** replacing the IP4X cover, snap the IP4X cover off of the top cover, install the new IP4X cover, and discard the old one.
 - If you are replacing the top cover, you do not need to remove the IP4X cover. Continue with Step 6.

Figure 5: IP4X Cover (Frame Size 5B Shown)

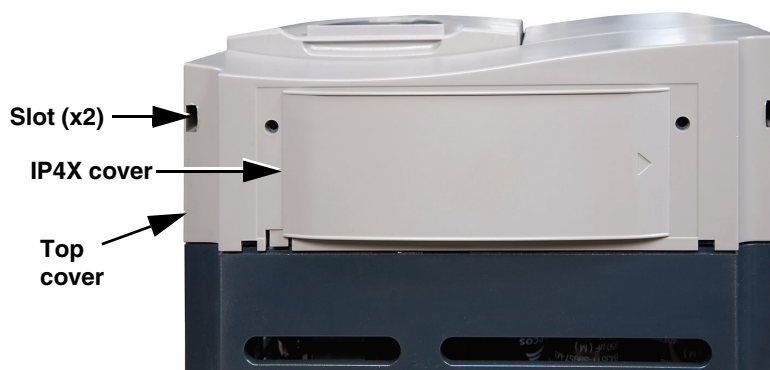

6. To remove the top cover, insert a flathead screw driver into the slots (see Figure 5) on each side of the cover, and push towards the outside of the drive until the snaps disengage.
7. If you are **only** replacing the top cover, discard the old top cover and snap the new one into place.

NEXT STEP: If you are also replacing the front cap, continue with Step 8 on page 16.

Remove/Replace the Front Cap

8. To remove the front cap:
 - **Frame sizes 5A and 5B:** push in on two snaps at the bottom of the front cap (see Figure 6) and disengage the cap from the chassis.
 - **Frame sizes 3 and 4:** only one snap secures the front cap to the chassis.

NOTE: A flathead screwdriver can be inserted at the bottom of the front cap to assist with removal.

 - **Frame size 2:** there is no front cap piece.
9. If you are **only** replacing the front cap:
 - Discard the old front cap and snap the new one into place.
 - Reinstall the top cover. See “Remove/Replace the IP4X Cover and the Top Cover” on page 15.

NEXT STEP: If you are also replacing the side caps, continue with Step 10 on page 17 before replacing the top cap.

Figure 6: Front Cap (Frame Size 5B Shown)



Remove/Replace the Side Caps

10. The drive has left and right side caps. To remove either side cap:
 - Slide the cap towards the top of the drive to disengage it, then remove it from the drive chassis.
 - Discard the old side cap and slide the new one into place.
 - Reinstall the top cap. See “Remove/Replace the IP4X Cover and the Top Cover” on page 15.

Figure 7: Side Cap (Frame Size 5B Shown)

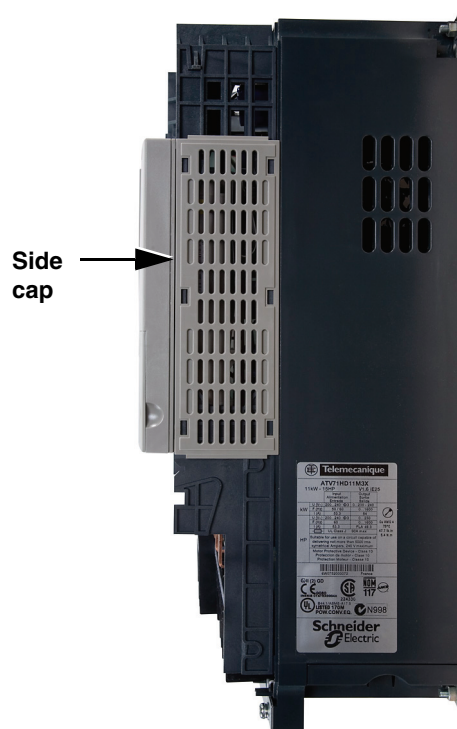

Replacing the Power Terminal Block

IMPORTANT: Label and retain all removed hardware and cables for use in reassembly.

⚠ DANGER

HAZARD OF ELECTRIC SHOCK, EXPLOSION, OR ARC FLASH

- Read and understand the precautions in “Before You Begin” starting on page 5 before performing this procedure.
- Before working on this equipment, turn off all power supplying it and perform the DC bus voltage measurement procedure on page 10.

Failure to follow these instructions will result in death or serious injury.

1. Remove the wiring trap cover. See “Remove/Replace the Wiring Trap Cover” on page 14.
2. Using a size 2 Phillips driver:
 - Remove three screws (**A**) securing the power wires to terminals R/L1, S/L2, and T/L3. See Figure 8.
 - Remove seven screws (**B**) securing the bus bars to the power terminal block. See Figure 8.

NOTE: Note the names and positions of the terminals for reinstallation.

Figure 8: Power Wires (Frame Size 5B)

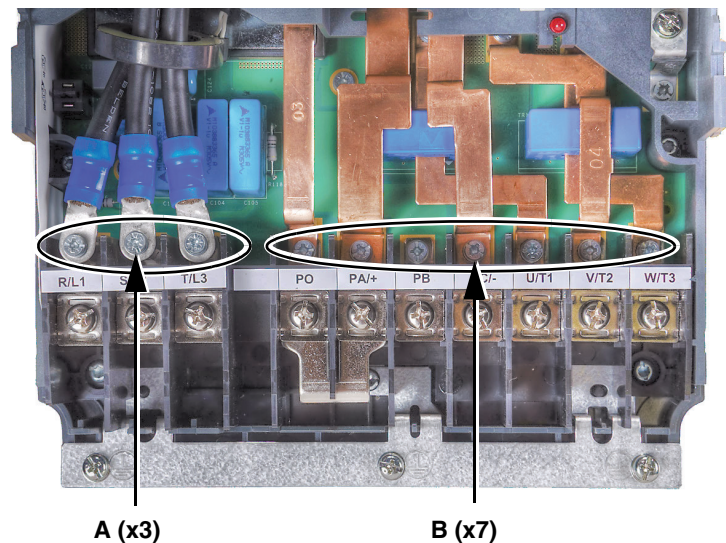

- Using a 7 mm socket wrench, remove three standoffs (C) from terminals R/L1, S/L2, and T/L3. See Figure 9.

Figure 9: Standoffs (Frame Size 5B)

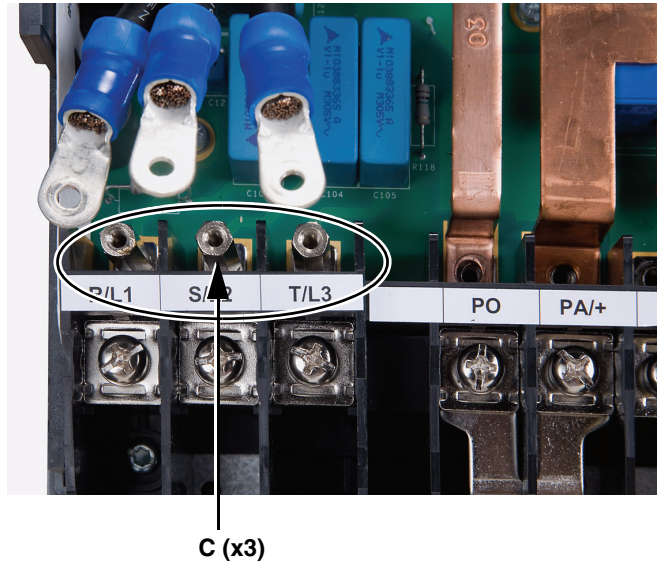

- Using a T-20 Torx driver, remove two screws (D) securing the left and right sides of the power terminal board to the drive chassis. See Figure 10.

Figure 10: Power Terminal Mounting Hardware (Frame Size 5B)

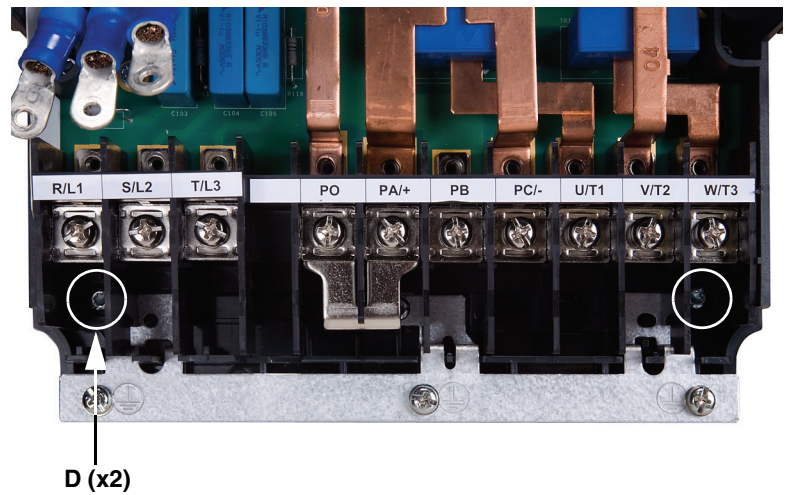

- Slide the power terminal block out from under the bus bars and remove it from the drive.
- Install the new power terminal block.
- Using a T-20 Torx driver, secure the power terminal block to the drive chassis with two screws (D, Figure 10). Tighten the screws to 1.1–1.7 N•m (9.7–15 lb-in).

8. Using a 7 mm socket wrench, install the standoffs at terminals R/L1, S/L2, and T/L3 (**C**, Figure 9 on page 19). Tighten the standoffs to 1.1–1.7 N•m (9.7–15 lb-in).
9. Using a size 2 Phillips driver:
 - Secure the power wires to terminals R/L1, S/L2, and T/L3 with three screws (**A**, Figure 8 on page 18). Tighten the screws to 1.1–1.7 N•m (9.7–15 lb-in).
 - Secure the bus bars to the power terminal block with seven screws (**B**, Figure 8 on page 18). Tighten the screws to 1.1–1.7 N•m (9.7–15 lb-in).
10. Reinstall the wiring trap cover. See “Remove/Replace the Wiring Trap Cover” on page 14.

**Plastic Kits and Power Terminal Kit for Altivar® 61/71 Drives, Frame Sizes 2–5
Instruction Bulletin**

Schneider Electric

8001 Knightdale Blvd.
Knightdale, NC 27545 USA
1-888-SquareD
(1-888-778-2733)
www.schneider-electric.us

Altivar® is a registered trademark of Schneider Electric. Other trademarks used herein are the property of their respective owners.

Electrical equipment should be installed, operated, serviced, and maintained only by qualified personnel. No responsibility is assumed by Schneider Electric for any consequences arising out of the use of this material.

30072-453-27 © 2009 Schneider Electric All Rights Reserved