

2

1

NOTES:

- 1. MATERIAL: ABS
- 2. ACCEPTS KEYSTONE STYLE INSERT
- 3. APPLICATIONS: DATA, VIDEO
- 4. UL LISTED
- 5. COLORS AVAILABLE: IVORY, BROWN, BLACK, ALMOND, LIGHT ALMOND ,WHITE
- 6. INSTALLATION HARDWARE INCLUDED

B

B

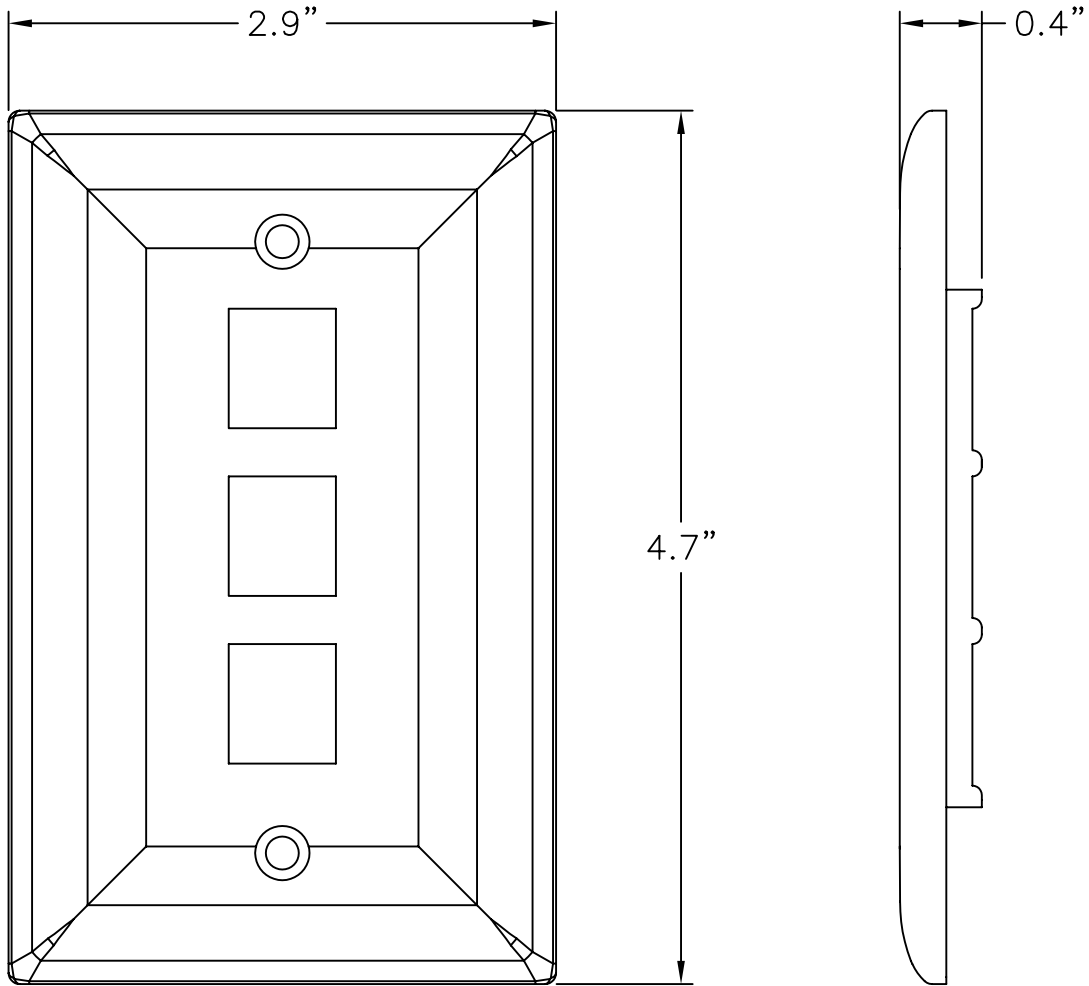

A

A

PROPRIETARY AND CONFIDENTIAL
 THE INFORMATION CONTAINED
 IN THIS DRAWING IS THE SOLE
 PROPERTY OF On-Q/LEGRAND.
 ANY REPRODUCTION IN PART OR
 AS A WHOLE WITHOUT THE WRITTEN
 PERMISSION OF On-Q/LEGRAND
 IS PROHIBITED. DRAWING IS SUBJECT
 TO CHANGE WITHOUT NOTICE.

on·Q

legrand

P.O. Box 60907
 Middletown, PA 17106-0907
 1-800-321-2343

TITLE:

**SINGLE GANG WALL PLATE
 3 PORT**

SIZE A	DWG NO WP3403	FILE NAME CD-WP3403	CUST REV 1
REVISED DATE 11/09/07	SCALE NONE	SHEET 1 OF 1	

2

1