



Modicon X80

The common offer of modules for
Modicon M580 and M340 PLCs/PACs



Modicon

Discover **Modicon**

Edge control for Industrial IoT

Modicon IIoT-native edge controllers manage complex interfaces across assets and devices or directly into the cloud, with embedded functional safety and cybersecurity. Modicon provides performance and scalability for a wide range of industrial applications up to high-performance multi-axis machines and high-available redundant processes.

Explore our offer

- **Modicon** HVAC Controllers
- **Modicon** PLC
- **Modicon** Motion Controllers
- **Modicon** PAC
- **Modicon** I/O
- **Modicon** Networking
- **Modicon** Power Supply
- **Modicon** Wiring
- **Modicon** Safety

Life Is On



Quick access to product information

Get technical information about your product

References

Modicon TM3
I/O expansion modules for Modicon controllers
Analog I/O modules

References	Output range	Resolution	Input terminal block (T) (terminal block)	Reference	Weight (kg)
2 voltage/current inputs	-10...+10 VDC 0...+10 VDC 0...20 mA / -20 mA	16 000 or 10 000 + sign	0 280.2	TM3A01	0.150
4 voltage/current inputs	-10...+10 VDC 0...+10 VDC 0...20 mA / -20 mA	12 000 or 11 000 + sign	0 280.2	TM3A02	0.200
4 voltage/current or temperature inputs (I, K, R, S, E, T, N, E, C)	Thermocouple (I, K, R, S, E, T, N, E, C) or temperature inputs (I, K, R, S, E, T, N, E, C) (PT100, PT1000) or -10...+10 VDC 0...20 mA / -20 mA	16 000 or 10 000 + sign	3 310.15	TM3A03	0.200
4 differential temperature inputs (I, K, R, S, E, T, N, E, C)	Thermocouple (I, K, R, S, E, T, N, E, C) or temperature inputs (I, K, R, S, E, T, N, E, C)	16 000 or 10 000 + sign	3 310.15	TM3A04	0.200
4 voltage/current	-10...+10 VDC	12 000 or	0 280.2	TM3A05	0.150

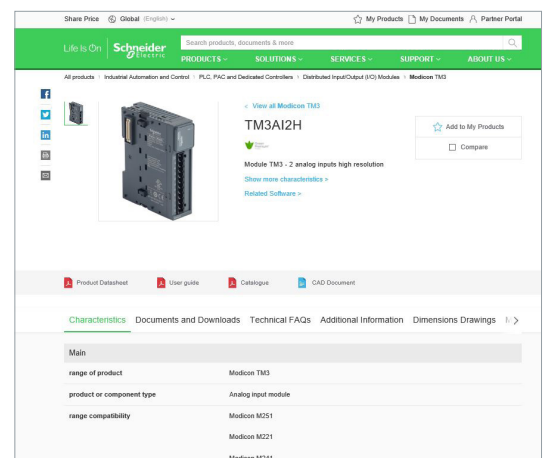

Each commercial reference presented in a catalog contains a hyperlink. Click on it to obtain the technical information of the product:

- Characteristics, Dimensions and drawings, Mounting and clearance, Connections and schemas, Performance curves
- Product image, Instruction sheet, User guide, Product certifications, End of life manual

Find your catalog

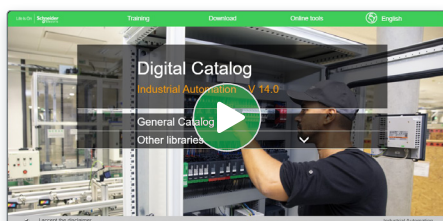

- > With just 3 clicks, you can access the Industrial Automation and Control catalogs, in both English and French
- > Consult digital automation catalogs at [Digi-Cat Online](#)

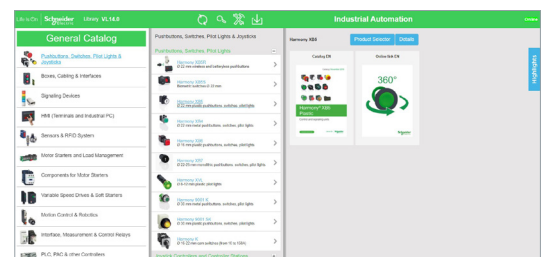

- Up-to-date catalogs
- Embedded product selectors, 360° pictures
- Optimized search by commercial references

Select your training



- > Find the right [Training](#) for your needs on our Global website
- > Locate the training center with the selector tool, using this [link](#)

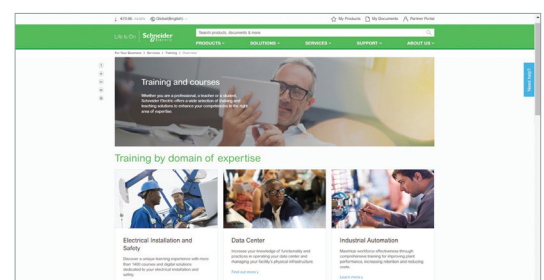

Life Is On

Schneider Electric

General contents

Modicon X80 offer presentation	1
Backplanes	2
Power supplies	3
I/O modules	4
Safety	5
Expert modules	6
I/O expansion modules	7
Communication modules	8
Dedicated parts for severe environments. . .	9
Standards and certifications, Services, Index	10

In this catalog, all instances of the word “safety” without precision must be understood as referring to “functional safety” according to IEC 61508 and IEC 61511.

Schneider Electric's IoT-enabled, plug-and-play, open, secure, interoperable architecture and platform, in Industries, Infrastructures, Data Centers, and Buildings.

Innovation at every level

EcoStruxure is based on a three-tiered technology stack delivering innovation at every level, from connected products to edge control and apps, analytics, and services.

Together with our hybrid segments approach, this enhances your value around safety, reliability, operational efficiency, sustainability, and connectivity across 6 domains of expertise:

- Power
- IT
- Building
- Machine
- Plant
- Grid

Dedicated architectures and IoT

We tailor our solutions in the form of dedicated reference architectures for plants:

- Management systems
- Power systems
- Data center systems
- Industrial plant and machine systems
- Smart grid systems

The Industrial Internet of Things (IIoT) gives an additional boost to technologies. That's why we provide our customers with an IoT-enabled architecture and platform offering simple, reliable, productive, and cost-efficient solutions.

Cybersecurity solutions

Robust cybersecurity protection is a must, and Schneider Electric's solutions can deliver it, regardless of business type or industry.

The vendor-agnostic services provided by our skilled professionals help to protect your entire critical infrastructure. We help to assess your risk, implement cyber-specific solutions, and maintain your onsite defenses over time, while integrating appropriate IT policies and requirements.

This is our difference and your advantage.

Enhanced safety

With the release of Modicon M580 Safety, Schneider Electric further expands the EcoStruxure platform.

This consolidates our position as one of the most trusted industrial safety vendor, with thousands of Modicon and Triconex safety systems protecting the most critical industrial processes globally.

EcoStruxure™ for Plant
Innovation At Every Level

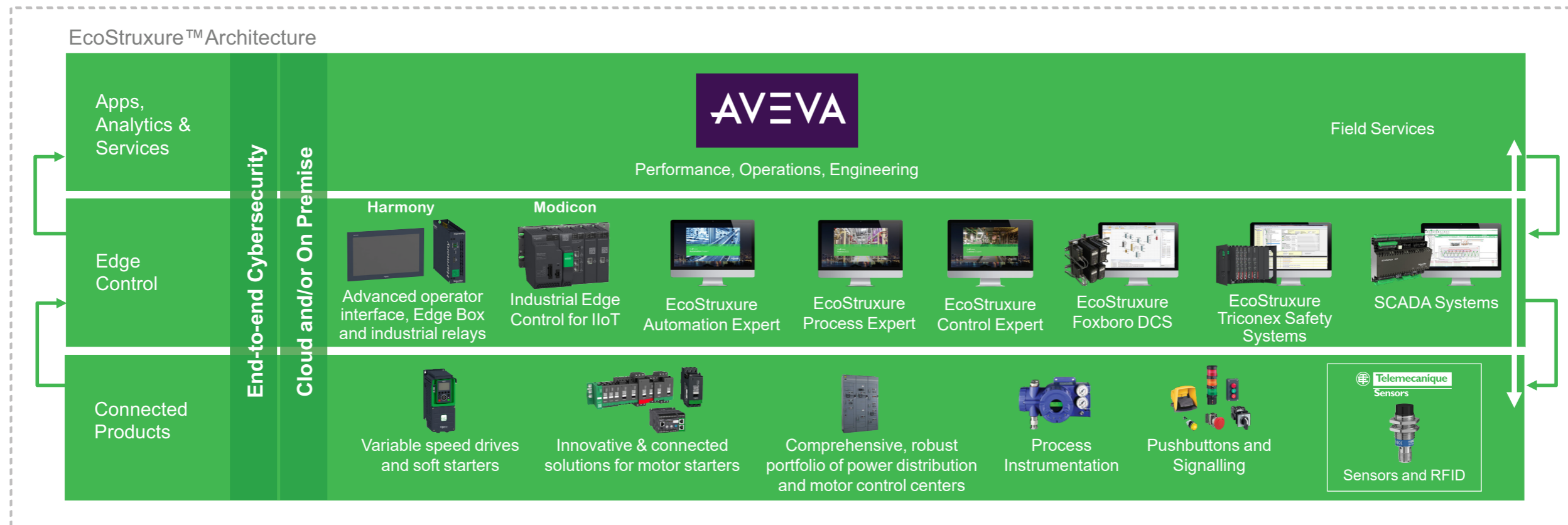

*The Schneider Electric industrial software business and AVEVA have merged to trade as AVEVA Group plc, a UK listed company. The Schneider Electric and Life is On trademarks are owned by Schneider Electric and are being licensed to AVEVA by Schneider Electric.

Modicon X80 offer presentation

- Overview [page 1/2](#)
- Composition [page 1/6](#)
- Description..... [page 1/7](#)
- Modicon PAC offer for plant automation..... [page 1/8](#)
- Product compatibility according to network architecture and platform [page 1/10](#)



Modicon X80 modules

Compact, robust, sustainable

1

Modicon X80 modules

Common in-rack modules for Modicon M580 and Modicon M340



Modicon X80 modules serve as the common in-rack I/O, expert, and communication modules for Modicon M580 and Modicon M340 PAC platforms. This range also includes power supplies, racks, and accessories common to both ranges.

A wide choice of modules is available to meet the needs of hybrid industries and critical infrastructures.

- > Modicon X80 modules can be used in remote racks with an I/O expansion module in Modicon M580 architectures. This forms a Modicon X80 RIO drop.
- > Modicon X80 modules can also be used in distributed architectures to build Modicon X80 DIO drops.

This single common offer helps customers to reduce their stocks of spare parts. It also decreases maintenance and training costs.

Modicon X80 in-rack I/O modules provide a high level of functionality, including features such as bit forcing, device DDT, and Change Configuration on the Fly, and are natively integrated into EcoStruxure Control Expert (1), the programming environment for Modicon M580 and Modicon M340.

Compact

- > Modicon X80 modules feature the latest I/O technology, making them extremely compact
- > They take up less space in the cabinet, with some modules having up to 64 discrete I/O
- > High density



Modicon X80 modules

Robust

- > Offering more than required by the standards

Characteristics	Modicon X80 modules	IEC standards Required by
Mechanical constraints	Levels reached	IEC 60068-2
Shock	30 g	> 15 g
Vibrations	3 g	> 1 g
Electrical immunity	Levels reached	IEC 61131-2
Radiated field	15 V/m	> 10 V/m
Electrostatic discharges by contact	6 kV	> 4 kV
Environmental immunity	Working values	IEC 61131-2
Temperature	0...60 °C/32... 140 °F	> 5...55 °C/41... 131 °F
Modicon X80 ruggedized offer	-25...70 °C/32... 158 °F	> 5...55 °C/41... 131 °F
Corrosive environments (coated versions)		Class Gx, 3C4, Kb, 3S4, 3B2

Sustainable

- > Common Modicon X80 modules reduce training and maintenance costs
- > Hot-swappable
- > Existing solutions for migrating from legacy I/O to Modicon X80 modules
- > Green Premium Eco Label

(1) EcoStruxure Control Expert software continues the Unity Pro range of software and corresponds to versions ≥ 14 of Unity Pro.

+ Common platform

Modicon M580 Safety

Regulatory requirements



Good practices dictate that control systems must be designed to keep process control functions separate and operationally independent from safety functions. This is usually achieved using a controller for the process and a separate system for safety.

Our solution to combine safety and process management in one application

Clear distinction between safety and process

- > Dual processing capability to control safety and process functions independently
- > Unifying independent plant safety and process control to help protect the entire operating environment
- > Minimized impact of standard process failure on plant safety, its people, and assets
- > No need to design, install, and maintain separate safety systems
- > Same tools, wiring methods, and I/O structures as Modicon M580 controller

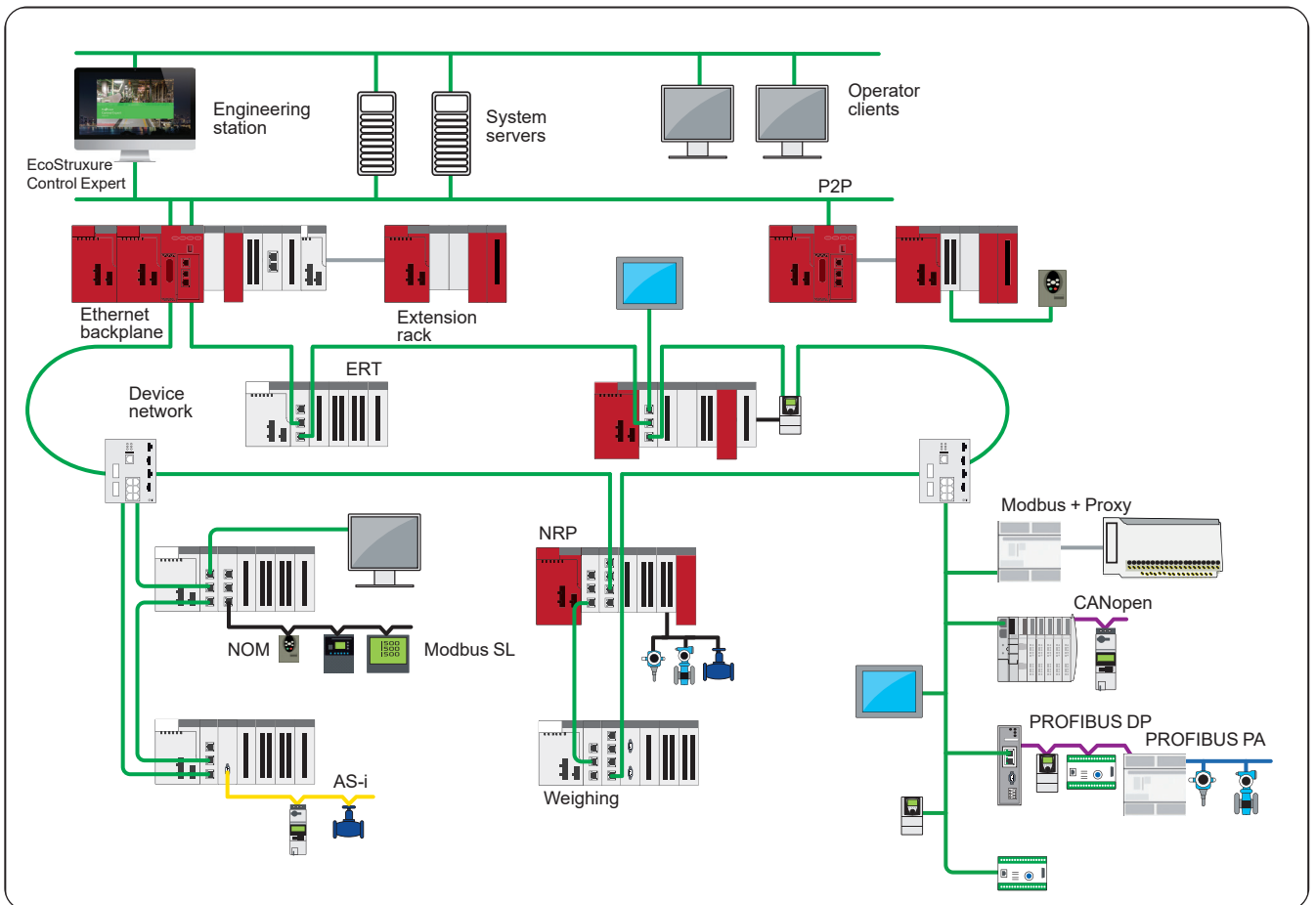

Typical common Safety architecture with Modicon M580 Safety

+ Combining standard process and safety in a single M580 project

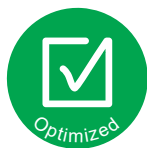

Certifications and standards

Depending on the model, Modicon X80 modules comply with the following standards:

- > International certifications: CE, UL, CSA, RCM, EAC, UKCA
- > Certified for Hazardous Location Class I Division 2 Groups ABCD and for ATEX/UKEX/IECEX zone 2/22 (depending on the model, see [pages 10/2 to 10/3](#))
- > Marine: IACS E10 and agencies: ABS, BV, DNV, GL, LR, RINA, RMRS, and CCS
- > Power generation market: IEC 61000-6-5, IEC 61850-3
- > See [pages 10/2 to 10/3](#) for more information.

International certifications



Marine



Hazardous locations



Functional safety





Market segments

> The Modicon PAC platforms (Modicon M340 and Modicon M580) supported by common Modicon X80 modules are suited to fulfill the requirements of the following vertical segments:



Water & waste water



Mining, minerals & metals



Consumer Packaged Goods



Oil & gas



Power generation



Discrete manufacturing



Transportation



Tunnels



Data centers



Presentation

Modicon X80 modules serve as the common in-rack I/O, expert, and communication modules for Modicon M580 and Modicon M340 PAC platforms (1). This range also includes power supplies, racks, and accessories common to both ranges.



Modicon M580 platform



Modicon M340 platform

Modicon X80 modules may also:

- Form part of a Modicon M580 Ethernet I/O architecture as an Ethernet RIO (EIO) drop with an X80 remote I/O drop adapter;



Modicon X80 RIO drop for Modicon M580 Ethernet I/O architecture

- Form an Ethernet Modbus/TCP DIO drop with an X80 peripheral remote I/O adapter.



Modicon X80 DIO drop

Modicon X80 modules are available in a single-rack or multi-rack configuration. One Modicon X80 RIO drop may support two racks separated by a cumulative distance of up to 30 m/98 ft.

These modules, common to several automation platforms, can help to reduce maintenance and training costs by offering:

- a single range of spare parts in stock
- training common to several PLCs

Based on the latest I/O technology, Modicon X80 modules offer:

- high-quality ruggedness and compactness
- compliance with international certifications (ATEX, IEC, etc.)
- a wide selection of modules: discrete or analog I/O modules, expert modules, communication modules, etc.

Bit forcing simplifies simulation and structured data simplifies diagnostics.

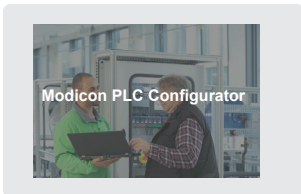

Click on the pictogram to access Modicon PLC Configurator online



All Modicon products are being changed from white to gray (in progress)

(1) See the compatibility guide on page 1/10.

Description

Modicon X80 modules

- 1 X-bus backplane with 4, 6, 8, or 12 slots or Dual X-bus and Ethernet backplane with 4, 8, or 12 slots for single power supply, or Dual X-bus and Ethernet backplane with 6 or 10 slots for power redundancy
- 2 AC or DC power supply modules
- 3 Discrete and analog I/O modules
- 4 RIO drop adapter



Typical basic assembly with Modicon X80 I/O modules

The Modicon X80 offer comprises:

- **X80 I/O modules**, including HART I/O
- **X80 expert modules** such as counter, motion control, SSI encoder, time-stamping, frequency input modules, and additional TPP (1) module for weighing
- **X80 communication modules** for AS-Interface, Modbus, CANopen, PROFIBUS DP communication, and additional devices such as fiber converter modules and an Ethernet network switch module
- **X80 I/O expansion modules**: Remote I/O drop and peripheral remote I/O drop adapters

Modicon M580 and Modicon M340 automation platforms also include specific communication modules that are described in the corresponding catalog:



[DIA6ED2151012EN](#)



[DIA6ED2110104EN](#)

Treatment for severe environments

In their ruggedized version, Modicon X80 modules may be used in harsh environments or within a range of operating temperatures from -25 to +70 °C/-13 to +158 °F (see [page 9/2](#)).

(1) Technology Partner Program

Modicon PAC offer for plant automation

Standard and severe environments*

1



> Modicon M580 ePAC (PLC)

Standard or Safety with standalone or redundant coprocessor



Communication modules

OPC UA, IEC 61850, IEC 101/104, DNP3, EtherNet/IP, Modbus/TCP



Communication modules

IEC 101/104, DNP3, EtherNet/IP, Modbus/TCP



> Modicon M340 PAC (PLC)

Standard or Performance
Modbus serial link, Modbus/TCP, or CANopen



* Most of Modicon products exist in hardened (H) or coated (C) versions to support severe environments

Configure with online tool:



Click on the pictogram to access Modicon PLC Configurator online

Pilot with EcoStruxure:



EcoStruxure
Innovation At Every Level



> Modicon X80 I/O modules

From 4 to 64 channels, discrete or analog (including temperature and HART), Standard and Safety

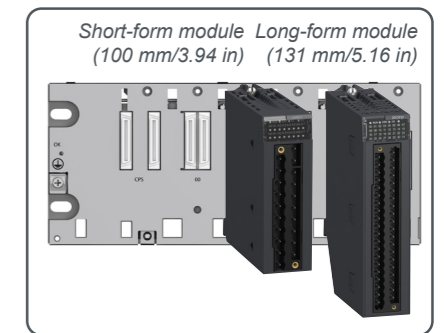

Backplanes

From 4 to 12 slots, single bus (X-bus) or dual bus (X-bus and Ethernet), for redundant or standalone power supply

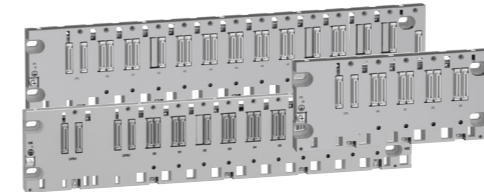

Power supplies

Standard or Safety, AC or DC, standalone or redundant



Communication modules

AS-i, Modbus/ASCII serial link, CANopen, PROFIBUS DP, fiber converter, Ethernet switch



Expert modules

Counter, time-stamping, motion control, frequency input, weighing, and diagnostics...



I/O expansion modules

Remote I/O adapter for Modicon M580



> Modicon Networking

Ethernet Switches
Managed or unmanaged



More technical information on www.se.com



More technical information on www.se.com

Modicon M580/M340 platforms and Modicon X80 modules

Product compatibility according to network architecture and platform

For safety product compatibility, please refer to [page 5/4](#)

Product type	Product main feature	Commercial reference (1)	Module type	Modicon M340	Modicon M580				Modicon X80 drops on Ethernet remote I/O			Modicon M580/M340
					Local rack with CPU				Standalone or redundant CPU			Modicon X80 drops on distributed I/O
					Standalone CPU		Redundant CPU		Standalone or redundant CPU			N/A
					X-bus backplane (2) BMXXBP●●●●	Dual X-bus and Ethernet backplane BMEXBP●●●●	X-bus backplane (2) BMXXBP●●●●	Dual X-bus and Ethernet backplane BMEXBP●●●●	X-bus backplane (2) BMXXBP●●●●	Dual X-bus and Ethernet backplane BMEXBP●●●●	X-bus backplane BMXXBP●●●●, Dual X-bus and Ethernet backplane BMEXBP●●●●	
				BMXCRA31200	BMXCRA31210	BMECRA31210	BMXPRA0100					
Modicon X80 power supplies	Standalone power supply	BMXCPS2000	100...240 V ~, 20 W									
		BMXCPS2010	24 V ~, 17 W									
		BMXCPS3020 (H)	24...48 V ~, 32 W									
		BMXCPS3500 (H)	100...240 V ~, 36 W									
		BMXCPS3540T	125 V ~, 36 W									
	Redundant power supply	BMXCPS4002 (H)	100...240 V ~, 40 W									
BMXCPS4022 (H)		24...48 V ~, 40 W										
BMXCPS3522 (H)		125 V ~, 40 W										
Modicon X80 backplanes	X-bus backplane	BMXXBP0400 (H)	4 slots									
		BMXXBP0600 (H)	6 slots									
		BMXXBP0800 (H)	8 slots									
		BMXXBP1200 (H)	12 slots									
	Dual X-bus and Ethernet backplane	BMEXBP0400 (H)	4 slots									
		BMEXBP0800 (H)	8 slots									
		BMEXBP1200 (H)	12 slots									
	Dual X-bus and Ethernet backplane with power redundancy	BMEXBP0602 (H) (3)	6 slots									
		BMEXBP1002 (H) (3)	10 slots									
	Rack expansion	BMXXBE1000 (H) (4)	Expansion module									
		BMXXBE2005 (5)	Expansion kit									
	Accessories	BMXXEM010 (6)	Protective cover									
Modicon X80 discrete modules	Discrete input AC	BMXDAI0805	8 inputs, 200...240 V~									
		BMXDAI0814	8 inputs, 100...120 V~									
		BMXDAI1602 (H)	16 inputs, 24 V~/~									
		BMXDAI1603 (H)	16 inputs, 48 V~									
		BMXDAI1604 (H)	16 inputs, 100...120 V~									
		BMXDAI1614 (H)	16 inputs, 100...120 V~									
		BMXDAI16142	16 inputs, 100...120 V~									
		BMXDAI1615 (H)	16 inputs, 200...240 V~									
	Discrete output AC	BMXDAO1605 (H)	16 outputs, 100...240 V~									
		BMXDAO1615 (H)	16 outputs, 24...240 V~									
	Discrete input DC	BMXDDI1602 (H)	16 inputs, 24 V ~									
		BMXDDI1603 (H)	16 inputs, 48 V ~									
		BMXDDI1604T	16 inputs, 125 V ~									
		BMXDDI3202K (H)	32 inputs, 24 V ~									
		BMXDDI3203 (H)	32 inputs, 48 V ~									
		BMXDDI3232 (H)	32 inputs, 12/24 V ~									
		BMXDDI6402K (H)	64 inputs, 24 V ~									
		BMXDDM16022 (H)	8 inputs, 24 V ~; 8 outputs, 24 V ~									
	Discrete mixed I/O	BMXDDM16025 (H)	8 inputs, 24 V ~; 8 outputs, relay 24...240 V~/24 V ~									
		BMXDDM3202K	16 inputs, 24 V ~; 16 outputs, 24 V ~									
		BMXDDO1602 (H)	16 outputs, 24 V ~									
	Discrete output DC	BMXDDO1612 (H)	16 outputs, 24 V ~ negative									
		BMXDDO3202 (H)	32 outputs, 24 V ~									
		BMXDDO3202K (C)	32 outputs, 24 V ~									
		BMXDDO6402K (C)	64 outputs, 24 V ~									
	Discrete Output Relay	BMXDRA0804T	8 outputs, 100...150 V~									
		BMXDRA0815 (H)	8 outputs, 24...240 V~/24...125 V ~									
		BMXDRA1605 (H)	16 outputs, 24...240 V~/24 V ~									
		BMXDRC0805 (H)	8 outputs, 24...240 V~/24...125 V ~									

(1) Optional versions: (C) - "Coated", (H) - "Hardened", and (T) - "Extended Temperature"
 (2) BMXXBP●●●● with PV02 or later required
 (3) Not compatible with single power supplies

Not compatible Compatible

(4) Extended rack can be on any type of backplane, but only X-bus modules (BMX) can be used
 (5) Extended rack kit
 (6) Protective cover for unoccupied slots on backplane

Modicon M580/M340 platforms and Modicon X80 modules

Product compatibility according to network architecture and platform

For safety product compatibility, please refer to [page 5/4](#)

Product type	Product main feature	Commercial reference (1)	Module type	Modicon M340	Modicon M580				Modicon X80 drops on Ethernet remote I/O			Modicon M580/M340
					Local rack with CPU				Modicon X80 drops on distributed I/O			Modicon X80 drops on distributed I/O
					Standalone CPU		Redundant CPU		Standalone or redundant CPU			N/A
					X-bus backplane (2) BMXXBP●●●●	Dual X-bus and Ethernet backplane BMEXBP●●●●	X-bus backplane (2) BMXXBP●●●●	Dual X-bus and Ethernet backplane BMEXBP●●●●	X-bus backplane (2) BMXXBP●●●●		Dual X-bus and Ethernet backplane BMEXBP●●●●	X-bus backplane BMXXBP●●●●, Dual X-bus and Ethernet backplane BMEXBP●●●●
				BMXCRA31200	BMXCRA31210	BMECRA31210	BMXPRA0100					
Modicon X80 analog modules	Analog High-level Input	BMXAMI0410 (H)	4 voltage/current inputs									
		BMXAMI0800	8 voltage/current inputs									
		BMXAMI0810 (H)	8 voltage/current inputs									
		BMEAHI0812 (H)	8 current inputs, HART									
	Analog Low-level Input	BMXART0414 (H)	4 RTD, thermocouple and voltage inputs									
		BMXART0814 (H)	8 RTD, thermocouple and voltage inputs									
	Analog Mixed I/O	BMXAMM0600 (H)	4 voltage/current inputs & 2 voltage/current outputs									
	Analog High-level Output	BMXAMO0210 (H)	2 voltage/current outputs									
		BMXAMO0410 (H)	4 voltage/current outputs									
		BMXAMO0802 (H)	8 current outputs									
		BMEAHO0412 (C)	4 current outputs, HART									
	Modicon X80 Expert modules	SSI encoder interface	BMXEAE0300 (H)	3 channels								
Counter		BMXEHC0200 (H)	2 channels									
		BMXEHC0800 (H)	8 channels									
Time Stamping		BMXERT1604T/H	16 inputs, 24...125 V ~									
Motion Control		BMXMSP0200	2 channels									
Frequency Input		BMXETM0200H	2 channels									
Weighing (3)	PMESWT0100	1 channel										
Communication modules (4)	Modicon X80	BMXNOM0200 (H)	Serial link									
		BMXEIA0100	AS-Interface									
		BMECXM0100 (H)	CANopen									
		BMXNRP0200 (C)	Fiber converter, multimode									
		BMXNRP0201 (C)	Fiber converter, single mode									
		PMEPXM0100 (H)	PROFIBUS DP									
		BMENOS0300 (C)	Ethernet switch									
		Modicon M580	BMENOC0301 (C)	Ethernet								
			BMENOC0311 (C)	Ethernet FactoryCast								
	BMENOC0321 (C)		Ethernet control router									
	BMENOP0300		IEC 61850									
	BMXNGD0100		Ethernet Global Data									
	BMENUA0100 (H)		OPC UA									
	Modicon M580/M340	BMENOR2200H	Advanced RTU									
		Modicon M340	BMXNOR0200H	RTU								
			BMXNOE0100 (H)	Ethernet								
	Modicon X80 I/O expansion modules	RIO drop adapter	BMXCRA31200	X-bus, Standard								
			BMXCRA31210 (C)	X-bus, Performance								
BMECRA31210 (C)			Ethernet, Performance									
DIO drop adapter		BMXPRA0100	Peripheral									

(1) Optional versions: (C) - "Coated", (H) - "Hardened", and (T) - "Extended Temperature"

(2) BMXXBP●●●● with PV02 or later required

(3) Products by our Technology Partners; see more information on our [partner website page](#)

(4) According to the module type, the communication module description is included in the Modicon X80 catalog, Modicon M580 catalog, or Modicon M340 catalog.

Not compatible Compatible Only compatible in the standalone configuration of remote Modicon X80 drop

Single-rack configuration

- [Presentation..... page 2/2](#)
- [X-bus backplanes page 2/3](#)
- [Dual X-bus and Ethernet backplanes page 2/4](#)
- [Dual X-bus and Ethernet backplanes with power redundancy page 2/5](#)
- [Accessories for single-rack configuration page 2/6](#)

Multi-rack configuration

- [Presentation, description page 2/7](#)
- [Accessories, references page 2/10](#)





Click on the pictogram to access Modicon PLC Configurator online

Presentation

The Modicon X80 offer includes three types of backplane compatible with Modicon automation products:

- X-bus backplanes (**BMXXBP●●●●**) (1), with X-bus functionality, conforming to the legacy implementation and specification
- Dual X-bus and Ethernet backplanes (**BMEXBP●●00**), with Ethernet connectivity to some slots on the backplane
- Dual X-bus and Ethernet backplanes with power redundancy (**BMEXBP●●02**), thanks to an additional power supply slot

Please refer to the product compatibility table ([page 1/10](#)) for more information on possible combinations with Modicon X80 modules.

All backplanes are available in both standard and ruggedized format for severe environments (see [page 9/2](#) for severe environment products).

X-bus backplane functionalities

BMXXBP●●00 backplanes are basic elements in Modicon M580 single-rack and multi-rack configurations, equipped with 4, 6, 8, or 12 slots. They perform the following functions:

- They assign a backplane number to X-bus slots.
- Mechanical function: They are used to install modules in a PLC station (power supply, processor, discrete, analog, and application-specific I/O). These backplanes can be mounted on a panel or a mounting plate, inside enclosures, on machine frames, etc.
- Electrical function: The backplanes incorporate X-bus (proprietary bus). They are used to:
 - Distribute the power supply required for each module in the same rack
 - Distribute data and service signals for the entire PLC station
 - Hot swap modules during operation

Dual X-bus and Ethernet backplane functionalities

BMEXBP●●●● backplanes provide electrical and mechanical functions for installing modules in a PLC station (power supply, processor, discrete, analog, and application-specific I/O), and feature additional functions:

- **BMEXBP●●00** backplanes provide specific services to X-bus slots:
 - Assign a backplane number
 - Supply the interconnection for the slots in the main and extended backplanes
- **BMEXBP●●02** are backplanes with power redundancy with two CPS slots for two redundant power supplies. They feature:
 - Compatibility only with redundant power supplies
 - Security of power supply in high-availability applications

The Ethernet interface is the main communication medium in the Ethernet backplane. The Ethernet modules on the Ethernet backplane are attached to one of several ports and they connect to the Ethernet switch chip embedded in the Ethernet backplane.

The Ethernet backplanes provide the following services to Ethernet slots:

- Ethernet connection
- Point-to-point connection

(1) Mandatory PV02 version or later.

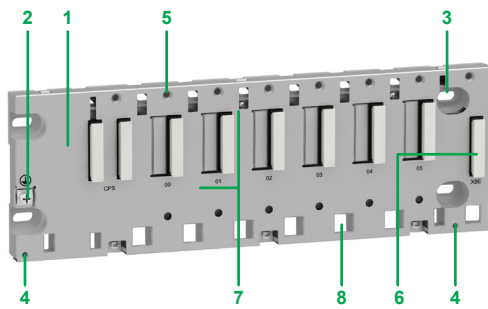

BMXXBP0600 backplane with 6 slots

X-bus backplanes

Description

BMXXBP●●00 backplanes are available in 4-, 6-, 8- or 12-slot versions and comprise:

- 1 A metal frame that:
 - Holds the X-bus electronic card and helps it withstand EMI and ESD type interference
 - Holds the modules
 - Gives the rack mechanical rigidity
- 2 A ground terminal for grounding the rack
- 3 4 holes (big enough for M6 screws) for mounting the backplane on a frame
- 4 2 fixing points for the shielding connection bar
- 5 Tapped holes to take the locking screw on each module
- 6 A connector for a rack expansion module, marked **XBE**
- 7 40-way female ½ DIN connectors forming the electrical connection between the backplane and each module, marked **CPS, 00...15** (the backplane is delivered with each connector protected by a cover, which needs to be removed before inserting the module)
- 8 Slots for anchoring the module pins

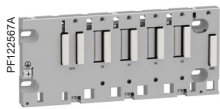

BMXXBP0400

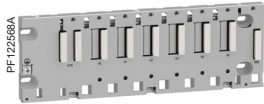

BMXXBP0600

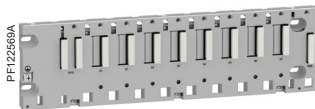

BMXXBP0800

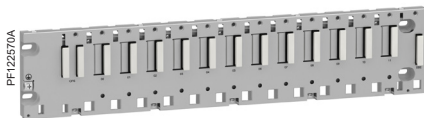

BMXXBP1200

References

Description	Type of module to be inserted	No. of slots (1)	Power consumption (2)	Reference	Weight kg/lb
X-bus backplanes	BMXCPS power supply,	4	1.12 W	BMXXBP0400	0.630/ 1.389
	BMXP34 or BMEP58 processor,	6	1.68 W	BMXXBP0600	0.790/ 1.742
	I/O modules, communication modules and application-specific modules (counter, motion control, and serial)	8	PV<0.3: 2.21 W PV≥0.3: 0.13 W	BMXXBP0800	0.950/ 2.094
		12	0.17 W	BMXXBP1200	1.270/ 2.780

(1) Number of slots taking the processor, I/O modules, communication modules, and application-specific modules (excluding power supply)

(2) Including power consumption of anti-condensation resistor(s) for 4-, 6-, and 8-slot backplanes

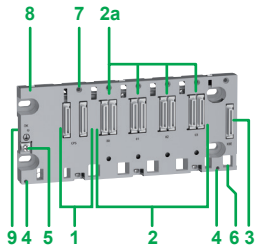

BMEXBP0400 backplane

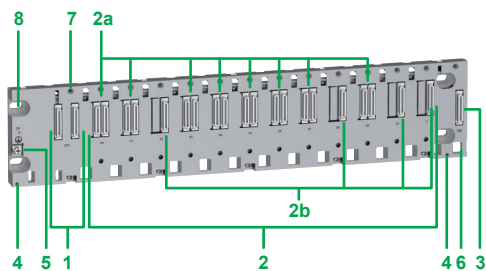

BMEXBP1200 backplane

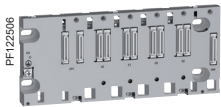

BMEXBP0400

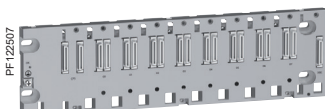

BMEXBP0800

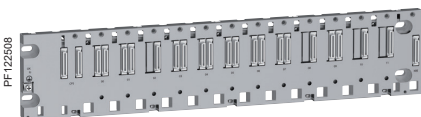

BMEXBP1200

Dual X-bus and Ethernet backplanes (1) (2)

Description

The number of X-bus and Ethernet slots found on a backplane depends on the backplane size.

BMEXBP0400/BMEXBP0800 are 4- or 8-slot dual X-bus and Ethernet backplanes with:

- 1 CPS slot for power supply
- 2 4 slots (**BMEXBP0400**) or 8 slots (**BMEXBP0800**) with:
 - 2a 4 or 8 X-bus and Ethernet connectors for X-bus or Ethernet modules (3)
 - 3 Extension: 1 connector for an X-bus rack expansion
 - 4 2 fixing points for the shielding connection bar
 - 5 Protective ground screw
 - 6 Slots for anchoring the module pin
 - 7 Tapped holes for the locking screw on each module
 - 8 4 holes for M4, M5, M6, or UNC #6-32 screws (4.32 mm to 6.35 mm/0.17 to 0.25 in.)
 - 9 The backplane is fastened to 35 mm/1.38 in. wide and 15 mm/0.59 in. deep DIN rails. Mounting on a 35 mm/1.38 in. wide and 7.5 mm/0.295 in. deep DIN rail is also possible (in this case, the product withstands less mechanical stress).

BMEXBP1200 is a 12-slot dual X-bus and Ethernet backplane with:

- 1 CPS slot for power supply
- 2 12 slots with:
 - 2a 8 X-bus and Ethernet connectors for X-bus or Ethernet modules (3)
 - 2b 4 X-bus connectors for X-bus modules
 - 3 Extension: 1 connector for an X-bus rack expansion
 - 4 2 fixing points for the shielding connection bar
 - 5 Protective ground screw
 - 6 Slots for anchoring the module pin
 - 7 Tapped holes for the locking screw on each module
 - 8 4 holes for M4, M5, M6, or UNC #6-32 screws (4.32 mm to 6.35 mm/0.17 to 0.25 in.)

References

Description	Type of module to be inserted	Ethernet connectors	X-bus connectors	Power consumption (4)	Reference	Weight kg/lb
4-slot (5) X-bus and Ethernet backplane	BMXCPS power supply, BMEP58/BMEH58 processor, I/O modules, communication modules, and application-specific modules (counter, motion control, and serial)	4	4	2.99 W	BMEXBP0400	0.719/1.500
8-slot (5) X-bus and Ethernet backplane		8	8	4.15 W	BMEXBP0800	1.064/2.350
12-slot (5) X-bus and Ethernet backplane		8	12	4.22 W	BMEXBP1200	1.398/3.080

(1) In a Modicon M580 architecture, Ethernet backplanes can be used for Ethernet RIO drop (EIO) and for expansion racks. Only the X-bus is extended across expansion racks connected in a daisy chain. Modules that require connection to the Ethernet bus do not operate when installed in expansion racks (refer to compatibility table page 1/10).

(2) For multi-rack configuration, see page 2/7.

(3) Modules supporting both X-bus and Ethernet. All Modicon X80 I/O modules are X-bus modules, except for HART modules. See compatibility table for more details (page 1/10).

(4) Including power consumption of anti-condensation resistor(s).

(5) Maximum number of slots for modules excluding power supply and rack expansion modules.

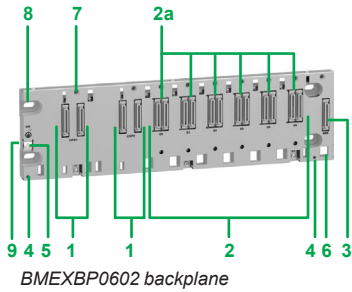

BMEXBP0602 backplane

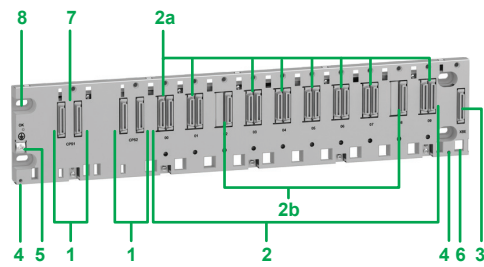

BMEXBP1002 backplane

Dual X-bus and Ethernet backplanes with power redundancy (1) (2)

Description

BMEXBP0602 is a 6-slot dual X-bus and Ethernet backplane with:

- 1 2 CPS slots for **BMXCPS●●●2** redundant power supply only
- 2 6 slots with:
- 2a 6 X-bus and Ethernet connectors for X-bus or Ethernet modules (3)
- 3 Extension: 1 connector for an X-bus rack expansion
- 4 2 fixing points for the shielding connection bar
- 5 Protective ground screw
- 6 Slots for anchoring the module pin
- 7 Tapped holes for the locking screw on each module
- 8 4 holes for M4, M5, M6, or UNC #6-32 screws (4.32 to 6.35 mm/0.17 to 0.25 in.)
- 9 The backplane is fastened to 35 mm/1.38 in. wide and 15 mm/0.59 in. deep DIN rails. Mounting on a 35 mm/1.38 in. wide and 7.5 mm/0.295 in. deep DIN rail is also possible (in this case, the product withstands less mechanical stress).

BMEXBP1002 is a 10-slot dual X-bus and Ethernet backplane with:

- 1 2 CPS slots for **BMXCPS●●●2** redundant power supply only
- 2 10 slots with:
- 2a 8 X-bus and Ethernet connectors for X-bus or Ethernet modules (3)
- 2b 2 X-bus connectors for X-bus modules
- 3 Extension: 1 connector for an X-bus rack expansion
- 4 2 fixing points for the shielding connection bar
- 5 Protective ground screw
- 6 Slots for anchoring the module pin
- 7 Tapped holes for the locking screw on each module
- 8 4 holes for M4, M5, M6, or UNC #6-32 screws (4.32 to 6.35 mm/0.17 to 0.25 in.)

References

Description	Type of module to be inserted	Ethernet connectors	X-bus connectors	Power consumption (4)	Reference	Weight kg/lb
6-slot (5) dual X-bus and Ethernet backplane with power redundancy	BMXCPS●●●2 with power redundancy, BMEP58/BMEH58 processor, I/O modules, communication modules and application-specific modules (counter, motion control, and serial)	6	6	4.15 W	BMEXBP0602	1.02/2.249
10-slot (5) dual X-bus and Ethernet backplane with power redundancy		8	10	4.22 W	BMEXBP1002	1.377/3.036

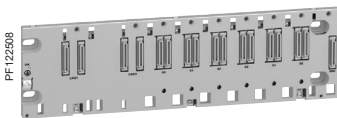

BMEXBP0602

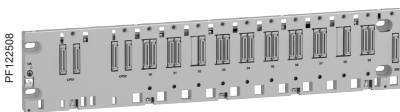

BMEXBP1002

(1) In a Modicon M580 architecture, Ethernet backplanes can be used for Ethernet RIO drop (EIO) and for expansion racks. Only the X-bus is extended across expansion racks connected in a daisy chain. Modules that require connection to the Ethernet bus do not operate when installed in expansion racks (refer to compatibility table page 1/10).

(2) For multi-rack configuration, see page 2/7.

(3) Modules supporting both X-bus and Ethernet. All Modicon X80 I/O modules are X-bus modules, except for HART modules. See compatibility table for more details (page 1/10).

(4) Including power consumption of anti-condensation resistor(s).

(5) Maximum number of slots for modules excluding power supply and rack expansion modules.

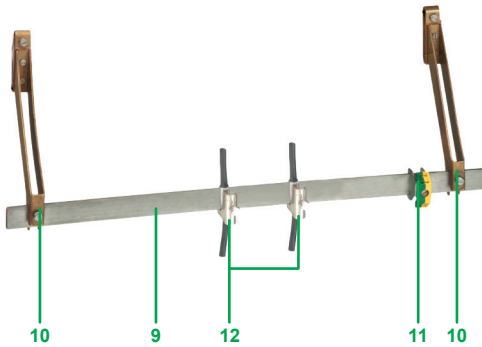

BMXXSP cable shielding connection kit

Description

Cable shielding connection kit

To be ordered separately:

A **BMXXSP** cable shielding connection kit, used to help protect against electrostatic discharge when connecting the shielding on cordsets for connecting:

- Analog, counter, and motion control modules
- A Harmony HMI to the processor

The **BMXXSP** shielding system comprises:

- 9 A metal bar that takes the clamping rings and the grounding terminal
- 10 Two sub-bases to be mounted on the rack
- 11 A grounding terminal (not included)
- 12 Not included in the shielding connection kit, the **STBXSP30** clamping rings (sold in lots of 10, cross-section 1.5...6 mm²/16...10 AWG or 5...11 mm²/10...7 AWG)

Accessories

Description	For use with	Reference	Weight kg/lb
Shielding connection kits comprising: - 1 metal bar - 2 support sub-bases	BM XBP0400 backplanes	BMXXSP0400	0.280/ 0.617
	BM XXBP0600 backplane	BMXXSP0600	0.310/ 0.683
	BM XBP0800 backplanes BM EXBP0602 backplane	BMXXSP0800	0.340/ 0.750
	BM XBP1200 backplanes BM EXBP1002 backplane	BMXXSP1200	0.400/ 0.882
Spring clamping rings Sold in lots of 10	Cables, cross-section 1.5...6 mm ² /16...10 AWG	STBXSP3010	0.050/ 0.110
	Cables, cross-section 5...11 mm ² /10...7 AWG	STBXSP3020	0.070/ 0.154
Protective covers (replacement parts) Sold in lots of 5	Unoccupied slots on BM XBP backplanes	BMXXEM010	0.005/ 0.011



BMXXSP + STBXSP30

(1) The grounding terminal is not included in the shielding connection kits.

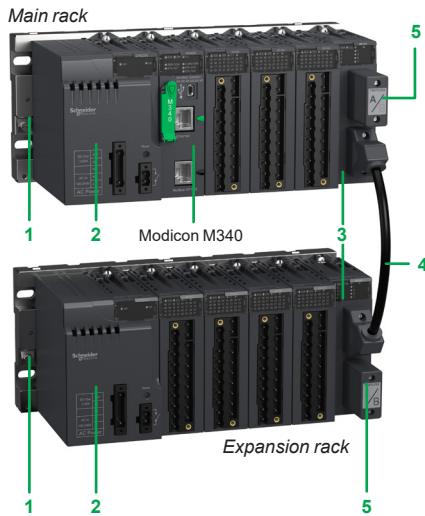

Station with Modicon M340 in main rack + expansion rack

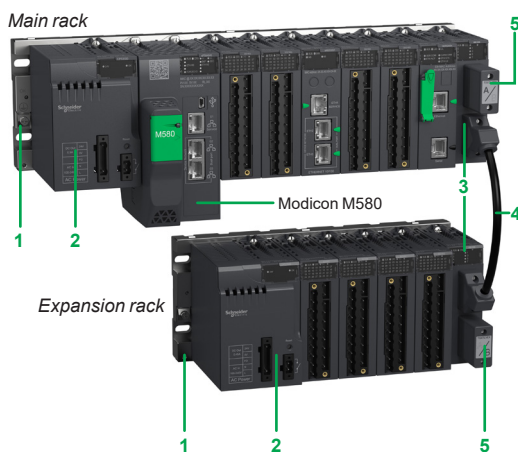

Station with Modicon M580 in main rack + expansion rack

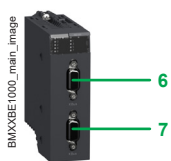

BMXXBE1000 rack expansion module featuring two 9-way SUB-D connectors

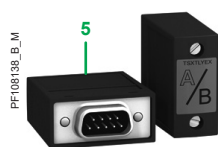

TSXTLYEX line terminator

Composition of a multi-rack configuration

Multi-rack configurations are composed of one main rack, including a processor, and expansion racks, the number of which depends on the CPU performance level:

- One expansion rack maximum for a station with a **BMXP341000** processor
- Three expansion racks maximum for a station with a **BMXP342000** processor
- Three expansion racks maximum for a station with a **BMEP581020** or **BMEP582000** processor
- Seven expansion racks maximum for a station with a **BMEP583000**, **BMEP584000**, **BMEP585040**, or **BMEP586040** processor

Each rack is equipped with:

- 1 A **BM●XBP●●●●** backplane (1)
- 2 A **BMXCPS●●●●0** power supply or two **BMXCPS●●●●2** redundant power supplies (2)
- 3 A **BMXXBE1000** rack expansion module. This module, inserted in the right-hand end of the rack (**XBE** slot, see page 2/3, element 6) does not occupy backplane slots 00...15 (4, 6, 8, or 12 slots are still available).
- 4 A **BMXXBC●●●0K** X-bus extension cordset to connect the **BMXXBE1000** rack expansion modules
- 5 A **TSXTLYEX** line terminator on the unused 9-way SUB-D connector 6 or 7

Configuration with X-bus racks

In a multi-rack configuration, the racks distributed on the X-bus include any of the **BM●XBP●●●●** backplanes. The racks are connected in a daisy chain using **BMXXBC●●●0K** (3) X-bus extension cordsets 4, connected to either the two 9-way SUB-D connectors 6 and 7 or the front panels of the **BMXXBE1000** rack expansion modules 3.

The maximum total length between the main rack and the last rack of the daisy chain cannot exceed 30 m/98.42 ft.

Line terminators

Both expansion modules at the ends of the daisy chain must have a line terminator 5 **TSXTLYEX** on the unused 9-way SUB-D connector.

Note: The processor is always positioned in the rack at address 0. In an X-bus daisy chain, the order of the racks has no effect on operation. For example, the order of the daisy chain can be 0-1-2-3, 2-0-3-1, or 3-1-2-0, etc.

Configuration with dual X-bus and Ethernet racks

Dual X-bus and Ethernet backplanes support Ethernet ring or star architectures from the Modicon M580 CPU Ethernet port:

- Modicon M580 **BME●58●●2●** CPUs support Ethernet star or ring architectures (RSTP loop is supported on ports 2 and 3). The embedded scanner allows scanning of distributed equipment. The CPU directly drives these devices ("NOC" embedded function).
- Modicon M580 **BME●58●●4●** CPUs support an embedded scanner that allows scanning of Modicon X80 drops on Ethernet RIO (EIO) and distributed equipment.

Modicon M580 CPUs have an additional third Ethernet port dedicated to the connection of a service tool such as a PC, HMI, or network analyzer. This port, labeled "ETH 1", does not support RSTP.

Modicon M580 CPUs can communicate on the main Ethernet rack. They cannot be installed in an expansion rack.

It is necessary to use one of the following dual X-bus and Ethernet backplanes:

Reference	Description
BMEXBP0400	4-slot backplane
BMEXBP0800	8-slot backplane
BMEXBP1200	12-slot backplane
BMEXBP0602	6-slot backplane with power redundancy
BMEXBP1002	10-slot backplane with power redundancy

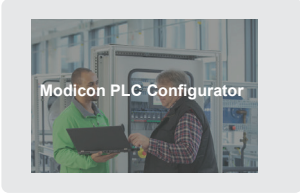

Click on the pictogram to access Modicon PLC Configurator online

2

Local rack



Main rack



Modicon X80 remote I/O drop



Expansion rack

Modicon M580 local rack + Modicon X80 remote drop + expansion rack

Combined configuration

An expansion rack can be connected to the main rack and the Modicon X80 drop (EIO).

The rack address is assigned as follows:

- Each rack will be assigned a physical address using 4 microswitches located in the bus extender module.
- The main rack containing the CPU will be assigned address 0.
- The other racks will be assigned addresses 1 to 7.

Each rack is equipped with:

- 1 A **BM●XBP●●●00** backplane (1)
- 2 A **BMXCPS●●●0** power supply or two **BMXCPS●●●2** redundant power supplies (2)
- 3 A **BMXXBE1000** rack expansion module. This module, inserted in the right-hand end of the rack (XBE slot) does not occupy backplane slots 00...15 (4, 6, 8, or 12 slots are still available).
- 4 A **BMXXBC●●●K** X-bus cordset to connect the expansion modules to each other
- 5 Line terminators: Both expansion modules at the ends of the daisy chain must have a line terminator **5 TSXTLYEX** on the unused 9-way SUB-D connector.

(1) **BMEXBP●●●●** are only supported on M580 processor based platforms.
 (2) **BMXCPS●●●2** redundant power supplies are only compatible with the **BMEXBP●●●02** backplanes with power redundancy.
 (3) **BMXXBC●●●0K** extension cordsets, length 0.8 m/2.62 ft, 1.5 m/4.92 ft, 3 m/9.84 ft, 5 m/16.4 ft, or 12 m/39.4 ft, with angled connectors or **TSXCBY●08K** extension cordsets, length 1 m/3.28 ft, 3 m/9.84 ft, 5 m/16.4 ft, 12 m/39.4 ft, 18 m/59 ft, or 28 m/92 ft, with straight connectors.

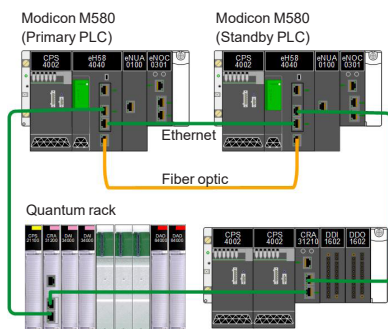

Quantum Ethernet I/O migration

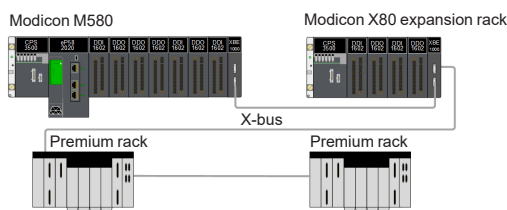

Premium X-bus expansion example



DIA6ED2151012EN

Quantum Ethernet I/O migration

Modicon M580 CPUs level 4 and above (**BMEP584040**, **BMEP585040**, and **BMEP586040**) support Quantum I/O using the Quantum Ethernet remote drop adapter **140CRA31200**. The number of remote I/O drops allowed (up to 31) depends on the M580 processor model.

The Quantum Ethernet drop is configured using EcoStruxure Control Expert (1) software. Each Quantum I/O can be configured with the X80 I/O model (Device DDT) or the Quantum model ("State ram" : %I, %IW, %M, %MW) to simplify the reuse of legacy applications.

The compatibilities of Quantum I/O in an Ethernet Quantum drop are identical in a Quantum processor-based architecture.

In addition, the Modicon LL984 legacy language is supported by some CPU models; please refer to the Modicon M580 product catalog for more information.

Premium X-bus extension

The Modicon M580 CPU supports revamping of an existing Premium installation by replacing the Premium rack 0 (CPU and communication modules) with a Modicon M580 rack.

It is also possible to combine Premium racks **TSXRKY4EX/6EX/8EX/12EX** with Modicon X80 I/O based on an X-bus rack. The majority of existing configurations are supported.

The number of expanded racks allowed depends on which CPU is used:

- The **BMEP581020**, **BMEP582020**, and **BMEP582040** CPUs support a main local rack and up to three expansion racks. If you are using 4-, 6-, or 8-slot Premium expansion racks, you can install two physical racks at each assigned rack address, allowing up to six Premium expansion racks (up to six backplanes and 100 m/328 ft between two drops).
- The **BMEP583020**, **BMEP583040**, **BMEP584020**, and **BMEP584040** CPUs support a main local rack with up to seven expansion racks. If you are using 4-, 6-, or 8-slot Premium expansion racks, you can install two physical racks at each assigned rack address, allowing up to 14 Premium expansion racks.

The maximum number of supported X-bus drops is as follows:

- Four for **BMEP581000/2000**
- Eight for **BMEP583000/4000/5000/6000**

The maximum number of X-bus drops is calculated as follows:

- Max number = one for CPU rack (**BMXXBP0000** or **BMEXP0000**)
- + ½ the number of **TSXRKY4/6/8EX** racks
- + the number of **TSXRKY12EX** racks
- + the number of **BMXXBP0000** racks

Description of the rack expansion module

The front panel of the **BMXXBE1000** rack expansion module comprises:

- 5 A screw for locking the module in its slot (at the far right-hand end of the rack)
- 6 A display block with five LEDs:
 - RUN LED (green): Module running
 - COL LED (red): Several racks have the same address, or rack address 0 does not contain any **BMXP340000** or **BMXP580000** processor
 - LEDs 0, 1, 2, and 3 (green): rack address 0, 1, 2, or 3
- 7 A 9-way female connector, marked X-bus, for the incoming X-bus cordset **3** connected to the upstream rack, or if it is the first rack, for the **A/** line terminator included in the **TSXTLYEX 4** pack
- 8 A 9-way female SUB-D connector, marked X-bus, for the outgoing X-bus cordset **3** to the downstream rack, or if it is the last rack, for the **B/** line terminator included in the **TSXTLYEX 4** pack

On the right-hand side panel

A flap for accessing the three rack addressing microswitches: 0...3

Installation rules for **BM0XBP0000** racks

Rules for installing racks in enclosures (see [our website](#)).

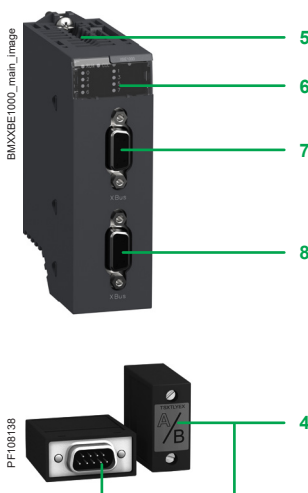

(1) EcoStruxure Control Expert software continues the Unity Pro range of software and corresponds to versions ≥ 14 of Unity Pro.

2



BMXXBE1000



BMXXBE2005



BMXXBC000K



TSXTLYEX

Rack expansion

Description	Use	Reference	Weight kg/lb
Modicon X80 rack expansion module	Standard module for mounting in each rack (XBE slot) and used to interconnect: - Up to 1 expansion rack with BMXP341000 processor - Up to 3 expansion racks with BMXP342000 processor - Up to 3 expansion racks with BMEP581020/2000 processor - Up to 7 expansion racks with BMEP583000/4000/5000/6000 processor - 1 rack with X80 drop (EIO)	BMXXBE1000	0.178/ 0.392
Modicon X80 rack expansion kit	Complete kit for 2-rack configuration comprising: - 2 BMXXBE1000 rack expansion modules - 1 BMXXBC008K extension cordset, length 0.8 m/2.62 ft - 1 TSXTLYEX line terminator (set of 2)	BMXXBE2005	0.700/ 1.543

Cordsets and connection accessories

Description	Use	Composition	Type of connector	Length m/ft	Reference	Weight kg/lb
X-bus expansion cordsets total length 30 m/98 ft max (1).	Between 2 BMXXBE1000 rack expansion modules	2 x 9-way SUB-D connector	Angled	0.8/ 2.62	BMXXBC008K	0.165/ 0.363
				1.5/ 4.92	BMXXBC015K	0.250/ 0.551
				3/ 9.84	BMXXBC030K	0.420/ 0.926
				5/ 16.4	BMXXBC050K	0.650/ 1.433
				12/ 39.4	BMXXBC120K	1.440/ 3.175

Description	Use	Composition	Sold in lots of	Reference	Weight kg/lb
Line terminators	Required on both BMXXBP0000 modules located at either end of the daisy chain	2 x 9-way SUB-D connectors marked A/ and /B	2	TSXTLYEX	0.050/ 0.110

(1) Module and cordsets do not operate properly at temperatures lower than -25 °C/-13 °F.

Modicon X80 power supplies

- Presentation, description [page 3/2](#)
- Functions, references [page 3/3](#)

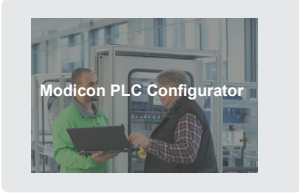

Click on the pictogram to access Modicon PLC Configurator online and calculate the optimal power supply for the power consumption

3

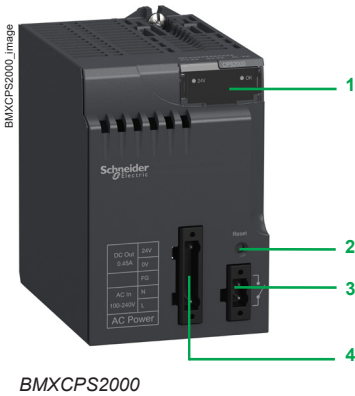

BMXCPS2000

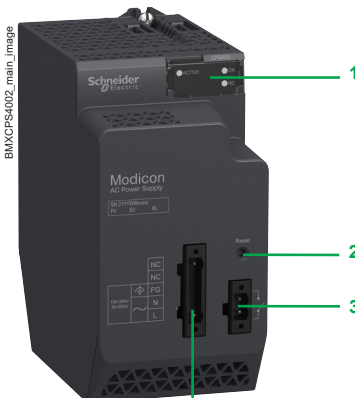

BMXCPS4002

Presentation

BMXCPS●●●● power supplies provide the power supply for each **BMEXBP●●00** or **BMXXBP●●00** Modicon X80 backplane and the modules installed on it (**BMEXBP●●02** supports **BMXCPS●●●2** power supplies only).

The Modicon X80 power supplies offer comprises:

- Five power supplies for DC line supplies:
 - 24 V $\bar{\text{---}}$, 17 W isolated power supply, **BMXCPS2010**
 - 24...48 V $\bar{\text{---}}$, 32 W isolated power supply, **BMXCPS3020**
 - 24...48 V $\bar{\text{---}}$, 40 W redundant power supply, **BMXCPS4022**
 - 125 V $\bar{\text{---}}$, 36 W power supply, **BMXCPS3540T** (extended operating temperature -25 to +70 °C/-13 to +158 °F)
 - 125 V $\bar{\text{---}}$, 40 W redundant power supply, **BMXCPS3522**
- Three power supplies for AC line supplies:
 - 100...240 V \sim , 20 W power supply, **BMXCPS2000**
 - 100...240 V \sim , 36 W power supply, **BMXCPS3500**
 - 100...240 V \sim , 40 W redundant power supply, **BMXCPS4002**

Description

The power supply is selected according to:

- The electrical line supply: 24 V $\bar{\text{---}}$, 48 V $\bar{\text{---}}$, 125 V $\bar{\text{---}}$, or 100...240 V \sim
- The required power (calculate the power consumption using the [Modicon PLC Configurator tool](#)) (1)

BMXCPS●●●● power supplies have the following on the front panel:

- 1 A display block comprising:
 - OK LED (green), lit if rack voltages are present and correct
 - 24 V LED (green), lit when the sensor voltage is present (**BMXCPS2000/BMXCPS3500/BMXCPS3540T** power supply modules only)
 - RD LED (green), lit when all the internal power supply modules are functioning normally (**BMXCPS4002/BMXCPS4022/BMXCPS3522** redundant power supply modules only)
 - ACT LED (green), lit when the power supply is the primary power supply, off when it acts as a secondary supply in redundant application (**BMXCPS4002/BMXCPS4022/BMXCPS3522** redundant power supply modules only)
- 2 A pencil-point Reset pushbutton for a cold restart of the application
- 3 A 2-way connector that can take a removable terminal block (caged or spring-type) for connecting the alarm relay
- 4 A 5-way connector that can take a removable terminal block (caged or spring-type) for connecting the following:
 - $\bar{\text{---}}$ or \sim line supply
 - Protective ground
 - Dedicated 24 V $\bar{\text{---}}$ power supply for the input sensors (for **BMXCPS2000/BMXCPS3500/BMXCPS3540T** power supply modules only)

Included with each power supply module:

- Set of two **BMXXTSCPS10** caged removable terminal blocks (5-way and 2-way)

To be ordered separately (if necessary):

- Set of two **BMXXTSCPS20** spring-type removable terminal blocks (5-way and 2-way)

Compatibility of the power supply with the backplane

The redundant AC power supply can be used alone in a single power supply backplane or as a pair in a dual power supply backplane. For high-availability applications, two independent redundant power supplies can be used to increase the availability of power supply. If the primary power supply is unable to provide the total current, the secondary power supply will change to primary mode and continue to function.

Type	Standalone power supply (BMXCPS●●●0)	Redundant power supply (BMXCPS●●●2)
Single power supply backplanes (BMXXBP●●00, BMEXBP●●00)		
Dual power supply backplanes (BMEXBP●●02)		

Compatible
 Incompatible

(1) This power consumption calculation for the backplane can also be performed by EcoStruxure Control Expert V14 (Unity Pro in earlier versions) programming software.



BMXCPS2010/3020



BMXCPS2000/3500



BMXCPS4002



BMXCPS4022



BMXCPS3522

Functions

Alarm relay

The alarm relay incorporated in each power supply has a volt-free contact accessible on the 2-way connector on the front panel.

The operating principle is as follows:

In normal operation, with the PLC in RUN, the alarm relay is energized and its contact is closed (state 1).

The relay de-energizes and its associated contact opens (state 0) whenever the application stops, even partially, due to any of the following:

- Detection of a blocking fault
- Incorrect rack output voltages
- Loss of supply voltage

Reset pushbutton

The power supply in each backplane has a Reset button on the front panel which, when pressed, triggers an initialization sequence on the processor and the modules in the rack it supplies.

Pressing this pushbutton triggers a sequence of service signals, which is the same as that for:

- A power break, when the pushbutton is pressed
- A power-up, when the pushbutton is released
- In terms of the application, these operations represent a cold start (forcing the I/O modules to state 0 and initializing the processor).

Sensor power supply

BMXCPS2000/3500 AC power supplies and **BMXCPS3540T** DC power supplies have an integrated 24 V $\bar{\bar{\bar{\text{---}}}}$ supply for powering the input sensors.

Connection to this 24 V $\bar{\bar{\bar{\text{---}}}}$ sensor power supply is via the 5-way connector on the front panel. The available power depends on the power supply (0.45 A or 0.9 A).

References

Each **BMEXBP●●00** or **BMXXBP●●00** rack must be equipped with a power supply. **BMEXBP●●02** must be equipped with one or two redundant power supplies. These power supplies are inserted in the leftmost power supply slots of each rack (marked CPS).

The power required to supply each backplane depends on the type and number of modules installed in the backplane. It is therefore necessary to draw up a power consumption table for each backplane in order to determine which **BMXCPS●●●●** power supply is the most suitable for each backplane (please use the [Modicon PLC Configurator tool](#)).

X80 power supplies (1)

Line supply	Available power (2)			Total	Nominal current 24 V $\bar{\bar{\bar{\text{---}}}}$ rack (3)	Reference	Weight kg/lb
	3.3 V $\bar{\bar{\bar{\text{---}}}}$ (3)	24 V $\bar{\bar{\bar{\text{---}}}}$ (3)	24 V $\bar{\bar{\bar{\text{---}}}}$ sensors (4)				
24 V $\bar{\bar{\bar{\text{---}}}}$ isolated	8.3 W	17 W	–	17 W	0.7 A	BMXCPS2010	0.290/ 0.639
24...48 V $\bar{\bar{\bar{\text{---}}}}$ isolated	15 W	32 W	–	32 W	1.3 A	BMXCPS3020	0.340/ 0.750
24...48 V $\bar{\bar{\bar{\text{---}}}}$	18 W	40 W	–	40 W	1.67 A	BMXCPS4022	0.810/ 1.786
100...150 V $\bar{\bar{\bar{\text{---}}}}$	15 W	31.2 W	21.6 W	36 W (5)	1.3 A	BMXCPS3540T (5)	0.340/ 0.750
	18 W	40 W	–	40 W	1.67 A	BMXCPS3522	0.610/ 1.345
100...240 V \sim	8.3 W	16.8 W	10.8 W	20 W	0.7 A	BMXCPS2000	0.300/ 0.661
	15 W	31.2 W	21.6 W	36 W	1.3 A	BMXCPS3500	0.360/ 0.794
	18 W	40 W	–	40 W	1.67 A	BMXCPS4002	0.360/ 0.794

Separate parts

Description	Type	Composition	Reference	Weight kg/lb
Set of 2 removable connectors	Spring-type	One 5-way terminal block and one 2-way terminal block	BMXXTSCPS20	0.015/ 0.033
	Caged	One 5-way terminal block and one 2-way terminal block	BMXXTSCPS10	0.020/ 0.044

(1) Include a set of two caged removable connectors. Spring-type connectors available separately under reference **BMXXTSCPS20**.

(2) The sum of the power consumed on each voltage (3.3 V $\bar{\bar{\bar{\text{---}}}}$ and 24 V $\bar{\bar{\bar{\text{---}}}}$) must not exceed the total power of the module. Calculate the power consumption using the [Modicon PLC Configurator tool](#) or [EcoStruxure Control Expert](#): see the power supply and I/O budget available in the power supply properties in [EcoStruxure Control Expert](#).

(3) 3.3 V $\bar{\bar{\bar{\text{---}}}}$ and 24 V $\bar{\bar{\bar{\text{---}}}}$ rack voltages for powering modules in the Modicon X80 I/O rack.

(4) 24 V $\bar{\bar{\bar{\text{---}}}}$ sensor voltage for powering the input sensors (voltage available via the 2-way removable connector on the front panel).

(5) Extended operating temperature -25 to +70 °C/-13 to +158 °F (with power derating at extreme temperatures: 27 W between -25 and 0 °C/-13 and 0 °F and between 60 and 70 °C/140 and 158 °F).

Modicon X80 discrete I/O modules

- [Selection guide](#) page 4/2
- [Presentation, description](#) page 4/8
- [Functions](#) page 4/9
- [Connection devices](#) page 4/10
- [Complementary characteristics](#) page 4/12
- [References](#) page 4/13

Modicon X80 analog I/O modules

- [Selection guide](#) page 4/16
- [Presentation](#) page 4/20
- [Description](#) page 4/21
- [Connections, combinations](#) page 4/22
- [Complementary characteristics](#) page 4/23
- [References](#) page 4/24

Modicon X80 HART analog I/O modules

- [Selection guide](#) page 4/26
- [Presentation, description](#) page 4/28
- [References](#) page 4/29

Modicon X80 modules

Modicon X80 I/O modules
Discrete input modules

Applications **8-channel discrete input modules** **16-channel discrete input modules**







Type	~		---			~ or ---		~												
Voltage	200...240 V	100...120 V	24 V	48 V	125 V	24 V (~ or ---)	48 V	100...120 V			200...240 V									
Current per channel	10.4 mA (for U = 220 V at 50 Hz)	5 mA	3.5 mA	2.5 mA	2.4 mA	3 mA (~) 3.9 mA (---)	5 mA	10.1 mA (max.) at 50 Hz 11.9 mA (max.) at 60 Hz		9.7 mA (max.) at 50 Hz 11.5 mA (max.) at 60 Hz										
Modularity (Number of channels and commons)	8 inputs and 1 common		8 isolated inputs		16 inputs and 1 common				16 isolated inputs											
Connection	Via BMXFTB20•0 20-way caged, screw clamp, or spring-type removable terminal block						Via BMXFTB40•0 40-way caged or spring-type removable terminal block													
Inputs	IEC/EN 61131-2 conformity		Type 2		Type 3		Type 1		Non-type		Type 1 (~) Non-type (---)		Type 3		Type 1		Non-type at 50 Hz Type 1 at 60 Hz		Type 1	
Logic	-		-		Positive (sink)		-		-		Positive (sink)/Negative (source) (---)		-		-		-		-	
Type of input	Capacitive		Capacitive		Current sink		Resistive		Capacitive		Capacitive		Capacitive		Capacitive		Capacitive		Capacitive	
Sensor compatibility IEC/EN 60947-5-2	2-wire ~		2-wire ~		2-wire ---, 3-wire --- PNP any type		-		-		2-wire ---/~, 3-wire --- PNP/NPN any type		2-wire ~		2-wire ~		2-wire ~		2-wire ~	
Sensor power supply (ripple included)	170...264 V ~	85...132 V ~ (no sensor power monitoring)	19...30 V ---	38...60 V ---	88...150 V ~	20...26 V ~ 19...30 V ---	40...52 V ~	85...132 V ~	100...120 V ~	200...240 V ~										
Protection of inputs	Use one 0.5 A fast-blow fuse per group of channels		Use one 0.25 A fast-blow fuse per channel		Use one 0.5 A fast-blow fuse per group of channels								Use one 0.25 A fast-blow fuse per channel							
Maximum dissipated power	4.73 W	2.35 W	2.5 W	3.6 W	8.5 W (at 40 °C/104 °F)	3 W	4 W	3.8 W	4.3 W											
Operating temperature	0...60 °C/32...140 °F					-25...70 °C/-13...158 °F		0...60 °C/32...140 °F												
Dimensions	W x H x D 32 x 100 x 86 mm/1.25 x 3.93 x 3.38 in.										32 x 131 x 86 mm/1.25 x 5.15 x 3.38 in.									
Compatibility with TeSys Quickfit installation system	-																			
Compatibility with Modicon ABE7 Telefast pre-wired system (1)	Passive connection sub-bases											Adapter sub-bases with relays								
References	BMXDAI0805	BMXDAI0814	BMXDDI1602	BMXDDI1603	BMXDDI1604T	BMXDAI1602	BMXDAI1603	BMXDAI1604	BMXDAI1614	BMXDAI16142	BMXDAI1615									
Pages	4/13																			

(1) For more information, please refer to the "Telefast Pre-wired system – Modicon ABE7 IP20 connection sub-bases" catalog or visit our website.

Modicon X80 modules

Modicon X80 I/O modules

Discrete input and mixed I/O modules

Applications	32-channel high-density discrete input module			32-channel discrete input modules			64-channel high-density discrete input module			16-channel discrete mixed I/O modules			32-channel high-density discrete mixed I/O module		
															
Type	---			---			---			--- inputs and ---/~ relay outputs			---		
Voltage	24 V			12/24 V			48 V			24 V			Inputs: 24 V Solid-state outputs: 24 V		
Current per channel	2.5 mA			3.3 mA			2.3 mA			0.6 mA			Inputs: 24 V --- Relay outputs: 24 V --- or 24...240 V ~		
Modularity (Number of channels and commons)	32 inputs and 2 commons			32 inputs and 2 commons			64 inputs and 4 commons			8 inputs and 1 common, 8 outputs and 1 common			16 inputs and 1 common, 16 outputs and 1 common		
Connection	Via one 40-way connector with preassembled cordsets			Via BMXFTB40●0 40-way caged or spring-type removable terminal block			Via two 40-way connectors with preassembled cordsets			Via BMXFTB20●0 20-way caged, screw clamp, or spring-type removable terminal block			Via one 40-way connector with preassembled cordsets		
Inputs	IEC/EN 61131-2 conformity			Type 1			Type 3			Non-type			Type 3		
Logic	Positive (sink)			Positive (sink)/Negative (source)			Positive (sink)			Positive (sink)			Positive (sink)		
Type of input	Current sink			Current sink/source			Current sink			Current sink			Current sink		
Sensor compatibility IEC/EN 60947-5-2	2-wire ---, 3-wire --- PNP any type			2-wire ---, 3-wire --- PNP/NPN any type			2-wire ---, 3-wire --- PNP any type			-			2-wire ---, 3-wire --- PNP any type		
Sensor power supply (ripple included)	19...30 V ---			10.8...30 V ---			38...60 V ---			19...30 V ---			19...30 V ---		
Protection of inputs	Use one 0.5 A fast-blow fuse per group of channels			Use one 0.5 A fast-blow fuse per group of channels			Use one 0.5 A fast-blow fuse per group of channels			Use one 0.5 A fast-blow fuse per group of channels			Use one 0.5 A fast-blow fuse per group of channels		
Outputs	Fallback			-			-			Configurable output fallback, continuous monitoring of output control, and resetting of outputs in case of internal detected fault			-		
IEC/EN 61131-2 conformity	-			-			-			Yes			-		
Protection	-			-			-			Protected			Not protected		
Logic	-			-			-			Positive			-		
Preactuator power supply (ripple included)	-			-			-			19...30 V ---			19...30 V --- 24...240 V ~		
Output fuse protection	-			-			-			Use one 6.3 A fast-blow fuse per group of channels			Use one 12 A fast-blow fuse per group of channels		
Maximum dissipated power	3.9 W			4.7 W			6 W			4.3 W			3.7 W		
Operating temperature	0...60 °C/32...140 °F			0...60 °C/32...140 °F			0...60 °C/32...140 °F			0...60 °C/32...140 °F			0...60 °C/32...140 °F		
Dimensions W x H x D	32 x 100 x 86 mm/1.25 x 3.93 x 3.38 in.			32 x 131 x 86 mm/1.25 x 5.15 x 3.38 in.			32 x 100 x 86 mm/1.25 x 3.93 x 3.38 in.			32 x 100 x 86 mm/1.25 x 3.93 x 3.38 in.			32 x 100 x 86 mm/1.25 x 3.93 x 3.38 in.		
Compatibility with TeSys Quickfit installation system	LU9G02 splitter boxes (8 motor starters) and BMXFCC●●3 preassembled cordsets (see pages 4/11 and 4/15)			-			LU9G02 splitter boxes (8 motor starters) and BMXFCC●●3 preassembled cordsets (see pages 4/11 and 4/15)			-			LU9G02 splitter boxes (8 motor starters) and BMXFCC●●3 preassembled cordsets (see pages 4/11 and 4/15)		
Compatibility with Modicon ABE7 Telefast pre-wired system (1)	Passive connection sub-bases			-			-			-			-		
	Adapter sub-bases with relays			-			-			-			-		
References	BMXDDI3202K			BMXDDI3232			BMXDDI3203			BMXDDI6402K			BMXDDM16022		
Pages	4/13			4/13			4/13			4/14			4/14		

(1) For more information, please refer to the "Telefast Pre-wired system – Modicon ABE7 IP20 connection sub-bases" catalog or visit [our website](http://www.se.com).
 (2) 8- or 16-channel passive sub-bases, with or without LED, with common or 2 terminals per channel
 (3) Active sub-bases with solid state or electromagnetic relays (fixed or removable), 16 channels, with common or 2 terminals per channel (caged or spring-type connection)

Modicon X80 modules

Modicon X80 I/O modules
Discrete output modules

Applications	16-channel discrete output modules				32-channel discrete output module	32-channel high-density discrete output module	64-channel high-density output module	8-channel relay output modules			16-channel relay output module
--------------	------------------------------------	--	--	--	-----------------------------------	--	---------------------------------------	--------------------------------	--	--	--------------------------------



Type	--- transistor		~ triac	--- transistor		--- relay		---/~ relay				
Voltage	24 V		100...240 V	24...240 V		12...24 V	24 V		100...150 V		24 V --- 24...240 V ~	
Current per channel	0.5 A		0.6 A	3 A		0.5 A	0.1 A		0.3 A (lth)	3 A (lth)	4 A (lth)	
Modularity (Number of channels and commons)	16 outputs and 1 common		16 outputs and 4 commons	16 isolated outputs		32 outputs and 2 commons		64 outputs and 4 commons		8 normally open isolated relay outputs		
Connection	Via BMXFTB20●0 20-way caged, screw clamp, or spring-type removable terminal block			Via BMXFTB40●0 40-way caged or spring-type removable terminal block			Via one 40-way connector with preassembled cordsets		Via two 40-way connectors with preassembled cordsets		Via BMXFTB20●0 20-way caged, screw clamp, or spring-type removable terminal block	
Outputs	Fallback		Configurable output fallback, continuous monitoring of output control, and resetting of outputs in case of internal detected fault		Configurable output fallback		Configurable output fallback, continuous monitoring of output control, and resetting of outputs in case of internal detected fault		Configurable output fallback			
IEC/EN 61131-2 conformity	Yes		Yes		Yes		Yes		Yes			
Protection	Positive (source) Negative (sink)		-		Positive (source)		-		-			
Logic	19...30 V ---		100...240 V ~		24...240 V ~		10.8...30 V ---		19...30 V ---		100...150 V ---	
Preactuator power supply (ripple included)	5...150 V --- 19...264 V ~		-		-		-		-		-	
Output fuse protection	Use one 6.3 A fast-blow fuse per group of channels		Use one 3 A fast-blow fuse per group of channels		Use one 4 A fast-blow fuse per channel		Use one fast-blow fuse per group of channels		Use one 2 A fast-blow fuse per group of channels		Use one 0.5 A fast-blow fuse per each channel	
Maximum dissipated power	Use one fast-blow fuse per each channel		Use one 12 A fast-blow fuse per each group of channels		-		-		-		-	
Operating temperature	4 W		2.26 W		-		4.8 W		3.6 W		6.85 W	
Dimensions	0...60 °C/32...140 °F		-		-		-		-25...70 °C/ -13...158 °F		0...60 °C/32...140 °F	
Compatibility with TeSys Quickfit installation system	32 x 100 x 86 mm/1.25 x 3.93 x 3.38 in.		32 x 131 x 86 mm/1.25 x 5.15 x 3.38 in.		32 x 100 x 86 mm/1.25 x 3.93 x 3.38 in.		32 x 100 x 86 mm/1.25 x 3.93 x 3.38 in.		32 x 131 x 86 mm/ 1.25 x 5.15 x 3.38 in.		32 x 100 x 86 mm/ 1.25 x 3.93 x 3.38 in.	
Compatibility with Modicon ABE7 Telefast pre-wired system (1)	-		-		-		-		-		-	
References	-		-		-		-		-		-	
Pages	-		-		-		-		-		-	
	BMXDDO1602	BMXDDO1612	BMXDAO1605	BMXDAO1615	BMXDDO3202	BMXDDO3202K	BMXDDO6402K	BMXDRA0804T	BMXDRA0815	BMXDRC0805	BMXDRA1605	
	4/14											

(1) For more information, please refer to the "Telefast Pre-wired system -- Modicon ABE7 IP20 connection sub-bases" catalog or visit [our website](#).
 (2) 8- or 16-channel passive sub-bases, with or without LED, with common or 2 terminals per channel
 (3) Active sub-bases with solid state or electromagnetic relays (fixed or removable), 16 channels, with common or 2 terminals per channel (caged or spring-type connection)

4

Presentation

Discrete I/O modules in the Modicon X80 offer are standard modules occupying a single slot on the rack. These modules are equipped with one of the following:

- A connector for a 20-way caged, screw clamp, or spring-type removable terminal block
- A connector for a 40-way caged or spring-type removable terminal block
- One or two 40-way connectors

This wide range of discrete I/O can be used to meet whatever requirements arise in terms of:

- Functions: AC or DC I/O, positive or negative logic
- Modularity: 8, 16, 32, or 64 channels per module

The inputs receive signals from the sensors and perform the following functions:

- Acquisition
- Adaptation
- Electrical isolation
- Filtering
- Protection against interference signals

The outputs memorize commands issued by the processor to enable control of the preactuators via the decoupling and amplification circuits.

Description

BMXD●/D●O/DRA discrete I/O modules are standard format (1 slot). They have an IP20 case to help protect the electronics, and are locked into position with a captive screw.

I/O modules connected via 20-way removable terminal block

- 1 Rigid body providing support and protection for the electronic card
- 2 Module reference marking (a label is also visible on the right-hand side of the module)
- 3 Channel status display block
- 4 Connector taking the 20-way removable terminal block for connection of sensors or preactuators

To be ordered separately:

- 5 **BMXFTB20●0** 20-way removable terminal block (identification label supplied with each I/O module) or a preassembled cordset with a 20-way removable terminal block at one end and flying leads at the other (see [page 4/15](#)).

I/O modules connected via 40-way removable terminal block

- 1 Rigid body providing support and protection for the electronic card
- 2 Module reference marking (a label is also visible on the right-hand side of the module)
- 3 Channel status display block
- 4 Connector taking the 40-way removable terminal block for connection of sensors or preactuators

To be ordered separately:

- 5 **BMXFTB40●0** 40-way removable terminal block (identification label supplied with each I/O module) or a preassembled cordset with a 40-way removable terminal block at one end and flying leads at the other (see [page 4/15](#))

I/O modules connected via 40-way connector(s)

- 1 Rigid body providing support and protection for the electronic card
- 2 Module reference marking (a label is also visible on the right-hand side of the module)
- 3 Channel status display block
- 4 One or two 40-way connectors (32 or 64 channels) (1) for connection of sensors or preactuators
- 5 With the 64-channel module, a pushbutton which, with successive presses, displays the state of channels 0...31 or 32...63 on the display block 3 (see [page 4/9](#))

To be ordered separately, depending on the type of module:

One or two preassembled cordset(s) with a 40-way connector (see [page 4/15](#))

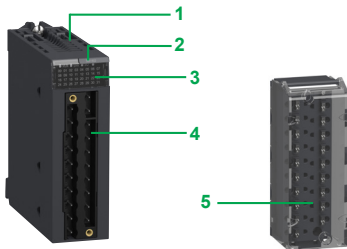

Module for connection via 20-way removable terminal block

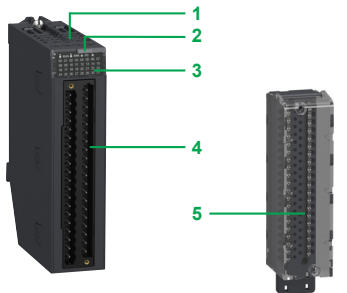

Module for connection via 40-way removable terminal block

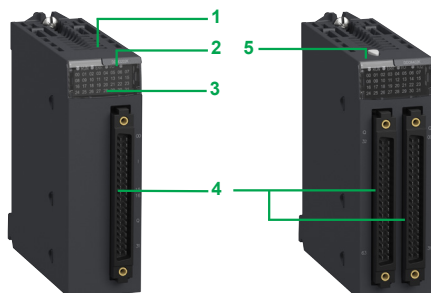

32- and 64-channel modules for connection via one or two 40-way connector(s)

(1) Fujitsu FCN 40-way connector

Functions (1)

The discrete I/O modules provide the following functions:

- **Hot swapping:** Due to their special integrated devices, I/O modules (including application-specific modules) can be removed or added while the power is on.
- **I/O assignment:** The channels of discrete I/O modules are grouped into blocks of 4, 8, or 16 consecutive channels depending on the type of module. Each group of channels can be assigned to a specific application task, namely master or fast.
- **Protection of DC inputs:** The 24 V \overline{DC} and 48 V \overline{DC} inputs are constant-current type. This characteristic limits the current consumed at the inputs.
- **Protection of DC outputs:** Active transistor outputs can withstand overloads, short-circuits, reverse polarity, and inductive over-voltage.
- **Reactivation of DC outputs:** If a line fault has caused an output to trip, the output can be reactivated using this parameter if no other terminal line fault is present. Reactivation is controlled by means of a group of 8 channels. It can be programmed or automatic.
- **RUN/STOP command:** An input can be configured to control the RUN/STOP changeover for the PLC.
- **Output fallback:** This parameter defines the fallback mode used by the DC transistor outputs when the PLC stops. It can assume the “fallback” value at state 0 or state 1 for the corresponding group of 8 channels or the “maintain” value representing the state of the outputs before the PLC stops.
- **I/O module diagnostics:** Each discrete I/O module is equipped with a display block on the front panel centralizing the information necessary for module control, diagnostics, and maintenance.
 - **Diagnostics via EcoStruxure Control Expert (2):** Using the integrated diagnostics in EcoStruxure Control Expert (2), local diagnostics screens are available at global hardware configuration level, module level, and channel level.
 - **Remote diagnostics using a Web browser on a «Thin Client» PC:** In addition, the diagnostics described above can be performed remotely using a simple Web browser thanks to the standard Web server integrated in the Modicon X80 modules (processor with integrated Ethernet port or Ethernet module), using the “ready-to-use” Rack Viewer function.
- **Compatibility with 2-wire and 3-wire sensors:** The discrete input modules can be used in conjunction with OsiSense XS inductive proximity sensors and with OsiSense XU photoelectric sensors (3).



Display block for module
BMXDDO3202K

(1) For further information, please consult [our website](#).

(2) EcoStruxure Control Expert software continues the Unity Pro range of software and corresponds to versions ≥ 14 of Unity Pro.

(3) For further information, please consult the [Telemecanique Sensors website www.tesensors.com](http://www.tesensors.com).



DIA3ED2160602EN

Caged terminal block Screw clamp terminal block Spring-type terminal block

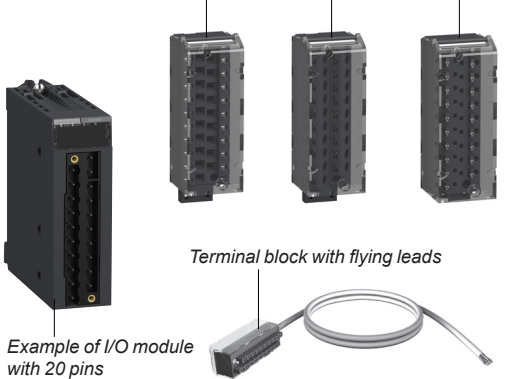

Accessories for connecting 20-pin modules

Caged terminal block Spring-type terminal block

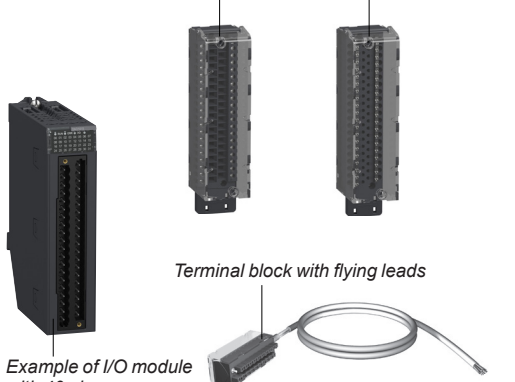

Accessories for connecting 40-pin modules

Connecting modules with 20-way removable terminal blocks

There are three types of 20-way removable terminal block:

- Screw clamp terminal block
- Caged terminal block
- Spring-type terminal block

Each removable terminal block can take:

- Bare wires
- Wires equipped with **DZ5CE/AZ5DE** cable ends

One version of the removable terminal block is equipped with 3, 5, or 10 m / 4.92, 9.84, or 16.4 ft cordsets with color-coded flying leads (**BMXFTW●●1**).

Caged terminal blocks

The capacity of each terminal is:

- Minimum: One 0.34 mm² wire (AWG 22)
- Maximum: One 1 mm² wire (AWG 18)

BMXFTB2000 caged connectors are equipped with captive screws (maximum tightening torque 0.5 N.m/0.37 lb-ft).

Screw clamp terminal blocks

The capacity of each terminal is:

- Minimum: One or two 0.34 mm² wires (AWG 22)
- Maximum: Two 1.5 mm² wires (AWG 16)

BMXFTB2010 screw clamp connectors are equipped with captive screws (maximum tightening torque 0.5 N.m/0.37 lb-ft).

Spring-type terminal blocks

The capacity of each terminal in the **BMXFTB2020** spring-type terminal blocks is:

- Minimum: One 0.34 mm² wire (AWG 22)
- Maximum: One 1 mm² wire (AWG 18)

Connecting modules with 40-way removable terminal blocks

There are two types of 40-way removable terminal block:

- Caged terminal block
- Spring-type terminal block

Each removable terminal block can take:

- Bare wires
- Wires equipped with **DZ5CE/DZ5CA** cable ends

One version of the removable terminal block is equipped with 3 or 5 m / 4.92 or 9.84 ft cordsets with color-coded flying leads (**BMXFTW●●5**).

Caged terminal blocks

The capacity of each terminal is:

- Minimum: One 0.34 mm² wire (AWG 22)
- Maximum: One 1 mm² wire (AWG 18)

BMXFTB4000 caged connectors are equipped with captive screws (maximum tightening torque 0.4 N.m/0.30 lb-ft).

Spring-type terminal blocks

The capacity of each terminal in the **BMXFTB4020** spring-type terminal blocks is:

- Minimum: One 0.34 mm² wire (AWG 22)
- Maximum: One 1 mm² wire (AWG 18)

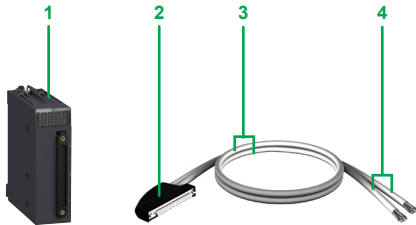

Preassembled cordset with 40-way connector and two ends with flying leads

Connecting modules with 40-way connectors

Preassembled cordsets with 40-way connector at one end and flying leads at the other

Preassembled cordsets can be used for easy direct wire-to-wire connection between the I/O of modules **1** with 40-way connectors and the sensors, preactuators, or intermediate terminal blocks.

These preassembled cordsets comprise:

- At one end, a 40-way connector **2** with either of the following:
 - One sheath containing 20 wires with a cross-section of 0.34 mm² (AWG 22) (**BMXFCW●●1**)
 - Two sheaths **3**, each containing 20 wires with a cross-section of 0.34 mm² (AWG 22) (**BMXFCW●●3**)
- At the other end, color-coded flying leads **4** conforming to standard DIN 47100

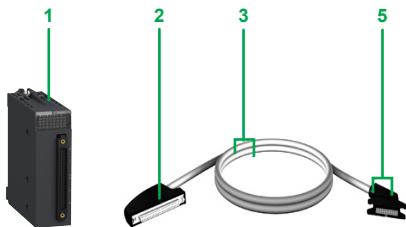

Preassembled cordset with 40-way connectors and HE10 connectors for Modicon ABE7 Telefast system

Preassembled cordsets with 40-way connector and HE 10 connector(s)

Two types of cordset can be used for connecting the I/O of modules **1** with 40-way connectors to Modicon ABE7 rapid wiring connection and adaptation interfaces (1). These preassembled cordsets comprise:

- At one end, a 40-way connector **2** with either of the following:
 - One sheath containing 20 wires (**BMXFCC●●1**)
 - Two sheaths **3** each containing 20 wires (**BMXFCC●●3**)
- At the other end, one or two HE 10 connectors **5**

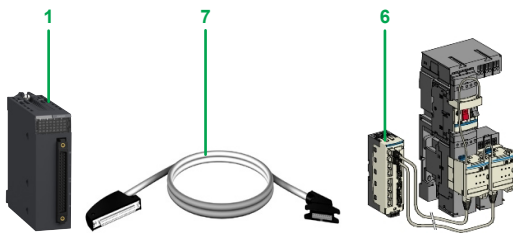

Example of connection to the TeSys Quickfit installation system

Connection to TeSys Quickfit system

BMXDDI3202K/6402K input modules, **BMXDDO3202K/6402K** output modules, and **BMXDDM3202K** mixed I/O modules with 40-way connectors are designed, amongst other things, for use in conjunction with the TeSys Quickfit mounting system via the **LU9G02** splitter module **6** (for 8 motor starters). The splitter modules are easily connected using **BMXFCC●●1/●●3** preassembled cordsets **7**.

(1) For more information, please refer to the "ABE7 / ABE9 Telefast Pre-wired system" catalog or visit [our website](#).

Complementary characteristics

The following characteristics complement those introduced in the selection guide on pages 4/2 to 4/7.

DC input modules **BMXDDI16●●/1604T/3202K/3232/3203/6402K** and **BMXDAI1602**

- Input impedance at nominal voltage: 6.4 to 19.2 kΩ, depending on model
- Reverse polarity: Protection for modules **BMXDDI1602/1603/3202K/3203**
- Paralleling of inputs (1): Yes, for modules **BMXDDI1602/1603/3232/3203**
- Dielectric strength between groups of channels: 500 V $\overline{\text{---}}$ for modules **BXDDI3202K/3203/3232/6402K**
- Temperature derating for module **BMXDDI1604T**: No derating up to 40 °C/104 °F, a maximum of 25% of inputs at state 1 at 70 °C/158 °F

AC input modules **BMXDAI16●●/08●●**

- Input frequency: 47 to 63 Hz
- Current peak on activation at nominal voltage: 5 to 380 mA depending on model
- Input impedance at nominal voltage and F = 55 Hz: 6 to 28 kΩ, depending on model

Triac output module **BMXDAO1605**

- Current via common: 2.4 A
- Current for the 4 commons together: 4.8 A

Isolated triac output module **BMXDAO1615**

- Current per module: 10 A maximum continuous

DC transistor output modules **BMXDDO16●●/3202/3202K/6402K**

- Dielectric strength between groups of channels: 500 V $\overline{\text{---}}$ for modules **BMXDDO3202K/6402K**

Relay output modules **BMXDRA08●●●/1605** and **BMXDRC0805**

- Protection against AC inductive overvoltage: Use an RC circuit or ZNO surge limiter appropriate to the voltage in parallel on each output.
- Protection against DC inductive overvoltage: Use a discharge diode on each output.

Mixed I/O relay module **BMXDDM16025**

- Input impedance at nominal voltage: 6.8 kΩ
- Dielectric strength between groups of inputs: 500 V $\overline{\text{---}}$

DC mixed I/O modules **BMXDDM16022/3202K**

- Input impedance at nominal voltage: 6.8 to 9.6 kΩ, depending on model
- Reverse polarity on the inputs: Protection
- Paralleling of outputs: Yes, for a maximum of 2 outputs for module **BMXDDM16022** and a maximum of 3 outputs for module **BMXDDM3202K**

(1) For further information, please consult [our website](#).

Modicon X80 modules

Modicon X80 I/O modules

Discrete input modules



BMXDDI160●●
BMXDAI08●●●●/160●



BMXDDI3202K



BMXDDI6402K



BMXDAI161●●

References							
Modicon X80 discrete input modules							
Type	Input voltage	Connection via (1)	IEC/EN 61131-2 conformity	No. of channels (common x channels per group)	Reference	Weight kg/lb	
⎓	24 V (positive logic)	20-way caged, screw clamp, or spring-type removable terminal block	Type 3	16 inputs (1 x 16)	BMXDDI1602	0.115/0.254	
		One 40-way connector	Type 1	32 inputs (2 x 16)	BMXDDI3202K	0.110/0.243	
		Two 40-way connectors	Non-type	64 inputs (4 x 16)	BMXDDI6402K (1)	0.145/0.320	
	24 V (positive/negative logic)	20-way caged, screw clamp, or spring-type removable terminal block	Non-type	16 inputs (1 x 16)	BMXDAI1602	0.115/0.254	
		12/24 V (positive/negative logic)	40-way caged or spring-type removable terminal block	Type 3	32 inputs (2 x 16)	BMXDDI3232	0.137/0.302
		48 V (positive logic)	20-way caged, screw clamp, or spring-type removable terminal block	Type 1	16 inputs (1 x 16)	BMXDDI1603	0.115/0.254
40-way caged or spring-type removable terminal block	Type 3		32 inputs (2 x 16)	BMXDDI3203	0.137/0.302		
~	125 V (positive logic)	20-way caged, screw clamp, or spring-type removable terminal block	Non-type	16 inputs (1 x 16)	BMXDDI1604T	0.144/0.317	
		24 V	20-way caged, screw clamp, or spring-type removable terminal block	Type 1	16 inputs (1 x 16)	BMXDAI1602	0.115/0.254
	48 V	20-way caged, screw clamp, or spring-type removable terminal block	Type 3	16 inputs (1 x 16)	BMXDAI1603	0.115/0.254	
		100...120 V	20-way caged, screw clamp, or spring-type removable terminal block	Type 3	8 isolated inputs (8 x 1)	BMXDAI0814	0.115/0.254
	20-way caged, screw clamp, or spring-type removable terminal block		Type 3	16 inputs (1 x 16)	BMXDAI1604	0.115/0.254	
	40-way caged or spring-type removable terminal block		Type 1	16 isolated inputs	BMXDAI1614	0.157/0.346	
	40-way caged or spring-type removable terminal block		Non-type at 50 Hz Type 1 at 60 Hz	16 isolated inputs	BMXDAI16142 (2)	0.157/0.346	
	200...240 V	20-way caged, screw clamp, or spring-type removable terminal block	Type 2	8 inputs (1 x 8)	BMXDAI0805	0.120/0.265	
		40-way caged or spring-type removable terminal block	Type 1	16 isolated inputs	BMXDAI1615	0.157/0.346	

(1) 64-channel modules have two connectors and therefore require two connection cables.
 (2) **BMXDAI16142** is optimized for 60Hz application, e.g. Quantum modules, while **BMXDAI1614** is compatible for both 50Hz and 60 Hz.

Modicon X80 modules

Modicon X80 I/O modules

Discrete output and mixed I/O modules

References

Modicon X80 discrete output modules

Type	Output voltage		Connection via (1)	IEC/EN 61131-2 conformity	No. of channels (common x channels per group)		Reference	Weight kg/lb
	Inputs	Outputs			Inputs	Outputs		
transistor	24 V	24 V	20-way caged, screw clamp, or spring-type removable terminal block	Yes	16 outputs (1 x 16)		BMXDDO1602	0.120/0.265
	(positive logic)	(positive logic)						
	24 V	24 V	20-way caged, screw clamp, or spring-type removable terminal block	Yes	16 outputs (1 x 16)		BMXDDO1612	0.120/0.265
	(negative logic)	(negative logic)						
12...24 V	24 V	40-way caged or spring-type removable terminal block	Yes	32 outputs (2 x 16)		BMXDDO3202	0.142/0.313	
(positive logic)	(positive logic)							
24 V	24 V	One 40-way connector	Yes	32 outputs (2 x 16)		BMXDDO3202K	0.110/0.243	
			Two 40-way connectors	Yes	64 outputs (4 x 16)		BMXDDO6402K (1)	0.150/0.331
triac	100...240 V	24 V	20-way caged, screw clamp, or spring-type removable terminal block	Yes	16 outputs (4 x 4)		BMXDAO1605	0.140/0.309
		(positive logic)						
	24...240 V	24 V	40-way caged or spring-type removable terminal block	Yes	16 isolated outputs		BMXDAO1615	0.250/0.551
relay	100...150 V	24 V	20-way caged, screw clamp, or spring-type removable terminal block	Yes	8 normally open isolated relay outputs		BMXDRA0804T	0.178/0.392
		(positive logic)						
relay	24...125 V	24 V	20-way caged, screw clamp, or spring-type removable terminal block	Yes	8 normally open isolated relay outputs		BMXDRA0815	0.210/0.463
		(positive logic)						
relay	24 V	24 V	20-way caged, screw clamp, or spring-type removable terminal block	Yes	16 normally open relay outputs (2 x 8)		BMXDRA1605	0.150/0.331
		(positive logic)						
	5...125 V	24 V	40-way caged or spring-type removable terminal block	Yes	8 normally open and normally closed isolated relay outputs		BMXDRC0805	0.189/0.417
	24...240 V	24 V						

Modicon X80 discrete mixed I/O modules

Type	Voltage		Connection via	IEC/EN 61131-2 conformity	No. of channels (common x channels per group)		Reference	Weight kg/lb	
	Inputs	Outputs			Inputs	Outputs			
transistor	24 V	24 V	20-way caged, screw clamp, or spring-type removable terminal block	Type 3	Yes	8 (1 x 8)	8 (1 x 8)	BMXDDM16022	0.115/0.254
	(positive logic)	(positive logic)							
relay	24 V	24...240 V	20-way caged, screw clamp, or spring-type removable terminal block	Type 3	Yes	8 (1 x 8)	8 (1 x 8)	BMXDDM16025	0.135/0.298
	(positive logic)	(positive logic)							
transistor	24 V	24 V	One 40-way connector	Type 1	Yes	16 (1 x 16)	16 (1 x 16)	BMXDDM3202K	0.110/0.243
	(positive logic)	(positive logic)							

(1) 64-channel modules have two connectors and therefore require two connection cables.



BMXDDO1602
BMXDDO1602/2/BMXDAO1605
BMXDRA0804



BMXDDO3202K



BMXDDO6402K



BMXDDO3202K



BMXDDO6402K



BMXDRC0805
BMXDRC0805



BMXDAO1615



BMXDDM3202K



BMXDDM1602

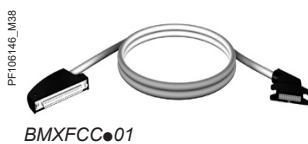
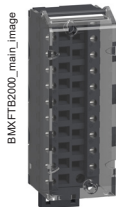

References (continued)

Removable terminal blocks

Description	For use with	Type	Reference	Weight kg/lb
20-way removable terminal blocks	For module with 20-way removable terminal block	Caged	BMXFTB2000	0.093/ 0.205
		Screw clamp	BMXFTB2010	0.075/ 0.165
		Spring	BMXFTB2020	0.060/ 0.132
40-way removable terminal blocks	For module with 40-way removable terminal block	Caged	BMXFTB4000	0.166/ 0.366
		Spring	BMXFTB4020	0.098/ 0.216

Preassembled cordsets for 16- and 32-channel I/O modules with removable terminal block

Description	Composition	Cross-section	Length m/ft	Reference	Weight kg/lb
Preassembled cordsets with one end with flying leads	One 20-way spring-type removable terminal block (BMXFTB2020) and one end with color-coded flying leads	0.324 mm ² / AWG 22	3/9.84	BMXFTW301	0.850/ 1.874
			5/16.4	BMXFTW501	1.400/ 3.086
			10/32.8	BMXFTW1001	2.780/ 6.129
	One 40-way spring-type removable terminal block (BMXFTB4020) and one end with color-coded flying leads	0.324 mm ² / AWG 22	3/9.84	BMXFTW305	0.940/ 2.072
			5/16.4	BMXFTW505	1.460/ 3.218

Preassembled cordsets for 16-, 32-, and 64-channel I/O modules with 40-way connectors

Description	No. of sheaths	Composition	Cross-section	Length m/ft	Reference	Weight kg/lb
Preassembled cordsets with one end with flying leads	1 x 20 wires (16 channels)	One 40-way connector and one end with color-coded flying leads	0.324 mm ² / AWG 22	3/9.84	BMXFCW301	0.820/ 1.808
				5/16.4	BMXFCW501	1.370/ 3.020
				10/32.8	BMXFCW1001	2.770/ 6.107
	2 x 20 wires (32 channels) (1)	One 40-way connector and two ends with color-coded flying leads	0.324 mm ² / AWG 22	3/9.84	BMXFCW303	0.900/ 1.984
				5/16.4	BMXFCW503	1.490/ 3.285
				10/32.8	BMXFCW1003	2.960/ 6.526
Preassembled cordsets for Modicon ABE7 sub-bases	1 x 20 wires (16 channels)	One 40-way connector and one HE 10 connector	0.324 mm ² / AWG 22	0.5/1.64	BMXFCC051	0.140/ 0.309
				1/3.28	BMXFCC101	0.195/ 0.430
				2/6.56	BMXFCC201	0.560/ 1.235
				3/9.84	BMXFCC301	0.840/ 1.852
				5/16.4	BMXFCC501	1.390/ 3.064
				10/32.8	BMXFCC1001	2.780/ 6.123
				0.5/1.64	BMXFCC053	0.210/ 0.463
				1/3.28	BMXFCC103	0.350/ 0.772
				2/6.56	BMXFCC203	0.630/ 1.389
				3/9.84	BMXFCC303	0.940/ 2.072
5/16.4	BMXFCC503	1.530/ 3.373				
10/32.8	BMXFCC1003	3.000/ 6.614				

(1) 64-channel modules have two connectors and therefore require two connection cables.

Modicon X80 modules

Modicon X80 I/O modules
Analog input modules

Applications

Analog inputs



Type of input		Isolated low-level inputs, voltage, thermocouples, temperature probes, resistors		Isolated high-level inputs		Non-isolated high-level inputs		Isolated high-level inputs	
Type		Multirange		Voltage/current					
Range	Voltage	± 40 mV, ± 80 mV, ± 160 mV, ± 320 mV, ± 640 mV, ± 1.28 V		± 10 V, 0...10 V, 0...5 V, 1..5 V, ± 5 V					
	Current	-		0...20 mA, 4...20 mA, ± 20 mA					
	Thermocouple	Thermocouples, type B, E, J, K, L, N, R, S, T, U		-					
	Temperature probe	2-, 3- or 4-wire temperature probes, type Pt100, JPt100, Pt1000, JPt1000, Ni100, Ni1000 (in accordance with DIN 43760), and Cu 10		-					
	Resistor	2-, 3- or 4-wire resistors, 400 Ω or 4,000 Ω		-					
Modularity		4 inputs	8 inputs	4 inputs	8 inputs				
Acquisition period		400 ms for the 4 inputs	400 ms for the 8 inputs	Fast: 1 + (1 x no. of declared channels) ms Default: 5 ms for the 4 channels	Fast: 1 + (1 x no. of declared channels) ms Default: 9 ms for the 8 channels				
Conversion time		-							
Resolution		15 bits + sign		16 bits					
Dimensions		W x H x D 32 x 100 x 86 mm / 1.25 x 3.93 x 3.38 in.							
Isolation	Between channels	750 V ---		300 V ---					
	Between channels and bus	1,400 V ---							
	Between channels and ground	750 V ---		1,400 V ---					
Connection	Directly to the module	Via one 40-way connector	Via two 40-way connectors	Via BMXFTB20●0 20-way caged, screw clamp, or spring-type removable terminal block	Via BMXFTB28●0 28-way caged or spring-type removable terminal block				
	Via preassembled cordsets	BMXFCW●01S cordsets with one end with color-coded flying leads (3 or 5 m/9.84 or 16.4 ft)		BMXFTW●01S cordsets with one end with color-coded flying leads (3 or 5 m/9.84 or 16.4 ft)	BMXFTW●08S cordsets with one end with color-coded flying leads (3 or 5 m/9.84 or 16.4 ft)				
Compatibility with Modicon ABE7 Telefast pre-wired system (1)	Connection sub-base	4-channel sub-base for direct connection of 4 thermocouples plus connection and provision of cold junction compensation		4-channel sub-base for direct connection of 4 inputs, delivers and distributes 4 protected isolated power supplies	8-channel sub-base for direct connection of 8 current/voltage inputs				
	Type of connection sub-base	ABE7CPA412		ABE7CPA410	ABE7CPA02/03/31/31E	ABE7CPA02/31/31E			
	Type of preassembled cordsets	BMXFCA●●2 (1.5, 3, or 5 m/4.92, 9.84, or 16.4 ft)		BMXFCA●●0 (1.5, 3, or 5 m/4.92, 9.84, or 16.4 ft)	BMXFCA●●0 (1.5, 3, or 5 m/4.92, 9.84, or 16.4 ft)	BMXFCA●●0 (1.5 or 3 m/4.92 or 9.84 ft)			
References		BMXART0414		BMXART0814		BMXAMI0410		BMXAMI0800	
Page		4/24							

(1) For more information, please refer to the "Telefast Pre-wired system -- Modicon ABE7 IP20 connection sub-bases" catalog or visit our website.

Modicon X80 modules

Modicon X80 I/O modules
Analog output modules and mixed I/O modules

Applications	Analog outputs		Analog mixed I/O
			
			
Type of I/O	Isolated high-level outputs		Non-isolated high-level outputs
Type	Voltage/current		Current
Range	Voltage ± 10 V		–
	Current 0-20 mA, 4-20 mA		–
Modularity	2 outputs	4 outputs	8 outputs
Acquisition period (inputs)	–		
Conversion time (outputs)	≤ 1 ms		≤ 4 ms
Resolution	Inputs –		–
	Outputs 15 bits + sign		–
Dimensions	W x H x D 32 x 100 x 86 mm / 1.25 x 3.93 x 3.38 in.		
Isolation	Between groups of input or output channels –		750 V ~
	Between channels 750 V ~		–
	Between channels and bus 1,400 V ~		–
	Between channels and ground 1,400 V ~		–
Connection	Directly to the module Via BMXFTB20●0 20-way caged, screw clamp, or spring-type removable terminal block		
	Via preassembled cordsets BMXFTW●01S cordsets with one end with color-coded flying leads (3 or 5 m / 9.84 or 16.4 ft)		
Compatibility with Modicon ABE7 Telefast pre-wired system (1)	Connection sub-base 4-channel sub-base for direct connection of 2/4 current/voltage outputs		8-channel sub-base for direct connection of 8 current/voltage inputs
	Type of connection sub-base ABE7CPA21		ABE7CPA02
	Type of preassembled cordsets BMXFCA●●0 (1.5, 3, or 5 m / 4.92, 9.84, or 16.4 ft)		BMXFTA●●2 (1.5 or 3 m / 4.92 or 9.84 ft)
References	BMXAMO0210	BMXAMO0410	BMXAMO0802
Page	4/22		

(1) For more information, please refer to the "Telefast Pre-wired system -- Modicon ABE7 IP20 connection sub-bases" catalog or visit [our website](#).

Presentation

The Modicon X80 analog I/O modules offer comprises:

- Five analog input modules:
 - Two modules with 4 and 8 isolated channels, low-level voltage, thermocouples, Pt, JPt, Ni, or Cu temperature probes and resistors, 15 bits + sign
BMXART0414/0814
 - One module with 4 high-speed isolated analog channels, high-level voltage or current, 16 bits **BMXAMI0410**
 - Two modules with 8 high-speed non-isolated analog channels, high-level voltage or current, 15 bits + sign **BMXAMI0800/0810**
- Three analog output modules:
 - One module with 2 isolated analog channels, high-level voltage or current, 15 bits + sign **BMXAMO0210**
 - One module with 4 isolated analog channels, high-level voltage or current, 15 bits + sign **BMXAMO0410**
 - One module with 8 non-isolated analog channels, high-level current, 15 bits + sign **BMXAMO0802**
- One analog mixed I/O module with 4 input channels and 2 output channels (non-isolated), voltage or current, 12 to 14 bits according to type of channel and range **BMXAMM0600**

Analog I/O modules are equipped with a connector for a 20- or 28-way removable terminal block, except for **BMXART0414/0814** analog input modules for thermocouples/temperature probes, which are equipped with one or two 40-way connector(s).

All analog modules occupy a single slot in **BMEXBP●●●●** or **BMXXBP●●●●** racks. These modules can be installed in any slot in the rack, except the first two (PS and 00), which are reserved for the power supply module and the processor module respectively.

The power supply for the analog functions is supplied by the backplane bus (3.3 V and 24 V). Analog I/O modules are hot-swappable (see [page 4/9](#)).

4

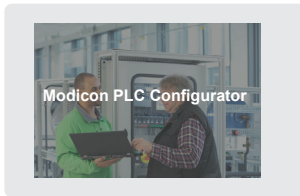

Click on the pictogram to access Modicon PLC Configurator online and design your installation

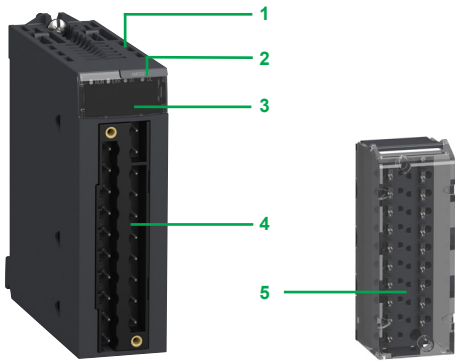

Module for connection via 20- or 28-way removable terminal block

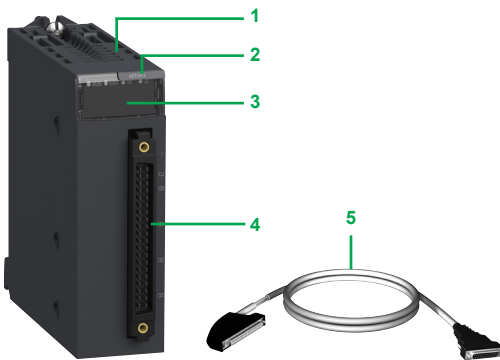

Module for connection via 40-way connector

Description

BMXAM●/ART analog I/O modules are standard format (1 slot). They have a case, which provides IP20 protection of the electronics, and are locked into position by a captive screw.

I/O modules connected via 20 or 28-way removable terminal block

BMXAM● analog I/O modules feature the following:

- 1 A rigid body providing support and protection for the electronic card
- 2 A module reference marking (a label is also visible on the right-hand side of the module)
- 3 A module and channel status display block
- 4 A connector taking the 20- or 28-way removable screw clamp or spring-type terminal block for directly connecting the sensors or preactuators to the module

To be ordered separately (see page 4/25):

- 5 **BMXFTB20●0** or **BMXFTB28●0** 20- or 28-way removable terminal block (referencing label supplied with each I/O module) or pre-wired cables with:
 - A 20-way terminal block at one end and flying leads at the other (**BMXFTW●01S**)
 - A 28-way terminal block at one end and flying leads at the other (**BMXFTW●08S**)
 - A 20- or 28-way terminal block and a 25-way SUB-D connector (**BMXFCA●●0** or **BMXFTA●●0**), for connection to Modicon ABE7 sub-bases

I/O modules connected via 40-way connector

BMXART analog input modules have the following on the front panel:

- 1 A rigid body providing support and protection for the electronic card
- 2 A module reference marking (a label is also visible on the right-hand side of the module)
- 3 A module and channel status display block
- 4 One (or two) 40-way connector(s) for connecting the sensors

To be ordered separately (see page 4/25):

- 5 Pre-wired cables with:
 - A 40-way connector at one end and flying leads at the other (**BMXFCW●01S**)
 - A 40-way connector and a 25-way SUB-D connector (**BMXFCA●●2**) for direct connection to Modicon ABE7 sub-bases

To be ordered separately (see page 2/6):

- A **BMXXSP●●00** shielding connection kit to help protect against electrostatic discharge, consisting of a metal bar and two sub-bases for mounting on the rack supporting the analog modules
- A set of **STBXSP3020** clamping rings for the shielding braids of analog signal cables

Modicon X80 modules

Modicon X80 I/O modules

Connection devices for analog I/O modules

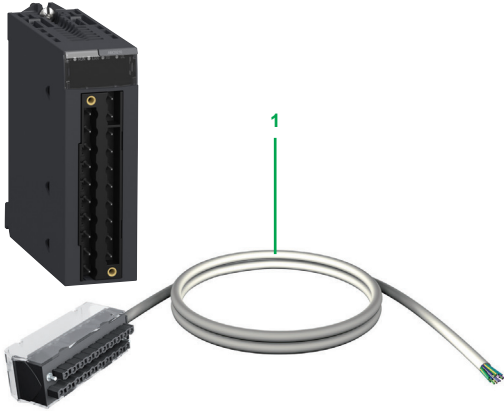

BMXFTW01S cordset (with 20-way removable terminal block at one end and flying leads at the other)

Connecting modules with removable terminal blocks

BMXAMI0410, BMXAMO, and BMXAMM modules with 20-way terminal block

The 20-way removable terminal blocks (**BMXFTB2000**) are the same as those used for discrete I/O modules (screw clamp, caged, or spring-type) (see [page 4/25](#)).

One version of the removable terminal block is equipped with a 3 or 5 m/9.84 or 16.4 ft cordset with color-coded flying leads (**BMXFTW01S**). These preassembled cordsets have reinforced shielding **1**.

BMXAMI0800/0810 modules with 28-way terminal block

The 28-way removable terminal blocks are caged (**BMXFTB2800**) or spring-type (**BMXFTB2820**).

One version of the removable terminal block is equipped with a 3 or 5 m/9.84 or 16.4 ft cordset with color-coded flying leads (**BMXFTW08S**). These preassembled cordsets have reinforced shielding **1**.

Connecting modules with 40-way connectors

BMXART014 modules with 40-way connectors

Two types of cordset are available:

- Preassembled cordsets with reinforced shielding (**BMXFCW01S**) which have color-coded flying leads at the other end **2**. Available in 3 or 5 m/9.84 or 16.4 ft lengths, they enable easy direct wire-to-wire connection of the analog sensors via terminal blocks.
- Preassembled cordsets with reinforced shielding (**BMXFCA002**) which have a 25-way SUB-D connector at the other end **3**. Available in 1.5, 3, or 5 m/4.92, 9.84, or 16.4 ft lengths, they enable direct connection to the Modicon **ABE7CPA412** sub-base (see below).

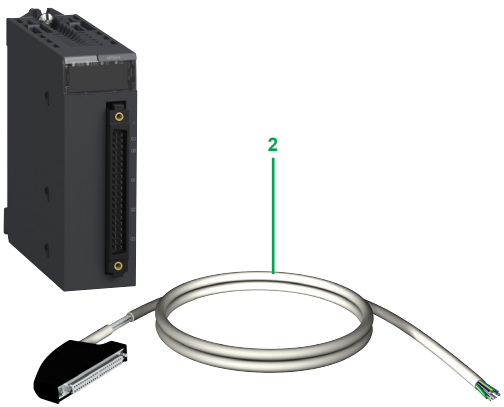

BMXFCW01S cordset (with 40-way connector at one end and flying leads at the other)

Use with Modicon ABE7

Using the Modicon ABE7 Telefast pre-wired system makes it easier to install the modules since the inputs (or outputs) can be accessed via screw clamp terminals. Seven special sub-bases are available:

Modicon ABE7CPA410 sub-base

The Modicon **ABE7CPA410** sub-base is mainly used in conjunction with the **BMXAMI0410** voltage/current analog 4-input module. This sub-base allows you to:

- Directly connect 4 sensors
- Remotely locate the input terminals in voltage mode
- Power the 4 to 20 mA conditioning units one channel at a time with a 24 V voltage, protected and limited to 25 mA, while maintaining isolation between channels
- Help protect the current impedance matching resistors integrated in the sub-base against overvoltages

Connection is via the **BMXFCA000** cordset (1.5, 3, or 5 m/4.92, 9.84, or 16.4 ft).

Modicon ABE7CPA412 sub-base

The Modicon **ABE7CPA412** sub-base is specially designed as a wiring interface for the **BMXART0414** and **BMXART0814** thermocouple modules. This sub-base allows you to:

- Connect 4 thermocouple probes
- Provide external cold junction compensation with a temperature probe integrated in the sub-base
- Provide continuity of the shielding

The **BMXART0814** module requires two Modicon **ABE7CPA412** sub-bases. The connection with each sub-base is made via a **BMXFCA002** cordset (1.5, 3, or 5 m/4.92, 9.84, or 16.4 ft).

Modicon ABE7CPA21 sub-base

The Modicon **ABE7CPA21** sub-base is compatible with the **BMXAMO0210** output module. This sub-base allows you to:

- Directly connect 2 current/voltage outputs
- Provide continuity of the shielding

Connection is via the **BMXFCA000** cordset **3** (1.5, 3, or 5 m/4.92, 9.84, or 16.4 ft).



BMXFCA002 cordset, BMXART0414 4-channel module, and ABE7CPA412 sub-base



DIA3ED2160602EN

Use with Modicon ABE7 (continued)

Modicon ABE7CPA02 sub-base

The Modicon **ABE7CPA02** sub-base can be used in combination with:

- **BMXAMI0800/0810** analog current input modules with 8 inputs
- **BMXAMO0802** analog current output modules with 8 outputs

This sub-base allows you to:

- Connect the 8 analog inputs or outputs point-to-point
- Provide continuity of the shielding

BMXAMI0800/0810 modules are connected via **BMXFTA●●0** 1.5 or 3 m/4.92 or 9.84 ft cables.

The **BMXAMO0802** module is connected via **BMXFTA●●2** 1.5, 3, or 5 m/4.92, 9.84, or 16.4 ft cables.

Modicon ABE7CPA03 sub-base

The Modicon **ABE7CPA03** sub-base can be used in combination with the **BMXAMI0800** voltage/current analog 8-input module.

This sub-base allows you to:

- Directly connect 8 analog inputs
- Power the current inputs one channel at a time with a voltage of 24 V that is protected and limited to 25 mA
- Provide continuity of the shielding

The **BMXAMI0800** module is connected via **BMXFTA●●0** 1.5 or 3 m/4.92 or 9.84 ft cables.

Modicon ABE7CPA31/31E sub-bases

The Modicon **ABE7CPA31/31E** sub-bases can be used in combination with the **BMXAMI0800/0810** voltage/current analog 8-input modules.

These sub-bases allow you to:

- Directly connect 8 analog inputs
- Power the current inputs one channel at a time with 24 V converters
- Provide continuity of the shielding

BMXAMI0800/0810 modules are connected via **BMXFTA●●0** 1.5 or 3 m/4.92 or 9.84 ft cables.

Complementary characteristics

BMXART0414/0814 analog input modules

BMXART0414/0814 modules are multirange input modules with 4 or 8 low-level isolated inputs (15 bits + sign) respectively.

Depending on the choice made during configuration, the modules offer, for each of the inputs, the following ranges:

- Temperature probe: Pt100, JPt100, Pt1000, JPt1000, Cu10, Ni100, or Ni1000 (in accordance with DIN 43760), with open-circuit detection
- Thermocouple: B, E, J, K, L, N, R, S, T, or U with broken wire detection
- Resistor: 0...400 or 0...4,000 Ω , 2-, 3-, or 4-wire
- Voltage: ± 40 mV, ± 80 mV, ± 160 mV, ± 320 mV, ± 640 mV, ± 1.28 V

BMXAMI0410 analog input module

The **BMXAMI0410** module is a high-level analog input module with 4 isolated inputs (16 bits).

Used with sensors or transmitters, it performs monitoring, measurement, and process control functions for continuous processes.

The module offers the following ranges for each of the inputs depending on the choice made during configuration:

- Voltage ± 10 V, ± 5 V, 0...10 V, 0...5 V, and 1...5 V
- Current 0-20 mA, 4-20 mA, and ± 20 mA

BMXAMI0800/0810 analog input modules

BMXAMI0800/0810 analog input modules have 8 high-level isolated/non-isolated analog inputs (15 bits + sign).

The modules offer the following ranges for each of the inputs depending on the choice made during configuration:

- Voltage: ± 10 V, 0...10 V, 0...5 V, 1...5 V, ± 5 V
- Current: 0-20 mA and 4-20 mA

Complementary characteristics (continued)

BMXAMO0210 analog output module

The **BMXAMO0210** module has 2 high-level isolated outputs (15 bits + sign).

The **BMXAMO0210** module offers the following ranges for each of the inputs depending on the choice made during configuration:

- Voltage: ± 10 V
- Current: 0-20 mA and 4-20 mA

BMXAMO0410/0802 analog output modules

BMXAMO0410/0802 analog output modules have 4 or 8 high-level isolated/non-isolated analog outputs (16 bits/15 bits + sign).

The **BMXAMO0410** module offers the following ranges for each of the outputs depending on the choice made during configuration:

- Voltage: ± 10 V
- Current: 0-20 mA and 4-20 mA

The **BMXAMO0802** module offers the current ranges 0-20 mA and 4-20 mA.

BMXAMM0600 analog mixed I/O module

The **BMXAMM0600** mixed module is a non-isolated I/O module with 4 inputs (12/14 bits) and 2 outputs (12 bits). The module offers the following ranges for each of the inputs or outputs depending on the choice made during configuration:

- Voltage: ± 10 V, 0...10 V, 0...5 V, and 1...5 V
- Current: 0-20 mA and 4-20 mA

References

X80 analog input modules (1)

Type of input	Input signal range	Resolution	Connection via	No. of channels	Reference	Weight kg/lb
Isolated high-level inputs	± 10 V, 0...10 V, 0...5 V, 1...5 V, ± 5 V, 0-20 mA, 4-20 mA, ± 20 mA	16 bits	20-way caged, screw clamp, or spring-type removable terminal block	4 channels	BMXAMI0410	0.143/ 0.315
Non-isolated high-level inputs	± 10 V, 0...10 V, 0...5 V, 1...5 V, ± 5 V, 0-20 mA	15 bits + sign	28-way caged or spring-type removable terminal block	8 channels	BMXAMI0800	0.175/ 0.386
Isolated high-level inputs	± 10 V, 0...10 V, 0...5 V, 1...5 V, ± 5 V, 0-20 mA	15 bits + sign	28-way caged or spring-type removable terminal block	8 channels	BMXAMI0810	0.175/ 0.386
Isolated low-level inputs	Temperature probe, thermocouple, ± 40 mV, ± 80 mV, ± 160 mV, ± 320 mV, ± 640 mV, ± 1.28 V	15 bits + sign	40-way connector	4 channels	BMXART0414	0.135/ 0.298
				8 channels	BMXART0814	0.165/ 0.364

X80 analog output modules (1)

Type of outputs	Output signal range	Resolution	Connection via	No. of channels	Reference	Weight kg/lb
Isolated high-level outputs	± 10 V, 0-20 mA, 4-20 mA	16 bits	20-way caged, screw clamp, or spring-type removable terminal block	2 channels	BMXAMO0210	0.144/ 0.317
High-level outputs isolated	± 10 V, 0-20 mA, 4-20 mA	15 bits + sign	20-way caged, screw clamp, or spring-type removable terminal block	4 channels	BMXAMO0410	0.175/ 0.386
Non-isolated high-level inputs	0-20 mA, 4-20 mA	15 bits + sign	20-way caged, screw clamp, or spring-type removable terminal block	8 channels	BMXAMO0802	0.175/ 0.386

X80 analog mixed I/O module (1)

Type of I/O	Signal range	Resolution	Connection via	No. of channels	Reference	Weight kg/lb
Mixed I/O, non-isolated	± 10 V, 0...10 V, 0...5 V, 1...5 V, 0-20 mA, 4-20 mA	12 bits or 14 bits depending on the range	20-way caged, screw clamp, or spring-type removable terminal block	Inputs: 4 channels Outputs: 2 channels	BMXAMM0600	0.155/ 0.342

(1) Calculate the power consumption by using the online [Modicon PLC configurator tool](#).



BMXAMI0410



BMXART0414



BMXAMO0210



BMXAMM0600



BMXFTB20●0



BMXFTW●01S



ABE7CPA41●/21



BMXFCA●●0



BMXFCA●●2

References (continued)

Connection accessories for analog modules (1)

Description	For use with modules	Type, composition	Length	Reference	Weight kg/lb
20-way removable terminal block	BMXAMI0410	Caged	–	BMXFTB2000	0.093/ 0.205
	BMXAMO0210	Screw clamp	–	BMXFTB2010	0.075/ 0.165
	BMXAMO0410		–	BMXFTB2020	0.060/ 0.132
	BMXAMO0802	Spring	–		
	BMXAMM0600				
28-way removable terminal block	BMXAMI0800	Caged	–	BMXFTB2800	0.111/ 0.245
	BMXAMI0810	Spring	–	BMXFTB2820	0.080/ 0.176
Preassembled cordset	BMXAMI0410	One 20-way terminal block (BMXFTB2020) and one end with color-coded flying leads	3 m/9.84 ft	BMXFTW301S	0.470/ 1.036
	BMXAMO0210		5 m/16.4 ft	BMXFTW501S	0.700/ 1.543
	BMXAMO0410				
	BMXAMO0802	One 28-way removable terminal block (BMXFTB2820) and one end with color-coded flying leads	3 m/9.84 ft	BMXFTW308S	0.435/ 0.959
	BMXAMM0600		5 m/16.4 ft	BMXFTW508S	0.750/ 1.653
		BMXART0414	One 40-way connector and one end with color-coded flying leads	3 m/9.84 ft	BMXFCW301S
	BMXART0814	5 m/16.4 ft		BMXFCW501S	0.710/ 1.565

Modicon ABE7 Telefast pre-wired system

Description	For use with modules	Type, composition	Length or connection technology	Reference	Weight kg/lb	
Modicon ABE7 sub-base	BMXAMI0410	Distribution of isolated power supplies. Delivers 4 protected isolated power supplies for 4-20 mA inputs. Direct connection of 4 inputs	Screws	ABE7CPA410	0.180/ 0.397	
	BMXART0414	Connection and provision of cold-junction compensation for thermocouples Direct connection of 4 inputs	Screws	ABE7CPA412	0.180/ 0.397	
	BMXART0814 (2)					
	BMXAMO0210	Direct connection of 2/4 outputs	Screws	ABE7CPA21	0.210/ 0.463	
	BMXAMO0410					
	BMXAMI0800	Point-to-point connection of 8 I/O	Screws	ABE7CPA02	0.317/ 0.699	
	BMXAMI0810					
BMXAMO0802						
Preassembled cordsets for Modicon ABE7 sub-bases	BMXAMI0800	Direct connection of 8 inputs. Delivers 8x 24 V \pm power supplies limited to 25 mA to the 8 current inputs	Screws	ABE7CPA03	0.307/ 0.677	
	BMXAMI0800	Direct connection of 8 inputs Delivers 8x 24 V \pm power supplies isolated and limited to 25 mA to the 8 current inputs	Screws	ABE7CPA31	0.498/ 1.098	
	BMXAMI0810		Spring	ABE7CPA31E	0.508/ 1.120	
		BMXAMI0410	One 20-way removable terminal block and one 25-way SUB-D connector for ABE7CPA410/CPA21 sub-base	1.5 m/4.92 ft	BMXFCA150	0.320/ 0.705
		BMXAMO0210		3 m/9.84 ft	BMXFCA300	0.500/ 1.102
		BMXAMO0410		5 m/16.4 ft	BMXFCA500	0.730/ 1.609
		BMXART0414	One 40-way connector and one 25-way SUB-D connector for ABE7CPA412 sub-base	1.5 m/4.92 ft	BMXFCA152	0.330/ 0.728
		BMXART0814 (2)		3 m/9.84 ft	BMXFCA302	0.510/ 1.124
				5 m/16.4 ft	BMXFCA502	0.740/ 1.631
		BMXAMI0800	One 28-way removable terminal block and one 25-way SUB-D connector for sub-bases ABE7CPA02/03/31/31E	1.5 m/4.92 ft	BMXFCA152	0.374/ 0.825
BMXAMI0810		3 m/9.84 ft		BMXFCA300	0.500/ 1.102	
	BMXAMO0802	One 20-way removable terminal block and one 25-way SUB-D connector for ABE7CPA02 sub-bases	1.5 m/4.92 ft	BMXFCA152	0.374/ 0.825	
			3 m/9.84 ft	BMXFCA302	0.500/ 1.102	

(1) The shielding on the cordsets carrying the analog signals must always be connected to the BMXXSP●●00 shielding connection kit mounted under the rack holding the analog modules (see page 2/6).

(2) The BMXART0814 8-channel module requires two ABE7CPA412 sub-bases and two BMXFCA●●2 cordsets.

Modicon X80 modules

Modicon X80 I/O modules
HART analog I/O modules

Applications		HART analog inputs	HART analog outputs
			
Type of I/O		Isolated analog inputs with HART	Isolated analog outputs with HART
Number of channels		8	4
Range	Current	4-20 mA	
Maximum load impedance		–	600 Ω (0-20 mA)
Operating temperature		0...60°C/32...140°F	
Dimensions	W x H x D	32 x 100 x 86 mm/1.25 x 3.93 x 3.38 in.	
Compatible devices		BMEP58●●●● processors BMECRA31210 drop modules BMEXBP●●00(H) Ethernet + X-bus backplanes 140NOC78000 Quantum Ethernet DIO module	BMEP58●●●● processors BMECRA31210 drop modules BMEXBP●●00(H) Ethernet + X-bus backplanes 140NOC78000 Quantum Ethernet DIO module
Resolution		15 bits + sign	
Isolation	Between channels	1,000 V ~ for 1 minute	
	Between channels and bus	1,400 V ~ for 1 minute	
	Between channels and ground	1,400 V ~ for 1 minute	
Connection	Directly to the module	Via BMXFTB20●0 20-way caged, screw clamp, or spring-type removable terminal block	
Compatibility with Modicon ABE7 Telefast pre-wired system	Connection sub-base	8-channel sub-base for direct connection of 8 current/voltage inputs	
	Type of connection sub-base	ABE7CPA02, ABE7CPA03, ABE7CPA31	
	Type of preassembled cordsets	BMXFTA1522, BMXFTA3022 (1.5 or 3 m/4.92 or 9.84 ft)	
Field device support		2-wire/4-wire	
HART specification	HART field device compliance	HART V5, V6, V7	
	HART field device connection	Point-to-point	
	HART I/O mapping	Yes	
References		BMEAHI0812	BMEAHO0412
Page		4/29	

4

4



More technical information on www.se.com



More technical information on www.se.com

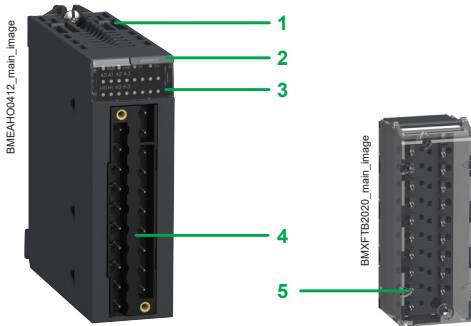

Module for connection via 20-way removable terminal block



DIA6ED2151012EN



BMXFTW01S



BMXFCA000

Presentation

BMEAH0012 HART analog I/O modules contain transceivers that control HART devices and information through the module. They can be managed by the AMS (Asset Management System) or by the automation platform CPU.

These modules require an Ethernet + X-bus backplane and can only be installed in the main local rack with the CPU or in RIO drops with a Modicon X80 Performance remote I/O drop adapter **BMECRA31210**. They cannot be installed in expansion racks.

Description

BMEAH0012 HART analog I/O modules are standard format (1 slot). They have a case, which provides IP20 protection of the electronics, and are locked into position by a captive screw. They are connected via a 20-way removable terminal block.

BMEAH0012 HART analog I/O modules feature the following:

- 1 A rigid body providing support and protection for the electronic card
- 2 A module reference marking (a label is also visible on the right-hand side of the module)
- 3 A module and channel status display block
- 4 A connector taking the 20-way removable screw clamp or spring-type terminal block for directly connecting the sensors or preactuators to the module

To be ordered separately (see [page 4/25](#)):

- 5 A **BMXFTB2000** 20-way removable terminal block (referencing label supplied with each I/O module) or pre-wired cables with:
 - A 20-way terminal block at one end and flying leads at the other (**BMXFTW01S**)
 - A 20-way terminal block and a 25-way SUB-D connector (**BMXFCA000** or **BMXFCA022**), for connection to Modicon ABE 7 sub-bases

Connecting modules using 20-way removable terminal blocks

The 20-way removable terminal blocks (**BMXFTB2000**) are the same as those used for discrete I/O modules (screw clamp, caged, or spring-type) (see [page 4/25](#)).

One version of the removable terminal block is equipped with a 3 or 5 m/9.84 or 16.4 ft cordset with color-coded flying leads (**BMXFTW01S**). These preassembled cordsets have reinforced shielding.

Use with Modicon ABE7 sub-bases

Modicon ABE7CPA21 sub-base

The Modicon **ABE7CPA21** sub-base is compatible with the **BMEAH00412** output module.

This sub-base allows you to:

- Directly connect two current/voltage outputs
- Provide continuity of the shielding

Connection is via the **BMXFCA000** cordset (1.5, 3, or 5 m/4.92, 9.84, or 16.4 ft long).

Modicon ABE7CPA02 sub-base

The Modicon **ABE7CPA02** sub-base can be used with the **BMEAH00812** HART analog input module.

This sub-base allows you to:

- Connect the 8 analog inputs point-to-point
- Provide continuity of the shielding

The **BMEAH00812** module is connected by means of the 1.5 or 3 m/4.92 or 9.84 ft long **BMXFCA1522/3022** cables.



DIA3ED2160602EN

Use with Modicon ABE7 sub-bases

Modicon ABE7CPA03 sub-base

The Modicon **ABE7CPA03** sub-base can be used with the **BMEAHI0812** HART analog input module.

This sub-base allows you to:

- Directly connect the 8 analog inputs
- Power the current inputs one channel at a time with a voltage of 24 V that is protected and limited to 25 mA
- Provide continuity of the shielding

The **BMEAHI0812** module is connected by means of the 1.5 or 3 m/4.92 or 9.84 ft long **BMXFTA1522/3022** cables (1).

Modicon ABE7CPA31 sub-base

The Modicon **ABE7CPA31** sub-base can be used with the **BMEAHI0812** HART analog input module.

This sub-base allows you to:

- Directly connect the 8 analog inputs
- Power the current inputs one channel at a time with 24 V converters
- Provide continuity of the shielding

The **BMEAHI0812** module is connected by means of the 1.5 or 3 m/4.92 or 9.84 ft long **BMXFTA1522/3022** cables.

Additional characteristics

BMEAHI0812 HART analog input module

The **BMEAHI0812** module is a module with 8 high-level isolated inputs (15 bits + sign).

The **BMEAHI0812** module offers the current range 4-20 mA for each of the inputs depending on the choice made during configuration.

BMEAHO0412 HART analog output module

The **BMEAHO0412** module is a module with 4 high-level isolated outputs (15 bits + sign).

The **BMEAHO0412** module offers the current range 4-20 mA for each of the inputs depending on the choice made during configuration.

References

Modicon X80 HART analog input module

Type of input	Input signal range	Resolution	Connection via	No. of channels	Reference	Weight kg/lb
Isolated high-level inputs	4-20 mA	15 bits + sign	20-way caged, screw clamp, or spring-type removable terminal block	8 channels	BMEAHI0812	0.233/ 0.514

Modicon X80 HART analog output module

Type of input	Output signal range	Resolution	Connection via	No. of channels	Reference	Weight kg/lb
Isolated high-level outputs	4-20 mA	15 bits + sign	20-way caged, screw clamp, or spring-type removable terminal block	4 channels	BMEAHO0412	0.223/ 0.492

(1) The **BMEAHI0812** HART analog input module loses its isolation between channels when connected to the Modicon **ABE7CPA03** sub-base.



BMEAHI0812

Modicon X80 Safety products

Modicon Safety selection guide page 5/2

■ Safety product compatibility page 5/4

Modicon X80 Safety power supplies

■ Presentation, description page 5/6

■ Functions, references page 5/7

Modicon X80 Safety discrete I/O modules

■ Presentation..... page 5/8

■ Description, connections page 5/9

■ References page 5/10

Modicon X80 Safety analog I/O module

■ Presentation, description, connections page 5/11

■ References page 5/11

Modicon X80 modules

Modicon X80 Safety
Safety I/O modules

Applications	16-channel Safety discrete input module	8-channel Safety discrete output module	4-channel Safety relay output module	4-channel Safety analog input module
				
Type	DC		AC/DC relays	
Voltage	24 V		24 V $\overline{\text{---}}$ /24...230 V \sim	
Current per channel	3.5 mA	0.5 A	-	
Range	Voltage		6	
	Current		4...20 mA	
Modularity	Number of channels		4 isolated outputs	
	16	8	4 isolated inputs	
	Number of groups			
	2	1		
	Number of channels per common			
	8	-		
Acquisition period	Hot-swap RAID HDD and battery backup		5 ms for the 4 inputs	
Resolution	-		16 bits (12,500 counts)	
Connection	Via BMXFTB20●0 20-way caged, screw clamp, or spring-type removable terminal block			
Isolated inputs	IEC/EN 61131-2 conformity		Resistive	
	Logic			
	Type of input			
	Sensor compatibility IEC/EN 60947-5-2			
Isolated outputs	Fallback		-	
	IEC/EN 61131-2 conformity		-	
	Protection		-	
	Logic		-	
Isolation	Between channels		3,000 Vrms	
	Between channels and bus		3,000 Vrms	
	Between channels and ground		3,000 Vrms	
Dimension	W x H x D			
	32 x 131 x 86 mm / 1.25 x 5.15 x 3.38 in.			
Sensor power supply (ripple included)	19...30 V		-	
Preactuator power supply (ripple included)	-		19...30 V	
Protection of inputs	Use a fast-blow fuse, max 0.5 A, depending on the module current load		10...264 V \sim /10...34 V $\overline{\text{---}}$	
Output fuse protection	-		Use a fast-blow fuse, max 6 A, depending on the relay contact current load	
Maximum dissipated power	3.57 W		3.90 W	
Conformal coated	Yes		-	
Operating temperature	-25...60 °C / -13...140 °F			
References	BMXSDI1602	BMXSDO0802	BMXSRA0405	BMXSAI0410
Page	5/10			5/11

5

5



More technical information on www.se.com



More technical information on www.se.com

Modicon M580 platform and Modicon X80 modules

Safety product compatibility according to network architecture and platform

For non safety product compatibility, please refer to [page 1/10](#)

Product type	Product main feature	Commercial reference (1)	Module type	Modicon M580 Safety				
				Local rack with Safety CPU and coprocessor (X-bus + Ethernet backplanes BMEXBP are mandatory for Safety CPU and coprocessor)		Modicon X80 drops on Ethernet remote I/O		Modicon X80 drops on distributed I/O
				Standalone CPU	Redundant CPU (HSBY)	Standalone or redundant CPU (HSBY)		Standalone CPU
				X-bus + Ethernet backplane BMEXBP●●●●		X-bus backplane BMXXBP●●●●		X-bus + Ethernet backplane BMEXBP●●●●
				BMXCRA31200	BMXCRA31210	BMECRA31210	BMXPRA0100	
Modicon X80 Safety power supplies	Redundant Safety power supply	BMXCPS4002S	100...240 V ~, 40 W					
		BMXCPS4022S	24...48 V ~, 40 W					
		BMXCPS3522S	100...150 V ~, 40 W					
Modicon X80 backplanes	X-bus backplane	BMXXBP0400 (H)	4 slots					
		BMXXBP0600 (H)	6 slots					
		BMXXBP0800 (H)	8 slots					
		BMXXBP1200 (H)	12 slots					
	X-bus + Ethernet backplane	BMEXBP0400 (H)	4 slots					
		BMEXBP0800 (H)	8 slots					
		BMEXBP1200 (H)	12 slots					
	X-bus + Ethernet, dual power supply backplane	BMEXBP0602 (H) (2)	6 slots					
		BMEXBP1002 (H) (2)	10 slots					
	Rack expansion	BMXXBE1000 (H)(3)	Module					
		BMXXBE2005 (4)	Kit					
	Accessories	BMXXEM010 (5)	Protective cover					
	Safety I/O	Safety analog input	BMXSAI0410	4 channels				
Safety discrete input		BMXSDI1602	16 channels					
Safety discrete output		BMXSDO0802	8 channels					
Safety Output Relay		BMXSRA0405	4 channels					
I/O expansion	RIO drop adapter	BMXCRA31200	X-bus, Standard					
		BMXCRA31210 (C)	X-bus, Performance					
		BMECRA31210 (C)	Ethernet, Performance					
	DIO drop adapter	BMXPRA0100	Peripheral					

(1) Optional versions: (C) - "Coated", (H) - "Hardened"
 (2) Not compatible with single power supplies
 (3) Extended rack can be any type of rack, but only X-bus modules (BMX) can be used
 (4) Extended rack kit
 (5) Protective cover for unoccupied slots on backplane

Compatible **Not compatible**

Note: All Modicon X80 Safety modules are compatible with the Modicon M580 Safety ePAC only.

Presentation

The Safety power supply in the Modicon X80 module offer is the **BMXCPS●●●2S**.

The **BMXCPS4022S** Safety power supply:

- Converts 24...48 V $\overline{\text{---}}$ power into two output voltages, 24 V $\overline{\text{---}}$ and 3.3 V $\overline{\text{---}}$, which are distributed over the backplane
- Detects overvoltage, overload, and short-circuit conditions on both the 3.3 V $\overline{\text{---}}$ and 24 V $\overline{\text{---}}$ backplane lines

The **BMXCPS3522S** Safety power supply:

- Converts 100...150 V $\overline{\text{---}}$ power into two output voltages, 24 V $\overline{\text{---}}$ and 3.3 V $\overline{\text{---}}$, which are distributed over the backplane
- Detects overvoltage, overload, and short-circuit conditions on both the 3.3 V $\overline{\text{---}}$ and 24 V $\overline{\text{---}}$ backplane lines

The **BMXCPS4002S** Safety power supply:

- Converts 110...240 V \sim power into two output voltages, 24 V $\overline{\text{---}}$ and 3.3 V $\overline{\text{---}}$, which are distributed over the backplane
- Detects overvoltage, overload, and short-circuit conditions on both the 3.3 V $\overline{\text{---}}$ and 24 V $\overline{\text{---}}$ backplane lines, and allows a maximum voltage of 30 V $\overline{\text{---}}$

Description

The **BMXCPS●●●2S** Safety power supply includes:

- 1 Display panel comprising LEDs with various combinations to provide quick diagnostics of the power supply status:
 - ACTIVE LED (green): On when the power supply is the primary power supply, off when it acts as a secondary supply in a redundant application
 - OK LED (green): On if the rack voltages are present and correct
 - RD LED (green): On when all the internal power supplies function normally
- 2 Printed serial number and product version
- 3 Pencil-point Reset pushbutton for a cold restart of the application
- 4 2-way connector that can take a removable terminal block (caged or spring-type) for connecting the alarm relay
- 5 A 5-way connector that can take a removable terminal block (caged or spring-type) for connecting the following:
 - AC or DC line supply
 - Protective ground
- 6 1 hook and 1 screw for mechanical attachment and grounding connection to the backplane

Included with each power supply: Set of two caged removable terminal blocks (5-way and 2-way) **BMXXTSCPS10**

To be ordered separately (if necessary): Set of two spring-type removable terminal blocks (5-way and 2-way) **BMXXTSCPS20** (see [page 5/7](#)).

Compatibility of the power supply with the rack

The **BMXCPS●●●2S** is a safety-certified power supply that can be used as:

- a main local rack
- an extended local rack
- a main remote rack
- an extended remote rack

The **BMXCPS●●●2S** is a redundant power supply. It can be installed alone in a single power supply rack or dual power supply rack as a pair (primary and secondary).

For high-availability applications, two independent redundant power supplies can be used to increase the security of the power supply. In case the primary power supply fails to provide the total current, the secondary power supply changes to primary mode and continues to function.

The power supply has to be inserted in the leftmost power supply slots on each rack (marked CPS).

Advanced diagnostics

The **BMXCPS●●●2S** can provide advanced diagnostics such as current load, temperatures, remaining life time, and undervoltage thresholds. These values will help to simplify maintenance by predicting when to replace the power supply before it stops.

Note: LED diagnostic display is provided for the module and for each input channel.

M1890_62098_CPSCT16005C

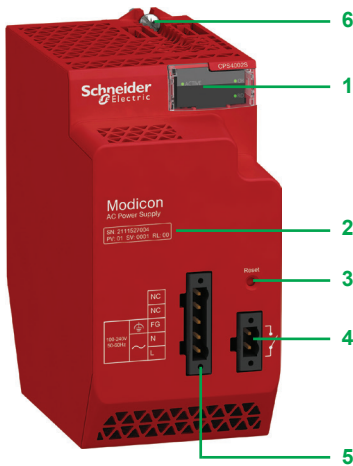

BMXCPS●●●2S

Functions

Alarm relay

The alarm relay incorporated in each power supply has a volt-free contact accessible, on the 2-way connector on the front panel.

The operating principle is as follows:

- The alarm relay is energized and its contact is closed (state 1) in normal operation, with the PLC in RUN.
- The relay de-energizes and its associated contact opens (state 0) whenever the application stops, even partially, due to any of the following:
 - Occurrence of a detected blocking fault (detected RAM error in memory check, Safety watchdog overrun detected on CPU, etc.)
 - Incorrect rack output voltages
 - Loss of supply voltage

Reset pushbutton

The power supply in each rack has a Reset button on the front panel.

Pressing the Reset button on the power supply causes re-initialization of all modules in the same rack as the power supply. If the **BMXCPS●●●2S** power supply is in the main local rack, pressing the Reset button causes re-initialization of the CPU.

In a redundant design, with two **BMXCPS●●●2S** power supplies, you can press the Reset button on either or both power supplies to execute the reset function.

Pressing this pushbutton triggers a sequence of service signals, which is the same as that for:

- A power break, when the pushbutton is pressed
- A power-up, when the pushbutton is released

In terms of the application, these operations represent a cold start (forcing the I/O modules to state 0 and initializing the processor).

References

Modicon X80 Safety power supply (1)

Line supply	Available power (2)			Nominal current	Reference	Weight kg/lb
	3.3 V ⎓ (3)	24 V ⎓ rack (3)	Total			
24...48 V ⎓	18 W	40 W	40 W	1.67 A	BMXCPS4022S	0.810/ 1.786
100...150 V ⎓	18 W	40 W	40 W	1.67 A	BMXCPS3522S	0.610/ 1.345
100...240 V ⎓	18 W	40 W	40 W	1.67 A	BMXCPS4002S	0.510/ 1.124

Accessories for Modicon X80 Safety power supply

Description	Type	Composition	Reference	Weight kg/lb
Removable connectors	Spring-type	One 5-way terminal block and one 2-way terminal block	BMXXTSCPS20	0.015/ 0.033
	Caged	One 5-way terminal block and one 2-way terminal block	BMXXTSCPS10	0.020/ 0.044

(1) Include a set of two caged removable connectors. Spring-type connectors available separately under reference [BMXXTSCPS20](#).

(2) The sum of the power consumed on each voltage (3.3 V ⎓ and 24 V ⎓) must not exceed the total power of the module. See the power supply and I/O budget available in the power supply properties in EcoStruxure Control Expert.

(3) 3.3 V ⎓ and 24 V ⎓ rack voltages for powering modules in the Modicon X80 I/O rack.

Modicon X80 modules

Modicon X80 Safety

Safety discrete I/O modules

Modicon_M580_Safety_TB-I/O_assembly



Modicon M580 Safety configuration with a mix of Modicon X80 standard and Safety I/O

Modicon_Safety_Copro



Modicon Safety configuration with Modicon X80 Safety modules only with removable terminal blocks

Presentation of Safety I/O modules

Modicon X80 is a powerful, proven solution for integrating an homogeneous automation architecture with a unique process and safety modules.

In the Modicon X80 offer, a Safety project can include both Safety modules and non-Safety modules:

- Safety modules in the SAFE task
- Non-Safety modules only for the non-safety tasks (MAST, FAST, AUX0, and AUX1)

Only non-Safety modules that do not interfere with the functional safety function can be added to a Safety project.

Safety I/O modules can be used to connect the Safety PAC to sensors and actuators that are not part of the functional safety function loop.

Each Safety I/O module incorporates a dedicated Safety processor.

Safety I/O modules can be installed in the local backplane or in RIO drops.

All Safety I/O modules support SIL3 standards according to IEC 61508. The assessment is indicated by the category (Cat) and performance level (PL).

Each Safety I/O module provides module and channel LED diagnostics on the front face of the module:

- The top four LEDs (RUN, ERR, I/O, and LCK) indicate the module status.
- The bottom rows of LEDs combine with the top four LEDs to indicate the state and health of each input or output channel.

Presentation of Safety discrete I/O modules

There are three Safety discrete I/O modules in the Modicon X80 offer:

- **BMXSDI1602** Safety discrete input module
- **BMXSDO0802** Safety discrete output module
- **BMXSRA0405** Safety discrete relay output module

These modules can only be used with a Safety CPU.

BMXSDI1602

The **BMXSDI1602** Safety discrete input module has the following features:

- 16 Type 3 (1) inputs, in two groups of 8 non-isolated inputs
- 24 V $\overline{\text{---}}$ nominal input voltage
- Achieves SIL3, Cat2/PLd assessment using 1 input channel and Cat4/PLe using 2 input channels
- Compatible with 2- or 3-wire proximity sensors
- Optional provision of two 24 V $\overline{\text{---}}$ outputs (VS1 and VS2) for short-circuit to 24 V $\overline{\text{---}}$ monitoring
- Monitoring of external 24 V $\overline{\text{---}}$ sensor supply voltage

BMXSDO0802

The **BMXSDO0802** Safety discrete output module has the following features:

- 8 non-isolated 0.5 A outputs
- 24 V $\overline{\text{---}}$ nominal output voltage
- Achieves SIL3, Cat4/PLe assessment
- Monitoring of the external pre-actuator power supply

BMXSRA0405

The **BMXSRA0405** Safety discrete relay output module has the following features:

- 4 relay outputs with 5 A current
- 24 V $\overline{\text{---}}$ and 24...230 V \sim nominal output voltage (overvoltage category II)
- Achieves SIL2, Cat2/PLc assessment using 1 relay and SIL3, Cat4/PLe using 2 relays
- Support for eight pre-defined application wiring configuration selections
- Configurable automatic self-test monitoring of the relay capacity to execute the commanded output state (depending on the selected application wiring configuration)
- Configurable module settings for fallback mode and fallback timeout (in ms)

(1) According to IEC61131-2 standard

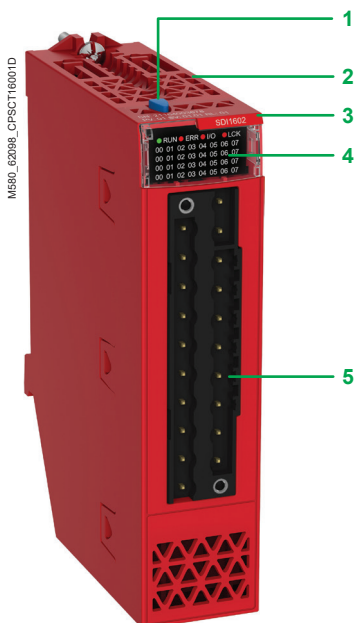

Safety discrete I/O module

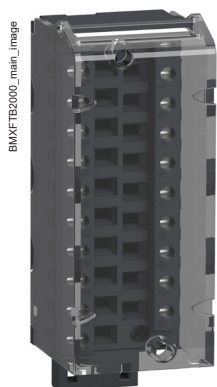

BMXFTB2000

Description

Safety discrete I/O modules are standard format with one slot. They have an IP20 housing to help protect the electronics, and are locked into position with a captive screw.

To be ordered separately: A **BMXFTB2000** 20-way removable terminal block (identification label supplied with each I/O module) or a preassembled cordset with a 20-way removable terminal block at one end and flying leads at the other (see connections on [page 5/10](#)):

BMXSDI1602, **BMXSDO0802**, and **BMXSRA0405**, Safety discrete modules include:

- 1 Lock/unlock configuration button
- 2 Rigid body providing support and protection for the electronic card
- 3 Module reference marking (a label is also visible on the right-hand side of the module)
- 4 Display panel comprising LEDs with various combinations to provide quick diagnostics of the status of the module and each channel:
 - RUN LED (green): module in operation
 - ERR LED (red): detected module error
 - I/O LED (red): detected I/O error
 - LCK LED (bi-color green/red): indicates the configuration status
 - 1 LED per channel (bi-color green/red): indicates the channel status
- 5 Connector taking the 20-way removable terminal block for connecting sensors or preactuators

Connections

20-way removable terminal blocks are used to connect the three Safety discrete I/O modules.

There are three types of 20-way removable terminal block:

- Caged terminal block **BMXFTB2000** (1)
- Screw clamp terminal block **BMXFTB2010** (1)
- Spring-type terminal block **BMXFTB2020** (1)

Type of terminal block	Minimum capacity	Maximum capacity
Caged (1)	One 0.34 mm ² wire (AWG 22)	One 1 mm ² wire (AWG 18)
Screw clamp (1)	One or two 0.34 mm ² wires (AWG 22)	Two 1.5 mm ² wires (AWG 15)
Spring-type	One 0.34 mm ² wire (AWG 22)	One 1 mm ² wire (AWG 18)

(1) Connectors are equipped with captive screws: max. tightening torque 0.5 N.m/0.37 lb-ft.

Note: No cordset is provided for cabling Modicon X80 Safety I/O modules. Too many options are possible according to the kind of:

- application: safety only, safety mixed with availability, etc.
- functional safety level: SIL3/Cat2, SIL3/Cat4, SIL2, etc.

For more information on the different cabling options, please refer to the detailed user manuals published on [our website](#).

Modicon X80 modules

Modicon X80 Safety

Safety discrete I/O modules

M580_62098_CPSCT16001D



BMXSDI1602

M580_62098_CPSCT16002A



BMXSDO0802

M580_62098_CPSCT16004A



BMXSRA0405

5

References

Modicon X80 Safety discrete input module

Type of current	Input voltage	Connection via	IEC/EN 61131-2 conformity	Number of channels (common)	Reference	Weight kg/lb
DC	24 V (logic positive)	Caged, screw clamp, or spring-type 20-way removable terminal block	Type 3	16 non-isolated inputs (1 x 16)	BMXSDI1602	0.115/ 0.254

Modicon X80 Safety discrete output module

Type of current	Input voltage	Connection via	IEC/EN 61131-2 conformity	Number of channels (common)	Reference	Weight kg/lb
DC	24 V (logic positive)	Caged, screw clamp, or spring-type 20-way removable terminal block	Yes	8 non-isolated outputs (1 x 8)	BMXSDO0802	0.120/ 0.264

Modicon X80 Safety relay output module

Type of current	Input voltage	Connection via	IEC/EN 61131-2 conformity	Number of channels (common)	Reference	Weight kg/lb
AC/DC relay	24 V \pm /24...230 V \sim	Caged, screw clamp, or spring-type 20-way removable terminal block	Yes	4 isolated outputs (1 x 4)	BMXSRA0405	0.145/ 0.320

Removable terminal blocks

Description	For use with modules	Type composition	Reference	Weight kg/lb
20-way removable terminal blocks	BMXSDI1602	Caged	BMXFTB2000	0.093/ 0.205
	BMXSDO0802	Screw clamp	BMXFTB2010	0.075/ 0.165
	BMXSRA0405	Spring	BMXFTB2020	0.062/ 0.132

Modicon X80 modules

Modicon X80 Safety Safety analog input module

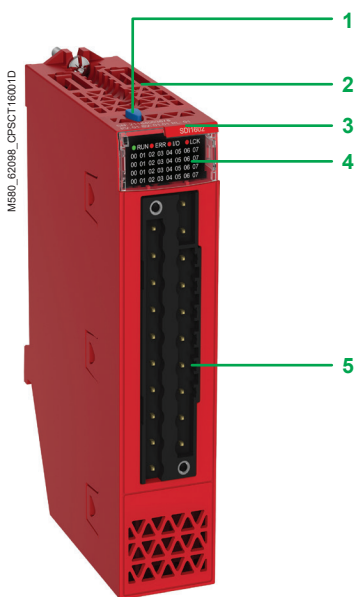

BMXSAI0410

Presentation

The Safety analog input module in the Modicon X80 offer is the **BMXSAI0410**:

The **BMXSAI0410** Safety analog input module has the following features:

- 4 isolated analog 4...20 mA current input channels
- 16-bit resolution (12,500 counts), spanning the data range 0...25 mA
- Current out of range detection, for current values less than 3.75 mA or greater than 20.75 mA
- Achieves SIL3, Cat2/PLD assessment using 1 input channel and SIL3, Cat4/PLE using 2 input channels

This module can only be used with a Safety CPU.

Description

The **BMXSAI0410** Safety analog input module includes:

- 1 Lock/unlock configuration button
- 2 Rigid body providing support and protection for the electronic card
- 3 Module reference marking (a label is also visible on the right-hand side of the module)
- 4 Display panel comprising LEDs with various combinations to provide quick diagnostics of the status of the module and each channel (1):
 - RUN LED (green): module in operation
 - ERR LED (red): detected module error
 - I/O LED (red): detected I/O error
 - LCK LED (bi-color green/red): indicates the configuration status
 - 1 LED per channel (bi-color green/red): indicates the channel status
- 5 Connector taking the 20-way removable terminal block for connecting sensors or preactuators

Connections

20-way removable terminal blocks are used to connect the analog input module (2).

There are three types of 20-way removable terminal block:

- Caged terminal block **BMXFTB2000** (3)
- Screw clamp terminal block **BMXFTB2010** (3)
- Spring-type terminal block **BMXFTB2020**

Type of terminal block	Minimum capacity	Maximum capacity
Caged (3)	One 0.34 mm ² wire (AWG 22)	One 1 mm ² wire (AWG 18)
Screw clamp (3)	One or two 0.34 mm ² wires (AWG 22)	Two 1.5 mm ² wires (AWG 15)
Spring-type	One 0.34 mm ² wire (AWG 22)	One 1 mm ² wire (AWG 18)

Red labels are provided for Safety I/O modules.

References

Modicon X80 Safety analog input modules

Type of input	Input signal range	Resolution	Connection	No. of channels	Reference	Weight kg/lb
Isolated high-level input	4–20 mA	16 bits	Removable terminal block, 20-way caged, screw clamp, or spring-type	4	BMXSAI0410	0.143/0.315

Connection accessories for Modicon X80 Safety analog input module

Description	For use with modules	Type composition	Reference	Weight kg/lb
20-way removable terminal blocks	BMXSAI0410	Caged	BMXFTB2000	0.093/0.205
		Screw clamp	BMXFTB2010	0.075/0.165
		Spring	BMXFTB2020	0.060/0.132

(1) LEDs in positions 5...7 are not used because the input module only has four channels.

(2) No cordset is provided for cabling Modicon X80 Safety I/O modules. Too many options are possible according to the kind of:

- applications: safety only, safety mixed with availability, etc.
- functional safety level: SIL3/Cat2, SIL3/Cat4, SIL2, etc.

For more information on the different cabling options, please refer to the detailed user manuals published on [our website](#).

(3) Connectors are equipped with captive screws: max. tightening torque 0.5 N.m/0.37 lb-ft.

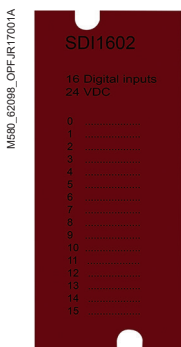

SDI1602 red label

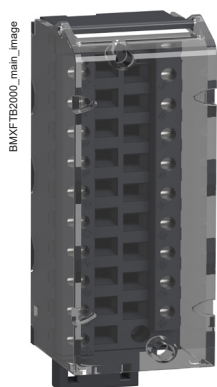

BMXFTB2000

Modicon X80 counter modules

- Presentation, description [page 6/2](#)
- Functions [page 6/3](#)
- References [page 6/5](#)

Modicon X80 time-stamping module

- Presentation, description [page 6/6](#)
- Performance, references [page 6/7](#)

Modicon X80 SSI encoder interface module

- Presentation, description [page 6/8](#)
- Functions, references [page 6/9](#)

Modicon X80 motion control module

- Presentation, description [page 6/10](#)
- Operation, references [page 6/11](#)
- MFB library presentation, functions [page 6/12](#)
- Motion tree manager, programming, maintenance [page 6/13](#)

Modicon X80 frequency input module

- Presentation, description [page 6/14](#)
- Module specifications, references [page 6/15](#)

Modicon X80 weighing module

- Presentation, description [page 6/16](#)
- References [page 6/17](#)



Click on the pictogram to access Modicon PLC Configurator online and design your installation

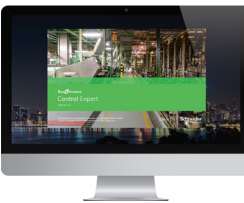

EcoStruxure Control Expert monitor

6

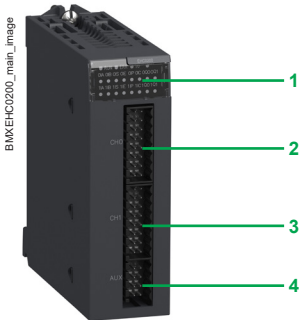

BMXEHC0200

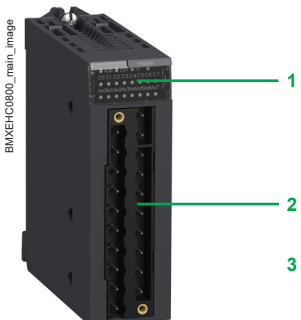

BMXEHC0800

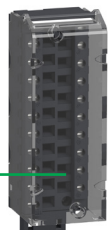

BMXFTB2000

Presentation

In the Modicon X80 module offer, **BMXEHC0200** and **BMXEHC0800** counter modules are used to count the pulses generated by a sensor or to process the signals from an incremental encoder.

The two modules differ in their number of counter channels, maximum input frequencies, functions, and auxiliary input and output interfaces:

Counter module	No. of channels	Maximum frequency	Integrated functions	No. of physical inputs	No. of physical outputs
BMXEHC0200	2	60 KHz	Upcounting Downcounting Period meter Frequency meter Frequency generator Axis control	6	2
BMXEHC0800	8	10 KHz	Upcounting Downcounting Measurement	2	–

The sensors used on each channel can be:

- 2-wire 24 V proximity sensors
- 3-wire 24 V proximity sensors
- 10/30 V output signal incremental encoders with push-pull outputs

BMXEHC0200/0800 counter modules can be used to meet the demands of applications such as:

- Alarm generation on empty unwinder status using the ratio
- Sorting small parts using the period meter
- Single electronic cam using the dynamic setting thresholds
- Speed control using the period meter

These standard format modules can be installed in any available slot on a Modicon X80 backplane. They are hot-swappable.

In a Modicon X80 PLC configuration, the number of **BMXEHC0200/0800** counter modules should be added to the number of application-specific modules (communication). The function parameters are set by configuration using EcoStruxure Control Expert (1) software.

Description

BMXEHC0200/0800 counter modules are standard format. They occupy a single slot in **BM•XBP•••** backplanes. They come in a plastic case, which provides IP20 protection of the electronics, and are locked into position by a captive screw.

BMXEHC0200 module, 2 channels, 60 KHz

The front panel of the **BMXEHC0200** counter module features:

- 1 Module and channel status display block
- 2 16-way connector for connecting the sensors of counter 0
- 3 16-way connector for connecting the sensors of counter 1
- 4 10-way connector for connecting:
 - Auxiliary outputs
 - Sensor power supplies

To be ordered separately:

- A **BMXTSHSC20** kit containing two 16-way connectors and one 10-way connector (see [page 6/5](#))
- A **BMXXSP••00** shielding connection kit if the backplane is not already equipped with one (see [page 2/6](#))

BMXEHC0800 module, 8 channels, 10 KHz

The front panel of the **BMXEHC0800** counter module features:

- 1 Module and channel status display block
- 2 Connector taking the **BMXFTB2000** 20-way removable terminal block **3** (same as that of I/O modules)

To be ordered separately:

- A 20-way removable terminal block **3** (caged, screw clamp, or spring-type) (see [page 4/15](#))
- A **BMXXSP••00** shielding connection kit if the backplane is not already equipped with one (see [page 2/6](#))

(1) EcoStruxure Control Expert software continues the Unity Pro range of software and corresponds to versions ≥ 14 of Unity Pro.

Operating modes for module BMXEHC0200

Eight configurable modes	Frequency meter	<p>This mode measures a frequency, speed, data rate, or an event stream. As standard, this mode measures the frequency received on the IN_A input. This frequency is expressed in Hz (number of pulses/second), with a precision of 1 Hz.</p> <p>The maximum frequency on the IN_A input is 60 kHz. The maximum cyclic ratio at 60 kHz is 60%.</p>
	Event counting	<p>This mode is used to determine the number of events received. In this mode, the counter calculates the number of pulses applied to the IN_A input at time intervals defined by the user.</p> <p>The module counts the pulses applied to the IN_A input each time the pulse for this input lasts longer than 5 μs (without anti-bounce filter).</p>
	Period meter	<p>This mode is used to:</p> <ul style="list-style-type: none"> ■ Determine the duration of an event ■ Determine the time between two events ■ Time and measure the execution time of a process <p>It measures the time elapsed during an event or between two events (IN_A input) according to a selectable time base of 1 μs, 100 μs, or 1 ms.</p> <p>The IN_SYNC input can be used to enable or stop a measurement. The module can carry out a maximum of 1 measurement every 5 ms. The shortest measurable pulse is 100 μs, even if the unit defined by the user is 1 μs. The maximum measurable duration is 4,294,967,295 units (unit to be defined).</p>
	Ratio counting	<p>Ratio counting mode only uses the IN_A and IN_B inputs. There are two possible modes:</p> <ul style="list-style-type: none"> ■ Ratio 1: Used to divide two frequencies. This is intended for applications such as flowmeters, mixers, etc. ■ Ratio 2: Used to subtract two frequencies. This is intended for the same applications, but for those requiring more precise regulation (more similar frequencies). <p>Ratio 1 mode gives the results in thousandths for better accuracy (a display of 2,000 corresponds to a value of 2) and ratio 2 mode gives the results in Hz.</p> <p>The maximum frequency that the module can measure on the IN_A and IN_B inputs is 60 kHz.</p>
	Downcounting	<p>This mode is used to list a group of operations. In this mode, activating the synchronization function starts the counter which, starting from a user-defined preset value, decreases with each pulse applied to the IN_A input, until it reaches 0. This downcounting is made possible when the enable function has been activated. The counting register is thus updated at 1 ms intervals.</p> <p>One basic use of this mode is to signal, using an output, the end of a group of operations (when the counter reaches 0).</p> <p>The shortest pulse applied to the IN_SYNC input is 100 μs. The maximum frequency applied to the IN_SYNC input is 1 pulse every 5 ms. The maximum user-defined preset value is 4,294,967,295. The maximum count value is 4,294,967,295 units.</p>
	Loop (modulo) counting	<p>This mode is used in packaging and labeling applications where actions are repeated on sets of moving objects:</p> <ul style="list-style-type: none"> ■ In upcounting, the counter increases until it reaches the user-defined "modulo - 1" value. On the next pulse, the counter is reset to 0 and upcounting restarts. ■ In downcounting, the counter decreases until it reaches 0. On the next pulse, the counter is reset to the user-defined "modulo - 1" value. Downcounting can then restart. <p>The maximum frequency applied to the IN_A and IN_B inputs is 60 kHz. The maximum frequency of the modulo event is 1 event every 5 ms. The maximum modulo value is 4,294,967,296 (possible by declaring 0 in the modulo adjust value).</p>
	32-bit counter counting	<p>This mode is mainly used in axis following.</p> <p>The maximum frequency applied simultaneously to the IN_A and IN_B inputs is 60 kHz. The maximum frequency of the referencing event is one event every 5 ms. The counter value is between -2,147,483,648 and +2,147,483,647.</p>
	Width modulation	<p>In this operating mode, the module uses an internal clock generator to supply a periodic signal on the module's O0 output. Only the O0 output is affected by this mode, as the O1 output is independent of it.</p> <p>The maximum output frequency is 4 kHz.</p> <p>As O0 is a source output, a load resistor is necessary for the O0 output signal to change to 0 at the correct frequency. The cyclic ratio adjustment range varies according to the frequency of the O0 output.</p>

Operating modes for module BMXEHC0800

Five configurable 16-bit modes	Frequency meter	<p>This mode measures a frequency, speed, rate, or data stream control. As standard, this mode measures the frequency received on the IN_A input. This frequency is expressed in Hz (number of pulses per second), with a precision of 1 Hz.</p> <p>The maximum frequency on the IN_A input is 10 kHz.</p> <p>The maximum cyclic ratio at 10 kHz is 60%.</p>
	Event counting	<p>This mode is used to determine the number of events received. In this mode, the counter calculates the number of pulses applied to the IN_A input at time intervals defined by the user.</p> <p>As an option, it is possible to use the IN_AUX input during a period of time, provided that the enable bit has been configured.</p> <p>The module counts the pulses applied to the IN_A input each time the pulse for this input lasts longer than 50 μs (without anti-bounce filter).</p> <p>Pulses with less than 100 ms synchronization are lost.</p>
	Downcounting	<p>This mode is used to list a group of operations. In this mode, when counting is enabled (software validation via the valid_sync command), a rising or falling edge on the IN_AUX input causes a value, defined by the user, to be loaded in the counter. The latter decreases with each pulse applied to the IN_A input until it reaches the value 0. Downcounting is made possible when the force_enable command is high (software positioning).</p> <p>The smallest pulse applied to the IN_AUX input varies according to the selected filter level.</p> <p>The maximum frequency applied to the IN_AUX input is 1 pulse every 25 ms.</p>
	Loop (modulo) counting	<p>This mode is used in packaging and labeling applications where actions are repeated on sets of moving objects.</p> <p>The counter increases with each pulse applied to the IN_A input until it reaches the user-defined "modulo - 1" value. On the next pulse in the upcounting direction, the counter is reset to 0 and upcounting restarts.</p> <p>The maximum frequency applied to the IN_A input is 10 kHz.</p> <p>The smallest pulse applied to the IN_AUX input varies according to the selected filter level.</p> <p>The maximum frequency of the modulo event is one event every 25 ms.</p> <p>The maximum modulo value is 65,536 units.</p>
	Up/down counter	<p>This mode is used for an accumulation, upcounting, or downcounting operation on a single input.</p> <p>Each pulse applied to the IN_A input produces:</p> <ul style="list-style-type: none"> ■ Upcounting of pulses if the IN_AUX input is high ■ Downcounting of pulses if the IN_AUX input is low <p>The counter values vary between the limits -65,536 and +65,535.</p> <p>The maximum frequency applied to the IN_A input is 10 kHz.</p> <p>Pulses applied to the IN_A input after a change of direction are only upcounted or downcounted after a period corresponding to the delay for taking account of the state of the IN_AUX input due to the programmable filter level on this input.</p>
One 32-bit mode	32-bit counter counting	<p>32-bit counter counting mode is available for channels 0, 2, 4, and 6 (channels 1, 3, 5, and 7 are now inactive). It behaves in the same way as the up/down counting mode using up to three physical inputs. It enables simultaneous upcounting and downcounting.</p> <p>The counter values vary between the limits -2,147,483,648 and +2,147,483,647 (31 bits + sign).</p> <p>The maximum frequency applied to the IN_A and IN_B inputs is 10 kHz.</p> <p>The smallest pulse applied to the IN_AUX input is defined according to the filtering applied to this input.</p> <p>The maximum frequency of loading the preset value is one every 25 ms.</p>



BMXEHC0200



BMXEHC0800

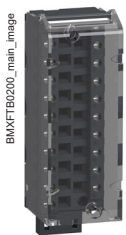

BMXFTB2000

References

Modicon X80 counter modules (1)

Description	No. of channels	Characteristics	Reference	Weight kg/lb
Counter modules for 24 V ---	2	60 kHz counting	BMXEHC0200	0.112/ 0.247
2- and 3-wire sensors and 10/30 V --- incremental encoders with push-pull outputs	8	10 kHz counting	BMXEHC0800	0.113/ 0.249

Connection accessories (2)

Description	Composition	Unit reference	Weight kg/lb
Pack of connectors for BMXEHC0200 module	Two 16-way connectors and one 10-way connector	BMXXTSHSC20	0.021/ 0.046
20-way removable terminal blocks for BMXEHC0800 module	Caged	BMXFTB2000	0.093/ 0.205
	Screw clamp	BMXFTB2010	0.075/ 0.165
	Spring	BMXFTB2020	0.060/ 0.132
Shielding connection kit for X80 counter modules	Comprising a metal bar and two support bases for mounting on backplane	See page 2/6	—

(1) Calculate the power consumption by using the online [Modicon PLC Configurator](#) tool.

(2) The shielding on the cordsets carrying the counter signals must always be connected to the [BMXXSP0000](#) shielding connection kit mounted under the backplane that holds the [BMXEHC0200](#) module (see [page 2/6](#)).

Modicon X80 modules

Modicon X80 expert modules

Time-stamping module



BMXERT1604T/BMXERT1604H

Presentation

The **BMXERT1604T/H** time-stamping module is a complete solution providing a SCADA with a sequence of events that are time-stamped at source, enabling the user to analyze the source of any abnormal behavior in an automated system.

The SOE (sequence of events) is displayed in the alarms log or in the list of events for a client such as a SCADA.

Each event in the SOE is a change of value (transition) of a discrete I/O detected by a time-stamping module.

Advantages

Using the time-stamping system has the following advantages:

- No PLC programming
- Direct communication between the time-stamping modules and the client; if the time-stamping modules are in a Quantum Ethernet I/O drop, the bandwidth of the PLC communication is not used
- Consistency of the I/O values between the process (time-stamping modules) and the client
- Consistency is maintained irrespective of the operating mode
- No loss of events under normal operating conditions
- Management of Hot Standby configurations on the PLC and/or SCADA redundancy

Composition of a time-stamping architecture

Modicon X80 remote I/O drop adapter

The **BMXERT1604T/H** module can be at the source of any discrete I/O signal located in the drop with a resolution of 10 ms. To help ensure no event is lost, all events are stored and kept in a buffer located in the product until OFS takes them.

The NTP protocol is used to synchronize the Modicon X80 remote I/O drop adapter (**BM●CRA312●0**).

Modicon X80 time-stamping module

The **BMXERT1604T/H** time-stamping module has 16 discrete inputs which carry out the time-stamping at source outputs with a resolution of 1 ms.

To help ensure no event is lost, all events are stored and kept in a buffer located in the product until OFS takes them.

This module can be placed either in an RIO drop or in a local rack equipped with a Modicon X80 remote I/O drop adapter which is synchronized via the DCF 77 or IRIG-B standards.

OFS V3.6 software

OFS V3.6 software is used to access events stored in the various buffers in the architecture and to place them in the SCADA via the standard OPC DA protocol. For further information, consult [our website](#).

AVEVA Plant SCADA

AVEVA Plant SCADA receives events transmitted by OFS and displays them in the SOE or in the list of alarms. For further information, consult our [TPP partner website](#).



Performance

Performance	Event source module	Value
Between two identical source modules in the same rack	BMXERT1604T	1.6 < resolution < 3.3 ms
	BMXERT1604H	
	BM●CRA31●10	10 ms
Between two different inputs in the same source module	BMXERT1604T	1 ms
	BMXERT1604H	
	BM●CRA31●10	1 scan
Maximum buffer	BMXERT1604T BMXERT1604H	255 groups (1)
Maximum number of discrete inputs/outputs monitored by the PLC for the entire time-stamping module	BMXERT1604T	400 discrete inputs (2)
	BMXERT1604H	
	BM●CRA31●10	2,048 discrete I/O (2)
Maximum number of I/O and memory available	BMXERT1604T	16 discrete inputs on module
	BMXERT1604H	255 groups (3)
	BM●CRA31●10	256 discrete I/O configured 4,000 events in internal buffer
Maximum number of source modules in an Ethernet remote drop	BM●CRA31●10	1 per drop
	BMXERT1604T	9 per drop
	BMXERT1604H	
Maximum number of sources of events polled by OFS	BMXERT1604T BMXERT1604H	500 sources per second (2)

References

Modicon X80 time-stamping modules

Description	Input type	Reference	Weight kg/lb
Multifunction time-stamping input module	16 discrete inputs	BMXERT1604T	0.119/ 0.262
Multifunction time-stamping input module for severe environments		BMXERT1604H	

Connection accessories for time-stamping modules

Description	For use with modules	Type, composition	Length	Reference	Weight kg/lb
28-way removable terminal blocks	BMXERT1604T BMXERT1604H	Caged	–	BMXFTB2800	0.111/ 0.245
		Spring	–	BMXFTB2820	0.080/ 0.176

(1) A group is a set of 1 to 16 events detected in the same cycle.

(2) This maximum value is not an absolute value. It depends on the overall system dynamics (total number of scanned items and number of events generated by the system).

(3) The event number contained in one group varies within 1..16. It depends on how many channels have the events occur within same sampling window (0.5 ms).

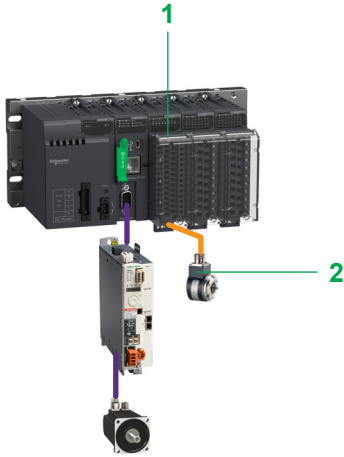

Modicon X80 modules with Modicon M340 processor

Presentation

The **BMXEAE0300** SSI encoder interface module (1) for the Modicon automation platform (1) is a 3-channel standard synchronous serial interface module designed for use with SSI absolute encoders (2).

The **BMXEAE0300** module enables SSI encoder values to be processed on PAC platforms for applications requiring accurate position/angular control, such as:

- Hydro power, e.g. dam inlet gate position control
- Wind power, e.g. wind turbine blade pitch control
- Complex motion loop control, e.g. ship elevator, blast furnace, flame cutting, etc.

The **BMXEAE0300** module provides a migration path from Premium (with **TSXCTY2C** measurement and counter module) to the Modicon X80 modules SSI solution to compete in the above market segments.

Like any other application-specific module, the **BMXEAE0300** module is installed in the rack slots (01 to 11). The number of modules is limited by the maximum number of application-specific channels permitted according to the CPU type (consult [our website](#)).

Dam inlet gate control

Inlet gate control enables the water level in a dam to be monitored and controlled:

- The SSI encoder provides the PLC with accurate feedback of the gate position for precise monitoring of gate opening, adjustment, and positioning.
- The SSI interface converts the signals from the SSI encoders and transmits them to the CPU.

Wind turbine blade pitch control

Pitch control is required for adjusting the angle of the wind turbine blades in relation to the wind direction and strength, in order to achieve optimum energy conversion efficiency.

- The SSI absolute encoder is frequently used to feed back the position of the blade due to its reliability and robustness.
- Typically, the position of each of the three blades is read by the SSI encoders and then transmitted to the CPU via the SSI interface for motion loop control. Sometimes, three additional SSI inputs act as backup. Therefore, this new offer is adequately sized for the channel density.

Description

The **BMXEAE0300** SSI encoder interface module is standard format (1 slot). Its housing provides IP20 protection of the electronics and it is locked in each slot (01 to 11) by a captive screw.

The front panel of the **BMXEAE0300** module features:

- 1 A rigid housing providing support and protection for the electronic card
- 2 The module reference marking (a label is also visible on the right-hand side of the module)
- 3 A display block indicating:
 - Module status via four LEDs:
 - RUN (green): module operating status
 - ERR (red): internal fault detected in the module or a fault detected between the module and the rest of the configuration
 - I/O (red): external fault detected
 - DL (green): firmware download status
 - Status of the 3 SSI channels via eight LEDs:
 - Sx (green): channel x input (x = 0, 1, or 2)
 - Qx (green): reflex output for channel x (x = 0, 1, or 2)
 - IO/1 (green): capture inputs for the three SSI channels
- 4 A connector for a 28-way terminal block, for connecting to a removable caged or spring terminal block on sensors and preactuators

To be ordered separately:

- 5 A **BMXFTB2800** 28-way removable caged terminal block or **BMXFTB2820** spring terminal block, supplied with a channel identification label (see [page 6/9](#))
 - A shielding connection kit to help protect against electrostatic discharge, consisting of a metal bar and two sub-bases for mounting on the rack: **BMXXSP●●00** (reference dependent on the number of slots in the rack) (see [page 2/6](#))
 - A set of clamping rings **STBXSP30●0** for the connection cable shielding braids (reference dependent on the cable diameter) (see [page 2/6](#))

(1) Only for the Modicon automation platforms compatible with Modicon X80 modules

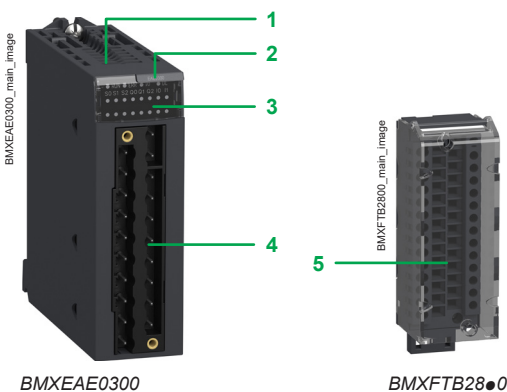

BMXEAE0300

BMXFTB2800

Modicon X80 modules

Modicon X80 expert modules

SSI encoder interface module

Module specifications and functions

Specifications

The **BMXEAE0300** SSI encoder interface module is a 3-channel, synchronous serial interface, absolute encoder interface for Modicon PLCs. It supports:

- 3 channels of SSI inputs (DATA pair, CLK pair, 24 VDC field power supply to encoder)
- 1 reflex output for each SSI channel (Q)
- 2 capture inputs for the 3 SSI channels (CAP_IN0, CAP_IN1)
- 8 to 31 bits data width
- 4 baud rates (100 kHz, 200 kHz, 500 kHz, and 1 MHz)
- Capture and compare functions

Basic and optional functions

The following table presents the main functions of the **BMXEAE0300** module:

Function	Basic/ optional	Description
Absolute SSI encoder value acquisition	Basic	The position values of the SSI channel are automatically read by the module within 1 ms, unless the channel is disabled.
Modulo	Optional for motion	The modulo function limits the dynamics of the position value to within the power of 2. An event (if enabled) detects the passing of the modulo. The reflex output can also be detected when the modulo is passed (if configured).
Reduction	Optional for motion	This function reduces the intrinsic resolution of the encoder by a value defined by the "reduction" parameter. This reduction is carried out by a shift in the bit field provided by the encoder.
Offset	Optional for motion	The correction function of the encoder offset systematically corrects the offset produced by the encoder at mechanical position "0". The user enters the absolute encoder offset parameter.
Capture	Optional for events	The two capture input registers (per channel) enable the PLC program to carry out a dynamic measurement function between two points. The capture action can be triggered by two capture inputs. The event will be triggered at each capture.
Compare	Optional for events	Two independent comparators (per channel), with thresholds that can be modified by adjustment (explicit exchange), are able to generate an event or reflex output when the threshold is crossed.

Main features

- Supported by EcoStruxure Control Expert (1).
- Supports absolute encoder 24 V model with standard SSI interface, including Telemecanique Sensors OsiSense SSI encoders. For further information, consult the [Telemecanique Sensors website](#).
- Standards and approvals: CE, UL, CSA, C-Tick, GOST, etc.



EcoStruxure Control Expert monitor



BMXEAE0300

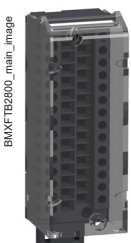

BMXFTB2800

References

Modicon X80 SSI encoder interface module (2)

Description	Number of channels	Description per channel	Reference	Weight kg/lb
SSI encoder interface module	3 SSI channels	1 reflex output for each SSI channel 2 capture inputs for the 3 SSI channels 8 to 31 bits data width 4 baud rates: 100 kHz, 200 kHz, 500 kHz, 1 MHz Capture and compare functions	BMXEAE0300	0.138/ 0.304

Cabling accessories

Description	Description, use	Reference	Weight kg/lb
28-way removable terminal block	Caged	BMXFTB2800	0.111/ 0.245
	Spring	BMXFTB2820	0.080/ 0.176
Shielding connection kit for BMXEAE0300 module (3)	Comprising a metal bar and two support bases for mounting on rack	See page 2/5	–

(1) EcoStruxure Control Expert software continues the range of Unity Pro software and corresponds to versions ≥ 14 of Unity Pro.

(2) Calculate the power consumption by using the online [Modicon PLC Configurator](#) tool.

(3) The shielding on the cables carrying the power supply to the module, each SSI channel, the capture inputs, and the reflex outputs (if any of them is wired) must always be connected to the **BMXXSP●●00** shielding connection kit mounted under the rack holding the **BMXEAE0300** module (see [page 2/6](#)).

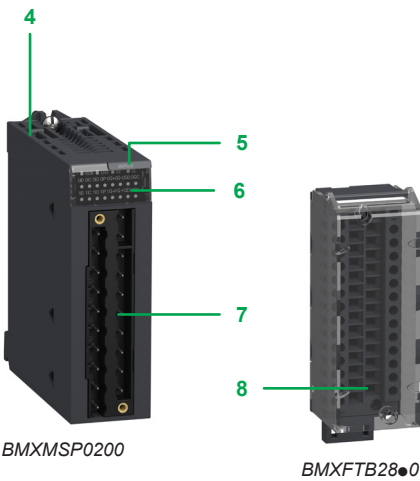
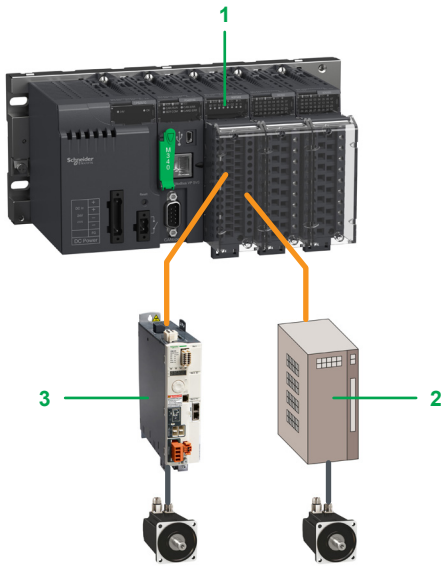

BMXMSP0200

BMXFTB2800



DIA6ED2151012EN

Presentation

The **1 BMXMSP0200** motion control pulse train output (PTO) module for the Modicon automation platform is used for controlling third-party variable speed drives **2**, which have an integrated position loop and inputs that are compatible with open collector outputs.

The **BMXMSP0200** motion control module is also directly compatible with the Lexium 32C and 32M **3** servo drive ranges, which have an integrated pulse control interface.

The **BMXMSP0200** motion control PTO module has two independent PTO channels. Like any other application-specific module, it is installed in the rack slots (labeled **01** to **11**). The number of modules is limited by the maximum number of application-specific channels permitted according to the CPU type:

- Standard **BMXP341000**: Maximum of 20 application-specific channels (1)
- Performance **BMXP342000**: Maximum of 36 application-specific channels (1)
- **BMEP5810**: Maximum of 24 application-specific channels (1)
- **BMEP5820**: Maximum of 32 application-specific channels (1)
- **BMEP5830** and **BMEP5840**: Maximum of 64 application-specific channels (1)
- **BMEP585040**: Maximum of 180 application-specific channels (1)
- **BMEP586040**: Maximum of 216 application-specific channels (1)

Description

The **BMXMSP0200** motion control module is standard format (1 slot). Its housing provides IP20 protection of the electronics and it is locked in each slot (**01** to **11**) by a captive screw.

The front panel of the **BMXMSP0200** motion control module features:

- 4** A rigid body providing support and protection for the electronic card
- 5** A module reference marking (a label is also visible on the right-hand side of the module)
- 6** A display block indicating:
 - Module status via four LEDs (RUN, ERR, I/O, and DL)
 - Status of the auxiliary inputs, 4 per channel
 - Status of the PTO outputs, 2 per channel
 - Status of the auxiliary outputs, 2 per channel
- 7** A connector for a 28-way terminal block, for connecting to a removable spring terminal block on sensors and preactuators

To be ordered separately:

- 8** A **BMXFTB2800** 28-way removable caged terminal block or **BMXFTB2820** spring terminal block, supplied with a channel identification label (see [page 6/11](#))
- A shielding connection kit to help protect against electrostatic discharge, consisting of a metal bar and two sub-bases for mounting on the rack: **BMXXSP0000** (reference dependent on the number of slots in the rack) (see [page 2/6](#))
- A set of clamping rings **STBXSP3000** for the connection cable shielding braids (reference dependent on the cable diameter) (see [page 2/6](#))

(1) Application-specific channels: **BMXEHC0200** (2-channel) and **BMXEHC0800** (8-channel) counter modules, **BMXMSP0200** (2-channel) motion control module, **BMXNOM0200** (2-channel) and **BMXNOR0200H** (1-channel) serial communication modules, **BMEAH10812** (8-channel) analog input module and **BMEAH00412** (4-channel) analog output module, **BMXEA0300** (3-channel) SSI module and **BMXERT1604T/H** (16-channel) discrete input module.

Operation

Block diagram of a BMXMSP0200 module channel

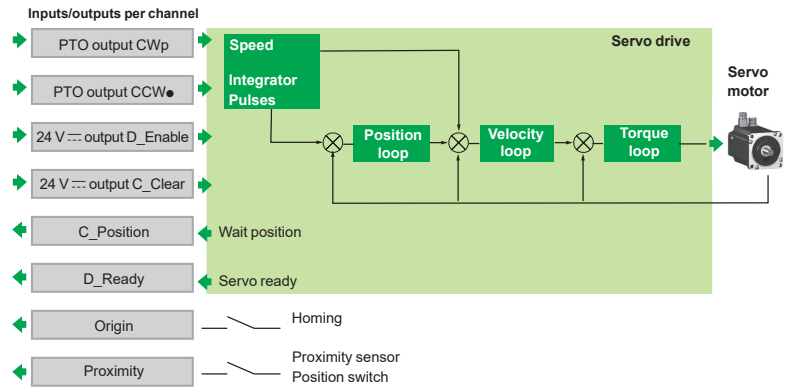

References

Modicon X80 motion control module (1)

Description	Number of channels	Description per channel	Reference	Weight kg/lb
PTO module	2	2 x 200 kHz max. PTO outputs 2 x 24 V ~/50 mA auxiliary outputs 4 x 24 V ~ auxiliary inputs	BMXMSP0200	0.145/ 0.320

Cabling accessories

Description	Description, use	Length	Reference	Weight kg/lb
28-way removable terminal block	Caged	–	BMXFTB2800	0.111/ 0.245
	Spring	–	BMXFTB2820	0.080/ 0.176

Connection cable for daisy chain or pulse control (2)	From BMXMSP0200 (screw clamp terminal block) module to Lexium 32C or 32M (RJ45 connector) (cable with flying leads at one end and an RJ45 connector at the other)	3 m/9.84 ft	VW3M8223R30	–
---	---	-------------	-----------------------------	---

Shielding connection kit for module BMXMSP0200	Comprising a metal bar and two support bases for mounting on rack	–	See page 2/6	–
--	---	---	------------------------------	---

(1) Calculate the power consumption by using the online [Modicon PLC Configurator](#) tool.
 (2) The shielding on the cordsets carrying the motion control signals must always be connected to the [BMXXSP●●00](#) shielding connection kit mounted under the rack holding the [BMXMSP0200](#) module (see [page 2/6](#)).



BMXMSP0200

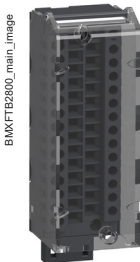

BMXFTB28●0

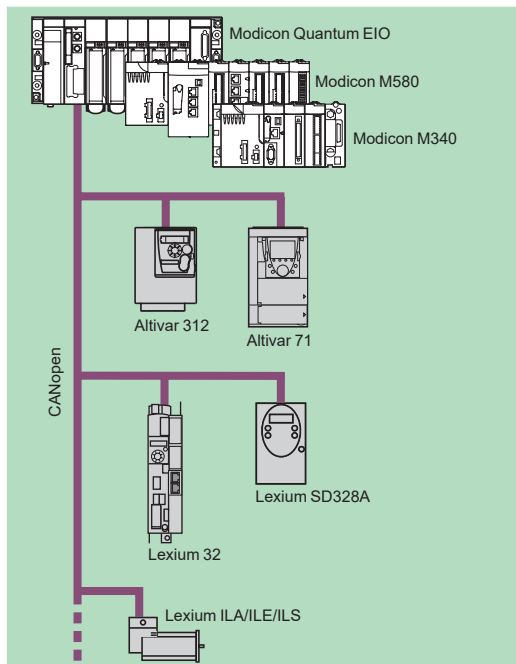

MFB: Motion control distributed over CANopen



Presentation

MFB (Motion Function Blocks) is a library of function blocks integrated in EcoStruxure Control Expert (1) used to set up motion control in the architectures of drives and servo drives on CANopen buses:

- Altivar 312: For asynchronous motors from 0.18 to 15 kW/0.25 to 20 HP
- Altivar 71: For synchronous or asynchronous motors from 0.37 to 500 kW/0.5 to 700 HP
- Lexium 32: For servo motors from 0.15 to 7 kW/0.20 to 10 HP
- Lexium ILA/ILE/ILS: Integrated motor drives from 0.10 to 0.35 kW/0.13 to 0.47 HP
- Lexium SD328A: For 3-phase stepper motors from 0.35 to 0.75 kW/0.47 to 1 HP

In compliance with PLCopen specifications, the MFB library allows both easy and flexible motion programming with EcoStruxure Control Expert (1), as well as axis diagnosis.

In maintenance operations, drives can be replaced quickly thanks to drive parameter download blocks.

Setting up drives on the CANopen network is facilitated through Motion Tree Manager organization in the EcoStruxure Control Expert (1) browser, making it easy for users to access the application drives.

Applications

The features of the MFB library are particularly suitable for machines with independent axes. In the case of these modular/special machines, MFBs are an ideal solution for controlling single axes. The following are typical applications for this type of architecture:

- Automatic storage/removal
- Material handling
- Palletizers/depalletizers
- Conveyors
- Packaging, simple labeling application
- Grouping/ungrouping
- Adjustment axes in flexible machines, etc.

Functions

The table below lists the function blocks of the MFB library and the compatible drives. The prefix indicates the block family:

- MC: Function block defined by the Motion Function Block PLC open standard
- TE: Function block specific to Schneider Electric products
- Lxm: Function block specific to Lexium servo drives

Type	Function	Function block	Altivar 312	Altivar 71	Lexium 32	Lexium ILA/ILE/ILS	Lexium SD328A
Management and motion	Read an internal parameter	MC_ReadParameter					
	Write an internal parameter	MC_WriteParameter					
	Read the current position	MC_ReadActualPosition					
	Read the instantaneous speed	MC_ReadActualVelocity					
	Acknowledge detected error messages	MC_Reset					
	Stop any active movement	MC_Stop					
	Axis coming to standstill	MC_Power					
	Movement to absolute position	MC_MoveAbsolute					
	Relative movement	MC_MoveRelative					
	Additional movement	MC_MoveAdditive					
	Homing	MC_Home					
	Movement at given speed	MC_MoveVelocity					
	Read diagnostic data	MC_ReadAxisError					
	Read servo drive status	MC_ReadStatus					
	Torque control	MC_TorqueControl					
	Read actual torque value	MC_ReadActualTorque					
Manual control	MC_Jog						
Save and restore parameters (FDR)	Read drive parameters and store in PLC memory	TE_UploadDriveParam					
	Write drive parameters from PLC memory	TE_DownloadDriveParam					
Advanced Lexium functions	Read a motion task	Lxm_UploadMTask					
	Write a motion task	Lxm_DownloadMTask					
	Start a motion task	Lxm_StartMTask			(1)		
	Set the reduction ratio, signed	Lxm_GearPosS			(1)		
System	Communication with the servo drive	TE_CAN_Handler					

Compatible

(1) The Lxm_StartMTask and Lxm_GearPosS function blocks are only compatible with Lexium 32 (LXM32M) servo drives.

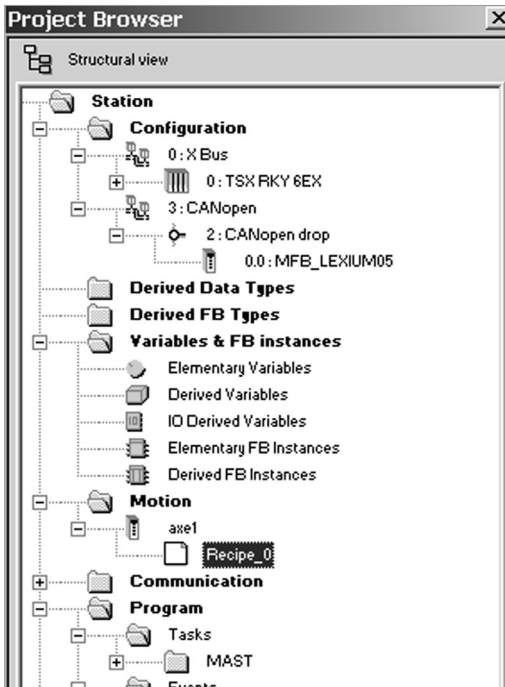

Motion Tree Manager integrated in the EcoStruxure Control Expert browser

Motion Tree Manager

Motion Tree Manager is associated with the MFB library in EcoStruxure Control Expert (1) and integrated in its browser. It provides specific assistance for:

- Axis object management
- Axis variable definition
- Drive parameter management

Motion Tree Manager automatically creates links between the CANopen bus configuration and the MFB function block data using a limited amount of configuration data.

General axis parameters

In this tab, the designer is prompted to define:

- The name of the axis that will identify it in the browser for the entire application
- The address of the drive on the CANopen bus

Axis parameters

The drop-down lists in this tab are used to determine the exact type of drive: family, version.

Variable names

This last tab is used to identify data structures:

- **Axis_Reference**: Used by the function block instances for the axis in question
- **CAN_Handler**: Used to manage communication with the drive via the CANopen network

Recipe definition

The recipes attached to the axis are the data structures containing the adjustment parameters of a given drive. This data is used when:

- Changing the drive with restoration of the context during “Fast Device Replacement” (FDR) maintenance
- Changing the manufacturing program of the machine and calling up an appropriate set of parameters: servo control gains, limitations, etc. adapted to the weight and size of the moving parts
- Saving parameters in the initial values of the PLC application

Programming, diagnostics, and maintenance

Communication between the PLC and drive is automatically set up by the system as soon as a TE_CAN_Handler instance is declared in the EcoStruxure Control Expert (1) task with which the axis is associated. Movements are then programmed by sequencing function blocks from the library in the user’s chosen EcoStruxure Control Expert (1) editor (LD, ST, FBD).

The two function blocks, MC_ReadStatus, and in some cases MC_ReadAxisError, are useful for determining the overall status of the axis, as well as the code of the active detected errors.

The function blocks TE_UploadDriveParam and TE_DownloadDriveParam allow the application to save the drive parameters (recipe) and to then quickly reload them into another drive when it is necessary to change the original one.

(1) EcoStruxure Control Expert software continues the Unity Pro range of software and corresponds to versions ≥ 14 of Unity Pro.

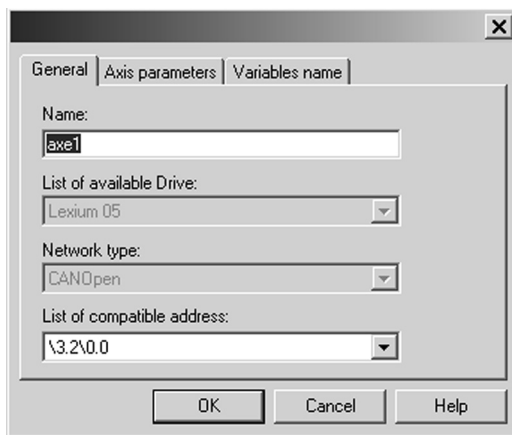

General parameters: Axis name and address

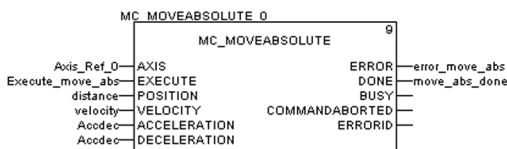

MFB: Programming a movement in absolute mode

Modicon X80 modules

Modicon X80 expert modules

Frequency input module

Presentation

The **BMXETM0200H** frequency input module offers turbine shaft and engine speed monitoring functionality for general purpose turbomachinery control (TMC) applications. It can be integrated into Modicon M340 and M580 standard and high-availability systems.

TMC applications include prime movers, driven equipment, auxiliaries, mechanical retrofits, and protection. With the Modicon Package solution, the frequency input and measurement function is available for the following general purpose TMC application types:

- Large hydro turbines
- Small steam turbine generators
- Small hydro turbines
- Small mechanical drive gas turbines
- Diesel generators
- Reciprocating compressors
- Packaged air compressors
- Single-stage mechanical drive turbines: pumps

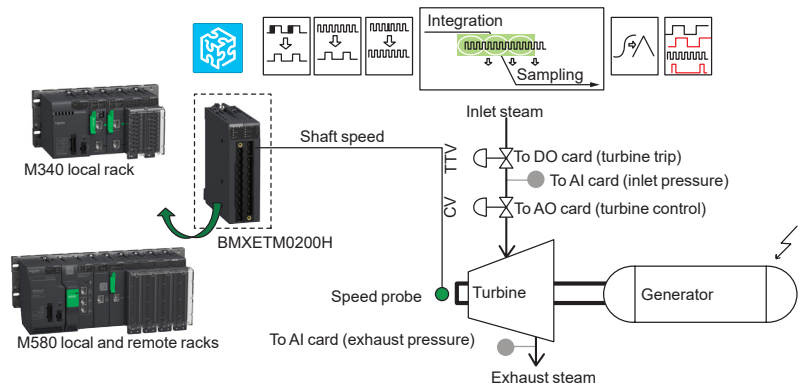

TMC governor control system architecture

Functionality

The purpose of the **BMXETM0200H** module is to monitor the turbine shaft or engine speed. It is designed to receive electrical pulses generated by the gear tooth sensing probe, cam, and crank etc. and convert these pulses into a numerical value. The measured value of the turbine shaft rotating velocity is highly accurate with a fast refresh rate.

With the **BMXETM0200H** module providing frequency input and measurement, Modicon PACs build up a closed loop control system as part of the turbomachinery governor. This control mechanism will automatically track and direct the speed of driven equipment (such as a generator or compressor) and a prime mover (such as a turbine or engine) under varying load conditions with the aim of:

- maintaining the selected speed
- limiting slow and fast speeds
- helping to protect mechanical parts and customer investment by anticipating overspeeds by means of its acceleration and jerk detection capability

6

BMXETM0200H_main_image



BMXETM0200H

Modicon X80 modules

Modicon X80 expert modules

Frequency input module

Module specifications

Availability and compatibility

Available for Modicon M340 and M580 standalone and HSBY platforms, on local rack or RIO rack with hot swapping supported.

Ambient operating temperature

Hardened with extended temperature range from $-25\dots70\text{ }^{\circ}\text{C}/-13\dots158\text{ }^{\circ}\text{F}$ and conformal coating.

Measurement performance

Two frequency input channels for 1 V and 1 Hz signal up to a maximum of 500 KHz with 100 KHz, 10 KHz, and 1 KHz input filters.

Supported signal source device type

Speed sensor inputs support passive pickup, active speed sensor (output OC, TTL, ST), potential transformer, and incremental encoder.

Digital reflex outputs

One positive 24 VDC reflex digital output per channel controlled from an embedded comparator.

Error detection

Detects broken wire and probe health status.

Dedicated TMC functions

A set of dedicated TMC functions for turbine shaft monitoring, including:

- Frequency pattern recognition up to 512 pulses per pattern
- Acceleration and jerk detection
- Phase angle and ratio detection between channels
- Scaling factor for RPM measurement up to 1,024 teeth per revolution
- Alarm bits that can be time-stamped by the Modicon M580 controller

Software configuration

Configurable using EcoStruxure Control Expert (1) or Unity Pro \geq V11 (S, L, and XL) with TMC Hotfix integrated.

Reference

Modicon X80 Frequency input module

Description	Composition	Reference	Weight kg/lb
Turbomachinery frequency input module (2 channels) for severe environments	1 ms cycle time	BMXETM0200H	0.124/ 0.273
	2 digital reflex outputs		
	2 discrete inputs (for frequency measurement functions)		

(1) EcoStruxure Control Expert software continues the Unity Pro range of software and corresponds to versions \geq 14 of Unity Pro.

Technology
Partner

Schneider
Electric

PMESWT0100 Scaime partner
weighing module

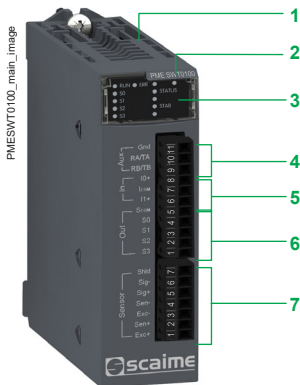

PMESWT0100

6

Presentation

The **PMESWT0100** Scaime partner weighing module can be installed in:

- a Modicon automation platform including a dual X-bus and Ethernet **BMEXBP●●00(H)** backplane and a Modicon M580 **BMEP58●0●0** PLC, or
- a Modicon X80 RIO drop including a dual X-bus and Ethernet **BMEXBP●●00(H)** backplane and a **BMECRA31210** adapter.

With this module, it is possible to go beyond the scope of a simple weighing application: it is suitable for static weighing applications such as silo level measurement and scale weighing; it is also well suited to low-speed dynamic weighing applications such as filling, dosing, and material transfer.

The Modicon PLC can manage the whole weighing environment as well as the whole machine or industrial process associated with the weighing system: weighing data is accessible by the PLC via implicit exchanges or explicit commands. Once the weighing signal is received, it is processed and transferred by the weighing module to the Modicon M580 PLC via the Ethernet backbone.

This Ethernet weighing transmitter offline configuration, online calibration, monitoring, and weighing diagnostics are achieved using EcoStruxure Control Expert (1) software via FDT/DTM.

The Scaime partner weighing module has been developed to comply with the general standards and certifications of the Modicon X80 modules. For more information, see [page 10/2](#) or consult [our website](#).

Description

The **PMESWT0100** weighing module features the following:

- 1 A rigid body providing support and protection for the electronic card
- 2 A module reference marking (a label is also visible on the right-hand side of the module)
- 3 A module and channel status display block
- 4 Screw clamp terminals for connecting an external HMI output
- 5 Screw clamp terminals for connecting discrete reflex inputs
- 6 Screw clamp terminals for connecting discrete reflex outputs
- 7 Screw clamp terminals for connecting input load cells

Main characteristics

Measurement input

One weighing channel per module, comprising up to eight load cells connected via junction box

Input load cell supply voltage

5 V $\overline{\text{DC}}$

Internal resolution

24-bit converter

User resolution

Up to 1,000,000, factory-calibrated 500,000 at 2 mV/V

Internal measurement rate

6 to 400 measurements per second

External measurement rate

100 measurements per second

Discrete reflex outputs

Number of applications

4 positive logic outputs, 2 for dosing and 2 for threshold monitoring

Maximum voltage

55 V $\overline{\text{DC}}$

Nominal current

400 mA

Response time

2 ms discrimination

Discrete inputs

Number of applications

2 positive logic inputs, weighing functions

Low voltage range

0...3 V $\overline{\text{DC}}$

High voltage range

9...28 V $\overline{\text{DC}}$

High current

20 mA at 24 V $\overline{\text{DC}}$

(1) EcoStruxure Control Expert software continues the Unity Pro range of software and corresponds to versions ≥ 14 of Unity Pro.

Modicon X80 modules

Modicon X80 expert modules

Weighing module



PMESWT0100

References

Modicon X80 weighing module

Description	Composition	Reference	Weight kg/lb
Scaime partner weighing module (1) (1 weighing channel per module)	- Load cell input 100 measurements/s (for 1 to 8 load cells) - 4 discrete reflex outputs (for threshold monitoring and dosing) - 2 discrete inputs (for weighing functions) - 1 output for an external HMI	PMESWT0100 (2)	0.233/ 0.514

Technology
Partner

Schneider
Electric

(1) Partner Product, sold by SE and Scaime. Supported by Scaime, see [our website](#).

(2) To order this product, please contact our Customer Care Center.

Selection guide page 7/2

Modicon X80 remote I/O drop adapters

- **Modicon X80 offer presentation** page 7/4
- **Characteristics** page 7/4
- **Performance and Standard adapters** page 7/5

Modicon X80 peripheral remote I/O drop adapter

- **Presentation** page 7/7
- **Description, references** page 7/7

Modicon X80 modules

Modicon X80 I/O expansion modules

Applications	RIO drop adapter	RIO drop adapter	RIO drop adapter
Type of device	Standard	Performance	Performance
Network protocols	EtherNet/IP		
Racks	Up to 2		
Structure	10BASE-T/100BASE-TX		
Physical interface	2x RJ45:		
Type of connector	■ 2 connectors for RIO network (RSTP ring topology)	3x RJ45:	3x RJ45:
Ethernet backplane connection	No	■ 1 connector for service	■ 1 connector for service
Access method	CSMA-CD	■ 2 connectors for RIO network (RSTP ring topology)	■ 2 connectors for RIO network (RSTP ring topology)
Data rate	10/100 Mbps	Yes	Yes
Medium	Double shielded twisted pair copper cable, category CAT 5E		
Dimensions	32 x 100 x 86 mm / 1.25 x 3.93 x 3.38 in.		
Remote X80 I/O	Up to 128	Up to 1,024	
Maximum number of discrete I/O modules	Up to 16	Up to 256	
Maximum number of analog I/O modules			
I/O modules supported	All BMXA●●●●●●		
Analog I/O	All BMXD●●●●●●		
Discrete I/O			BMEAH0812/BMEAHO0412
HART integrated analog I/O modules			
Communication modules supported		BMXNOM0200	BMXNOM0200
Serial link		BMXEIA0100	BMXEIA0100
AS-i			PMEPXM0100 (1)
PROFIBUS DP			BMECXM0100 (1)
CANopen			BMENOS0300
Network option switch			
Expert modules supported		BMXEHC0200/BMXEHC0800	BMXEHC0200/BMXEHC0800
Counter		BMXERT1604T/H	BMXERT1604T/H
Time- and date-stamping		BMXEAE0300	BMXEAE0300
SSI encoder interface module		BMXETM0200H	BMXETM0200H
Frequency input			PMESWT0100
Weighing			
Standard services	No	Yes	
CCOTF (Change Configuration on the Fly)	Yes		
Diagnostics for remote I/O devices (DDT)	No	Yes	
Port mirroring	No	10 ms	
System time-stamping	No	Yes	
Non-interfering Type 1	Yes (logical, 50 ms recovery time)		
Network redundancy	No		
Module redundancy	■ Input data is collected and published to the remote I/O head adapter		
I/O service	■ Output modules are updated with the data received from the remote I/O head adapter		
Communication services	Yes		
EtherNet/IP adapter	Yes		
QoS (Quality of Service)	Yes		
RSTP media redundancy	Yes		
NTP/SNTP time synchronization	SNTP (Client)		
FDR service	Yes (Client)		
SNMP network management	SNMPV1 (Agent)		
Syslog	Yes (Client)		
CIP explicit messaging (Server)	Yes		
Modbus/TCP server for module diagnostics	Yes		
Compatibility with processor	Modicon M580 BMEP58●●40(S) Modicon M580 BMEH58●●40(S) Modicon Quantum		Modicon M580 BMEP58●●40(S) Modicon M580 BMEH58●●40(S)
References	BMXCRA31200	BMXCRA31210	BMECRA31210
Page	7/6		

(1) Not supported in a remote rack in a hot standby configuration

Modicon X80 modules

Modicon X80 I/O expansion modules

Remote I/O drop adapter



BMECRA31210

Modicon X80 remote I/O drop adapters

Offer presentation

A Modicon M580 Ethernet RIO (EIO) architecture with Modicon X80 I/O drops requires the use of Modicon X80 remote I/O drop adapters in each remote rack to connect Modicon X80 I/O, communication, and expert modules.

The remote I/O drop adapter connects to the RIO network to help ensure network determinism on a dedicated private network connected to the Modicon M580 CPU. The Modicon X80 modules are integrated and seen by the EcoStruxure Control Expert engineering software as if they were local I/O, with a high-level of integration in terms of configuration and diagnostics.

The Modicon X80 offer comprises three I/O drop adapters:

- Performance drop adapters **BMECRA31210** and **BMXCRA31210**
- Standard drop adapter **BMXCRA31200**

For severe environments, **BM●CRA31210** adapters are also available in a conformal coating version (suffix "C"): see [page 9/3](#) for more details.

Adapter compared suitability

According to the considered RIO architecture, each I/O drop adapter presents the most suitable features as shown in the table below:

Modicon X80 I/O drop adapter	Communication		Safety		Controllers	
	Ethernet	X-Bus	Safety	Non-Safety	Quantum	M580
BMXCRA31210 (C)		☑	☑	☑	☑	☑
BMXCRA31200		☑		☑	☑	☑
BMECRA31210 (C)	☑	☑	☑	☑		☑

Characteristics

Connecting I/O drop adapters

Each adapter uses one slot in the Modicon X80 rack and is connected by Ethernet cordsets equipped with RJ45 connectors.

Depending on the distance between the main local rack and remote drops, RIO drop adapters are connected via copper cable (up to 100 m) or fiber optic cable (up to 15 km). A DRS switch may be used to extend the distance between devices connected via fiber optic cable.

Supported modules

Depending on the model, Modicon X80 remote I/O drop adapters support various types of module (1):

- All Modicon X80 I/O modules (HART I/O modules only supported by **BMECRA31210**)
- Modicon X80 communication modules (except for **BMXCRA31200**), like serial link, AS-Interface, PROFIBUS DP, CANopen, and network option switch modules
- Modicon X80 expert modules (except for **BMXCRA31200**), like counter, time-stamping, SSI encoder, frequency input, and weighing modules

Redundancy

Redundancy brings service continuity by helping to prevent process downtime and facilitating reparability and maintenance.

With **BM●CRA312●0** adapters, the dual Ethernet network connection port allows daisy chain loop connections using the RSTP protocol (Rapid Spanning Tree Protocol), in a ring topology.

(1) Please refer to the selection guide on [page 7/2](#) for details.



DIA6ED2151012EN

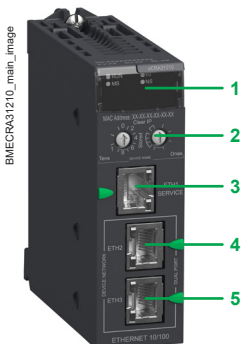

BMECRA31210

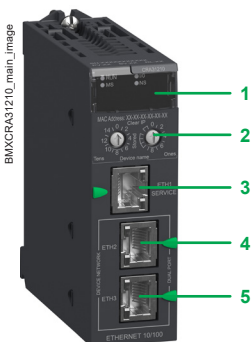

BMXCRA31210

Modicon X80 remote I/O drop adapters (continued)

Performance remote I/O drop adapter BMECRA31210

Presentation

The **BMECRA31210** Performance RIO drop adapter is designed to be installed on an Ethernet backplane in the main remote rack (only one **BMECRA31210** module installed per Modicon X80 RIO drop). This module can also support a

BMXXBP●●00 expansion rack. The **BMECRA31210** adapter supports the following:

- Both Ethernet and X-bus communications across the remote backplane
- Modicon X80 I/O and TPP partner modules with both Ethernet and X-bus connections (1)
- All expert modules (e.g. counter and weighing modules) and communication modules (e.g. serial, PROFIBUS)
- Time-stamping, which can be managed with a resolution of 10 ms for Modicon X80 RIO drops on an Ethernet backplane
- Change Configuration on the Fly (CCOTF)

Description

- 1 LED display block indicating the module status
- 2 Rotary switches for setting the address of an EIO drop (00...159)
- 3 Dedicated RJ45 service port (ETH 1) for remote service tools such as a PC, HMI terminal module, or Ethernet DIO devices
- 4 RJ45 device network port (ETH 2) for connection to the Ethernet network
- 5 RJ45 device network port (ETH 3) for connection to the Ethernet network

Note: The keying pin on the rear side of the module helps to ensure that the **BMECRA31210** adapter cannot be installed on unsupported backplanes.

Performance remote I/O drop adapter BMXCRA31210 (2)

Presentation

The **BMXCRA31210** Performance RIO drop adapter is designed to be installed on an Ethernet backplane in the main remote rack (only one **BMXCRA31210** module installed per Modicon X80 RIO drop). This module can also support a **BMXXBP●●00** expansion rack.

The **BMXCRA31210** adapter supports:

- X-bus communications only across the remote backplane
- Modicon X80 I/O and partner modules only with X-bus connections
- Several expert modules, such as counter modules, as well as Change Configuration on the Fly (CCOTF)
- Time-stamping, which can be managed with a resolution of 10 ms for Modicon X80 RIO drops on an Ethernet backplane

Description

- 1 Display block indicating the module status
- 2 Rotary switches for addressing EIO drops (00...159)
- 3 Dedicated RJ45 service port for remote service tools such as a PC, an HMI terminal, or Ethernet DIO devices (identical to the SERVICE port on Quantum CRP/CRA modules, see [page 2/7](#))
- 4 RJ45 device network port (ETH 2) for connection to the Ethernet network
- 5 RJ45 device network port (ETH 3) for connection to the Ethernet network

(1) This module is also compatible with X-bus backplanes. In this case it has the same functionality as a **BMXCRA31210** Performance Ethernet drop adapter. For more details, see [our website](#).

(2) Also compatible with Quantum PLC.

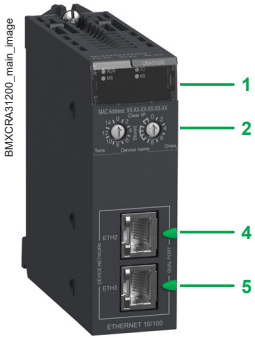

BMXCRA31200

Modicon X80 remote I/O drop adapters (continued)

Standard remote I/O drop adapter BMXCRA31200 (1)

Presentation

The **BMXCRA31200** Standard RIO drop adapter is a basic adapter designed to be installed on an Ethernet backplane in the main remote rack (only one The **BMXCRA31200** module installed per Modicon X80 RIO drop and no expansion rack allowed).

BMXCRA31200 Standard adapter supports:

- X-bus communications only across the remote backplane
- Only Modicon X80 I/O discrete and analog modules (except for HART I/O modules). Neither expert nor communication modules are supported
- No time-stamping, no Change Configuration on the Fly (CCOTF)

Description

- 1 Display block indicating the module status
- 2 Rotary switches for addressing EIO drops (00...159)
- 4 RJ45 device network port (ETH 2) for connection to the Ethernet network
- 5 RJ45 device network (ETH 3) port for connection to the Ethernet network

References

Modicon X80 remote I/O drop adapters

Description	Service port	Device ports	Height mm/in	Reference	Weight kg/lb
Modicon X80 RIO drop adapter (Standard)	1	2 (RSTP) RIO network	100/3.93	BMXCRA31200	0.225/0.496
Modicon X80 RIO drop adapters (Performance)	1	2 (RSTP) RIO network	100/3.93	BMECRA31210	0.225/0.496
		2 (RSTP) RIO network	100/3.93	BMXCRA31210	0.225/0.496

(1) Also compatible with Quantum PLC

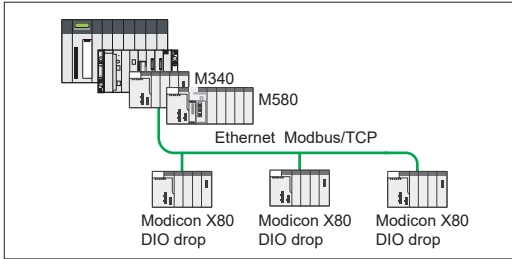

Modicon X80 DIO drops in an Ethernet Modbus/TCP network

Presentation

The **BMXPRA0100** peripheral remote I/O adapter is dedicated to Modicon X80 DIO drops in a Modicon M340 or Modicon M580 I/O architecture using Ethernet Modbus/TCP.

The **BMXPRA0100** module manages a remote X80 I/O rack on Ethernet Modbus/TCP which includes:

- discrete I/O modules
- analog I/O modules

It communicates by I/O scanning with the master PAC (Modicon M340 or Modicon M580).

In case of a redundant Ethernet link, the use of a **BMXNOE0100** Ethernet module is required.

Main characteristics

Primary racks per drop

Up to 4

Discrete I/O modules

Up to 1,024

Analog I/O modules

Up to 256

Internal memory

Up to 448 Kbits

Memory card capacity

Up to 96 Kbits

Average consumption

95 mA

Dissipated power

2.3 W

Real time clock with battery backup

Yes

Description

- 1 Module reference
- 2 Display block indicating the module status
- 3 Memory card port with protective cover
- 4 RJ45 Ethernet port

Reference (1)

Description	Reference	Weight kg/lb
Modicon X80 peripheral remote I/O adapter Provides 1 module per Ethernet Modbus/TCP DIO drop	BMXPRA0100	—

(1) Requires Unity Pro software ≥ V4.1 or EcoStruxure Control Expert

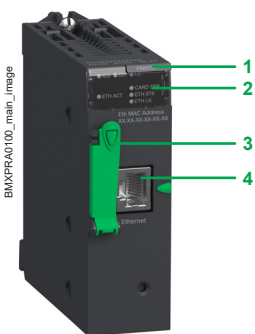

Modicon X80 peripheral remote I/O adapter

Selection guide page 8/2

Modicon X80 AS-Interface module

- Presentation, description page 8/4
- Diagnostics, references page 8/5

Modicon X80 Modbus and Character mode serial link module

- Presentation, description page 8/6
- Characteristics, references page 8/7

Modicon X80 CANopen module

- Presentation, description page 8/8
- Diagnostics, references page 8/9

Modicon X80 PROFIBUS DP module

- Presentation, description, architecture page 8/10
- Software configuration, diagnostics, references page 8/11

Modbus Plus Proxy

- Presentation, description page 8/12
- References page 8/13

Modicon X80 fiber converter modules

- Presentation, description page 8/14
- References page 8/14

Modicon X80 Ethernet switch module

- Presentation, description page 8/15
- References page 8/15

* Communication modules specific to Modicon M580 ePAC or Modicon M340 PAC are not described in this chapter, please refer to the Modicon M580 and Modicon M340 catalogs.

Modicon X80 modules

Modicon X80 communication modules

Applications	AS-Interface communication	Serial link communication	CANopen communication	PROFIBUS communication	Modbus Plus communication
Type of device	AS-Interface module	Modbus and Character mode serial link module	CANopen module	PROFIBUS DP module	Modbus plus proxy



Network protocols		AS-Interface	Modbus and Character mode	CANopen	PROFIBUS DP	Ethernet Modbus/TCP	Modbus Plus
Structure	Physical interface	AS-Interface V3 standard	<ul style="list-style-type: none"> Non-isolated: RS-232, 8-wire Isolated: RS-485, 2-wire 	ISO 11898	RS-485	10/100BASE-TX	RS-485
	Type of connector	3-way SUB-D	1x RJ45 and 2x RJ45	9-way SUB-D male	9-way SUB-D female	2x RJ45	2x 9-way female SUB-D
	Access method	Server/Client	–	Server/Client	Server/Client, Token passing	CSMA/CD	HDLC -Token passing
	Data rate	167 Kbps	0.3...115.2 Kbps in RS-232 0.3...57.6 Kbps in RS-485	500 Kbps at 100 m/328 ft 1 Mbps at 20 m/65 ft	9.6 Kbps at 1,200 m/3937 ft 12 Mbps at 100 m/328 ft	10/100 Mbps	1 Mbps
Medium		2-wire AS-Interface cable	Shielded twisted pair copper cable	Shielded twisted pair copper cable	Shielded twisted pair copper cable	Double shielded twisted pair copper cable, category CAT 5E (direct or crossover)	Shielded twisted pair copper cable
Configuration	Maximum number of devices	62 clients	2 per drop, 16 per Ethernet remote I/O (RIO) network max.	63 clients	10 masters, 125 clients	128	32 per segment 64 for all segments
	Maximum length	100 m/328 ft, 500 m/1,640 ft max. with 2 repeaters	15 m/49 ft with non-isolated RS-232, 1,000 m/3,280 ft with non-isolated RS-485	100 m/328 ft 2.5 m/8.2 ft with repeater	1,200 m/3937 ft per segment	100 m/328 ft	450 m/1476 ft per segment 1.8 m/5.9 ft with 3 repeaters
	Number of links of the same type per station	BMXP341000 processor: 2x AS-Interface modules	20/36 application-specific channels with BMXP341000/BMXP342000 (1 application-specific channel = 1 counter, motion control, or serial link module channel)	Limitation depends on number of available Ethernet slots in Modicon M580 local and remote racks	Up to 10 PMEPXM0100 modules in total with a Modicon M580 BMEP586040 processor	1 TCSEGDB23F24FA max.	
		BMXP342000 or BMEP58 processor: 4x AS-Interface modules	36 application specific channels max. 6x BMXNOM0200 modules per BM•CRA31010 Ethernet drop adapter	Each BMECXM0100 counts as a DIO device. Number of DIO devices depends on CPU/NOC capacity and IO scanner memory			
		BM•CRA31210 Ethernet drop adapter: 2x AS-Interface modules	All M580 processors: 36 application-specific channels	–			
Standard services	Transparent exchanges with sensors/actuators	Read/write bits and words, Diagnostics in Modbus mode	–	Transparent exchanges with CANopen clients and Ethernet-based processors	Cyclic data exchange (master class1) Acyclic data exchange (master class2)	Modbus/TCP messaging	Modbus Plus messaging
Conformity class	M4 profile	–	–	EDS description files of the clients	PI International certified	–	–
Communication services	Gateway DTM	No	No	Yes	Yes	No	No
	FDR service	No	No	Yes	Yes	Yes	No
	SNMP network management	No	No	Yes (Agent)	Yes (Agent)	Yes (Agent)	No
	Syslog	No	No	Yes (Client)	Yes (Client)	No	No
	Modbus Plus server	No	No	No	No	Yes (scanned by the PLC)	No
	Read/Write variables	No	No	No	No	No	Yes
	Global Data	No	No	No	No	No	Yes
	Peer Cop service	No	No	No	No	No	Yes
Compatibility with processor		Modicon M340, Modicon M580		Modicon M580 only		Modicon M340, Modicon M580	
References		BMXEIA0100	BMXNOM0200	BMECXM0100	PMEPXM0100	TCSEGDB23F24FA	
Page		8/5	8/7	8/9	8/11	8/13	



Presentation

The **BMXEIA0100** server module for AS-Interface cabling system provides the AS-Interface system server function for the Modicon automation platform.

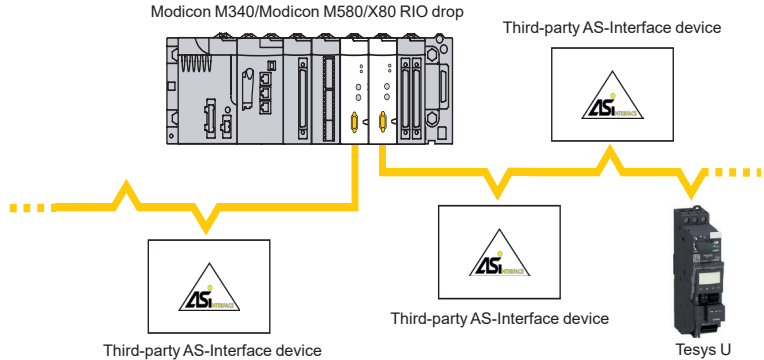

The AS-Interface cabling system consists of a server station and client stations. The server supporting the AS-Interface profile interrogates the devices connected on the AS-Interface line one-by-one and stores the information (actuator/sensor status, device operating status) in the PLC memory. Communication on the AS-Interface line is managed totally transparently in relation to the application PLC program.

The **BMXEIA0100** module supports the latest management profile for AS-Interface devices (*AS-Interface V3*), which is able to manage level V1, V2, and V3 AS-Interface clients:

- Discrete client devices (up to 62 devices of 4 inputs/4 outputs organized in two banks (A/B) of 31 addresses each)
- Analog devices (up to 31 devices (4 channels) in bank A)
- Safety interfaces (up to 31 devices in bank A)

An AS-Interface power supply is essential for powering the various devices on the line. Ideally it should be placed near stations that consume a great deal of energy. Please refer to the "Phaseo AS-i ABL Single phase power supplies 2.4 and 4.8 A for AS-Interface wiring system" catalog.

A Modicon M340 Performance configuration with a **BMXP3420●0/20●02** processor or a Modicon M580 configuration with a **BMEP58●●●●** processor can take four **BMXEIA0100** modules. A Standard configuration with **BMXP341000** processor can take two **BMXEIA0100** modules.

Description

The **BMXEIA0100** AS-Interface module is standard format (1 slot). Its housing provides IP20 protection of the electronics and it is locked into each rack slot (0111) by a captive screw.

The front panel of the **BMXEIA0100** AS-Interface module features:

- 1 A rigid body providing support and protection for the electronic card
- 2 A module reference marking
- 3 A display block with five LEDs indicating the module operating modes:
 - RUN (green): Module running
 - ERR (red): Detected module fault
 - A/B (green): Displays the group of 31 clients
 - I/O (red): Detected I/O fault on AS-Interface line
 - 32 LEDs for diagnostics of the AS-Interface line and each client connected on the line depending on the A/B pushbutton selection (1)
- 4 Two LEDs marked ASI POWER and FAULT: AS-Interface external power supply present and detected AS-Interface line fault (see diagnostics on [page 8/5](#))
- 5 Two pushbuttons marked A/B and MODE (see diagnostics on [page 8/5](#))
- 6 A 3-way male SUB-D connector for the AS-Interface cable (female screw clamp connector supplied)

(1) Depending on whether A or B is selected, this displays either the first 31 clients (standard addressing) or the last 31 clients (extended addressing).

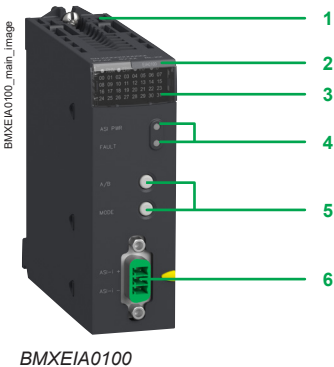

BMXEIA0100

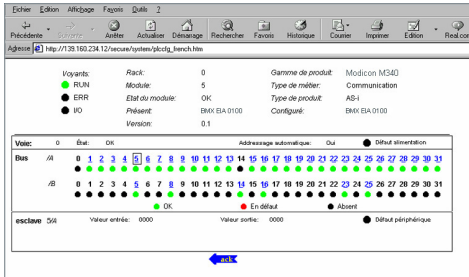

Rack function display in Web browser

Diagnostics

The two LEDs **4** on the module front panel are used in conjunction with the two pushbuttons **5** for module diagnostics:

LEDs		Pushbuttons	
4 ASI PWR: AS-Interface power supply present	4 FAULT: Detected AS-Interface line fault	5 A/B: Selects the group of clients on the display block 3	5 MODE: Module Offline/Online

The display block on the front panel of the **BMXEIA0100** server module can be used to perform simplified local diagnostics by displaying the client devices present on the AS-Interface line.

Detailed diagnostics of each client device is also possible using:

- An adjustment terminal (1)
- A Web browser using the Rack Viewer function in the standard Web server on the Modicon X80 modules. For further information, please consult [our website](#).

References

Modicon X80 AS-Interface module

Description	Usage	Reference	Weight kg/lb
AS-Interface module supplied with 3-way male SUB-D connector	M4 AS-Interface profile for level V1, V2, and V3 clients	BMXEIA0100	0.340/ 0.750

(1) For example, see our Bihl+Wiedemann partner offer.



Presentation

The Modbus serial link is used for client/server architectures (it is necessary, however, to check that the Modbus services used by the application have been implemented on all relevant devices).

Harmony

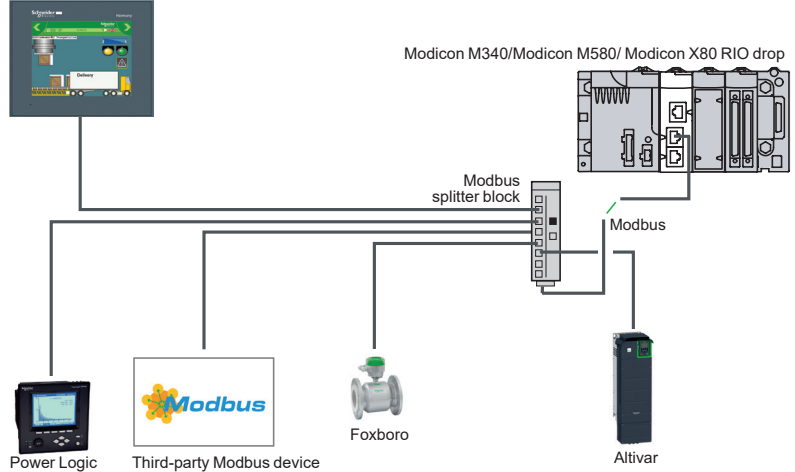

The bus consists of a client station and server stations. Only the client station can initiate the exchange (direct communication between server stations is not possible). Two exchange mechanisms are available:

- Question/response, where requests from the client are addressed to a given server. The client then waits for the response from the server that has been interrogated.
- Broadcasting, where the client broadcasts a message to all server stations on the bus. The latter execute the order without transmitting a reply.
- It is necessary to use **BM●CRA31●10** modules as drop adapters. A maximum of two **BMXNOM0200** modules can be plugged onto one drop.

The following services are not available in the server stations:

- Modbus server
- Modem services

Although most processors have a serial link that can support modems, the **BMXNOM0200** 2-channel serial link module is particularly recommended for this type of use.

Its performance and numerous parameter-setting options make it ideal for any type of configuration, especially when using radio modems.

Description

Modicon X80 serial link module

The front panel of the **BMXNOM0200** serial link module features :

- 1 A screw for locking the module in a slot in the rack.
- 2 A display block with four LEDs:
 - RUN (green) and ERR (red): Module status
 - For each of the two channels: SER COM (green): Activity on the serial link (lit)/detected fault on a device present on the serial link (flashing)
- 3 Two RJ45 connectors (exclusive use) for connection of channel 0 (with black indicator):
 - 3a A connector for RS-232-C connection, marked "COM Port 0 RS232"
 - 3b A connector for RS-485 connection, marked "COM Port 0 RS485"
- 4 An RJ45 connector for RS-485 connection of channel 1, marked "COM Port 1 RS-485", with black indicator

To be ordered separately:

RS-485 cordsets (refer to the "Modicon M580 automation platform" catalog available on [our website](#)) or RS-232 cordsets for DCE terminal (see [page 8/7](#)).

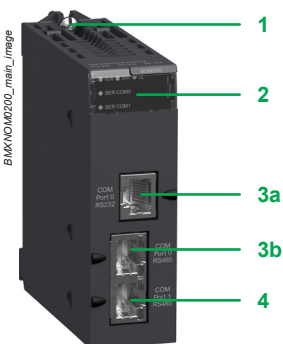

BMXNOM0200



EcoStruxure Control Expert
Monitor



BMXNOM0200



DIA6ED2151012EN

Complementary characteristics

The following characteristics complement those indicated in the selection guide on [page 8/2](#).

BMXNOM0200 module serial links

- Physical interface:
 - Port 0 RS-232: RS-232 8-wire, non-isolated
 - Port 0 and port 1 RS-485: RS-485 2-wire, isolated
- Frame:
 - Modbus: RTU/ASCII, full duplex in RS-232, half duplex in RS-485
 - Character mode: full duplex in RS-232, half duplex in RS-485
- Data rate:
 - Port 0 RS-232: 0.3...115 Kbps (Modbus/Character mode)
 - Port 0 and port 1 RS-485: 0.3...57.6 kbps (Modbus/Character mode)
- Line polarization:
 - Modbus RS-485: automatic
 - RS-485 Character mode: configurable with EcoStruxure Control Expert (1) software
- Maximum length of a tap link in RS-485 2-wire:
 - 15 m/49 ft in a non-isolated link
 - 40 m/131 ft in an isolated link
- Expert mode (from version V1.2 of the module and version V5 of Unity Pro (1)): used to configure the time out links individually from the application and thus adapt to the specific characteristics of certain modems.

References (2)

Modicon X80 serial link module

Description	Protocol	Physical layer	Reference	Weight kg/lb
2-channel serial link module (3)	Modbus client/server RTU/ASCII, Character mode GSM/GPRS modem	1 non-isolated RS-232 channel (Port 0)	BMXNOM0200	0.230/
		2 isolated RS 485 channels (Port 0 and Port 1)		0.507

Cordsets for RS-232 serial link (4)

Description	Connection	Number of wires	Length m/ft	Reference	Weight kg/lb
Cordset for Data Terminal Equipment (DTE) (printer)	RJ45 connector and 9-way female SUB-D connector		3/9.84	TCSMCN3M4F3C2	0.150/0.331
Cordset for Data Communication Equipment (DCE) (modem, etc.)	RJ45 connector and 9-way female SUB-D connector	4-wire (RX, TX, RTS, CTS)	3/9.84	TCSMCN3M4M3S2	0.150/0.331
		8-wire (excluding RI signal)	3/9.84	TCSXCN3M4F3S4	0.165/0.364

(1) EcoStruxure Control Expert software continues the Unity Pro range of software and corresponds to versions ≥ 14 of Unity Pro.

(2) Requires Unity Pro software $\geq V4.1$ or EcoStruxure Control Expert.

(3) For the ruggedized version, BMXNOM0200H, see characteristics on [page 9/9](#).

(4) RS-485 serial link connection (refer to the "Modicon M580 automation platform" catalog available on [our website](#)).

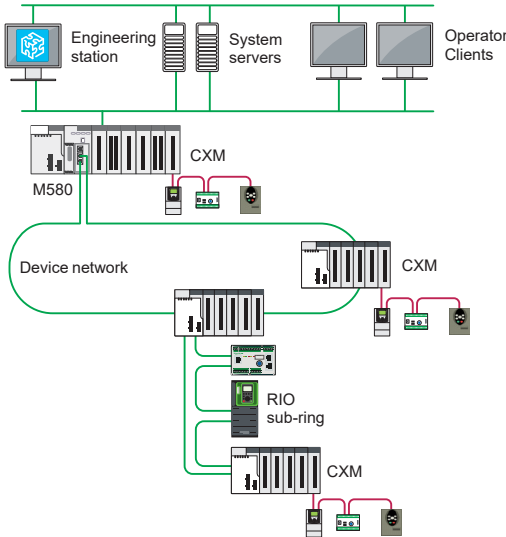

Typical topology to connect CANopen devices to Modicon M580 platforms or Modicon X80 drops with BMECXM0100

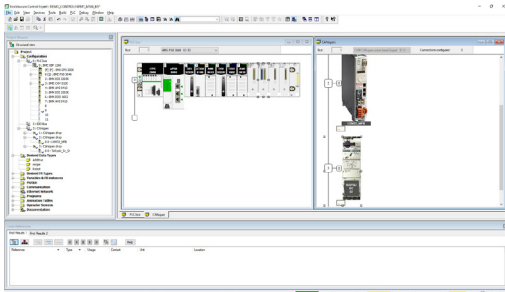

Configuring CANopen with EcoStruxure Control Expert

Presentation

CANopen is an open network supported by more than 600 companies worldwide, and promoted by CAN in Automation (CiA). With the general acceptance of CANopen, Schneider Electric has the accumulated and proven experience of applying CANopen in machine solution platforms.

CANopen helps to ensure reliable and deterministic access to real-time data in field devices. As a consequence, products using CANopen are increasingly used in control system architectures. The **BMECXM0100** CANopen module provides powerful access to the CANopen clients from the Modicon M580 local rack or a remote Modicon X80 drop.

Advantages

The **BMECXM0100** module is designed to fulfill customer needs by offering the following advantages:

- Operational intelligence:
 - Complete software integration into EcoStruxure Control Expert or Unity Pro with a predefined catalog of preferred devices and numerous automated operations such as device variable creation, IP/DHCP settings, and IO scanner configuration
 - Simple integration of third-party devices
- Maintenance excellence:
 - Robust and well-designed with a long life cycle following Modicon X80 standards
 - Built to withstand extreme temperatures (-25 °C to +70 °C/-13 °F to +158 °F), ATEX certified
 - Easy diagnostics by maintenance engineers via a simple Web browser (no need for Unity) and the FDR (Fast Device Replacement) service
- Investment protection: Totally flexible topologies with the possibility of using several **BMECXM0100** modules in a single Modicon M580, or in a remote I/O drop closest to the process
- Time-to-market: Simple, compact size, all in one, which reduces installation time
- Enhanced protection and security: Integrated cybersecurity design helps to protect plant operations

Description

The **BMECXM0100** CANopen module is standard format (1 slot) and supports one CANopen port (SUB-D9 male connector).

The **BMECXM0100** module supports up to 63 clients with a maximum process image size of 4 Kbytes IN/4 Kbytes OUT.

Standardized baudrates between 20 Kbd and 1 Mbd (20 kbd, 50 kbd, 125 kbd, 250 kbd, 500 kbd, 1 MBd) are supported.

Depending on the performance level required by the process, the **BMECXM0100** module can be scanned by the RIO or the DIO scanner of the Modicon M580 CPU. RIO scanning helps to ensure optimum performance, in sync with the PLC task (MAST, FAST, or AUX).

Several **BMECXM0100** modules can be connected to the same or different I/O scanners in the same Modicon M580 PAC.

BMECXM0100 modules are not compatible with redundant Modicon M580 architectures and cannot be scanned by an Ethernet module, including **BMENOC0301** and **BMXNOC0402**.

Third-party CANopen clients can only be configured in **BMECXM0100** modules from their EDS description files and via the hardware catalog manager. They cannot be configured from their DTM. Communication between the device and its DTM over Ethernet IO is also not supported.

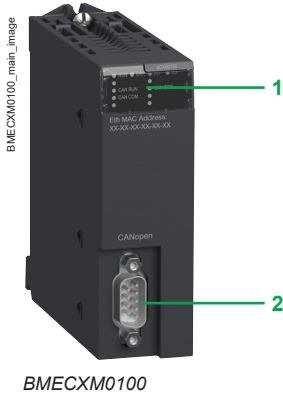

Diagnostics

The five LEDs **1** on the module front panel are used for quick CANopen communication diagnostics:

LED	Color	Description
I/O	Red	Indicates the exchange status with CANopen devices
BS (Bus Status)	Red/Green	Indicates the EtherNet/IP connection status
	Yellow	Firmware upgrade in progress
CAN RUN	Green	Indicates the status of the CANopen fieldbus
CAN ERR	Red	Indicates the status of the CANopen physical layer and indicates detected errors due to missing CAN messages (SYNC, node-guarding, or heartbeat)
CAN COM	Yellow	Dedicated to SDO transmission

References

Modicon X80 CANopen module

Description	Reference	Weight kg/lb
Communication module used in Modicon M580 platform; supplied with male 9-way SUB-D connector 2	BMECXM0100 (1)	–

(1) For the ruggedized version BMECXM0100H, see [page 9/9](#).



PMEPXM0100 PROSOFT partner PROFIBUS module

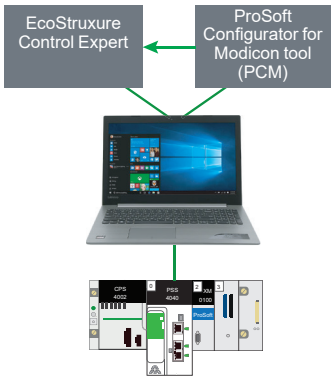

Interaction between EcoStruxure Control Expert, Prosoft Configurator for Modicon (PCM tool), and Modicon X80 PROFIBUS DP module

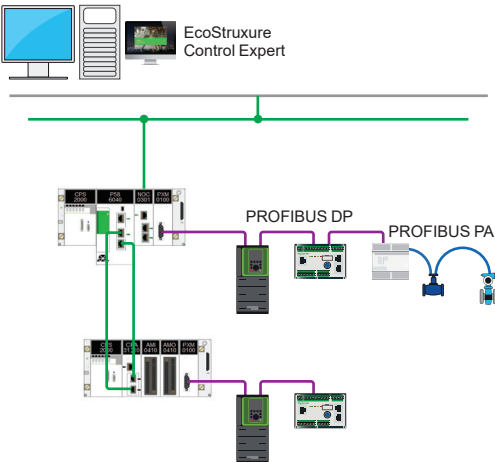

Standalone topology to connect Modicon X80 PROFIBUS DP module to Modicon M580 or Modicon X80 drop with PMEPM0100

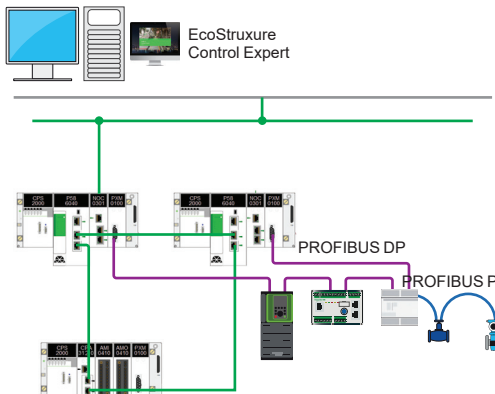

Redundant (HSBY) topology to connect the Modicon X80 PROFIBUS DP module to Modicon M580 platform or Modicon X80 drop with PMEPM0100

Presentation

Overview

The Modicon X80 PROFIBUS DP module allows the user to integrate PROFIBUS DP client devices into Schneider Electric Modicon M580 control system to exchange process, alarm, and diagnostic data with PROFIBUS DP devices as well as to provide configuration and asset management of client devices using Device Type Managers (DTMs).

This is an advanced in-rack solution for your PROFIBUS system compliant with high-availability (HSBY system) and standalone common Safety architectures.

The latest versions of Modicon M580 CPU and **BMECRA31210** Modicon X80 remote I/O drop adapter firmware and software are necessary to operate the module:

- CPU version ≥ V2.80
- **BMECRA31210** version ≥ V2.40 if the module is used in a remote drop
- EcoStruxure Control Expert ≥ V14
- ProSoft Configurator for Modicon tool (PCM)

Advantages

The Modicon X80 PROFIBUS DP module is designed to meet customer needs by offering the following advantages:

- High performance, with up to 125 client devices behind one module (2 kB IN/2 kB OUT), and up to 10 PROFIBUS servers in one Modicon M580 configuration
- Real-time PROFIBUS network analyzer with packet capture tool: accelerates the troubleshooting phase, fine tunes network options, and anticipates any maintenance needs
- Simple and ergonomic ProSoft Configurator for Modicon (PCM) with easy import into EcoStruxure Control Expert to efficiently build the PROFIBUS architecture
- Easy modernization from Quantum PTQ, user-friendly interface
- Achilles Level 2, HTTP, SNMP, Access control, and Sys Log

Description

The Modicon X80 PROFIBUS DP module is a PROFIBUS DP V1 server class 2 module that can be plugged in the Modicon M580 local rack or in any remote drop supporting the Modicon M580 Ethernet backplane depending on the architecture. It has an Autoscan feature to automatically poll and configure all the active clients connected to the bus.

The PROFIBUS Communication DTM library is provided to enable the module interface by PROFIBUS Asset Management Tools.

“On the fly” operations, such as changing parameters or adding a new device online, are allowed.

The module is refreshed based on the RPI values, asynchronous to the periodic tasks. This refreshment is achieved via the Mast task with limited impact on the task duration, which is proportional to the device number.

The Modicon X80 PROFIBUS DP module can be scanned by the Modicon M580 CPU as well as by any Ethernet module (**BMENOC●●●●**). Nevertheless, the CPU capacity (mainly memory) is designed to be capable of managing all Modicon X80 PROFIBUS DP modules installed in the configuration. This simplifies the architecture and the process of modifying client parameters via the “on the fly” feature, as well as that of adding new devices.

An advanced operating mode provides the option to stop the module while the PLC is in RUN in order to manage any modification without stopping the process.

Architecture

The Modicon X80 PROFIBUS DP module can be integrated into two types of architecture:

- Standalone:
 - Local racks and remote racks
 - Up to six modules in one configuration for high-end Modicon M580 CPU
 - Common Safety
- High availability (HSBY system):
 - Local rack only
 - Up to six modules in each rack for high-end Modicon M580 CPU



ProSoft Configurator for Modicon tool (PCM)

ProSoft Configurator for Modicon tool (PCM)

The following are required to configure the **PMEPXM0100** Modicon X80 PROFIBUS DP module:

- EcoStruxure Control Expert V14 and higher
- ControlExpert_V140_HF_PMEPXM0100
- ProSoft Configurator for Modicon tool (PCM)

There is a strong interaction between EcoStruxure Control Expert and the Prosoft Configurator for Modicon (PCM). The ProSoft Configurator for Modicon tool (PCM) also provides the finest level of information and diagnostics on the module, on the bus, and on all the clients. This tool is available at no additional cost on the Schneider Electric website in the product page section.

The PROFIBUS DP module is integrated from EcoStruxure Control Expert with high-level services:

- It is included natively in the EcoStruxure Control Expert (1) hardware catalog
- Exhaustive Device DDT for advanced control and diagnostics

Index	Time	Dir	Status	Src	Dest	Function	Details	Src SAP	Dest SAP	PDU	Data
0	0.327093	Rx	Ok	8	1	Response	Data	-	-	00:00:00:00	68:07:07:68:01:0...
1	0.331732	Tx	Ok	1	2	Request	SRD - Priority	-	-	02:03	68:05:05:68:02:0...
2	0.336113	Rx	Ok	2	1	Response	Data	-	-	03:00:00:00:03	68:05:05:68:02:0...
3	0.332757	Tx	Ok	1	1	Token	-	-	-	-	0C:01:01
4	0.336453	Tx	Ok	1	1	Token	-	-	-	-	0C:01:01
5	0.336044	Tx	Ok	1	1	Token	-	-	-	-	0C:01:01
6	0.427684	Tx	Ok	1	1	Token	-	-	-	-	0C:01:01
7	0.419322	Tx	Ok	1	8	Request	SRD - Priority	-	-	00	68:04:04:68:08:0...
8	0.423243	Rx	Ok	8	1	Response	Data	-	-	00:00:00:00	68:07:07:68:01:0...
9	0.427481	Tx	Ok	1	2	Request	SRD - Priority	-	-	02:03	68:05:05:68:02:0...
10	0.423363	Rx	Ok	2	1	Response	Data	-	-	03:00:00:00:03	68:05:05:68:02:0...
11	0.426925	Tx	Ok	1	6	Request	Request FDL Stat.	-	-	-	30:06:01:49:50:96
12	0.519374	Tx	Ok	1	1	Token	-	-	-	-	0C:01:01
13	0.513013	Tx	Ok	1	8	Request	SRD - Priority	-	-	00	68:04:04:68:08:0...
14	0.514553	Rx	Ok	8	1	Response	Data	-	-	00:00:00:00	68:07:07:68:01:0...
15	0.516231	Tx	Ok	1	2	Request	SRD - Priority	-	-	02:03	68:05:05:68:02:0...
16	0.626513	Rx	Ok	2	1	Response	Data	-	-	03:00:02:02:03	68:05:05:68:02:0...
17	0.612258	Tx	Ok	1	1	Token	-	-	-	-	0C:01:01
18	0.627623	Tx	Ok	1	1	Token	-	-	-	-	0C:01:01
19	0.623544	Tx	Ok	1	1	Token	-	-	-	-	0C:01:01
20	0.641164	Tx	Ok	1	1	Token	-	-	-	-	0C:01:01
21	0.658823	Tx	Ok	1	8	Request	SRD - Priority	-	-	00	68:04:04:68:08:0...
22	0.650343	Rx	Ok	8	1	Response	Data	-	-	00:00:00:00	68:07:07:68:01:0...
23	0.644880	Tx	Ok	1	2	Request	SRD - Priority	-	-	02:03	68:05:05:68:02:0...
24	0.731363	Rx	Ok	2	1	Response	Data	-	-	03:00:02:02:03	68:05:05:68:02:0...

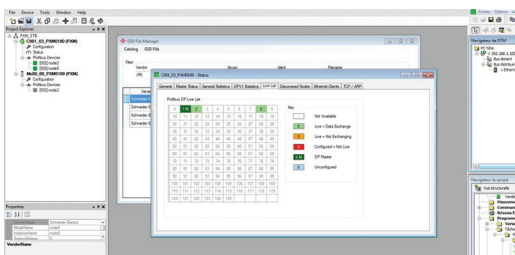

PMEPXM0100 status monitoring - Live List

Diagnostics and monitoring

The seven LEDs on the module front panel are used for quick PROFIBUS DP fieldbus communication diagnostics.

The Modicon X80 PROFIBUS DP module provides a range of statistics that can assist with module operation, maintenance, and fault detection. The statistics can be accessed by the Prosoft Configurator for Modicon or via the Web server embedded in the module.



PMEPXM0100

References

Modicon X80 PROFIBUS DP module

Description	Reference	Weight kg/lb
Used for Modicon M580 platform fieldbus communication	PMEPXM0100	0.270/ 0.595



(1) EcoStruxure Control Expert software continues the Unity Pro range of software and corresponds to versions ≥ 14 of Unity Pro.

Modicon X80 modules

Modicon X80 communication modules

Modbus Plus Proxy

Presentation

The **TCSEGDB23F24FA** Modbus Plus Proxy module is a network gateway that allows Modicon M340 and Modicon M580 PLCs to communicate with existing Modbus Plus devices.

It is not necessary to modify the applications for these devices to communicate with the Modicon M340 and Modicon M580 PLCs, since the module automatically addresses the platforms and the various communication functions between the Modicon M340/Modicon M580 and other PLC platforms (especially 984LL).

The Modbus Plus Proxy offers Modbus Plus PLC users the chance to integrate Modicon M340 and Modicon M580 PLCs easily into their Modbus Plus network and thus to access advanced communications via Ethernet, or to migrate gradually from other PLC models to Modicon M340/Modicon M580 and EcoStruxure Control Expert (1).

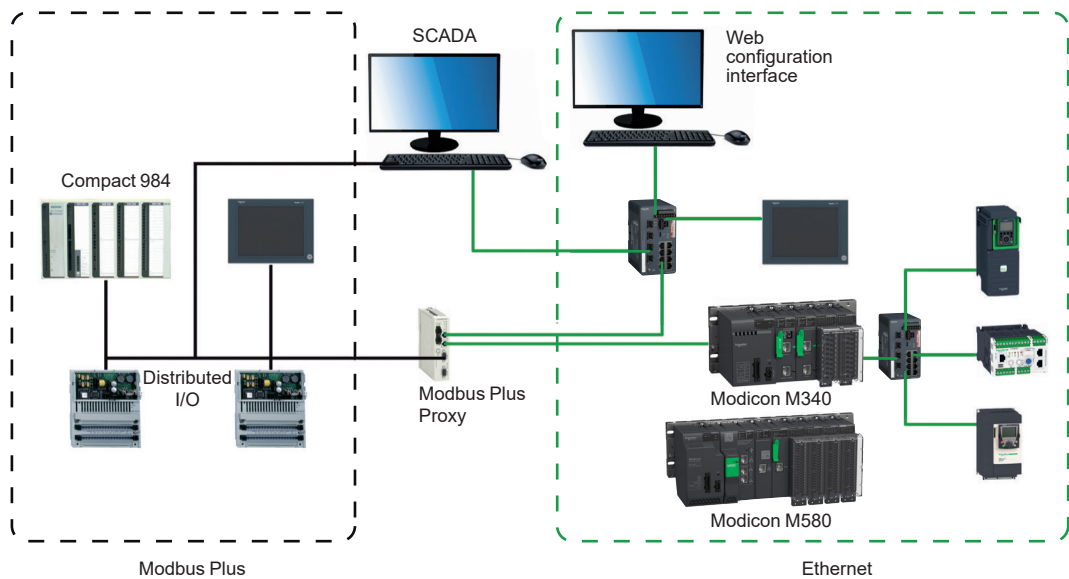

Key benefits

Reduced startup time

- Online configuration of the proxy via a simple Web browser
- Web page setup similar to the screens of the Modbus Plus Peer Cop utility, accessible under Concept/EcoStruxure Control Expert (1) for the Global Data transaction
- Simpler data exchange with Global Data transactions performed on all network nodes
- Point-to-point communication without programming with Peer Cop

Increased network reliability and maintainability

- Standard diagnostics provide data on all network nodes for easy troubleshooting
- Dual Modbus Plus ports provide Modbus Plus network redundancy

Reduced total cost of ownership

- Helps protect your investment in Modbus Plus while migrating to Ethernet
- Dual Ethernet ports allow connection of both the Modicon M340 or Modicon M580 PLC and the configuration PC to the proxy, without any additional switches

(1) Unity Pro software in earlier versions

Modicon X80 modules

Modicon X80 communication modules Modbus Plus Proxy

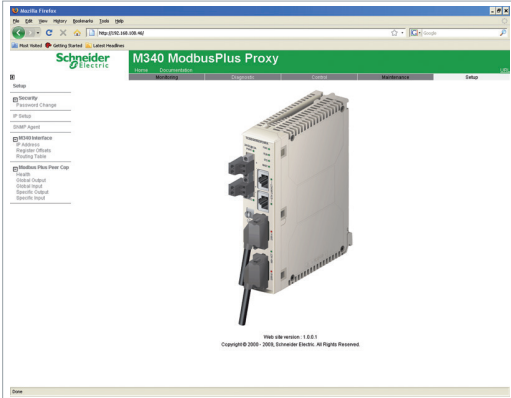

TCSEGDB23F24FA

Embedded Web server

Web server functions

The Modbus Plus Proxy includes an embedded Web server that can be used to perform diagnostics and configure the module connection. Data is presented in the form of standard web pages in HTML format. To access a web page, you need Internet Explorer (version 6.0 or later) and Java (version 1.5 or later).

Embedded Web server functions

- 1 - Setup: The Setup pages allow you to define the parameters for several different module services, including security, IP, SNMP, Global Data, Peer Cop, and Ethernet ports.
- 2 - Diagnostics: These network diagnostic pages contain Ethernet, TCP, and SNMP statistics, as well as a log of the diagnostics performed.

Complementary characteristics

The following characteristics complement those introduced in the communication selection guide on [page 8/2](#)

- External power supply voltage: 19.2...31.2 V ~
- Consumption: 300 mA max.
- Dissipated power: 6.2 W

References

System and network requirements

- EcoStruxure Control Expert or Unity Pro XL programming software (version 3.x or later) (1)
- Internet Explorer (version 6.0 or later)
- Java (version 1.5 or later)
- Microsoft Windows XP or Vista

Modicon M340 processors:

- BMXP342020 (Modbus and Ethernet version)
- BMXP3420302 (CANopen and Ethernet version)

Modicon M580 processors:

- BMEP581020
- BMEP582020/BMEP582040(S)
- BMEP583020/BMEP583040
- BMEP584020/BMEP584040(S)
- BMEP585040
- BMEP586040(S)

Modicon M340 Ethernet modules:

- BMXNOE0100
- BMXNOE0110
- BMXNOC0401

Modicon M580 Ethernet modules:

- BMENOC0301
- BMENOC0311
- BMENOC0321

Modicon Modbus Plus Proxy (2)

Description	Supplied with	Reference	Weight kg/lb
Modbus Plus Proxy module for Modicon M340 and Modicon M580 PLCs	2 front-mounted power supply connectors (2 positions)	TCSEGDB23F24FA	-

(1) Unity Pro V8.0 or later with Modicon M580

(2) For Modicon Modbus Plus Proxy with conformal coating, see [page 9/9](#).

Modicon X80 modules

Modicon X80 communication modules
Fiber converter modules

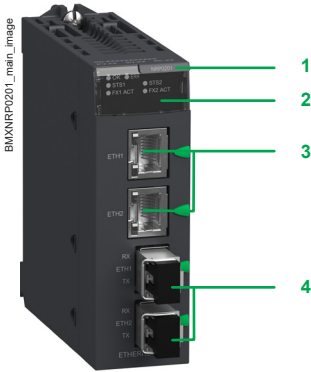

BMXNRP0200

Modicon X80 fiber converter module (1) (2)

Presentation

BMXNRP0200/0201 module offers an alternative to the use of Modicon managed dual ring switches (DRS), for fiber communications over long distances in Ethernet I/O systems (RIO or DIO).
When inserted in Modicon X80 EIO drops, **BMXNRP0200/0201** modules make it possible to:

- Extend the total distance of the EIO network when EIO drops are located in areas of the factory above 100 m/328 ft
- Enhance immunity to noise
- Resolve grounding incompatibilities between sites with different grounding methods

BMXNRP0200/0201 modules can be installed on the primary or secondary rings. These modules cannot, however, be used to connect secondary rings to the primary ring.

Following the distance of the remote location, you may select:

- The **BMXNRP0200** module for multimode optical fiber which allows remote location up to 2 km/1.25 mi., or
- The **BMXNRP0201** module for single-mode optical fiber which allows remote location up to 16 km/9.94 mi.

Depending on the configuration, the X80 fiber converter module may be linked to the X80 remote I/O drop adapter of the drop where it is installed, via one or two Ethernet Interlink cables.

Description

- 1 Module reference
- 2 Display block indicating the module status
- 3 RJ45 Ethernet ports (two LEDs, LNK and ACT, indicate the status of each port)
- 4 Fiber optic ports with SFP transceiver for LC type connector

Instead of an embedded switch, you may also use our external Modicon switches described in the Modicon Networking catalog. They are all delivered with predefined parameters in order to optimize your architecture performances, including dual ring switch, management of main ring RIO, sub-ring, or loop with DIO.

References (1)

Modicon X80 fiber converter modules (2)

Description	Optical fiber	Reference	Weight kg/lb
Modules for fiber optic communications over long distances	Multimode	BMXNRP0200	—
	Single-mode	BMXNRP0201	—

(1) For additional characteristics, see [our website](#).

(2) Requires Unity Pro Extra Large software ≥ V7.0 or EcoStruxure Control Expert: see [our website](#).



[DIA6ED2140903EN](#)

Modicon X80 modules

Modicon X80 communication modules
Ethernet switch module

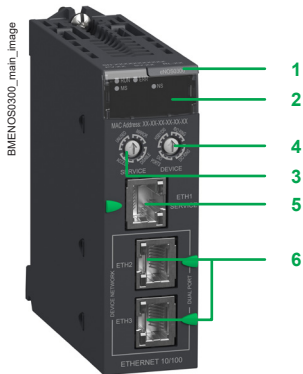

BMENOS0300



DIA6ED2140903EN

Ethernet switch module

Presentation

The **BMENOS0300** Ethernet switch module offers an economic alternative to the use of Modicon managed dual ring switches (DRS) for copper Ethernet communication over short distances in Ethernet I/O systems (RIO or DIO). Based on the rotary switches on the front panel, the application of the two device network ports can be configured intuitively as:

- RIO ring
- DIO ring
- DIO ports

Depending on the architecture, the **BMENOS0300** switch can be used to communicate with the distributed I/O by simply inserting it in the local main rack or remote drops.

Description

- 1 Module reference
- 2 Display block indicating the module status
- 3 Rotary switch for configuring the ETH 1 service port
- 4 Rotary switch for configuring the 2 device network ports (ETH 2 and ETH 3)
- 5 ETH 1: Service port (Ethernet)
- 6 ETH 2/ETH 3: Device network port (Ethernet)

Instead of an embedded switch, you may also use our external Modicon switches described in the Modicon Networking catalog. They are all delivered with predefined parameters in order to optimize your architecture performances, including dual ring switch, management of main ring RIO, sub-ring, or loop with DIO.

References (1)

Modicon X80 Ethernet switch module

Description	Service port	Device network port (Ethernet)	Reference	Weight kg/lb
Switch for copper Ethernet communication over short distances	1	2	BMENOS0300	–

(1) For additional characteristics, see [our website](#).

9 - Dedicated parts for severe environments

Treatment for severe environments

- **Presentation** [page 9/2](#)
- Protective treatment for Modicon X80 modules [page 9/2](#)
- Treatment for severe environments [page 9/2](#)
 - Harsh chemical environments [page 9/2](#)
 - Extreme climate environments [page 9/2](#)
- Specific characteristics for Modicon X80 Safety modules [page 9/3](#)
- Composition of Modicon X80 offer for severe environments [page 9/3](#)

Dedicated parts for severe environments

- **Modicon X80 racks and rack expansion module for severe environments**
- References [page 9/4](#)
- **Modicon X80 power supplies for severe environments**
- References [page 9/5](#)
- **Modicon X80 I/O modules for severe environments**
- Modicon X80 discrete I/O modules [page 9/6](#)
- Modicon X80 analog I/O modules [page 9/7](#)
- **Modicon X80 expert modules for severe environments**
- Modicon X80 counter modules [page 9/8](#)
- Modicon X80 time-stamping module [page 9/8](#)
- Modicon X80 SSI encoder interface module [page 9/8](#)
- Modicon X80 frequency input module [page 9/8](#)
- Removable terminal blocks for severe environments [page 9/8](#)
- **Modicon X80 I/O expansion modules for severe environments**
- Modicon X80 remote I/O drop adapter with conformal coating [page 9/9](#)
- **Modicon X80 communication modules for severe environments**
- Modicon X80 Modbus and Character mode serial link module [page 9/9](#)
- Modicon X80 CANopen master module [page 9/9](#)
- Modicon X80 PROFIBUS DP module [page 9/9](#)
- Modicon X80 PROFIBUS DP network gateway [page 9/9](#)
- Modicon X80 fiber converter modules [page 9/9](#)
- Modicon X80 Ethernet switch module [page 9/9](#)



Presentation

Protective treatment for Modicon X80 modules

The Modicon X80 modules comply with “TC” treatment requirements (treatment for all climates). It is designed as standard to operate in temperatures ranging from 0 to 60 °C/32 to 140 °F.

For installations in industrial environments corresponding to “TH” (treatment for hot and humid environments), devices must be housed in enclosures providing at least IP54 protection as specified by standard IEC/EN 60529, or an equivalent level of protection according to NEMA 250.

The Modicon X80 modules offer **IP20 protection** (1). They can therefore be installed without an enclosure in reserved access areas that do not exceed **pollution level 2** (control room with no conductive dust). **Pollution level 2** does not take account of harsher environments, such as those where the air is polluted with conductive dust, fumes, corrosive or radioactive particles, vapors or salts, molds, insects, etc. All the functional safety hardware in-rack modules colored red (processor, coprocessor, Modicon X80 I/O) are conformal coated for use in severe environments.

Treatment for severe environments

If the Modicon X80 modules have to be used in more severe environments or are required to start and operate in an extended temperature range, from **-25 to +70 °C/-13 to +158 °F** (only H or T version), the “**ruggedized**” offer features an industrially hardened processor and power supply modules, X-bus and Ethernet I/O modules, and backplanes that have a protective coating on their circuit boards.

Note: Capable of starting within an extended temperature range (from -25 to +70 °C/-13 to +158 °F, a single-rack configuration is also able to operate at extremely low temperatures (as low as -40 °C/-40 °F) if placed in an appropriate enclosure. Please contact our Customer Care Center.

The coated/harsh offer provides the Modicon M580 Safety CPU/coprocessor and Modicon X80 Safety I/O modules with “AVR 80” coating on their electronic cards. This treatment increases the isolation capability of the circuit boards and their resistance to:

- Condensation
- Dusty atmospheres (conducting foreign particles)
- Chemical corrosion, in particular during use in sulfurous atmospheres (oil refinery, purification plant, etc.) or atmospheres containing halogens (chlorine, etc.) or chemical vapors

This protection, combined with appropriate installation and maintenance, enables Modicon X80 products to be used in the following environments:

Harsh chemical environments (products with suffix ‘H’ and ‘C’)

The use of contact grease protection on connectors and removable terminal blocks is mandatory to meet these requirements.

The lubricant protection seals electrical contacts from oxygen, moisture, aggressive gasses, and other hostile elements.

- **IEC/EN 60721-3-3 class 3C1, 3C2, 3C3, 3C4:**
 - 7 days; 25 °C/77 °F relative humidity 75%
 - Concentrations (ppb): H₂S: 9,900/SO₂: 4,800/Cl₂: 200
- **ISA S71.04 classes G1, G2, G3, Gx:**
 - 14 days; 25 °C/77 °F relative humidity 75%
 - Concentrations (ppb): H₂S: 60/SO₂: 350/Cl₂: 1,450/NO₂: 12
- **IEC/EN 60068-2-52 salt mist, Kb test severity level 2:**
 - 3 x 24-hour cycles
 - 5% NaCl
 - 40 °C/104 °F relative humidity 93%

Extreme climate environments (products with suffix ‘H’ and ‘T’)

- Temperatures ranging from -25 to +70 °C/-13 to +158 °F
- Relative humidity levels up to 93%
- Altitudes from 0 to 5,000 m/0 to 16,404 ft

Note: Some products with the suffix ‘C’ also operate in an extended temperature range (from -25 to +60 °C/-13 to 140 °F). Please contact our Customer Care Center.

(1) Each slot in a **BM●XBP●●00** backplane is equipped as standard with a protective cover that should only be removed when inserting a module. If any covers are subsequently misplaced, replacements can be ordered under reference **BMXXEM010** (sold in lots of 5).



Protective gel BMXGEL0025

Presentation (continued)

Specific characteristics for Modicon X80 Safety modules

All Modicon X80 Safety modules are coated and only exist with this surface treatment. There is no T, C, or H extension in the product references. Modicon X80 Safety modules are compatible with:

- a temperature range from $-25...+60\text{ }^{\circ}\text{C}$ / $-13...+140\text{ }^{\circ}\text{F}$
- corrosive environments using common H components

A protective gel is needed to cover all electrical connections on Modicon X80 products used in corrosive environments.

This gel comes in a 25 g tube and can be ordered separately under the reference **BMXGEL0025**.

Modicon X80 offer composition for severe environments

To order ruggedized modules and backplanes, see the reference tables from [page 9/4](#) to [page 9/9](#):

- References of available ruggedized products include the suffix "H".
- References of available conformal coated products include the suffix "C".

The majority of operating and electrical characteristics of ruggedized modules are identical to those of their equivalent standard versions. However, some characteristics are subject to either derating or limitation. Please consult [our website](#).

In this chapter, note that only Modicon X80 products are described.

- For Modicon M580 or Modicon M340 products, please refer to the corresponding catalog:



[DIA6ED2151012EN](#)



[DIA6ED2110104EN](#)

- For additional accessories, please refer to:
 - Standard accessories for backplanes, [page 2/5](#) and [page 2/10](#)
 - Standard accessories for power supplies, [page 3/3](#)
 - Standard accessories for I/O modules, [page 4/15](#)
 - Standard accessories for expert modules, [page 4/15](#)

Modicon X80 modules

Dedicated parts for severe environments
Modicon X80 backplanes and rack expansion module for severe environments

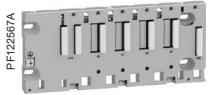

BMXXBP0400H

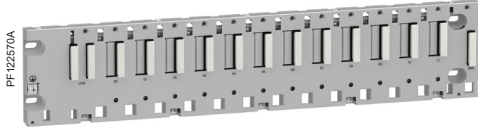

BMXXBP1200H

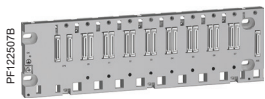

BMEXBP0800H

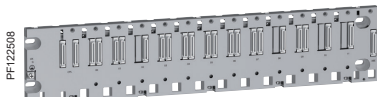

BMEXBP1002H



BMXXBE1000H

Modicon X80 backplanes and rack expansion module for severe environments

Description	Type of module to be inserted	No. of slots (1)	Power consumption (2)	Reference	Weight kg/lb
X-bus backplanes for severe environments	BMXCPS power supply, BMXP34 or BMEP58 processor, BMEH58 processor, I/O modules, and application-specific (counter and communication) modules	4	1.12 W	BMXXBP0400H	0.630/1.389
		6	1.68 W	BMXXBP0600H	0.790/1.742
		8	PV<0.3: 2.21 W PV≥0.3: 0.13 W	BMXXBP0800H	0.950/2.094
		12	0.83 W	BMXXBP1200H	1.270/2.800
Dual X-bus and Ethernet backplanes for severe environments	BMXCPS power supply, BMEP58 processor, BMEH58 processor, I/O modules, and application-specific (counter and communication) modules	4	2.99 W	BMEXBP0400H	0.715/1.576
		8	4.15 W	BMEXBP0800H	1.070/2.359
		12	4.22 W	BMEXBP1200H	1.387/3.058
Dual X-bus and Ethernet backplanes with power redundancy, for severe environments	BMEP58 processor, BMEH58 processor, BMXCPS400 redundant power supply, I/O modules, and application-specific (counter and communication) modules	6	4.15 W	BMEXBP0602H	1.02/2.249
		10	4.22 W	BMEXBP1002H	1.387/3.058

Description	Use	Reference	Weight kg/lb
Rack expansion module (3) for severe environments	Standard module to be installed in each rack (XBE slot) Used to daisy chain 2, 4, or 8 racks depending on the types of Modicon M340 or Modicon M580 processor	BMXXBE1000H	0.178/0.392

(1) Number of slots taking the processor module, I/O modules, and application-specific modules (excluding power supply).

(2) Including power consumption of anti-condensation resistor(s).

(3) Module and cordsets do not operate properly at temperatures lower than -25 °C/-13 °F.

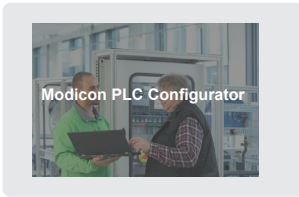

Click on the pictogram to access Modicon PLC Configurator online and calculate the optimal power supply for the power consumption

Modicon X80 power supplies for severe environments

Each **BM●XBP●●00H** backplane must be equipped with a power supply. **BMEXBP●●02H** backplanes must be equipped with one or two redundant power supplies. These modules are inserted in the leftmost power supply slots of each backplane (marked CPS).

The available power values given below in **bold italic** correspond to operation at -25 °C/-13 °F and +70 °C/+158 °F (see temperature derating curves on [our website](#)).

The power required to supply each rack depends on the type and number of modules installed in the backplane. It is therefore necessary to draw up a power consumption table for each rack in order to determine which is the most appropriate **BMXCPS●●●●H** power supply for your requirements : calculate the power consumption by using the online [Modicon PLC Configurator](#) tool.

Modicon X80 power supplies for severe environments (1)

Line supply	Available power (2)			Reference	Weight kg/lb	
	3.3 V $\overline{\text{---}}$ (3)	24 V $\overline{\text{---}}$ rack (3)	24 V $\overline{\text{---}}$ sensors (4)			Total
24...48 V $\overline{\text{---}}$ isolated	15 W	32 W	–	32 W	BMXCPS3020H	0.340/ 0.750
	11.3 W	23.4 W		23.4 W		
100...240 V \sim	15 W	31.2 W	21.6 W	36 W	BMXCPS3500H	0.360/ 0.794
	11.3 W	23.4 W	16.2 W	27 W		
24...48 V $\overline{\text{---}}$	18 W	40 W	–	40 W	BMXCPS4002H	0.360/ 0.794
	18 W	40 W		40 W		
24...48 V $\overline{\text{---}}$	18 W	40 W	–	40 W	BMXCPS4022H	0.810/ 1.786
	18 W	40 W		40 W		
125 V $\overline{\text{---}}$	18 W	40 W	–	40 W	BMXCPS3522H	0.610/ 1.345
	18 W	40 W		40 W		

- (1) Includes a set of two removable caged connectors **BMXXTSCPS10**.
- (2) The total power consumed on each voltage (3.3 V $\overline{\text{---}}$ and 24 V $\overline{\text{---}}$) must not exceed the total power of the module.
- (3) 3.3 V $\overline{\text{---}}$ and 24 V $\overline{\text{---}}$ rack voltages for powering Modicon M340 and Modicon M580 PLCs.
- (4) 24 V $\overline{\text{---}}$ sensor voltage for powering the input sensors (voltage available via the 2-way removable connector on the front panel).



BMXCPS3020H



BMXCPS3500H



BMXCPS4002H



BMXCPS4022H



BMXCPS3522H

Modicon X80 modules

Dedicated parts for severe environments
Modicon X80 discrete I/O modules for severe environments



BMXDDI160●H
BMXDAI160●H



BMXDAI161●H
BMXDDO3202H



BMXDDI3202KH (left)
BMXDDI6402KH (right)



BMXDDO16●2H
BMXDAO1605H
BMXDRA●●●●H



BMXDDO6402KC



BMXDDO3202H
BMXDAO1615H
BMXDRC0805H

References						
Modicon X80 discrete input modules for severe environments						
Type of current	Input voltage	Connection via	IEC/EN 61131-2 conformity	No. of channels (common x channels per group)	Reference	Weight kg/lb
⎓	24 V (positive logic)	20-way caged, screw clamp, or spring-type removable terminal block	Type 3	16 inputs (1 x 16)	BMXDDI1602H	0.115/0.254
		One 40-way connector	Type 1	32 inputs (2 x 16)	BMXDDI3202KH	0.110/0.243
		Two 40-way connectors	Non-type	64 inputs (4 x 16)	BMXDDI6402KH	0.145/0.320
	24 V (positive/negative logic)	20-way caged, screw clamp, or spring-type removable terminal block	Non-type	16 inputs (1 x 16)	BMXDAI1602H	0.115/0.254
		40-way caged or spring-type removable terminal block	Type 3	32 inputs (2 x 16)	BMXDDI3232H	0.138/0.30
		20-way caged, screw clamp, or spring-type removable terminal block	Type 1	16 inputs (1 x 16)	BMXDDI1603H	0.115/0.254
~	48 V	40-way caged or spring-type removable terminal block	Type 3	32 inputs (2 x 16)	BMXDDI3203H	0.138/0.304
		20-way caged, screw clamp, or spring-type removable terminal block	Type 1	16 inputs (1 x 16)	BMXDAI1602H	0.115/0.254
		20-way caged, screw clamp, or spring-type removable terminal block	Type 3	16 inputs (1 x 16)	BMXDAI1603H	0.115/0.254
	100...120 V	20-way caged, screw clamp, or spring-type removable terminal block	Type 3	16 inputs (1 x 16)	BMXDAI1604H	0.115/0.254
		40-way caged or spring-type removable terminal block	Type 1	16 isolated inputs	BMXDAI1614H	0.150/0.331
		40-way caged or spring-type removable terminal block	Type 1	16 isolated inputs	BMXDAI1615H	0.156/0.344

Modicon X80 discrete output modules for severe environments						
Type of current	Output voltage	Connection via	IEC/EN 61131-2 conformity	No. of channels (common x channels per group)	Reference	Weight kg/lb
⎓ transistor	24 V (positive logic)	20-way caged, screw clamp, or spring-type removable terminal block	Yes	16 outputs (1 x 16)	BMXDDO1602H	0.120/0.265
		20-way caged, screw clamp, or spring-type removable terminal block	Yes	16 outputs (1 x 16)	BMXDDO1612H	0.120/0.265
	12...24 V (positive logic)	40-way caged or spring-type removable terminal block	Yes	32 outputs (2 x 16)	BMXDDO3202H	0.144/0.317
	24 V (positive logic)	One 40-way connector	Yes	32 outputs (2 x 16)	BMXDDO3202KC	0.110/0.243
Two 40-way connectors		Yes	64 outputs (4 x 16)	BMXDDO6402KC	0.150/0.331	
~ triac	100...240 V	20-way caged, screw clamp, or spring-type removable terminal block	Yes	16 outputs (4 x 4)	BMXDAO1605H	0.140/0.309
	24...240 V	40-way caged or spring-type removable terminal block	Yes	16 isolated outputs	BMXDAO1615H	0.250/0.551
⎓ / ~ relay	24...125 V ⎓ 24...240 V ~	20-way caged, screw clamp, or spring-type removable terminal block	Yes	8 normally open isolated relay outputs	BMXDRA0815H	0.210/0.463
		20-way caged, screw clamp, or spring-type removable terminal block	Yes	16 normally open relay outputs (2 x 8)	BMXDRA1605H	0.150/0.331
	24...125 V ⎓ 24...240 V ~	40-way caged or spring-type removable terminal block	Yes	8 normally open and normally closed isolated relay outputs	BMXDRC0805H	0.189/0.417

Modicon X80 modules

Dedicated parts for severe environments
Modicon X80 analog I/O modules for severe environments



BMXDDM1602H



BMXART0414H (left)
BMXART0814H (right)



BMEAH0812H



BMXAMO0210H



BMEAH00412C

References

Modicon X80 discrete mixed I/O modules for severe environments

Type	Voltage		Connection via	IEC/EN 61131-2 conformity		No. of channels (common x channels per group)		Reference	Weight kg/lb
	Inputs	Outputs		Inputs	Outputs	Inputs	Outputs		
transistor	24 V $\overline{\text{---}}$ (positive logic)	24 V $\overline{\text{---}}$	20-way caged, screw clamp, or spring-type removable terminal block	Type 3	Yes	8 (1 x 8)	8 (1 x 8)	BMXDDM16022H	0.115/ 0.254
relay	24 V $\overline{\text{---}}$ (positive logic)	24...240 V \sim	20-way caged, screw clamp, or spring-type removable terminal block	Type 3	Yes	8 (1 x 8)	8 (1 x 8)	BMXDDM16025H	0.135/ 0.298

Modicon X80 analog input modules for severe environments

Type of inputs	Input signal range	Resolution	Connection	No. of channels	Reference	Weight kg/lb
Isolated high-level inputs	± 10 V, 0...10 V, 0...5 V, 1...5 V, ± 5 V, 0...20 mA, 4...20 mA, ± 20 mA	16 bits	20-way caged, screw clamp, or spring-type removable terminal block	4 inputs	BMXAMI0410H	0.143/ 0.315
			28-way caged, screw clamp, or spring-type removable terminal block	8 inputs	BMXAMI0810H	0.175/ 0.386
Isolated low-level inputs	Temperature probe, thermocouple, ± 40 mV, ± 80 mV, ± 160 mV, ± 320 mV, ± 640 mV, ± 1.28 V	15 bits + sign	40-way connector	4 inputs	BMXART0414H	0.135/ 0.298
				8 inputs	BMXART0814H	0.165/ 0.364

Modicon X80 HART analog input module for severe environments

Type of inputs	Input signal range	Resolution	Connection	No. of channels	Reference	Weight kg/lb
Isolated high-level inputs	4...20 mA	15 bits + sign	20-way caged, screw clamp, or spring-type removable terminal block	8 inputs	BMEAH0812H	0.233/ 0.514

Modicon X80 analog output modules for severe environments

Type of outputs	Output signal range	Resolution	Connection	No. of channels	Reference	Weight kg/lb
Isolated high-level outputs	± 10 V, 0...20 mA, 4...20 mA	16 bits	20-way caged, screw clamp, or spring-type removable terminal block	2 outputs	BMXAMO0210H	0.144/ 0.317
				4 outputs	BMXAMO0410H	0.175/ 0.386
Non-isolated high-level outputs	0...20 mA, 4...20 mA	15 bits + sign	20-way caged, screw clamp, or spring-type removable terminal block	8 outputs	BMXAMO0802H	0.150/ 0.331

Modicon X80 HART analog output module for severe environments

Type of outputs	Output signal range	Resolution	Connection	No. of channels	Reference	Weight kg/lb
Isolated high-level outputs	4...20 mA	15 bits + sign	20-way caged, screw clamp, or spring-type removable terminal block	4 outputs	BMEAH00412C	0.223/ 0.492

Modicon X80 analog mixed I/O module for severe environments

Type of outputs	Signal range		Resolution	Connection	No. of channels		Reference	Weight kg/lb
	Inputs	Outputs			Inputs	Outputs		
Mixed I/O, non-isolated	± 10 V, 0...10 V, 0...5 V, 1...5 V, 0...20 mA, 4...20 mA	± 10 V, 0...20 mA, 4...20 mA	12 or 14 bits depending on the range	20-way caged, screw clamp, or spring-type removable terminal block	4 inputs	2 outputs	BMXAMM0600H	0.155/ 0.342



Modicon X80 modules

Dedicated parts for severe environments
Modicon X80 expert modules for severe environments



BMXEHC0200H



BMXEHC0800H



BMXERT1604H



BMXEAE0300H



BMXETM0200H



BMXFTB4000H



BMXFTB4020H

References

Modicon X80 counter modules for severe environments

Description	Characteristics	Connection via	No. of channels	Reference	Weight kg/lb
Counter modules for 24 V \pm 2- and 3-wire sensors and 10/30 V \pm incremental encoders with push-pull outputs	60 kHz counting	2 x 16-way connector and 1 10-way connector	2	BMXEHC0200H	0.112/0.247
	10 kHz counting	20-way caged, screw clamp, or spring-type removable terminal block	8	BMXEHC0800H	0.113/0.249

Modicon X80 time-stamping module for severe environments

Description	Characteristics	Connection via	No. of channels	Reference	Weight kg/lb
Multifunction time-stamping input module	Time- and date-stamping at 1 ms 1.6 < resolution < 3.3 ms store up to local 4,000 events (255 groups, each group 16 channel) (1) 16 discrete inputs on module	28-way caged or spring-type removable terminal block	16	BMXERT1604H	0.119/0.262

Modicon X80 SSI encoder interface module for severe environments

Description	Characteristics	Connection via	No. of channels	Reference	Weight kg/lb
SSI encoder interface module	8- to 31-bit data width 4 baud rates: 100 kHz, 200 kHz, 500 kHz, 1 MHz	28-way caged or spring-type removable terminal block	3	BMXEAE0300H	0.138/0.304

Modicon X80 frequency input module for severe environments

Description	Characteristics	Connection via	No. of channels	Reference	Weight kg/lb
Speed and frequency control module for turbomachinery application	Input frequency: 0...500 Hz, reflex digital output	28-way caged or spring-type removable terminal block	2	BMXETM0200H	0.124/0.273

Removable terminal blocks for severe environments (3)

Description	Type	Reference	Weight kg/lb
40-way removable terminal block	Caged	BMXFTB4000H	0.166/0.366
	Spring	BMXFTB4020H	0.098/0.216

- (1) This maximum value is not an absolute value. It depends on the overall system dynamics (total number of scanned items and number of events generated by the system).
- (2) The shielding on the cordsets carrying the counter signals must always be connected to the **BMXXSP●●00** shielding connection kit mounted under the rack holding the **BMXEHC0200H** module (see page 2/6).
- (3) Both standard and hardened terminal blocks are applicable for severe environment. However, hardened terminal blocks can provide a better protection in a severe environment due to their gold plating.

Modicon X80 modules

Dedicated parts for severe environments
Modicon X80 I/O expansion modules, communication modules, and gateway for severe environments



BMECRA31210C



BMXCRA31210C



BMECXM0100H



PMEPXM0100H



TCSEGPA23F14FK



BMXNRP0200C



BMENOS0300C

References

Modicon X80 remote I/O drop adapters for severe environments

Description	Protocol	Service port	Reference	Weight kg/lb
Remote I/O drop adapter	RSTP	1	BMECRA31210C	0.225/ 0.496
Remote I/O drop adapter	RSTP	1	BMXCRA31210C	0.225/ 0.496

Modicon X80 serial link module for severe environments

Description		Physical layer	Reference	Weight kg/lb
Serial link module (2 channels)	Modbus client/server RTU/ASCII, Character mode, GSM/GPRS modem	1 non-isolated RS-232 channel (SL0) 2 isolated RS-485 channels (SL0 and SL1)	BMXNOM0200H	0.230/ 0.507

Modicon X80 CANopen client module for severe environments

Description	Protocols	Physical layer	Reference	Weight kg/lb
CANopen communication module	CiA 301 V4.2 standard (client or server); Ethernet/IP	ISO 11898 (9-way SUB-D connector)	BMECXM0100H	0.200/ 0.441

Modicon X80 PROFIBUS DP module for severe environments

Description	Protocols	Physical layer	Reference	Weight kg/lb
X80 PROFIBUS DP Master module	Implicit exchange of process data	EIA-485 (optical, MBP)	PMEPXM0100H	0.270/ 0.595

Modicon X80 PROFIBUS DP network gateway for severe environments

Description	Protocols	Physical layer	Reference	Weight kg/lb
PROFIBUS Remote Master (PRM) module	Modbus/TCP	1 Ethernet switch, 2 ports 10BASE-T/ 100BASE-TX	TCSEGPA23F14FK	0.62/ 1.36
	PROFIBUS DP V1 and PROFIBUS PA (via gateway)	1 isolated RS-485 PROFIBUS DP port		

Modbus Plus Proxy module for severe environments

Description	Supplied with	Reference	Weight kg/lb
Modbus Plus Proxy module	2 front-mounted power supply connectors (2 positions)	TCSEGDB23F24FK	-

Modicon X80 fiber converter modules for severe environments (1) (2)

Description	Optical fiber	Reference	Weight kg/lb
Modules for fiber optic communications over long distances	Multimode	BMXNRP0200C	0.203/ 0.447
	Single-mode	BMXNRP0201C	0.203/ 0.447

Modicon X80 Ethernet switch module for severe environments

Description	Service port	Device network port (Ethernet)	Reference	Weight kg/lb
Ethernet switch module	1	2	BMENOS0300C	-

Connection accessories

Designation	Description	RS-232 interface	Reference	Weight kg/lb
Cordset for DCE terminal (modem, etc.)	Equipped with 1x RJ45 connector and 1x 9-way male SUB-D connector Length 3 m/9.84 ft	Simplified 4-wire (RX, TX, RTS, and CTS) Full 8-wire (except RI signal)	TCSMCN3M4M3S2 TCSXCN3M4F3S4	0.150/ 0.331 0.165/ 0.364

(1) Requires Unity Pro Extra Large software ≥ V7.0 or EcoStruxure Control Expert; see our website.

(2) Supports operation at -25 to 60°C/-13 to +140°F.

Technical appendices

- Standards, certifications, and environmental conditions [page 10/2](#)
- Per region [page 10/2](#)
- Per application [page 10/2](#)
- Functional safety [page 10/3](#)
- Environmental characteristics [page 10/4](#)
- Protective treatment of Modicon X80 modules [page 10/4](#)
- Installation restrictions and recommendations [page 10/4](#)
- Environment tests [page 10/5](#)
- Certifications and EC regulations for automation products [page 10/10](#)

Dedicated service offers for your installed base

- Maintenance and support services [page 10/12](#)
- Consultancy services [page 10/13](#)
- Modernization solutions [page 10/13](#)
- Customization services [page 10/13](#)

Index

- Product reference index [page 10/14](#)
- mySchneider, your personalized digital experience [page 10/15](#)



Standards and certifications

Per region

The Modicon X80 modules and Modicon X80 Safety modules have been developed to comply with the principal national and international standards concerning electronic equipment for industrial automation systems. Up-to-date information on which certifications have been obtained is available on our website: consult commercial references directly.

- Compliance with European Directives for CE marking:
 - WEEE: 2012/19/EU
 - Low voltage: 2014/35/EU
 - Electromagnetic compatibility: 2014/30/EU
 - Machinery: 2006/42/EC (check EU DoC on [our website](#))
 - ATEX: 2014/34/EU (check EU DoC on [our website](#))
- Requirements specific to programmable controllers (functional characteristics, immunity, resistance, functional safety, etc.):
 - IEC/EN 61131-2
 - IEC/EN/UL/CSA 61010-2-201
- Country-specific passport:
 - RCM
 - EAC
 - UKCA

For other country certifications, please refer to the technical appendix [page 10/10](#).

Modicon X80 modules are considered as open equipment and are designed for use in industrial environments, in pollution degree 2, overvoltage category II (IEC 60664-1), and in low-voltage installations, where the main power branch is protected on both wires by devices such as fuses or circuit breakers limiting the current to 15 A for North America and 16 A for the rest of the world.

Per application

Power generation

- IEC/EN 61000-6-5 for Type 1 and Type 2 interfaces
- IEC/EN 61850-3 for location G

Marine

Marine requirements of the major international organizations are unified in IACS (International Association of Classification Societies) E10 rules: BV, DNV, ABS, LR, RINA (refer to [page 10/11](#)).

Railway

- EN 50155/IEC 60571: Railway applications - Rolling stock - Electronic equipment
- EN 45545-2: Railway applications - Fire protection on railway vehicles - Part 2: requirements for fire behavior of materials and components
- EN 50121-3-2/IEC 62236-3-2: Railway applications - Electromagnetic compatibility - Part 3-2: Rolling stock - Apparatus
- EN 50121-4/IEC 62236-4: Railway applications - Electromagnetic compatibility - Part 4: Emission and immunity of the signalling and telecommunications apparatus
- EN 50121-5/IEC 62236-5: Railway applications - Electromagnetic compatibility - Part 5: Emission and immunity of fixed power supply installations and apparatus
- EN 50124-1/IEC 62947-1: Railway - Insulation coordination - Part 1: Basic requirements - Clearances and creepage distances for all electrical and electronic equipment
- EN 50125-1/IEC 62498-1: Railway - Environmental conditions for equipment - Part 1: Rolling stock and on-board equipment
- EN 50125-3/IEC 62498-3: Railway - Environmental conditions for equipment - Part 3: Equipment for signaling and telecommunications

Hazardous areas

- For USA and Canada: Hazardous location class I, division 2, groups A, B, C, and D
- For European Union: ATEX for atmosphere Zone 2 (gas) and Zone 22 (dust)
- For United Kingdom: UKEX for atmosphere Zone 2 (gas) and Zone 22 (dust)
- For other countries: IECEx for atmosphere Zone 2 (gas) and/or Zone 22 (dust)



Standards and certifications (continued)

Functional safety

All Modicon X80 Safety modules are certified by TÜV Rheinland.

The certificate reviews the following standards:

■ Generic safety

- IEC/EN 61508: Functional safety of electrical/electronic/programmable electronic safety-related systems
 - IEC/EN 61508-1 - Part 1: General requirements
 - IEC/EN 61508-2 - Part 2: Requirements for electrical/electronic/programmable electronic safety-related systems
 - IEC/EN 61508-3 - Part 3: Software requirements

■ Safety for Process

- IEC/EN 61511: Functional safety - Safety instrumented systems for the process industry sector
 - IEC/EN 61511-1 - Part 1: Framework, definitions, system, hardware and software requirements
 - IEC/EN 61511-2 - Part 2: Guidelines for the application of IEC 61511-1
 - IEC/EN 61511-3 - Part 3: Guidance for the determination of the required safety integrity levels

■ Safety for Machine

- IEC/EN 62061: Safety of machinery - Functional safety of safety-related electrical, electronic and programmable electronic control systems
- ISO/EN 13849-1: Safety of machinery - Safety-related parts of control systems - Part 1: General principles for design
- ISO/EN 13849-2: Safety-related parts of control systems - Part 2: Validation

■ Safety for Railway

- EN 50126/IEC 62278: Railway Applications - The Specification and demonstration of reliability, availability, maintainability and safety (RAMS)
- EN 50128/IEC 62279: Railway Applications - Communication, signaling and processing systems. Software for railway control and protection systems
- EN 50129/IEC 62425: Railway applications - Communication, signaling and processing systems - Safety-related electronic systems for signaling

Fire & Gas

- EN 54.2: Fire detection and fire alarms systems - Part 2: Control and indicating equipment
- EN 50156-1: Electrical equipment for furnaces and ancillary equipment - Part 1: Requirements for application design and installation
- EN 50130-4: Immunity requirements components of fire, intruder, holdup, CCTV, access control and social alarms systems
- EN 298: Automatic burner control systems for burners and appliances burning gaseous or liquid fuels
- NFPA 85: Boiler and Combustion Systems Hazards Code
- NFPA 86: Standard for Ovens and Furnaces
- NFPA 72: National Fire Alarm and Signaling Code

Environmental characteristics

Service conditions and recommendations relating to the environment

			Modicon X80 modules	Modicon X80 Safety modules	Modicon X80 modules for severe environments		
Temperature	Operation	°C/°F	0...60/32...140	-25...+60/-13...+140	-25...+70/-13...+158		
	Storage	°C/°F	-40...+85/-40...+185	-40...+85/-40...+185	-40...+85/-40...+185		
Relative humidity (without condensation)	Cyclical humidity (1)	%	+5...+95 up to 55 °C/131 °F	+5...+95 up to 55 °C/131 °F	+5...+95 up to 55 °C/131 °F		
	Continuous humidity	%	+5...+93 up to 55 °C/131 °F	+5...+93 up to 60 °C/140 °F	+5...+93 up to 60 °C/140 °F		
Altitude	Operation	m/ft	0...2,000/0...6,562 (full specification: temperature and isolation) 2,000...5,000/6,562...16,404 (temperature derating: approx. 1 °C/400 m (33.8 °F/1,312 ft), isolation 150 V/1,000 m/3,281 ft) For accurate temperature derating calculation, refer to IEC 61131-2 Ed4.0 Annex A				
			Modicon X80 power supplies				
Supply voltage			BMXCPS2010	BMXCPS3020 BMXCPS3020H	BMXCPS3540T BMXCPS3522 BMXCPS3522S	BMXCPS2000	BMXCPS3500 BMXCPS3500H BMXCPS4002 BMXCPS4002S BMXCPS4002H BMXCPS4022S
	Nominal voltage	V	24 ---	24...48 ---	125 ---	100...240 ~	100...240 ~
	Limit voltages	V	18...31.2 ---	18...62.4 ---	100...150 ---	85...264 ~	85...264 ~
	Nominal frequencies	Hz	—	—	—	50/60	50/60
	Limit frequencies	Hz	—	—	—	47/63	47/63

Protective treatment of Modicon X80 modules

The Modicon X80 modules and Modicon X80 Safety modules meet the requirements of “TC” treatment (treatment for all climates).

For installations in industrial production workshops or environments corresponding to “TH” treatment (treatment for hot and humid environments), Modicon X80 modules must be embedded in enclosures with minimum IP54 protection.

The Modicon X80 modules and Modicon X80 Safety modules offer **protection to IP20 level** and **protection against access to terminals** (enclosed equipment) (2). They can therefore be installed without an enclosure in reserved-access areas that do not exceed **pollution level 2** (control room with no dust-producing machine or activity). Pollution level 2 does not take account of more severe environmental conditions: air pollution by dust, smoke, corrosive or radioactive particles, vapors or salts, molds, insects, etc.

Installation restrictions and recommendations

Please note that in order to fulfill the international certification conditions:

- Devices must be installed, wired, and maintained in accordance with the instructions provided in the manual “Grounding and Electromagnetic Compatibility of PLC Systems”.
- Installation restrictions are provided in the “Modicon M580, M340, X80 Platforms, Standards and Certifications” and “Modicon M580 Safety, Standards and Certifications” manuals.

Download the manuals for further details:

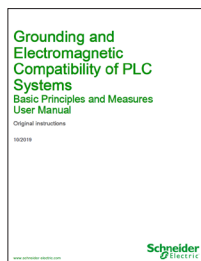

33002439KO1000



EIO0000002726



EIO0000002750

(1) The modules have been tested for a period of 96 hours.

(2) In cases where a slot is not occupied by a module, a BMXXEM010 protective cover must be installed.

(CC): Tests required by European directives (CC) and based on IEC/EN 61131-2 standards.

Environment tests

The table below (pages 10/5 to 10/9) provides test values for Industry; for Power generation, Merchant navy, and Railway application related tests, please refer to “Modicon M580, M340, and X80 platforms, Standards and Certifications - Installation & User guide” (see page 10/4).

Name of test	Standards	Levels
Immunity to LF interference (CE) (1) (2)		
Voltage and frequency variations	IEC/EN 61131-2; IEC/EN 61000-6-2; IEC 61000-4-11	0.85...1.10 Un - 0.94...1.04 Fn; 4 steps t = 30 min
Direct voltage variations	IEC/EN 61131-2; IEC 61000-4-29	0.85...1.2 Un + ripple: 5% peak; 2 steps t = 30 min
Third harmonic	IEC/EN 61131-2	H3 (10% Un), 0°/180°; 2 steps t = 5 min
Voltage interruptions	IEC/EN 61131-2; IEC/EN 61000-6-2; IEC 61000-4-11; IEC 61000-4-29 For functional safety (DS criteria): IEC 61000-6-7; IEC 61326-3-1 IEC/EN 61131-2; IEC/EN 61000-6-2; IEC 61000-4-11	Power supply immunity: ■ 1 ms for --- PS1/10 ms for ~ PS2 (20 ms DS criteria), 85% Un ■ Check operating mode for longer interruptions ■ Up to 5 s, 85% Un For ~ PS2: ■ 20% Un, t0: ½ period ■ 40% Un, cycle 10/12 ■ 70% Un, cycle: 25/30 ■ 0% Un, cycle 250/300
Voltage shut-down and start-up	IEC/EN 61131-2	■ Un...0...Un; t = Un/60 s ■ Umin...0...Umin; t = Umin/5 s ■ Umin...0.9 Udl...Umin; t = Umin/60 s
Magnetic field	IEC/EN 61131-2; IEC 61000-4-8 For functional safety (DS criteria): IEC 61000-6-7; IEC 61326-3-1 IEC 61000-4-10	Power frequency: 50/60 Hz, 100 A/m continuous ...1,000 A/m; t = 3 s; 3 axes Oscillatory: 100 kHz...1 MHz, 100 A/m; t = 9 s; 3 axes
Conducted common mode disturbances range 0 Hz ...150 kHz	IEC 61000-4-16 For functional safety (DS criteria): IEC 61000-6-7; IEC 61326-3-1	For remote systems: ■ 50/60 Hz and ---, 300 V, t = 1 s ■ 50/60 Hz and ---, 30 V, t = 1 min ■ 5 Hz...150 kHz, sweep 3 V...30 V ■ For AC: 10 V ■ For DC: 10 V cont. or 100 V, t = 1 s

Where:

- PS1 applies to PLC supplied by battery, PS2 applies to PLC energized from ~ or --- supplies
- Un: nominal voltage, Fn: nominal frequency, Udl: detection level when powered

(1) Devices must be installed, wired, and maintained in accordance with the instructions provided in the manual “Grounding and Electromagnetic Compatibility of PLC Systems” (see page 10/4).

(2) These tests are performed without an enclosure, with devices fixed on a metal grid and wired as per the recommendations in the manual “Grounding and Electromagnetic Compatibility of PLC systems” (see page 10/4).

(CE): Tests required by European CE directives and based on IEC/EN 61131-2.

Environment tests (continued)		
Name of test	Standards	Levels
Immunity to HF interference (CC) (1) (2)		
Electrostatic discharges	IEC/EN 61131-2; IEC/EN 61000-6-2; IEC 61000-4-2 For functional safety (DS criteria): IEC 61000-6-7; IEC 61326-3-1	6 kV contact; 8 kV air; 6 kV indirect contact
Radiated radio frequency electromagnetic field	IEC/EN 61131-2; IEC/EN 61000-6-2; IEC 61000-4-3 For functional safety (DS criteria): IEC 61000-6-7; IEC 61326-3-1	80 MHz...1 GHz: 10/15 V/m (20 V/m DS criteria); 3 V/m, 1.4 GHz...2 GHz: 3V/m (10 V/m DS criteria) 2 GHz...6 GHz: 3V/m Sinus amplitude modulated 80%, 1 kHz + internal clock frequencies
Electrical fast transient bursts	IEC/EN 61131-2; IEC/EN 61000-6-2; IEC 61000-4-4 For functional safety (DS criteria): IEC 61000-6-7; IEC 61326-3-1	For ~ or --- main supplies: ■ 2 kV in common mode/2 kV in wire mode (4 kV DS criteria with external protection) For ~ or --- auxiliary supplies, ~ unshielded I/O: ■ 2 kV in common mode For analog, --- unshielded I/O, communication and shielded lines: ■ 1 kV in common mode (3 kV DS criteria)
Surge	IEC/EN 61131-2; IEC/EN 61000-6-2; IEC 61000-4-5 For functional safety (DS criteria): IEC 61000-6-7; IEC 61326-3-1	For ~/--- main and auxiliary supplies, ~ unshielded I/O: ■ 2 kV in common mode/1 kV in differential mode (4 kV DS criteria with external protection) For analog, --- unshielded I/O: ■ 1 kV in common mode For communication and shielded lines: ■ 1 kV in common mode (3 kV DS criteria)
Conducted disturbances induced by radiated electromagnetic fields	IEC/EN 61131-2; IEC/EN 61000-6-2; IEC 61000-4-6 For functional safety (DS criteria): IEC 61000-6-7; IEC 61326-3-1	10 V; 0.15 MHz...80 MHz (20 V DS criteria) Sinus amplitude 80%, 1 kHz + spot frequencies
Damped oscillatory wave	IEC/EN 61131-2; IEC 61000-4-18	For ~/--- main supplies and ~ auxiliary supplies, ~ unshielded I/O: ■ 2.5 kV in common mode/1 kV in differential mode For --- auxiliary supplies, analog, --- unshielded I/O: ■ 1 kV in common mode/0.5 kV in differential mode For communication and shielded lines: ■ 0.5 kV in common mode

(1) Devices must be installed, wired, and maintained in accordance with the instructions provided in the manual "Grounding and Electromagnetic Compatibility of PLC Systems" (see page 10/4).

(2) These tests are performed without an enclosure, with devices fixed on a metal grid and wired as per the recommendations in the manual "Grounding and Electromagnetic Compatibility of PLC systems" (see page 10/4).

(CC): Tests required by European CC directives and based on IEC/EN 61131-2.

Environment tests (continued)		
Name of test	Standards	Levels
Electromagnetic emissions (CE) (1)		
Conducted emissions	IEC/EN 61131-2; IEC/EN 61000-6-4; CISPR 11 & 22, Class A, Group 1	150 kHz ... 500 kHz: quasi-peak 79 dB (µV/m); average 66 dB (µV/m) 500 kHz ... 30 MHz: quasi-peak 73 dB (µV/m); average 60 dB (µV/m)
Radiated emissions	IEC/EN 61131-2; IEC/EN 61000-6-4; CISPR 11 & 22, Class A, Group 1	30 MHz ... 230 MHz: quasi-peak 40 dB (µV/m) (at 10 m/33 ft) 230 MHz ... 1 GHz: quasi-peak 47 dB (µV/m) (at 10 m/33 ft) 1 GHz ... 3 GHz: quasi-peak 76 dB (µV/m) (at 3 m/9.84 ft) 3 GHz ... 6 GHz: quasi-peak 80 dB (µV/m) (at 3 m/9.84 ft)
Name of test	Standards	Levels
Immunity to climatic variations (1) (power on)		
Dry heat	IEC 60068-2-2 (Bb & Bd)	60 °C/140 °F, t = 16 hrs [for ruggedized range: 70 °C/158 °F, t = 16 hrs] (2)
Cold	IEC 60068-2-1 (Ab & Ad)	0...-25 °C/32...-13 °F, t = 16 hrs + power on at 0 °C/ 32 °F [for ruggedized range: power on at -25 °C/-13 °F] (2)
Damp heat, steady state (continuous humidity)	IEC 60068-2-78 (Cab)	55 °C/131 °F, 93% relative humidity, t = 96 hrs [for ruggedized range: 60 °C/140 °F] (2)
Damp heat, cyclic (cyclical humidity)	IEC 60068-2-30 (Db)	55...25 °C/131...77 °F, 93...95% relative humidity, 2 cycles t = 12 hrs + 12 hrs
Change of temperature	IEC 60068-2-14 (Nb)	0... 60 °C/32... 140 °F, 5 cycles t = 6 hrs + 6 hrs [for ruggedized range: - 25...70 °C/-13... 158 °F] (2)
Name of test	Standards	Levels
Withstand to climatic variations (1) (power off)		
Dry heat	IEC/EN 61131-2; IEC 60068-2-2 (Bb & Bd)	85 °C/185 °F, t = 96 hrs
Cold	IEC/EN 61131-2; IEC 60068-2-1 (Ab & Ad)	-40 °C/-40 °F, t = 96 hrs
Damp heat, cyclic (cyclical humidity)	IEC/EN 61131-2; IEC 60068-2-30 (Db)	55...25 °C/77...131 °F, 93...95% relative humidity, 2 cycles t = 12 hrs + 12 hrs
Change of temperature (thermal shocks)	IEC/EN 61131-2; IEC 60068-2-14 (Na)	-40...85 °C/-40...185 °F, 5 cycles t = 3 hrs + 3 hrs

(1) Devices must be installed, wired, and maintained in accordance with the instructions provided in the manual "Grounding and Electromagnetic Compatibility of PLC Systems" (see page 10/4).

(2) Refer also to the section "Treatment for severe environments".

(CE): Tests required by European CE directives and based on IEC/EN 61131-2 standards.

Environment tests (continued)		
Name of test	Standards	Levels
Immunity to mechanical constraints (1) (power on)		
Sinusoidal vibrations	IEC/EN 61131-2; IEC 60068-2-6 (Fc)	Basic IEC/EN 61131-2: 5...150 Hz, ± 3.5 mm/0.14 in. amplitude (5...8.4 Hz), 1 g (8.4...150 Hz) Specific profile: 5...150 Hz, ± 10.4 mm/0.41 in. amplitude (5...8.4 Hz), 3 g (8.4...150 Hz) For basic and specific: endurance: 10 sweep cycles for each axis
	IEC 60870-2-2; IEC 60068-2-6 (Class Cm)	2... 500 Hz, 7 mm/0.28 in. amplitude (2...9 Hz), 2 g (9...200 Hz), 1.5 g (200...500 Hz) endurance: 10 sweep cycles for each axis
	IEC 60068-2-6	Seismic analysis: 3...35 Hz, 22.5 mm/0.89 in. amplitude (3...8.1 Hz), 6 g (8.1...35 Hz)
Shock	IEC/EN 61131-2; IEC 60068-2-27 (Ea)	30 g, 11 ms; 3 shocks/direction/axis (2) For Modicon M580 Safety: 15 g, 11 ms; 3 shocks/direction/axis 25 g, 6 ms; 100 bumps/direction/axis (bumps) (3)
Free fall during operation	IEC/EN 61131-2; IEC 60068-2-32 (Ed Method 1)	1 m/3.28 ft, 2 falls
Withstand to mechanical constraints (power off)		
Random free fall with packaging	IEC/EN 61131-2; IEC 60068-2-32 (Method 1)	1 m/3.28 ft, 5 falls
Flat free fall	IEC/EN 61131-2; IEC 60068-2-32 (Ed Method 1)	10 cm/0.33 ft, 2 falls
Controlled free fall	IEC/EN 61131-2; IEC 60068-2-31 (Ec)	30° or 10 cm/0.33 ft, 2 falls
Plugging/Unplugging	IEC/EN 61131-2	For modules and connectors: Operations: 50 for permanent connections, 500 for non-permanent connections

(1) Devices must be installed, wired, and maintained in accordance with the instructions provided in the manual "Grounding and Electromagnetic Compatibility of PLC Systems" (see page 10/4).

(2) When using fast actuators (response time ≤ 5 ms) driven by relay outputs: 15 g, 11 ms; 3 shocks/direction/axis.

(3) When using fast actuators (response time ≤ 15 ms) driven by relay outputs: 15 g, 6 ms; 100 bumps/direction/axis.

(C): Tests required by European CE directives and based on IEC/EN 61131-2 standards.

Environment tests (continued)		
Name of test	Standards	Levels
Equipment and personnel safety (1) (CE)		
Dielectric strength and insulation resistance	IEC/EN 61131-2; IEC 61010-2-201; UL; CSA	Dielectric: $2 U_n + 1000 \text{ V}$; $t = 1 \text{ min}$ Insulation: $U_n \leq 50 \text{ V}$: $10 \text{ M}\Omega$, $50 \text{ V} \leq U_n \leq 250 \text{ V}$: $100 \text{ M}\Omega$
Ground continuity	IEC/EN 61131-2; IEC 61010-2-201; UL; CSA	30 A , $R \leq 0,1 \Omega$; $t = 2 \text{ min}$
Leakage current	IEC/EN 61131-2; IEC 61010-2-201; UL; CSA	$\leq 0.5 \text{ mA}$ in normal condition $\leq 3.5 \text{ mA}$ in single fault condition
Protection offered by enclosures	IEC/EN 61131-2; IEC 61010-2-201	IP20 and protection against standardized pins
Impact withstand	IEC/EN 61131-2; IEC 61010-2-201; UL; CSA	Sphere of 500 g , fall from $1.3 \text{ m}/4.27 \text{ ft}$ (energy 6.8 J minimum)
Overload	IEC/EN 61131-2; IEC 61010-2-201; UL; CSA	50 cycles , U_n , $1.5 I_n$; $t = 1 \text{ s ON} + 9 \text{ s OFF}$
Endurance	IEC/EN 61131-2; IEC 61010-2-201; UL; CSA	I_n , U_n ; $6,000 \text{ cycles}$: $t = 1 \text{ s ON} + 9 \text{ s OFF}$
Temperature rise	IEC/EN 61131-2; UL; CSA; ATEX; IECEx	Ambient temperature $60 \text{ }^\circ\text{C}/140 \text{ }^\circ\text{F}$ [for ruggedized range: $70 \text{ }^\circ\text{C}/158 \text{ }^\circ\text{F}$] (2)

(1) Devices must be installed, wired, and maintained in accordance with the instructions provided in the manual "Grounding and Electromagnetic Compatibility of PLC Systems" (see [page 10/4](#)).

(2) Refer also to the section "Treatment for severe environments".

(CE): Tests required by European CE directives and based on IEC/EN 61131-2 standards.

Technical appendices

Certifications and EC regulations for Modicon automation products

Some countries require certain electrical components to undergo certification by law. This certification takes the form of a certificate of conformity to the relevant standards and is issued by the official body in question. Where applicable, certified devices must be labeled accordingly. Use of electrical equipment on board merchant vessels generally implies that it has gained prior approval (i.e. certification) by certain shipping classification societies.









Abbreviation	Certification body/authority	Country
CE	European Community	European Union
UL	Underwriters Laboratories	USA
CSA	Canadian Standards Association	Canada
RCM	Australian Communications and Media Authority	Australia, New Zealand
EAC	Eurasian conformity	Russia and Eurasian Economic Union
UKCA	United Kingdom Central Authority	United Kingdom
cULus	Underwriters Laboratories	USA, Canada
cCSAus	Canadian Standards Association	Canada, USA
IECEX	International Electrotechnical Commission Explosive	International
ATEX	ATmosphères EXplosives	International
TÜV Rheinland (functional safety)	Technischer Überwachungsverein Rheinland	International
ABS	American Bureau of Shipping	USA
BV	Bureau Veritas	France
DNV	Det Norske Veritas	Norway, Germany
LR	Lloyd's Register	UK
RINA	Registro Italiano Navale	Italy
RMRS	Russian Maritime Register of Shipping	Russia
RRR	Russian River Register	Russia
CCS	China Classification Society	China
KRS	Korean Register of Shipping	Korea
Class NK	Nippon Kaiji Kyokai	Japan

Note: Although DNV GL rebranded to DNV as of March 1st, 2021, all certificates with DNV GL name and logo keep their initial validity date. Only rules in force on or after March 1st, 2021, are rebranded to DNV.

The following tables provide an overview of the situation as of January 2024, in terms of which certifications (listed next to their respective bodies) have been granted or are pending for our automation products.

Up-to-date information on which certifications have been obtained by products bearing the Schneider Electric brand can be viewed on [our website](#).

Product certifications

	Certifications								
	 CE	 UL	 CSA	 RCM	 EAC	 UKCA	 UL - CSA Hazardous locations (1)	 ATEX - IECEX	 TÜV Rheinland
	EU	USA	Canada	Australia	Russia	UK	USA, Canada	International	Germany
Modicon STB							Cl. I, Div. 2, Grps ABCD	Zone 2 (2) (4)	
Modicon Telefast ABE 7									
Modicon Switch			(3)				Cl. I, Div. 2, Grps ABCD (2)	Zone 2 (2)	
Modicon MC80							Cl. I, Div. 2, Grps ABCD		
Modicon M340							Cl. I, Div. 2, Grps ABCD	Zone 2/22 (2) (5)	
Modicon M580							Cl. I, Div. 2, Grps ABCD	Zone 2/22 (2) (5)	
Modicon M580 Safety							Cl. I, Div. 2, Grps ABCD	Zone 2/22 (2) (5)	SIL3, SILCL3, SIL4, Cat.4/PLe (6)
Modicon X80							Cl. I, Div. 2, Grps ABCD	Zone 2/22 (2) (5)	
Modicon Momentum							Cl. I, Div. 2, Grps ABCD		
Modicon Quantum					(2)		Cl. I, Div. 2, Grps ABCD	Zone 2/22 (2) (5)	

(1) Refer to user manual for installation in hazardous locations.

(2) Depends on product; Refer to the product certificates on [our website](#).

(3) North American certification cULus (Canada and USA).

(4) For zones not covered by this specification, Schneider Electric offers a solution as part of the TPP (Technology Partner Program). Please contact our Customer Care Center.

(5) Certified by INERIS. Refer to the instructions supplied with each ATEX and/or IECEX certified product.

(6) Certified by TÜV Rheinland for integration into a functional safety:

- up to SIL2 or SIL3 in accordance with IEC 61508/61511 for Process











- up to SILCL3 in accordance with IEC 62061 and up to Cat.4/PLe in accordance with ISO 13849 for Machine

- up to SIL4 in accordance with EN 50126/50128/50129 for Railway

Technical appendices

Certifications and EC regulations for Modicon automation products

Marine certifications

	Shipping classification societies									
										
	ABS	BV	DNV	LR	RINA	RMRS	RRR	CCS	KRS	Class NK
	USA	France	Norway/ Germany	United Kingdom	Italy	Russia	Russia	China	Korea	Japan
Modicon STB										
Modicon Telefast ABE 7										
Modicon Switch		(1)	(1)	(1)						
Modicon MC80										
Modicon M340										
Modicon M580										
Modicon M580 Safety										
Modicon X80										
Modicon Momentum										
Modicon Quantum										

EC regulations

European Directives

The open nature of the European markets assumes harmonization between the regulations set by the member states of the European Union. European Directives are texts intended to remove restrictions on free circulation of goods and must be applied within all European Union states.

Member states are obligated to incorporate each Directive into their national legislation, and to simultaneously withdraw any regulations that contradict it.

Directives - and particularly those of a technical nature with which we are concerned - merely set out the objectives to be fulfilled (referred to as "essential requirements"). Manufacturers are responsible for taking the necessary measures to establish that their products conform to the requirements of each Directive applicable to their equipment.

As a general rule, manufacturers certify compliance with the essential requirements of the Directive(s) that apply to their products by applying a CE mark. The CE mark is affixed to our products where applicable.

Significance of the CE mark

The CE mark on a product indicates the manufacturer's certification that the product conforms to the relevant European Directives; this is a prerequisite for placing a product that is subject to the requirements of one or more Directives on the market and allowing its free circulation within European Union countries. The CE mark is intended for use by those responsible for regulating national markets.

Where electrical equipment is concerned, conformity to standards indicates that the product is fit for use. Only a warranty by a well-known manufacturer can provide reassurance of a high level of quality.

As far as our products are concerned, one or more Directives are likely to apply in each case, in particular:

- The Low Voltage Directive (2014/35/EU)
- The Electromagnetic Compatibility Directive (2014/30/EU)
- The ATEX CE Directive (2014/34/EU)
- The Machinery Directive (2006/42/EU)

Hazardous substances

These products are compatible with:

- The WEEE Directive (2012/19/EU)
- The RoHS Directive (2011/65/EU)
- The China RoHS Directive (Standard GB/T 26572-2011)
- REACH regulations (EC No. 1907/2006)

Note: Documentation on sustainable development is available on [our website](#) (product environmental profiles and instructions for use, RoHS and REACH directives).

End of life (WEEE)

End-of-life products containing electronic cards must be dealt with by specific treatment processes.

When products containing backup batteries are unusable or at end of life they must be collected and treated separately. Batteries do not contain a percentage by weight of heavy metals above the limit specified by European Directive 2013/56/EU.

(1) Please refer to the Modicon Networking catalog for more details.

Dedicated service offers for your installed base



Schneider Electric, with its experts, products, and dedicated tools, provides services such as system design, consultancy, maintenance contracts, modernization of facilities, and project delivery.

The Schneider Electric services offer is structured around several key areas:

- Maintenance and support services:
 - A set of services to help maintain reliability and availability of automated control systems. These services may be the subject of a bespoke maintenance contract to meet your requirements more closely.
- Consultancy services:
 - Diagnostics of the installed base
- Modernization solutions:
 - Migration solutions including consultancy, expertise, tools, and technical support to help ensure a smooth transition to newer technology while retaining the wiring and encoding in most cases.

Customization services are also available to accommodate specific requirements. For more information, please consult the [specific pages on our website](#).

Maintenance and support services

Spare parts, exchanges, and repairs

Everything you need to get equipment working again as quickly as possible

Solutions to respond very quickly to requests for spare parts, exchanges, and repairs to your installed automation equipment (automation platforms, Human Machine Interfaces, drives, distributed I/O):

- Spare parts management:
 - Identification of critical parts
 - Stock of spare parts: a Schneider Electric owned stock of spare parts, on your site or in one of our warehouses, with immediate availability on site or a contractually agreed delivery time if stored off site
 - Testing of spare parts stored on site
 - Automatic stock filling
- Repairs:
 - Products that have broken down are repaired in a network of worldwide repair centers. For each repaired product, our experts provide a detailed report.
- On-site repair:
 - Our experts' knowledge and expertise
 - Monitoring of specific repair procedures
 - Availability of our teams to respond 24/7
- Exchanges:
 - With standard replacements, receive a new or reconditioned product before the product that has broken down has even been sent back
 - Fast exchanges offer the option to receive the replacement product within 24 hours (in Europe)

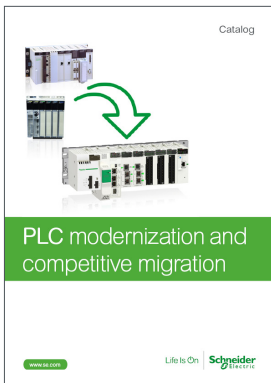

DIA6ED2171102EN

Preventive maintenance

Improving and helping to ensure the long-term reliability and performance of your installations

Schneider Electric's preventive maintenance expert assesses your site and the equipment to be managed and sets up a maintenance program to accommodate your specific requirements. A list is provided of the tasks to be performed and their frequency, including site-specific tasks, describing how preventive maintenance is to be managed.

Extended warranty

An additional manufacturer warranty covering replacement or repair of the equipment

The extended warranty offers the option to take out a 3-year warranty. The warranty period can vary according to the geographical area (please contact our Customer Care Center for more information).

Online support

Access to dedicated experts

Priority access to experts who can answer technical questions promptly concerning equipment and software both on sale and no longer commercially available.

Software subscription

Access to software upgrades and new features

By subscribing to software updates, users are able to:

- Purchase licences
- Receive updates, upgrades, software migrations, and transitions
- Download software from Schneider Electric's software library

Consultancy services

M2C (Maintenance and Modernization Consultancy)

Professional tools and methods, proven experience of managing obsolescence and updating installed bases, helping to reduce downtime and improve performance

With our maintenance and modernization consultancy offer, Schneider Electric will help you check the state of your installed base by:

- Defining the scope and depth of the analysis in collaboration with you
- Collecting the technical data without shutting down production
- Analyzing and identifying avenues for improvement
- Producing a recommendation plan

Customer benefits:

- Learning about the components that make up the installed base and what their life cycle state is (i.e. commercialized or obsolete)
- Better downtime anticipation
- Expert advice designed to improve performance

Modernization solutions

Migration to EcoStruxure

Proven expertise, tools, and methods to give you a clear vision of the improvement opportunities and guide you towards a successful modernization project



Find out more about EcoStruxure architectures on our website www.se.com

Schneider Electric offers gradual solutions of modernization through a set of products, tools, and services that allow you to upgrade your installations with our latest technologies. Our solutions offer you the choice to plan your modernization:

- Partial modernization: replacement of an old set of components with a new one
- Step-by-step modernization: gradual incorporation of new solutions or offers in the system
- Complete modernization: total renovation of the system

The table below lists our various migration offers:

Wide range of migration offers		Moving to Modicon M580/M340 platforms and Modicon X80 station						
Solution		Solution type			Tools	Solution services		
		Change the CPU and retain the I/O racks and wiring	Change the CPU and the I/O racks and retain I/O field wiring with wiring system	Change the CPU, the I/O racks, and the I/O wiring	SoftWare application conversion tool	Modernization/migration service	Manage your project	Execute your project
Platform	Premium	☑	☑	☑	☑	☑	☑	☑
	TSX47 to TSX107		☑	☑	☑	☑	☑	☑
	Quantum	☑	☑	☑	☑	☑	☑	☑
	Modicon 984 & 800 Series I/O	☑	☑	☑	☑	☑	☑	☑
	Modicon Compact		☑	☑	☑	☑	☑	☑
	Symax	☑	(1)	☑	☑	☑	☑	☑
	April Series 1000		(2)	☑	☑	☑	☑	☑
	April SMC			☑	☑	☑	☑	☑
	Merlin Gerin PB			☑		☑	☑	☑
	AEG		(1)	☑		☑	☑	☑
	Rockwell SLC500		☑	☑	☑	☑	☑	☑
	Rockwell PLC 5	☑	☑	☑	☑	☑	☑	☑
	Siemens S5 and S7			☑	☑	☑	☑	☑

☑ Service available

(1) Consult Schneider Services - project-specific solution is possible
 (2) For April Series 1000 (April 5000-7000 and April 2000-3000)
 Consult Schneider Services - project-specific solution is possible

Customization services

Schneider Electric is able to meet your specific requirements and provide you with adapted products:

- Protective coating for HMIs, automation platforms, and distributed I/O modules for use in harsh environments
- Customized cable lengths to match your specific needs
- Customized front panels for HMIs
- The multi-use flying lead I/O adapter can be prepared in the factory before use on request.

Note: To check availability of services required, please contact our Customer Care Center.

mySchneider, your personalized digital experience

Access an all-in-one customized online experience and benefit from tailored business services, resources, and tools to efficiently support your business operations.

- **Efficiency:** In just a few clicks, find all the information and support you need to get the job done.
- **Simplicity:** Use a single login to access all business services, in one place, available 24/7. You no longer need to log in to multiple platforms.
- **Personalization:** Benefit from content, tools, and business services tailored to your activity, and customize your landing page based on your preferences.

Watch the How-to Videos



Order management

- > [Select Products and Add to Cart](#)
- > [Check for Products' Price and Availability](#)
- > [Order Products with Generic Commercial References](#)



Product information

- > [Find a Product Data Sheet and Related Documents](#)
- > [Select Products and Add to Cart](#)
- > [Stay Up to Date on the Status of My Products](#)



Support

- > [Get Quicker Answers Thanks to Online Support](#)

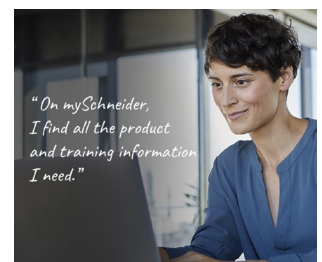

Training

- > [Access Trainings Dedicated to My Activity](#)

"On mySchneider, I find all the product and training information I need."

[Create your account](#)

Life Is On

Schneider
Electric

Life Is On



Learn more about our products at www.se.com

The information provided in this documentation contains general descriptions and/or technical characteristics of the performance of the products contained herein. This documentation is not intended as a substitute for and is not to be used for determining suitability or reliability of these products for specific user applications. It is the duty of any such user or integrator to perform the appropriate and complete risk analysis, evaluation and testing of the products with respect to the relevant specific application or use thereof. Neither Schneider Electric nor any of its affiliates or subsidiaries shall be responsible or liable for misuse of the information contained herein.

Design: Schneider Electric
Photos: Schneider Electric

Schneider Electric Industries SAS

Head Office
35, rue Joseph Monier - CS 30323
F-92500 Rueil-Malmaison Cedex
France

DIA6ED2131203EN
February 2024 - V15