

Machine truxure™

Modicon M171/M172 logic controllers
for HVAC and Pumping solutions

Catalog

October **2015**



Schneider
 Electric

Catalog October 2015 - V2.0

**Modicon M171/M172
logic controllers
for HVAC
and Pumping solutions**

General contents

General presentation.....	1
Solutions overview	2
Hardware control platforms	3
Programming software.....	4
Connectivity.....	5
Related products	6
Product reference index.....	7

Chapter 1

General presentation



Technical data relating to products listed in this chapter is available
online at www.schneider-electric.com/m171-m172

■ **General presentation**

- **MachineStruxure™**: Automation solutions at your service *page 1/2*
- **Design green machines**: 4 energy efficiency principles *page 1/3*
- **Service & support**: Stage in the product life cycle:
 - Design *page 1/4*
 - Build *page 1/4*
 - Operate *page 1/5*
 - Improve *page 1/5*

1

Automation solutions at your service

Improve your HVAC and Pumping system and business performance

Challenges

Whatever your area of focus in fluid systems - chillers, heat pumps, Air Handling Units, pumping stations, etc. for residential, building, or industrial applications - Schneider Electric has the right solution for you.

To keep your customers satisfied, you need to offer machines with intuitive automation, flexible and scalable performance, all-embedded functionality, and to be connected everywhere to the machines.

Your customers also expect a seamless integration into their Building Management Systems and the best service, anytime and anywhere in the world. Now more than ever, your choice of control solutions is key to distinguish yourself at every stage of the process, from design and development to implementation and machine maintenance.

Ready-to-use architectures and function blocks

Tested, Validated, and Documented Architectures (TVDAs) help reduce design time. They include system user guides, CAD files, and dedicated Pumping and HVAC Application Functions Blocks (AFBs) that make system design fast and easy.

Flexible and scalable machine control platforms

Scalable drive, HMI, logic, and motion controllers provide the foundation for a wide range of machine applications. Advanced drive technology and on-board energy efficiency solutions help you quickly design a cost-optimized system.

Your partner throughout the entire machine lifecycle

Our experts help you every step of the way, from engineering and perfecting machine design, to onsite service and optimization of the finished machine. For special product requirements, customization services are also available. Once installed, our global technical support, 24/7 hotline services, and replacement parts centers around the world help you deliver superior customer support and satisfaction.

Maximize your business and machine performance

With MachineStruxure™, you can maximize performance throughout the machine's entire life cycle. MachineStruxure™ solutions allow you to:

- > Reduce your machine's time-to-market
- > Increase profitability
- > Improve efficiency
- > Simplify integration and maintenance

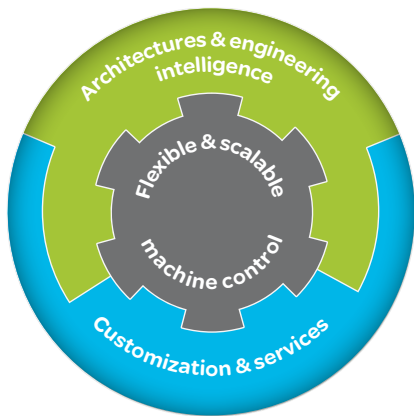

Hardware, software, and an extensive array of HVAC and Pumping specific know-how and services: MachineStruxure™ integrates it all in a single solution

4 energy efficiency principles

Improve your machines energy consumption



Pumping and HVAC machines can represent up to 40% of the overall energy consumption of buildings and facilities. Schneider Electric offers smart strategies to improve machine energy consumption according to 4 energy efficiency principles:

- 1 **Measure** the energy consumption of your machine to identify potential savings.
- 2 **Fix the basics** and reduce energy consumption by selecting the right devices.
- 3 **Optimize** your machine's energy consumption with dedicated Energy Efficiency function blocks.
- 4 **Monitor** electrical energy consumption to **maintain** and **improve** machine efficiency.

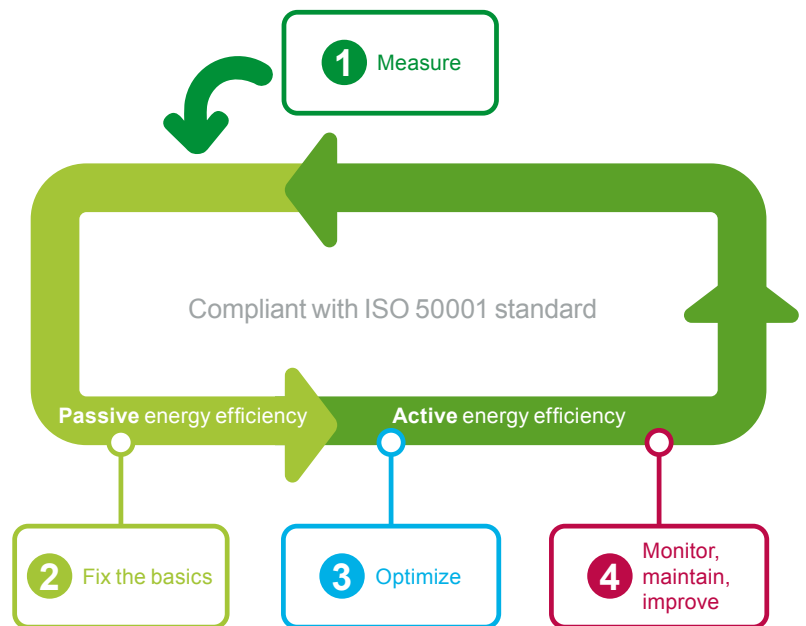

Your benefits

- > Increased visibility of your machines' energy consumption
- > Detection of "over-sized" equipment that consumes more energy
- > Possible marketing argument to your customers with real evidence of energy savings

Your customers' benefits

- > Significant reductions in energy bills
- > Improved preventive maintenance for machines
- > Increased lifespan for motors and electronic equipment

1

Service and support behind you every step of the way

Stage in the product life cycle: Design What we can bring you at this stage...



Design

We find the optimum solution for your needs

- > Based on your needs, our Solution Application Experts and Application Design Experts (SAE/ADE) work out innovative technical solutions including:
 - > Co-engineering
 - > Tests
 - > Validation

We understand your challenges

- > Consulting
- > Audits

We execute the solution with a comprehensive service agreement

- > Our solution design and delivery centers (Flex Centers) are committed to quality and results and provide tests, validation, and commissioning

We improve your team's competencies

- > In-class and on-site training

Stage in the product life cycle: Build What we can bring you at this stage...



Build

We take care of the delivery of your solution

- > Availability of components through a large worldwide network of distributors
- > Collaboration, management, and delivery through local partners
- > With Schneider Electric as your turnkey solution partner, your solutions will include:
 - > Project management and responsibility
 - > Engineered systems
 - > Third-party components management
 - > Customizations and adaptations

We provide on-site services and support

- > Secondment of qualified personnel to deliver on-site engineering and technical services

We improve your service team's competencies

- > Service and commissioning training
- > Supply chain optimization

 Make your machines stand out from the start

Service and support behind you every step of the way

Stage in the product life cycle: Operate
What we can bring you at this stage...



Operate

We provide international sales and after-sales services for you and your customers

- > Maintenance contracts
- > Spare parts and repairs
- > Just-in-time delivery
- > Return of goods
- > Service expertise
- > Diagnosis and repair
- > Environmental measurements (EMC, fieldbus, thermography, power quality analyses, etc.)
- > Customer International Support (CIS) as a single point of contact
- > A network of dedicated local country experts
- > Web-based collaborative platform for efficient communication

We improve your customers' competencies

- > In-class customer training and on-site training
- > Customer service and commissioning training

Stage in the product life cycle: Improve
What we can bring you at this stage...



Improve

We improve your pumping machine ranges

- > Consulting

We improve your customers' pumping machines in their production line

- > Audits
- > Training
- > Migration and upgrade
- > Services expertise:
 - > Consultancy
 - > Retrofitting



Contact your HVAC and Pumping experts right now at your Customer Care Center at www.schneider-electric.com

Chapter 2

Solutions overview



Technical data relating to products listed in this chapter is available online at
www.schneider-electric.com/hvacmachines
www.schneider-electric.com/pumping

■ Application solutions for HVAC

- Air/Water cooled chillers - Flexible solution (inc. TVDA) page 2/2
- Air Handling Units - Flexible solution page 2/3
- Air/Water cooled chillers - Customized solution page 2/4
- Global overview of related functions for HVAC control solutions . . page 2/5
- Related functions
 - Compressor management page 2/6
 - Floating High Pressure advanced control page 2/7
 - Fan management page 2/8
 - Plant mode control page 2/9
 - Air Handling Unit temperature control page 2/10
 - PID page 2/11
 - Drive communication control page 2/12
 - Energy management page 2/13

■ Application solutions for pumping

- Booster multi-drive page 2/14
- Booster single-drive page 2/15
- Global overview of related functions for pumping control solutions page 2/16
- Related functions
 - Booster working mode page 2/17
 - Pump Stage and De-Stage page 2/18
 - Cavitation protection page 2/18
 - Friction loss page 2/19
 - PID page 2/19

Solutions overview

Application solutions for HVAC

Air/Water cooled chillers

Air/Water cooled chillers:
Flexible solution (incorporating TVDA)

2

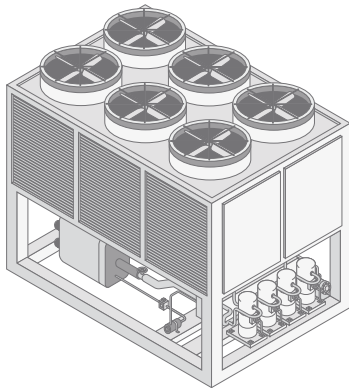

Challenges

- > Your business is producing air-cooled and water-cooled chillers. Your machine development efforts involve both mechanical aspects and control requirements. You need a flexible control system that is compatible with the various types of machine you build. Connectivity with higher-level systems and the ability to adapt the control application to future requirements is a must.
- > Time-to-market is key. You are looking for a supplier who offers smart solutions that optimize installation and commissioning time, and who has a high level of expertise in HVAC machine control.
- > You also need comprehensive worldwide technical support for your machine control system throughout the entire machine lifecycle, from development to regular operation.

Solution

- > Schneider Electric offers flexible Tested, Validated, and Documented Architectures (TVDA) designed specifically for air-cooled and water-cooled chillers. This is a flexible solution for all types of chiller that can be customized to your specific machine applications, with pre-designed control functions.
- > The solution combines a logic controller, an operating panel, a motor starter, a circuit breaker, and a variable speed drive controlled via Modbus SL fieldbus. Optional I/O modules provide a high level of flexibility to optimize your control system.
- > Schneider Electric also provides related functions to support your engineering efforts, and can quickly implement a large assortment of machine subfunctions. Dedicated energy efficiency functions deliver innovative solutions to enhance energy efficiency.
- > Connectivity to various BMS networks is provided through optional communication modules (BACnet MS/TP, BACnet IP, Modbus TCP, and others).

Architecture

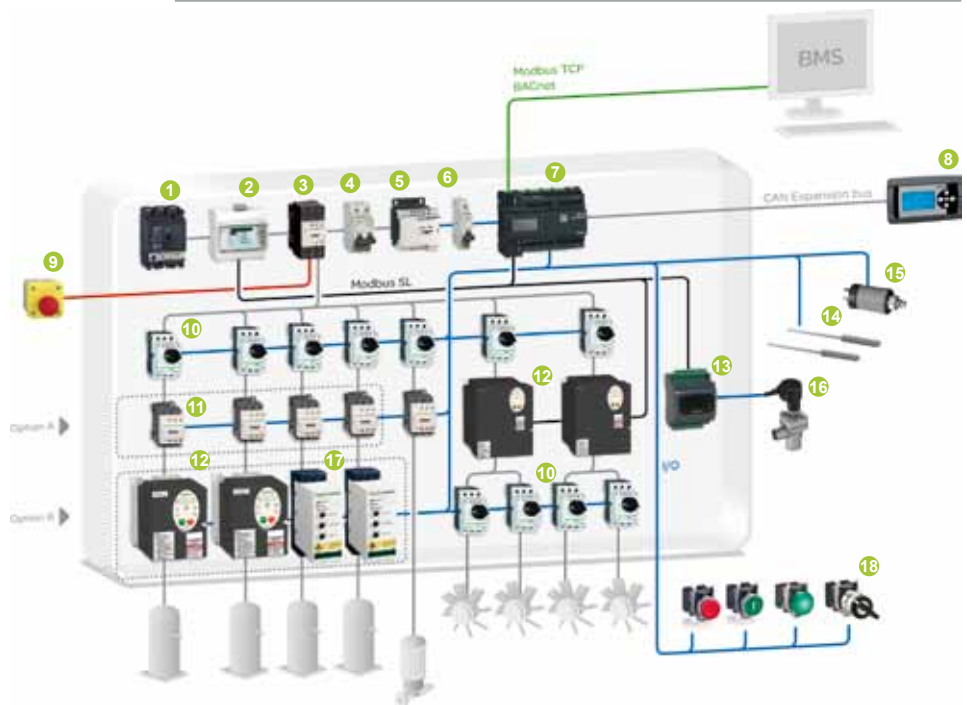

HVAC/Chiller/Modbus SL/Modicon M172 performance logic controller

Solution breakdown

- | | |
|---|---|
| 1 Compact NSX circuit breaker (1) | 10 TeSys GV2L magnetic circuit breaker |
| 2 iEM3000 energy meter (1) | 11 TeSys D contactor (1) |
| 3 TeSys D contactor (1) | 12 Altivar 212 variable speed drive, for 0.75 to 75 kW (1.0 to 100 hp) motors (1) |
| 4 C60L-MA modular circuit breaker (1) | 13 Modicon M171 electronic expansion valve driver (2) |
| 5 Phaseo switch mode power supply (1) | 14 Modicon TM1S humidity or temperature probes (2) |
| 6 C60L-DC DC circuit breaker (1) | 15 OsiSense XMLP pressure sensors (2) |
| 7 Modicon M172 performance logic controller (2) | 16 Electronic expansion valve |
| 8 Modicon M171 remote display (2) | 17 Altistart 01 soft starter (1) |
| 9 Harmony XALK Emergency stop push button (1) | 18 Harmony XB4/XB5 control & signaling units (1) |

(1) See chapter 5: Related offers.

(2) See chapter 3: Modicon M171/M172 logic controller offer.

Air Handling Units: Flexible solution

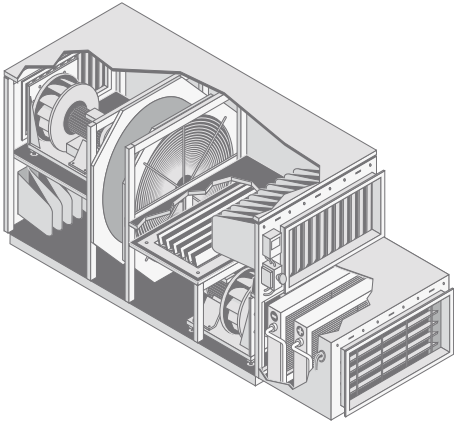

Challenges

- > Your business is producing Air Handling Units (AHUs). Your machine development efforts involve both mechanical aspects and control requirements. You need a flexible control system that is compatible with the various types of machine you build. Connectivity with higher-level systems, the ability to integrate mobile machine access, and the adaptability of the control application to future requirements is a must.
- > Time-to-market is key. You are looking for a supplier who offers smart solutions that optimize installation and commissioning time, and who has a high level of expertise in HVAC machine control.
- > You also need comprehensive worldwide technical support for your machine control system throughout the entire machine lifecycle, from development to regular operation.

Solution

- > Schneider Electric offers a flexible, fully-tested, complete control system designed specifically for Air Handling Units. This is an optimized solution for AHUs that can be customized to your specific machine applications, with pre-designed control functions.
- > The solution combines a controller, an operating panel, a motor starter, a circuit breaker, and a variable speed drive controlled via Modbus SL field bus. Optional I/O modules provide a high level of flexibility for optimizing your control system.
- > Schneider Electric also provides related functions to support your engineering efforts and quickly implement a large assortment of machine subfunctions. Dedicated energy efficiency functions deliver innovative solutions to enhance energy efficiency.
- > Connectivity to various BMS networks is provided through native Modbus SL connectivity and optional communication modules (BACnet MS/TP, BACnet/IP, Modbus TCP, and others).

Architecture

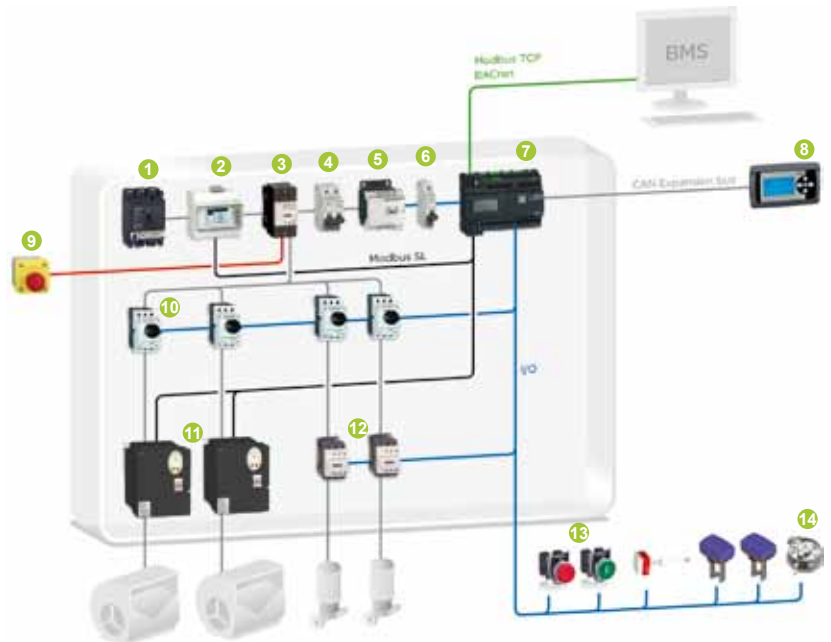

HVAC/AHU/Modbus SL/Modicon M172 performance logic controller

Solution breakdown

- | | |
|---|---|
| 1 Compact NSX circuit breaker (1) | 10 TeSys GV2L magnetic circuit breaker |
| 2 iEM3000 energy meter (1) | 11 Altivar 212 variable speed drive, for 0.75 to 75 kW (1.0 to 100 hp) motors (1) |
| 3 TeSys D contactor (1) | 12 TeSys D contactor (1) |
| 4 C60L-MA modular circuit breaker (1) | 13 Harmony XB4/XB5 control & signaling units (1) |
| 5 Phaseo switch mode power supply (1) | 14 Differential pressure switch (1) |
| 6 C60L-DC DC circuit breaker (1) | |
| 7 Modicon M172 performance logic controller (2) | |
| 8 Modicon M171 remote display (2) | |
| 9 Harmony XALK Emergency stop push button (1) | |

(1) See chapter 5: Related offers.
 (2) See chapter 3: Modicon M171/M172 logic controller offer.

Solutions overview

Application solutions for HVAC

Air/water cooled chillers, chillers, rooftop units, Air Handling Units, HVAC machines

Customized solution

2

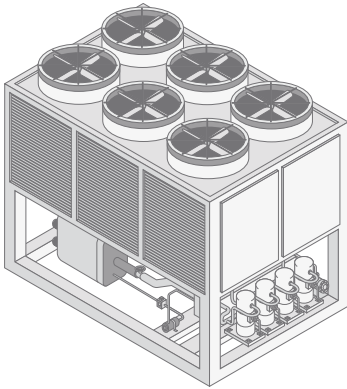

Challenges

- > You need to reduce the overall cost of your machine control panels, and achieve optimal sizing of all electrical components. Building control panels is not part of your core business.
- > You want to reduce the cost of your stock of electrical components.
- > You are looking for expertise in the engineering, design, and manufacture of control solutions. You expect fully customizable turnkey control panel solutions with a minimum number of component suppliers.

Solution

- > Schneider Electric provides manufacturers of HVAC machines with fully customizable turnkey control panel solutions. We deliver solutions quickly and offer a complete logistical management service.
- > Our experts will design your specific control panel based upon your specifications, and optimize it in terms of size and components.
- > In order to optimize the energy consumption of your HVAC machine, our experts provide the right solution to build an energy efficient machine.
- > Based upon your needs, we can design your control solution in compliance with national standards in the countries where your machine is delivered.

Benefits

The main advantages offered by our customized solutions are:

Expertise in panel building and HVAC control

- > Our experts have a high level of expertise in control panel design and HVAC control solutions.

A turnkey solution

- > A control panel solution for a pre-assembled solution based upon your specific needs.

Increased profitability

- > Optimized and standardized “repetitive” solutions for highly cost-efficient control panels.

Worldwide compliance

- > We design your electrical cabinet in compliance with national standards, wherever you deliver.

Flexibility and openness

- > Large choice of system configuration options. Features can be added to your machines as needed. Expert support for system adaptations.

A single supplier

- > Complete control system architecture, including all installation components, completely assembled and delivered by a single supplier.
- > A single provider of solutions, from machine controls and building management systems to large automation and management installations.

Your automation partner

- > Our experts, our application centers, and our worldwide service provide you with comprehensive support throughout the entire machine lifecycle.

Application Function Blocks

Schneider Electric has also developed a user-friendly tool for customers to design their control systems quickly and efficiently themselves. A set of Application Function Blocks (AFBs) is included in SoMachine HVAC software to help, for example:

- > to reduce the development time for new machines
- > to manage your compressors or fans efficiently with a variable speed drive
- > to include floating High Pressure control
- > to control Schneider Electric variable speed drives via Modbus serial line

These AFBs have been created to help you reduce your development times and improve the efficiency of your control solutions.

Global overview of related functions

Related functions for HVAC control solutions involving chillers

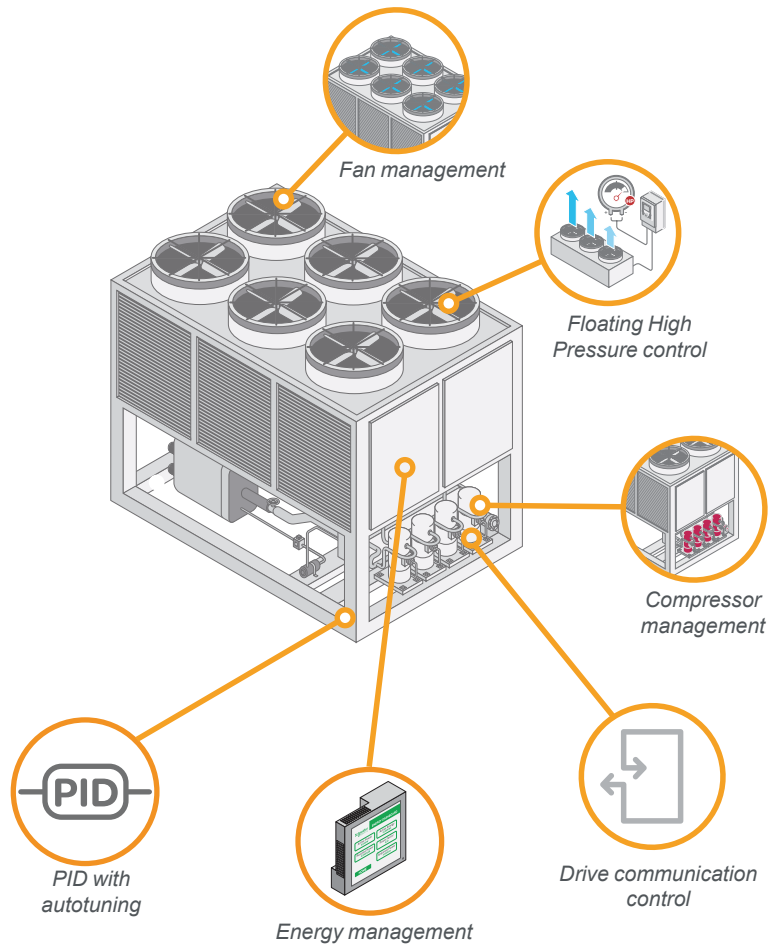

Related functions for HVAC control solutions involving Air Handling Units

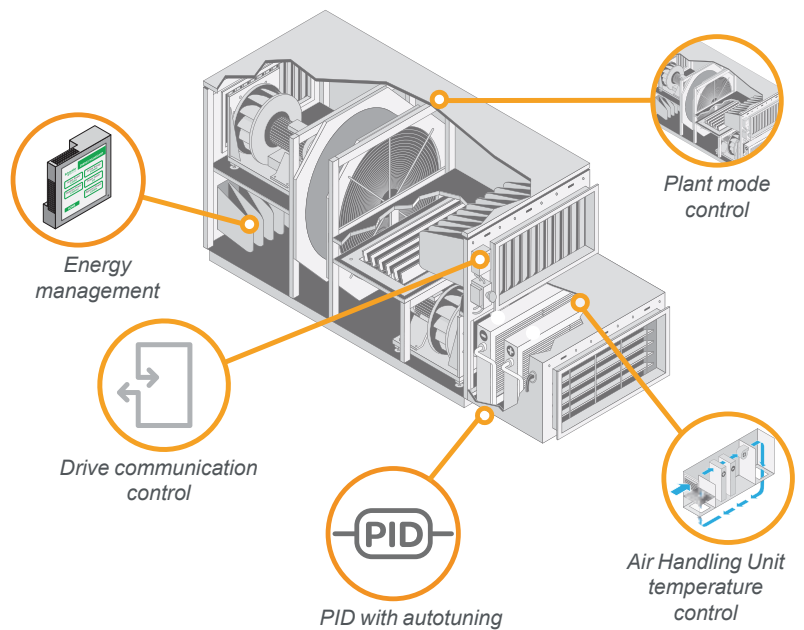

Compressor management

2

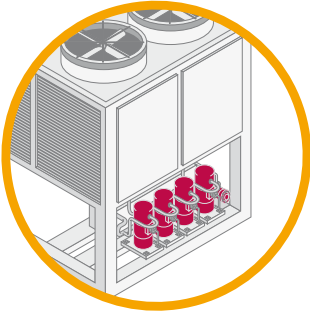

Description

The compressor management function controls a combination of fixed and variable speed compressors to maintain a constant pressure or water temperature in a chiller system.

Benefits

Performance

- > Maintains the required temperature or pressure by controlling:
 - > the capacity of the compressors in a system with a variable speed drive
 - > or the number of compressors

Response

- > Makes the system energy efficient by controlling compressor capacity prior to switching compressors on/off
- > Facilitates smooth operation by monitoring compressor availability and changing over to the next available compressor if an error is detected

Operating principle

The main objective of this function block is to perform control and switching of multiple compressors to maintain a pre-defined temperature or pressure in a chiller system. The temperature and pressure are measured through sensors while the setpoints are entered through the HMI. The function uses intelligent algorithms to manage switching by assigning priorities to the compressors based on availability and energy optimization.

Characteristics

Main characteristics:

- > Controls scroll, screw, or reciprocating compressors
- > Balances operating hours based on first in first out (FIFO), last in first out (LIFO), or runtime algorithms
- > Supports minimum on timer, minimum off timer, and minimum cycle timer to help prevent frequent compressor switching
- > Supports timers to help prevent frequent compressor switching
- > Oil recovery function helps prevent compressor damage during partial load conditions
- > Helps eliminate resonance frequencies during compressor operation, thereby helping to increase compressor lifetime and reduce noise
- > Supports up to 8 compressors per refrigerant circuit
- > Allows variable speed drive regulation
- > Supports heating or cooling mode

Typical applications

- > Air and water cooled chillers
- > Heat pumps
- > Rooftop units
- > Compressor racks

Floating High Pressure control with variable speed drives

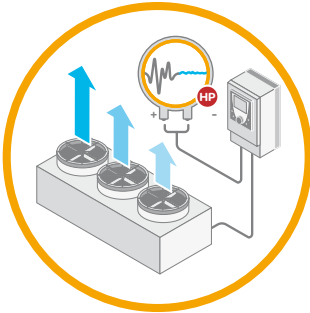

Description

This Application Function Block (AFB) controls the condensing pressure of the air-cooled condenser. It manages the High Pressure setpoint and provides the information to the fan management AFB. The setpoint is defined so as to be able to reduce the energy consumption of the system.

Benefits

Energy performance

- > Energy saving of up to 40% by combining variable speed drives with floating High Pressure control

Operating principle

The AFB calculates a High Pressure setpoint based on the outside temperature evolution. The required pressure is controlled by modulating the air flow through fans (on/off and speed control).

3 methods are used to calculate the High Pressure setpoint:

- > fixed High Pressure setpoint
- > floating High Pressure setpoint with constant offset
- > floating High Pressure setpoint with variable offset

Characteristics

This AFB:

- > includes a heat recovery input to allow the High Pressure setpoint to be increased if necessary
- > manages the minimum and maximum setpoints
- > includes a function to limit setpoint variation
- > includes PID control

Typical applications

- > Air-cooled condensers

High pressure control white paper

Refrigeration processes use a considerable amount of energy (30 to 80%) in the food industry, storage, grocery stores, and hypermarkets. It is one of the first expenditures where users want to save money, but it is also the least known and most critical. Despite solutions that have been existing for years, the initial choice favors operation and investment rather than energy consumption.

Among solutions to save energy in refrigeration, High Pressure (HP) control is one of the most well-known, if not the best known, for refrigeration equipment. When properly implemented, this solution can help cut electricity bills by more than 30%. However, technology alone is not sufficient to obtain energy savings. It is necessary to properly implement HP control to maximize savings and avoid technical problems.

A white paper has been drawn up by Schneider experts and is available to download from our website: <http://www2.schneider-electric.com/sites/corporate/en/support/white-papers/high-pressure-control.page>

It explains how HP control generates energy savings versus regulation with constant HP, and gives technical constraints.

Energy savings in commercial refrigeration equipment:

High Pressure Control

July 2011/White paper

by Christophe Borlein

AFB and IIF-IR member

Make the most of your energy

White paper by Schneider Electric

Fan management

2

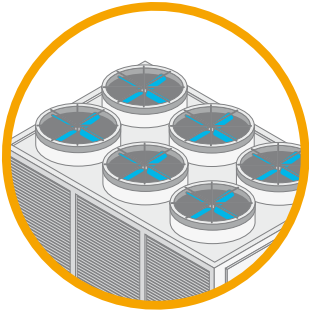

Description

In order to control the condensing pressure of air-cooled condensers, this function block controls the frequency, starting, and stopping of the fans in a predetermined order to optimize their energy consumption, operating time, and availability.

Benefits

Reliability

- > Fans with detected errors are automatically replaced in the sequence by operational fans.
- > Fan service life is optimized through operation sequences (FIFO, balancing hours, LIFO).

Performance

- > Fan switch-on and operating frequency are optimized in order to reduce the energy consumption of the air-cooled condenser.

Operating principle

Depending on the input, this AFB manages the number of stages of fans to be used. Up to 12 fans per stage can be used, with a maximum of 4 stages. Regulation allows the maximum surface of the condenser to be used in order to reduce the consumption of the fans.

Characteristics

This AFB provides:

- > Linear action between PID and flow
- > Management of detected errors and subsequent compensation of fan operation
- > Operation with no delay and management of frequencies:
this function increases control stability and reduces the number of fan starts/stops.

Typical applications

- > Air-cooled condensers

Plant mode control

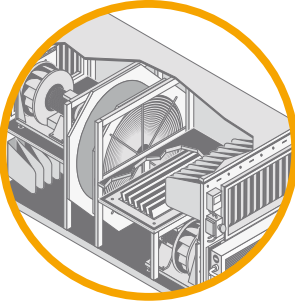

Description

This Application Function Block (AFB) determines the operating mode for an Air Handling Unit. Besides monitoring the status of alarms, the AFB also monitors room and outdoor air temperatures to reduce cooling energy needs and improve comfort levels.

Benefits

Monitored operation

- > The Air Handling Unit is set to a secure operation mode on detection of a fire alarm, fan alarm, or freeze state alarm
- > The night cycle function monitors room temperatures to help protect the building against condensation or other damage due to extreme indoor temperature conditions (too hot or too cold).

Energy optimization

- > The night purge function purges and pre-cools the building during unoccupied periods to reduce cooling energy needs (free cooling).
- > The night cycle mode maintains a lower room temperature during heating periods and a higher room temperature during cooling periods to reduce the cooling or heating energy needs.

Operating principle

At start-up, the AFB checks the status of the alarms and the various operating modes, then automatically starts or stops the Air Handling Units.

Characteristics

This AFB can be used with all types of Air Handling Units.

Typical applications

- > Air Handling Units

Air Handling Unit temperature control

2

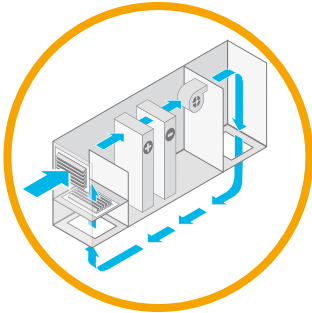

Description

This Application Function Block (AFB) controls the discharge air temperature of Air Handling Units with or without mixing dampers. Heating coil, cooling coil, dampers, and fan speed are modulated in sequence to control the temperature. The function block supports 2 major temperature algorithms: constant discharge air temperature control and return air compensated discharge air temperature control.

Benefits

Energy performance

- > The Air Handling Unit air volume is controlled to keep optimum indoor air quality conditions with minimum air volume.
- > The economizer control function reduces cooling energy costs by choosing the most economical air for cooling indoor space.
- > The summer compensation function reduces cooling energy costs by increasing indoor space temperature in summer seasons.

Comfort

- > Optimum comfort is achieved by adjusting the compensated discharge air temperature according to changes in the outdoor air temperature.
- > An increased indoor space temperature during summer seasons avoids climate shocks when entering or leaving buildings.
- > An increased discharge air temperature during winter seasons increases human comfort by compensating conductive cold from walls during winter seasons.

Operating principle

At startup, the freeze protection and recovery function stops the AHU cycling due to low outdoor air temperature conditions. The AHU can operate in constant discharge air temperature control mode or in a return air compensated discharge air temperature control mode. The temperature is controlled by sequencing the heating coil, damper, cooling coil, and fan speed.

Characteristics

This AFB can be used with all types of Air Handling Units.

Typical applications

- > Air Handling Units

PID with autotuning



Description

The advanced PID function blocks are optimized for temperature or pressure control in HVAC systems. With the additional PID Autotune function, the control system is capable of analyzing the response time of the control loop and calculating the correct PID parameter settings.

Benefits

Precision

- > PID control maintains the required controlled variable through adjustment.
- > It minimizes the deviation of the actual process value from the setpoint to optimize system control.

Efficient setup

- > Various loop control interactions available to manage different required machine operating modes
- > Automatic detection of PID control loop parameter with autotuning

Operating principle

PID control maintains the actual value and adjusts the output value according to deviations in the system's response. The PID function supports automatic and manual operating mode and is capable of monitoring a user-defined deadband on the actual value with alarm indication in case of undershoot or overshoot. The hold and reset commands can also be used to regulate the process.

The PID Autotune function is used to analyze the system response and determine the correct PID parameters.

The PID Autotune and PID Advanced functions interact directly. Depending on the operating mode of the PID Autotune function, it controls the PID Advanced function regulation and provides PID parameters for it.

Characteristics

Main characteristics:

- > Operating modes: automatic and manual
- > Hold function to help eliminate windup
- > Integral anti-windup
- > Deadband for more stable control
- > Adjustable high or low limits
- > Direct and reverse control

Typical applications

- > Air and water cooled chillers
- > Heat pumps
- > Rooftop units
- > Air Handling Units

Drive communication control

2

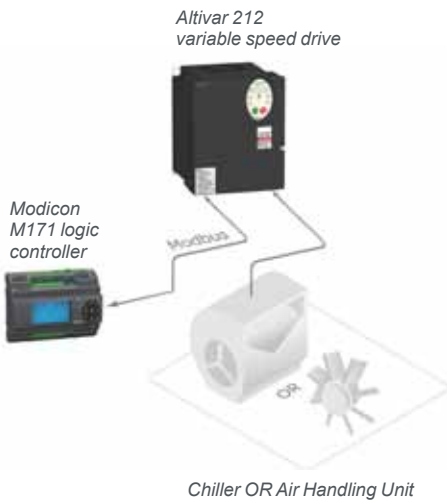
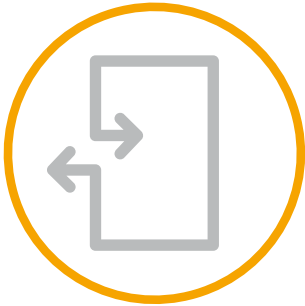

Description

These function blocks provide an easy and efficient way to integrate one or several Altivar variable speed drive(s) connected, via Modbus SL fieldbus, in the Modicon M171/M172 system. The function blocks manage communication with the drives and provide control and monitoring capabilities.

Benefits

Easy integration

> Easy and efficient integration of Altivar variable speed drives in the Modicon M171/M172 logic controller offer.

Complete drive control

> Control and monitoring of Altivar variable speed drives on a Modicon M171/M172 logic controller without any additional development.

Operating principle

The drive communication function blocks are designed to control and monitor Altivar variable speed drives connected to a Modicon M171/M172 logic controller via Modbus SL. The function blocks completely manage the Modbus SL communication with the drive and provide direct control of the speed and drive modes. Communication and drive status are monitored permanently and detected faults are indicated on the function block.

Characteristics

These function blocks are designed for the Modicon M171/M172 logic controllers. They can be used with all types of HVAC machine and pumping application requiring an Altivar variable speed drive to operate e.g. compressors, fans, and pumps. Function blocks are available for Altivar 12, Altivar 21, Altivar 212, Altivar 31, Altivar 312, Altivar 32, Altivar 61, and Altivar 71 variable speed drives.

Typical applications

- > HVAC machines
- > Pumping applications

Energy management

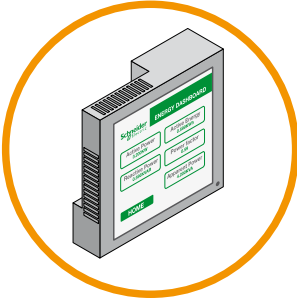

Description

The energy management function blocks are designed for applications where the machine energy consumption needs to be metered and energy efficiency information is required. The function blocks provide an easy integration of metering devices into the system and offer calculations methods to determine the machine efficiency, COP, or ESEER (1).

Benefits

Quick and easy integration

- > Preprogrammed and fully tested metering functions are provided for a quick and easy integration of energy metering devices and machine efficiency calculation methods.
- > The function blocks provide an efficient integration of electrical metering devices either connected via Modbus SL or hardwired by using pulses.
- > A thermal energy calculation function block is embedded to determine the produced thermal energy. With dedicated trending and COP (1) calculation functions, machine efficiency can be monitored and analyzed in detail.
- > The function block allows the cooling capacity to be calculated without adding a flow meter.

Operating principle

A wide range of functions are covered by a comprehensive set of metering function blocks, from retrieving energy information to energy efficiency calculations and trending.

Characteristics

The following function blocks are designed to be used in the Modicon M171/M172 logic controller application:

- > Digital input pulse totalizer: counts the digital input pulses from an energy meter
- > Converter of totalized pulses from energy meter: converts the digital input pulses into the consumption
- > Thermal power calculation: calculates the thermal power, an energy based on the flow (for water chillers)
- > Coefficient of performance calculation: calculates the COP based on the consumption and the thermal power
- > Energy meter data trend: Trend of consumption data over time

To calculate the thermal energy, a flow meter must be installed in the system and the heat capacity of the medium must be known.

Thanks to a new AFB named "COPMonitor", which combines 6 other AFBs, the COP can be calculated without the need for a flow meter. The flow is calculated based on the compressor characteristics and the thermal power produced by the machine is calculated based on the enthalpies of the machine.

Typical applications

- > Air and water cooled chillers
- > Heat pumps
- > Rooftop units
- > Compressor racks

(1) COP = Coefficient Of Performance. Efficiency of the chiller or heat pump calculated by the cooling or heating power divided by electrical power consumption.
 ESEER = European Seasonal Energy Efficiency Ratio: seasonal efficiency of refrigeration equipment, chillers, and air conditioners calculated by the cooling or heating power divided by the electrical power consumption at different loads.

Booster multi drive

Description

This architecture is adapted for pumping manufacturers with high-level specialized expertise. It combines a logic controller, an energy meter, and variable speed drives (on Modbus or hardwired). The whole setup gives you maximum flexibility and helps you to simplify your installation. At the same time, the SoMachine HVAC controller software provides dedicated pumping functions to increase the performance of your booster and optimize operation.

Architecture

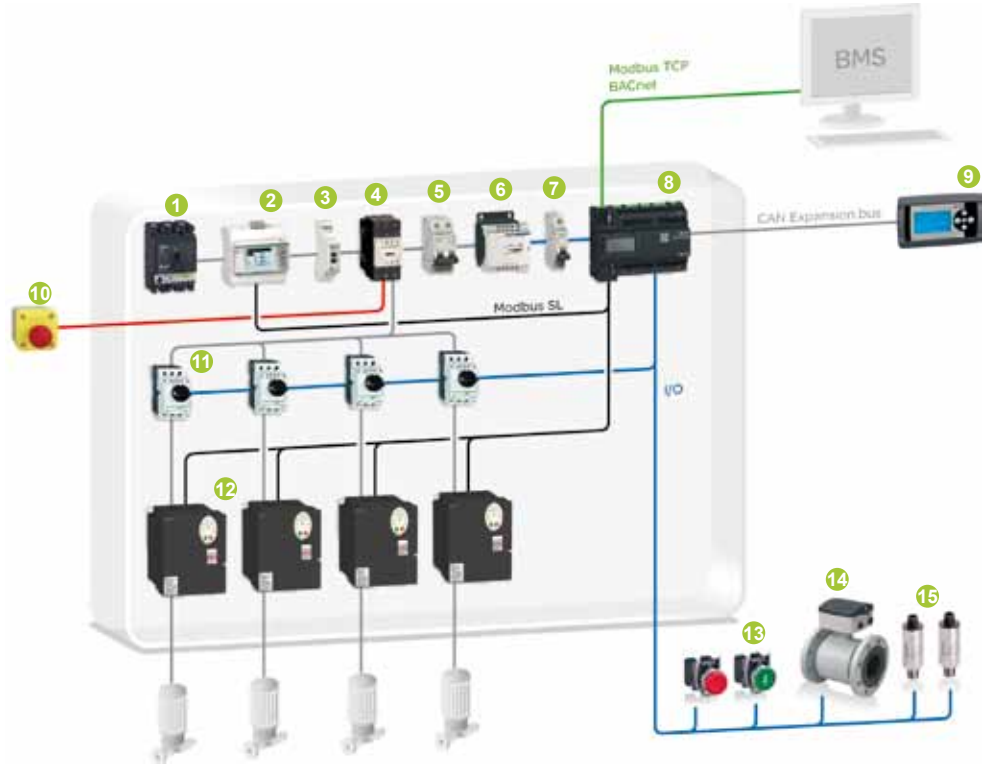

Pumping Booster / Multi Drive/Modbus SL/Modicon M172 performance logic controller

Solution breakdown

- | | |
|---|---|
| 1 Compact NSX circuit breaker (1) | 11 TeSys GV2L magnetic circuit breaker |
| 2 iEM3000 energy meter (1) | 12 Altivar 212 variable speed drive, for 0.75 to 75 kW (1.0 to 100 hp) motors (1) |
| 3 Zelio control phase sequence (1) | 13 Harmony XB4/XB5 control & signaling units (1) |
| 4 TeSys D contactor (1) | 14 Flow meter (third-party product) |
| 5 C60L-MA modular circuit breaker (1) | 15 OsiSense XMLP pressure sensors (2) |
| 6 Phaseo switch mode power supply (1) | |
| 7 C60L-DC DC circuit breaker (1) | |
| 8 Modicon M172 performance logic controller (2) | |
| 9 Modicon M171 remote display (2) | |
| 10 Harmony XALK Emergency stop push button (1) | |

(1) See chapter 5: Related offers.

(2) See chapter 3: Modicon M171/M172 logic controller offer.

Booster single drive

Description

This solution is dedicated to simple and standard boosters in buildings. This is the first step towards automation of traditional relay architectures. With a built-in display on a Modicon M171/M172 logic controller, this solution is very cost effective. Single drive can be used in single or multi drive mode.

Architecture

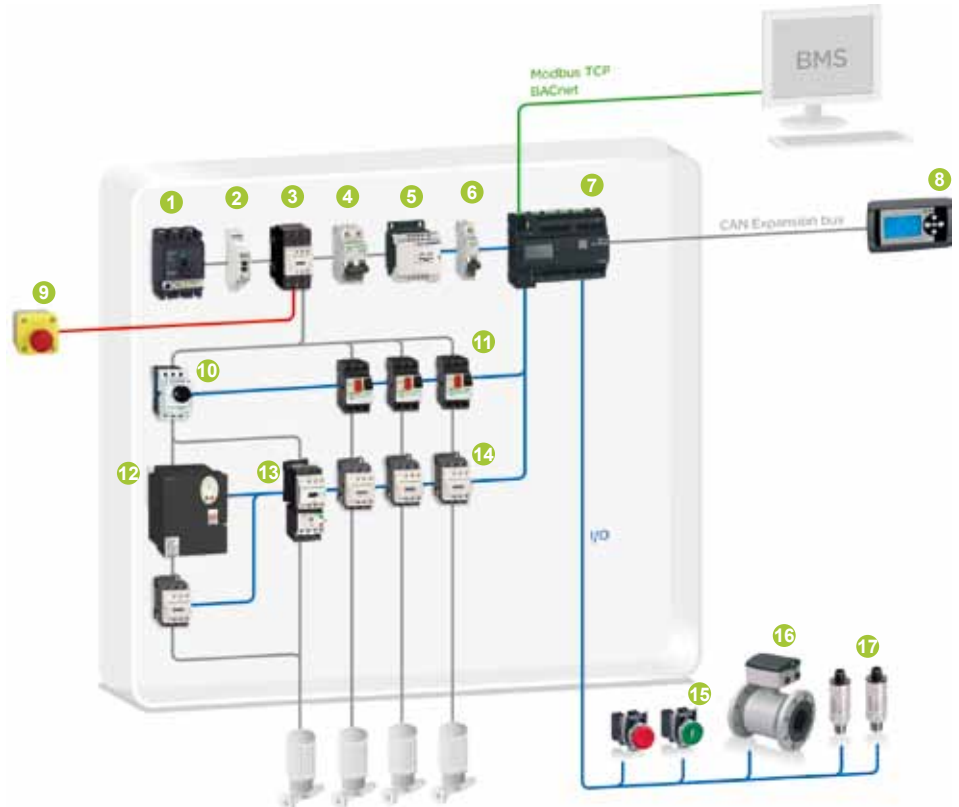

Pumping Booster / Single Drive/Hardwired/Modicon M172 performance logic controller

Solution breakdown

- | | |
|---|---|
| 1 Compact NSX circuit breaker (1) | 11 TeSys GV2 motor circuit breaker |
| 2 Zelio control phase sequence (1) | 12 Altivar 212 variable speed drive, for 0.75 to 75 kW (1.0 to 100 hp) motors (1) |
| 3 TeSys D contactor (1) | 13 TeSys GV2M circuit breaker (1) |
| 4 C60L-MA modular circuit breaker (1) | 14 TeSys D contactor |
| 5 Phaseo switch mode power supply (1) | 15 Harmony XB4/XB5 control & signaling units (1) |
| 6 C60L-DC DC circuit breaker (1) | 16 Flow meter (third-party product) |
| 7 Modicon M172 performance logic controller (2) | 17 OsiSense XMLP pressure sensors (2) |
| 8 Modicon M171 remote display (2) | |
| 9 Harmony XALK Emergency stop push button (1) | |
| 10 TeSys GV2L magnetic circuit breaker | |

(1) See chapter 5: Related offers.

(2) See chapter 3: Modicon M171/M172 logic controller offer.

Global overview of related functions

Related functions for pumping control solutions

2

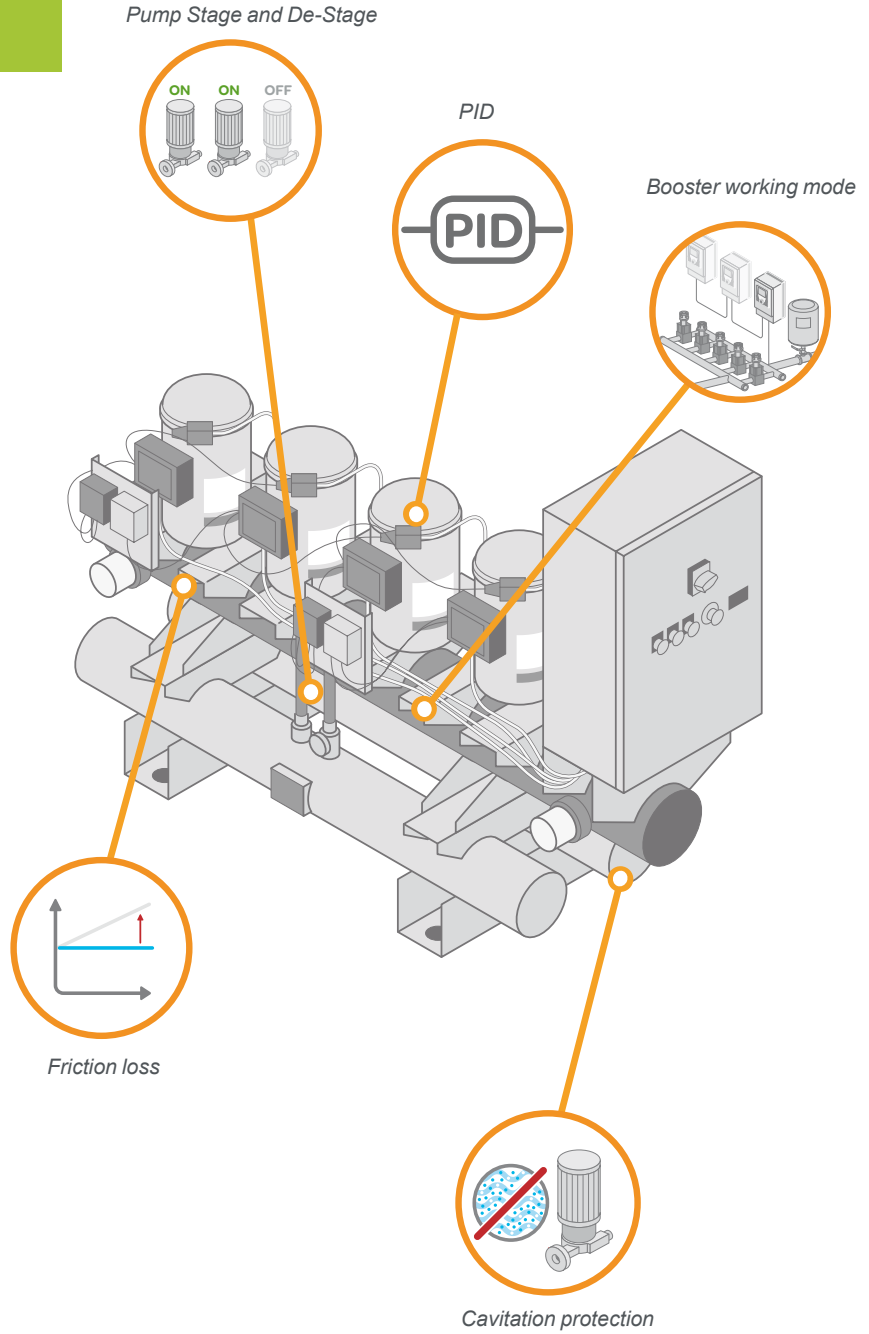

Booster working mode

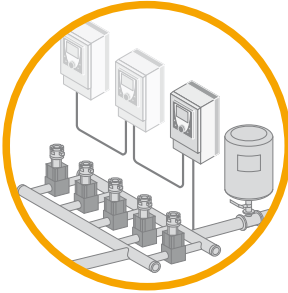

Description

This function is used to run in the “single drive” or “multi drive” operating mode in a booster system.

Definition and benefits

Multi drive

- > Definition: in this mode, each pump in the system is connected to an individual drive.
- > Main advantage: this type of arrangement provides the most energy efficient systems and a higher level of pump protection. Systems are easy to maintain.

Single drive, multi-lead

- > Definition: In this mode, a single drive is used to start the first pump in the system. Pump selection is based on pump operating hours or detected error status, or a user-defined priority.
- > Main advantage: these types of arrangement are cost effective.

Single drive, single-lead

- > Definition: In this mode, a single drive is used to start one pump only in the system and there is no switching of drives to another pump.
- > Main advantage: these types of arrangement are cost effective.

Operating principle

The main purpose of this function is to enable the user to select the optimum operating mode for the booster system. By selecting multi-lead systems, multiple pumps, connected to drives or contactors, can be controlled to switch different pumps to operate them in the most optimized manner. Switching is based upon pressure, operating hours, and the available pumps in the system.

Single drive systems can select the pump to be connected and started with the only drive present in the system. The other fixed-speed pumps are started or stopped based upon pressure requirements. If an error is detected on the pump connected to the drive or it experiences a stoppage, the drive will be connected to the first available pump based upon the operating hours or detected error status of the pump, or a user-defined priority.

In single drive, single-lead systems the single drive in the system is connected to only one pump and there is no switching of the drive to other pumps in the system. The other fixed-speed pumps are started by DOL based upon pressure requirements.

Characteristics

Main characteristics:

- > Pump switching is performed to operate the pumps in the most optimized and energy efficient manner.
- > The function detects the next available pump based on operating hours, detected errors, and pressure requirements.
- > The function is capable of bypassing drives in the event of a detected error.
- > Switching values can be set from the HMI.

Typical applications

- > Booster pumping system consisting of multiple pumps

2

Pump Stage and De-Stage

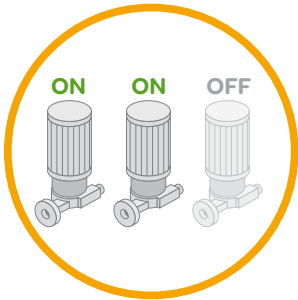

Description

The Pump Stage and De-Stage function switches a combination of fixed and variable speed pumps to maintain a constant pressure in a booster system.

Benefits

Performance

- > Maintains the required pressure by performing switching between the pumps available in the system

Optimization

- > Makes the system energy efficient by defining the operational combination of pumps in such a way that the pumps operated by drives are given priority
- > Facilitates smooth operation by monitoring pump availability and changing over to the next available pump if an error is detected

Operating principle

The main objective of this function is to perform switching of multiple pumps to maintain a pre-defined pressure in the booster system. The flow and pressure are measured through sensors while the setpoints are entered from the HMI. The function uses intelligent algorithms to manage switching by assigning priorities to the pumps based on availability and energy optimization.

Characteristics

Main characteristics:

- > This function is capable of maintaining the required pressure in the booster system using an energy efficient algorithm to determine optimum pump operation.
- > Pump switching is based on the principle of assigning higher priority to variable speed pumps and pumps with fewer operating hours.
- > In the event of a detected error, the function uses an intelligent algorithm to switch to the next available pump.

Typical applications

- > Booster pumping system consisting of multiple pumps

Cavitation protection



Description

This function stops pumps from operating under conditions of cavitation.

Benefits

Optimization

- > Promotes a longer service life by helping to ensure pumps do not operate in cavitation
- > Adapts setpoints to optimize pump operation

Monitoring

- > Generates alarms in case of detection of cavitation in the system

Operating principle

The main purpose of this function is to help ensure pumps do not operate under cavitation conditions. If cavitation is detected, the function immediately stops the pumps. This is achieved by reducing the pressure setpoint/flow in the system. After completing this task and resetting the alarm, the function checks the suction pressure is within the permissible limits, the function restarts the pumps in normal mode.

Characteristics

- > Detects abnormality in pressure using the actual suction feedback pressure value
- > Activates algorithms to adjust setpoints to avoid cavitation conditions
- > Uses a limit switch function to avoid toggling of the cavitation mode
- > Generates alarms on detection of cavitation conditions

Typical applications

- > Booster pumping system consisting of single or multiple pumps

Friction loss

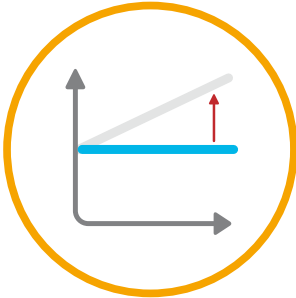

Description

This function compensates the friction lost by adapting the pressure setpoint according to the number of running pumps or the flow value (optional) in the discharge side.

Benefits

Optimization

- > Promotes a longer operating life of the pump by maintaining a linear pressure in the system
- > Adapts pressure setpoints to optimize pump operation

Monitoring

- > Generates alarms in case of detection of abnormality in the suction pressure curve

Operating principle

Ideal pressure can be maintained either based on flow or the setpoints of each pump in the system. For flow, the function adapts the setpoint based on the system curve with the help of the actual flow value. Both absolute and percentage values can be used. The minimal setting (two points) to use this function are:

- > The increased value in percent (% to increase the standard setpoint) or the absolute value of the setpoint to reach the setpoint value on the highest and farthest point of the system in case of minimal flow. The standard value of this point is zero (relative) or equal to the setpoint (absolute).
- > The increased value in percent (% to increase the standard setpoint) or absolute value of the setpoint to reach the setpoint value on the highest and farthest point of the system in case of maximal flow. The value of this point is higher than zero (relative) or greater than the setpoint (absolute).

The results of this measurement are minimum two correction values in percent or absolute values and its corresponding flow values.

In case of adaptation of the setpoints of the pumps, the function adapts the setpoint depending on the number of used pumps and the moment of the stage change.

Characteristics

- > Detects pressure abnormalities in the system
- > Executes algorithms to maintain the pressure using flow or setpoints to manage the pumps
- > Generates alarms on detection of pressure abnormalities in the system

Typical applications

- > Booster pumping system consisting of single or multiple pumps

PID



Description

The PID function adjusts the setpoint of the pumps to maintain a constant pressure in a booster system on the basis of flow and pressure.

Benefits / Operating principle / Characteristics

The benefits, the operating principle, and the characteristics are identical to those described in previous pages for HVAC equipment, for more details, see page 2/11.

Chapter 3

Hardware control platforms



Technical data relating to products listed in this chapter is available online at www.schneider-electric.com/m171-m172

- **General presentation**
 - Maximize your business and machine performance with MachineStruxure™ page 3/2
 - Improve efficiency page 3/3
 - Increase profitability page 3/4
 - Reduce time-to-market page 3/4
 - Simplify integration and maintenance page 3/5
- **Modicon M171/M172 logic controllers**
 - Presentation: range, system components page 3/6
 - Modicon M171 optimized logic controllers for simple and compact machines page 3/8
 - Modicon M171 performance logic controllers for complex and BMS connectable machines page 3/8
 - Modicon M172 performance logic controllers for large and connected machines page 3/9
 - Selection guide page 3/10
- **Modicon M171 optimized logic controllers**
 - > Presentation, Description page 3/12
 - > References page 3/13
 - > Accessories page 3/13
 - Remote display, Wall thermostats
 - > Presentation, Description page 3/14
 - > References page 3/15
 - > Accessories page 3/15
- **Modicon M171 performance logic controllers**
 - > Presentation, Description page 3/16
 - > References page 3/17
 - > Accessories page 3/17
 - Remote display
 - > References page 3/17
 - > Accessories page 3/17
- **Modicon M172 performance logic controllers**
 - > Presentation, Description page 3/18
 - > References page 3/19
 - > Accessories page 3/19
 - Remote display
 - > References page 3/19
 - > Accessories page 3/19
- **I/O expansion modules**
 - For Modicon M171 optimized logic controllers
 - > Presentation, Description page 3/20
 - > References page 3/21
 - For Modicon M171 and M172 performance logic controllers
 - > Presentation, Description page 3/20
 - > References page 3/21
 - Accessories
 - > References page 3/21
- **Communication modules**
 - For M171 performance and M172 performance logic controllers
 - > Presentation, Description page 3/22
 - > References page 3/23
- **Electronic expansion valve drivers**
 - > Presentation, Description page 3/24
 - > References page 3/25
 - Accessories
 - > References page 3/25
- **Measurement accessories**
 - Humidity and temperature probes, NTC probes, PT1000 probes
 - > References page 3/26
 - XMLP Pressure transmitters
 - > Presentation page 3/27
 - > Functions page 3/27

Hardware control platform

Modicon M171/M172 logic controllers

Maximize your business and machine performance with MachineStruxure

Maximize your business and machine performance with MachineStruxure

Machine builders are constantly looking for new ways to design and build more innovative machines in less time and at lower costs. MachineStruxure™ can help.

The NEXT generation of MachineStruxure™ is a complete machine automation solution that provides flexible and scalable machine control, ready-to-use architectures, efficient engineering solutions, and comprehensive customization and engineering support services. It can help to meet your challenges for improved efficiency and greater productivity, as well as allow to deliver higher added value to your customers throughout the entire machine life cycle.

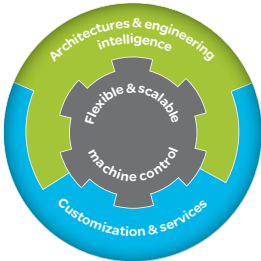

Ready-to-use architectures and function blocks

- > Tested, Validated, and Documented Architectures (TVDA) are just one of the ways we help to reduce design time.
- > Whether machines are simple or complex, Application Function Blocks (AFBs) make system design fast and easy.

Modicon M171/M172 is part of MachineStruxure

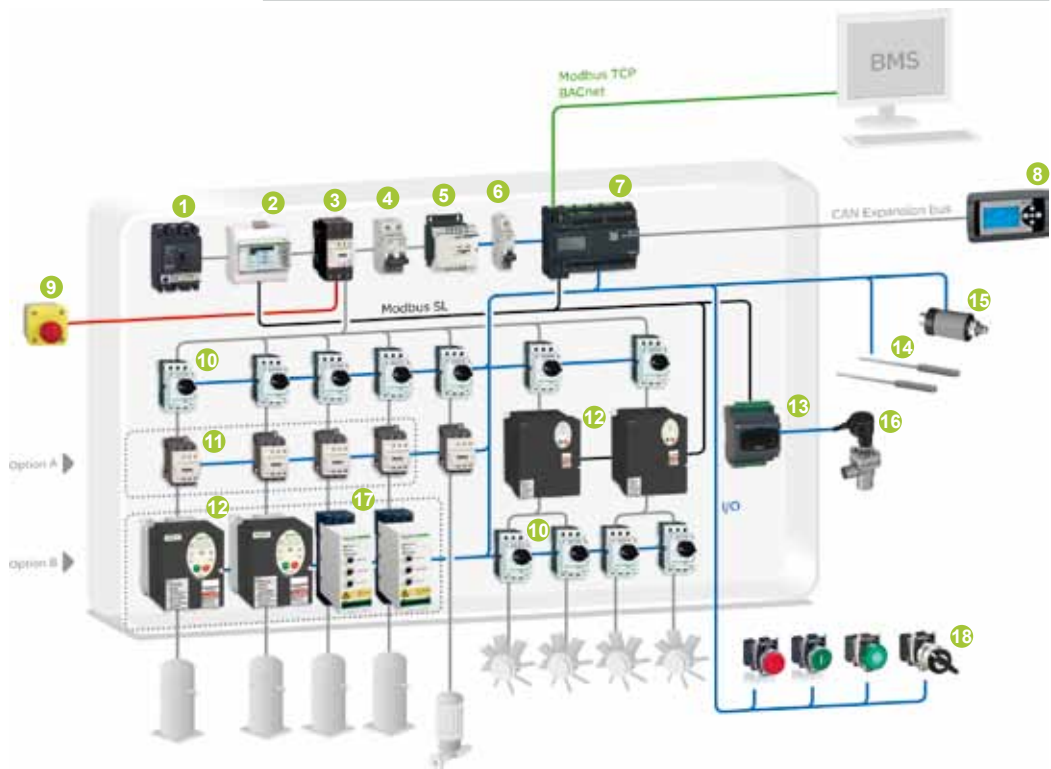

HVAC/Chiller/Modbus SL/Modicon M172 performance logic controller

Solution breakdown

- | | |
|---|---|
| <ul style="list-style-type: none"> 1 Compact NSX circuit breaker 2 iEM3000 energy meter 3 TeSys D contactor 4 C60L-MA modular circuit breaker 5 Phaseo switch mode power supply 6 C60L-DC DC circuit breaker 7 Modicon M172 performance logic controller 8 Modicon M171 remote display 9 Harmony XALK Emergency stop push button 10 TeSys GV2L magnetic circuit breaker 11 TeSys D contactor | <ul style="list-style-type: none"> 12 Altivar 212 variable speed drive, for 0.75 to 75 kW (1.0 to 100 hp) motors 13 Modicon M171 electronic expansion valve driver 14 Modicon TM1S humidity and temperature probes 15 OsiSense XMLP pressure sensors 16 Electronic expansion valve 17 Altistart 01 soft starter 18 Harmony XB4/XB5 control & signaling units |
|---|---|

3

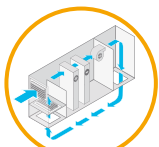

Fan management



Floating High Pressure control

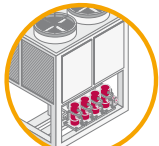

Compressor management

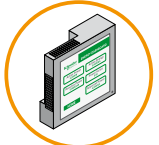

Energy management

Application Function Blocks (AFBs)

Improve efficiency



Flexible and scalable performance

Whether you focus on chillers, Air Handling Units for commercial buildings, residential, or industrial applications...

With the range of Modicon M171/M172 logic controllers, the next generation of MachineStruxure™ is now better positioned than ever. Multiple BMS (Building Management System) connectivity, embedded or in option, and an embedded web server enable ease in remote control; while a unique software environment supports the development of algorithms and functions that can be used on all platforms.



Performance and connectivity



- > Best-in-class versatility and compact size
- > Best-in-class performance

- > Modicon™ **M171 optimized logic controller** for simple and compact machines is one of the smallest programmable controllers on the market. Available also for flush mounting, it requires minimal installation time and offers tremendous versatility.
- > Modicon™ **M171 performance logic controller** for complex and BMS connectable machines can be adapted to virtually any application.
- > Modicon™ **M172 performance logic controller** for large and connected machines with more scalability and connectivity.

Increase profitability



3

Everything needed is embedded

The high degree of flexibility makes it very easy to install additional modules and still keep everything in just one configuration:

- > Remote displays
- > Expansion modules
- > Communication modules
- > Wall thermostats
- > Wide range of humidity and temperature probes



Remote displays



Expansion modules



Communication modules



Wall thermostat

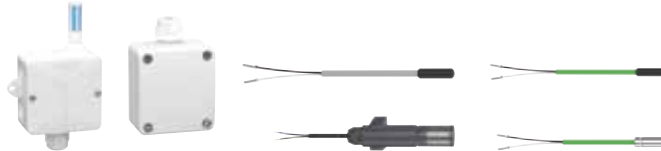

Humidity and temperature probes

Reduce time-to-market



Intuitive automation with SoMachine HVAC

SoMachine™ HVAC is the universal programming software for machines automated by Modicon M171/M172 logic controllers.

Simplified navigation that requires only a few clicks delivers a more efficient engineering process.



SoMachine HVAC simplifies every step in machine design and commissioning

Simplify integration and maintenance



Connected everywhere

Integration into machines and management systems has never been easier – many needed connectivity features are embedded in the offer:

- > Modbus RTU
- > BACnet/IP and MS/TP (B-AAC profile)
- > Modbus TCP with Webvisu embedded
- > ASCII support for GSM Modem
- > Profibus
- > CAN
- > LonWorks (FFT-10)

Customization and services

Our experts help you every step of the way, from perfecting machine design to on-site services of the finished machine.

Global support, 24/7 hotline services, and replacement parts centers around the world enable you to deliver superior customer support and satisfaction.

3



- 1 Remote LED display
- 2 Wall thermostat
- 3 M171 optimized logic controller
- 4 I/O expansion module



- 1 Remote LCD display
- 2 Communication module
- 3 M171 performance logic controller
- 4 I/O expansion module
- 5 Electronic expansion valve driver



- 1 Remote LCD display
- 2 Communication module
- 3 M172 performance logic controller
- 4 I/O expansion module
- 5 Electronic expansion valve driver

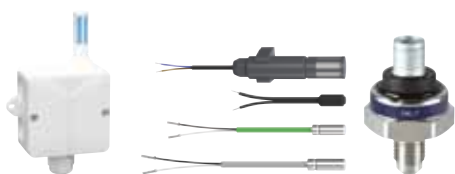

Measurement accessories

Pressure transmitters

Presentation

The Modicon M171/M172 logic controller range has been developed to manage digital and analog inputs and outputs, to offer numerous possibilities for connection to different Building Management System communication networks.

Modicon M171/M172 range

The range of Modicon M171/M172 comprises 21 logic controllers, programmable with SoMachine HVAC software, and is divided in 3 types: **M171 optimized** logic controllers, **M171 performance** logic controllers and **M172 performance** logic controllers.

■ **M171 optimized** logic controllers are suitable for customized applications designed to control simple and compacts machines:

- Air/water-cooled chiller
- Rooftop unit
- Heat pump
- Compressor rack
- Ventilation unit

■ **M171 performance** logic controllers type are suitable for customized applications designed to control complex and BMS connectable machines:

- Air/water-cooled chiller
- Rooftop unit
- Heat pump
- Precision air conditioner
- Booster station
- Compressor rack
- Heat recovery unit

■ **M172 performance** logic controllers increase the scalability and the connectivity achieved by M171 performance controllers. They control the same type of applications as the Modicon M171 performance do, and embed more universality and connectivity.

System components

The offer range comprises:

- 21 logic controllers:
 - 10 **M171 optimized** logic controllers,
 - 5 **M171 performance** logic controllers
 - 6 **M172 performance** logic controllers

The Modicon M171/M172 logic controllers are available with or without embedded display. See pages 3/12, 3/16 and 3/18.

■ 5 I/O expansion module types (mixed digital and analog):

- 2 **TM171EP●●R** for **M171** and **M172 performance** logic controllers
- 3 **TM171EO●●R** for **M171 optimized** logic controllers. See page 3/20.

■ 5 remote displays (LED or LCD technology):

- 1 **TM171DGRP** for **M171** and **M172 performance** logic controllers
- 4 **TM171D●●●●** for **M171 optimized** logic controllers. See pages 3/14, 3/17 and 3/19.

■ 8 **TM171A●●●●** communication modules (BMS fieldbus interfaces) to provide to the **M171** and **M172 performance** logic controllers a connection to:

- BACnet MS/TP (B-AAC profile) or IP
- Modbus SL (Serial Link)
- Modbus TCP
- LonWorks (FFT-10)
- Profibus
- CAN bus
- etc, see page 3/21.

■ 3 **TM171VEV●●** electronic expansion valve drivers compatible with the entire Modicon M171/M172 logic controller range and also with third party controllers and electronic expansion valves. See page 3/24

■ 23 specific measurement accessories: **TM1S●●●●** humidity and temperature probes. See page 3/26.

■ Pressure sensors from our partner Telemecanique sensors, see page 3/27.

■ Adapted connection accessories: I/O connectors and cables. See pages 3/15 and 3/21.

■ SoMachine HVAC programming software. See page 4/2.

■ Programming accessories. See page 4/3.



SoMachine HVAC programming software

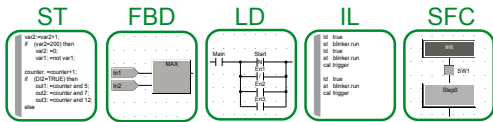

5 languages compliance IEC 61131-3

General presentation (continued)

Configuration software

Modicon M171/M172 logic controllers are supported by a completely intuitive software package SoMachine HVAC (see page 4/2).

- SoMachine HVAC uses 5 languages compliance IEC 61131-3.
- This software follows a simple drag and drop function block approach to configuration and is completed with a library of Application Function Blocks (AFBs) and logic functions.
- This software runs with 5 programming languages.
- Examples:

□ ST language



□ FBD language



□ LD language



□ IL language

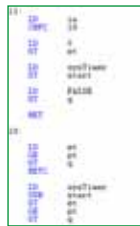

□ SFC language

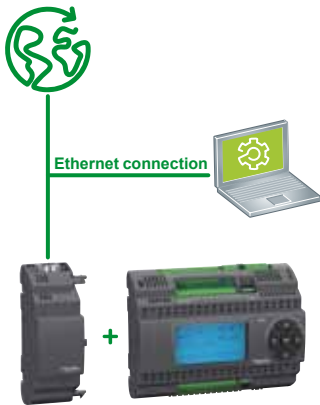

Communication module (TM171AETH or TM171AETHRS485) and M171 performance logic controller

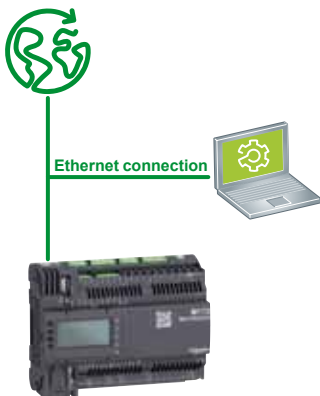

M172 performance logic controller

Available resources on logic controllers for IEC programming

	Logic controller type		
	M171 optimized	M171 performance	M172 performance
CPU	14.7 MHz	72 MHz, 32 MB RAM	120 MHz, 32 MB RAM
Available memory for application	188 kB	1.0 MB	1.0 MB
Available memory for user interface	–	1.5 MB	1.5 MB
Flash memory data	–	126 MB	5 MB
RAM memory (automatic mapping)	2048 B (1024 word)	512 kB (256000 word)	512 kB (256000 word)
RAM memory (Modbus mapping)	1024 B (512 word)	10 kB (5000 word)	10 kB (5000 word)
EEPROM variables	1024 B (512 word)	28 kB (14000 word)	28 kB (14000 word)

Ethernet connection

Ethernet access is available on **performance** logic controllers:

- Ethernet access is optional with **M171 performance** logic controllers by means of a communication module
- Ethernet access is embedded with **M172 performance** logic controllers.

Ethernet access enables several functions to **M171** and **M172 performance** logic controllers, such as:

- > Text e-mail (via NMTP server)
- > TFTP transfer protocol (for M171 performance only)
- > DNS
- > Program transfers (upload/download)
- > Online debugging
- > Firmware updates
- > Parameter management
- > File management (virtual FTP)
- > Bridge: specific function allowing PLCs to be configured via the performance logic controllers, on Modbus
- > WebVisu

General presentation (continued)

Modicon M171 optimized logic controllers for simple and compact machines

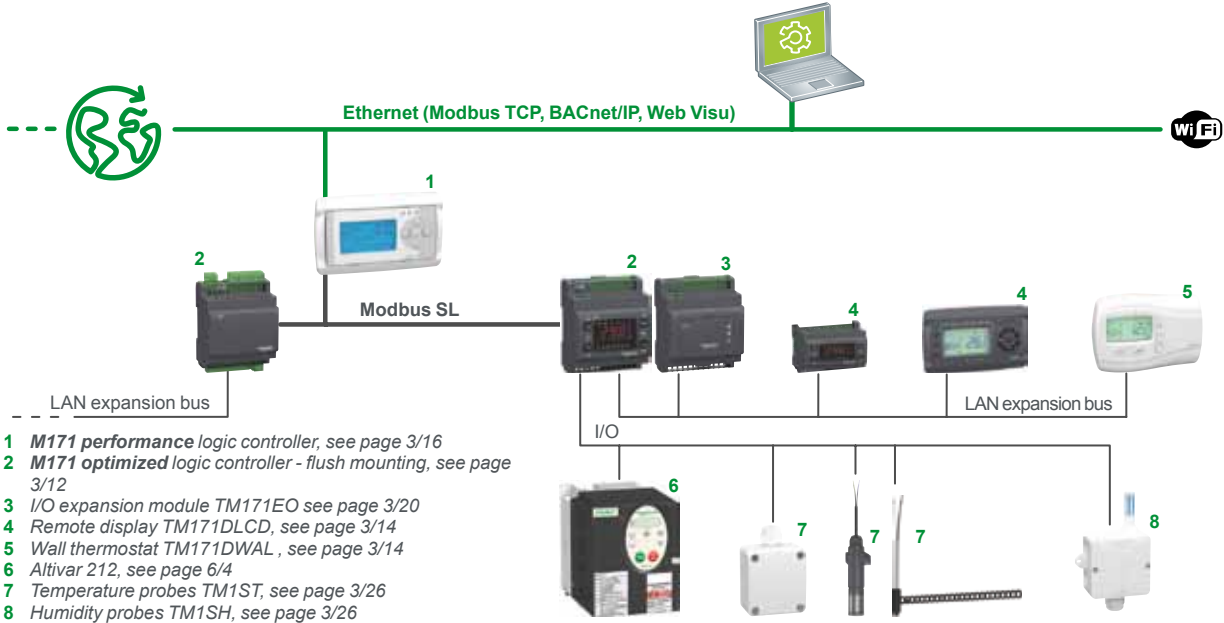

Modicon M171 performance logic controllers for complex and BMS connectable machines

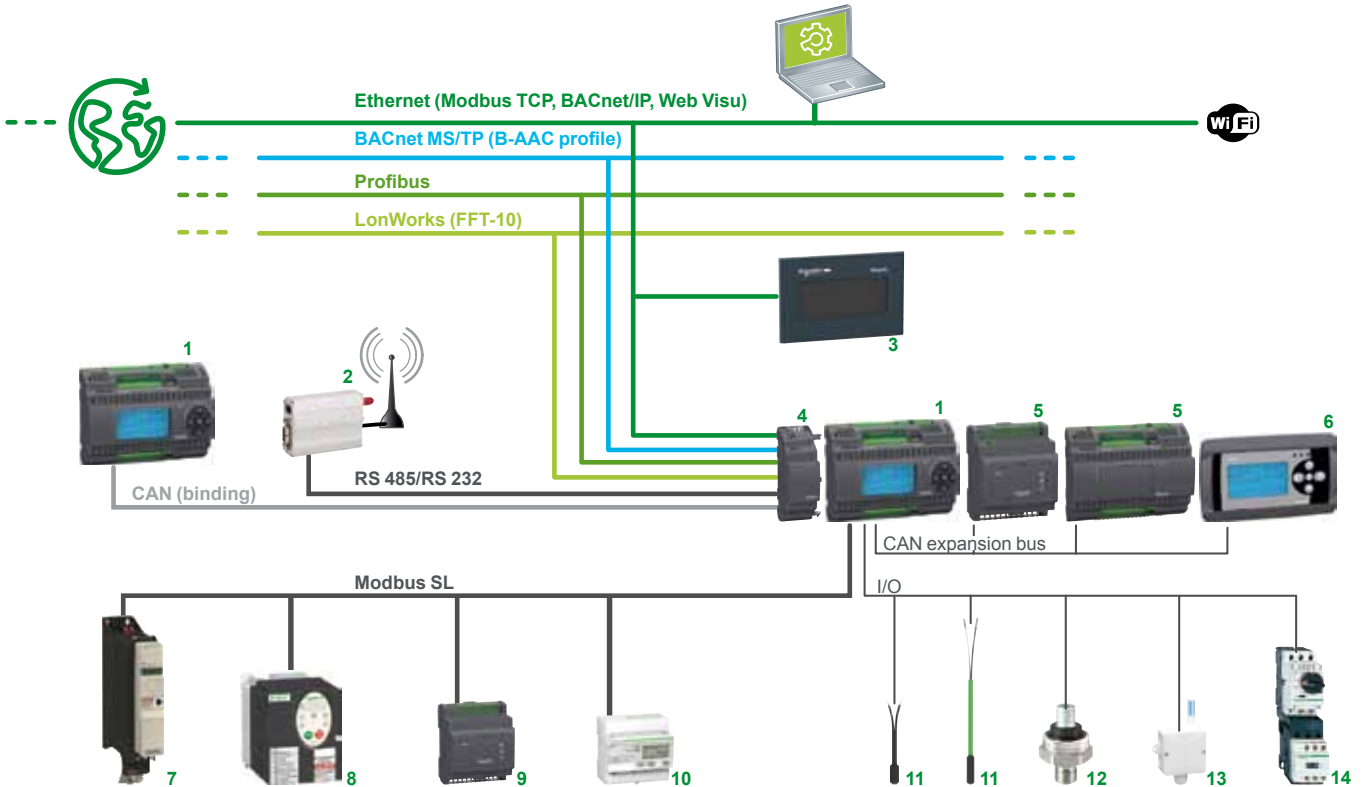

General presentation (continued)

M172 performance logic controllers for large and connected machines

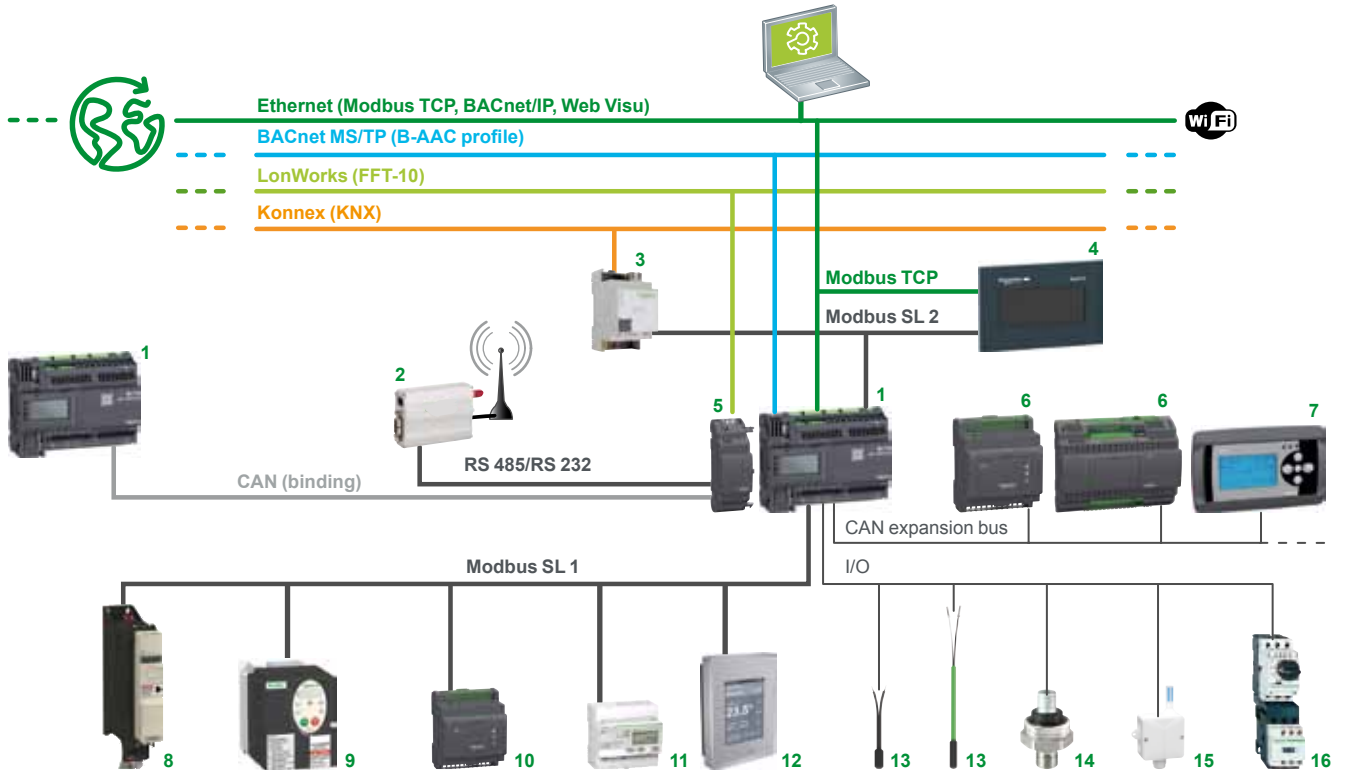

- 1 M172 performance logic controller, see page 3/18
- 2 Modem
- 3 spaceLynk gateway, see page 5/5
- 4 HMI Magelis STO/STU, see page 6/4
- 5 Communication module TM171ALON, see page 3/22
- 6 I/O expansion module TM171EP, see page 3/20
- 7 Remote display TM171DGRP, see page 3/17
- 8 Altivar 32, see page 6/4
- 9 Altivar 212, see page 6/4

- 10 Electronic expansion valve driver TM171VEV, see page 3/24
- 11 Energy meter iEm 3000, see page 6/18
- 12 Room controller SE8000, see page 6/2
- 13 Temperature probes TM1ST, see page 3/26
- 14 XMLP pressure transmitters, see page 3/27
- 15 Humidity probes TM1SH, see page 3/26
- 16 TeSys GV2 + TeSys D, see page 6/8

3

Applications

M171 optimized logic controllers for simple and compact machines

- Air/water-cooled chiller
- Rooftop unit
- Heat pump
- Compressor rack
- Ventilation unit



Programming software

SoMachine HVAC V1.0 or higher

Maximum number of I/O with expansion modules

44	28
----	----

Generic programmable inputs

Digital input	6 digital inputs	2 digital inputs
analog input	5 configurable analog inputs	5 configurable analog inputs

Generic programmable outputs

Digital output	6 digital outputs	4 digital outputs
analog output	5 analog outputs	5 analog outputs

Communication

Embedded communication port

- 1 wired connector for LAN expansion bus
- 1 wired connector for Modbus SL master/slave for TM171O●●M●●●

Optional communication

None except with a gateway

USB port

No (program can be downloaded with the TM171AMFK programming stick and TM171ADMI programming cable)

Services

Remote download through Modbus SL

Power supply

~ 12-24 V or --- 24 V for all, ~ 12-24 V for TM171O●●22S	~ 100...240 V, isolated
--	-------------------------

Display

Built-in	Yes, on TM171OD●22●	Yes	Yes, on TM171ODM14R
Remote	Yes, with TM171DLED, TM171DLCD, and TM171DWAL2● displays Or with HMI Magelis offer (see page 6/4 or our web site: www.schneider-electric.com)		

Mounting

35 mm / 1.38 in. 1/2 rail	Flush mounting	35 mm / 1.38 in. 1/2 rail
---------------------------	----------------	---------------------------

Product certifications

CE, cURus, CSA, EAC

Logic controller reference

TM171O●●22●	TM171OF22R TM171OFM22R	TM171O●M14R TM171OD14R
--------------------	---	---

Page

3/12 and 3/13

(1) On the same port at the same time.
(2) November 2015
(3) Pending

M171 performance logic controllers for complex and BMS connectable machines

- Air/water-cooled chiller
- Rooftop unit
- Heat pump
- Precision air conditioner
- Booster station
- Compressor rack
- Heat recovery unit

M172 performance logic controllers for large and connected machines



Programming software

SoMachine HVAC V1.0 or higher

Maximum number of I/O with expansion modules

351

Generic programmable inputs

9 digital inputs	327	366
6 configurable analog inputs	3 configurable analog inputs	8 or 12 analog inputs

Generic programmable outputs

7 digital outputs	12 digital outputs
5 analog outputs	4 or 6 analog outputs, 8 or 12 digital outputs

Optional communication

- 1 removable connector for CAN expansion bus
- 1 removable connector for Modbus SL master/slave

Optional communication

- 1 removable connector for CAN expansion bus
- 1 removable connector for Modbus SL master/slave or BACnet MS/TP (B-AAC profile)
- 1 RJ45 connector for Modbus TCP and BACnet IP (B-AAC profile) (WebVisu) (1)

Optional communication

- 2 removable connectors for Modbus SL master/slave (Only 1 Master) or 1 BACnet MS/TP (B-AAC profile)
- 1 RJ45 connector for Modbus TCP and BACnet IP (B-AAC profile) (Webvisu)
- 1 removable connector for CAN expansion bus

With **TM171A●●●** communication modules:

- Modbus TCP (WebVisu)
- Modbus SL
- BACnet MS/TP (B-AAC profile)
- BACnet IP (B-AAC profile) (Webvisu)
- CAN bus
- RS 232
- Profibus
- LonWorks (FFT-10)

None except with a gateway

With **TM171A●●●** communication modules:

- Modbus SL
- BACnet MS/TP (B-AAC profile)
- BACnet IP (B-AAC profile) (Webvisu)
- CAN bus
- RS 232
- LonWorks (FFT-10)

USB port

No

Yes: 1 USB-A and 1 USB-Mini-B

Services

- Remote download
- File management (virtual FTP)
- Text e-mail
- Datalogging

Power supply

~ 24 V or --- 48 V

~ 24 V

Display

Yes, on TM171PDM27● controllers

Yes, on TM172PDG●●● controllers

Yes, with TM171DGRP display
Or with HMI Magelis offer (see page 6/4 or our web site: www.schneider-electric.com)

Mounting

35 mm / 1.38 in. 1/2 rail

Flush mounting

Product certifications

CE, cURus, CSA, EAC

CE, cURus (2), CSA (3), EAC (3)

Logic controller reference

TM171PDM27● TM171PBM27R	TM171PFE03●●
--	---------------------

TM172P●G27● TM172P●G42●
--

Page

3/16 and 3/17

3/18 and 3/19

Presentation

The **M171 optimized** logic controllers comprise 10 models that can be used to control from 14 up to 22 embedded I/Os (digital and analog).

- 2 types of power supply are available:
 - ~ 100-240 V
 - ~ 12-24 V or = 24 V
- 2 types of housing:
 - with built-in display
 - with remote display that can be added through the LAN expansion bus.
- 2 types of mounting:
 - Flush mounting: controllers to be mounted on a cabinet door
 - 35 mm/1.38 in. rail mounting: controllers to be mounted inside a cabinet
- Optimized logic controllers embed up to 2 communication ports (depending on the model):
 - 1 optional Modbus SL bus
 - 1 LAN expansion bus
- The **M171 optimized logic controllers** are certified CE, cURus, CSA, EAC.

Description

35 mm/1.38 in. rail mounting optimized controllers

TM171O●14R optimized logic controllers (1)

- 1 Display
- 2 4 navigation keys for setting controller parameters
- 3 Programming port (TTL)
- 4 Removable terminal block for RS 485 serial port (TM171O●M14R)
- 5 Wired connector for LAN expansion bus
- 6 Mounting clip for 35 mm/1.38 in. rail mounting
- 7 Removable terminal block for digital outputs
- 8 Removable terminal block for ~ 100...240 V power supply
- 9 Removable terminal block for I/Os

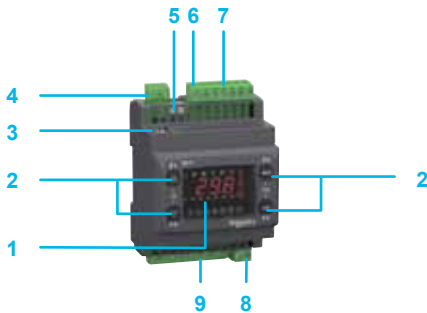

TM171O●22R● optimized logic controllers (1)

- 1 Display
- 2 4 navigation keys for setting controller parameters
- 3 Programming port (TTL)
- 4 Wired connector for RS 485 serial port (TM171O●M14R)
- 5 Mounting clip for 35 mm/1.38 in. rail mounting
- 6 Removable terminal block for outputs
- 7 Wired connector for ~ 12-24 V or = 24 V power supply, and for low voltage I/Os
- 8 Wired connector for analog output
- 9 Wired connector for LAN expansion bus

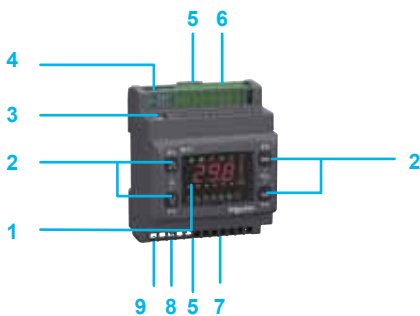

Flush mounting controllers

TM171OF●22R● optimized logic controllers (1)

- 1 Display
- 2 4 navigation keys for setting controller parameters
- 3 Wired connector for RS 485 serial port (TM171OF●M22R)
- 4 Wired connector for analog outputs
- 5 Wired connector for LAN expansion bus
- 6 Programming port (TTL)



(1) Connectors to be ordered separately, see page 3/15.



TM171OBM14R



TM171OD14R



TM171ODM14R



TM171OB22R



TM171OBM22R



TM171OD22R



TM171ODM22R



TM171ODM22S



TM171OF22R



TM171OFM22R

M171 optimized logic controllers

Power supply: ~ 100-240 V

35 mm/1.38 in. rail mounting optimized controllers

No. of I/Os	Number and type of channels	Display	Embedded communication	Reference	Weight kg/lb
14	2 digital inputs: 2 open collector or digital inputs (1)	Remote display (optional)	<input type="checkbox"/> 1 wired connector for Modbus SL (master/slave) <input type="checkbox"/> 1 wired connector for LAN expansion bus	TM171OBM14R	0.190/ 0.420
	4 digital outputs: <input type="checkbox"/> 3 SPST (2 A, ~ 230 V) with the same common <input type="checkbox"/> 1 SPDT (2 A, ~ 230 V)				
	5 configurable analog inputs: <input type="checkbox"/> 2 NTC, PT1000, or digital inputs <input type="checkbox"/> 2 NTC, 0-20 mA, 4-20 mA, 0-10 V, 0-5 V, 0-1 V, or digital inputs <input type="checkbox"/> 1 NTC, PT1000, 0-20 mA, 4-20 mA, 0-10 V, 0-5 V, 0-1 V, or digital inputs	Built-in display	<input type="checkbox"/> 1 wired connector for LAN expansion bus <input type="checkbox"/> 1 wired connector for Modbus SL (master/slave) <input type="checkbox"/> 1 wired connector for LAN expansion bus	TM171OD14R	0.190/ 0.420
	5 analog outputs: <input type="checkbox"/> 2 open collector (1) for 12 V PWM/PPM or digital inputs <input type="checkbox"/> 2x 0-10 V <input type="checkbox"/> 1x 4-20 mA				

Power supply: ~ 12-24 V or ~ 24 V (2)

35 mm/1.38 in. rail mounting optimized controllers

22	6 digital inputs: <input type="checkbox"/> 6 volt-free in 1 group	Remote display (optional)	<input type="checkbox"/> 1 wired connector for LAN expansion bus <input type="checkbox"/> 1 wired connector for Modbus SL (master/slave) <input type="checkbox"/> 1 wired connector for LAN expansion bus	TM171OB22R	0.190/ 0.420
	5 configurable analog inputs: <input type="checkbox"/> 3 NTC or digital inputs <input type="checkbox"/> 2 NTC, 0-20 mA, 4-20 mA, 0-10 V, 0-5 V, 0-1 V, or digital inputs				
	6 digital outputs: <input type="checkbox"/> 3 SPST (2 A, ~ 230 V) with the same common <input type="checkbox"/> 2 SPST (2 A, ~ 230 V) with independent common <input type="checkbox"/> 1 open collector	Built-in display	<input type="checkbox"/> 1 wired connector for LAN expansion bus <input type="checkbox"/> 1 wired connector for Modbus SL (master/slave) <input type="checkbox"/> 1 wired connector for LAN expansion bus	TM171OBM22R	0.190/ 0.420
	5 analog outputs: <input type="checkbox"/> 2 open collector for 12 V PWM/PPM <input type="checkbox"/> 3x 0-10 V				
		Built-in display	<input type="checkbox"/> 1 wired connector for Modbus SL (master/slave) <input type="checkbox"/> 1 wired connector for LAN expansion bus	TM171OD22R	0.190/ 0.420
		Built-in display	<input type="checkbox"/> 1 wired connector for Modbus SL (master/slave) <input type="checkbox"/> 1 wired connector for LAN expansion bus	TM171ODM22R	0.190/ 0.420

Flush mounting optimized controllers

22	6 digital inputs: <input type="checkbox"/> 6 volt-free in 1 group	Built-in display	1 wired connector for LAN expansion bus	TM171OF22R	0.164/ 0.360
	5 configurable analog inputs: <input type="checkbox"/> 3 NTC or digital input <input type="checkbox"/> 2 NTC, 0-20 mA, 4-20 mA, 0-10 V, 0-5 V, 0-1 V, or digital inputs				
	6 digital outputs: <input type="checkbox"/> 3 SPST (2 A, ~ 230 V) with the same common <input type="checkbox"/> 2 SPST (2 A, ~ 230 V) with independent common <input type="checkbox"/> 1 open collector		1 wired connector for Modbus SL (master/slave) 1 wired connector for LAN expansion bus	TM171OFM22R	0.164/ 0.360
	5 analog outputs: <input type="checkbox"/> 2 open collector for 12 V PWM/PPM <input type="checkbox"/> 3x 0-10 V				

Remote display for M171 optimized logic controllers

Remote displays see page 3/15

Wall thermostats see page 3/15

Connection accessories for M171 optimized logic controllers

See page 3/15

(1) The 2 I/Os are the same. On the same channel: 2 digital inputs or 2 analog outputs (depending on the configuration).

(2) Except for for TM171ODM22S: ~ 12-24 V

3

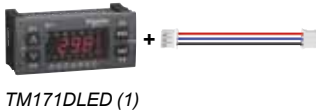

TM171DLED (1)



TM171DLCD2U



TM171DWAL2U

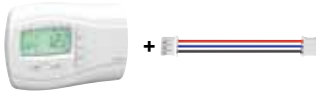

TM171DWAL2L

Remote display for M171 optimized logic controllers

The two available remote displays for the M171 optimized logic controllers offer, are distinguished by technology and mounting.

- Technology: LED display or LCD display
- Mounting: flush mounting – can be mounted on a cabinet door

The remote displays are connected to the LAN expansion bus which provides the power supply.

Reference

Type	Description	Reference	Weight kg/lb
Remote displays With realtime clock	<ul style="list-style-type: none"> ■ LED display: 4 digits, 7 segments ■ Keyboard: 4 buttons ■ Flush mounting ■ Communication port: 1 for LAN expansion bus – with wired connector (1) or screw terminal blocks 	TM171DLED	0.042/ 0.090
	<ul style="list-style-type: none"> ■ LCD display (with segments) ■ Keyboard: 7 buttons ■ Flush mounting ■ Communication port: 1 for LAN expansion bus – with screw terminal blocks ■ 2 analog inputs <ul style="list-style-type: none"> <input type="checkbox"/> 1 NTC or digital input <input type="checkbox"/> 1 NTC or 4-20 mA or digital input 	TM171DLCD2U	0.170/ 0.370

Wall thermostats for M171 optimized logic controllers

The two types of electronic wall thermostats available for the M171 optimized logic controllers offer are delivered with or without backlight.

The wall thermostats have a realtime clock.

Reference

Type	Description	Reference	Weight kg/lb
Wall thermostats	Without backlight	TM171DWAL2U	0.143/ 0.320
	With backlight	TM171DWAL2L	0.143/ 0.320

(1) Supplied with LAN expansion bus connector TM171ACB40LAN

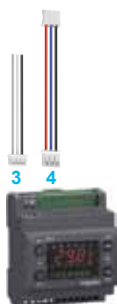

Connection accessories (1) for M171 optimized logic controller (rail mounting):
TM171OB22R, TM171OBM22R,
TM171OD22R, TM171ODM22R, and
TM171ODM22S

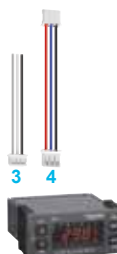
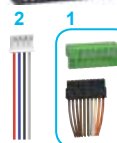

Connection accessories (1) for M171 optimized logic controller (flush mounting):
TM171OF22R, and TM171OFM22R

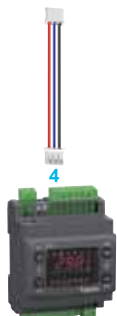
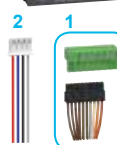

Connection accessories (1) for M171 optimized logic controller (rail mounting):
TM171OBM14R, TM171OD14R,
TM171ODM14R
Nota: terminal blocks are supplied with
TM171OBM14R, TM171OD14R, and
TM171ODM14R

Connection accessories for M171 optimized logic controllers

To be ordered separately

Type	Item	Description	Cable length (m/ft.)	Unit reference	Weight kg/lb
Low voltage connector Sold in lots of 5	1	Screw terminal block and a cordset equipped with a 20-pin connector on one end	1/3.3	TM171ACB4OI1M	0.575/ 1.270
			2/6.6	TM171ACB4OI2M	1.120/ 2.470
analog output connector (0-10 V outputs) Sold in lots of 5	2	Cordset equipped with a 4-pin connector on one end	1/3.3	TM171ACB4OAO1M	0.075/ 0.170
			2/6.6	TM171ACB4OAO2M	0.125/ 0.280
Modbus SL connector Sold in lots of 5	3	Cordset equipped with a 3-pin connector on one end	1/3.3	TM171ACB4ORS485	0.052/ 0.110
LAN expansion bus connector Sold in lots of 5	4	Cordset equipped with a 3-pin connector at each end	2/6.6	TM171ACB4OLAN	0.060/ 0.130

(1) Minimum set for operating controllers.

Presentation

The **M171 performance** logic controllers comprise 5 models that can be used to control from 3 up to 27 embedded I/Os (digital and analog).

- Power supply: \approx 24 V or \approx 48 V
- 2 types of housing:
 - with built-in display
 - without display

Each controller includes a connection (through the CAN expansion bus or through Modbus) for a remote display, available in the catalog.

- 2 types of mounting:
 - 35 mm/1.38 in. \perp rail mounting: controllers to be mounted inside a cabinet
 - Flush mounting: controllers to be mounted on a cabinet door or wall-mounted using the wall support accessory, see page 3/17.

- **M171 performance** logic controllers embed up to 3 communication ports:

- On 35 mm/1.38 in. \perp rail mounting version:
 - 1 Modbus SL master/slave
 - 2 USB
 - 1 CAN expansion bus
- On flush-mounting version:
 - 1 Modbus SL master/slave
 - 1 Modbus TCP and BACnet IP (B-AAC profile) (WebVisu)
 - 1 CAN expansion bus

- **M171 performance** logic controllers are certified CE, cURus, CSA, EAC

Description

35 mm/1.38 in. \perp rail mounting performance controllers

TM171P●M27● performance logic controllers (1)

- 1 Connector for removable terminal block for digital inputs
- 2 Connector for removable terminal block for analog inputs
- 3 Connector for removable terminal block for Modbus SL
- 4 Connector for removable terminal block for CAN expansion bus
- 5 4-position DIP switches for address selection
- 6 5 command keys for setting controller parameters
- 7 Connector for removable terminal block for power supply (\approx 24 V, \approx 48 V)
- 8 Connector for removable terminal block for fast digital input (high speed counter)
- 9 Connector for removable terminal block for digital outputs
- 10 Connector for removable terminal block for analog outputs
- 11 Mounting clips for 35 mm/1.38 in. \perp rail mounting
- 12 On TM171PDM27●: display
On TM171PBM27R: 6- and 10-position DIP switches, behind a front panel

Behind the removable protective cover: 13 and 14

- 13 USB mini-B port to link a PC
- 14 USB-A port for USB stick
- 15 Connector for communication modules
- 16 3 status LEDs

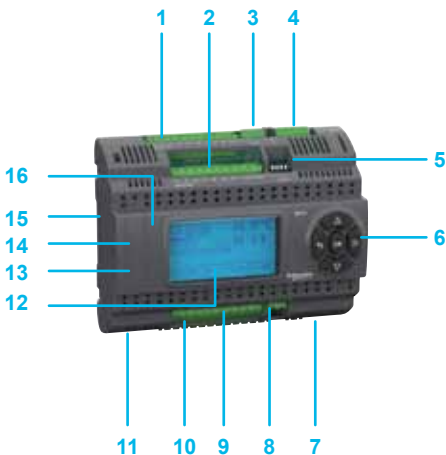

Flush mounting performance controllers

TM171PFE03R●●● performance logic controllers (2)

- 1 Display
- 2 3 status LEDs
- 3 5 command keys for setting controller parameters

On the rear side of the controller

- 4 Terminal block for power supply (\approx 24 V or \approx 48 V)
- 5 Terminal block for CAN expansion bus
- 6 Terminal block for Modbus SL
- 7 Terminal block for analog input
- 8 RJ45 connector for Ethernet
- 9 Built-in NTC sensor (analog)
- 10 Built-in humidity sensor (analog) (on TM171PFE03HR)

(1) TM171ASCTB27 removable terminal blocks to be ordered separately (see page 3/17).
(2) Terminal blocks supplied with flush-mounting version of performance controllers.

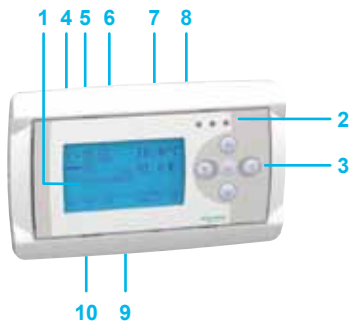

Hardware control platform

Modicon M171/M172 logic controllers

M171 performance logic controllers



TM171PBM27R



TM171PDM27R



TM171PDM27S



TM171PFE03



TM171PFE03HR



TM171ABKPB



TM171ABKPG



TM171ASCTB27



TM171DGRP

M171 performance logic controllers

Power supply: \sim 24 V, \dots 48 V

35 mm/1.38 in. rail mounting performance controllers

No. of I/Os	Number and type of channels	Display	Embedded communication port	Reference	Weight kg/lb	
	Inputs	Outputs				
27	9 digital inputs (8 + 1): □ 2 groups of 4 digital inputs, \sim 24 V or \dots 48 V □ 1 fast digital input or high speed counter, volt-free 6 configurable analog inputs: □ 2 NTC or digital input □ 4 NTC, PT1000, 4-20 mA, 0-5 V, 0-10 V, 0-30 k Ω /0-5 k Ω variable resistor, or digital inputs	7 digital outputs: □ 2 SPDT (8 A, \sim 230 V) with independent common □ 5 SPST (5 A, \sim 230 V) with independent common 5 analog outputs: □ 3x 0...+10 V or 4-20 mA □ 2x 0...+10 V, or 4-20 mA, or digital output open collector	Remote display (optional) Built-in display 128 x 64 LCD with backlight	□ 1 removable connector for Modbus SL (master/slave) □ 1 removable connector for CAN expansion bus □ 1 removable connector for Modbus SL (master/slave) □ 1 removable connector for CAN expansion bus	TM171PBM27R TM171PDM27R TM171PDM27S	0.385/ 0.850 0.385/ 0.850 0.385/ 0.850
		7 digital outputs: □ 2 SPDT (8 A, \sim 230 V) with independent common □ 3 SPST (5 A, \sim 230 V) with independent common □ 2 SSR (1 A, \sim 230 V) outputs 5 analog outputs: □ 3x 0...+10 V or 4-20 mA □ 2x 0...+10 V, or 4-20 mA, or digital output open collector	Built-in display	□ 1 removable connector for Modbus SL (master/slave) □ 1 removable connector for CAN expansion bus	0.385/ 0.850	

Flush mounting performance controllers (to be used with the wall support accessory – see below)

No. of I/Os	Number and type of channels	Display	Embedded communication port	Reference	Weight kg/lb
	Inputs	Outputs			
3	3 configurable analog inputs: □ 1 built-in NTC □ 1 NTC or digital input □ 1x 4-20 mA or 0-10 V	–	Built-in display	□ 1 removable connector for Modbus SL (master/slave) or BACnet MS/TP (B-AAC profile) □ 1 removable connector for CAN expansion bus □ 1 RJ45 for Modbus TCP and BACnet/IP	TM171PFE03 0.320/ 0.710
	3 configurable analog inputs: □ 1 built-in NTC □ 1 NTC or digital input □ 1 built-in humidity sensor	–	Built-in display	□ 1 removable connector for Modbus SL (master/slave) □ 1 removable connector for CAN expansion bus □ 1 RJ45 for Modbus TCP and BACnet IP (B-AAC profile) and MS/TP (B-AAC profile)	TM171PFE03HR 0.350/ 0.770

Accessories for M171 performance logic controllers

To be ordered separately

Designation	Use	Reference	Weight kg/lb	
Screw terminal blocks	For TM171PBM27R, TM171PDM27R, and TM171PDM27S	TM171ASCTB27	0.100/ 0.220	
Designation	Use	Description	Reference	Weight kg/lb
Wall support for flush mounting performance logic controllers	For TM171PFE03 and TM171PFE03HR	White	TM171ABKPB	0.015/ 0.030
		Grey	TM171ABKPG	0.015/ 0.030

Remote display, HMI

Type	Description	Reference	Weight kg/lb
Remote display	128 x 64 LCD, with backlight Use for M171 and M172 performance logic controllers	TM171DGRP	0.197/ 0.430
HMI Magelis STU/STO	See page 6/14		

Presentation

The **M172 performance** logic controllers comprise 6 models that can be used to control from 28 up to 42 embedded I/Os (digital and analog).

- Power supply: $\approx 24\text{ V}$
- 2 types of housing:
 - with built-in display
 - without display

Each performance controller type TM172P includes a connection (through the CAN expansion bus or through Modbus) for a remote display, available in the catalog.

- 2 types of mounting:
 - 35 mm/1.38 in. \perp rail mounting: controllers to be mounted inside a cabinet
 - on panel with an accessory: each M172 performance controller can be mounted on a panel with the **TM172AP12PM** fixing accessory.

- **M172 performance** logic controllers embed up to 4 communication ports:
 - 2 for Modbus SL (master/slave) (only 1 master) or 1 for BACnet MS/TP (B-AAC profile)
 - 1 for Modbus TCP and BACnet IP (B-AAC profile) (RJ45)
 - 1 for CAN expansion bus,
 - plus a communication module connector.

- The **M172 performance** logic controllers are certified CE, cURus (1), CSA (2), EAC (2).

Micro SD card

A slot for a micro SD memory card is available on the front face of each Modicon M172 performance controllers.

The micro SD card is used for:

- Data-logging
- Webserver storage

Description

M172 performance controllers logic controllers (3)

- 1 RJ45 connector for Modbus TCP and BACnet IP (B-AAC profile)
- 2 Connector for removable terminal block for digital outputs
- 3 Connector for removable terminal block for power supply ($\approx 24\text{ V}$)
- 4 Connector for removable terminal block for analog inputs
- 5 Connector for removable terminal block for digital inputs
- 6 Connector for removable terminal block for fast digital input (high speed counter)
- 7 Connector for removable terminal block for analog outputs
- 8 Connector for removable terminal block for RS485-1 (Modbus SL or BACnet MS/TP)
- 9 Connector for removable terminal block for RS485-2 (Modbus SL or BACnet MS/TP)
- 10 Connector for removable terminal block for CAN expansion bus
- 11 Slot for micro SD card
- 12 Slot for battery (behind the front flap)
- 13 On TM172PDG●●●: Built-in display, 4 status LEDs and 5 command keys for setting controller parameters
On TM172PBG●●●: 4 status LEDs and 5 command keys for setting controller parameters, behind a front panel
- 14 Connector for communication modules
- 15 USB mini-B port to link a PC
- 16 USB-A port for USB stick
- 17 Mounting clips for 35 mm/1.38 in. \perp rail mounting
- 18 2 Slots for the **TM172AP12PM** fixing accessory

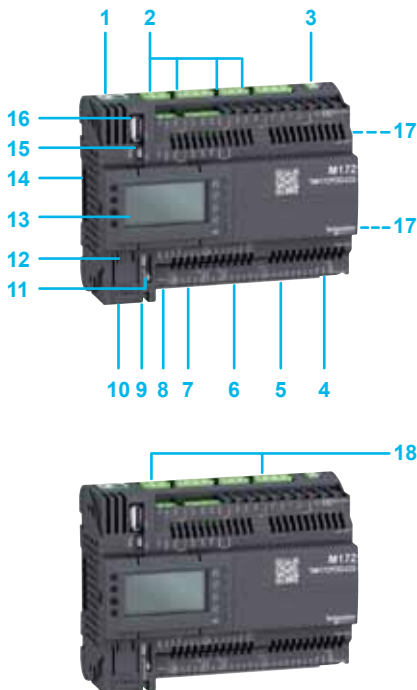

(1) November 2015

(2) Pending

(3) TM172ASCTB28 and TM172ASCTB42 removable terminal blocks to be ordered separately (see page 3/19).

Hardware control platform

Modicon M171/M172 logic controllers

M172 performance logic controllers

M172 performance logic controllers

Power supply: \approx 24 V

35 mm/1.38 in. rail mounting performance controllers, and Panel mounting with accessory

No. of I/Os	Number and type of channels	Display	Embedded communication port	Reference	Weight kg/lb	
	Inputs (1)	Outputs				
28	8 digital inputs: <input type="checkbox"/> 6 \sim or --- 24 V <input type="checkbox"/> 2 high speed counters, dry contact 8 analog inputs, configurable by pair: 8 NTC, or PT1000 (-200 °C to +850 °C / -328 to +1562 °F), or PTC, or 0-20 mA, or 4-20 mA, or 0-5 V, or 0-10 V, or digital input	8 digital outputs: <input type="checkbox"/> 1 SPDT Relay 1 A <input type="checkbox"/> 3 SPST with the same common <input type="checkbox"/> 2 SPST with the same common <input type="checkbox"/> 2 SPST with independent common <input type="checkbox"/> Optional 2 SSR with independent common for TM172PDG28S only 4 analog outputs: <input type="checkbox"/> 2x 0-10 V, or 4-20 mA, or PWM (2 kHz, --- 24 V) <input type="checkbox"/> 2x 0-10 V	Remote display (optional)	<input type="checkbox"/> 2 removable connectors for Modbus SL (master/slave) (only 1 master), or 1 for BACnet MS/TP (B-AAC profile) <input type="checkbox"/> 1 RJ45 connector for Modbus TCP and BACnet IP (B-AAC profile) (RJ45) <input type="checkbox"/> 1 removable connector for CAN expansion bus	TM172PBG28R	0.300/ 0.661
			Built-in display 128 x 64 LCD with backlight			
42	12 digital inputs: <input type="checkbox"/> 10 \sim or --- 24 V <input type="checkbox"/> 2 high speed counter, dry contact 12 analog inputs, configurable by pair: 12 NTC, or PT1000 (-200 °C to 850 °C / -328 to +1562 °F), or PTC, or 0-20 mA, or 4-20 mA, or 0-5 V, or 0-10 V, or digital input	12 digital outputs: <input type="checkbox"/> 2 SPDT relay 1 A <input type="checkbox"/> 3 SPST with the same common <input type="checkbox"/> 3 SPST with the same common <input type="checkbox"/> 2 SPST with the same common <input type="checkbox"/> 2 SPST with independent common <input type="checkbox"/> Optional 2 SSR with independent common for TM172PDG42S only 6 analog outputs: <input type="checkbox"/> 2x 0-10 V, or 4-20 mA, or PWM (2 kHz, --- 24 V) <input type="checkbox"/> 4x 0-10 V	Remote display (optional)	<input type="checkbox"/> 2 removable connectors for Modbus SL master/slave (only 1 Master), or 1 for BACnet MS/TP (B-AAC profile) <input type="checkbox"/> 1 RJ45 connector for Modbus TCP and BACnet IP (B-AAC profile) (RJ45) <input type="checkbox"/> 1 removable connector for CAN expansion bus	TM172PBG42R	0.385/ 0.849
			Built-in display 128 x 64 LCD with backlight			
				<input type="checkbox"/> 1 RJ45 connector for Modbus TCP and BACnet IP (B-AAC profile) (RJ45) <input type="checkbox"/> 1 removable connector for CAN expansion bus	TM172PDG28S	0.300/ 0.661
					TM172PDG42S	0.385/ 0.849



TM172PBG28R



TM172PDG28R

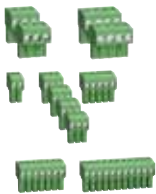

TM172ASCTB28



TM172ASCTB42



TM172AP12PM



TM171DGRP

Accessories for M172 performance logic controllers

To be ordered separately

Designation	Use	Reference	Weight kg/lb
Screw terminal blocks	For TM172P●●●28● performance logic controllers	TM172ASCTB28	0.100/ 0.220
	For TM172P●●●42● performance logic controllers	TM172ASCTB42	0.150/ 0.331
Fixing accessory: 12 clips-on lock for panel mounting	For mounting M172 performance logic controllers on panel	TM172AP12PM	0.050/ 0.110

Remote display, HMI

Type	Use	Description	Reference	Weight kg/lb
Remote display	For M172 performance logic controllers	128 x 64 LCD, with backlight	TM171DGRP	0.197/ 0.430
HMI Magelis STU/STO	See page 6/14			

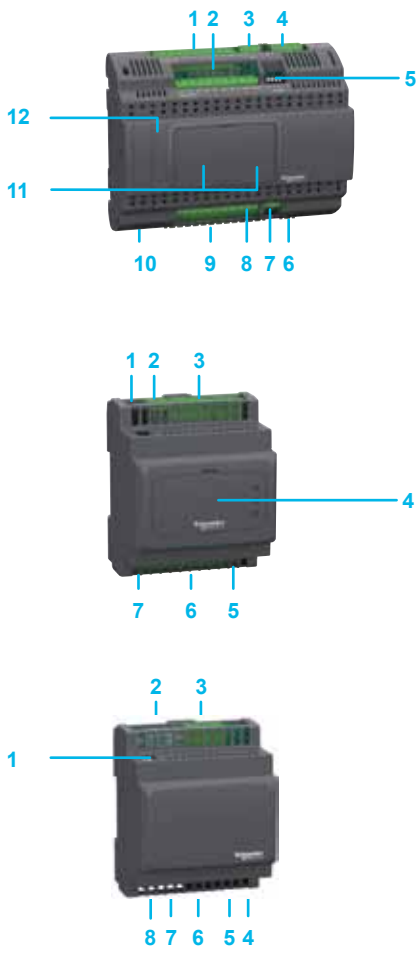

Presentation

5 I/O expansion modules are available, 2 of which are dedicated to **M171** and **M172 performance** logic controllers, and 3 of which are for **M171 optimized** logic controllers (see compatibility table below).

- They are used to increase the number of I/Os:
 - up to 44 on **M171 optimized** logic controllers
 - up to 351 on **M171 performance** logic controllers
 - up to 366 on **M172 performance** logic controllers
- Expanded I/O types are digital and analog I/Os
- They are connected:
 - Via the LAN expansion bus on **M171 optimized** logic controllers
 - Via the CAN expansion bus on **M171** and **M172 performance** logic controllers

Compatibility between logic controllers and I/O expansion modules

Logic controller type	Reference	Compatible I/O expansion module (reference)
M171 optimized	TM171OBM14R	TM171EO14R
	TM171OD14R	
	TM171ODM14R	
	TM171OB22R	TM171EO15R TM171EO22R
	TM171OBM22R	
	TM171OD22R	
	TM171ODM22R	
TM171ODM22S		
TM171OF22R		
TM171OFM22R		
M171 performance	TM171PBM27R	TM171EP14R TM171EP27R
	TM171PDM27R	
	TM171PDM27S	
	TM171PFE03	
	TM171PFE03HR	
M172 performance	TM172PBG28R	
	TM172PDG28R	
	TM172PDG28S	
	TM172PBG42R	
	TM172PDG42R	
	TM172PDG42S	

Description

35 mm/1.38 in. \perp rail mounting I/O expansion modules

TM171EP27R expansion module (1)

- 1 Connector for removable terminal block for digital inputs
- 2 Connector for removable terminal block for analog inputs
- 3 Connector for removable terminal block for Modbus SL
- 4 Connector for removable terminal block for CAN expansion bus
- 5 4-position DIP switches for address selection
- 6 Connector for removable terminal block for power supply (\sim 24 V, \equiv 48 V)
- 7 Connector for removable terminal block for fast digital input
- 8 Connector for removable terminal block for digital outputs
- 9 Connector for removable terminal block for analog outputs
- 10 Clip for 35 mm/1.38 in. \perp rail mounting
- 11 6- and 10-position DIP switches for address selection
- 12 3 status LEDs

TM171EP14R expansion module (1)

- 1 4-position DIP switches
- 2 Connector for removable terminal block for CAN expansion bus
- 3 Removable terminal block for digital outputs
- 4 **Behind the removable protective cover:** Service port (TTL)
- 5 Connector for low voltage I/Os
- 6 Clip for 35 mm/1.38 in. \perp rail mounting
- 7 Connector for removable terminal block for power supply (\sim 24 V)

TM171EO●●R expansion modules (1)

- 1 Service port (TTL)
- 2 Wired connector for removable terminal block for Modbus SL
- 3 Connector for removable terminal block for digital outputs
- 4 Wired connector for removable terminal block for power supply (\sim 12-24 V or \equiv 24 V),
- 5 Wired connector for low voltage I/Os
- 6 Clip for 35 mm/1.38 in. \perp rail mounting
- 7 Wired connector for removable terminal block for analog outputs
- 8 Wired connector for removable terminal block for LAN expansion bus

(1) Removable terminal blocks to be ordered separately, except for TM171EO14R, see page 3/21.

Hardware control platform

Modicon M171/M172 logic controllers

I/O expansion modules

I/O expansion modules for Modicon M171 and M172 performance logic controllers

35 mm/1.38 in. rail mounting expansion modules

No. of I/Os	Number and type of channels	Outputs	Compatibility with logic controller	Embedded communication connection	Reference	Weight kg/lb
14	4 digital inputs: ~ 24 V or $\bar{\text{---}}$ 24 V 4 analog inputs: (configurable by pair) NTC, PT1000, PTC, 4-20 mA, 0-5 V, 0-10 V, or digital inputs	4 digital outputs: <input type="checkbox"/> 1 SPDT (5 A, ~ 230 V) with independent common <input type="checkbox"/> 3 SPST (3 A, ~ 230 V) with independent common 2 analog outputs: 0-10 V	TM171P●●●● TM172P●●●●	<input type="checkbox"/> 1 removable connector for CAN expansion bus	TM171EP14R	0.190/ 0.420
27	9 digital inputs (8 + 1): <input type="checkbox"/> 2 groups of 4 digital inputs, ~ 24 V or $\bar{\text{---}}$ 48 V <input type="checkbox"/> 1 fast digital input or high speed counter, volt-free 6 analog inputs: <input type="checkbox"/> 2 NTC or digital inputs <input type="checkbox"/> 4 NTC, 4-20 mA, 0-10 V, or digital inputs	7 digital outputs: <input type="checkbox"/> 2 SPDT (8 A, ~ 230 V) with independent common <input type="checkbox"/> 5 SPST (5 A, ~ 230 V) with independent common 5 analog outputs: <input type="checkbox"/> 0-10 V, or 4-20 mA	TM171P●●●● TM172P●●●●	<input type="checkbox"/> 1 removable connector for CAN expansion bus	TM171EP27R	0.385/ 0.850



TM171EP14R



TM171EP27R



TM171EO14R



TM171EO15R



TM171EO22R

I/O expansion modules for Modicon M171 optimized logic controllers

35 mm/1.38 in. rail mounting expansion modules

14	2 digital inputs: 2 open collector or digital inputs (1) 5 configurable analog inputs: <input type="checkbox"/> 2 NTC, PT1000 or digital inputs <input type="checkbox"/> 2 NTC, 0-20 mA, 4-20 mA, 0-10 V, 0-5 V, 0-1 V, or digital inputs <input type="checkbox"/> 1 NTC, PT1000, 0-20 mA, 4-20 mA, 0-10 V, 0-5 V, 0-1 V, or digital inputs	4 digital outputs: <input type="checkbox"/> 3 SPST (2 A, ~ 230 V) with the same common <input type="checkbox"/> 1 SPDT (2 A, ~ 230 V) 5 analog outputs: <input type="checkbox"/> 2 open collector for 12 V PWM/PPM or digital inputs (1) <input type="checkbox"/> 2x 0-10 V <input type="checkbox"/> 1x 4-20 mA	TM171OBM14R TM171OD14R TM171ODM14R	<input type="checkbox"/> 1 wired connector for LAN expansion bus	TM171EO14R	0.190/ 0.420
15	6 digital inputs: volt-free 3 analog inputs: NTC or digital inputs	4 digital outputs: <input type="checkbox"/> 3x 2 A, ~ 250 V <input type="checkbox"/> 1 open collector 2 analog outputs: open collector (PPM/PWM)	TM171OB22R TM171OBM22R TM171OD22R TM171ODM22R TM171ODM22S TM171OF22R TM171OFM22R	<input type="checkbox"/> 1 wired connector for LAN expansion bus	TM171EO15R	0.190/ 0.420
22	6 digital inputs: volt-free 5 analog inputs: <input type="checkbox"/> 3 NTC or digital inputs <input type="checkbox"/> 2 NTC, 0-20 mA, 4-20 mA, 0-10 V, or digital inputs	6 digital outputs: <input type="checkbox"/> 5x 2 A, ~ 250 V <input type="checkbox"/> 1 open collector 5 analog outputs: <input type="checkbox"/> 2 open collector (PPM/PWM) <input type="checkbox"/> 2x 0-10 V <input type="checkbox"/> 1x 0-20 mA/4-20 mA	TM171OB22R TM171OBM22R TM171OD22R TM171ODM22R TM171ODM22S TM171OF22R TM171OFM22R	<input type="checkbox"/> 1 wired connector for LAN expansion bus	TM171EO22R	0.190/ 0.420

Accessories for I/O expansion modules

Designation	Description	Cable length (m/ft.)	Unit reference	Weight kg/lb
Accessories – To be ordered separately				
analog output connector (0-10 V outputs) Sold in lots of 5 (item 1)	Cordset equipped with a 4-pin connector on one end	1/3.3 2/6.6	TM171ACB4OAO1M TM171ACB4OAO2M	0.075/ 0.170 0.125/ 0.280
Low voltage connector Sold in lots of 5 (item 2)	Screw terminal block and a cordset equipped with a 20-pin connector on one end	1/3.3 2/6.6	TM171ACB4OI1M TM171ACB4OI2M	0.575/ 1.270 1.120/ 2.470
Accessory – Supplied with each expansion module				
LAN expansion bus connector Sold in lots of 5 (item 3)	Cordset equipped with a 3-pin connector at each end	2/6.6	TM171ACB4OLAN	0.060/ 0.130
Accessories – Supplied with TM171EP14R TM171EP27R				
Screw terminal blocks (inputs, outputs, and communication bus)	14 I/Os – For TM171EP14R 27 I/Os – For TM171EP27R	–	TM171ASCTB14 TM171ASCTB27	0.050/ 0.110 0.100/ 0.220

(1) On the same channel: 2 digital inputs or 2 analog outputs (depending on the configuration).
 (2) Minimum set for operating controllers.



Connection accessories (2) for expansion modules: TM171EO15R, M171EO22R

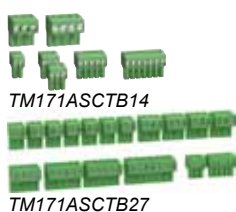

TM171ASCTB14

TM171ASCTB27

Hardware control platform

Modicon M171/M172 logic controllers

Communication modules for M171 performance and M172 performance logic controllers

3

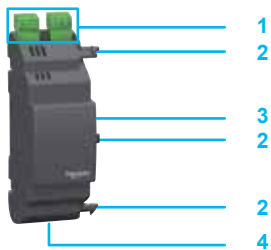

Presentation

The communication module offer is dedicated to the 35 mm/1.38 in. rail mounting version of **M171 performance** and **M172 performance** logic controllers (1). The 8 optional modules provide specific connections:

- To fieldbuses, including:
 - CAN bus
 - Modbus TCP
 - Profibus
 - Modbus SL (RS 485)
 - BACnet MS/TP (B-AAC profile)
 - BACnet IP (B-AAC profile)
 - RS 232 serial link
 - LonWorks (FFT-10)
 - Konnex (KNX) via Schneider Electric' spaceLYnk gateway, see page 5/5
- To services, including:
 - Ethernet
 - WebVisu and remote download functions
- They are mounted by simple interlocking on the left-hand side of an **M171 performance** or an **M172 performance** logic controller (1).
- Only one communication module can be added to a performance logic controller. The communication module is powered by the controller.
- Each communication module has its own type of connector, adapted to the bus or communication network (see details in the reference table, page 3/23).

Description

35 mm/1.38 in. rail mounting

TM171A I/O communication modules

- 1 Communication connector (2)
- 2 Locking device
- 3 Expansion connector to the performance controller type TM171P or TM172P (1)
- 4 Clip for 35 mm/1.38 in. rail mounting

(1) Compatibility between **M171** and **M172 performance** logic controllers and communication modules, see table below:

Compatibility between performance logic controllers and communication modules		
Logic controller	Reference	Compatible communication modules
M171 performance logic controller	TM171PBM27R TM171PDM27R TM171PDM27S	TM171ACAN TM171AETH TM171APBUS TM171AMB TM171ARS485 TM171ARS232 TM171AETHRS485 TM171ALON
M172 performance logic controller	TM172PBG28R TM172PDG28R TM172PDG28S TM172PBG42R TM172PDG42R TM172PDG42S	TM171ACAN TM171AMB TM171ARS485 TM171ARS232 TM171ALON

(2) Communication connector type depends on communication modules, see detail next page.

Hardware control platform

Modicon M171/M172 logic controllers

Communication modules for M171 performance and M172 performance logic controllers

Communication modules					
For M171 and M172 performance logic controllers (35 mm/1.38 in. rail mounting version)					
Designation	Compatibility with logic controller	Fieldbus, services access	Communication port	Reference (1)	Weight kg/lb
 TM171ACAN	M171 performance, M172 performance	<input type="checkbox"/> CAN	<input type="checkbox"/> 2 screw terminal blocks (1)	TM171ACAN	0.077/ 0.170
		<input type="checkbox"/> Modbus TCP	<input type="checkbox"/> 1 RJ45		
 TM171AETH	M171 performance	<input type="checkbox"/> Ethernet		TM171AETH	0.077/ 0.170
		<input type="checkbox"/> BACnet IP (B-AAC profile)			
 TM171APBUS	M171 performance	<input type="checkbox"/> WebVisu and remote download functions		TM171APBUS	0.077/ 0.170
		<input type="checkbox"/> Profibus			
 TM171AMB	M171 performance, M172 performance	<input type="checkbox"/> Modbus SL (RS 485)	<input type="checkbox"/> 2 screw terminal blocks (1)	TM171AMB	0.077/ 0.170
		<input type="checkbox"/> Modbus SL or BACnet MS/TP (B-AAC profile)	<input type="checkbox"/> 2 screw terminal blocks (1)		
 TM171ARS485	M171 performance, M172 performance	<input type="checkbox"/> RS 232 serial link	<input type="checkbox"/> 1 SUB-D 9 for RS 232	TM171ARS232	0.077/ 0.170
		<input type="checkbox"/> Relay output	<input type="checkbox"/> 1 screw terminal block for relay output (1)		
 TM171ARS232	M171 performance	<input type="checkbox"/> Modbus TCP and BACnet/IP	<input type="checkbox"/> 1 RJ45 for Ethernet	TM171AETHRS485	0.077/ 0.170
		<input type="checkbox"/> Modbus SL or BACnet MS/TP (B-AAC profile)	<input type="checkbox"/> 2 screw terminal blocks for RS 485 (1)		
 TM171AETHRS485	M171 performance, M172 performance	<input type="checkbox"/> WebVisu and remote download functions		TM171ALON	0.077/ 0.170
		<input type="checkbox"/> Ethernet			
 TM171ALON	M171 performance, M172 performance	<input type="checkbox"/> LonWorks (FFT-10)	<input type="checkbox"/> 1 screw terminal block for LON bus	TM171ALON	0.077/ 0.170

(1) Removable terminal blocks supplied with communication modules.

Presentation

Electronic expansion valve drivers

The 3 types of electronic expansion valve drivers are used to control the electronic expansion valve so as to control superheat after the evaporator.

- They are compatible with each performance or optimized logic controllers.
- They operate independently on measurement accessories such as:
 - NTC or PT1000 probes
 - Pressure transducers
- The 3 available electronic expansion valve drivers are compatible with competing valve brands such as those given in the table below:

Electronic expansion valve drivers Brand and type	Expansion valves Brand and type
Schneider Electric TM171VEVA2, TM171VEVD4, TM171VEVM4	ELIWELL™ SXVB
	ALCO™ EX4, EX5, EX6, EX7, EX8 EXM246/EXL246
	DANFOSS™ ETS50, ETS100
	SPORLAN™ SER(I) G, J, K, B, C, D SER1.5 to 20, SEI 30,50, SEH
	SANHUA™ DPF(Q)/DPF(T01)

Description

35 mm/1.38 in. \perp rail mounting

TM171V●● electronic expansion valve drivers (1)

- 1 Output terminal block and power supply connector (\approx 24 V)
 - 2 Protective cover
 - 3 3 status LEDs
- Behind the removable protective cover:**
- 4 6-position DIP switches
 - 5 Status LED (for operation with TM171AMFK programming stick)
 - 6 LAN serial port for connecting TM171DLED remote display
 - 7 Terminal block for analog/digital inputs
 - 8 Clip for 35 mm/1.38 in. \perp rail mounting
 - 9 TTL programming port

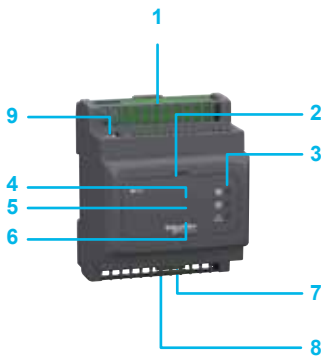

(1) TM171ASCTBVEV screw terminal block to be ordered separately.

Hardware control platform

Modicon M171/M172 logic controllers

Electronic expansion valve drivers



TM171VEVA2



TM171VEVD4



TM171VEVM4

Electronic expansion valve drivers

Application	Number and type of channels	Reference	Weight
	Inputs	Outputs	kg/lb
Actuator, convert 0-10 V or 4-20 mA in opening position contact	1 analog input: <input type="checkbox"/> 1x 4-20 mA, 0-5 V, or 0-10V	1 digital output: <input type="checkbox"/> 1 open collector (100 mA, \pm 12 V)	0.190/ 0.420
Autonomous, wired to manage On/Off contact	2 digital inputs: <input type="checkbox"/> 2 volt-free 4 analog inputs: <input type="checkbox"/> 2 NTC (-50...+110 °C, -40...+150 °C / -58...+203 °F, -40...+302 °F), PT1000, 4-20 mA, 0-5 V, or 0-10 V <input type="checkbox"/> 2 NTC (-50...+110 °C, -40...+150 °C / -58...+203 °F, -40...+302 °F), or PT1000 (1)	2 digital outputs: <input type="checkbox"/> 1 open collector (100 mA, \pm 12 V) <input type="checkbox"/> 1 SPST NO relay contact, 5 A, \sim 250 V	0.190/ 0.420
Autonomous, managed by Modbus (RS 485)	2 digital inputs: <input type="checkbox"/> 2 volt-free 4 analog inputs: <input type="checkbox"/> 2 NTC (-50...+110 °C, -40...+150 °C / -58...+203 °F, -40...+302 °F), PT1000, 4-20 mA, 0-5 V, or 0-10 V (1) <input type="checkbox"/> 2 NTC (-50...+110 °C, -40...+150 °C / -58...+203 °F, -40...+302 °F), or PT1000 (1)	2 digital outputs: <input type="checkbox"/> 1 open collector (100 mA, \pm 12 V) <input type="checkbox"/> 1 SPST NO relay contact, 5 A, \sim 250 V	0.190/ 0.420

Accessories for Electronic expansion valve drivers

To be ordered separately

Designation	For connecting	Reference	Weight
			kg/lb
Screw terminal block for electronic expansion valve drivers	Power supply, sensor power supply, digital and analog I/O, Modbus link	TM171ASCTBVEV	0.050/ 0.110



TM171ASCTBVEV

(1) 2 PT1000 (-50...+99.9 °C / -58... + 211.82 °F)

3



TM1SH314



TM1SH284



TM1STNTCRN61550



TM1STNTCSF44015



TM1STNTCSN62015



TM1STNTCTN62015



TM1STNTCRN52015



TM1STNTCWN65605



TM1STNTCWN75750



TM1STPTTSN62015



TM1STPTTSN52015

Measurement accessories						
Application	Description	Sold in lots of	Cable length m/ft.	Unit reference	Weight kg/lb	
Humidity & temperature probe	<input type="checkbox"/> IP 65 <input type="checkbox"/> 4-20 mA <input type="checkbox"/> Wall mounting <input type="checkbox"/> Measuring ranges: 0...100%, -40...60 °C / -40...140 °F	–	–	TM1SH314	0.176/0.390	
	Humidity probe	–	–	TM1SH304	0.170/0.370	
Humidity probe (sensor equipped with a cable)	<input type="checkbox"/> IP 54 <input type="checkbox"/> 4-20 mA <input type="checkbox"/> Measuring ranges: 15...90%	–	3/9.84	TM1SH284	0.138/0.300	
NTC probes (sensor equipped with a cable)	<input type="checkbox"/> IP 67 <input type="checkbox"/> Sensor 6x 15 mm / 0,591 in. <input type="checkbox"/> -50...+110 °C/-122...+230 °F <input type="checkbox"/> Grey	8	1.5/4.92	TM1STNTCRN61515	0.104/0.230	
		5	3/9.84	TM1STNTCRN61530	0.125/0.280	
		4	5/16.40	TM1STNTCRN61550	0.164/0.360	
		8	1.5/4.92	TM1STNTCSF44015	0.144/0.320	
	<input type="checkbox"/> FAST IP 67 <input type="checkbox"/> 4x 40 mm / 1.57 in. <input type="checkbox"/> -50...+110 °C/-122...+230 °F <input type="checkbox"/> Grey	5	3/9.84	TM1STNTCSF44030	0.175/0.390	
		8	1.5/4.92	TM1STNTCSN62015	0.144/0.320	
	<input type="checkbox"/> IP 68 <input type="checkbox"/> 6x 20 mm / 0,79 in. <input type="checkbox"/> -50...+110 °C/-122...+230 °F <input type="checkbox"/> Grey	5	3/9.84	TM1STNTCSN62030	0.175/0.390	
		4	5/16.40	TM1STNTCSN62050	0.232/0.510	
		8	1.5/4.92	TM1STNTCTN62015	0.152/0.340	
	<input type="checkbox"/> IP 68 <input type="checkbox"/> 6x 20 mm / 0,79 in. <input type="checkbox"/> TPE <input type="checkbox"/> with strap <input type="checkbox"/> Grey	5	3/9.84	TM1STNTCTN62030	0.180/0.400	
		8	1.5/4.92	TM1STNTCRN52015	0.144/0.320	
	<input type="checkbox"/> IP 68 <input type="checkbox"/> 5x 20 mm / 0,79 in. <input type="checkbox"/> -50...+110 °C/-122...+230 °F <input type="checkbox"/> Grey	5	3/9.84	TM1STNTCRN52030	0.180/0.400	
		4	5/16.40	TM1STNTCRN52050	0.228/0.500	
		–	–	TM1STNTCWN65605	0.050/0.110	
NTC probes for air wall mounting	Outdoor mounting	–	–	TM1STNTCWN65605	0.050/0.110	
	Indoor mounting	–	–	TM1STNTCWN75750	0.050/0.110	
PT1000 probes	<input type="checkbox"/> IP 68 <input type="checkbox"/> 6x 20 mm / 0,79 in. <input type="checkbox"/> -50...+110 °C/-122...+230 °F <input type="checkbox"/> Green	8	1.5/4.92	TM1STPTTSN62015	0.144/0.320	
		5	3/9.84	TM1STPTTSN62030	0.175/0.390	
		8	1.5/4.92	TM1STPTTSN52015	0.136/0.300	
		5	3/9.84	TM1STPTTSN52030	0.175/0.390	
	<input type="checkbox"/> IP 68 <input type="checkbox"/> 5x 20 mm / 0,79 in. <input type="checkbox"/> -50...+110 °C/-122...+230 °F <input type="checkbox"/> Green	4	5/16.40	TM1STPTTSN52050	0.232/0.510	



XMLP pressure transmitters

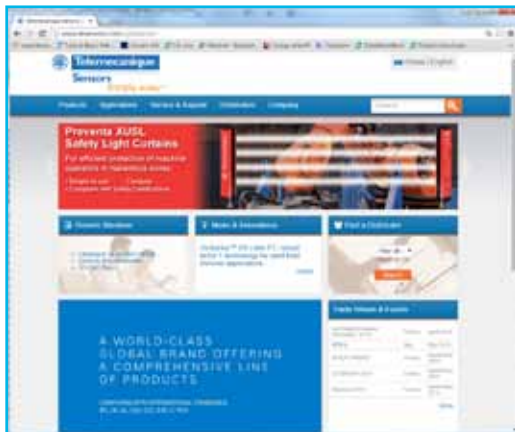

- > Discover XMLP offer on the web site:
<http://www.tesensors.com/global>
- > Access to the catalog by product at this URL:
<http://www.tesensors.com/global/en/product/catalog/>

Schneider Electric recommends his partner Telemecanique Sensors, which proposes a range of pressure transmitters: XMLP

Presentation

XMLP pressure transmitters are characterised by their “thin film” technology. The stainless steel capsule holding the sensing element is welded directly onto the transmitter’s stainless steel body, which provides the following advantages:

- > No gasket comes into contact with the fluid
- > Compatibility with a large number of fluids:
 - Hydraulic oils
 - Air
 - Fresh water
 - Refrigeration fluids
 - All fluids or gases compatible with stainless steel AISI 304

XMLP pressure transmitters can control fluids from - 30 to 120°C / 86 to 248 °F.

- Their power supply depends on the type of analog output:
- > 5 V +/- 5% for the 0.5...4.5 V ratiometric output
 - > 12 or 24 V (nominal), operating from 8 to 30 V for the 4...20 mA output
 - > 24 V (nominal), operating from 14 to 30 V for the 0...10 V output
- Made of 304 stainless steel, XMLP pressure transmitters are compact and rugged.

Their degree of protection varies according to the type of connector:

- > IP 65 for versions with connector EN 175301-803-A
- > IP 65 and IP 67 for Packard Metri-Pack connector versions
- > IP 65, IP 67 and IP 69K for M12 connector versions

With typical precision better than 0.5% of the rating, these transmitters are particularly suitable for industrial applications such as:

- > Machine tools
- > Moulding presses
- > Stamping presses
- > Lifting gear
- > Air-conditioning systems (HVAC)

Functions

XMLP pressure transmitters have an analog output which delivers a signal proportional to the measured pressure. This output can be one of the following types:

- > 4...20 mA
- > 0...10 V
- > 0.5...4.5 V

The pressure ranges available are:

- > 0...10 bar to 0...600 bar or
- > 0...100 psi to 0...10,000 psi

The XMLP offer is available in three types of electrical connection:

- > M12, 4-pin connector
- > EN 175301-803-A connector (ex-DIN 43650)
- > Packard Metri-Pack 150 connector

Several types of fluid connection are available:

- > G1/4 A male
- > SAE 7/16-20UNF-2A male
- > SAE 7/16-20UNF-2B female (with Schrader pin)
- > 1/4"-18 NPT male

Nota: XMLP pressure transmitters are sold individually or in lots of 40.

Chapter 4

Programming software



Technical data relating to products listed in this chapter is available online at www.schneider-electric.com/modicon-m171-m172

- **SoMachine HVAC programming software for Modicon M171/M172 logic controllers**
 - **Presentation** page 4/2
 - **General characteristics** page 4/2
 - **Product offer** page 4/3
 - **References**
 - > Programming Software..... page 4/3
 - > Programming accessories:
 - for M171 and M172 performance logic controllers page 4/3
 - for M171 optimized logic controllers page 4/3

Presentation



SoMachine HVAC programming software

Software solution

SoMachine HVAC programming software is compliant with IEC 61131-3. It can be used to develop, configure, and commission entire HVAC or Pumping solution systems.

It includes:

- Programming Modicon M171/M172 logic controllers (performance and optimized) and remote display units
- Setting up expansion buses and networks
- Creating the screen of the displays (built-in and displays of the M171/M172 logic controller offer)
- Configuring BMS communication modules on BACnet MS/TP (B-AAC profile), Modbus SL, Modbus TCP, BACnet MS/TP, BACnet IP (B-AAC profile), and LonWorks (FFT-10)
- Dedicated libraries such as:
 - a library of application function blocks (1)
 - a library of Tested, Validated, and Documented Applications (TVDA)
- Full simulation mode

General characteristics

Overview

Programming languages	<ul style="list-style-type: none"> ■ ST (Structured Text) ■ FBD (Function Block Diagram) ■ LD (Ladder) ■ IL (Instruction List) ■ SFC (Sequential Function Chart)
Applications	<ul style="list-style-type: none"> ■ Graphical and text-based languages: <ul style="list-style-type: none"> □ Adaptation to each developer background □ Library management □ Code debugging □ Parameter definition □ Simulation mode ■ Advanced programming: <ul style="list-style-type: none"> □ Vectors □ Pointers
System solutions management	<ul style="list-style-type: none"> ■ Multi-target project ■ Management of Modbus data ■ Data exchange between several Modicon M171/M172 performance logic controllers
Graphical user interface	<ul style="list-style-type: none"> ■ Graphic display: <ul style="list-style-type: none"> □ Multipage □ Buttons □ Edit box □ Static text □ Images □ Animations □ Bars □ Lists of data (parameters/variables/alarms) ■ Configurable buttons ■ Multilanguage ■ Automatic documentation
Communication bus configurators	<ul style="list-style-type: none"> ■ Control networks: Modbus TCP, Modbus SL, Profibus ■ Expansion bus fieldbus: CAN expansion bus ■ BMS connectivity: BACnet MS/TP (B-AAC profile), BACnet IP (B-AAC profile), LonWorks (FFT-10)
Advanced simulation options	<ul style="list-style-type: none"> ■ Full simulation □ I/O emulation □ HMI □ IEC code □ Live debug □ Triggers □ Oscilloscope
Advanced debugging and simulation options	<ul style="list-style-type: none"> ■ Remote control/download: <ul style="list-style-type: none"> □ Modbus SL & TCP □ CAN □ Modem ■ Parameter management ■ Status monitoring ■ Field test: <ul style="list-style-type: none"> □ Oscilloscope □ Debug window □ Export to Excel

(1) For more information about Application Function Blocks, see chapter 2.

Programming software

SoMachine HVAC programming software for Modicon M171/M172 logic controllers

Product offer

SoMachine HVAC software is supplied on a DVD or can be downloaded from our web site: www.schneider-electric.com > Solutions > Systems > Machine Control > HVAC control.

The product version concerned offers the SoMachine HVAC functions associated with logic controllers.

References

System configuration:

- Processor: Pentium 1.6 GHz or higher
- RAM: 1 GB; 2 GB recommended
- Hard disk: 500 MB minimum
- OS: 32-bit Windows; XP Pro SP3 or Windows 7 (32-bit or 64-bit) or Windows 8
- Drive: DVD drive
- Display: SVGA video card; 800×600, 128 MB; 1024×768, 256 MB recommended
- Peripheral device: A mouse or compatible pointing device
- Peripheral device: USB interface

Local programming, download - M171 & M172 performance - through USB port



Remote programming - M171 performance



Remote programming - M172 performance

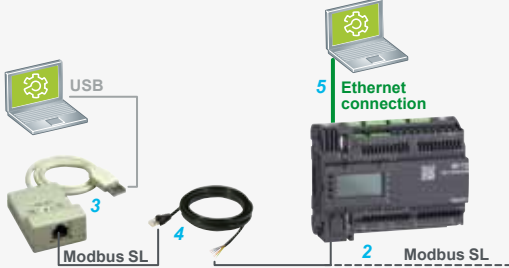

Local programming, download - M171 optimized - through TTL port

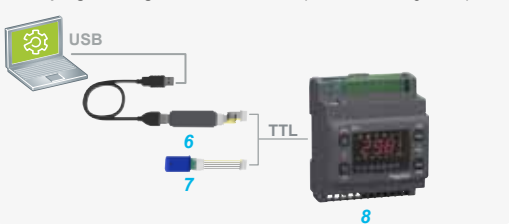

Remote programming - M171 optimized



SoMachine HVAC programming software

Application	Reference	Weight kg/lb
M171 optimized logic controllers, M171 performance logic controllers, and M172 performance logic controllers	TM171SW	0.050/ 0.110

Programming accessories for M171 and M172 performance logic controllers

- The USB cable is recommended for local programming.
- Ethernet port is recommended for remote download or remote programming.

Description	Characteristics and use	Length m/ft.	Reference	Weight kg/lb
Programming through USB port				
Programming cables (1)	From the PC USB-A port to the USB mini-B port on M171 (2) and M172 performance logic controllers (2)	3/0.98	TCSXCNAMUM3P (1)	0.065/ 0.143
		1.8/5.90	BMXXCAUSBH018	0.065/ 0.143

Programming through Modbus SL and/or Ethernet

USB to RS485 converter (3)	To be used on M171 (2) and M172 performance logic controllers (2) Equipped with 1 RJ45 connector on the controller side and 1 USB-A connector on the PC side	0.4/1.31	TSXCUSB485	0.144/ 0.320
----------------------------	--	----------	------------	-----------------

Connection cable for Modbus serial link (4)	Equipped with 1 RJ45 connector at one end and flying leads at the other end	3/9.84	VW3A8306D30	0.250/ 0.550
---	---	--------	-------------	-----------------

Ethernet connection cable

Ethernet ConneXium cable - shielded twisted pair straight cord (5)	For connection to terminal devices (DTE) Equipped with 1 RJ45 connector at each end	2/6.56 (2)	490NTW00002	-
--	---	------------	-------------	---

CE compatible

(1) Unshielded cable without grounding. To be used only for temporary connections. For permanent connections, use the reference BMXXCAUSBH018.

(2) Other length available: 5 m/16.40 ft, 12 m/39.37 ft, 40 m/131.23 ft, and 80 m/262.47 ft, see page 5/4.

Programming accessories for M171 optimized logic controllers

Programming through TTL programming port

Description	Characteristics and use	Reference	Weight kg/lb
Programming cable (6)	To be used between a PC and the TTL programming port of M171 optimized logic controllers (8)	TM171ADMI	0.157/ 0.350

Programming stick (7)	To be used to transfer parameters from one M171 optimized logic controller (8) to another, or to download the program	TM171AMFK	0.010/ 0.020
-----------------------	---	-----------	-----------------

Programming through USB port

USB to RS485 converter (3)	See above
Connection cable for Modbus serial link (4)	See above

Chapter 5

Connectivity



Technical data relating to products listed in this chapter is available online at www.schneider-electric.com

- **MachineStruxure architectures** page 5/2
- **Communication modules for Modicon M171 and M172 performance logic controllers**
 - Presentation page 5/3
 - References page 5/3
- **ConneXium - Connecting Ethernet devices: Shielded copper connection cables**
 - Presentation page 5/4
 - References page 5/4
- **spaceLYnk gateway**
 - Presentation page 5/5
 - References page 5/5
- **Universal automation Wifi interface**
 - Presentation page 5/5
 - References page 5/5
- **WebVisu** page 5/6
- **StruxureWare application** page 5/7

Connectivity

Modicon M171/M172 logic controllers

MachineStruxure architectures

MachineStruxure architectures

Easy integration into Building Management System (BMS)

Your customers demand comprehensive solutions that include enterprise-wide management of power, IT, HVAC, Pumping, and security and with a level of efficiency that includes system dynamics across segments, platforms, and providers. That's why MachineStruxure™ architectures can be easily integrated.

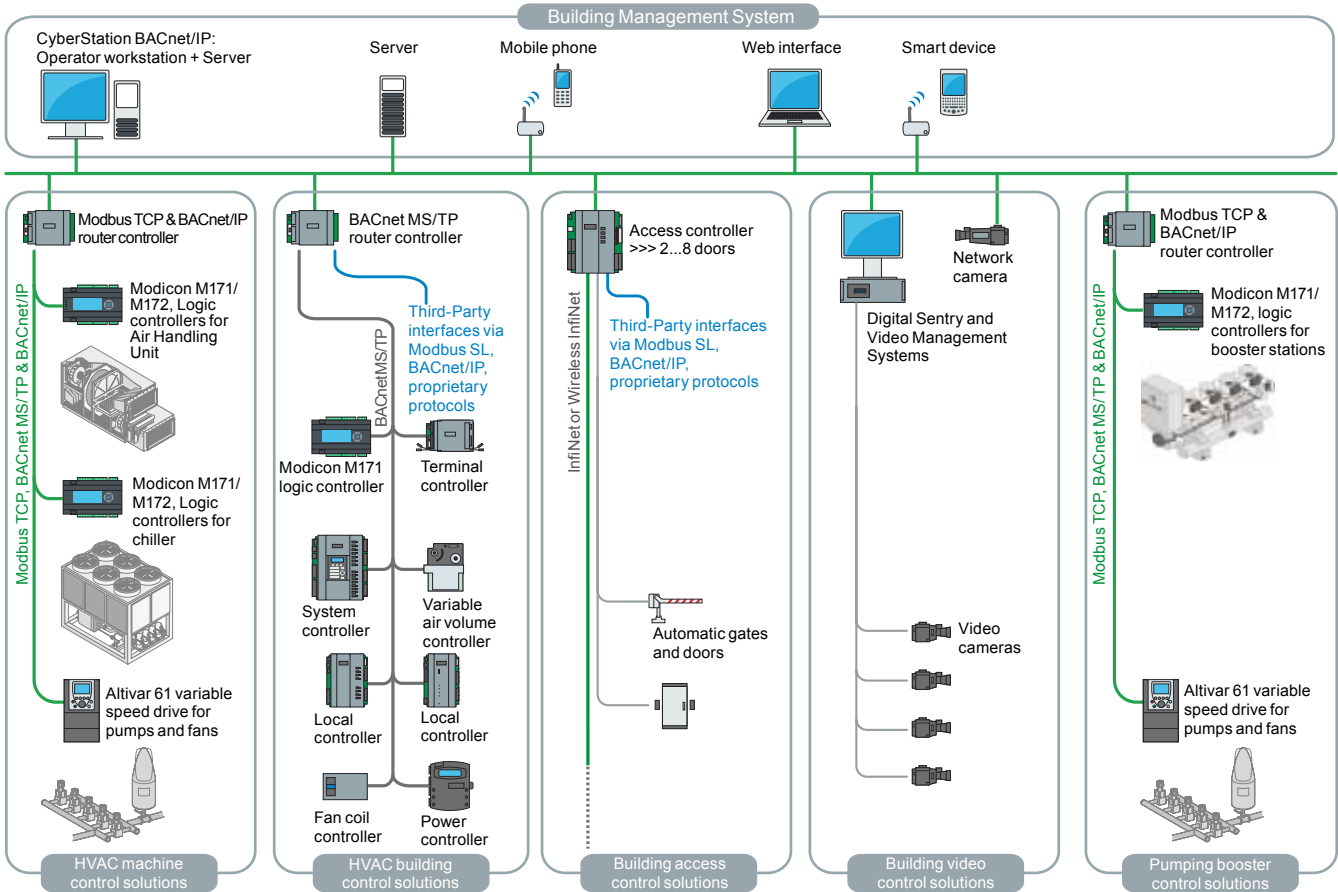

5

Your benefits

- > Modicon M171/M172 makes it easy to integrate your machines into your customers' BMS architectures
- > Compliance with open BMS standards:
 - > BACnet/IP, BACnet MS/TP (B-AAC profile), Modbus TCP, Modbus RTU, and LonWorks
 - > BACnet/IP & Modbus TCP Ethernet modules offering easy maintenance through embedded data logging, text e-mail, and web server
- > Maintenance and monitoring efficiency
 - > Provided on Ethernet modules, offering embedded data logging, e-mail notification, and web server capabilities
- > Late-point configuration with Modicon M171/M172 interchangeable communication plug-in



Modbus



(Pending)

Communication modules



TM171A communication module

+



M171 performance logic controller



TM171A communication module

+



M172 performance logic controller

Compatibility between M171 and M172 performance logic controllers and TM171A communication modules

Performance logic controllers	Compatible communication modules
TM171PBM27R TM171PDM27R TM171PDM27S	TM171ACAN TM171AETH TM171APBUS TM171AMB TM171ARS485 TM171ARS232 TM171AETHRS485 TM171ALON
TM172PBG28R TM172PDG28R TM172PDG28S TM172PBG42R TM172PDG42R TM172PDG42S	TM171ACAN TM171AMB TM171ARS485 TM171ARS232 TM171ALON

Presentation

TM171A communication modules are dedicated to the 35 mm (1.38 in.) rail mounting version of M171 performance logic controllers, and M172 performance logic controllers (please refer to the compatibility table).

They allow specific connections to fieldbuses (CAN bus, Modbus TCP, Profibus, Modbus SL (RS 485), BACnet MS/TP (B-AAC profile), BACnet IP (B-AAC profile), RS 232 serial link and LonWorks), and services (Ethernet, WebVisu, and remote download functions).

They are mounted by simple interlocking on the left-hand side of an M171 or M172 performance logic controller.

- Only one communication module can be added to an M171 performance or M172 performance logic controller. It is powered by the controller.
- Each communication module has its own type of connector, adapted to the bus or communication network (see table below).

References

Fiedbus or services access	Communication port type	Reference
<ul style="list-style-type: none"> CAN 	<ul style="list-style-type: none"> 2 screw terminal blocks (1) 	 TM171ACAN
<ul style="list-style-type: none"> Modbus TCP Ethernet BACnet IP (B-AAC profile) Web Visu and remote download functions 	<ul style="list-style-type: none"> 1 RJ45 	 TM171AETH
<ul style="list-style-type: none"> Profibus 	<ul style="list-style-type: none"> 1 SUB-D 9 	 TM171APBUS
<ul style="list-style-type: none"> Modbus SL (RS 485) 	<ul style="list-style-type: none"> 2 screw terminal blocks (1) 	 TM171AMB
<ul style="list-style-type: none"> Modbus SL or BACnet MS/TP (B-AAC profile) 	<ul style="list-style-type: none"> 2 screw terminal blocks (1) 	 TM171ARS485
<ul style="list-style-type: none"> RS 232 serial link Relay output 	<ul style="list-style-type: none"> 1 SUB-D 9 for RS 232 1 screw terminal block for relay output (1) 	 TM171ARS232
<ul style="list-style-type: none"> Modbus TCP and BACnet/IP Modbus SL or BACnet MS/TP (B-AAC profile) WebVisu and remote download functions Ethernet 	<ul style="list-style-type: none"> 1 RJ45 for Ethernet 2 screw terminal blocks for RS 485 (1) 	 TM171AETHRS485
<ul style="list-style-type: none"> LonWorks (FFT-10) 	<ul style="list-style-type: none"> 1 screw terminal block for LON bus 	 TM171ALON

(1) Removable terminal blocks supplied with communication modules.

Shielded copper connection cables

Presentation

ConneXium shielded connection cables are available in two versions to meet the requirements of the various current standards and approvals:

■ **EIA/TIA 568 shielded twisted pair cables for CE market**

These cables conform to:

- EIA/TIA-568 standard, category CAT 5E
- IEC 60603-2-11/EN 50173-1 standard, class D

Their fire resistance conforms to:

- NF C32-070 standard, class C2
- IEC 322/1 standards
- Low Smoke Zero Halogen (LSZH)

■ **EIA/TIA 568 shielded twisted pair cables for UL market**

These cables are:

- CEC type FT-1
- NEC type CM

A range of ConneXium fully shielded preassembled cables has been specially designed for use in harsh industrial environments. These cables combine a category 5E shielded cable and RJ 45 connectors reinforced with a metal profile.

References

EIA/TIA 568 shielded twisted pair cables for CE market

Description	End fittings	Type	Length m (ft.)	Reference	Weight kg
Straight-through copper cables CE compatible	2 RJ 45 connectors For connection to terminal devices (DTE)	standard	2 (6.56)	490NTW00002	–
			5 (16.40)	490NTW00005	–
			12 (39.37)	490NTW00012	–
			40 (131.23)	490NTW00040	–
			80 (262.47)	490NTW00080	–
		ruggedised	1 (3.28)	TCSECE3M3M1S4	–
			2 (6.56)	TCSECE3M3M2S4	–
			3 (9.84)	TCSECE3M3M3S4	–
			5 (16.40)	TCSECE3M3M5S4	–
			10 (32.81)	TCSECE3M3M10S4	–



490NTW000●●



TCSEC●3M3M●●S4

Shielded twisted pair cables for UL market

Description	End fittings	Type	Length m (ft.)	Reference	Weight kg
Straight-through copper cables UL compatible	2 RJ 45 connectors For connection to terminal devices (DTE)	standard	2 (6.56)	490NTW00002U	–
			5 (16.40)	490NTW00005U	–
			12 (39.37)	490NTW00012U	–
			40 (131.23)	490NTW00040U	–
			80 (262.47)	490NTW00080U	–
		ruggedised	1 (3.28)	TCSECU3M3M1S4	–
			2 (6.56)	TCSECU3M3M2S4	–
			3 (9.84)	TCSECU3M3M3S4	–
			5 (16.40)	TCSECU3M3M5S4	–
			10 (32.81)	TCSECU3M3M10S4	–

Do it Yourself copper cable and connectors

The ConneXium "Do it Yourself" offer consists of 2 connector references (M12 and RJ 45) and 1 cable reference - 300 m (984.252 ft) reel - enabling Ethernet 10/100 Mbps network cables to be made up in situ.

The maximum length of cables made up in this way is 80 m (262.467 ft.). They are assembled using only a knife and wire cutters (no special tool is required).

Description	Characteristics	Length m (ft.)	Reference	Weight kg
Ethernet copper cable 2 shielded twisted pairs 24 AWG	Conforms to the standards and approval listed above	300 (984.25)	TCSECN300R2	–
RJ 45 connector	Conforms to EIA/TIA-568-D	–	TCSEK3MDS	–

ConneXium unmanaged switches, 3, 4 and 5 ports, twisted pair and optical fibre

Description	Interfaces	Reference	Weight kg lb
ConneXium unmanaged switches	3 x 10BASE-T/100BASE-TX ports (copper cable), RJ 45 shielded connectors	TCSESU033FN0	0.113 0.249
	<ul style="list-style-type: none"> ■ 4 x 10BASE-T/100BASE-TX ports (copper cable), RJ 45 shielded connectors ■ 1 x 100BASE-FX port (multimode optical fibre), duplex SC connector 	TCSESU043F1N0	0.120 0.265
	5 x 10BASE-T/100BASE-TX ports (copper cable), RJ 45 shielded connectors	TCSESU053FN0	0.113 0.249



TCSESU053FN0

Other wiring components are available, please consult the ConneXium offer on our website www.schneider-electric.com.

spaceLYnk gateway

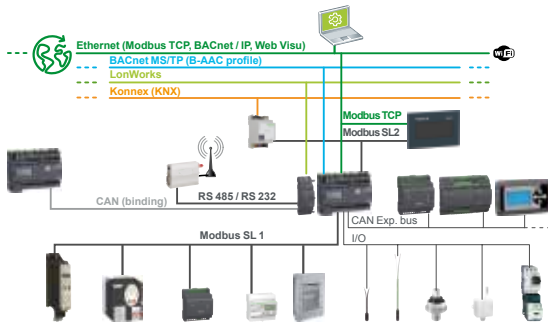

Presentation

spaceLYnk is designed to build a complete Building Automation Solutions for commercial segments :

- > Complete Building Automation solution for Small and Medium building with a complete architecture including Light and Room Control (KNX, DALI Control), Metering (Modbus offer, Smartlink RTU and IP), and boiler management (SSL)
- > Complete Building Automation solution for Large Building with a complete architecture managed by SBO (BMS from Schneider Electric) and including Light and Room Control (KNX, DALI Control) and Metering (Modbus offer, Smartlink RTU and IP)

spaceLYnk is compliance with the Modicon M171/M172 logic controller and allows to add KNX to the embedded protocols

spaceLYnk can be used in several ways:

- > As a gateway to translate and enable communication between different products
- > As an aggregator to stock, analyze, and send the data (.csv file for example)
- > As an user interface to display relevant informations on mobile devices
- > As an event controller that sends email in case of issues

Applications

- > Cross-standard gateway between KNX and Modbus RTU/TCP
- > Logical functions
- > WEB SCADA visualization for PC and touch-devices
- > BACnet Server (500 points)
- > Integration with third party devices over RS 232 (IR, AV)
- > Scheduling
- > Camera streaming
- > Data logger with trends

Technical feature

- > Supply voltage: 24 V DC
- > Interface: 1x KNX, 1x10BaseT/100BaseTX, 1x RS 485, 1x RS 232, 1x USB2.0

References

Designation	Communication port protocol	Reference
spaceLYnk logic controller	<input type="checkbox"/> BACnet <input type="checkbox"/> Modbus <input type="checkbox"/> IP (Internet Protocol) <input type="checkbox"/> KNX	 LSS100200

Universal automation WiFi Interface

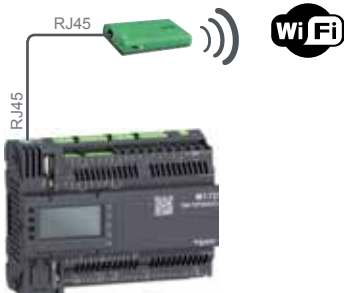

Presentation

The universal automation Wifi interface TCSEGWB13FA0 is a communication accessory, giving a wireless access point to several equipment as PC, PLC, Variable speed drive, Smart phone, Tablet, and Phablet.

References

Designation	Description	Reference
universal automation Wifi Interface - IP20 - with RJ45 and USB connectors	<input type="checkbox"/> For connection of WiFi equipment (PC, tablet, smartphone, etc.) <input type="checkbox"/> Powered by internal rechargeable battery <input type="checkbox"/> Provided with : USB cable, Battery, Quick start guide, Power adaptor, and Ethernet cable (RJ45/RJ45)	 TCSEGWB13FA0

WebVisu

WebVisu is embedded to simplify the web page creation and to create directly your page in SoMachine HVAC

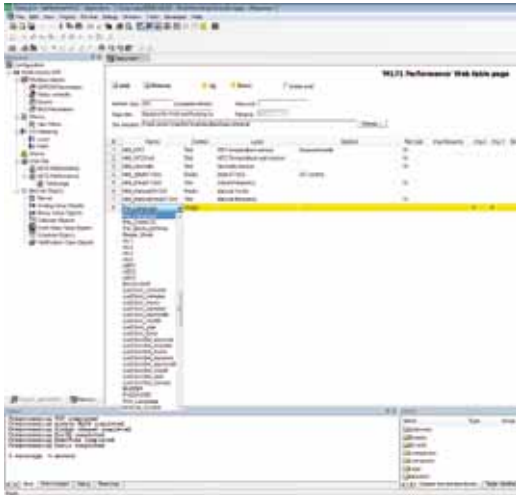

Web page creation with SoMachine HVAC software

SoMachine HVAC programming software is used to create in the webserver customized pages for viewing and monitoring devices.

These pages can also be accessed on any mobile device such as a tablet or smart phone with any operating system (iOS, Android, Windows).

External **HTML5 tool** can be also used to customize the pages with your logo and your company look and feel.

WebVisu (Web server) can allow to reduce solution cost !

How many time are you using an HMI for commissioning ?

if not more than twice a year, you can replace the HMI with a webserver and a WiFi access point (Universal automation WiFi interface, see page 5/5), allows you more features by using your smart phone to set, to check or to maintain the machine.

WebVisu is not displaying only ready values, you can write parameters or start/stop a device.

During maintenance, start and stop a device (fan, pump, compressor, coil,...) with a smart phone allows to stay close to this device. Maintenance is quicker and more efficient.

5



Result - Web page in classic browser

StruxureWare application

Start small and grow, and build on what you own



Discover StruxureWare Building Operation on our web site:
<http://www.schneider-electric.com/sites/corporate/en/solutions/struxureware/applications/building-operation.page>

StruxureWare applications allow you to add additional applications incrementally, while a 'plug and play' design helps to ensure the applications will connect seamlessly. Additionally, open standards mean StruxureWare applications will work with virtually any software, hardware, or system that you are already using, so there is no need to start over.

StruxureWare Building Operation

Delivering energy efficient and effectively-managed facilities

StruxureWare Building Operation provides integrated monitoring, control, and management of energy, lighting, fire, and HVAC systems.

Part of a SmartStruxure solution, the application optimizes energy consumption, maintains a healthy and productive environment, updates aging facilities, and delivers anytime/anywhere access to building systems.

Benefits

- > Personalize the modern, attractive interface for ease of use
- > Simplify day-to-day operations
- > Gain freedom of choice through embedded open protocols
- > Receive actionable intelligence through one-click reporting
- > Get the right information when, where, and how you want it

Chapter 6

Related products



Technical data relating to products listed in this chapter is available online at www.schneider-electric.com

- SE8000 room controllers
 - Presentation.....page 6/2
 - Panorama*.....page 6/2
 - References.....page 6/3
 - Operator dialog terminals
 - Magelis™ Small panels
 - Selection guide*.....page 6/4
 - Variable speed drives
 - Variable speed drives for compressors
 - Panorama*.....page 6/6
 - Variable speed drives for fans and pumps
 - Panorama*.....page 6/7
 - Variable speed drives for asynchronous and synchronous motors
 - Selection guide*.....page 6/8
 - Soft starters for asynchronous and synchronous motors
 - Selection guide*.....page 6/10
 - Control and protection components
 - Control panel technical guide
 - Optimize your motor starter solutionspage 6/11
 - Motor starter solutions with 1, 2, or 3 products
 - Panorama*.....page 6/12
 - Short-circuit and overload protection
 - Panorama*.....page 6/14
 - Incoming protection and switching
 - Panorama*.....page 6/16
 - Regulated switch mode power supplies and function modules: Phaseo power supplies
 - Selection guide*.....page 6/18
 - Indication and metering
 - Panorama*.....page 6/20

Presentation

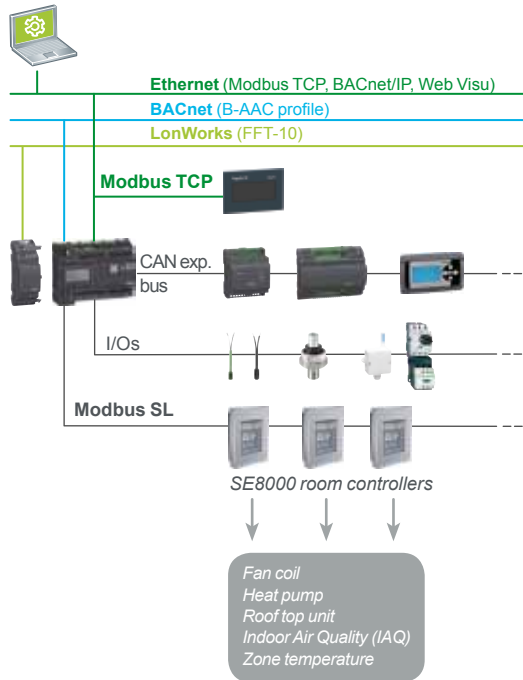

The SE8000 Series is a sophisticated addition to the Schneider Electric product portfolio of room controllers. With rich, customizable features, the SE8000 enables significant energy savings with accurate temperature control in any space, and can be easily integrated into most Building Management Systems (BMS).

Designed for new construction and retrofit projects, the SE8000 decreases project delivery costs by reducing installation, configuration and commissioning time.

No complex software or tools are required to customize functionality in order to meet your applications requirements. The SE8000 provides the advanced features and monitoring functions required by modern building automation systems, in a simple and compact enclosure.

Common features

- > Customizable colour digital touch screen interface
- > Configurable sequence of operations
- > Proportional integral control of HVAC equipment
- > BACnet MS/TP (BTL certified) and Modbus RTU (slave) integration
- > Each model supports over 100 configurable points/parameters
- > Scheduler
- > Upload custom standby screen images to highlight the brand or logo of your customers
- > Programmable with **Lua4RC** to modify control sequences or override inputs and outputs
- > Multi-language support (user interface): English, French, Spanish, Chinese, Russian, Arabic, Czech, Danish, Dutch, Finnish, German, Hungarian, Indonesian, Italian, Norwegian, Polish, Portuguese, Slovak, Swedish, and Turkish

Options

- > Different models address different types of HVAC equipment (fan coil units, roof top units, heat pumps, indoor air quality applications, and zone temperature control applications). This includes extra inputs to integrate remote temperature, humidity, and CO² sensors, depending on the SE8000 model and application
- > Optional on-board relative humidity sensor with dehumidification control sequence
- > Optional on-board PIR motion sensor with occupancy-based control sequence (modes: occupied, standby, unoccupied)

Uploader SE8000

- > The Firmware of the SE8000 can be upgraded using the Uploader SE8000. This free downloadable tool also enables the upload of standby screen images and scripts

Panorama

Series	SER8300 with SC3000 relay pack	SE8300	SE8600
Application	Line voltage fan coil units	Low voltage fan coil units	Rooftop units, heat pumps and indoor air quality
Description	<input type="checkbox"/> Requires SC3000 relay pack <input type="checkbox"/> Fan speed and sequence of operation <input type="checkbox"/> Two pipes <input type="checkbox"/> Four pipes	<input type="checkbox"/> Fan speed and sequence of operation <input type="checkbox"/> Two pipes <input type="checkbox"/> Four pipes	<input type="checkbox"/> Economizer <input type="checkbox"/> CO2 sensor input <input type="checkbox"/> Fresh Air Station input
		Mixed voltage fan coil units <input type="checkbox"/> Requires SC1300/SC2300 relay pack Zone control <input type="checkbox"/> Cooling only VVT zone with reheat <input type="checkbox"/> Fin-tube radiators <input type="checkbox"/> Cabinet heaters <input type="checkbox"/> Radiant panel heaters <input type="checkbox"/> Electric re-heat zones <input type="checkbox"/> Pressure dependent VAV system <input type="checkbox"/> Terminal reheat	Configurable stages <input type="checkbox"/> 1 heat/1 cool <input type="checkbox"/> 2 heat/2 cool <input type="checkbox"/> Modulation heat/2 cool <input type="checkbox"/> 3 heat/2 cool
Voltage	SER8000: 6.5 - 28 VDC or 20 - 28 VAC, 50/60Hz / 2.4 W Min. SC3000: 90-277 VAC universal, 50/60Hz	6.5 - 28 VDC or 20 - 28 VAC, 50/60Hz / 4 VA + Output Load (64 VA Max.)	28 VDC or 20 - 28 VAC, 50/60Hz / 4 VA + Output Load (64 VA Max.)
Communication	<input type="checkbox"/> Modbus SL <input type="checkbox"/> BACnet MS/TP	<input type="checkbox"/> Modbus SL <input type="checkbox"/> BACnet MS/TP	<input type="checkbox"/> Modbus SL <input type="checkbox"/> BACnet MS/TP



More information on Room controllers, Please visit our web site:
<https://ecobuilding.schneider-electric.com/room-controllers>

SE8000 room controllers - References				
Description	RH sensor & control	PIR motion sensor	Fascia and Casing color	Reference
Line voltage fan coil controller	–	–	Silver	SE8300A0B00
	✓	–	Silver	SE8350A0B00
	–	✓	Silver	SE8300A5B00
	✓	✓	Silver	SE8350A5B00
	–	–	White	SE8300A0B11
	✓	–	White	SE8350A0B11
	–	✓	White	SE8300A5B11
	✓	✓	White	SE8350A5B11
Low voltage fan coil controller	–	–	Silver	SE8300U0B00
	✓	–	Silver	SE8350U0B00
	–	✓	Silver	SE8300U5B00
	✓	✓	Silver	SE8350U5B00
	–	–	White	SE8300U0B11
	✓	–	White	SE8350U0B11
	–	✓	White	SE8300U5B11
	✓	✓	White	SE8350U5B11
Heat pump & indoor air quality controller	–	–	Silver	SE8600U0B00
	✓	–	Silver	SE8650U0B00
	–	✓	Silver	SE8600U5B00
	✓	✓	Silver	SE8650U5B00
	–	–	White	SE8600U0B11
	✓	–	White	SE8650U0B11
	–	✓	White	SE8600U5B11
	✓	✓	White	SE8650U5B11
Dimensions				
Height: 12 cm / 4.72 in - Width: 8.6 cm / 3.38 in - Depth: 2.5 cm / 1 in				

SC3000 relay packs - References				
Applications	Fan control	Monitoring inputs	Control types	Reference
2 pipes 2 pipes with reheat 4 pipes	Up to 3 speed	None	On-Off line switched valve output control □ 1 heat / cool output □ 1 cool output □ 3 fan outputs	SC3500E5045
		4 FCU remote inputs	On-Off line switched valve output control □ 1 heat / cool output □ 1 cool output □ 3 fan outputs	SC3504E5045
			On-Off line switched valve output control □ 1 heat / cool output □ 1 cool output □ 3 fan outputs □ Occupancy output (7VDC)	SC3514E5045 (with occupancy output)
2 pipes 2 pipes with modulating pulsed reheat	Up to 3 speed	None	On-Off line switched valve output control □ 1 heat / cool output □ 1 Modulating pulsed Vdc output for SSR electric reheat control □ 3 fan outputs	SC3400E5045
		4 FCU remote inputs	On-Off line switched valve output control □ 1 heat / cool output □ 1 Modulating pulsed Vdc output for SSR electric reheat control □ 3 fan outputs	SC3404E5045
Slave fan control only	Up to 3 speed	None	Slave fan control only 3 fan outputs	SC3300E5045 (slave fan unit)
Dimensions				
Height: 12.2 cm / 4.80 in - Width: 8.0 cm / 3.15 in - Depth: 3.3 cm / 1.30 in				

Related products

Modicon M171/M172 logic controllers
Operator dialog terminals: Magelis™ Small panels

Applications		Display of graphic pages	
Type of terminal		Small panels with monochrome or color touch screen	
			
Display	Type	Monochrome STN LCD (200 x 80 pixels), backlit - Green, orange, and red, or - White, pink, and red	Color TFT LCD (480 x 272 pixels)
	Capacity	3.4" (monochrome)	4.3" (color)
Data entry		Via touch screen	
Memory capacity	Application	16 MB Flash	32 MB Flash
	Expansion	-	
Functions	Maximum number of pages	Limited by internal FLASH EPROM memory capacity	8999
	Variables per page	Unlimited	384
	Representation of variables	Alphanumeric, bitmap, bargraph, gauge, curves, buttons, LEDs	
	Recipes	32 groups of 64 recipes	max Ingredients 8192
	Curves	Yes, with log	
	Alarm logs	Yes	
	Real-time clock	Access to the PLC real-time clock	Option: RTC battery set
	Alarm relay	-	
	Buzzer	Yes	
Communication	Asynchronous serial link	RS 232C/RS 485 (1) RS 232C using Zelio protocol (2)	RS 232C/RS 485 (1) RS 232C (2)
	Downloadable protocols	Uni-TE, Modbus and for PLC brands: Allen-Bradley, Omron, Mitsubishi, Siemens	
	Printer link	USB for serial or parallel printer	-
	USB ports	1 host type A and 1 device type mini-B	
	Networks	1 Ethernet TCP/IP port (10BASE-T/100BASE-TX) (3)	
Development software		Vijeo Designer (on Windows XP Professional and Windows 7 Business 32-bit and 64-bit)	Vijeo XD (on Windows 7 and Windows 8)
Operating system		Magelis	
References		HMISTO5●●	HMISTO7●5 (▲)

(1) Only HMISTO511, HMISTO512, HMISTO715
(2) Only HMISTO501, HMISTO705
(3) Only HMISTO531, HMISTO532, HMISTO735
▲ Available 1st quarter 2016

Display of graphic pages	
Small panels with color touch screen	
	
Color QVGA TFT LCD (320 x 240 pixels)	
3.5" (color)	5.7" (color)
Via touch screen	
32 MB Flash	
-	
Limited by internal FLASH EPROM memory capacity	
Unlimited	
Alphanumeric, bitmap, bargraph, gauge, curves, buttons, LEDs	
32 groups of 64 recipes	
Yes, with log	
Yes	
Access to the PLC real-time clock	
-	
Yes	
RS 232C/RS 485	
Uni-TE, Modbus and for PLC brands: Allen-Bradley, Omron, Mitsubishi, Siemens	
USB for serial or parallel printer	
1 host type A and 1 device type mini-B	
1 Ethernet TCP/IP port (10BASE-T/100BASE-TX)	
Vijeo Designer (on Windows XP Professional and Windows 7 Business 32-bit and 64-bit)	
Magelis	
HMISTU655 HMISTU655W	HMISTU855 HMISTU855W

Related products

Modicon M171/M172 logic controllers
Variable speed drives for compressors

Application	Type of machine controlled	Compressor				
	Number of phases	1		3		
	Type of motor	Asynchronous	Synchronous (PM)	Asynchronous	Asynchronous and Synchronous for scroll	Synchronous (PM)
Compressor size	0.18 kW 0.25 HP	Altivar 12	Altivar 32	–	–	–
	0.37 kW 0.5 HP			Altivar 312	–	–
	0.75 kW 1 HP				Altivar 212	Altivar 32
	2.2 kW 0.25 HP					
	7.5 kW 10 HP	–	–			
	15 kW 20 HP	–	–			
	75 kW 100 HP	–	–	Altivar 61		–

Compatible range of variable speed drives

Related products

Modicon M171/M172 logic controllers
Variable speed drives for fans or pumps

Application	Type of machine controlled	Fan or pump	
	Number of phases	1	3
	Fan or pump size	0.18 kW 0.25 HP	Altivar 12
0.37 kW 0.5 HP			–
0.75 kW 1 HP			Altivar 212
2.2 kW 0.25 HP			
7.5 kW 10 HP		–	
15 kW 20 HP		–	
75 kW 100 HP		–	
> 75 kW > 100 HP	–	Altivar 61	

Compatible range of variable speed drives

Related products

Modicon M171/M172 logic controllers
Variable speed drives for asynchronous and synchronous motors

Application		Variable speed drives	
		For material handling (small conveyors), packing and packaging (small labeling machines or bagging machines), suction pumps, centrifugal pumps, circulating pumps, air or smoke extractor fans, plastic film making machines, ovens, boilers, etc.	For material handling (small conveyors), hoists, packing and packaging (small labeling machines or bagging machines), special machines (mixers, kneaders), textile machines, pumps, compressors, fans, etc.
			
Power range for 50...60 Hz (kW) line supply		0.18...4/0.25...5	0.18...15/0.25...20
Single-phase 100...120 V (kW/HP)		0.18...0.75/0.25...1	–
Single-phase 200...240 V (kW/HP)		0.18...2.2/0.25...3	0.18...2.2/0.25...3
Three-phase 200...230 V (kW/HP)		–	–
Three-phase 200...240 V (kW/HP)		0.18...4/0.25...5	0.18...15/0.25...20
Three-phase 380...480 V (kW/HP)		–	–
Three-phase 380...500 V (kW/HP)		–	0.37...7.5/0.5...10
Three-phase 500...600 V (kW/HP)		–	–
Three-phase 525...600 V (kW/HP)		–	0.75...15/1...20
Three-phase 500...690 V (kW/HP)		–	–
Degree of protection		IP 20	IP 21
Type of cooling		Heatsink or base plate	Heatsink
Drive system		0.1...400 Hz	0.1...500 Hz
Output frequency			
Type of control		Asynchronous motor	Standard (voltage/frequency) Performance (sensorless flux vector control) Pump/fan (Kn ² quadratic ratio)
		Synchronous motor	Standard (voltage/frequency) Performance (sensorless flux vector control). Energy saving ratio
Transient overtorque		150...170% of the nominal motor torque	170...200% of the nominal motor torque
Functions (number)		40	50
Safety functions		–	–
Integrated		–	–
Available as an option		–	–
Number of preset speeds		8	16
Number of I/O		1	3
Analog inputs		4	6
Logic inputs		1	1
Analog outputs		1	–
Logic outputs		1	2
Relay outputs		1	–
Communication		Modbus	Modbus and CANopen
Integrated		–	CANopen Daisy Chain, DeviceNet, PROFIBUS DP, Modbus TCP, Fipio
Available as an option		–	–
Bluetooth link®		–	–
Options		–	–
Dialog tools		IP 54 or IP 65 remote terminal	IP 54 or IP 65 remote terminal IP 54 remote graphic display terminal
Configuration		SoMove Simple Loader, Multi-Loader	SoMove Simple Loader, Multi-Loader
Standards and certifications		IEC 61800-5-1 IEC 61800-3 (environments 1 and 2, categories C1 to C3)	IEC 61800-5-1 IEC 61800-3 (environments 1 and 2, categories C1 to C3)
		CE, UL, CSA, C-Tick, NOM, GOST	CE, UL, CSA, C-Tick, NOM, GOST, DNV
Variable speed drive range		Altivar 12	Altivar 312

Variable speed drives without sensor (velocity control)		Variable speed drives	
For material handling (conveyors), transfer machines, packaging machines, hoisting, special machines (textile, transfer), wood-working or metal processing machines, etc.		For pumps, fans, and HVAC applications	For pumps, fans, and industrial applications
			
			
Power range for 50...60 Hz (kW) line supply		0.18...15/0.25...20	0.37...800/0.5...900
Single-phase 100...120 V (kW/HP)		–	–
Single-phase 200...240 V (kW/HP)		0.18...2.2/0.25...3	0.37...5.5/0.5...7.5
Three-phase 200...230 V (kW/HP)		–	–
Three-phase 200...240 V (kW/HP)		–	–
Three-phase 380...480 V (kW/HP)		0.75...30/1...40	0.75...90/1...125
Three-phase 380...500 V (kW/HP)		0.75...75/1...100	0.75...630/1...900
Three-phase 500...600 V (kW/HP)		–	–
Three-phase 525...600 V (kW/HP)		–	2.2...7.5/3...10
Three-phase 500...690 V (kW/HP)		–	–
Degree of protection		IP 20	IP 20
Type of cooling		Heatsink	Heatsink or water-cooled system
Drive system		0.1...599 Hz	0.5...200 Hz
Output frequency			
Type of control		Voltage/frequency ratios: U/f and 5-point U/f Sensorless flux vector control ratio Kn ² quadratic ratio (pump/fan). Energy saving ratio	Sensorless flux vector control Voltage/frequency ratio (2 points) Energy saving ratio
Ratio for synchronous motor without sensor		–	Vector control without speed feedback
Transient overtorque		170...200% of the nominal motor torque	120% of the nominal motor torque
Functions (number)		150	50
Safety functions		1: STO (Safe Torque Off) 3: SLS (Safe Limited Speed), SDI (Safe Direction Information), SS1 (Safe Stop 1)	–
Integrated		–	–
Available as an option		–	–
Number of preset speeds		–	7
Number of I/O		3	2
Analog inputs		6	3
Logic inputs		1	1
Analog outputs		1	–
Logic outputs		2	2
Relay outputs		–	–
Communication		Modbus and CANopen	Modbus, METASYS N2, APOGEE FLN, BACnet
Integrated		DeviceNet, PROFIBUS DP V1, EtherNet/IP, Modbus TCP, EtherCat	LONWORKS
Available as an option		–	Modbus TCP Daisy Chain, Modbus/Uni-Telway, EtherNet/IP (RSTP), DeviceNet, PROFIBUS DP V0 and V1, INTERBUS, CC-LINK, LONWORKS, METASYS N2, APOGEE FLN, BACnet, Profinet, EtherCAT, POWERLINK
Bluetooth link®		–	–
Options		Filters, braking resistors, line chokes	I/O expansion cards, "Controller Inside" programmable card, multi-pump cards, encoder interface cards
Dialog tools		IP 54 or IP 55 drive navigator IP 54 or IP 55 remote graphic display terminal	IP 54 or IP 65 remote graphic display terminal
Configuration		SoMove Simple Loader, Multi-Loader	PCSoft for Altivar 212 Multi-Loader
Standards and certifications		IEC 61800-5-1, IEC 61800-3 (environments 1 and 2, category C2), UL508C, EN 954-1 category 3, ISO/EN 13849-1/-2 category 3 (PL e), IEC 61508 (parts 1 & 2) SIL 3 level, draft standard EN 50495E, IEC 60 721-3-3 classes 3C3 and 3S2	IEC 61800-5-1 IEC 61800-3 (environments 1 and 2, categories C1 with option to C3)
		CE, UL, CSA, C-Tick, NOM, GOST	CE, UL, CSA, DNV, C-Tick, NOM, GOST
Variable speed drive range		Altivar 32	Altivar 212
			Altivar 61

Application		Soft starter	Soft start/soft stop unit	Soft start/soft stop unit
		For conveyors, conveyor belts, pumps, fans, compressors, automatic doors, small gantries, belt-driven machines, etc.		For centrifugal pumps, piston pumps, fans, screw compressors, conveyors, agitators, mixers, centrifugal machines, etc.
				
Power range for 50...60 Hz (kW) line supply		0.37...11	0.75...15	4...400
Single-phase 110...230 V (kW)		0.37...2.2	–	–
Three-phase 200...240 V (kW)		–	0.75...7.5	–
Three-phase 200...480 V (kW)		0.37...11	–	–
Three-phase 208...600 V (kW)		–	–	4...400
Three-phase 208...690 V (kW)		–	–	–
Three-phase 230...415 V (kW)		–	–	–
Three-phase 230...440 V (kW)		–	–	4...355
Three-phase 380...415 V (kW)		–	1.5...15	–
Degree of protection		IP 20		
Drive system				
Number of controlled phases		1	2	3
Type of control		–	–	Configurable voltage ramp
Operating cycle		–	–	Standard
Functions (number)		1 Bypass		
Safety functions		Integrated		
		Available as an option		
Number of preset speeds		–		
Number of I/O				
Analog inputs		–		
Logic inputs		–		
Analog outputs		–		
Logic outputs		–		
Relay outputs		–		
Communication		Integrated		
		Available as an option		
Dialog tools		–		
Configuration		Setup software		
Standards and certifications				
		IEC/EN 60947-4-2		IEC/EN 60947-4-2, EMC class A
		CE, UL, CSA, C-Tick, CCC		CE, UL, CSA, C-Tick, GOST, CCC
Type of soft starter		ATS01N1●●●●	ATS01N2●●●●	ATS22●●●●

Control panel technical guide for HVAC & R equipment



Control Panel Technical Guide
How to select the appropriate motor starters for your HVAC & R* equipment

The guide that can help you optimize your motor starter solutions

Why this guide?

This technical guide has been specially designed to assist customers in the selection of the appropriate contactor-based motor starter solutions for their installation of HVAC & R equipment.

2 kind of solutions are involved:

- > “standard” solutions for general purpose applications
- > “HVAC & R adapted” solutions for definite purpose applications

Each solution of this guide combines:

- > thermal magnetic protection
- > control by contactors

For which applications?

This 24-page guide is intended for 3 types of application:

- > compressors
- > fans
- > pumps

How can we help you?

This guide includes a table containing information on how to:

- > Select your HVAC & R machine
- > Find the motors that should be embedded
- > Access the corresponding motor starters selection pages

Availability

You will find this document in PDF format available to download from our website: www.schneider-electric.com.

Related products

Modicon M171/M172 logic controllers
Motor starter solutions with 1, 2, or 3 products

Advantages	<ul style="list-style-type: none"> Simple manual motor starter Fast wiring Compact size 	<ul style="list-style-type: none"> Conventional solution for pushbutton or automated motor control Easy maintenance (contactor replacement) Broad offer (e.g. connections, motor rating, etc.) 	<ul style="list-style-type: none"> Advanced motor protection provided by dedicated components Easy maintenance (selective replacement) Broad offer (e.g. protection type, etc.)
-------------------	--	---	--

Separate components	1-product solution	2-product solution	3-product solution	
	<p>Motor circuit breaker</p> <p>GV2 GV3 GV7</p> <p>Up to 110 kW</p>	<p>Motor circuit breaker</p> <p>GV2 and Compact NSX GV3 GV7</p> <p>+ Contactor</p> <p>LC1 K LC1 D LC1 F and LC1 B</p> <p>Up to 110 kW</p>	<p>Magnetic circuit breaker</p> <p>GV2 GV3 Compact NSX</p> <p>+ Contactor</p> <p>LC1 K LC1 D LC1 F and LC1 B</p> <p>+ Thermal relay Controller</p> <p>LRD LTM LUTM</p> <p>LR2K</p> <p>Up to 110 kW</p>	<p>Fused disconnect switch</p> <p>GS2</p> <p>+ Contactor</p> <p>LC1 K LC1 D LC1 F and LC1 B</p> <p>+ Thermal relay Controller</p> <p>LRD LTM LUTM</p> <p>LR2K</p> <p>Up to 560kW</p>

Pre-assembled: Ready to incorporate in the panel	<p>Pre-assembled: Ready to incorporate</p> <p>Pre-assembled motor circuit breaker + contactor</p> <p>Up to 15 kW GV2ME●●K1●● GV2DP</p>	<p>Pre-assembled: Ready to incorporate</p> <p>Pre-assembled motor circuit breaker + contactor</p> <p>Up to 15 kW GV2ME●●K1●● GV2DP</p>	<p>Pre-assembled: Ready to incorporate</p> <p>Pre-assembled motor circuit breaker + contactor</p> <p>Up to 15 kW GV2ME●●K1●● GV2DP</p>
---	---	---	---









Enclosed: Ready to mount on the machine	<p>Enclosed: Ready to mount</p> <p>VøF VCFN VøFY GV2MC GV2MP GV2PC GV3PC</p> <p>Up to 45 kW Up to 30 kW</p>	<p>Enclosed: Ready to mount</p> <p>GV2ME LE1D</p> <p>Up to 37 kW</p>	<p>All in one: TeSys U</p> <p>Control unit</p> <p>Up to 33 kW LUB12, LUB32</p> <p>Basic to extended functionalities</p> <ul style="list-style-type: none"> Short circuit, overload protection Overload indication and alerts Status, remote control via communication bus <p>Advantages</p> <ul style="list-style-type: none"> Fast wiring Compact motor starter Flexibility: last minute customization Electrical coordination
--	---	--	--

Compliant standards

Legends

Related products



Modicon M171/M172 logic controllers
Short-circuit and overload protection

Applications	DC circuit protection and disconnection: DC power supplies, generators, batteries, etc.		AC circuit protection and disconnection of machines, electrical distribution in buildings		Protection and disconnection of electrical circuits	Protection of operators against electrical shocks in event of direct or indirect contact with live equipment	Protection of operators against electrical shocks in event of direct or indirect contact with live equipment	Protection of operators against electrical shocks in event of direct or indirect contact with live equipment	Protection of sensitive equipment against voltage surges due to lightning, high power switching, etc.		
	Acti 9	Multi 9	Acti 9	Multi 9	TeSys DF	Acti 9	Multi 9	Acti 9	Multi 9		
											
Description	Miniature circuit breaker	Miniature circuit breaker	Miniature circuit breaker	Miniature circuit breaker	Fuse holder	RCBO (3)	RCBO (3)	RCCB (4)	Surge arrester		
Characteristics	Voltage		230/400 V AC		500 VAC	230/400 VAC					
	60 V DC/pole	250 V DC/pole			690 VAC						
Characteristics	Number of poles		1, 2, 3, and 4		–	1P+N		2, 3, and 4P			
	1 or 2				–						
Characteristics	Nominal current (A)		63 to 125		25	32	50	25	6 to 32	25 to 63	–
	1 to 63				8 x 32 mm (0.32 x 1.26 in.)	10 x 38 mm (0.39 x 1.5 in.)	14 x 51 mm (0.5 x 2 in.)	22 x 58 mm (0.87 x 2.28 in.)			
Characteristics	Breaking capacity (kA)		10		20	120	–	–	–	–	20
	6				–	–	–	–	–	–	–
Characteristics	Load type/Tripping curve (1)		B, C, D		–	C class A 30 or 300 mA		C class A 30 or 300 mA		Type 2	
	B, C, D	C	B, C, D		–						
Characteristics	Width		27 mm (1.07 in.)/pole		–	36 mm (1.42 in.)		27 to 63 mm (1.06 x 2.48 in.)		36 to 72 mm (1.42 x 2.84 in.)	
	18 mm (0.71 in.)/pole				–						
Characteristics	Product reference		Acti 9 C120N		–	Acti 9 DPN Vigi		Acti 9 Vigi iC60 blocks (2)		Acti 9 RCCB ID	
	Acti 9 iC60N	Acti 9 C60H-DC	Acti 9 iC60N	Acti 9 C120N	–						
Characteristics	IEC/UL		–		DF8	DF10	DF14	DF22	–	–	Multi9 GFP
	Multi 9 C60N	Multi 9 C60H-DC	Multi 9 C60N	–	–	–	–	–	–	–	–

(1) Tripping curve:
 B (3 In < Im < 5 In) standard
 C (5 In < Im < 10 In) inrush current
 D (10 In < Im < 14 In) electronics or long cable length

Related products

Modicon M171/M172 logic controllers
Incoming protection and switching

Applications	On-load switching of motors, resistive and inductive loads	Control and disconnection of electrical distribution circuits	Protection and switching of motors	Protection in industrial and tertiary applications	Feeder protection and circuit disconnection for multistandard motor circuit design	Power circuit protection and disconnection in industrial, infrastructure, and building applications	
	<p>TeSys Vario</p> 	<p>Compact</p> 	<p>TeSys GS</p> 	<p>NG</p> 	<p>Powerpact</p> 	<p>Compact</p> 	
Description	Switch disconnectors Rotary switch with fully visible breaking	Switch disconnectors	Fuse switch disconnectors	Circuit breakers	Molded case circuit breakers with optional embedded communication and metering possibilities		
Isolation and disconnection	<input checked="" type="checkbox"/>		<input checked="" type="checkbox"/>	<input checked="" type="checkbox"/>			
Protection	–		<input checked="" type="checkbox"/>	<input checked="" type="checkbox"/>			
Characteristics	Rated operational current (A)	12 to 175	40 to 2,500	32 to 1,250	10 to 125	15 to 600	16 to 3,200
Number of poles	3 to 6	3 and 4	3 and 4	3 and 4			
Short-circuit making capacity at 400 V Icm (kA)	0.5 to 3	50 to 220	5 to 90	10 to 50	18 to 65	25 to 150	
Product name	V	INS	GS	NG125	NH, NJ, NL	NSX/NS	
Embedded metering	–	–	–	–	Micrologic metering adapters		
Standards and certifications	IEC 60947-3 UL508	IEC 60947-3 UL508	IEC 60947-3	IEC 60947-2	IEC 60947-2 UL508	IEC 60947-2 UL508	IEC 60947-2

Related products

Modicon M171/M172 logic controllers
Regulated switch mode power supplies and function modules
Phaseo power supplies

Power supplies Function modules	Regulated switch mode		Function modules (Only compatible with Phaseo ABL8RP/ABL8WP power supplies)	
	ABL8MEM, ABL7RM: 7 to 60 W - Mounting on rail ABL8REM, ABL7RP: 60 to 144 W - Mounting on rail	ABL8RPS/8RPM/8WPS: 72 to 960 W - Wide input voltage range Mounting on rail	ABL8DCC: converter modules 24 V 24 V 5-12 V	ABL8B: solutions to microbreaks and power outages



Input voltage	100...240 V ~ 120...250 V 24 V		100...120 V ~ and 200...500 V ~ (1)	380...500 V ~	24 V 24 V	24 V 24 V	24 V 24 V
Connection to world-wide line supplies	United States - 120 V (in phase-to-neutral) - 240 V (in phase-to-phase) Europe - 230 V (in phase-to-neutral) - 400 V (in phase-to-phase) United States - 277 V (in phase-to-neutral) - 480 V (in phase-to-phase)	Single-phase (N-L1) or 2-phase (L1-L2) connection Single-phase (N-L1) connection	Single-phase (N-L1) or 2-phase (L1-L2) connection	3-phase (L1-L2-L3) connection 3-phase (L1-L2-L3) connection	-	-	-
IEC/EN 61000-3-2 conformity	Yes for ABL7RP, not for ABL8REM and not applicable for ABL8MEM and ABL7RM		Yes	Yes	-	-	-
Protection against undervoltage	Yes		Yes, current limitation or undervoltage detection	Yes, current limitation	-	-	-
Protection against overloads and short-circuits	Yes, voltage detection. Automatic restart on elimination on the fault		Yes, depending on model	Yes, depending on model	-	-	-
Diagnostic relay	-		Yes with buffer module, battery and battery control modules, redundancy module and discriminating downstream protection module	Yes with buffer module, battery and battery control modules, redundancy module and discriminating downstream protection module	-	-	-
Compatibility	with function modules with power supplies		-	-	ABL8RP/8WP	ABL8RP/8WP	ABL8RP/8WP
Power reserve (Boost)	1,25 to 1,4 In during 1 minute, depending on model (with ABL8MEM) No		1,5 In during 4 secondes	No	-	-	-
Output voltage	5 V 12 V 24 V 48 V		24 V	5 V 7...12 V 24 V	24 V	24 V	24 V
Output current	0.3 A 0.6 A 1.2 A 2 A 2.5 A 3 A 4 A 5 A 6 A 10 A 20 A 40 A	ABL8MEM24003 ABL8MEM24006 ABL8MEM24012 ABL8MEM12020 ABL7RM24025 ABL7RP4803 ABL8REM24030 ABL8MEM05040 ABL7RP1205 ABL8REM24050	ABL8RPS24030 ABL8RPS24050 ABL8RPS24100 ABL8RPM24200 ABL8WPS24200 ABL8WPS24400	ABL8DCC12020 ABL8DCC05060 ABL8BBU24200 ABL8RED24400 2x ABL8RED24400			ABL8PRP24100
More information	Please consult our catalogue "Phaseo, Power supplies & Transformers", n° DIA3ED2131105EN		Please consult our catalogue "Phaseo, Power supplies & Transformers", n° DIA3ED2131105EN				

(1) Except ABL8RPM24200. ~ 100...120 V and ~ 200...240 V.

Related products

Modicon M171/M172 logic controllers

Indication and metering

Applications	Current transformers	Basic meters		Basic energy meters	Basic multi-function metering		
	Current sensor: the current value is converted into a 0 to 5 A scale. To be used with ammeter, power meter, energy metering	Display of simple electrical values, volts, or amps Meters for mounting on DIN rails	Display of simple electrical values, volts, or amps Meters for mounting on front panels	Recording and display of energy consumption The meters are mounted on a DIN rail	Simple indication of the current passing through a Compact NSX circuit breaker	Full indication of electrical values and energy metering of a circuit protected by a Compact NSX circuit breaker	Full indication of electrical values and energy metering of a circuit

CT	iVLT iAMP	VLT AMP		iEM2000 iEM2010 iEM2000T	IME1	iEM3000 Series	Micrologic A trip unit	Micrologic E trip unit	PM3200 PM3210 PM3250 PM3255	PM5100 PM5300 PM5500
----	-----------	---------	--	--------------------------------	------	----------------	------------------------	------------------------	--------------------------------------	----------------------------



Description	Current transformers	Voltmeter Ammeter	Voltmeter Ammeter	Kilowatt-hour meters	Kilowatt-hour meters	Kilowatt-hour meters	Ammeter	Power meter	Metering & sub-metering Class 0.5S IEC 62053-22 Class 1 IEC 62053-21 Class 2 IEC 62053-23	Metering & sub-metering Class 0.5S IEC 62053-22 Class 0.2S (PM55●●) IEC 62053-22 Class 1/2 IEC 62053-24	
	Electrical indications	-	I / U	I / U	E		I	I, U, F, P, Q, S, PF, E	I, U, F, P, Q, S, PF, E (Power demand and current demand)	I, U, F, P, Q, S, PF, E (Power demand and current demand)	
Characteristics	Measurement accuracy	Class 0.5 to 3	Class 1.5	Class 1.5	Class 1		Current: Class 1	Current: Class 1 Voltage: 0.5% Power: Class 2	Class 0.5	Class 0.2S (PM55●●) Class 0.5S	
	Installation	On conductor (cable, bar, etc.) Double terminal blocks on type D provide alternative cabling possibility	DIN rail 4 x 18 mm (0.16 X 0.71 in.) modules	Flush-mounted 72 x 72 mm (2.84 x 2.84 in.)/ 96 x 96 mm (3.78 x 3.78 in.)	DIN rail 1.2 or 4 x 18 mm (0.05 or 0.16 x 0.71 in.) modules		Embedded into circuit breaker, remote LCD display available	Embedded into circuit breaker, remote LCD display available	DIN rail	Flush-mounted 96 mm x 96 mm	
	Voltage measurement	Maximum rated operational voltage: 720 V AC	VLT: 500 V AC direct or external VT	VLT: 500 V AC direct or external VT	400 V AC direct				690 V AC	50 V to 330 V AC (Ph-N) 80 V to 570 V AC (Ph-Ph) up to 1 MV AC (ext. VT)	20 V L-N/35 V L-L to 277 V L-N/480 V L-L/ 600 V L-L
	Current measurement	Ranges from 40/5 A to 6,000/5 A	AMP: 30 A direct or external CT	AMP: external CT	40 to 63 A direct or external CT		0.2 x In... 1.2 x In of circuit breaker	0.2 x In... 1.2 x In of circuit breaker	0.2 x In... 1.2 x In of circuit breaker	External CT	External CT
	Communication ports	-	-	-	-		1	1	1	1	2
	I/O	-	-	-	-		-	-	-	-	4 I/O 6 I/O (PM55●●)
	Memory capacity	-	-	-	-		-	-	-	-	256 KB 1.1 MB (PM55●●)

Selector switches for ammeter and voltmeter

• DIN rail/panel mounted 48x48

StruxureWare Power Monitoring Expert

- Real-time data viewing and sharing via smart dashboards
- Intuitive data formats to customize views
- Historical trending of any measurement
- Alarm and event notification and logging
- Comprehensive reporting

Chapter 7

Product reference index



Technical data relating to products listed in this chapter is available online at www.schneider-electric.com

■ Product reference index

□ Index page 7/2

4					
490NTW00002	4/3	TCSEGW13FA0	5/5	TM171APBUS	3/23
	5/4	TCSEK3MDS	5/4		5/3
490NTW00002U	5/4	TCSESU033FN0	5/4	TM171ARS232	3/23
490NTW00005	5/4	TCSESU043F1N0	5/4		5/3
490NTW00005U	5/4	TCSESU053FN0	5/4	TM171ARS485	3/23
490NTW00012	5/4	TCSXCNAMUM3P	4/3		5/3
490NTW00012U	5/4	TM1SH284	3/26	TM171ASCTB14	3/21
490NTW00040	5/4	TM1SH304	3/26	TM171ASCTB27	3/17
490NTW00040U	5/4	TM1SH314	3/26		3/21
490NTW00080	5/4	TM1STNTCRN52015	3/26	TM171ASCTBVEV	3/25
490NTW00080U	5/4	TM1STNTCRN52030	3/26	TM171DGRP	3/17
		TM1STNTCRN52050	3/26		3/19
		TM1STNTCRN61515	3/26	TM171DLCD2U	3/14
		TM1STNTCRN61530	3/26	TM171DLED	3/14
		TM1STNTCRN61550	3/26	TM171DWAL2L	3/14
		TM1STNTCSF44015	3/26	TM171DWAL2U	3/14
		TM1STNTCSF44030	3/26	TM171EO14R	3/21
		TM1STNTCSN62015	3/26	TM171EO15R	3/21
		TM1STNTCSN62030	3/26	TM171EO22R	3/21
		TM1STNTCSN62050	3/26	TM171EP14R	3/21
		TM1STNTCTN62015	3/26	TM171EP27R	3/21
		TM1STNTCTN62030	3/26	TM171OB22R	3/13
		TM1STNTCWN65605	3/26	TM171OBM14R	3/13
		TM1STNTCWN75750	3/26	TM171OBM22R	3/13
		TM1STPTTSN52015	3/26	TM171OD14R	3/13
		TM1STPTTSN52030	3/26	TM171OD22R	3/13
		TM1STPTTSN52050	3/26	TM171ODM14R	3/13
		TM1STPTTSN62015	3/26	TM171ODM22R	3/13
		TM1STPTTSN62030	3/26	TM171ODM22S	3/13
		TM171ABKPB	3/17	TM171OF22R	3/13
		TM171ABKPG	3/17	TM171OFM22R	3/13
		TM171ACAN	3/23	TM171PBM27R	3/17
			5/3	TM171PDM27R	3/17
		TM171ACB4OAO1M	3/15	TM171PDM27S	3/17
			3/21	TM171PFE03	3/17
		TM171ACB4OAO2M	3/15	TM171PFE03HR	3/17
			3/21	TM171SW	4/3
		TM171ACB4OI1M	3/15	TM171VEVA2	3/25
			3/21	TM171VEVD4	3/25
		TM171ACB4OI2M	3/15	TM171VEVM4	3/25
			3/21	TM172AP12PM	3/19
		TM171ACB4OLAN	3/15	TM172ASCTB28	3/19
			3/21	TM172ASCTB42	3/19
		TM171ACB4ORS485	3/15	TM172PBG28R	3/19
		TM171ADMI	4/3	TM172PBG42R	3/19
		TM171AETH	3/23	TM172PDG28R	3/19
			5/3	TM172PDG28S	3/19
		TM171AETHRS485	3/23	TM172PDG42R	3/19
			5/3	TM172PDG42S	3/19
		TM171ALON	3/23	TSXCUSB485	4/3
			5/3		
		TM171AMB	3/23		
			5/3		
		TM171AMFK	4/3		
				V	
				VW3A8306D30	4/3

The Next Generation



www.schneider-electric.com/msx

Schneider Electric Industries SAS

Head Office
35, rue Joseph Monier
F-92500 Rueil-Malmaison
France



www.schneider-electric.com/hvacmachines
www.schneider-electric.com/pumping

The information provided in this documentation contains general descriptions and/or technical characteristics of the performance of the products contained herein. This documentation is not intended as a substitute for and is not to be used for determining suitability or reliability of these products for specific user applications. It is the duty of any such user or integrator to perform the appropriate and complete risk analysis, evaluation and testing of the products with respect to the relevant specific application or use thereof. Neither Schneider Electric nor any of its affiliates or subsidiaries shall be responsible or liable for misuse of the information contained herein.

Design: Schneider Electric
Photos: Schneider Electric

DIA3ED2140905EN