

# PHASEO™ Power Supplies ABL7

Catalog  
April

# 04

Class 8440



## CONTENTS

Description	Page
<b>For ABL7 Power Supplies</b>	
Product Description . . . . .	2-7
Selection . . . . .	8
Specifications and Characteristics . . . . .	9-11
Technical Overview . . . . .	12-16
Dimensions and Wiring Diagrams . . . . .	17-18
<b>For AS-Interface Power Supplies</b>	
Product Description . . . . .	19
Selection . . . . .	19
Specifications and Characteristics . . . . .	20
Technical Overview . . . . .	21
Dimensions and Wiring Diagrams . . . . .	22
Catalog Number Index . . . . .	23



The characteristics to be taken into account when selecting a power supply are:

- the required output voltage and current,
- the supply voltage available in the installation.

An initial selection can be made using the table on page 3. This may however result in several products being selected as suitable. Other selection criteria must therefore be taken into account.

### Power Supply Voltage

The Phaseo™ range is the solution because it guarantees precision within 4% of the output voltage, whatever the load current and input voltage. In addition, the wide input voltage range of Phaseo™ power supplies allows connection to all voltage supplies within the nominal range, without any adjustment. The Phaseo™ **RP** and **CEM** families can also be connected to 110 Vdc and 220 Vdc supply voltages.

### Short Circuit Protection

Phaseo™ power supplies are equipped with an electronic protection device. This protection device resets itself automatically on elimination of the fault, which avoids having to take any action or change a fuse. In addition, the Phaseo™ **ABL7RP / UES / UPS** power supplies allow the user to select the reset mode in the event of a fault:

- in the “AUTO” position, resetting is automatic,
- in the “MANU” position, resetting occurs after elimination of the fault and after switching the supply power off and back on.

This feature allows Phaseo™ **ABL7RP / UES / UPS** power supplies to be used in installations where the risks associated with untimely restarting are significant.

### Phase Failure

In the event of failure of one phase, the 3-phase **ABL7UES / UPS** power supplies switch to relaxation mode for as long as the input voltage is < 450 V. For operation on higher voltages (e.g. 480 V), use of an upstream GV2 type residual current protection device is recommended.

### Electromagnetic Compatibility

Levels of conducted and radiated emissions are defined in standards EN 55011 and EN 55022. The majority of products in the Phaseo™ range have class B certification and can be used without any restrictions, due to their low emissions. **ABL7CEM24003** and **ABL7CEM24006** power supplies have class A certification.







### Power Factor

The current drawn by a power supply is not sinusoidal. This leads to the existence of harmonic currents which pollute the voltage supply.

Regulated switch mode supplies always produce harmonic currents; a filter circuit (Power Factor Correction or PFC) must therefore be added to comply with standard EN 61000-3-2. Phaseo™ **ABL7RP** and **ABL7UES / UPS** power supplies conform to standard EN 61000-3-2 and can therefore be connected directly to public voltage power supplies.

# PHASEO™ Power Supplies

## Product Description

Device type	ABL7CEM	ABL7RM	ABL7RE	ABL7RP	ABL7UES / UPS	ASIABL
						
	Single-phase, regulated switch mode				3-phase regulated switch mode	Regulated switch mode for AS-Interface power supplies
<b>Functions</b>	Supplies for dc control circuits					
<b>Applications</b>	Simple, low power equipment.	Industrial, commercial or residential applications. Modular format allowing integration into panels.	Industrial applications, low and medium power. Machine equipment applications.	Industrial or commercial applications on sites sensitive to supply interference. Protection against accidental restarting.	Industrial applications. In-line continuous process equipment, machine tools, injection presses, etc.	Industrial applications. Supply of dc voltage necessary for AS-Interface systems.
<b>Nominal power</b>	7 to 30 W	22 W   30 W	48 to 240 W	60 to 240 W	120 to 960 W	72 W   145 W   2 x 72 W
<b>Input voltage</b>	100 to 240 Vac single-phase 110 to 220 Vdc compatible (2)	100 to 240 Vac single-phase	100 to 240 Vac single-phase	100 to 240 Vac single phase, 110 to 220 Vdc compatible (1)	3 x 400 to 520 Vac 3-phase	100 to 240 Vac single-phase
<b>Output voltage</b>	24 Vdc adjustable	12 Vdc adjustable   24 Vdc adjustable	24 Vdc adjustable	12, 24 Vdc or 48 V adjustable	24 Vdc adjustable	30 Vdc   24 Vdc adjustable
<b>Technology</b>	Primary switch mode electronic power supplies.					
<b>Secondary protection</b>	Integrated, against overloads and short-circuits, with automatic reset.		Integrated, against overloads and short-circuits, with manual and automatic reset.		Integrated, against overloads and short-circuits, with manual and automatic reset.	Integrated, against overloads and short-circuits, over voltage and under voltage.
<b>Signalling</b>	Output indicator lamp.		Output and input indicator lamp.		Output indicator lamp.	Output and input indicator lamps
<b>Other characteristics</b>	Connection by lug-clamps possible	–	–	Anti-harmonic distortion filter	Anti-harmonic distortion filter	Available with ground fault protection
<b>Mounting</b>	35 mm DIN rail or panel mount	35 mm DIN rail or panel mount	35 mm DIN rail		5 A, 10 A versions - 35 mm DIN rail 20 A, 40 A versions - panel mount	35 mm DIN rail
<b>Conforming to standards</b>	UL508 EN 50081-2, IEC 61000-6-2, EN 60950	UL508 EN 50081-2, IEC 61000-6-2 (EN 50082-2), IEC 60950, EN61131-2 / A11	UL508 EN 50081-2, IEC 61000-6-2, (EN 50082-2), IEC 60950	UL508 EN 50081-2, IEC 61000-6-2, (EN 50082-2), IEC 60950, 61000-3-2	UL508 EN 50081-2, EN 50082-2, EN 60950, IEC 61000-3-2	UL508 EN 50081-2, IEC 61000-6-2, EN 55022 class B
<b>Approvals</b>	cULus, TÜV, CE	UL, CSA, TÜV, CE	UL, CSA, TÜV, CTick, CE		cULus, cCSAus, CE	UL, CSA, TÜV, CE
<b>Pages</b>	4	5	6		7	19

### Selection According to Applications Characteristics

Type of supply	Single-phase	3-phase	
<b>Supply Voltage</b>	100 to 240 Vac 50 / 60 Hz, 110 to 220 Vdc (1) (2), Wide range	3 x 400 to 520 V, 50 / 60 Hz Wide range	
<b>Permissible variation</b>	85 to 264 V, 47 to 63 Hz / 100 to 250 Vdc (1), 105 to 370 Vdc (2)	340 to 550 V / 47 to 63 Hz	
<b>Output voltage</b>	12 V   48 V   24 V   24 V	24 V	
<b>Output current</b>	0.3 A	ABL7CEM24003	
	0.6 A	ABL7CEM24006	
	1.2 A	ABL7CEM24012	
	1.3 A	ABL7RM2401	
	1.9 A	ABL7RM1202	
	2 A		ABL7RE2402
	3 A	ABL7RP4803	ABL7RP2403   ABL7RE2403
	5 A	ABL7RP1205	ABL7RP2405   ABL7RE2405
	10 A		ABL7RP2410   ABL7RE2410
20 A			
40 A		ABL7UPS24400	
<b>Compliance with EN61000-3-2</b>	Yes (not applicable for ABL7CEM, and ABL7RM)	No	Yes
<b>Integrated automatic protection</b>	Yes Automatic or manual restart on ABL7RP Automatic restart only on ABL7CEM and ABL7RM	Yes Automatic restart	Yes Automatic or manual restart

(1) Vdc values for ABL7RP power supplies, not indicated on the product.

(2) Vdc values for ABL7CEM power supplies, not indicated on the product.

## **ABL7 POWER SUPPLIES**

The ABL7 range of power supplies is designed to provide the dc voltage necessary for the control circuits of automation system equipment. Split into four families, this range meets all the needs encountered in industrial, commercial and residential applications. Single-phase or 3-phase, of the electronic switch mode type, they provide a quality of output which is suitable for the loads supplied and compatible with the power supply available in the equipment. Protection devices are often used with these power supplies for total safety.

### **Phaseo™ Switch Mode Power Supplies**

These switch mode power supplies are totally electronic and regulated. The use of electronics makes it possible to significantly improve the performance of these power supplies which offer:

- compact size
- integrated overload, short-circuit, over voltage and under voltage protection
- a very wide range of permissible input voltages, without any adjustment
- a high degree of output voltage stability
- good performance
- LED indicators on the front panel

Phaseo™ power supplies are available in single-phase and 3-phase versions. They deliver a voltage which is precise to  $\leq 4\%$ , whatever the load and type of power supply, within a range of 85 to 264 V for single-phase, or 340 to 550 V for 3-phase. Conforming to IEC standards and UL and CSA certifications, they are suitable for universal use. The inclusion of overload and short-circuit protection makes downstream protection unnecessary if discrimination is not required.

### **ABL7CEM Compact Switch Mode Power Supplies**



The **ABL7CEM** single phase regulated switching power supplies are designed to provide the dc voltage necessary for most simple circuits. These power supplies are totally electronic and regulated. The use of electronics makes it possible to significantly improve the performance of these power supplies. They provide:

- Compact size
- Integrated overload, short circuit and over voltage protection
- A wide range of permitted input voltages, (100–240 Vac, 110–220 Vdc) without any adjustment
- A high degree of output voltage stability ( $\pm 2\%$  max)
- 3 versions from 0.3 A (7 w) to 1.2 A (30 w)
- All versions are 1.77" (45 mm) wide
- Output voltage adjustable from 90–110% of the nominal 24 Vdc (21.6–26.4 Vdc)
- Designed to accept stranded or solid wire and forked or ring tongued connectors
- LED indicating presence of the DC output voltage
- These power supplies can be either 35 mm DIN rail or panel mounted
- Designed for use in an indoor enclosure
- Large screw heads for easier wiring

These power supplies, which are accurate to within  $\pm 2\%$  regardless of the load or the type of supply voltage, within the range of 85–264 Vac. The inclusion of overload and short circuit protection makes downstream protection unnecessary in most applications. All products have an output voltage adjustment potentiometer (21.6–26.4 %) which allows for compensation of any line voltage drop in installations with long runs.

The **ABL7CEM** products are excellent for typical automation, low power applications.

The **ABL7CEM** products are suitable for use in automation system environments based on the Nano and Twido PLCs or in any automation system configuration requiring a 24 Vdc supply.

## ABL7RM Modular Switch Mode Power Supplies



The **ABL7RM** modular regulated switching power supplies are designed to provide the dc voltage necessary for equipment control circuits and meet the needs encountered in industrial, commercial, and residential applications. These single-phase, modular, electronic switching power supplies provide a quality of output current which is suitable for the loads supplied and compatible with the Zelio logic relays. Clear guidelines are given on selecting the upstream protection devices (see page 15) which are often used with them, thus providing a comprehensive solution.

Switching power supplies are totally electronic and regulated. The use of electronics makes it possible to significantly improve the performance of these power supplies, which offer:

- Compact size
- Integrated overload, short-circuit, over voltage and under voltage protection
- A very wide range of permitted input voltages (100–240 Vac), without any adjustment
- A high degree of output voltage stability
- Good performance
- Considerably reduced weight (0.40 lb.)
- A modular format allowing incorporation into control panels

These Phaseo™ power supplies deliver a voltage which is accurate within  $\pm 3$  or 4% depending on voltage, regardless of load and supply voltage, within a supply voltage range of 85–264 Vac. They are suitable for general use, are UL listed and CSA certified, and conform to IEC standards. The inclusion of overload and short-circuit protection makes downstream protection unnecessary if discrimination is not required.

The power supplies are equipped with an output voltage adjustment potentiometer allowing you to compensate for any line voltage drops in installations with long cable runs.

- 12 Vdc device 12–14.4 Vdc
- 24 Vdc device 24–28.8 Vdc

These power supplies are designed for direct mounting on 35 mm and 75 mm  $\bar{D}$  DIN rail, or direct panel mounting by means of retractable mounting feet.

There are two single-phase power supplies available:

- **ABL7RM2401** (24 Vdc/1.3 A)
- **ABL7RM1202** (12 Vdc/1.9 A)

### Description

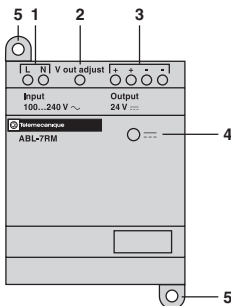

1. 2.5 mm<sup>2</sup> screw terminal for connection of the incoming ac supply voltage.
2. Output voltage adjustment potentiometer.
3. 2.5 mm<sup>2</sup> screw terminal for connection of the output voltage.
4. LED indicating presence of the dc output voltage.
5. Retractable mounting feet.

**ABL7RE and ABL7RP Single Phase Switch Mode Power Supplies**



The **ABL7RE** and **ABL7RP** single phase regulated switching power supplies are designed to provide the dc voltage necessary for most control system circuits. These power supplies are totally electronic and regulated. The use of electronics makes it possible to significantly improve the performance of these power supplies. They provide:

- Compact size
- Integrated overload, short circuit, over voltage and under voltage protection
- A wide range of permitted input voltages (100–240 Vac), without any adjustment
- A high degree of output voltage stability
- Good performance
- Considerably reduced weight in comparison to competition 1.15–4.85 lb. (0.52–2.19 kg)

These power supplies, which are accurate to within  $\pm 3\%$  regardless of the load or the type of supply voltage, within the range of 85–264 Vac. The inclusion of overload and short circuit protection makes downstream protection unnecessary in most applications. They have an output under voltage control which will cause the power supply to trip if the output voltage of a 24 Vdc supply drops below 19 Vdc, to ensure that the voltage is always usable by the devices being supplied. All products have an output voltage adjustment potentiometer (24 to 28.8 V on a 24 Vdc supply) which allows for compensation of any line voltage drop in installations with long runs.

The **ABL7RE** products are excellent for typical industrial applications.

The **ABL7RP** products are for general purpose applications. These supplies have an input filter (Power Factor Correction or PFC) which allows them to be used in commercial environments. They have 2 operating modes:

“**AUTO**” mode which automatically restarts as soon as the fault is cleared.

“**MANU**” mode which requires the power supply to be reset before restarting is possible. Resetting is achieved by switching off the supply voltage and reapplying it.

**Harmonics (Power Factor)** – The current drawn by a power supply is non-sinusoidal. This leads to the existence of harmonic currents which pollute the main supply. European standard EN 61000-3-2 limits the harmonic currents produced by power supplies. This standard covers all devices of more the 75 W, drawing up to 16 A per phase, and connected directly to the utilities. Devices connected downstream of a private, low voltage, general transformer are excluded. However, switching power supplies produce harmonic current. Therefore, a filter circuit (PFC) must be added to the circuit when using an **ABL7RE** power supply to comply with standard EN 61000-3-2. The **ABL7RP** power supplies also conform to the EN 61000-3-2 standard and can be connected directly to the public power supply system.

**Input LED**—When illuminated, this LED indicates the supply voltage is present.

**Output LED**—This LED indicates if a fault has occurred.

Steady: normal voltage out

Flashing: overload or short circuit

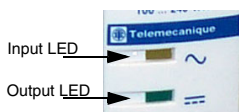



## ABL7UES AND ABL7UPS Three Phase Switch Mode Power Supplies

The **ABL7UES / UPS** three phase regulated switching power supplies are designed to provide the dc voltage necessary for most control system circuits. These power supplies are totally electronic and regulated. The use of electronics makes it possible to significantly improve the performance of these power supplies. They provide:

- Compact size
- Integrated overload, short circuit, over voltage and under voltage protection
- A wide range of permitted input voltages (400–520 Vac), without any adjustment
- A high degree of output voltage stability
- Good performance
- Considerably reduced weight in comparison to competition 2.87–9.92 lb. (1.3–4.5 kg)

These power supplies, which are accurate to within  $\pm 1\%$  regardless of the load or the type of supply voltage, within the range of 3 x 400 to 520 Vac with power between 120 W (5 A) and 960 W (40 A). The inclusion of overload and short circuit protection makes downstream protection unnecessary in most applications. They have an output under voltage control which will cause the power supply to trip if the output voltage of a 24 Vdc supply drops below 19 Vdc, to ensure that the voltage is always usable by the devices being supplied. All products have an output voltage adjustment potentiometer (24 to 27.8 V) which allows for compensation of any line voltage drop in installations with long runs.

The **ABL7UES / UPS** products are excellent for typical industrial applications. These supplies have an input filter (Power Factor Correction or PFC) which allows them to be used in commercial environments. They have 2 operating modes:

“**AUTO**” mode which automatically restarts as soon as the fault is cleared.

“**MANU**” mode which requires the power supply to be reset before restarting is possible. Resetting is achieved by switching off the supply voltage and reapplying it.

The **ABL7UES / UPS** products are suitable for use in automation system environments based on the Premium and Quantum PLCs or in any automation system configuration requiring a 24 Vdc supply. They can be used in industrial applications, for all in-line or continuous process equipment, machine tools, and injection presses, etc.



# PHASEO™ Power Supplies Selection



**ABL7RM**

Input Voltage 47 to 63 Hz	Output voltage	Nominal power	Nominal current	Automatic protection reset	Conforms to standard EN 61000-3-2	Catalog Number	Weight lb. (kg)
------------------------------	-------------------	------------------	--------------------	-------------------------------	--------------------------------------	-------------------	--------------------

## Single-phase Modular Regulated Switching Power Supplies ABL7RM

100 to 240 Vac single-phase wide range	12 Vdc	22 W	1.9 A	auto	no	<b>ABL7RM1202</b>	0.4 (0.18)
	24 Vdc	30 W	1.3 A	auto	no	<b>ABL7RM2401</b>	0.4 (0.18)



**ABL7CEM**

## Single-phase Regulated Switch Mode Power Supplies ABL7CEM

100 to 240 Vac single-phase wide range 110 to 220 Vdc (1)	24 Vdc	7 W	0.3 A	auto	no	<b>ABL7CEM24003</b>	0.33 (0.15)
		15 W	0.6 A	auto	no	<b>ABL7CEM24006</b>	0.40 (0.18)
		30 W	1.2 A	auto	no	<b>ABL7CEM24012</b>	0.49 (0.22)



**ABL7RE2405**  
**ABL7RP2405**  
**ABL7RP4803**

## Single-phase Regulated Switch Mode Power Supplies ABL7RE

100 to 240 Vac single-phase wide range	24 Vdc	48 W	2 A	auto	no	<b>ABL7RE2402</b>	1.15 (0.52)
		72 W	3 A	auto	no	<b>ABL7RE2403</b>	1.15 (0.52)
		120 W	5 A	auto	no	<b>ABL7RE2405</b>	2.20 (1.00)
		240 W	10 A	auto	no	<b>ABL7RE2410</b>	4.85 (2.20)

## Single-phase Regulated Switch Mode Power Supplies ABL7RP

100 to 240 Vac single-phase wide range 110 to 220 Vdc (1)	12 Vdc	60 W	5 A	auto/man	yes	<b>ABL7RP1205</b>	2.20 (1.00)
		72 W	3 A	auto/man	yes	<b>ABL7RP2403</b>	1.15 (0.52)
	24 Vdc	120 W	5 A	auto/man	yes	<b>ABL7RP2405</b>	2.20 (1.00)
		240 W	10 A	auto/man	yes	<b>ABL7RP2410</b>	4.85 (2.20)
	48 Vdc	144 W	3 A	auto/man	yes	<b>ABL7RP4803</b>	2.20 (1.00)



**ABL7UPS24200**

## 3-phase Regulated Switch Mode Power Supplies ABL7UES / UPS

3 x 400 to 520 Vac	24 Vdc	120 W	5 A	auto/man	yes	<b>ABL7UES24050</b>	2.87 (1.30)
		240 W	10 A	auto/man	yes	<b>ABL7UPS24100</b>	2.87 (1.30)
		480 W	20 A	auto/man	yes	<b>ABL7UPS24200</b>	5.07 (2.30)
		960 W	40 A	auto/man	yes	<b>ABL7UPS24400</b>	9.92 (4.50)

(1) Compatible Vdc input voltage not indicated on the product.

### ABL7RM

E164866 NRAQ  
E164866 NRAQ7

203359 5311 05

### ABL7CEM

E164867 NMTR  
E164867 NMTR7

### ABL7RE, RP

E164867 NMTR

204701 5311 03

### ABL7UES, UPS

E164353 NKCR  
E164353 NKCR7

1467190 5311 06  
1467190 5311 86

All have:



All except ABL7UES / UPS are  
SEMI F47 Compliant and





# PHASEO™ Power Supplies Specifications and Characteristics

## Specifications

<b>Catalog Number</b>	<b>ABL7RM1202</b>	<b>ABL7RM2401</b>
<b>Approvals</b>	cULus, CSA, TÜV, CE	
<b>Conforming to Standards</b>	UL508, CSA 22.2 N° 950	
Safety	IEC / EN 60950 - IEC / EN 61131-2 / A11	
EMC	EN 50081-2, IEC 61000-6-2 (EN 50082-2)	

## Input Circuit

<b>Rated values</b>	100 to 240 Vac	
<b>Permissible values</b>	85 to 264 Vac	
<b>Permissible frequencies</b>	47 to 63 Hz	
<b>Efficiency at nominal load</b>	> 80 %	
<b>Current consumption</b>	0.57 A @ 120 V / 0.37 A @ 240 V	0.74 A @ 120 V / 0.45 A @ 240 V
<b>Current (inrush)</b>	< 20 A	
<b>Power factor</b>	0.6	0.98

## Output Circuit

<b>LED indication</b>	Green LED	
<b>Nominal output voltage</b>	12 Vdc	24 Vdc
<b>Nominal output current</b>	1.9 A	1.3 A

## Precision

Output voltage	Adjustable, from 100 to 120 %	
Line and load regulation	± 4 %	± 3 %
Residual ripple - interference	< 200 mV	< 250 mV

## Micro-breaks

Holding time at I max and Ve min	> 10 ms
----------------------------------	---------

## Protection

Short-circuit	Permanent / thermal protection	
Overcurrent, cold-state	< 1.7 A	< 1.6 A
Undervoltage	< 10.5 V	< 19 V

## Characteristics

### Connections

Input	1 - #14 AWG (1 x 2.5 mm <sup>2</sup> ) or 2 - #16 AWG (2 x 1.5 mm <sup>2</sup> ) screw terminals
Output	1 - #14 AWG (1 x 2.5 mm <sup>2</sup> ) or 2 - #16 AWG (2 x 1.5 mm <sup>2</sup> ) screw terminals

<b>Tightening torque</b>	5.4 lb-in (0.6 N•m)
--------------------------	---------------------

### Environment

Storage Temperature	-13 to 158 °F (-25 to +70 °C)
Operating Temperature	-13 to 131 °F (-25 to +55 °C)
Maximum Relative Humidity	95%
Degree of Protection	IP20 conforming to IEC 60529
Vibrations	Conforming to EN 61131-2, IEC 60068-2-6 test Fc

<b>Operating position</b>	Vertical
---------------------------	----------

### Connections

Serial	Not Possible
Parallel	Possible (same references)

### Dielectric strength

Input / output	3000 V / 50 / 60 Hz / 1 min.
----------------	------------------------------

<b>Protection class conforming to VDE 0106 1</b>	Class II without ground terminal (double insulated)
--	---

<b>Input fuse incorporated</b>	Yes (internal, not replaceable)
--------------------------------	---------------------------------

<b>Emissions</b>	EN 50081-2 (Generic)
------------------	----------------------

Conducted / radiated	EN 55011 / EN 55022 cl.B
----------------------	--------------------------

<b>Immunity</b>	IEC 61000-6-2 (Generic)
-----------------	-------------------------

Electrostatic Discharge	EN 61000-4-2 (4 kV contact / 8 kV air)
-------------------------	--

Electromagnetic	EN 61000-4-3 level 3 (10 V / m)
-----------------	---------------------------------

Conducted Interference	EN 61000-4-4 level 3 (2 kV), EN 61000-4-6 (10 V)
------------------------	--

Supply Interference	EN 1000-4-11
---------------------	--------------

# PHASEO™ Power Supplies Specifications and Characteristics

## Specifications

Catalog Number	ABL7CEM	ABL7RE	ABL7RP
Approvals	cULus, TÜV, CE	UL, CSA, TÜV, CTick, CE	UL, CSA, TÜV, CTick, CE
Conforming to standards	UL 508	UL 508, CSA 22.2 n° 950	UL 508, CSA 22.2 n° 950
Safety	IEC / EN 60950		
EMC	EN 50081-2, EN 50082-2	EN 50081-2, IEC 61000-6-2 (EN 50082-2)	
Low frequency harmonic currents	No	No	EN 61000-3-2

## Input Circuit

LED indication	None	Orange LED	Orange LED
<b>Input voltages</b>			
Rated values	100 to 240 Vac, 110 to 220 Vdc compatible (1)	100 to 240 Vac	100 to 240 Vac, 110 to 220 Vdc compatible (1)
Permissible values	85 to 264 Vac, 105 to 370 Vdc compatible (1)	85 to 264 Vac single-phase	85 to 264 Vac, 100 to 250 Vdc compatible (1)
Permissible frequencies	47 to 63 Hz		
Efficiency at nominal load	> 70 %		> 85 %
Current consumption	Ue = 240 V	0.1 A (7 W) / 0.2 A (15 W) / 0.45 A (30 W)	0.7 A (48 W) / 0.9 A (72 W) / 1.4 A (120 W) / 2.5 A (240 W)
	Ue = 120 V	0.15 A (7 W) / 0.26 A (15 W) / 0.59 A (30 W)	1.13 A (48 W) / 1.57 A (72 W) / 2.44 A (120 W) / 4.35 A (240 W)
Current at switch-on	< 50 A		
Power factor	0.45 approx.	0.65 approx.	0.98 approx.

## Output Circuit

LED indication	Green LED	Green LED	Green LED
Nominal output voltage (U out)	24 Vdc		12, 24 and 48 Vdc
Nominal output current	0.3 A / 0.6 A / 1.2 A	2 A / 3 A / 5 A / 10 A	3 A / 5 A / 10 A
Output voltage	Adjustable, from 90 to 110 %		
Line and load regulation	2 % max.	± 3 %	
Residual ripple - interference	< 200 mV (peak-peak)		
<b>Micro-breaks</b>			
Holding time at I max and Ve min.	> 20 ms	> 10 ms	> 20 ms
Temporary overloads	Permissible inrush current (U out > 19 V) (See curves page 16)		
Short-circuit protection	Permanent / automatic restart	Permanent / automatic restart	Permanent / automatic restart or manual restart on product
Overload protection	1.05 In	1.1 In	
Overvoltage protection	U > 1.2	Tripping if U > 1.5 Un	
Undervoltage protection	-	Tripping if U < 0.8 Un	

## Characteristics

Input connection	2 - #14 AWG (2 x 2.5 mm <sup>2</sup> ) + ground		
Output connection	2 - #14 AWG (2 x 2.5 mm <sup>2</sup> )	2 - #14 AWG (2 x 2.5 mm <sup>2</sup> ) + ground, multiple output, depending on model	
Tightening torque	7.0 lb-in (0.8 N•m)	5.4 lb-in (0.6 N•m)	
Storage temperature	- 13 to + 158 °F (- 25 to + 70 °C)		
Operating temperature	14 to + 140 °F (- 10 to + 60 °C) derating as from 122 °F (50 °C), mounted vertically	- 32 to + 140 °F (0 to + 60 °C) derating as from 122 °F (50 °C), mounted vertically	
Maximum relative humidity	20 to 90 %	95 % without condensation or dripping water	
Degree of protection	IP 20 conforming to IEC 60529		
Vibrations	Conforming to EN 61131-2		
Operating position	Vertical and horizontal (see p. 13)	Vertical	
MTBF at 40 °	> 100 000 h		
Series connection	Possible		
Parallel connection	No	Possible - maximum temperature 122 °F (50 °C)	
<b>Dielectric strength</b>			
Input / output	3000 V / 50 Hz 1 min.	3000 V / 50 Hz 1 min.	
Input / ground	2000 V / 50 Hz 1 min.	3000 V / 50 Hz 1 min.	
Output / ground (and output / output)	500 V / 50 Hz 1 min.	500 V / 50 Hz 1 min.	
Input fuse incorporated	Yes (internal, not replaceable)		
<b>Emissions</b>			
Conducted	EN 55011 / EN 55022 cl.A (7 & 15 W) EN 55011 / EN 55022 cl.B (30 W)	EN 55011 / EN 55022 cl.B	
Radiated	EN 55011 / EN 55022 cl.B		
<b>Immunity</b>			
Electrostatic discharge	EN 61000-4-2 (4 kV contact / 8 kV air)		
Electromagnetic	EN 61000-4-3 level 3 (10 V / m)		
Conducted interference	EN 61000-4-4 level 3 (2 kV), EN 61000-4-5, EN 61000-4-6 level 3, EN 61000-4-8 level 4.		
Supply interference	EN 1000-4-11 (Voltage drops and cuts)		

(1) Vdc compatible input voltage, not indicated on the product.

# PHASEO™ Power Supplies Specifications and Characteristics

## Specifications

<b>Catalog Number</b>	ABL7UES24050, ABL7UPS24●
<b>Approvals</b>	cULus, cCSAus, CE
<b>Conforming to standards</b>	UL508
Safety	EN 60950, FELV
EMC	EN 50081-1, EN 50082-2
Low frequency harmonic currents	EN 61000-3-2

## Input Circuit

<b>LED indication</b>	None
<b>Input voltages</b>	
Rated values	3 x 400 to 520 Vac
Permissible values	3 x 340 to 550 Vac
Permissible frequencies	50 to 60 Hz
Efficiency at nominal load	> 90 %
Current consumption (U <sub>e</sub> = 400 V)	0.33 A @ 120 W / 0.65 A @ 240 W / 1.2 A @ 480 W / 1.7 A @ 960 W
Current at switch-on	< 15 A
Power factor	0.7 @ 120 W / 0.7 / 0.9 @ 960 W
<b>2-phase operating mode</b>	Relaxation if input voltage < 450 Vac

## Output Circuit

<b>LED indication</b>	Green LED
<b>Nominal output voltage (U out)</b>	24 Vdc
<b>Nominal output current</b>	5 / 10 / 20 / 40 A
<b>Output voltage</b>	Adjustable 100 to 116 %
<b>Line and load regulation</b>	1 % max.
<b>Residual ripple - interference</b>	< 200 mV (peak-peak)
<b>Micro-breaks</b>	
Holding time at I max and V <sub>e</sub> min.	between 8 and 13 ms
<b>Temporary overloads</b>	
Permissible inrush current (U out > 19 V)	See curves, page 16
<b>Short-circuit protection</b>	Permanent / automatic or normal restart
<b>Overload protection</b>	1.05 I <sub>n</sub> < 50 ms
<b>Overvoltage protection</b>	28.5 V typical
<b>Undervoltage protection</b>	19 V typical

## Characteristics

<b>Input connection</b>	2 - #16-14 AWG (2 x 1.5 to 2.5 mm <sup>2</sup> ) + ground
<b>Output connection</b>	
UES24050, UPS24100	2 - #16-14 AWG (2 x 1.5 to 2.5 mm <sup>2</sup> )
UPS24200	2 - #12-10 AWG (2 x 4 to 6 mm <sup>2</sup> )
UPS24400	2 - #12-8 AWG (2 x 4 to 10 mm <sup>2</sup> )
<b>Tightening torque</b>	
UES24050, UPS24100	Input: 5.4 lb-in (0.6 N•m) / Output: 4.5 lb-in (0.5 N•m)
UPS24200	Input: 5.4 lb-in (0.6 N•m) / Output: 5.4 lb-in (0.6 N•m)
UPS24400	Input: 5.4 lb-in (0.6 N•m) / Output: 10.8 lb-in (1.2 N•m)
<b>Ambient conditions</b>	
Storage temperature	-13 to + 158 °F (- 25 to + 70 °C)
Operating temperature	32 to + 140 °F (0 to + 60 °C)
Humidity relative maximal	30 to 90 %
Degree of protection	IP 20
Vibrations	Conforming to EN 61131-2
<b>Operating position</b>	Vertical
<b>MTBF</b>	> 100 000 h
<b>Series connection</b>	Possible - 2 power supplies max.
<b>Parallel connection</b>	Possible - 2 power supplies max.
<b>Dielectric strength</b>	
Input / output	3750 V / 50 and 60 Hz 1 mn
Input / ground	3500 V / 50 and 60 Hz 1 mn
Output / ground (and output / output)	500 V / 50 and 60 Hz 1 mn
<b>Input fuse incorporated</b>	No
<b>Emissions</b>	
Conducted / radiated	EN 55011 / EN 5022 - Class B
<b>Immunity</b>	
Electrostatic discharge	EN 61000-4-2 (4 kV contact / 8 kV air)
Electromagnetic	EN 61000-4-3 level 3 (10 V / m)
Conducted interference	EN 61000-4-4 level 3 (2 kV), EN 61000-4-5, EN 61000-4-6 level 3, EN 61000-4-8 level 4
Supply interference	EN 61000-4-11 (Voltage drops and cuts)

### **DERATING ABL7RM POWER SUPPLIES**

The ambient temperature is a determining factor which limits the power that an electronic power supply can deliver continuously. If the temperature around the electronic components is too high, their life will be significantly reduced. Conversely, a power supply can deliver more than its rated power if the ambient temperature remains well below the nominal operating temperature.

The maximum ambient temperature for Phaseo™ power supplies is 131 °F (55 °C). Below this temperature, it is possible to receive up to 110 % of the nominal power.

The graph below shows the power (in relation to the nominal power) which the power supply can deliver continuously, according to the ambient temperature.

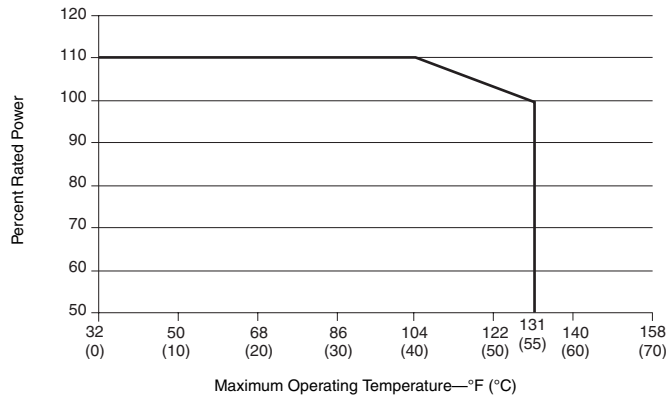

Derating should also be considered in the following extreme operating conditions:

- Intensive operation (output current permanently close to the nominal current, combined with a high ambient temperature)
- output voltage set above 24 V (to compensate for line voltage drops, for example)
- parallel connection to increase the total power

**DERATING ABL7CEM, RE, RP, UES, AND UPS**

The ambient temperature is a determining factor which limits the power that an electronic power supply can deliver continuously. A temperature which is too high around the electronic components significantly reduces their life. However, if the ambient temperature remains largely below the rated operating temperature, then a power supply can deliver more than its nominal power.

The rated ambient temperature for Phaseo™ power supplies is 122 °F (50 °C). Above 122 °F (50 °C), a derating is necessary up to a maximum temperature of 140 °F (60 °C).

The graph below shows the power (in relation to the nominal power) which the power supply unit can deliver continuously, according to the ambient temperature.

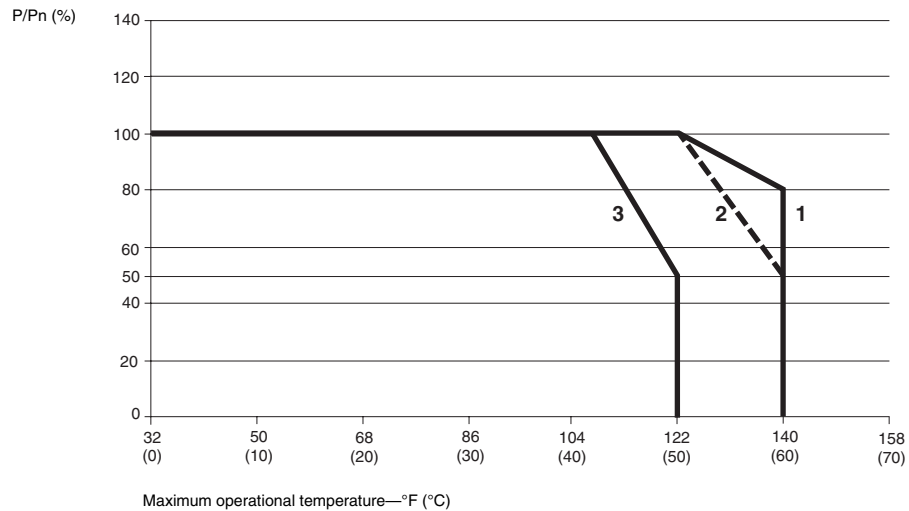

1. ABL7RE, ABL7RP, ABL7UES, ABL7UPS vertical mounting
2. ABL7CEM vertical mounting
3. ABL7CEM horizontal mounting

Derating should be considered in the following extreme operating conditions:

- intensive operation (output current permanently close to the nominal current, combined with a high ambient temperature),
- output voltage set above 24 V (to compensate for line voltage drops, for example),
- parallel connection to increase the total power.

**General rules to be followed**

<b>Intensive operation</b>	See derating information on the graph above. Example for ABL7RE: - without derating, from 32 °F to 122 °F (0 °C to 50 °C), - derating of nominal current by 2 % per additional °C, up to 140 °F (60 °C).
<b>Rise in output voltage</b>	The nominal power is fixed. Increasing the output voltage means that the current delivered must be reduced.
<b>Parallel connection to increase the power (except ABL7CEM)</b>	The total power is equal to the sum of the powers of the power supplies used, but the maximum ambient temperature for operation is 122 °F (50 °C) To improve heat dissipation, the power supplies must not be in contact with each other.

In all cases, there must be adequate convection around the products to ensure proper cooling.

	Required Clearances	
	Above and Below	On Both Sides
ABL7CEM	–	0.39 (10 mm)
ABL7RE, RP	1.96 (50 mm)	0.59 (15 mm)
ABL7UES / UPS	3.93 (100 mm)	3.93 (100 mm)

### **USING 24 Vdc**

- Using 24 Vdc enables so-called protection installations (PELV) to be built. Using PELV is a measure designed to protect people from direct and indirect contact. Measures relating to these installations are defined in publication NF C 12-201 and in standard IEC 60364-4-41.
- The application of these measures to the electrical equipment in machines is defined in standard NF EN 60204-1 and requires:
  - the voltage used is below 60 Vdc in dry environments and below 30 V in damp environments,
  - the connection of one side of the PELV circuit, or one point of the source, to the equipotential protection circuit associated with higher voltages.
  - the use of switchgear and control gear on which measures have been taken to ensure “safety separation” between power circuits and control circuits.
- A safety separation is necessary between power circuits and control circuits in PELV circuits. Its aim is to warn of the appearance of dangerous voltages in 24 Vdc safety circuits.
- The reference standards involved are:
  - IEC 61558-2-6 and EN 61558-2-6 (safety transformers),
  - IEC 60664 (coordination of isolation).Telemecanique power supplies meet these requirements.
- Moreover, to ensure that these products will operate correctly in relation to the demands of their reinforced isolation, it is recommended that they be mounted and wired as indicated below:
  - they should be placed on a grounded mounting plate or rail,
  - they should be connected using flexible wires, with a maximum of two wires per connection, and tightened to the nominal torque,
  - conductors of the correct insulation class must be used.
- If the dc circuit is not connected to an equipotential protection conductor, an ground leakage detector will indicate any accidental insulation faults.

### **OPERATING VOLTAGE**

- The permissible tolerances for the operating voltage are listed in publications IEC 61131-2 and DIN 19240.
- For nominal voltage  $U_n = 24 \text{ Vdc}$ , the extreme operating values are from - 15 % to + 20 % of  $U_n$ , whatever the supply fluctuations in the range - 10 % to + 6 % (defined by standard IEC 60038) and load variations in the range 0–100 % of  $I_n$ . All Telemecanique 24 Vdc power supplies are designed to provide a voltage within this range.
- It may be necessary to use a voltage measurement relay to detect when the normal voltage limits are being surpassed and to deal with the consequences of this.

**PROTECTION DEVICES**

**For ABL7CEM, ABL7RE, ABL7RP, AND ABL7RM**

For Use With	120 Vac Single-phase					240 Vac Single-phase				
	Input Current	Poles	Thermal-Magnetic Circuit-Protector		gG Fuse	Input Current	Poles	Thermal-Magnetic Circuit-Protector		gG Fuse
			GB2	C60N				GB2	C60N	
ABL7CEM24003	0.15 A	1	GB2CB05 (0.5 A)	MG17421 (0.5 A)	1 A	0.1 A	1	GB2CB05 (0.5 A)	MG17421 (0.5 A)	1 A
		2	GB2CD05 (0.5 A)	MG24516 (1.0 A)				GB2CD05 (0.5 A)	MG24516 (1.0 A)	
ABL7CEM24006	0.26 A	1	GB2CB05 (0.5 A)	MG17421 (0.5 A)	1 A	0.2 A	1	GB2CB05 (0.5 A)	MG17421 (0.5 A)	1 A
		2	GB2CD05 (0.5 A)	MG24516 (1.0 A)				GB2CD05 (0.5 A)	MG24516 (1.0 A)	
ABL7CEM24012	0.59 A	1	GB2CB06 (1.0 A)	MG24500 (1.0 A)	1 A	0.45 A	1	GB2CB06 (1.0 A)	MG24500 (1.0 A)	1 A
		2	GB2CD06 (1.0 A)	MG24516 (1.0 A)				GB2CD06 (1.0 A)	MG24516 (1.0 A)	
ABL7RE2402	1.13 A	1	GB2CB07 (2.0 A)	MG24501 (2.0 A)	2 A	0.7 A	1	GB2CB06 (1.0 A)	MG24500 (1.0 A)	1 A
		2	GB2CD07 (2.0 A)	MG24517 (2.0 A)				GB2CD06 (1.0 A)	MG24516 (1.0 A)	
ABL7RE2403	1.57 A	1	GB2CB07 (2.0 A)	MG24501 (2.0 A)	2 A	0.90 A	1	GB2CB06 (1.0 A)	MG24500 (1.0 A)	1 A
		2	GB2CD07 (2.0 A)	MG24517 (2.0 A)				GB2CD06 (1.0 A)	MG24516 (1.0 A)	
ABL7RE2405	2.44 A	1	GB2CB08 (3.0 A)	MG24502 (3.0 A)	4 A	1.4 A	1	GB2CB07 (2.0 A)	MG24501 (2.0 A)	2 A
		2	GB2CD08 (3.0 A)	MG24517 (3.0 A)				GB2CD07 (2.0 A)	MG24517 (2.0 A)	
ABL7RE2410	4.35 A	1	GB2CB12 (6.0 A)	MG24504 (6.0 A)	6 A	2.5 A	1	GB2CB08 (3.0 A)	MG24502 (3.0 A)	4 A
		2	GB2CD12 (6.0 A)	MG24520 (6.0 A)				GB2CD08 (3.0 A)	MG24517 (3.0 A)	
ABL7RP1205	0.78 A	1	GB2CB06 (1.0 A)	MG24500 (1.0 A)	2 A	0.5 A	1	GB2CB06 (1.0 A)	MG24500 (1.0 A)	1 A
		2	GB2CD06 (1.0 A)	MG24516 (1.0 A)				GB2CD06 (1.0 A)	MG24516 (1.0 A)	
ABL7RP2403	0.87 A	1	GB2CB07 (2.0 A)	MG24501 (2.0 A)	2 A	0.5 A	1	GB2CB06 (1.0 A)	MG24500 (1.0 A)	1 A
		2	GB2CD07 (2.0 A)	MG24517 (2.0 A)				GB2CD06 (1.0 A)	MG24516 (1.0 A)	
ABL7RP2405	1.39 A	1	GB2CB07 (2.0 A)	MG24501 (2.0 A)	2 A	0.7 A	1	GB2CB06 (1.0 A)	MG24500 (1.0 A)	1 A
		2	GB2CD07 (2.0 A)	MG24517 (2.0 A)				GB2CD06 (1.0 A)	MG24516 (1.0 A)	
ABL7RP2410	2.78 A	1	GB2CB09 (4.0 A)	MG24503 (4.0 A)	4 A	1.4 A	1	GB2CB07 (2.0 A)	MG24501 (2.0 A)	2 A
		2	GB2CD09 (4.0 A)	MG24519 (4.0 A)				GB2CD07 (2.0 A)	MG24517 (2.0 A)	
ABL7RP4803	1.39 A	1	GB2CB07 (2.0 A)	MG24501 (2.0 A)	2 A	0.7 A	1	GB2CB06 (1.0 A)	MG24500 (1.0 A)	1 A
		2	GB2CD07 (2.0 A)	MG24517 (2.0 A)				GB2CD06 (1.0 A)	MG24516 (1.0 A)	
ABL7RM1202	0.57 A	1	GB2CB06 (1.0 A)	MG24500 (1.0 A)	1 A	0.37 A	1	GB2CB05 (0.5 A)	MG17421 (0.5 A)	1 A
		2	GB2CD06 (1.0 A)	MG24516 (1.0 A)				GB2CD05 (0.5 A)	MG24516 (1.0 A)	
ABL7RM2401	0.74 A	1	GB2CB06 (1.0 A)	MG24500 (1.0 A)	1 A	0.45 A	1	GB2CB06 (1.0 A)	MG24500 (1.0 A)	1 A
		2	GB2CD06 (1.0 A)	MG24516 (1.0 A)				GB2CD06 (1.0 A)	MG24516 (1.0 A)	

**For ABL7UES and ABL7UPS**

For Use With	400 to 520 Vac Three-phase			
	Input Current	Thermal-Magnetic Supplementary Protector		gG Fuse
		GV2ME	C60N	
ABL7UES24050	3 x 0.33 A	GV2ME08 (2.5–4 A)	MG24533 (2 A)	2 A
ABL7UPS24100	3 x 0.65 A	GV2ME08 (2.5–4 A)	MG24533 (2 A)	2 A
ABL7UPS24200	3 x 1.2 A	GV2ME08 (2.5–4 A)	MG24534 (3 A)	3 A
ABL7UPS24400	3 x 1.7 A	GV2ME08 (2.5–4 A)	MG24535 (4 A)	4 A

**Wiring**

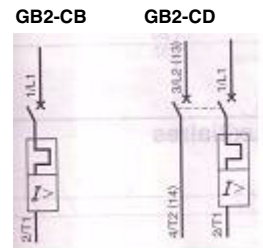



**OUTPUT CHARACTERISTICS**

**Load Limit**

**ABL7CEM24●●●**

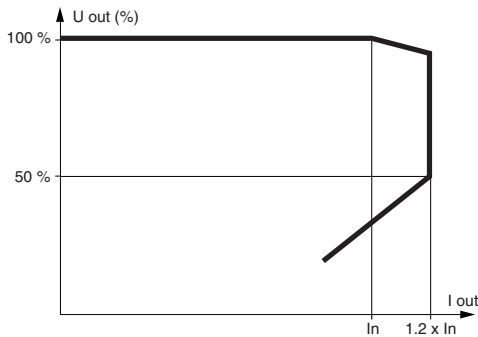

**ABL7RE24●●/ABL7RP●●●● and ABL7UES / UPS24●●**

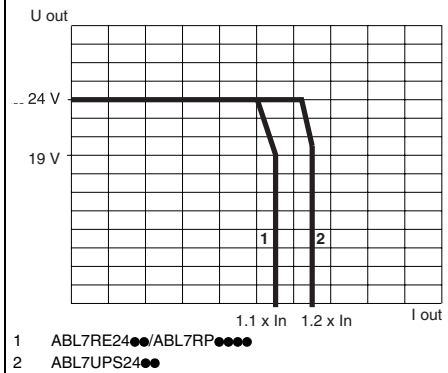

**Temporary Overloads**

**ABL7CEM**

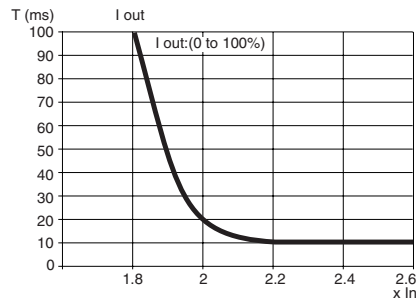

**ABL7RE/ABL7RP**

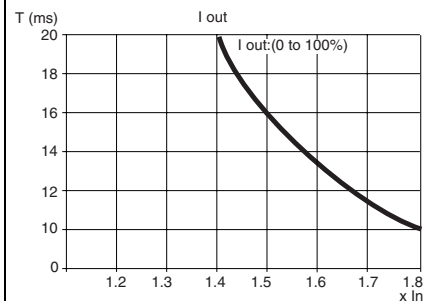

**ABL7UES / UPS**

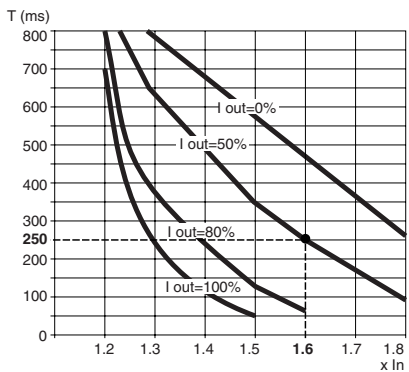

Example: For an ABL7UES / UPS24●●● power supply, 50 % loaded (I out = 50 %), this power supply can withstand a current peak of 1.6 x I in for 250 ms with an output voltage  $\geq 19$  V.

**Series or Parallel Connection**

**Series connection**

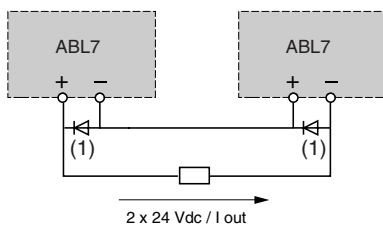

**Parallel connection**

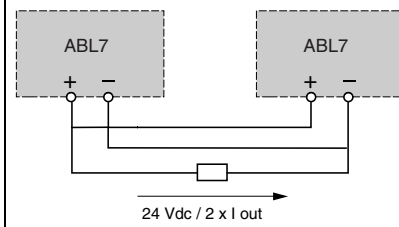

Family	Series	Parallel
ABL7CEM	2 products max (1)	Not possible
ABL7RE/RP	2 products max	2 products max
ABL7UES / UPS	2 products max	2 products max

(1) 2 Schottky diodes, 2 A/100 V, on ABL7CEM only.

## ABL7RM●●●●

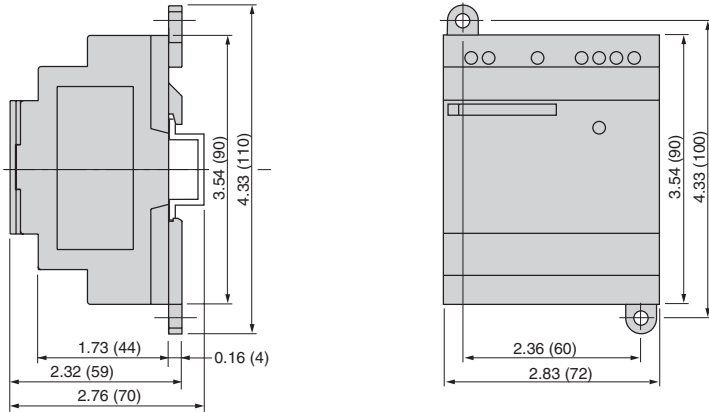

Dual Dimensions =  $\frac{\text{in}}{\text{mm}}$

## ABL7RE24●●/ABL7RP●●●●

Common side view

Mounting on 35 and 75 mm rails

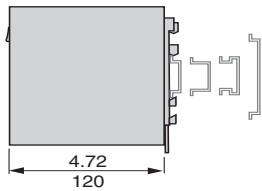

## ABL7RE2402/2403 ABL7RP2403

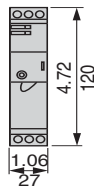

## ABL7RE2405 ABL7RP1205/2405/4803

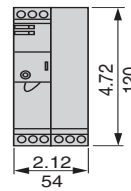

## ABL7RE2410 ABL7RP2410

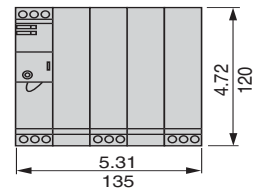

## ABL7CEM24●●● ABL7CEM24003

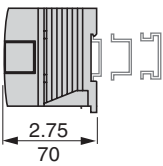

## ABL7CEM24006/ ABL7CEM24012

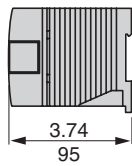

Panel mounting

Common front view

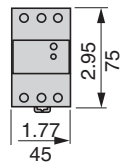

## ABL7UES24050 ABL7UPS24100

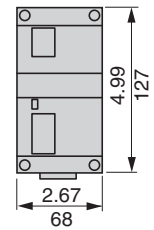
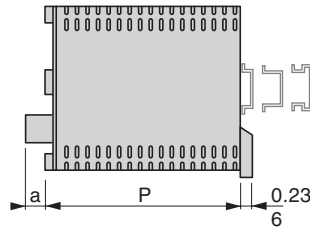

2 x M4 or 2 x Ø4.5

## ABL7UPS24400

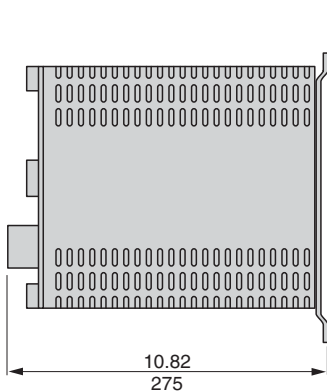

## ABL7UPS24200

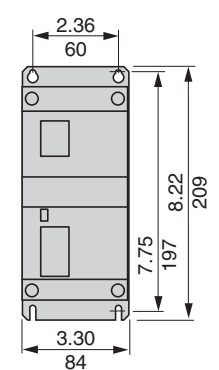
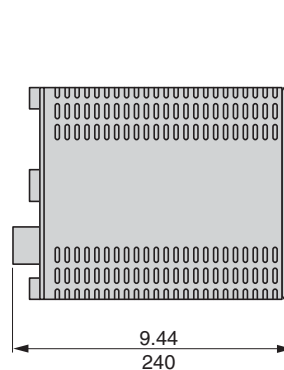
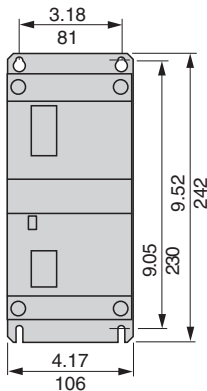

# PHASEO™ Power Supplies Wiring Diagrams

**ABL7RE2402/2403**

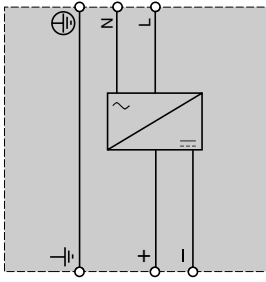

**ABL7RE2405**

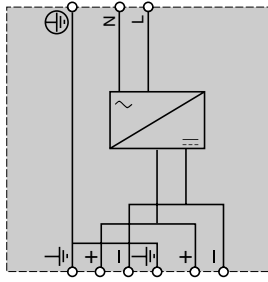

**ABL7RE2410**

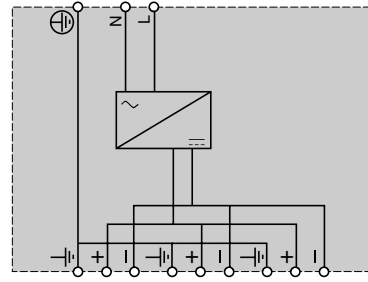

**ABL7RP2403**

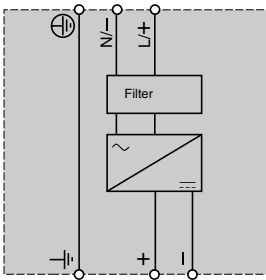

**ABL7RP1205/2405/4803**

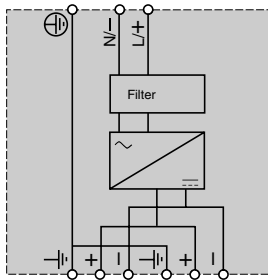

**ABL7RP2410**

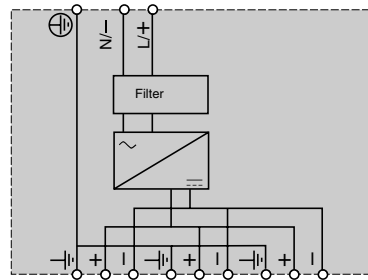

**ABL7CEM24●●●**

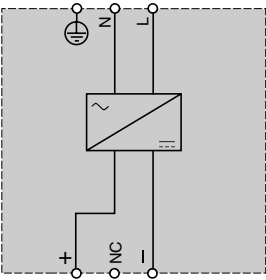

**ABL7RM●●●●**

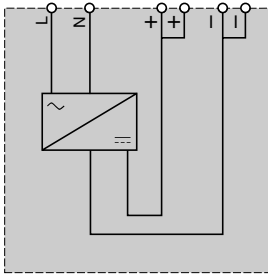

**ABL7UES / UPS●●●●●**

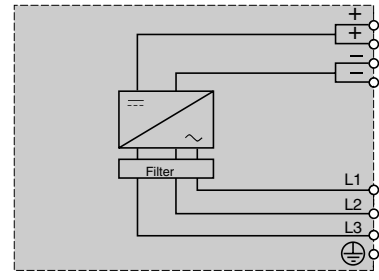

### POWER SUPPLIES FOR AS-INTERFACE

Consistent with the standard Phaseo™ line, the range of **ASIABL** power supplies is designed to deliver a dc voltage, as required by networks operating under the AS-Interface protocol. Three versions are available to meet all needs encountered in industrial applications, in enclosures, cells or floor-standing enclosures. These single-phase, electronic, switch mode power supplies guarantee the quality of the output current, in accordance with the electrical characteristics and conforming to standard EN 50295.

#### ASIABLB300●

Operating on a 100 to 240 Vac supply, this power supply delivers a voltage of 30 Vdc available in 2.4 and 4.8 A ratings. The parallel output terminal blocks allow the bus to be connected separately to the slaves and the master. Input and output LEDs allow fast and continuous diagnostics.

#### ASIABLD300●

Operating on a 100 to 240 Vac supply, this power supply delivers a voltage of 30 Vdc available in 2.4 and 4.8 A ratings, and allows diagnosis and management of ground faults on AS-Interface networks. In the event of a ground fault, the Phaseo™ power supply trips out, thus stopping dialogue on the bus. Restarting is only possible after deliberate acknowledgement of the fault. Two I/O ports are provided, which may be used to monitor status. The parallel output terminal blocks are used to connect the bus separately to the slaves and the AS-Interface master. Input, output and fault LED's allow fast and continuous diagnostics.

#### ASIABLM3024

Operating on a 100 to 240 Vac supply, this product delivers two dc outputs which are totally independent in the way they operate. Two output voltages - 30 Vdc/2.4 A (AS-Interface supply) and 24 Vdc/3 A - are available, making it possible to supply the control equipment without an additional power supply. Input and output LEDs allow fast and continuous diagnostics.

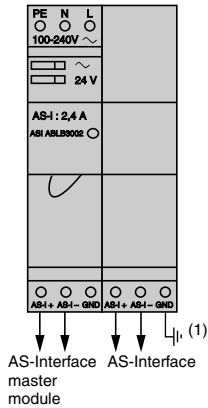

ASIABLB300●

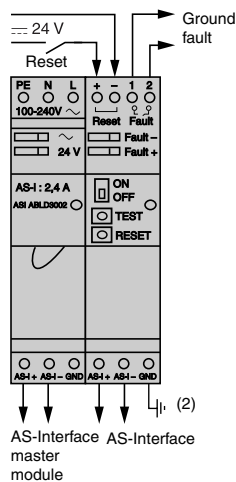

ASIABLD300●

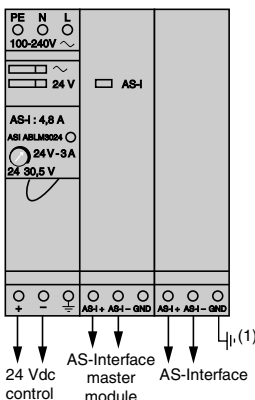

ASIABLM3024

### Regulated Switch Mode Power Supplies ASIABL

Input Voltage 47 to 63 Hz	Output voltage	Nominal power	Nominal current	Automatic protection reset	Ground fault detection	Catalog number	Weight lb. (kg)	
100 to 240 V single-phase wide range	30 Vdc	72 W	2.4 A	auto	no	ASIABLB3002	1.76 (0.80)	
		145 W	4.8 A	auto	no	ASIABLB3004	2.87 (1.30)	
	30 + 24 Vdc	72 W	2.4 A	auto	yes	ASIABLD3002	1.76 (0.80)	
		145 W	4.8 A	auto	yes	ASIABLD3004	2.87 (1.30)	
		30 + 24 Vdc	2 x 72 W	2.4 + 3 A	auto	no	ASIABLM3024	2.87 (1.30)

UL File E164867  
CCN NMTR

CSR File 204701  
Class 5311 03

CE



(1) Recommended connection.  
(2) Required connection.

# PHASEO™ Power Supplies Specifications and Characteristics

## Technical Specifications

<b>Catalog Number</b>	<b>ASIABLB3002</b>	<b>ASIABLB3004</b>	<b>ASIABLD3002</b>	<b>ASIABLD3004</b>	<b>ASIABLM3024</b>
<b>Functions</b>	Supply to the AS-Interface system				24 Vdc supply
<b>Approvals</b>	UL 508, CSA 22-2 n° 950, CE, TUV				
<b>Conforming to standards</b>					
Safety	EN 60950, TÜV				
EMC	EN 50081-1, IEC 61000-6-2, EN 55022 class B				
Low frequency harmonic currents	No				
<b>Input circuit</b>					
<b>LED indication</b>	Yellow LED				
<b>Input voltage</b>					
Rated values	100 to 240 Vac				
Permissible values	85 to 264 Vac				
Permissible frequencies	47 to 63 Hz				
Efficiency at nominal load	> 83 %				> 80 %
Current consumption	0.5	1	0.5	1	1
Current at switch-on	< 30 A				
Power factor	> 0.65				
<b>Output circuit</b>					
<b>LED indication</b>	Green LED				
<b>Nominal output voltage</b>	30 Vdc (AS-Interface)				24 Vdc
<b>Nominal output current</b>	2.4	4.8	2.4	4.8	2.4 3
<b>Precision</b>					
Adjustable output voltage	–				100 to 120 %
Line and load regulation	3 %				
Residual ripple - interference	300–50 mV				
<b>Micro-breaks</b>					
Holding time for I max and Ve min.	10 ms				
<b>Protection</b>					
Short-circuit	Permanent/automatic restart after elimination of the fault				
Overload	1.1 In				
Overvoltage	Tripping if U > 1.2 Un				U > 1.5 Un
Undervoltage	Tripping if U < 0.95 Un				U < 0.8 Un
<b>Operating characteristics</b>					
<b>Connections</b>					
Input	2-#14 AWG (2 x 2.5 mm <sup>2</sup> ) screw terminals + ground				
Output	2-#14 AWG (2 x 2.5 mm <sup>2</sup> ) screw terminals + ground, multiple output				
<b>Tightening torque</b>	5.4 lb-in (0.6 Nm)				
<b>Environment</b>					
Storage temperature	- 13 to + 158 °F (- 25 to + 70 °C)				
Operating temperature	32 to 140 °F (0 to + 60 °C) derating 122 °F (50 °C)				
Maximum relative humidity	95 % (without condensation or dripping water)				
Degree of protection	IP 20 (conforming to IEC 60529)				
Vibration	EN 61131-2				
<b>Operating position</b>	Vertical				
<b>MTBF</b>	> 100000 h conforming to Bell core, at 104 °F (40 °C)				
<b>Dielectric strength</b>					
Input/output	3000 V/50 Hz/1 mm				
Input/ground	3000 V/50 Hz/1 mm				
Output/ground (and input/output)	500 V/50 Hz/1 mm				
<b>Input fuse incorporated</b>	Yes (not interchangeable)				
<b>Emissions</b>					
Conducted/radiated	Class B (conforming to EN 55022)				
<b>Immunity</b>					
Electrostatic discharge	EN 61000-4-2 (4 kV contact/8 kV air)				
Electromagnetic	EN 61000-4-3 level 3 (10 V/m)				
Conducted interference	EN 61000-4-4 level 3 (2 kV), EN 61000-4-6 (10 V)				
Supply interference	EN 61000-4-11				

**DERATING**

The ambient temperature is a determining factor which limits the power that an electronic power supply can deliver continuously. If the temperature around the electronic components is too high, their life will be significantly reduced.

The graph below shows the power (in relation to the nominal power) which the power supply can deliver continuously, according to the ambient temperature.

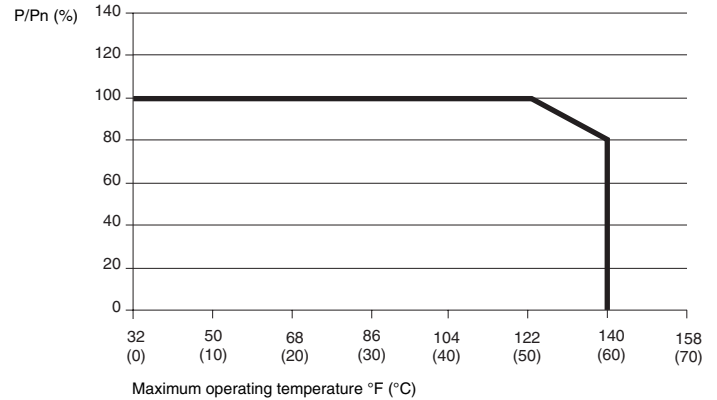

**PROTECTION DEVICES**

**For AS-Interface System**

Power Supply	115 Vac single-phase			230 Vac single-phase		
	Thermal-magnetic circuit-protector	Gg fuse		Thermal-magnetic circuit-protector	Gg fuse	
Single-pole	GB2 CB●●					
2-pole	GB2 DB●●	C60N		GB2 DB●●	C60N	
<b>ASIABLB3002</b>	GB2 ●B07	MG24517 (1)	2 A	GB2 DB06	MG24516 (1)	2 A
<b>ASIABLB3004</b>	GB2 ●B08	MG24518 (1)	4 A	GB2 DB07	MG17453 (1)	2 A
<b>ASIABLD3002</b>	GB2 ●B07	MG24517 (1)	2 A	GB2 DB06	MG24516 (1)	2 A
<b>ASIABLD3004</b>	GB2 ●B08	MG24518 (1)	4 A	GB2 DB07	MG17453 (1)	2 A
<b>ASIABLM3024</b>	GB2 ●B07	MG24517 (1)	2 A	GB2 DB06	MG17453 (1)	2 A

(1) UL listed circuit-breaker.

There must always be adequate convection around the power supply to ensure proper cooling. There must be a clear space of 1.96" (50 mm) above and below the power supply and 0.59" (15 mm) on both sides.

### Function Diagram

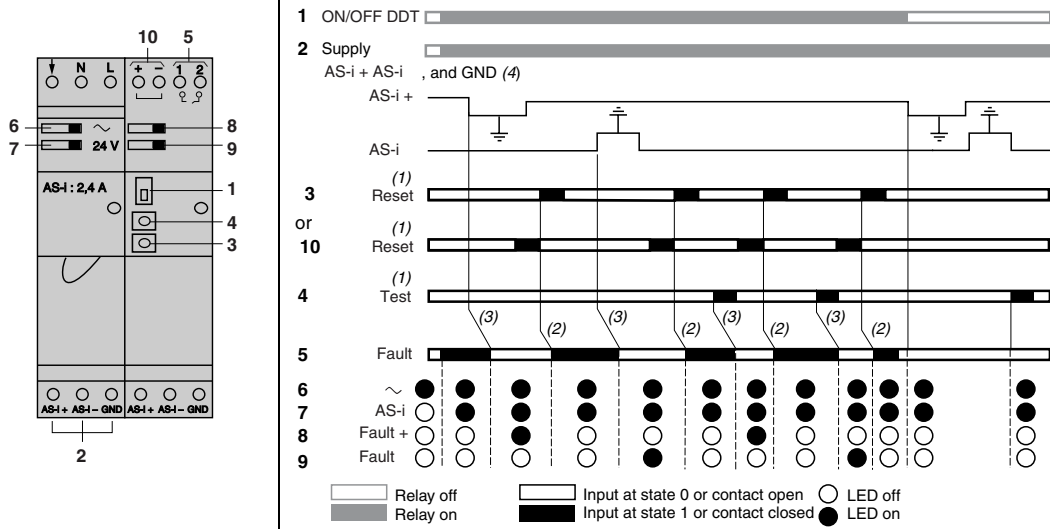

- (1) 30 ms min.
- (2) 15 ms.
- (3) 20 ms.
- (4) NOTE: The ground fault detector will only operate if the ground (GND) terminal is connected.

### Dimensions

Common side view  
Mounting on 35 and 75 mm rails

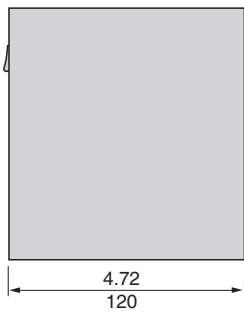

ASIABLB3002  
ASIABLD3002

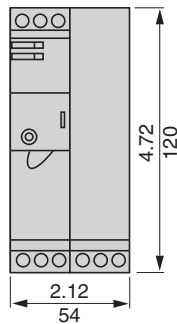

ASIABLM3024  
ASIABL3004

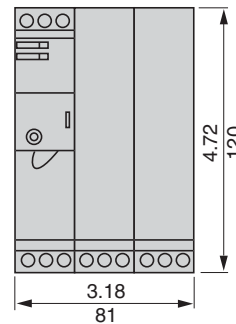

Dual Dimensions =  $\frac{\text{in}}{\text{mm}}$

### Wiring

ASIABLB300●

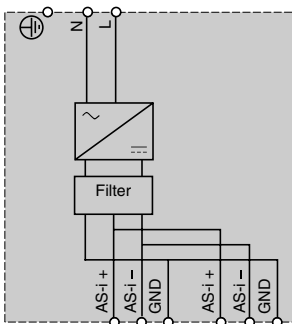

ASIABLD300●

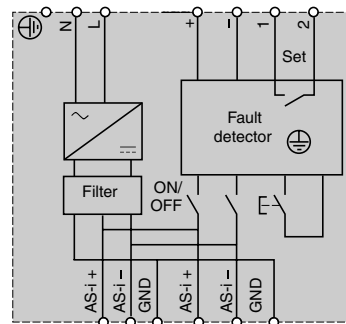

ASIABLM3024

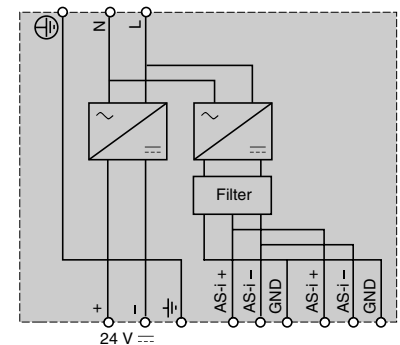



## PHASEO™ Power Supplies Indexed Catalog Numbers

ABL7RM1202 .....	8
ABL7RM2401 .....	8
ABL7CEM24003 .....	8
ABL7CEM24006 .....	8
ABL7CEM24012 .....	8
ABL7RE2402 .....	8
ABL7RE2403 .....	8
ABL7RE2405 .....	8
ABL7RE2410 .....	8
ABL7RP1205 .....	8
ABL7RP2403 .....	8
ABL7RP2405 .....	8
ABL7RP2410 .....	8
ABL7RP4803 .....	8
ABL7UES24050 .....	8
ABL7UPS24100 .....	8
ABL7UPS24200 .....	8
ABL7UPS24400 .....	8
ASIABLB3002 .....	20
ASIABLB3004 .....	20
ASIABLD3002 .....	20
ASIABLD3004 .....	20
ASIABLM3024 .....	20

*NOTE: Protective devices  
are listed on pages 15 and  
21.*

Schneider Electric  
8001 Highway 64 East  
Knightdale, NC 27545  
1-888-SquareD  
(1-888-778-2733)  
[www.us.SquareD.com](http://www.us.SquareD.com)

Schneider Electric Canada  
19 Waterman Avenue,  
M4B 1 Y2  
Toronto, Ontario  
1-800-565-6699  
[www.schneider-electric.ca](http://www.schneider-electric.ca)

Catalog No. 8440CT0001R4/04 May 2004 © 2000–2004 Schneider Electric All Rights Reserved  
Replaces 8440CT0001R2/03 dated 02/04