

Phaseo™ power supplies ABL1, ABL7 and ABL8

Catalog
2011





Product data website	4
<i>Selection guides</i>	6
Overview	10
Product descriptions:	
■ ABL7/ABL8 Modular range	14
■ ABL7/ABL8 Optimum range	20
■ ABL8 Universal range	26
<i>Function modules (for Universal range):</i>	
□ DC/DC Converter modules	36
□ Buffer modules and Battery Control modules	39
□ Redundancy module	46
■ ABL1 Dedicated range	50
■ ASIABL AS-Interface™ range	56
Product reference index	60



Go online to www.schneider-electric.com for technical information about products listed in this catalog, including:

To learn more about Phaseo™ electronic switch mode power supply products, follow these steps...

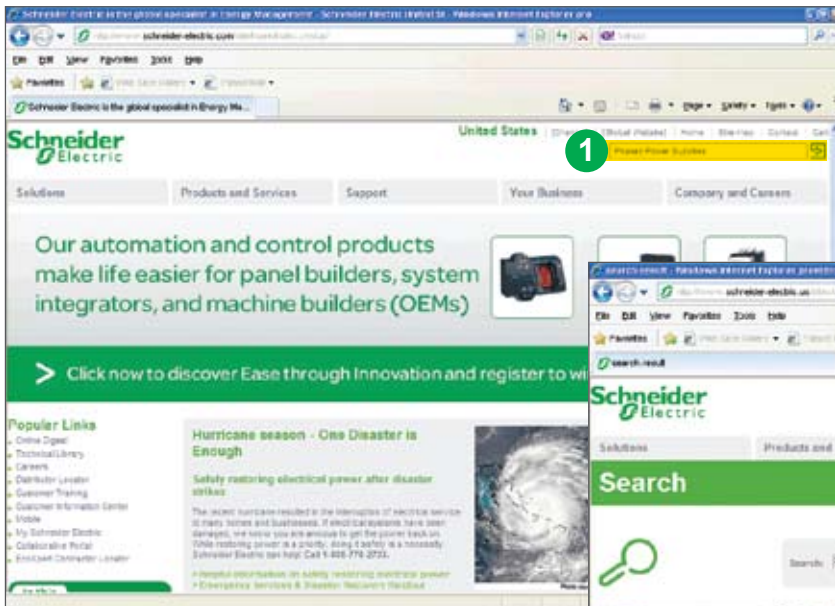

1 Go to www.schneider-electric.com and enter “Phaseo Power Supplies” in the Search Box.

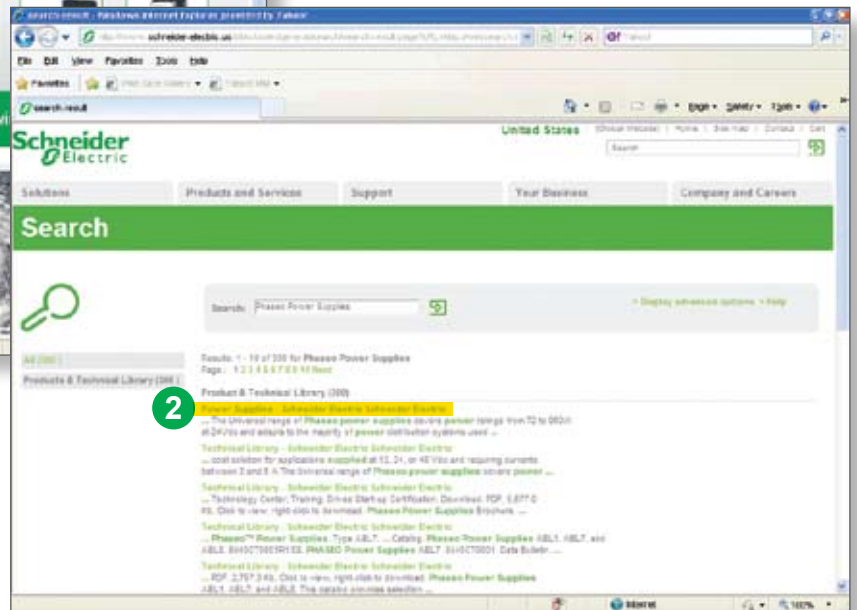

2 On the Search results page, select the first listing under “Product & Technical Library” entitled **Power Supplies - Schneider Electric**.

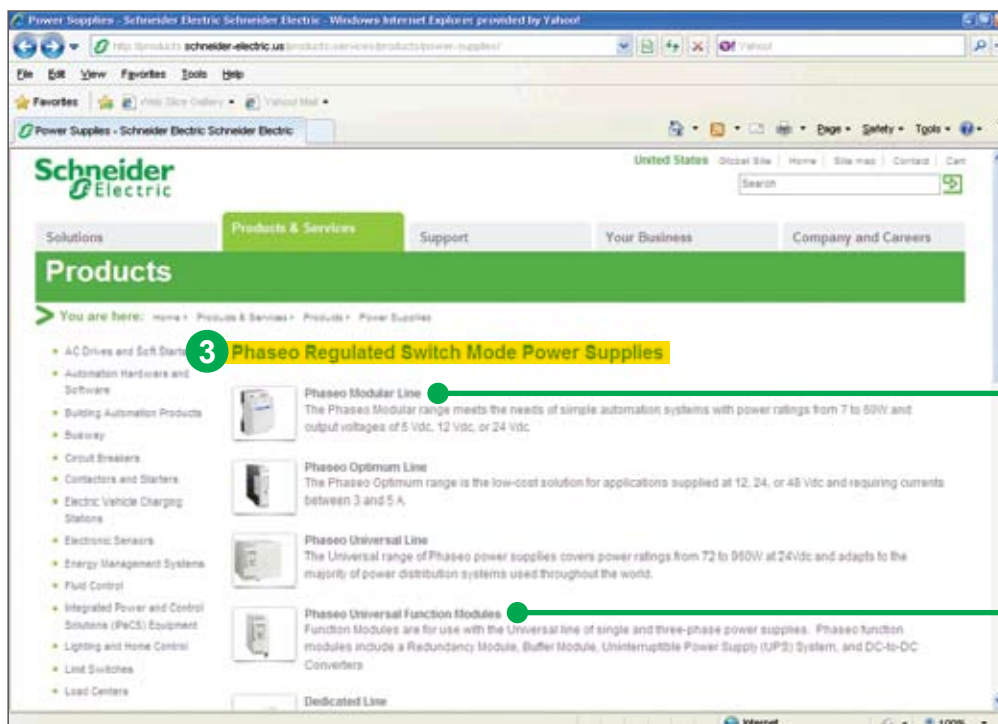

3 On the “Products” page – under “Phaseo Regulated Switch Mode Power Supplies” – select from the following product lines, including: **Modular, Optimum, Universal, Universal Function Modules and Dedicated Line.**

> Specifications > Dimensions > References
> Curves > Links to user guides and CAD files



4 For example...select the “Phaseo Modular Line” and click on **Overview** for Key Features and Applications.

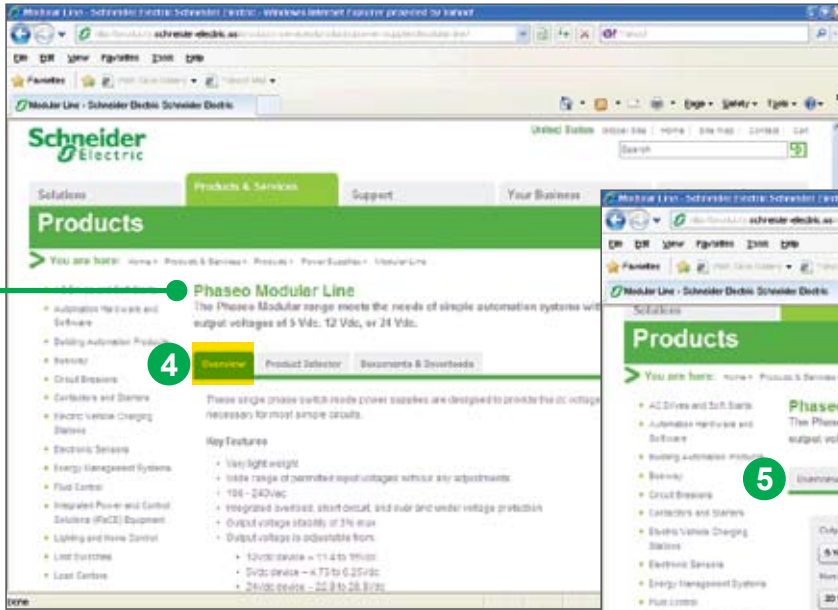

5 Use the **Product Selector** to identify the Phaseo Power Supply with the right specifications to meet your requirements.

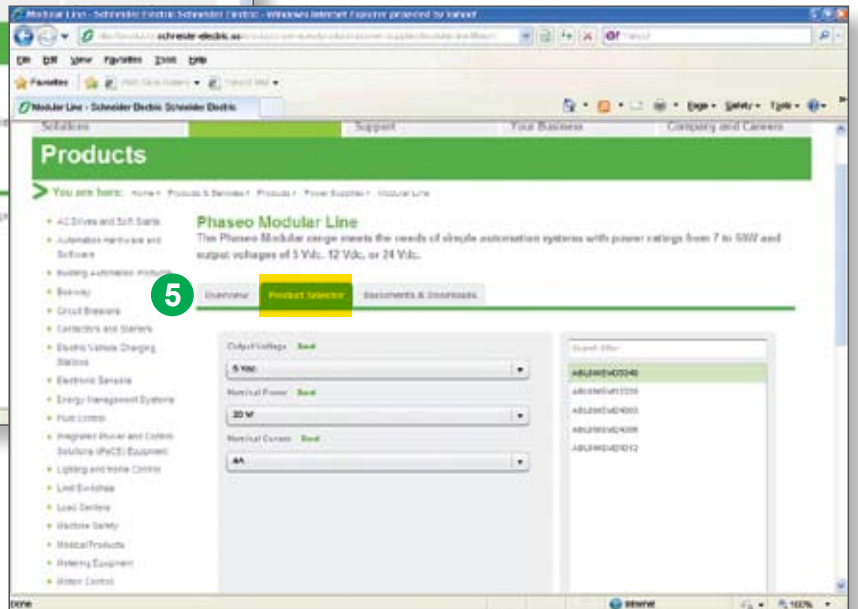

6 Select **Documents & Downloads** to view and select Product Brochures, Catalogs, Data Bulletins, Declarations, Handouts and Instruction Bulletins.

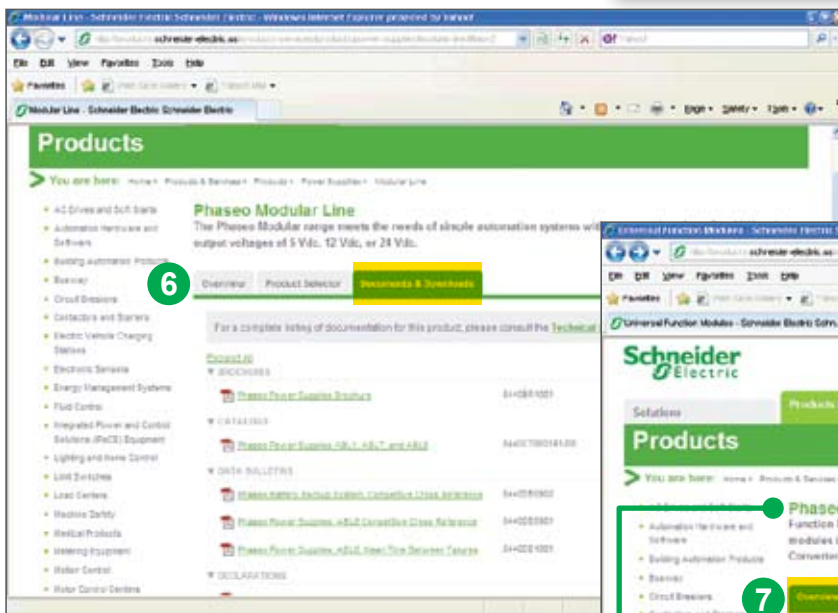

7 And, when you select “Phaseo Universal Function Modules” and click on **Overview**, you'll find out about the Uninterruptable Power Supply (UPS) System and the Interactive Demo.

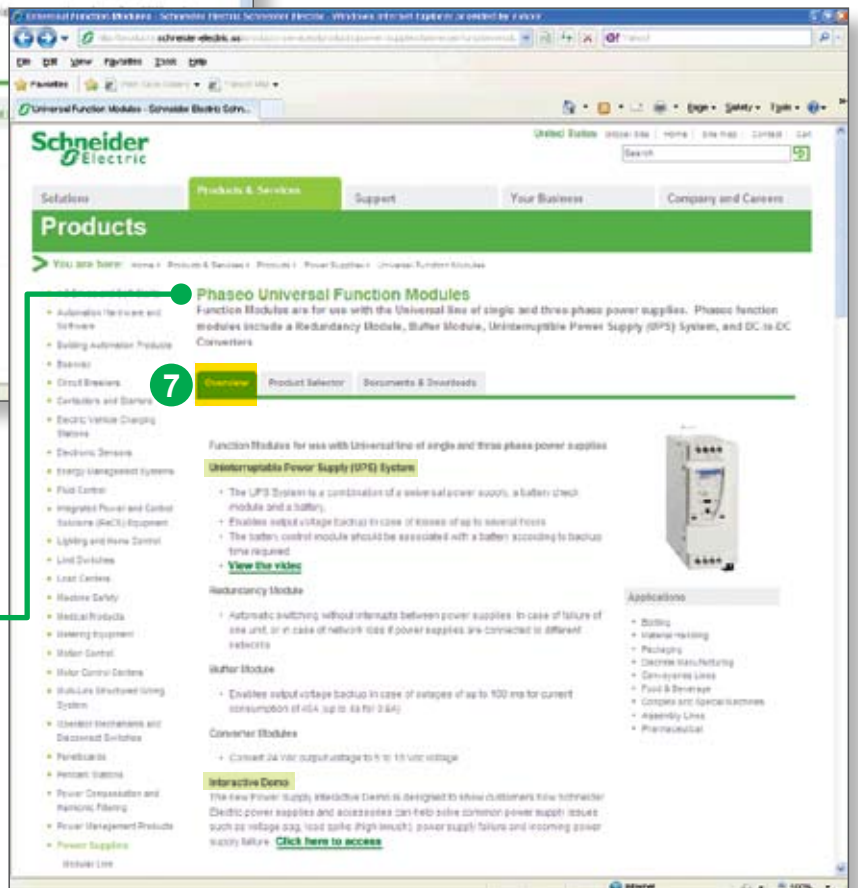

Phaseo™ power supplies

Regulated switch mode power supplies
ABL7/ABL8 Modular and Optimum ranges

Power supplies

Regulated switch mode
Phase Modular range and Optimum range industrial power supplies



Input voltage	
Connection to world-wide line supplies	United States - 120 V (in phase-to-neutral) - 240 V (in phase-to-phase) Europe - 230 V (in phase-to-neutral) - 400 V (in phase-to-phase) United States - 277 V (in phase-to-neutral) - 480 V (in phase-to-phase)

100 to 240 V ~ 120 to 250 V ---
Single-phase (N-L1) or 2-phase (L1-L2) connection
Single-phase (N-L1) connection
–

IEC/EN 61000-3-2 conformity
Protection against undervoltage
Protection against overloads and short-circuits
Diagnostic relay
Compatibility with function modules
Power reserve (Boost)

Yes for ABL7RP, not for ABL8REM and not applicable for ABL8MEM and ABL7RM	
Yes	
Yes, voltage detection. Automatic restart on elimination on the detected fault	
–	
–	
1.25 to 1.4 In for 1 minute, depending on model (with ABL8MEM)	No

Output voltage	
Output current	0.3 A 0.6 A 1.2 A 2 A 2.5 A 3 A 4 A 5 A 6 A 10 A 20 A 40 A

5 V ---	12 V ---	24 V ---	48 V ---
		ABL8MEM24003 (Modular)	
		ABL8MEM24006 (Modular)	
		ABL8MEM24012 (Modular)	
	ABL8MEM12020 (Modular)		
		ABL7RM24025 (Modular)	ABL7RP4803 (Optimum)
		ABL8REM24030 (Optimum)	
ABL8MEM05040 (Modular)			
	ABL7RP1205 (Optimum)	ABL8REM24050 (Optimum)	

Pages

14	14 (Modular) and 20 (Optimum)	20
----	-------------------------------	----



Regulated switch mode

Phaseo Universal range industrial power supplies **ABL8DCC Function modules: Converter modules 24 V/5-12 V**



100 to 120 V ~ and 200 to 500 V ~ (1)	380 to 500 V ~	24 V 24 V	
Single-phase (N-L1) or 2-phase (L1-L2) connection	–	–	
	3-phase (L1-L2-L3) connection	–	
	3-phase (L1-L2-L3) connection	–	
Yes		–	
Yes		–	
Yes, current limitation or undervoltage detection		Yes, current limitation	
Yes, depending on model			
Yes with buffer module, battery and battery control modules, redundancy module and discriminating downstream protection module			
1.5 In for 4 seconds		No	
24 V 24 V		5 V 5 V	7 to 12 V 7 to 12 V
			ABL8DCC12020 (2)
ABL8RPS24030			
ABL8RPS24050			
		ABL8DCC05060 (2)	
ABL8RPS24100			
ABL8RPM24200	ABL8WPS24200		
	ABL8WPS24400		

26 36

(1) Except **ABL8RPM24200**. ~ 100 to 120 V and ~ 200 to 240 V.
(2) 24 V/5 V converter module, requires to be associated with ABL8RP/ABL8WP power supply.

Phaseo™ power supplies

Regulated switch mode power supplies
ABL1 Dedicated range

Power supplies

Regulated switch mode
Phaseo Dedicated range power supplies for repetitive machines



Input voltage	
Connection to world-wide line supplies	<ul style="list-style-type: none"> United States <ul style="list-style-type: none"> - 120 V (in phase-to-neutral) - 240 V (in phase-to-phase) Europe <ul style="list-style-type: none"> - 230 V (in phase-to-neutral) - 400 V (in phase-to-phase) United States <ul style="list-style-type: none"> - 277 V (in phase-to-neutral) - 480 V (in phase-to-phase)
IEC/EN 61000-3-2 conformity	
Protection against undervoltage	
Protection against overloads and short-circuits	
Diagnostic relay	
Compatibility with function modules	
Power reserve (Boost)	
Output voltage	
Output current	<ul style="list-style-type: none"> 2.5 A 3 A 4.2 A 4.8 A 5 A 6.2 A 8.3 A 10 A
Pages	

100 to 240 V ~ 120 to 370 V ---	
Single-phase (N-L1) or 2-phase (L1-L2) connection	
Single-phase (N-L1) -	
Single-phase (N-L1) -	
Yes for ABL1RP, not applicable for ABL1REM24025/12050 -	
Yes, voltage detection. Automatic restart on elimination on the detected fault -	
-	
No	
12 V ---	24 V ---
	ABL1REM24025
	ABL1R•M24042
ABL1REM12050	
	ABL1R•M24062
ABL1RPM12083	
	ABL1R•M24100
50	



Regulated switch mode
Phaseo AS-Interface range for AS-Interface cabling system



100 to 240 V ~	
Single-phase (N-L1) connection	
Single-phase (N-L1) connection	
-	
No	Yes
-	Yes
Yes	
-	
-	
No	
30 V ⋯	24 V ⋯
ASIABLB3002 ASIABLD3002 (1) ASIABLM3024 (2)	
	ASIABLM3024 (2)
ASIABLB3004 (2) ASIABLD3004 (1)	

56

(1) With ground fault detection.

(2) One output 30 ⋯ and one output 24 ⋯ ± 5%.



Phaseo™ power supplies

Regulated switch mode power supplies

Overview

The Phaseo™ electronic switch mode power supply offer is designed to provide the DC voltage necessary for the PLC and automation system equipment control circuits.

These power supplies include five ranges:

- Modular, Optimum and Universal ranges for common applications (ABL8 and ABL7)
- AS-Interface range for the AS-Interface cabling system (AS-Interface)
- Dedicated range for repetitive equipment (ABL1)

The Phaseo offer meets all the needs encountered in industrial, commercial and residential applications. With phase-to-neutral (N-L1), phase-to-phase (L1-L2) or 3-phase (L1-L2-L3) connection to the line supply, these electronic switch mode power supplies provide a quality of output current that is suitable for the loads supplied and compatible with the line supply available in the equipment. Clear guidelines are given for selecting protection devices which are often used with them, and thus a comprehensive solution is provided that can be used in total safety.

Phaseo switch mode power supplies

Phaseo switch mode power supplies are totally electronic and their output voltage is regulated. The use of electronics makes it possible to significantly improve the performance of these power supplies, which offer:

- Very compact size
- Integrated overload, short-circuit, overvoltage and undervoltage protection
- Very wide input voltage range for the Universal range
- High degree of output voltage stability
- Good performance
- Diagnostics via LED indicators on the front panel
- Remote diagnostics via a relay contact for the Universal range

Phaseo power supplies deliver a stabilized \bar{u} output voltage that is precise to 3%, whatever the load from a \sim line supply, within the ranges of:

- For Modular, Optimum, Dedicated and AS-Interface ranges:
 - 100 to 240 V \sim for phase-to-neutral (N-L1) or phase-to-phase (L1- L2) connection
- For the Universal range:
 - 85 to 550 V \sim for phase-to-neutral (N-L1) or phase-to-phase (L1- L2) connection
 - 360 to 550 V \sim for 3-phase connection (L1-L2-L3)

Conforming to IEC standards and UL, CSA, TÜV and C-Tick certified, they are suitable for industrial use.

Phaseo power supplies also incorporate:

- Output voltage adjustment potentiometer in order to be able to compensate for any line voltage drops in installations with long cable runs
- Direct mounting on 35 mm DIN rails, optional on Dedicated range (1)

(1) The Optimum and AS-Interface ranges can also take 75 mm DIN rails.

Overview (continued)

Phaseo™ switch mode power supplies (continued)

Phaseo regulated switch mode industrial supplies are offered in three ranges (Modular, Optimum and Universal), complemented by the AS-Interface and Dedicated ranges for repetitive machines.

Phaseo Modular range

The Phaseo Modular range meets all the needs of simple automation systems with power ratings from 7 to 60 W and an output voltage of 5 V $\overline{\text{---}}$, 12 V $\overline{\text{---}}$ or 24 V $\overline{\text{---}}$. The shape and compact nature of its casing mean that it can be incorporated either in a modular panel or mounted on a DIN rail in a cabinet. Direct mounting on a panel (using its two retractable legs) and the choice of wires exiting at the top or bottom (except for the **ABL7RM24025** model) make it an easy product to integrate.



ABL8MEM12020



ABL8REM24030

Phaseo Optimum range

The Phaseo Optimum range is the low-cost solution for applications supplied in 12 V $\overline{\text{---}}$, 24 V $\overline{\text{---}}$ or 48 V $\overline{\text{---}}$ and requiring currents between 3 and 5 A. The Optimum range of Phaseo power supplies delivers a voltage that can guarantee the PLC logic states. In the event of an overload the power supply protection trips so that, once the detected fault has been eliminated, the power supply reverts to its nominal state.

Since the Optimum range of Phaseo power supplies does not have PFC (*Power Factor Correction*), they do not meet the requirements of standard IEC/EN 61000-3-2 (except for **ABL7RP1205/7RP4803** models).

Phaseo Universal range

The Universal range of Phaseo power supplies covers power ratings from 72 to 960 W in 24 V $\overline{\text{---}}$ and adapts to the majority of power distribution systems used throughout the world. The same power supply can thus be connected phase-to-neutral (N-L1) or phase-to-phase for line supplies ranging from 100 V \sim to 500 V \sim nominal. This product offering also includes three phase units. In addition, this range offers:

- Diagnostic functions (local or remote)
- User choice of operating mode in the event of an overload (current limiting or stop)
- Function modules to help ensure continuity of service:
 - Protection against microbreaks or prolonged outages by means of the Buffer module and Battery Control modules
 - Paralleling and redundancy functions by means of the Redundancy module
- Power reserve (boost function) for absorbing the transient current peaks required by the application

With the Universal range of power supplies, it is possible to satisfy the need for auxiliary voltage (5 V $\overline{\text{---}}$ to 15 V $\overline{\text{---}}$) using $\overline{\text{---}}$ / $\overline{\text{---}}$ Converter modules.

The incorporation of a PFC (*Power Factor Correction*) input filter reduces harmonic pollution to a minimum level across the entire Universal range, ensuring compliance with the requirements of standard IEC/EN 61000-3-2.

Phaseo AS-Interface range

The 72 and 144 W AS-Interface range of Phaseo power supplies is designed to deliver a voltage of 30 V $\overline{\text{---}}$, which is a prerequisite for the AS-Interface cabling system. These electronic switch mode power supplies with phase-to-neutral (N-L1) connection help ensure the quality of the output current in accordance with the electrical specifications and in compliance with standard EN 50295.

Phaseo Dedicated range

The Dedicated range of Phaseo power supplies from 60 to 240 W is designed for integration in repetitive equipment requiring a voltage of 12 V $\overline{\text{---}}$ or 24 V $\overline{\text{---}}$. These electronic switch mode power supplies, with phase-to-neutral (N-L1) connection, with or without anti-harmonic filter and UL 508, CSA and TÜV certified, meet all the needs encountered in commercial machines and standard catalog machines.



ABL8RPS24100



ABL8BUF24400



ASIABL304



ASIABL3002



ABL1R0M000



ABL1R0M24100

Specifications of the 24 V $\overline{\text{---}}$ operating voltage

The permissible tolerances for the operating voltage are listed in publications IEC/EN 61131-2 and DIN 19240.

For a nominal voltage U_n of 24 V $\overline{\text{---}}$, the extreme operating values are from - 15% to + 20% of voltage U_n , whatever the supply fluctuations in the range - 10% to + 6% (defined by standard IEC 38) with load variations in the range 0 to 100% of nominal current I_n .

All 24 V $\overline{\text{---}}$ Phaseo™ power supplies are designed to provide an output voltage within these ranges.

It may be necessary to use a voltage measurement relay to detect when the normal voltage limits are being surpassed and to deal with the consequences of this. The Universal range has integrated voltage detection.

Recommendations for the use of 24 V $\overline{\text{---}}$ voltage

The Phaseo power supplies can be used to supply control circuits with Protection Extra Low Voltage (PELV) or Safety Extra Low Voltage (SELV) in compliance with standard IEC/EN 60364-4-41.

They have the following specifications:

- Double insulation between the input circuit (connected to the line supply) and the low voltage output circuit via an integrated isolation transformer
- Internal device limiting the output voltage to less than 60 V in the event of an internal detected fault

Harmonic pollution (power factor)

The current drawn by a power supply is not sinusoidal. This leads to the generation of harmonic currents that pollute the distribution system. European standard IEC/EN 61000-3-2 limits the harmonic currents produced by power supplies.

This standard covers all devices between 75 and 1000 W, drawing up to 16 A per phase and connected directly to the public distribution system. Devices connected downstream of a private, low voltage general transformer are therefore excluded. Regulated switch mode supplies always consume harmonic currents; a filter circuit (Power Factor Correction or PFC) must therefore be added to comply with standard IEC/EN 61000-3-2.

The **ABL8RPS / 8RPM / 8WPS24●●0** Universal range and the **ABL1RPM** Dedicated range of Phaseo power supplies comply with standard EN 61000-3-2 and can therefore be connected directly to public distribution systems.

Since the **ABL8MEM240●●** Modular range and **ABL7RM24025** and **ABL1REM12050/24025** Dedicated range of Phaseo power supplies have power ratings of < 75 W, they are not subject to the requirements of standard EN 61000-3-2. They can therefore be connected directly to public distribution systems.

The **ABL8REM** Optimum range and the **ABL1REM** Dedicated range of Phaseo power supplies must only be connected downstream of a private, low voltage general transformer.

Phaseo™ power supplies

Regulated switch mode power supplies

ABL7/ABL8 Modular range

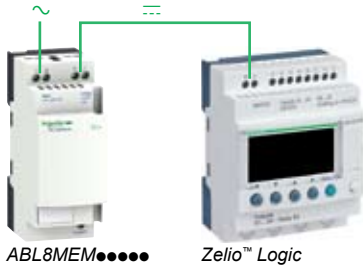

Switch mode power supplies: Modular range

The **ABL8MEM/ABL7RM** power supply offer is designed to provide the DC voltage necessary for the control circuits of automation system equipment consuming 7 to 60 W in 5, 12 and 24 V \dots . Comprised of six products, this range meets the needs encountered in industrial, commercial, and residential applications. These Modular electronic switch mode power supplies provide a quality of output current that is suitable for the loads supplied and compatible with the Zelio™ Logic range. Clear guidelines are given on selecting the upstream protection devices which are often used with them, and thus a comprehensive solution is provided that can be used in total safety.

The Modular range of Phaseo™ power supplies can be connected in phase-to-neutral (N-L1) or in phase-to-phase (1) (L1-L2). They deliver a voltage that is precise to 3%, whatever the load and whatever the type of line supply, within a range of 85 to 264 V \sim . Conforming to IEC standards and UL, CSA and TUV certified, they are suitable for global use. They have overload and short-circuit protection.

Due to their low power, the Modular range of Phaseo power supplies consume very little harmonic current and thus are not subject to the requirements of standard IEC/EN 61000-3-2 concerning harmonic pollution.

All the Modular range of Phaseo power supplies have protection devices to help ensure optimum performance of the automation system with an automatic reset mode on elimination of the detected fault.

All products are equipped with an output voltage adjustment potentiometer in order to be able to compensate for any line voltage drops in installations with long cable runs.

These power supplies also have a cable channel on the side of the unit so that the output wires can be directed to the top or bottom of the product as required.

They are designed for direct mounting on 35 mm DIN rails, or on a panel using their retractable mounting legs.

There are six references available in the Phaseo Modular range:

■ ABL8MEM24003	7 W	0.3 A	24 V \dots
■ ABL8MEM24006	15 W	0.6 A	24 V \dots
■ ABL8MEM24012	30 W	1.2 A	24 V \dots
■ ABL7RM24025	60 W	2.5 A	24 V \dots
■ ABL8MEM05040	20 W	4 A	5 V \dots
■ ABL8MEM12020	25 W	2 A	12 V \dots

(1) 240 V \sim nominal.

Description

ABL8MEM●●●●●



ABL7RM24025



- 1 14 AWG (2.5 mm²) screw terminal for connection of the AC input voltage
- 2 Output voltage adjustment potentiometer
- 3 14 AWG (2.5 mm²) screw terminal for connection of the output voltage
- 4 LED indicating presence of the DC output voltage
- 5 Channel for through-wiring of the output voltage conductors at the bottom (except for model ABL7RM24025)
- 6 Clip-on marker label (except for model ABL7RM24025)
- 7 Retractable mounting legs for panel mounting

Phaseo™ power supplies

Regulated switch mode power supplies

ABL7/ABL8 Modular range

Technical specifications

Power supply type		ABL8MEM24003	ABL8MEM24006	ABL8MEM24012	ABL7RM24025
Certifications		cULus 508, cCSAus (CSA22.2 n950-1), TÜV 60950-1, CE, CTick, RoHS			
Conformity to standards	Safety	IEC/EN 60950-1, SELV			
	EMC	IEC/EN 61000-6-2, IEC/EN 61000-6-3, IEC/EN 61204-3, EN 55022 Class B			

Input circuit

LED indication		No			
Input values	Nominal voltage	V	100 to 240 Vac		
	Limit voltage	V	85 to 264 Vac 120 to 250 Vdc (1)		85 to 264 Vac
Current consumption		A	0.25 (100 Vac) 0.18 (240 Vac)	0.4 (100 Vac) 0.25 (240 Vac)	0.65 (100 Vac) 0.4 (240 Vac)
	Permissible frequencies	Hz	47 to 63		
Maximum inrush current		A	20		90 for 1 ms
Power factor			> 0.5		
Efficiency at nominal load			> 78%	> 80%	> 82%
Dissipated power at nominal load		W	2	3.8	6.6
					11.4

Output circuit

LED indication		Green LED			
Nominal output values	Voltage (U _{out})	V	24 Vdc		
	Current	A	0.3	0.6	1.2
	Power	W	7	15	30
Precision	Output voltage	V	Adjustable from 22.8 to 28.8 Vdc		
	Line and load regulation		± 3%		
	Residual ripple - noise	mV	250		200
Holding time for I max.	U _{in} = 100 Vac	ms	≥ 10		
	U _{in} = 230 Vac	ms	≥ 150		
Protection	Against short circuits		Permanent		
	Against undervoltages	V	-		< 19
	Thermal		Yes		

Operating and environmental specifications

Connections	Input	AWG (mm ²)	26 to 14 (2 x 0.14 to 2.5) screw terminals		
	Output	AWG (mm ²)	26 to 14 (2 x 0.14 to 2.5) screw terminals	26 to 14 (4 x 0.14 to 2.5) screw terminals	
Mounting			On DIN rail, 35 x 7.5 mm and 35 x 15 mm or on panel (2 x ∅ 4 mm)		
Operating position	On vertical plane		Vertical		
Connections	Series		Possible		
	Parallel		Possible		
Environment	Operating temperature	°F (°C)	-13 to 158 derating from 131 °F (-25 to +70 derating from 55 °C),		-13 to 131 °F (-25 to +55 °C)
	Storage temperature	°F (°C)	-40 to 158 °F (-40 to +70 °C)		
	Relative humidity		90% during operation, 95% in storage		
	Degree of protection		IP 20 conforming to IEC 60529		
	Vibration per to EN 61131-2		3 to 11.9 Hz, amplitude 0.14 in. (3.5 mm); and 11.9 -150 Hz, acceleration 2 g		
Protection class according to VDE 0106 1			Class II		
Dielectric strength 50 Hz for 1 min	Input/output	V rms	3000 Vac		
Input fuse incorporated			Yes (not interchangeable)		
Emissions according to EN 61000-6-3			EN 50081-1 (generic)		
	Radiation		EN 55022 Class B		
	Conducted on the power line		EN 55022 Class B		
	Harmonic currents		IEC/EN 61000-3-2		
Immunity according to EN 61000-6-2			IEC 61000-6-2 (generic)		
	Electrostatic discharge		IEC/EN 61000-4-2 (6 kV contact/8 kV air)		IEC/EN 61000-4-2 (4 kV contact/8 kV air)
	Radiated electromagnetic fields		IEC/EN 61000-4-3 level 3 (10 V/m)		
	Induced electromagnetic fields		IEC/EN 61000-4-6 level 3 (10 V/m)		
	Rapid transients		IEC/EN 61000-4-4 (4 kV)		
	Surges		IEC/EN 61000-4-5 (1 kV)		
	Primary outages		IEC/EN 61000-4-11 (voltage dips and interruptions)		

(1) DC input voltages are not included in cULus, cCSAus, and TÜV certifications.

Phaseo™ power supplies

Regulated switch mode power supplies

ABL7/ABL8 Modular range

Technical specifications					
Power supply type		ABL8MEM05040		ABL8MEM12020	
Certifications		cULus 508, cCSAus (CSA22.2 n950-1), TÜV EN 60950-1, CE, CTick, RoHS			
Conformity to standards		Safety		IEC/EN 60950-1, SELV	
		EMC		IEC/EN 61000-6-2, IEC/EN 61000-6-3, IEC/EN 61204-3, EN 55022 Class B	
Input circuit					
LED indication				No	
Input values		Nominal voltage		V 100 to 240 Vac	
		Limit voltage		V 85 to 264 Vac 120 to 250 Vdc (1)	
		Current consumption		A 0.55 (100 Vac) 0.35 (240 Vac)	
		Permissible frequencies		Hz 47 to 63	
		Maximum inrush current		A 20	
		Power factor		> 0.5	
		Efficiency at nominal load		> 75%	
		Dissipated power at nominal load		W 6.7	
				> 80%	
				6.2	
Output circuit					
LED indication				Green LED	
Nominal output values		Voltage (U _{out})		V 5 Vdc	
		Current		A 4	
		Power		W 20	
		Output voltage		V Adjustable from 4.75 to 6.25	
		Line and load regulation		± 3%	
		Residual ripple - noise		mV 250	
Holding time for I _{max}		U _{in} min		ms ≥ 10	
Protection		Against short circuits		Permanent	
		Against undervoltages		-	
		Thermal		-	
Operating and environmental specifications					
Connections		Input		AWG (mm ²) 26 to 14 (2 x 0.14 to 2.5) screw terminals	
		Output		AWG (mm ²) 26 to 14 (4 x 0.14 to 2.5) screw terminals	
Mounting		On DIN rail, 35 x 7.5 mm and 35 x 15 mm or on panel (2 x ø 4 mm)			
Operating position		On vertical plane		Vertical	
Connections		Series		Possible	
		Parallel		Possible	
Environment		Operating temperature		°F (°C) -13 to 158 derating from 131 °F (-25 to +70 derating from 55 °C)	
		Storage temperature		°F (°C) -40 to 158 °F (-40 to +70 °C)	
		Maximum relative humidity		90% during operation 95% in storage	
		Degree of protection		IP 20 conforming to IEC 60529	
		Vibration		3 to 11.9 Hz, amplitude 0.14 in (3.5 mm); and 11.9 -150 Hz, acceleration 2 g	
Protection class according to VDE 0106 1		Class II			
Dielectric strength 50 Hz for 1 min		Input/output		V rms 3000 Vac	
Input fuse incorporated		Yes (not interchangeable)			
Emissions according to EN 61000-6-3		Radiation		EN 50081-1 (generic)	
		Conducted on the power line		EN 55022 Class B	
		Harmonic currents		IEC/EN 61000-3-2	
				IEC 61000-6-2 (generic)	
Immunity according to EN 61000-6-2		Electrostatic discharge		IEC/EN 61000-4-2 (6 kV contact/8 kV air)	
		Radiated electromagnetic fields		IEC/EN 61000-4-3 level 3 (10 V/m)	
		Induced electromagnetic fields		IEC/EN 61000-4-6 level 3 (10 V/m)	
		Rapid transients		IEC/EN 61000-4-4 (4 kV)	
		Surges		IEC/EN 61000-4-5 (1 kV)	
		Primary outages		IEC/EN 61000-4-11 (voltage dips and interruptions)	

(1) DC input voltages are not included in cULus, cCSAus, and TÜV certifications.

Output specifications

Behavior when short circuits and overloads occur

Phaseo™ power supplies are equipped with an electronic protection device. When an overload or short circuit occurs, the integrated protection interrupts the current supply before the output voltage drops below 19 V. The output voltage reverts to its nominal value upon elimination of the detected fault, eliminating the need to take any action.

Derating

The ambient temperature is a determining factor which limits the power that an electronic power supply can deliver continuously. Excessively high temperatures around the electronic components significantly reduce their life. The nominal ambient temperature for the Modular range of Phaseo power supplies is 131°F (55 °C). Above this temperature, derating is necessary up to a maximum temperature of 158 °F (70 °C) (except for the **ABL7RM24025** model).

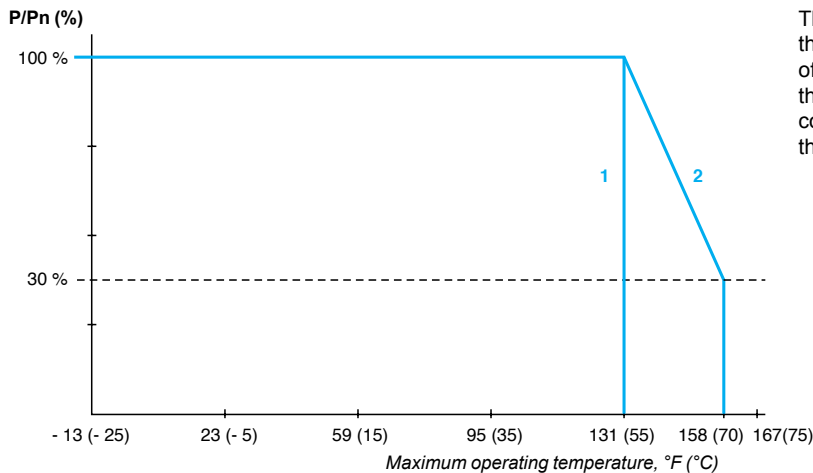

The graph to the left shows the power as a percentage of the nominal power that the power supply can deliver continuously, depending on the ambient temperature.

- 1 With an **ABL7RM24025**
- 2 With an **ABL8MEM●●●●●**

Temporary overloads

The **ABL8MEM●●●●●** Modular range of power supplies have an energy reserve that can be used to supply the application with 125% to 140% of the nominal output current for a maximum of 1 minute, depending on the model.

Series or parallel connection

Series connection

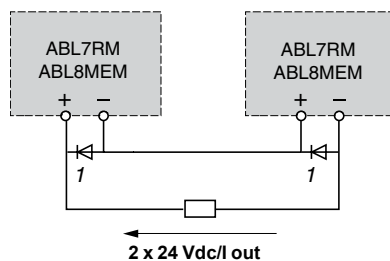

Parallel connection

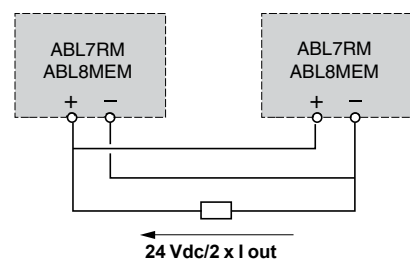

1 Two shottky diodes, I_{min} = power supply I_n , and V_{min} = 50 V

Family	Series	Parallel
ABL7RM / 8MEM	2 products max.	2 products max.

NOTE: Series or parallel connection is recommended only for products with identical catalog numbers.

Selection of protection for the power supply primary

Type of line supply	100 to 240 V ~ single-phase		
Type of protection	Thermal-magnetic circuit-breaker		Class CC fuse
	GB2 (IEC)	C60N (IEC) C60N (UL/CSA)	
ABL8MEM05040	GB2 ●●07 (1)	24581 24517	2 A
ABL8MEM12020			
ABL8MEM24003			
ABL8MEM24006			
ABL8MEM24012			
ABL7RM24025	GB2 ●●08 (1)	24582 24518	3 A

(1) Complete the reference by replacing ●● as required:
 - **CB** for single-pole circuit-breaker with magnetic trip threshold 12 to 16 In
 - **CD** for single-pole + neutral circuit-breaker with magnetic trip threshold 12 to 16 In
 - **DB** for 2-pole circuit-breaker with magnetic trip threshold 12 to 16 In
 - **CS** for single-pole circuit-breaker with magnetic trip threshold 5 to 7 In

Wiring diagrams

GB2CB●●

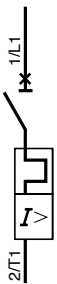

GB2CD●●

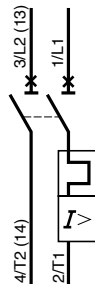

GB2DB●●

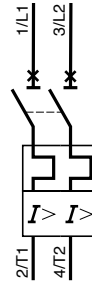

GB2CS●●



References



ABL8MEM05040/12020/24012



ABL8MEM24003/24006



ABL7RM24025

Input voltage	Secondary			Reset	Conforming to standard IEC/EN 61000-3-2 (1)	Reference	Weight lbs (kg)
	Output voltage	Nominal power	Nominal current				
Single-phase (N-L1) or 2-phase (L1-L2) connection							
100 to 240 V -15%, +10% 50/60 Hz	5 V $\overline{\text{---}}$	20 W	4 A	Automatic	Not applicable	ABL8MEM05040	0.51 (0.23)
	12 V $\overline{\text{---}}$	25 W	2 A	Automatic	Not applicable	ABL8MEM12020	0.50 (0.23)
	24 V $\overline{\text{---}}$	7 W	0.3 A	Automatic	Not applicable	ABL8MEM24003	0.28 (0.13)
		15 W	0.6 A	Automatic	Not applicable	ABL8MEM24006	0.29 (0.13)
		30 W	1.2 A	Automatic	Not applicable	ABL8MEM24012	0.51 (0.23)
		60 W	2.5 A	Automatic	Not applicable	ABL7RM24025	0.71 (0.32)

Designation	Use	Order in multiples of	Unit reference	Weight lbs (kg)
Clip-on marker labels	Replacement parts for ABL8MEM power supplies	100	LAD90	0.07 (0.03)

(1) Due to their power < 75 W, the **Modular** range of power supplies is not subject to the requirements of standard IEC/EN 61000-3-2.

Approximate dimensions

ABL8MEM●●●●● / ABL7RM24025 power supply

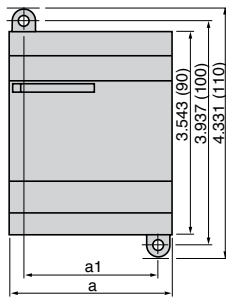
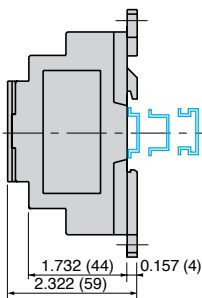

	a	a1
ABL8MEM05040	2.10 (53)	1.65 (42)
ABL8MEM12020	2.10 (53)	1.65 (42)
ABL8MEM24003	1.40 (36)	0.94 (24)
ABL8MEM24006	1.40 (36)	0.94 (24)
ABL8MEM24012	2.10 (53)	1.65 (42)
ABL7RM24025	2.83 (72)	2.36 (60)

in (mm)

Wiring diagrams

ABL8MEM2400●

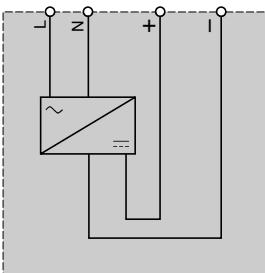

ABL8MEM05040 / 8MEM12020 / 8MEM24012 / 7RM24025

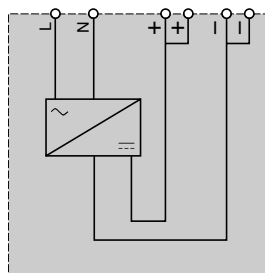

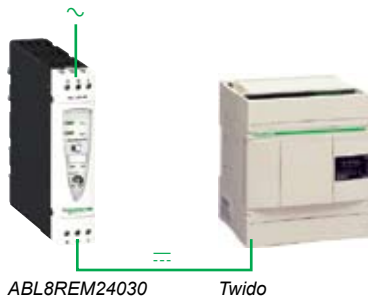

Switch mode power supplies: Optimum range

The **ABL8REM/7RP** power supply offer is designed to provide the DC voltage necessary for the control circuits of automation system equipment consuming 60 to 144 W in 12, 24 and 48 V $\overline{\text{---}}$. Comprised of four products, this range meets the needs encountered in industrial, commercial, and residential applications. With phase-to-neutral (N-L1) or phase-to-phase (1) (L1-L2) connection, these slim electronic switch mode power supplies provide a quality of output current that is suitable for the loads supplied and compatible with both the Twido™ range and the smallest Modicon™ M340™ configurations, making them ideal partners. Their simplified specifications in comparison with the Universal offer also make them the low-cost solution for applications less affected by problems with the line supply, such as harmonic pollution and outages. Clear guidelines are given on selecting the upstream protection devices which are often used with them, and thus a comprehensive solution is provided that can be used in total safety.

The Optimum range of Phaseo™ power supplies delivers a voltage that is precise to 3%, whatever the load and whatever the type of line supply, within a range of 85 to 264 V \sim . Conforming to IEC standards and UL, CSA and TUV certified, they are suitable for global use. They have overload and short-circuit protection.

ABL8REM power supplies do not have anti-harmonic filters and do not satisfy the requirements of standard IEC/EN 61000-3-2 concerning harmonic pollution. **ABL7RP** power supplies, however, are equipped with a PFC (*Power Factor Correction*) filter, thus ensuring compliance with standard IEC/EN 61000-3-2.

The **Optimum** range of Phaseo power supplies includes protection devices to help ensure optimum performance of the automation system with an automatic reset mode on elimination of the detected fault.

In the event of an overload or short-circuit, the integrated protection interrupts the current supply before the output voltage drops below 19 V $\overline{\text{---}}$. The protection device resets itself automatically on elimination of the detected fault, which avoids having to take any action or change a fuse.

All products are equipped with an output voltage adjustment potentiometer in order to be able to compensate for any line voltage drops in installations with long cable runs.

These power supplies are designed for direct mounting on 35 and 75 mm DIN rails.

There are four references available in the **Optimum** range of Phaseo power supplies:

■ ABL8REM24030	72 W	3 A	24 V $\overline{\text{---}}$
■ ABL8REM24050	120 W	5 A	24 V $\overline{\text{---}}$
■ ABL7RP1205	60 W	5 A	12 V $\overline{\text{---}}$
■ ABL7RP4803	144 W	3 A	48 V $\overline{\text{---}}$

Description

- 1 14 AWG (2.5 mm²) enclosed screw terminals for connection of the input voltage (single-phase N-L1, phase-to-phase L1-L2 (1))
- 2 Protective glass flap
- 3 Input voltage status LED (orange).
- 4 Output DC voltage status LED (green).
- 5 Locking catch for the glass flap (sealable)
- 6 Clip-on marker label.
- 7 Output voltage adjustment potentiometer
- 8 14 AWG (2.5 mm²) enclosed screw terminal block for connection of the DC output voltage

(1) 240 V \sim nominal

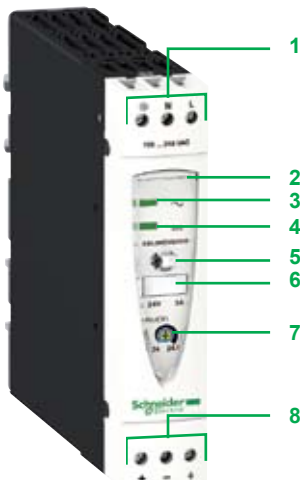

Technical specifications						
Type of power supply			ABL7RP1205	ABL7RP4803	ABL8REM24030	ABL8REM24050
Certifications			cULus 508, cCSAus (CSA22.2 n950-1), File Class, TÜV 60950-1, CE, CTick, RoHS			
Conformity to standards	Safety		IEC/EN 60950, IEC/EN 61496-1-2, SELV			
	EMC		EN 50081-1, IEC 61000-6-2 (EN 50082-2)			
Input circuit						
LED indication			Orange LED			
Input values	Nominal voltage	V	100 to 240 Vac compatible with 110 to 220 Vdc (1)		100 to 240 Vac compatible with 110 to 220 Vdc (1)	
	Limit voltage	V	85 to 264 Vac compatible with 100 to 250 Vdc (1)		85 to 264 Vac single-phase compatible with 100 to 250 Vdc (1)	
Current consumption	$U_{in} = 240 V_{\sim}$	A	0.4	0.6	0.83	1.2
	$U_{in} = 100 V_{\sim}$	A	0.8	1	1.46	1.9
Permissible frequencies		Hz	47 to 63			
Maximum inrush current		A	30			
Power factor			0.98 approx.		0.65 approx.	
Efficiency at nominal load			> 85%			
Dissipated power at nominal load		W	10.6	25.4	12.7	21.2
Output circuit						
LED indication			Green LED			
Nominal output values	Voltage (U_{out})	V	12 Vdc	48 Vdc	24 Vdc	
	Current	A	5	3	3	5
	Power	W	60	144	72	120
Precision	Output voltage	V	Adjustable from 12 to 14.4 Vdc	Adjustable from 48 to 57.6 Vdc	Adjustable from 24 to 28.8 Vdc	
	Line and load regulation		± 3%			
	Residual ripple - noise	mV	< 200 (peak-peak)			
Holding time for I max	$U_{in} = 240 V_{\sim}$	ms	≥ 20		≥ 10	
	$U_{in} = 100 V_{\sim}$	ms	≥ 20		≥ 10	
Protection	Against short circuits		Permanent/automatic or manual restart		Permanent/automatic restart	
	Against overloads		1.1 In			
	Against overvoltages		Tripping if $U_{out} > 1.5 U_n$			
	Against undervoltages		Tripping if $U_{out} < 0.8 U_n$			
Operating and environmental specifications						
Connections	Input	AWG (mm ²)	26 to 14 (2 x 0.14 to 2.5) screw terminals + ground			
	Output	AWG (mm ²)	26 to 14 (2 x 0.14 to 2.5) screw terminals + ground, multiple output, depending on model			
Mounting	On DIN rail	in (mm)	1.38 x.30, 1.38 x.59 and 2.95x.30 (35 x 7.5, 35 x 15 and 75 x 7.5)			
Operating position	On vertical plane		Vertical			
Connections	Series		Possible			
	Parallel		Possible			
Degree of protection			IP 20 conforming to IEC 60529			
Environment	Operating temperature	°F (°C)	32 to 140 derating from 122 °F (0 to +60 derating from 50 °C)			
	Storage temperature	°F (°C)	-13 to 158 °F (-25 to +70 °C)			
	Maximum relative humidity		95% without condensation or dripping water			
	Vibration per to EN 61131-2		3 to 11.9 Hz, amplitude 0.14 in (3.5 mm); and 11.9 to 150 Hz, acceleration 2 g			
Protection class according to VDE 0106 1			Class I			
Dielectric strength 50 and 60 Hz for 1 min	Input/output	V rms	3000 Vac			
	Input/ground	V rms	3000 Vac			
	Output/ground (and output/output)	V rms	500 Vac			
Input fuse incorporated			Yes (not interchangeable)			
Emissions according to EN 61000-6-3	Conducted/radiated		EN 50081-1 (generic)			
			EN 55011/EN 55022 cl. B			
Immunity according to EN 61000-6-2			IEC 61000-6-2 (generic)			
	Electrostatic discharge		IEC/EN 61000-4-2 (6 kV contact/8 kV air)			
	Radiated electromagnetic fields		IEC/EN 61000-4-3 level 3 (10 V/m)			
	Induced electromagnetic fields		IEC/EN 61000-4-6 level 3 (10 V/m)			
	Rapid transients		EN 61000-4-4 level 3 (2 kV)			
	Surges		IEC/EN 61000-4-5 (2 kV)			
	Primary outages		IEC/EN 61000-4-11 (voltage dips and interruptions)			

(1) DC input voltages are not included in cULus, cCSAus, and TÜV certifications.

Phaseo™ power supplies

Regulated switch mode power supplies

ABL7/ABL8 Optimum range

Output specifications

Derating

The ambient temperature is a determining factor which limits the power that an electronic power supply can deliver continuously. Excessively high temperatures around the electronic components significantly reduce their life.

The nominal ambient temperature for the Optimum range Phaseo™ power supplies is 122 °F (50 °C). Above this temperature, derating is necessary up to a maximum temperature of 140 °F (60 °C).

The graph below shows the power as a percentage of the nominal power that the power supply can deliver continuously, depending on the ambient temperature.

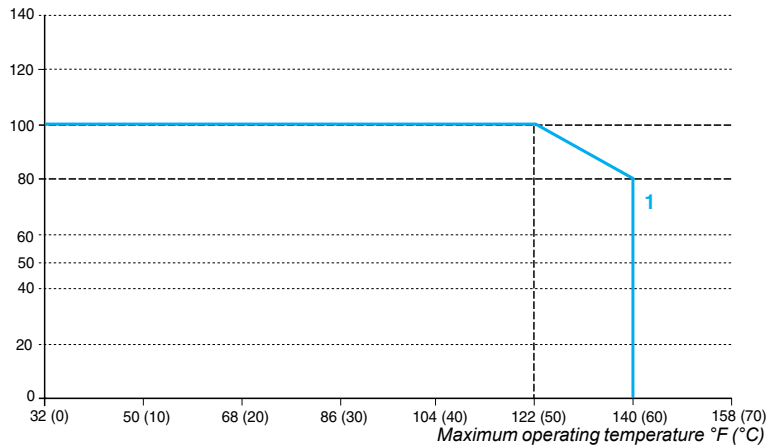

1 ABL8REM, ABL7RP mounted vertically

Derating should be considered in extreme operating conditions:

- Intensive operation (output current permanently close to the nominal current, combined with a high ambient temperature)
- Output voltage set above 24 Vdc (to compensate for line voltage drops, for example)
- Parallel connection to increase the total power

General rules

Intensive operation	See derating in above graph. Example for ABL8REM: <ul style="list-style-type: none"> ■ Without derating, from 32 to 122 °F (0 to 50 °C) ■ Derating of nominal current by 2% per additional °C, up to 60 °C. See chart.
Rise in output voltage	The nominal power is mounted. Increasing the output voltage means that the current delivered must be reduced.
Parallel connection to increase the total power	The total power is equal to the sum of the power supplies used, but the maximum ambient temperature for operation is 122 °F (50 °C). To improve heat dissipation, the power supplies must not be in contact with each other.

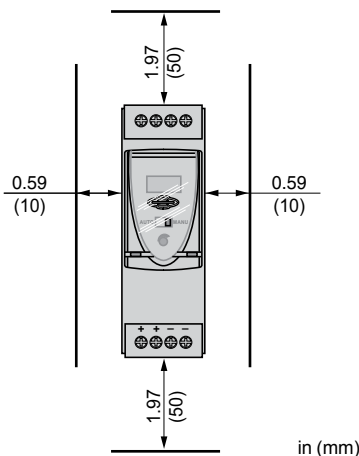

In all cases, there must be adequate convection around the products to assist cooling. There must be sufficient clearance around the Optimum range Phaseo power supplies:

- 1.97 inches (50 mm) above and below
- 0.59 inches (15 mm) on the sides

Output specifications (continued)

Load limit	Temporary overloads
ABL8REM240●● / ABL7RP●●●●	ABL8REM / ABL7RP

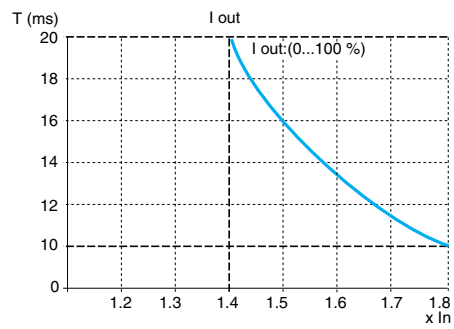
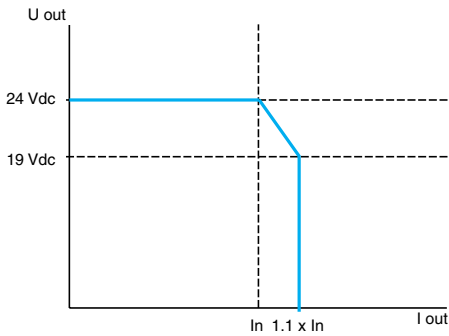

Series or parallel connection

Series connection	Parallel connection
-------------------	---------------------

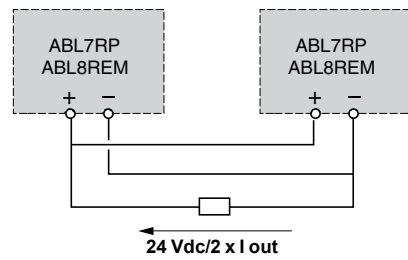
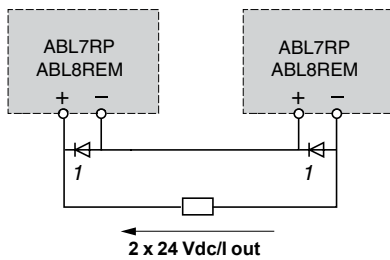

1 Two shottky diodes, I_{min} = power supply I_n , and V_{min} = 50 V

Family	Series	Parallel
ABL8REM / 7RP	2 products max.	2 products max.

Series or parallel connection is recommended only for products with identical catalog numbers.

Selection of protection for the power supply primary

Type of line supply (Single Phase)	100 V ~			240 V ~		
	Thermal-magnetic circuit-breaker		Class CC fuse	Thermal-magnetic circuit-breaker		Class CC fuse
	GB2 (IEC)	C60N (IEC) C60N (UL)		GB2 (IEC)	C60N (IEC) C60N (UL)	
ABL7RP1205	GB2 ●●06 (1)	24580 24516	2 A	GB2 ●●06 (1)	24580 24516	1 A
ABL8REM24030	GB2 ●●07 (1)	24581 24517	2 A	GB2 ●●06 (1)	24580 24516	1 A
ABL8REM24050	GB2 ●●07 (1)	24581 24517	2 A	GB2 ●●06 (1)	24580 24516	1 A
ABL7RP4803	GB2 ●●07 (1)	24581 24517	2 A	GB2 ●●06 (1)	24580 24516	1 A

(1) Complete the reference by replacing ●● with

CB for single-pole circuit-breaker with magnetic trip threshold 12 to 16 In

CD for single-pole + neutral circuit-breaker with magnetic trip threshold 12 to 16 In

DB for 2-pole circuit-breaker with magnetic trip threshold 12 to 16 In

CS for single-pole circuit-breaker with magnetic trip threshold 5 to 7 In

Wiring for GB2●●0● thermal-magnetic circuit protectors

GB2CB●●



GB2CD●●

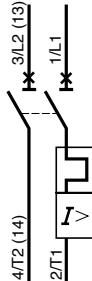

GB2D●●

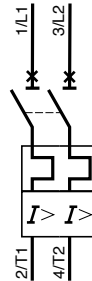

GB2CS●●



Regulated switch mode power supplies: Phaseo™ Optimum range



ABL7RP1205/4803



ABL8REM24030



ABL8REM24050

Input voltage	Secondary			Reset	Conforming to standard CEI/EN 61000-3-2	Reference	Weight lbs (kg)
	Output voltage	Nominal power	Nominal current				
Single-phase (N-L1) or phase-to-phase (L1-L2) connection							
100 to 240 V ~ - 15%, + 10% 50/60 Hz	12 V ☰	60 W	5 A	Automatic or manual	Yes	ABL7RP1205	2.37 (1.08)
	24 V ☰	72 W	3 A	Automatic	No	ABL8REM24030	1.21 (0.55)
		120 W	5 A	Automatic	No	ABL8REM24050	1.75 (0.79)
48 V ☰	144 W	2.5 A		Automatic or manual	Yes	ABL7RP4803	2.37 (1.08)

Approximate dimensions

ABL7RP●●●●
Common side view
Mounted on 35 and 75 mm DIN rails

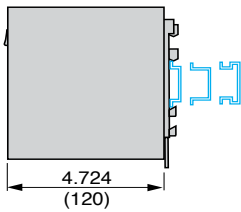

in (mm)

ABL8REM24030

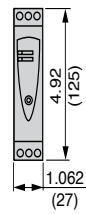

ABL7RP1205/4803

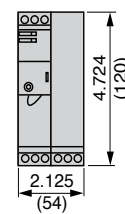

ABL8REM24050

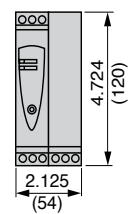

Wiring diagrams

ABL7RP1205 / 48030

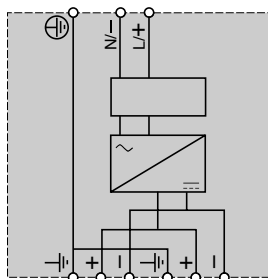

ABL8REM24030

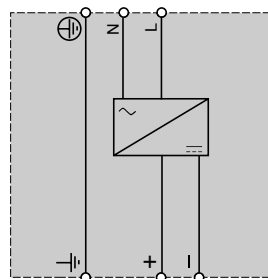

ABL8REM24050

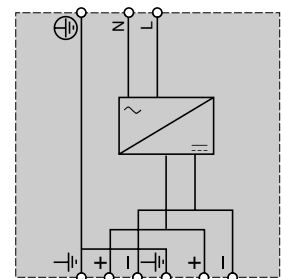

Phaseo™ power supplies

Regulated switch mode power supplies

ABL8 Universal range

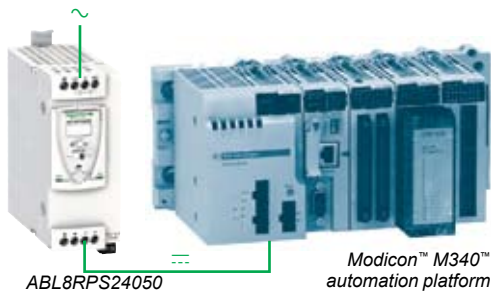

Switch mode power supplies: Universal range

The **ABL8RPS/RPM/WPS** power supply offer is designed to provide the DC voltage necessary for the control circuits of automation system equipment. Comprised of six products, this range meets the needs encountered in industrial and commercial applications. These compact electronic switch mode power supplies provide a quality of output current that is suitable for the loads supplied and compatible with the Modicon™ M340™, Premium™ and Quantum™ ranges. When used with additional function modules, they help ensure continuity of service in the event of network power outages or application malfunctions. Clear guidelines are given on selecting the function modules and upstream protection devices which are often used with them, and thus a comprehensive solution is provided that can be used in total safety.

The Universal range of Phaseo™ power supplies must be connected in phase-to-neutral or phase-to-phase for **ABL8RPS/RPM**, and in three-phase for **ABL8WPS**. They deliver a voltage that is precise to 3%, whatever the load and whatever the type of line supply, within the ranges:

- 85 to 132 V ~ and 170 to 550 V ~ for **ABL8RPS**
- 85 to 132 V ~ and 170 to 264 V ~ for **ABL8RPM**
- 340 to 550 V ~ for **ABL8WPS**

Their very wide input voltage range allows a considerable reduction of parts held in stock and offers a distinct advantage in terms of machine design.

Conforming to IEC standards and UL and CSA certified, they are suitable for global use.

ABL8RPS/RPM and **ABL8WPS** power supplies are all equipped with a harmonic filter, ensuring compliance with standard IEC/EN 61000-3-2 concerning harmonic pollution.

All the Universal range of Phaseo power supplies have protection devices to help ensure optimum performance of the automation system. Their operating mode can be configured as required by the user:

- Manual reset protection mode:** Priority is given to the voltage so as to guarantee the PLC logic states and nominal operation of the supplied actuators.
- Automatic reset protection mode:** Priority is given to the current to allow troubleshooting for example, or to help ensure continuity of service until the arrival of the maintenance team.

The Universal range of Phaseo power supplies also has a power reserve, allowing them to deliver a current of 1.5 I_n at regular intervals. This avoids the need to oversize the power supply if the device has a high inrush current, while ensuring optimum performance of the automation system.

The diagnostics for the Universal range of Phaseo power supplies are available on the front of the device via LEDs (U_{Out} and I_{Out}) and via a dry contact relay.

All products are equipped with an output voltage adjustment potentiometer in order to be able to compensate for any line voltage drops in installations with long connection cable runs.

These power supplies are designed for direct mounting on a 35 mm DIN rail.



Switch mode power supplies: Universal range (continued)

There are four references available in the Universal range of Phaseo™ power supplies for phase-to-neutral or phase-to-phase connection:

■ ABL8RPS24030	72 W	3 A	24 V $\overline{\text{---}}$
■ ABL8RPS24050	120 W	5 A	24 V $\overline{\text{---}}$
■ ABL8RPS24100	240 W	10 A	24 V $\overline{\text{---}}$
■ ABL8RPM24200	480 W	20 A	24 V $\overline{\text{---}}$

The Universal range of Phaseo power supplies also features two references for three-phase connection:

■ ABL8WPS24200	480 W	20 A	24 V $\overline{\text{---}}$
■ ABL8WPS24400	960 W	40 A	24 V $\overline{\text{---}}$

A range of function modules also allows functions to be added to the Universal range of Phaseo power supplies so as to help ensure continuity of service:

- Buffer module or Battery Control modules combined with batteries to help ensure continuity of service in the event of a network power outage
- Redundancy module to meet the most demanding requirements for continuity of service even if the power supply fails
- Converter modules delivering nominal voltages of 5 and 12 V $\overline{\text{---}}$ from the 24 V $\overline{\text{---}}$ output of the Universal range of Phaseo power supplies

Description

Universal range of power supplies

The Universal range of Phaseo regulated switch mode power supplies, **ABL8RPS24●●0/RPM24200/WPS24●●00**, is comprised of:

- 1 Spring clip for 35 mm DIN rail
- 2 12 AWG (4 mm²) enclosed screw terminals for connection of the AC voltage (single-phase, phase-to-phase or three-phase connection)
- 3 Protective glass flap
- 4 Clip-on marker label
- 5 Locking catch for the glass flap (sealable)
- 6 Protection mode selector
- 7 Output voltage adjustment potentiometer
- 8 Output voltage status LED (green and red) (1)
- 9 Output current status LED (green, red and orange)
- 10 Screw terminals for connection of the diagnostic relay contact, except **ABL8RPS24030**
- 11 12 AWG (4 mm²) [8 AWG (10 mm²) on **ABL8WPS24●●00** and **ABL8RPM24200**] enclosed screw terminals for connection of the DC output voltage

(1) See "LED Descriptions" on page 28

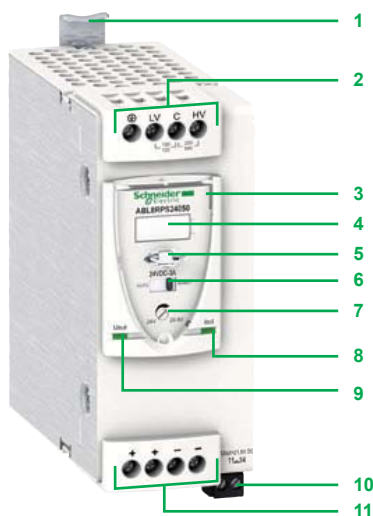

Technical specifications						
Type of power supply		ABL8RPS24030	ABL8RPS24050	ABL8RPS24100	ABL8RPM24200	
Certifications		CB scheme EN 60950-1, cULus 508, cCSAus, CĈ, RoHS				
Conformity to standards	Safety	IEC/EN 60950-1, EN 61204, SELV				
	EMC	EN 61000-6-1, EN 61000-6-2, EN 61000-6-3, EN 61000-6-4, EN 61204-3				
Input circuit						
Input values phase-to-neutral (N-L1) or phase-to-phase (L1-L2)	Nominal voltage	V	100 to 120 / 200 to 500 Vac		100 to 120 / 200 to 240 Vac	
	Limit voltage	V	85 to 132 / 170 to 550 Vac		85 to 132 / 170 to 264 Vac	
	Permissible frequencies	Hz	47 to 63			
	Maximum inrush current	A	30 for 2 ms max.			
	Power factor		0.59 at 120 Vac / 0.51 at 240 Vac		0.69 at 120 Vac / 0.68 at 240 Vac	
	Efficiency at nominal load		> 87 %			> 88 %
	Dissipated power at nominal load	W	7.8	15.5	31	57.6
Anti-harmonic filtering		Yes, via integrated PFC passive filter				
Output circuit						
Compatibility with function modules		Buffer, battery and battery control unit, and redundancy				
Diagnostics	LEDs on front panel		Current (green, orange, and red), voltage (green, red, and off)			
	Relay		–	Relay closed U _{Out} > 21.6 V contact 230 Vac, 0.5 A max; 24 Vdc, 5 mA min		
Nominal output values	Nominal output voltage (U _{Out})	V	24 Vdc			
	Current	A	3	5	10	20
	Power	W	72	120	240	480
Permissible temporary inrush current (boost)	A	1.5 I _n for 4 s maximum				
Precision	Nominal output voltage (U _{Out})	V	Adjustable 24 to 28.8 Vdc			
	Line and load regulation		1 % to 3 %			
	Residual ripple - noise	mV	< 200 (peak-peak)			
Holding time for I max.	U _{in} = 100 Vac	ms	≥ 20			
	U _{in} = 240 Vac	ms	≥ 40			
	U _{in} = 400 Vac	ms	≥ 120			–
Protection	Against short circuits		Permanent, automatic or manual restart			
	Against overloads		< 1.10 I _n (after "boost" function)			
	Against overvoltages	V	30 to 32 Vdc			
	Against undervoltages	V	Tripping if U _{Out} < 21.6 (in manual mode)			
	Thermal		Yes			

LED Descriptions

U out		11	14
	21.6 V ≤ U _{out}		
	7 V ≤ U _{out} < 21.6 V		
	U _{out} < 7 V		

I out	
	I _{out} ≤ I _n
	I _n ≤ I _{out}
	Power supply shut off 0 V / 0 A State of protection

- OFF
- Green
- Orange
- Red

Operating and environmental specifications						
Type of power supply			ABL8RPS24030	ABL8RPS24050	ABL8RPS24100	ABL8RPM24200
Connections	Input	AWG (mm ²)	22 to 12 (2 x 0.5 to 4) screw terminals + ground terminal			
	Output	AWG (mm ²)	24 to 10 (4 x 0.5 to 4) screw terminals + ground terminal			
	Diagnostic relay	AWG (mm ²)	–	14 (2 x 2.5) removable screw terminal block		
Mounting	On DIN rail	in/mm	1.38 x 0.30 and 1.38 x 0.59 (35 x 7.5 and 35 x 15)			
Operating position			Vertical			
Connections	Series		Possible			
	Parallel		Possible			
Degree of protection			IP 20 conforming to IEC 60529			
Environment	Operating temperature	°F (°C)	-13 to 140 derating from 122 °F (-25 to +60 derating from 50 °C)			
	Storage temperature	°F (°C)	-40 to 158 °F (-40 to +70 °C)			
	Maximum relative humidity		90% during operation, 95% in storage			
	Vibration per to EN 61131-2		3 to 11.9 Hz, amplitude 0.14 in (3.5 mm); and 11.9 to 150 Hz, acceleration 2 g			
Protection class		According to VDE 0106 1	Class I			
Dielectric strength 50 Hz for 1 min	Input/output	V rms	4000 Vac			3000 Vac
	Input/ground	V rms	3500 Vac			2500 Vac
	Output/ground	V rms	500 Vac			
Input fuse incorporated			No			
Emissions according to EN 61000-6-3	Radiation		EN 55022 Class B and GL levels			
	Conducted on the power line		EN 55022 Class B and GL levels			
	Harmonic currents		IEC/EN 61000-3-2			
Immunity according to EN 61000-6-2 and GL	Electrostatic discharge		IEC/EN 61000-4-2 (6 kV contact/8 kV air)			
	Radiated electromagnetic fields		IEC/EN 61000-4-3 level 3 (10 V/m)			
	Induced electromagnetic fields		IEC/EN 61000-4-6 level 3 (10 V/m)			
	Rapid transients		IEC/EN 61000-4-4 (4 kV)			
	Surges		IEC/EN 61000-4-5 (2 kV)			
	Primary outages		IEC/EN 61000-4-11 (voltage dips and interruptions)			

Technical specifications				
Type of power supply		ABL8WPS24200	ABL8WPS24400	
Certifications		CB scheme EN 60950-1, cULus 508, cCSAus, CE, RoHS		
Conformity to standards	Safety	EN 60950-1, EN 61204, SELV		
	EMC	EN 61000-6-1, EN 61000-6-2, EN 61000-6-3, EN 61000-6-4, EN 61204-3		
Input circuit				
LED indication		–		
Input values 3 phases (L1-L2-L3)	Nominal values	V	380-500 Vac	
	Permissible values	V	320-550 Vac	
	Permissible frequencies	Hz	47 to 63	
	Maximum inrush current	A	25 for 2 ms max.	
	Power factor		0.65	0.85
	Efficiency at nominal load		> 92%	
Dissipated power at nominal load		W	38.4	76.8
Anti-harmonic filtering		Yes, via integrated PFC passive filter		
Operating mode in the event of phase failure		V	Operation possible for a few minutes then protection trips	
Output circuit				
Compatibility with function modules		Buffer, battery and battery control unit, and redundancy		
Diagnostics	LEDs on front panel	Current (green, orange, and red), voltage (green, red, and off)		
	Relay	Closed relay U _{Out} > 21.6 V, contact 230 Vac, 0.5 A max; 24 Vdc, 5 mA min		
Nominal output values	Output voltage (U _{Out})	V	24 Vdc	
	Current	A	0 to 20	0 to 40
	Power	W	480	960
Permissible temporary inrush current (boost)		A	1.5 I _n for 4 s maximum	
Precision	Output voltage (U _{Out})	V	Adjustable 24 to 28.8 Vdc	
	Line and load regulation		1% to 3%	
	Residual ripple - noise	mV	< 200 (peak-peak)	
Holding time for I max	U _{In} = 400 Vac	ms	≥ 18	≥ 14
	Protection		Permanent, automatic or manual restart	
Protection	Against short circuits		< 1.10 I _n (after "boost" function)	
	Against overloads	V	30 to 32 Vdc	
	Against overvoltages	V	Tripping if U _{Out} < 21.6 (in manual mode)	
	Against undervoltages	V	Yes	
Operating and environmental specifications				
Connections	Input	AWG (mm ²)	22–12 (3 x 0.5 to 4) screw terminals + ground	
	Output	AWG (mm ²)	22–8 (4 x 0.5 to 10) screw terminals	
	Diagnostic relay	AWG (mm ²)	14 (2 x 2.5) removable screw terminal block	
Mounting	On DIN rail	in (mm)	1.38 x 0.30 and 1.38 x 0.59 (35 x 7.5 and 35 x 15)	
Operating position			Vertical	
Connections	Series		Possible	
	Parallel		Possible	
Degree of protection			IP 20 conforming to IEC 60529	
Environment	Operating temperature	°F (°C)	-13 to 140 derating from 122 °F (-25 to +60 derating from 50 °C)	
	Storage temperature	°F (°C)	-40 to 158 °F (-40 to +70 °C)	
	Maximum relative humidity		90% during operation, 95% in storage	
	Vibration per to EN 61131-2		3 to 11.9 Hz, amplitude 0.14 in (3.5 mm); and 11.9 to 150 Hz, acceleration 2 g	
Protection class according to VDE 0106 1			Class I	
Dielectric strength 50 Hz for 1 min	Input/output	V rms	4000 Vac	
	Input/ground	V rms	3500 Vac	
	Output/ground	V rms	500 Vac	
Input fuse incorporated			No	
Emissions according to EN 61000-6-3	Radiation		EN 55022 Class B and GL levels	
	Conducted on the power line		EN 55022 Class B and GL levels	
	Harmonic currents		IEC/EN 61000-3-2	
Immunity according to EN 61000-6-2 and GL	Electrostatic discharge		IEC/EN 61000-4-2 (6 kV contact/8 kV air)	
	Radiated electromagnetic fields		IEC/EN 61000-4-3 level 3 (10 V/m)	
	Induced electromagnetic fields		IEC/EN 61000-4-6 level 3 (10 V/m)	
	Rapid transients		IEC/EN 61000-4-4 (4 kV)	
	Surges		IEC/EN 61000-4-5 (1 kV)	
	Primary outages		IEC/EN 61000-4-11 (voltage dips and interruptions)	

Phaseo™ power supplies

Regulated switch mode power supplies

ABL8 Universal range

Output specifications

Derating

The ambient temperature is a determining factor which limits the power that an electronic power supply can deliver continuously. Excessively high temperatures around the electronic components significantly reduce their life.

The nominal ambient temperature for the Universal range of Phaseo™ power supplies is 122 °F (50 °C). Above this temperature, derating is necessary up to a maximum temperature of 140 °F (60 °C).

The graph below shows the power as a percentage of the nominal power that the power supply can deliver continuously, depending on the ambient temperature.

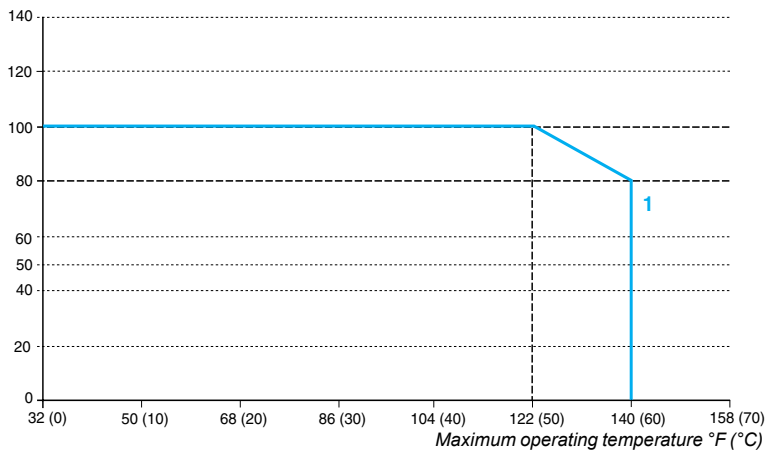

1 ABL8RPM, ABL8RPS, ABL8WPS mounted vertically

Derating should be considered in extreme operating conditions:

- Intensive operation (output current permanently close to the nominal current, combined with a high ambient temperature)
- Output voltage set above 24 Vdc (to compensate for line voltage drops, for example)
- Parallel connection to increase the total power

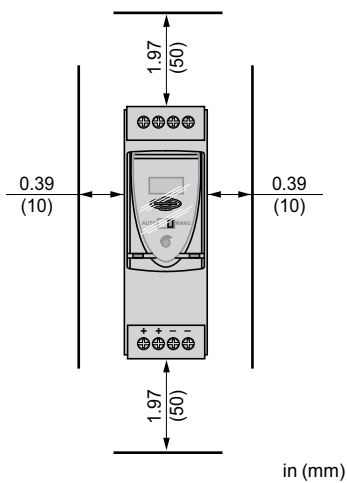

General rules

Intensive operation	See derating in above graph. Example for ABL8RPS: <ul style="list-style-type: none"> ■ Without derating, from 32 to 122 °F (0 to 50 °C) ■ Derating of nominal current by 2% per additional °C, up to 60 °C. See chart.
Rise in output voltage	The nominal power is mounted. Increasing the output voltage means that the current delivered must be reduced.
Mounting	To allow heat dissipation, the power supplies must not be in contact with each other.

In all cases, there must be adequate convection around the products to assist cooling. There must be sufficient clearance around the Universal range Phaseo power supplies:

- 1.97 inches (50 mm) above and below
- 0.39 inches (10 mm) on the sides

Output specifications (continued)

Behavior when overloads occur:

- Automatic reset protection mode (current limiting): If the output current exceeds approximately $1.2 I_n$, the output current is limited to this value. The value of the output voltage can then be less than 21 V but the diagnostic relay opens, allowing the anomaly to be fed back to the automation system. This prevents feedback of any undefined logic state. On elimination of the overload, the output voltage reverts to its preset value.
- Manual reset protection mode (undervoltage detection): If the output current exceeds approximately $1.2 I_n$, the power supply stops completely before the output voltage drops below 21 V and no longer delivers any current. The detected fault is stored in memory as long as voltage is present at the power supply primary. After the primary is de-energized for a few seconds, the power supply will become operational again if the cause of the detected fault has been removed.

In both these modes, any overload of less than $1.5 I_n$ and lasting less than 4 s will be absorbed by the "boost" circuit, and the voltage delivered will stay within the specified limits (adjustment voltage +/- 3%).

Load limit

Manual reset protection mode

ABL8RPM24200 / ABL8RPS24●●● / ABL8WPS24●●●

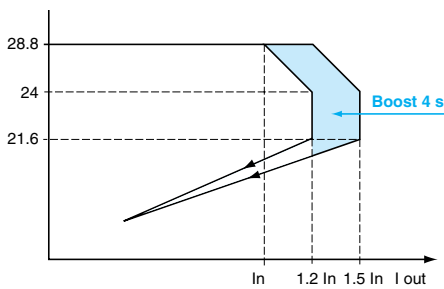

Automatic reset protection mode

ABL8RPM24200 / ABL8RPS24●●● / ABL8WPS24●●●

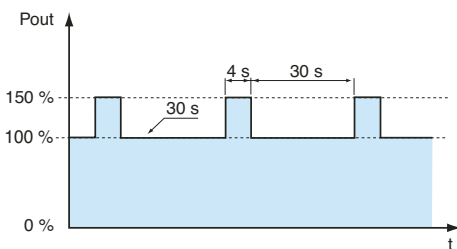
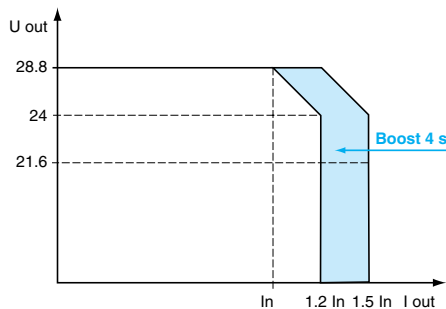

"Boost" repeat accuracy

The ABL8RPS / RPM / WPS Universal range of Phaseo™ power supplies has a power reserve, allowing them to supply the application with energy up to 1.5 times the nominal current at the intervals illustrated by the graph to the left.

The "boost" amplitude and repeat accuracy depend on:

- Overload duration
- Overload intensity
- Period between each consumption peak

When the power supply can no longer cope (repeated overloads, overload duration > 4 seconds, power rating > 150% of nominal power) the integrated protection trips.

Behavior in the event of phase failure on 3-phase power supplies

The ABL8WPS24●00 Universal range of Phaseo power supplies are capable of starting and delivering a nominal current and voltage for a few minutes when failure of one phase occurs. Their protection (thermal) then trips and they are reset automatically or manually, depending upon the operator's presetting.

Output specifications (continued)

Series or parallel connection

Series connection

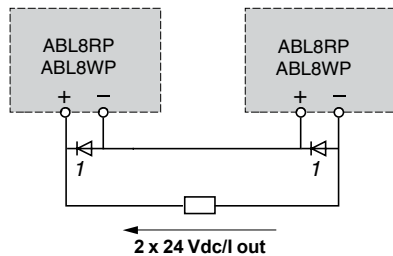

Parallel connection

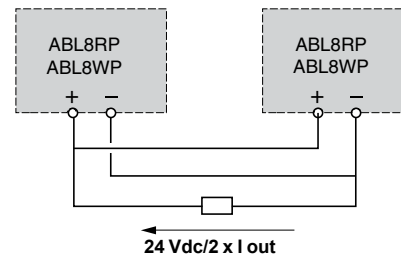

Family	Series	Parallel
ABL8RPS / 8RPM / 8WPS	2 products max.	2 products max.

Note: Series or parallel connection is only recommended for products with identical catalog numbers. For better availability, the power supplies can also be connected in parallel using the ABL8RED24400 Redundancy module.

1 Two shottky diodes, I_{min} = power supply I_n , and V_{min} = 50 V

Selection of the protections on the power supply primary circuit

ABL	~ 115 V				~ 230 V				~ 400 V			
	IEC		UL / CSA (2)		IEC		UL / CSA (2)		IEC		UL / CSA (2)	
8RPS24030	GB2/GV2	GB2 CD07	2 A (8 x 32)	—	2 A (8 x 32)	GB2 CD07	2 A (8 x 32)	—	2 A (8 x 32)	GV2 RT06 (1)	2 A (10,3 x 38,1)	2 A (10,3 x 38,1)
	C60N	2 A C curve	—	24443	—	2 A C curve	—	24443	—	—	—	—
8RPS24050	GB2/GV2	GB2 CD08	4 A (8 x 32)	—	4 A (8 x 32)	GB2 CD07	2 A (8 x 32)	—	2 A (8 x 32)	GV2 RT06 (1)	2 A (10,3 x 38,1)	2 A (10,3 x 38,1)
	C60N	3 A C curve	—	24444	—	2 A C curve	—	24443	—	—	—	—
8RPS24100	GB2/GV2	GB2 CD12	6 A (8 x 32)	—	6 A (8 x 32)	GB2 CD08	4 A (8 x 32)	—	4 A (8 x 32)	GV2 RT07 (1)	4 A (10,3 x 38,1)	4 A (10,3 x 38,1)
	C60N	6 A C curve	—	24447	—	3 A C curve	—	24444	—	—	—	—
8RPM24200	GB2/GV2	GB2 CD16	10 A (8 x 32)	—	10 A (8 x 32)	GB2 CD12	6 A (8 x 32)	—	6 A (8 x 32)	—	—	—
	C60N	10 A C curve	—	24449	—	6 A C curve	—	24447	—	—	—	—
8WPS24200	GB2/GV2	—	—	—	—	—	—	—	—	GV2 ME06	2 A (10,3 x 38,1)	2 A (10,3 x 38,1)
	C60N	—	—	—	—	—	—	—	—	—	—	—
8WPS24400	GB2/GV2	—	—	—	—	—	—	—	—	GV2 ME07	4 A (10,3 x 38,1)	4 A (10,3 x 38,1)
	C60N	—	—	—	—	—	—	—	—	—	—	—

(1)

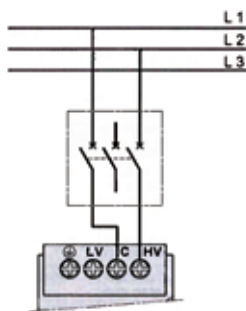

(2) Conformance with UL508 and CSA 22.2 n°14.

Wiring diagrams

GB2CD●●

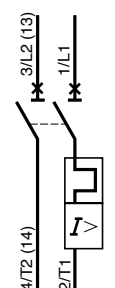

GV2RT●●

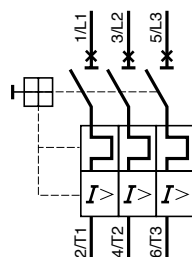

GV2ME●●

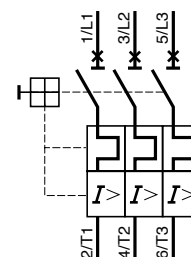

CB scheme EN60950-1, UL, cCSAus, CE, RoHS

Phaseo™ power supplies

Regulated switch mode power supplies

ABL8 Universal range



Regulated switch mode power supplies: Phaseo™ Universal range

Input voltage	Secondary		Reset	Conforming to standard IEC/EN 61000-3-2	Reference	Weight lbs (kg)
	Output voltage	Nominal power				
Single-phase (N-L1) or 2-phase (L1-L2) connection						
100 to 120 V - 200 to 500 V ~ - 15%, + 10% 50/60 Hz	24 to 28.8 V	72 W	3 A	Auto/man	Yes	ABL8RPS24030 1.58 (0.72)
	---	120 W	5 A	Auto/man	Yes	ABL8RPS24050 1.88 (0.85)
	---	240 W	10 A	Auto/man	Yes	ABL8RPS24100 3.50 (1.59)
100 to 120 V/200 to 240 V ~ - 15%, + 10% 50/60 Hz	24 to 28.8 V	480 W	20 A	Auto/man	Yes	ABL8RPM24200 6.20 (2.81)
Three-phase connection (L1-L2-L3)						
380 to 500 V ~ ± 10 % 50/60 Hz	24 to 28.8 V	480 W	20 A	Auto/man	Yes	ABL8WPS24200 4.67 (2.12)
	---	960 W	40 A	Auto/man	Yes	ABL8WPS24400 7.00 (3.18)

Function modules for continuity of service (1)

Function	Use	Designation	Reference	Weight lbs (kg)
Continuity after a power outage (5)	Holding time 100 ms at 40 A and 2 s at 1 A	Buffer module	ABL8BUF24400	3.00 (1.36)
	Holding time 9 min at 40 A to 2 hrs at 1 A (depending on use with a Battery Control module-battery unit and load) (2)	Battery Control module 20 A output current	ABL8BBU24200	2.37 (1.08)
		Battery Control module 40 A output current	ABL8BBU24400	2.63 (1.19)
		3.2 Ah battery module (3)	ABL8BPK24A03	10.69 (4.85)
		7 Ah battery module (3)	ABL8BPK24A03	16.98 (7.70)
	12 Ah battery module (3)	ABL8BPK24A12	25.35 (11.50)	
Continuity after a malfunction (6)	Paralleling and redundancy of the power supply to help ensure uninterrupted operation of the application excluding AC line failures and application overloads	Redundancy module	ABL8RED24400	1.27 (0.58)

DC/DC converters (1) (7)

Primary (4)	Universal range power supply module output current	Secondary		Reference	Weight lbs (kg)
		Output voltage	Nominal current		
24 V --- - 9%, + 24%	2.2 A	5 to 6.5 V ---	6 A	ABL8DCC05060	1.25 (0.57)
	1.7 A	7 to 15 V ---	2 A	ABL8DCC12020	1.22 (0.55)

Separate and replacement parts

Designation	Use	Composition	Reference	Weight lbs (kg)
Fuse assemblies	For ABL8BKP24A●● Battery	4 x 20 A and 6 x 30 A	ABL8FUS02	—
Clip-on marker labels	All products except ABL8PRP24100	Order in multiples of 100	LAD90	0.066 (0.030)
	ABL8PRP24100 selective Protection Module	Order in multiples of 22	ASI20MACC5	—
DIN rail mounting kit	ABL8BPK2403 Battery Module	—	ABL1A02	—
Cables	Connection cable between ABL8BBU and PC for updating the software	RS232 3m	SR2CBL01	0.330 (0.150)
		USB 3m	SR2USB01	0.330 (0.150)
EEPROM memory	Backup and duplication of ABL8 BBU24●00 battery control module parameters	—	SR2MEM02	0.022 (0.010)

- (1) For use with Universal range of Phaseo power supplies.
 (2) For table of compatibility of Battery Control module-battery unit with holding time depending on the load.
 (3) Supplied with 20 or 30 A fuse depending on the model.
 (4) Voltage from a 24 V --- Universal range Phaseo power supply.
 (5) For more information, see page 41.
 (6) For more information, see page 46.
 (7) For more information, see page 36.

Approximate dimensions

ABL8RPS24●●● / ABL8RPM24200 / ABL8WPS24●●●
Common side view

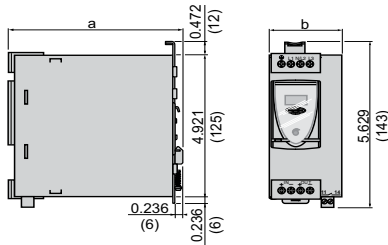

Reference	a	b
ABL8RPS24030	4.48 (114)	1.73 (44)
ABL8RPS24050	4.48 (114)	2.20 (56)
ABL8RPS24100	5.27 (134)	3.35 (85)
ABL8RPM24200	5.86 (149)	5.71 (145)
ABL8WPS24200	5.86 (149)	3.74 (95)
ABL8WPS24400	5.86 (149)	6.50 (165)

in (mm)

ABL8RPS, ABL8WPS, AND ABL7RPM:
cULus File E164867 CNN NMTR and NMTR7
cCSAus-File 238438 Class 3211-07, 5311-07, 5311-87
CB scheme EN 60950-1, CE, RoHS

Wiring diagrams

ABL8RPS24030

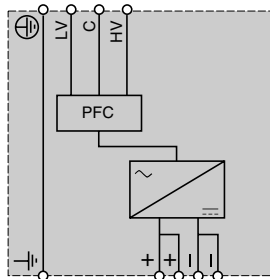

ABL8RPS24050

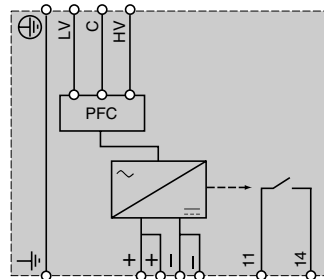

ABL8RPS24100

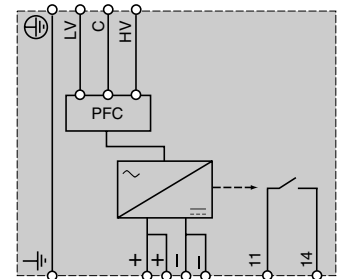

ABL8RPM24200

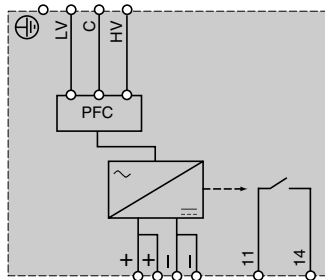

ABL8WPS24200

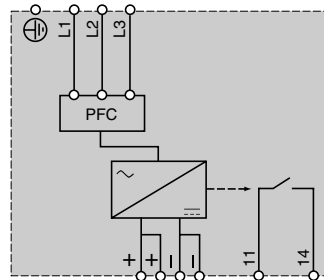

ABL8WPS24400

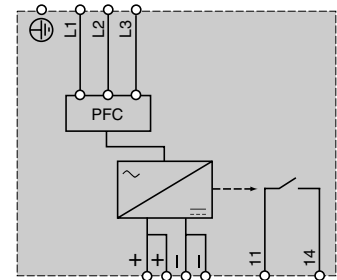

Line supply wiring diagrams

Single-phase (L-N) 100 to 120 V

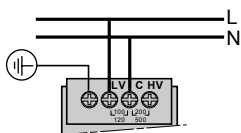

Phase-to-phase (L1-L2) 200 to 500 V

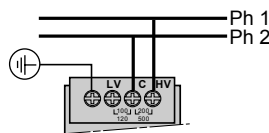

Three-phase (L1-L2-L3) 3 x 380 to 500 V

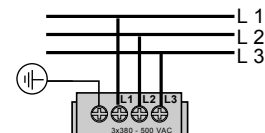

Single-phase (L-N) 200 to 500 V

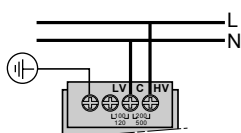

Phaseo™ power supplies

Regulated switch mode power supplies
Function modules (for Universal range):
DC/DC Converter modules

Supplying 5 V $\overline{\text{DC}}$ and 12 V $\overline{\text{DC}}$ auxiliary voltages

The Phaseo™ range offers modules that convert the 24 V $\overline{\text{DC}}$ voltage to a 5 to 15 V $\overline{\text{DC}}$ voltage.

These modules can be used for savings in the:

- Upstream protection normally used with the 5 to 15 V $\overline{\text{DC}}$ power supply
- Connection to the line supply

There are two references available for this solution:

- **ABL8DCC05060** : 5 to 6.5 V $\overline{\text{DC}}$, 6 A converter module
- **ABL8DCC12020** : 7 to 15 V $\overline{\text{DC}}$, 2 A converter module

Description

5 V $\overline{\text{DC}}$ and 12 V $\overline{\text{DC}}$ Converter modules

The **ABL8DCC●●0●0** DC/DC Converter modules include:

- 1 Spring clip for 35 mm DIN rail
- 2 Protective glass flap
- 3 Clip-on marker label
- 4 Locking catch for the glass flap (sealable)
- 5 Output voltage adjustment potentiometer
- 6 Output current status LED (green)
- 7 12 AWG (4 mm²) enclosed screw terminals for connection of the 24 V $\overline{\text{DC}}$ input voltage
- 8 12 AWG (4 mm²) enclosed screw terminals for connection of the 5 V $\overline{\text{DC}}$ or 12 V $\overline{\text{DC}}$ output voltage

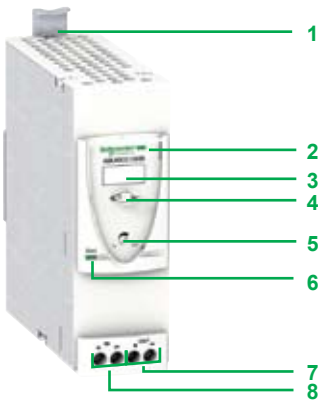

Phaseo™ power supplies

Regulated switch mode power supplies
Function modules (for Universal range):
DC/DC Converter modules

Technical specifications

Type of module		Converter	
		ABL8DCC05060	ABL8DCC12020
Certifications		CB scheme EN60950-1, UL, cCSAus, CE, RoHs	
Conformity to standards	Safety	EN60950-1, EN61204	
	EMC	EN 50081-1, EN61000-6-2, EN61000-6-3	

Input circuit

Input values	Nominal voltage	V	24 to 28.8 Vdc	
	Limit voltage	V	22 to 30 Vdc	
	Protection against reverse polarity		Yes	
	Efficiency at nominal load		> 80%	> 82%
	Dissipated power at nominal load	W	7	4

Output circuit

Diagnosics	LEDs on front panel		Voltage > 4 Vdc (green)	Voltage > 6 Vdc (green)
Nominal output values	Output voltage (U _{Out})	V	5, Adjustable from 5 to 6.5 Vdc	12, Adjustable from 7 to 15 Vdc
	Current	A	6	2
	Power	W	30	24
Precision	Line and load regulation		1 to 3%	
	Residual ripple - noise	mV	< 100	
Protection	Against short circuits		Permanent, automatic restart	
	Against overloads		Permanent, automatic restart I _{Out} > 1.1 I _n	
	Against overvoltages	V	Permanent, automatic restart U _{Out} > 7.8	Permanent, automatic restart U _{Out} > 18
	Thermal		-	

Operating and environmental specifications

Connections	Input	AWG (mm²)	24 to 12 (2 x 0.5 to 4)	
	Output	AWG (mm²)	24 to 12 (2 x 0.5 to 4)	
Mounting	On DIN rail	in (mm)	1.38 x 0.30 and 1.38 x 0.59 (35 x 7.5 and 35 x 15)	
Operating position			Mounted vertically Mounted horizontally with derating of power from 122 to 140 °F (50 to 60 °C) 40% maximum to 140 °F (60°C)	Vertical or horizontal position
Degree of protection			IP 20 conforming to IEC 60529	
Environment	Temperature	Operation	°F (°C) -40 to 185 °F (-40 to +85 °C)	
		Storage	°F (°C) -13 to 140 °F (-25 to +60 °C)	
	Relative humidity	Operation	90%	
		Storage	95%	
	Vibration according to EN 61131-2		3 to 11.9 Hz, amplitude 0.14 in (3.5 mm); 11.9 to 150 Hz, acceleration 2 g	
Protection class			Class III	
Dielectric strength 50 Hz for 1 min	Input/output	V rms	500 Vac	
	Input/ground	V rms	500 Vac	
	Output/ground	V rms	500 Vac	
Emissions according to EN 61000-6-3	Conducted/radiated		EN 55022 - Class B	
Immunity according to EN 61000-6-2	Electrostatic discharge		IEC/EN 61000-4-2 (6 kV contact/8 kV air)	
	Radiated electromagnetic fields		IEC/EN 61000-4-3 level 3 (10 V/m)	
	Induced electromagnetic fields		IEC/EN 61000-4-6 level 3 (10 V/m)	
	Rapid transients		IEC/EN 61000-4-4 level 3 (2 kV)	
	Surges		IEC/EN 61000-4-5 level 2 (1 kV)	

Phaseo™ power supplies

Regulated switch mode power supplies
Function modules (for Universal range):
DC/DC Converter modules



ABL8DCC050060/12020

References

DC/DC converters (for use with Universal range of Phaseo power supplies)					
Primary (1)		Secondary		Reference	Weight
Input voltage	Universal range power supply module output current	Output voltage	Nominal current		lbs (kg)
24 V $\overline{\text{---}}$ -9%, +24%	2.2 A	5 to 6.5 V $\overline{\text{---}}$	6 A	ABL8DCC05060	0.661 (0.300)
	1.7 A	7 to 15 V $\overline{\text{---}}$	2 A	ABL8DCC12020	0.661 (0.300)

Replacement part

Designation	Composition	Unit reference	Weight lbs (kg)
Clip-on marker labels	Order in multiples of 100	LAD90	0.661 (0.300)

(1) Voltage from a 24 V $\overline{\text{---}}$ Phaseo Universal range power supply

Wiring diagram for use with a Universal range power supply

With ABL8DCC●●0●0 Converter module

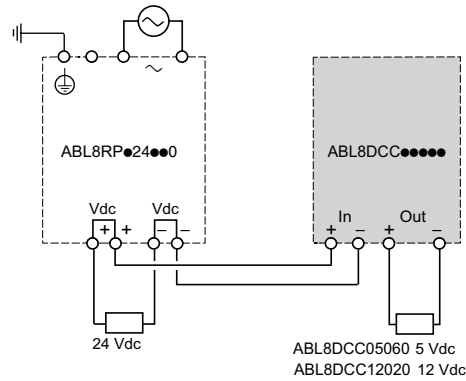

Approximate dimensions

ABL8DCC05060 and ABL8DCC12020 Converter modules

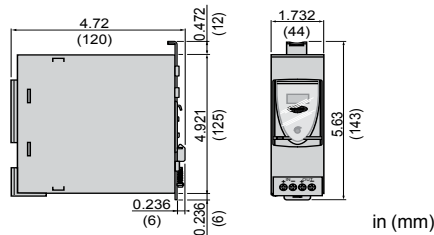

Wiring diagram

ABL8DCC05060 and ABL8DCC12020 Converter modules

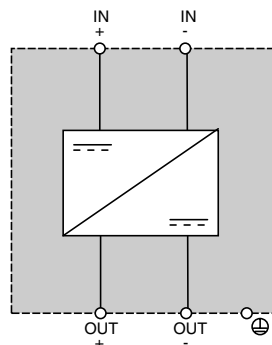

Phaseo™ power supplies

Regulated switch mode power supplies
Function modules (for Universal range):
Buffer modules and Battery Control modules

Introduction

The **ABL8B** Function module offer complements the **ABL8RPS/8RPM/8WPS** regulated switch mode power supply offer, forming a set of solutions to meet the needs for continuity of service in the most demanding applications.

These modules, connected to the electronic switch mode power supply outputs, offer the following solutions:

- Immunity to microbreaks (see below)
- Voltage holding in the event of power outages (see page 40)
- Voltage holding in the event of power supply equipment failure (see page 46)

Continuity of service: Immunity to microbreaks

ABL8RPS/8RPM/8WPS power supplies can deliver their nominal power in the event of a microbreak of less than 20 ms. When outages exceed this value, the **ABL8BUF24400** Buffer Function module, combined with an **ABL8RPS/8RPM/8WPS** power supply, is used. In the event of short interruptions, the Buffer module takes over and continues to provide the 24 V $\bar{\text{=}}$ voltage.

The table below indicates the maximum time for immunity to microbreaks t_1 .

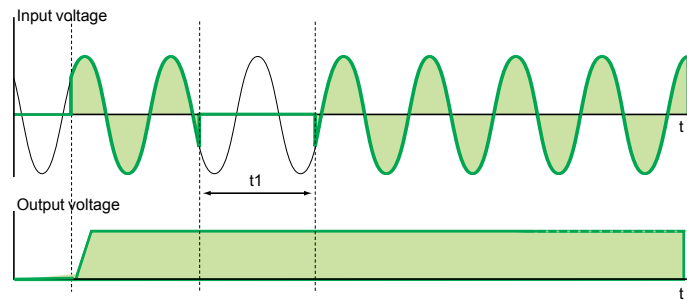

Power supply	Typical time for immunity to microbreaks with Buffer module (40 A) at Un t_1	
	100% load at the Buffer module output	2 A at the Buffer module output
ABL8RPS24030 Single-phase or 2-phase 3 A, 72 W	0.912 s	0.984 s
ABL8RPS24050 Single-phase or 2-phase 5 A, 120 W	0.472 s	1.33 s
ABL8RPS24100 Single-phase or 2-phase 10 A, 240 W	0.220 s	1.34 s
ABL8RPM24200 Single-phase or 2-phase 20 A, 480 W	0.206 s	1.82 s
ABL8WPS24200 3-phase 20 A, 480 W	0.056 s (1)	1.18 s
ABL8WPS24400 3-phase 40 A, 960 W	0.092 s (1)	1.29 s

(1) Values subject to increase significantly. Please consult our website www.schneider-electric.com

Phaseo™ power supplies

Regulated switch mode power supplies

Function modules (for Universal range):

Buffer modules and Battery Control modules

Continuity of service: Immunity to microbreaks (continued)

For applications that are sensitive to unintended stopping, the **ABL8B** range of Function modules offers a solution including:

- Electronic switch mode power supply and Buffer module for holding times t_2 up to two seconds
- Electronic switch mode power supply, Battery Control module and Battery module for holding times t_2 of between two seconds and a few hours

These solutions are used to supply voltage after loss of the line supply, thus enabling saving of current values or fallback of some actuators supplied with 24 V $\overline{\text{---}}$. The table below indicates the possible holding times according to the equipment combinations and the current required.

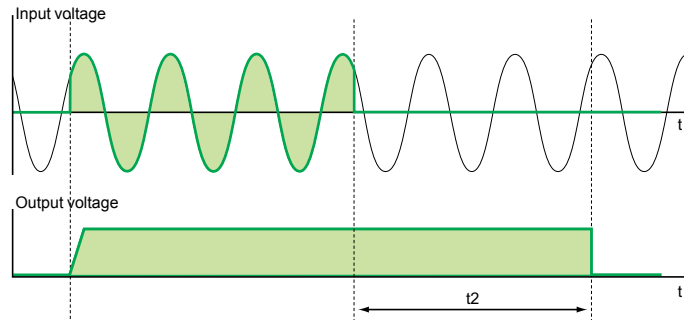

Holding current	Holding time t_2																										
	Seconds										Minutes										Hours						
	0.1	0.2	0.5	1	2	5	10	30	1	2	3	4	5	6	7	8	9	10	15	20	30	40	50	1	2	3	5
1 A	1	1	1	1	1	2+4	2+4	2+4	2+4	2+4	2+4	2+4	2+4	2+4	2+4	2+4	2+4	2+4	2+4	2+4	2+4	2+4	2+4	2+4	2+4	2+5	2+5
2 A	1	1	1	1	1	2+4	2+4	2+4	2+4	2+4	2+4	2+4	2+4	2+4	2+4	2+4	2+4	2+4	2+4	2+4	2+4	2+4	2+4	2+4	2+5	2+6	2+6
3 A	1	1	1	1	2+4	2+4	2+4	2+4	2+4	2+4	2+4	2+4	2+4	2+4	2+4	2+4	2+4	2+4	2+4	2+4	2+4	2+5	2+5	2+5	2+6	2+6	2+6
4 A	1	1	1	1	2+4	2+4	2+4	2+4	2+4	2+4	2+4	2+4	2+4	2+4	2+4	2+4	2+4	2+4	2+4	2+4	2+5	2+5	2+5	2+5	2+6	2+6	2+6
5 A	1	1	1	2+4	2+4	2+4	2+4	2+4	2+4	2+4	2+4	2+4	2+4	2+4	2+4	2+4	2+4	2+4	2+4	2+5	2+5	2+5	2+6	2+6	2+6	2+6	2+6
6 A	1	1	1	2+4	2+4	2+4	2+4	2+4	2+4	2+4	2+4	2+4	2+4	2+4	2+4	2+4	2+4	2+4	2+5	2+5	2+5	2+6	2+6	2+6	2+6	2+6	2+6
7 A	1	1	1	2+4	2+4	2+4	2+4	2+4	2+4	2+4	2+4	2+4	2+4	2+4	2+5	2+5	2+5	2+5	2+5	2+5	2+6	2+6	2+6	2+6	2+6	2+6	2+6
8 A	1	1	1	2+4	2+4	2+4	2+4	2+4	2+4	2+4	2+4	2+4	2+4	2+5	2+5	2+5	2+5	2+5	2+5	2+5	2+6	2+6	2+6	2+6	2+6	2+6	2+6
10 A	1	1	2+4	2+4	2+4	2+4	2+4	2+4	2+4	2+4	2+4	2+4	2+5	2+5	2+5	2+5	2+5	2+5	2+5	2+6	2+6	2+6	2+6	2+6	2+6	2+6	2+6
15 A	1	1	2+4	2+4	2+4	2+4	2+4	2+4	2+4	2+4	2+4	2+5	2+5	2+5	2+5	2+5	2+6	2+6	2+6	2+6	2+6	2+6	2+6	2+6	2+6	2+6	2+6
20 A	1	1	2+5	2+5	2+5	2+5	2+5	2+5	2+5	2+5	2+5	2+5	2+6	2+6	2+6	2+6	2+6	2+6	2+6	2+6	2+6	2+6	2+6	2+6	2+6	2+6	2+6
25 A	1	3+5	3+5	3+5	3+5	3+5	3+5	3+5	3+5	3+5	3+5	3+6	3+6	3+6	3+6	3+6	3+6	3+6	3+6	3+6	3+6	3+6	3+6	3+6	3+6	3+6	3+6
30 A	1	3+5	3+5	3+5	3+5	3+5	3+5	3+5	3+5	3+5	3+6	3+6	3+6	3+6	3+6	3+6	3+6	3+6	3+6	3+6	3+6	3+6	3+6	3+6	3+6	3+6	3+6
35 A	1	3+5	3+5	3+5	3+5	3+5	3+5	3+5	3+5	3+6	3+6	3+6	3+6	3+6	3+6	3+6	3+6	3+6	3+6	3+6	3+6	3+6	3+6	3+6	3+6	3+6	3+6
40 A	1	3+6	3+6	3+6	3+6	3+6	3+6	3+6	3+6	3+6	3+6	3+6	3+6	3+6	3+6	3+6	3+6	3+6	3+6	3+6	3+6	3+6	3+6	3+6	3+6	3+6	3+6

Function modules	Reference	Code
40 A Buffer module	ABL8BUF24400	1
20 A Battery Control module	ABL8BBU24200	2
40 A Battery Control module	ABL8BBU24400	3
3.2 Ah Battery module	ABL8BPK24A03	4
7 Ah Battery module	ABL8BPK24A07	5
12 Ah Battery module	ABL8BPK24A12	6

Note: Several Buffer modules (up to a maximum of three) can be connected in parallel to increase the immunity time. The times given in the table above (boxes marked 1) should be multiplied by the number of modules used (2 or 3).

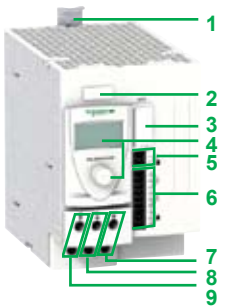

Green: Nominal status/information



Orange: Warning



Red: Detected fault

Examples of Battery Control module diagnostic screens

⚠ In the event of the Battery Control module-Battery module combination not being used for long periods (approximately 1 week minimum) the following is recommended:

- Fully charge the Battery module for at least 72 hours, then
- Remove the fuse(s) from the Battery module(s) and store them in the allocated slots 2

Description

40 A Buffer module

The **ABL8BUF24400** Buffer Function module includes:

- 1 Spring clip for 35 mm DIN rail
- 2 Clip-on marker label
- 3 LED indicator (green): module ready (maximum load)
- 4 8 AWG (10 mm²) enclosed screw terminals for connection of the 24 V $\bar{\text{~}}$ input voltage
- 5 8 AWG (10 mm²) enclosed screw terminals for connection of the 24 V $\bar{\text{~}}$ output voltage
- 6 Removable screw terminal block for connection of the diagnostic contact: module ready (maximum load)

20 A and 40 A Battery Control modules

The **ABL8BBU24●00** Battery control Function modules include:

- 1 Spring clip for 35 mm DIN rail
- 2 Clip-on marker label
- 3 Memory card slot for backup and duplication of the configuration parameters
- 4 Display and configuration parameter browse/selection button
- 5 Removable screw connector for connection of the battery voltage inhibit input (terminal block supplied)
 - ⚠** This contact must always be volt-free.
- 6 Removable screw connector for connection of the diagnostic contacts: power supply presence, battery alarm and presence (terminal block supplied)
- 7 8 AWG (10 mm²) enclosed screw terminals for connection of the 24 V $\bar{\text{~}}$ output voltage
- 8 8 AWG (10 mm²) enclosed screw terminals for connection of the power supply 24 V $\bar{\text{~}}$ input voltage
- 9 8 AWG (10 mm²) enclosed screw terminals for connection of the battery voltage 24 V $\bar{\text{~}}$ input voltage

3.2 Ah, 7 Ah, and 12 Ah Battery modules

The front panel of the **ABL8BPK24A●●** Battery Function modules include:

- 1 Metal box that can be mounted on a vertical or horizontal panel
- 2 Fuse carrier (one or two depending on the model), which, in addition to protecting the output, can be used to disable the battery module (fuse supplied but not fitted)
- 3 8 AWG (10 mm²) enclosed screw terminals for connection of the Battery module 24 V $\bar{\text{~}}$ output voltage (depending on the model, allows two Battery modules to be connected in parallel)
- 4 Fuse storage attachment

Functions

ABL8BBU24●00 Battery Control modules

The main module functions are:

- Charging and checking the associated battery
- Automatic switching between the power supply and the battery in the event of a power outage
- Diagnostics

The Battery Control modules offer a three-color LCD screen and a navigation button that can be used to:

- Display the status and diagnostic data
- Access the service and maintenance functions
- Set the module parameters

These modules also have a diagnostic relay (C/O contacts) relating to:

- Power supply status
- Battery module status
- Alarm

The following functions are available:

- Inhibition or activation (local or remote) of the battery to help ensure the safety of maintenance operations on the application
- Battery test
- Backup and download of a configuration via a memory card enabling storage and duplication of the configuration parameters so as to eliminate repetitive operations when setting up the Battery Control modules

The module parameters can be set in order to define:

- User language
- Rating of the battery connected to the Battery Control module
- Operating temperature for the battery in order to optimize its life
- Length and cross-section of connection to compensate for voltage losses due to length of line
- Duration of the battery-powered supply
- Threshold voltage provided by the power supply below which the battery takes over

Whichever solution is used, the output terminals for the power supplies, Buffer modules and Battery Control modules have been designed to make it easier to isolate a backed-up circuit and a non-backed-up circuit to help ensure discrimination in continuity of service after a power outage.

ABL8BPK24A●● Battery modules

Each Battery module consists of:

- Lead-sealed batteries (two in series)
- Automotive type fuse protection

Only these modules are compatible with the **ABL8BBU** Battery Control modules.

Phaseo™ power supplies

Regulated switch mode power supplies
Function modules (for Universal range):
Buffer modules and Battery Control modules

Technical specifications				
Type of Function module			Buffer module ABL8BUF24400	Battery Control module ABL8BBU24200 ABL8BBU24400
Certifications			CB scheme EN60950-1, cULus 508, cCSAus, CC, RoHS	
Conformity to standards	Safety		EN60950-1, EN61204	
	EMC		IEC/EN61000-6-2, IEC/EN61000-6-3	
Input circuit				
Input values	Nominal voltage	V	24 to 28.8 Vdc	
	Limit voltage	V	22 to 30 Vdc	
	No-load/On-load/Max. consumption	A	0.1/0.6/40.6	0.1/1.7/21.7 0.1/1.7/41.7
	Activation threshold	V	U _{In} - 1 and 22 Vdc min.	Adjustable 22 to 26 Vdc
	Protection against reverse polarity		Yes	
	Dissipated power at nominal load	W	< 15	< 7
Output circuit				
Nominal output values	Voltage (U _{Out})	V	Nominal mode: U _{In} -0.25 Buffer mode: U _{In} -1	Nominal mode: U _{In} -0.25 Battery mode: U _{Battery} -0.5
	Max. current	A	40	20 40
Precision	Residual ripple - noise	mV	< 200	
Holding time	I = 0.5 A		6 s	
	I = 40 A		0.1 s	
Protection	Against short circuits	Power-supplied mode	Permanent, automatic restart	Power supply protection
		Battery-backed mode	–	Permanent, automatic restart
	Against overloads		> 45 A	1.5 I _n
	Against overvoltages	V	–	–
	Against undervoltages	V	Tripping if U _{Out} < 19	–
Thermal		–		
Operating and environmental specifications				
Connections	Input	AWG (mm ²)	20 to 8 (2 x 0.5 to 10) screw terminals	
	Output	AWG (mm ²)	20 to 8 (2 x 0.5 to 10) screw terminals	
Mounting	Diagnostic relay	mm ²	2.5	0.75
	On DIN rail	in (mm)	1.38 x 0.30 and 1.38 x 0.59 (35 x 7.5 and 35 x 15)	
Operating position			Mounted vertically Mounted horizontally (with derating of maximum power by 20% from 50°C)	
Connections	Series		–	
	Parallel		Yes	–
Degree of protection			IP 20 conforming to IEC 60529	
Environment	Temperature	Operation	°F (°C) -13 to 140 °F (-25 to +60 °C)	
		Storage	°F (°C) -40 to 185 °F (-40 to +85 °C)	
	Relative humidity	Operation	90%	
		Storage	95%	
Vibration according to EN 61131-2			3 to 11.9 Hz, amplitude 0.14 in (3.5 mm); 11.9 to 150 Hz, acceleration 2 g	
Protection class according to VDE 0106 1			Class II	
Charging time		s	< 25	Depending on the battery used
Control input			–	Battery inhibit input /OFF: terminals 1 and 2 linked = battery off This contact must always be volt-free.
Diagnostics	Via LED		Green: Buffer ready Off: Load < 95%	–
	LCD screen		–	Green: nominal status, orange: warning, red: detected fault
	Via relay		Open: Load < 95% Closed: Buffer ready	3 C/O relays: for power supply status, battery and alarm status PSU: relay tripped (contact 1-2 closed): 24 V present on In input : relay tripped (contact 4-5 closed): backup mode, current supplied by the battery Alarm: relay tripped (contact 7-8 closed): battery charge < 80% battery off or disconnected
Relay characteristic			230 Vac 0.5 A, 24 Vdc 5 mAmin.	
Dielectric strength 50 Hz for 1 min	Input/ground	V rms	500 Vac	
	Output/ground	V rms	500 Vac	
Emissions according to EN 61000-6-3			EN 55022 - Class B	
Immunity according to EN 61000-6-2	Electrostatic discharge		IEC/EN 61000-4-2 (6 kV contact/8 kV air)	
	Radiated electromagnetic fields		IEC/EN 61000-4-3 level 3 (10 V/m)	
	Induced electromagnetic fields		IEC/EN 61000-4-6 level 3 (10 V/m)	
	Rapid transients		IEC/EN 61000-4-4 level 3 (2 kV)	
	Surges		IEC/EN 61000-4-5 level 2 (1 kV)	

Phaseo™ power supplies

Regulated switch mode power supplies
Function modules (for Universal range):
Buffer modules and Battery Control modules

Technical specifications					
Type of Function module		Battery	ABL8BPK24A03	ABL8BPK24A07	ABL8BPK24A12
Battery type		Lead-sealed battery			
Certifications		Certification pending			
Conformity to standards		Safety	Conformity pending		
Input circuit					
Input values	Nominal voltage	V	24 to 28.8 Vdc		
	Limit voltage	V	22 to 29 Vdc		
	Load current	A	0.3	0.7	1.2
	Protection against reverse polarity		Yes		
	Charging time	h	72 max.		
Output circuit					
Nominal output values	Voltage (Un)	V	24 Vdc		
	Max. current	A	32	40	75
	Capacity	Ah	3.2	7	12
Holding time at 20°C	Maximum	h	20 at 0.16 A	20 at 0.35 A	20 at 0.6 A
	Minimum	min	5 at 8.4 A	5 at 18.2 A	5 at 31.3 A
Protection	Against short circuits and overloads by automotive type fuse protection		1 x 20 A	1 x 30 A	2 x 30 A
	Self-discharge rate	1 month	3%		
		3 months	9%		
		6 months	15%		
Operating and environmental specifications					
Connections	Input	AWG (mm ²)	20 to 8 (2 x 0.5 to 10)		20 to 8 (4 x 0.5 to 10)
	Output	AWG (mm ²)	20 to 8 (2 x 0.5 to 10)		20 to 8 (4 x 0.5 to 10)
Mounting	On DIN rail	in (mm)	1.38 x 0.30 and 1.38 x 0.59 (35 x 7.5 and 35 x 15)		–
	On vertical panel		With 4 screws ϕ 5 mm		
	On horizontal panel		With 2 screws ϕ 5 mm		
Operating position			Vertical or horizontal		
Connections	Series		–		
	Parallel		Yes		
Degree of protection			IP 10 conforming to IEC 60529		
Environment	Temperature	Operation	°F (°C)	32 to 104 °F (0 to +40 °C)	
		Storage	°F (°C)	-4 to 122 °F (-20 to +50 °C)	
	Vibration according to EN 61131-2			3 to 11.9 Hz, amplitude 3.5 mm; and 11.9 to 150 Hz, acceleration 2 g	
Protection class according to VDE 0106 1			Class III		
Service life (approximate)	68 °F (20 °C)	h	44,000		
	77 °F (25 °C)	h	31,000		
	86 °F (30 °C)	h	22,000		
	95 °F (35 °C)	h	15,000		
	104 °F (40 °C)	h	11,000		
	113 °F (45 °C)	h	7,300		
	122 °F (50 °C)	h	5,000		

Phaseo™ power supplies

Regulated switch mode power supplies
Function modules (for Universal range):
Buffer modules and Battery Control modules



ABL8BUF24400



ABL8BBU24200



ABL8BBU24200

References

Function modules

Function	Use	Designation	Reference	Weight lbs (kg)
Continuity after a power outage	Holding time 100 ms at 40 A and 2 s at 1 A	Buffer module	ABL8BUF24400	2.645 (1.200)
	Holding time 9 min at 40 A to 2 hrs at 1 A (depending on use with a battery control module-battery unit and load) (1)	Battery Control module	ABL8BBU24200	1.102 (0.500)
		Battery Control module, 40 A output current	ABL8BBU24400	1.543 (0.700)
		3.2 Ah battery module (2)	ABL8BPK24A03	7.716 (3.500)
		7 Ah battery module (2)	ABL8BPK24A07	14.330 (6.500)
		12 Ah battery module (2)	ABL8BPK24A12	26.455 (12.000)

Separate and replacement parts

Designation	Description	Composition	Unit reference	Weight lbs (kg)
Fuse assemblies	For ABL8BPK24A●● battery	4 x 20 A and 6 x 30 A	ABL8FUS02	–
Clip-on marker labels	All products except ABL8PRP24100	Order in multiples of 100	LAD90	0.066 (0.030)
Kit for mounting on DIN rail	For ABL8BPK2403 Battery module	–	ABL1A02	–
Cables	Connection cable between ABL8BBU and PC for updating the software	RS232 3 m	SR2CBL01	0.330 (0.150)
		USB 3 m	SR2USB01	0.330 (0.150)
EEPROM memory	Backup and duplication of ABL8 BBU parameters	–	SR2MEM02	0.022 (0.010)

(1) See page 40 for details.

(2) Supplied with 20 or 30 A fuse depending on the model.

Wiring diagrams for use with Universal range power supplies

With ABL8BUF24400 Buffer module

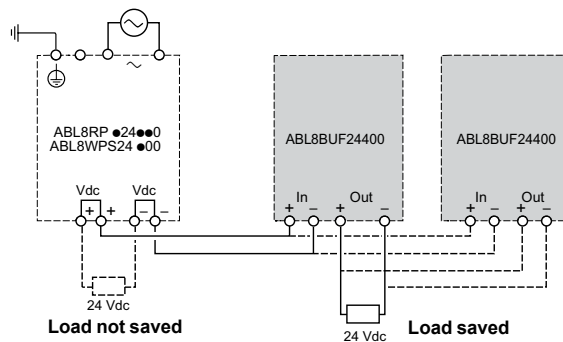

With ABL8BBU24●00 Battery Control module

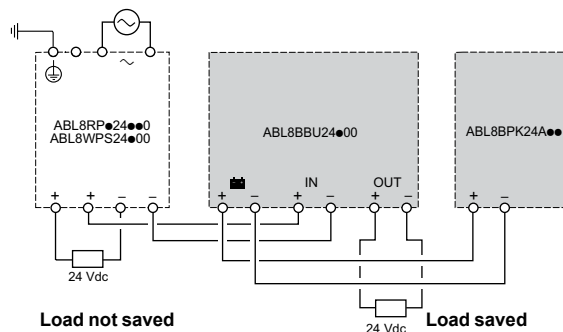

ABL8BUF2440
cULus File E164867 CCN
NMTR and NMTR7

cCSAus File 238438 Class
5311-07 and 5311-87

ABL8BBU
UL Listed File E164867 CCN
NMTR

Approximate dimensions

ABL8BUF24400 Buffer module

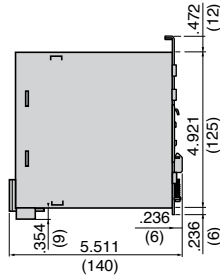

ABL8BBU24200 Battery Control module

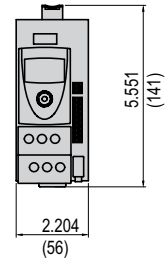
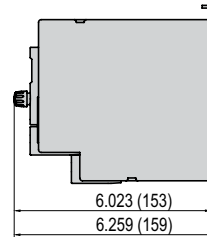
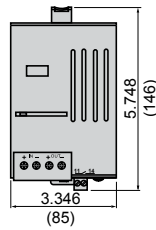

ABL8BBU24400 Battery Control module

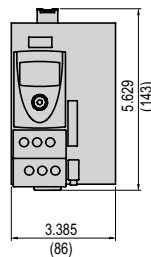
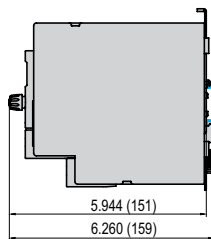

ABL8BPK24A03/A07/A12 Battery modules

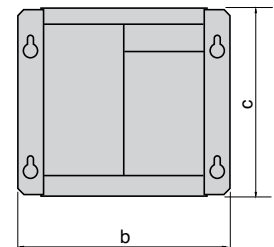
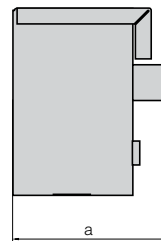

in (mm)

Reference	a	b	c
ABL8BPK24A03	3.83 (97)	7.24 (184)	5.45 (138)
ABL8BPK24A07	5.16 (131)	6.69 (170)	5.98 (152)
ABL8BPK24A12	5.16 (131)	9.29 (236)	6.12 (155)

in (mm)

Wiring diagrams

ABL8BUF24400 Buffer module

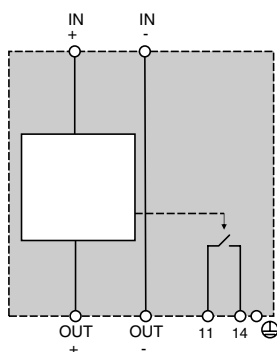

ABL8BBU24200 and ABL8BBU24400 Battery Control modules

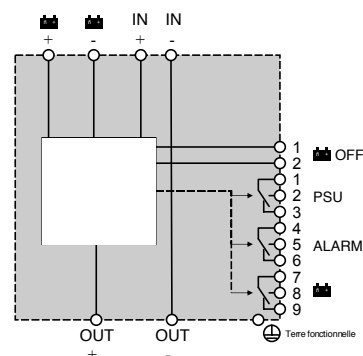

Phaseo™ power supplies

Regulated switch mode power supplies
Function modules (for Universal range):
Redundancy module

Continuity of service: Failure of power supply equipment

Where continuous operation of the application is the prime concern, it is necessary to help ensure that when one power supply malfunctions, a second power supply takes over. The **ABL8RED24400** Redundancy module can perform this function, ensuring that the failure of one power supply does not disturb the second (for example, in the event of a short-circuit of one of the power supply outputs).

The **ABL8RED24400** Redundancy module, used with two electronic switch mode power supplies of the same type, can be used to supply the nominal power to the application even if one of the power supplies fails.

The various diagnostics - on the front panel (LED) and remote (relay) - inform the maintenance team as soon as the first detected fault occurs on one of the power supplies.

When continuity of service is critical for the application, it may be necessary to provide redundancy for the Redundancy module.

Note: The Redundancy module can be used to connect two power supplies with a maximum rating of 20 A in parallel. To connect two 40 A **ABL8WPS24400** power supplies, two **ABL8RED24400** Redundancy modules must be used.



Description

2 x 20 A Redundancy module

The **ABL8RED24400** Redundancy Function module includes:

- 1 Spring clip for 35 mm DIN rail
- 2 Clip-on marker label
- 3 Input voltage status LED (green) for the first 24 V $\overline{\text{---}}$ power supply
- 4 Input voltage status LED (green) for the second 24 V $\overline{\text{---}}$ power supply
- 5 8 AWG (10 mm²) enclosed screw terminals for connection of the 24 V $\overline{\text{---}}$ output voltage
- 6 8 AWG (10 mm²) enclosed screw terminals for connection of the input voltage for the second 24 V $\overline{\text{---}}$ power supply ($I \leq 20$ A)
- 7 8 AWG (10 mm²) enclosed screw terminals for connection of the input voltage for the first 24 V $\overline{\text{---}}$ power supply ($I \leq 20$ A)
- 8 Removable screw terminal block for connection of the diagnostic contact: power supply connected to a faulty input

Phaseo™ power supplies

Regulated switch mode power supplies
Function modules (for Universal range):
Redundancy module

Technical specifications			
Type of Function module		Redundancy ABL8RED24400	
Certifications		CB scheme EN60950-1, cULus 508, cCSAus, CE, RoHS	
Conformity to standards	Safety	EN60950-1, EN61204	
	EMC	EN61000-6-2, EN61000-6-3	
Input circuit			
Input values	Nominal voltage (U _{In})	V	24–28.8 Vdc
	Limit voltage	V	22–30 Vdc
	Input limit current	A	20 per input
	Protection against reverse polarity		Yes
Output circuit			
Nominal output values	Output voltage (U _{Out})	V	U _{In} - 0.2
	Max. current (I _{Out})	A	40
Number of channels		1	
Protection	Against short circuits	Provided by the power supply	
	Against overloads	Manual, provided by the power supply	
Operating and environmental specifications			
Connections	Input	AWG (mm ²)	20–8 (2 x 0.5 to 10)
	Output	AWG (mm ²)	20–8 (2 x 0.5 to 10)
	Diagnostic relay	(mm ²)	2.5
Mounting	On DIN rail	in (mm)	1.38 x 0.30 and 1.38 x 0.59 (35 x 7.5 and 35 x 15)
Operating position		Vertical or horizontal position	
Connections	Series	—	
	Parallel	Yes for 2 x 40 A	
Degree of protection		IP 20 conforming to IEC 60529	
Environment	Temperature	Operation	°F (°C) -13 to 140 °F (-25 to +60 °C)
		Storage	°F (°C) -40 to 185 °F (-40 to +85 °C)
	Relative humidity	Operation	90%
		Storage	95%
Vibration according to EN 61131-2		3–11.9 Hz, amplitude 0.14 in (3.5 mm); 11.9–150 Hz, acceleration 2 g	
Protection class according to VDE 0106 1		Class II	
Diagnostics	Via LED	1 LED per input Green: power supply operational	
	Via relay	Closed: 2 power supplies operational	
Dielectric strength 50 Hz for 1 min	Input/output	V rms	No isolation
	Input/ground	V rms	500 Vac
	Output/ground	V rms	500 Vac
Emissions according to EN 61000-6-3		Conducted/radiated EN 55022 - Class B	
Immunity according to EN 61000-6-2	Electrostatic discharge	IEC/EN 61000-4-2 (6 kV contact/8 kV air)	
	Radiated electromagnetic fields	IEC/EN 61000-4-3 level 3 (10 V/m)	
	Induced electromagnetic fields	IEC/EN 61000-4-6 level 3 (10 V/m)	
	Rapid transients	IEC/EN 61000-4-4 level 3 (2 kV)	
	Surges	IEC/EN 61000-4-5 level 2 (1 kV)	

Phaseo™ power supplies

Regulated switch mode power supplies
Function modules (for Universal range):
Redundancy module



ABL8RED24400

Function module

Function	Use	Designation	Reference	Weight lbs (kg)
Continuity after a failure	Paralleling and redundancy of the power supply to help ensure uninterrupted operation of the application excluding AC line failures and application overloads	Redundancy module	ABL8RED24400	1.54 (0.700)

Replacement part

Designation	Composition	Unit reference	Weight lbs (kg)
Clip-on marker labels	Order in multiples of 100	LAD90	0.07 (0.030)

Wiring diagrams for use with Universal range power supplies

With ABL8RED24400 Redundancy module
ABL8RPS24●●●/ABL8RPM24200/ABL8WPS24200 **ABL8WPS24400 or full system redundancy**

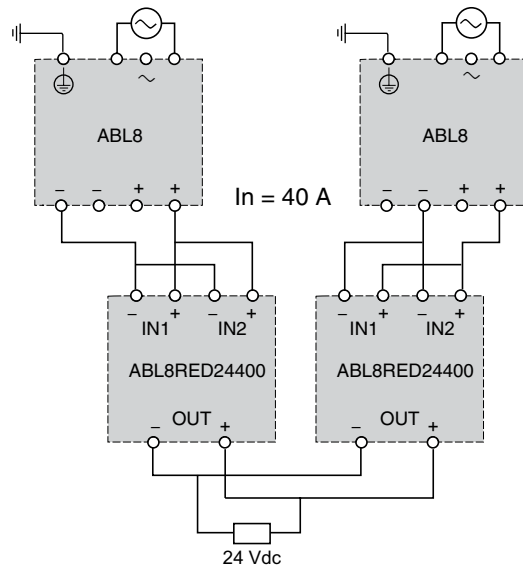
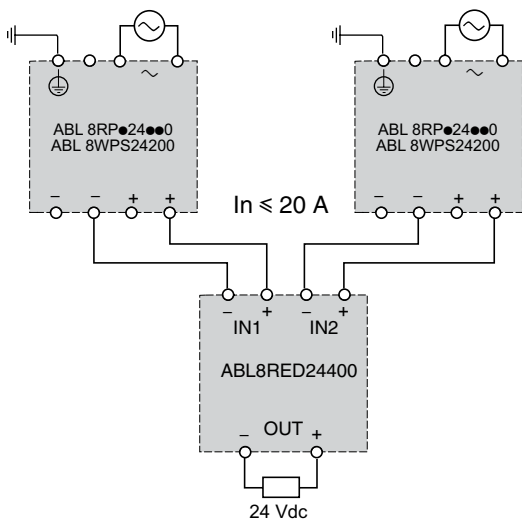

cULus File E164867 CCN NMTR and NMTR7
 cCSAus File 238438 Class 5311-87

Approximate dimensions

ABL8RED24400 Redundancy module

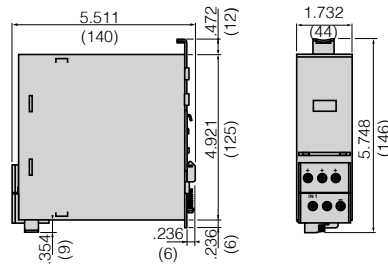

In/(mm)

Wiring diagram

ABL8RED24400 Redundancy module

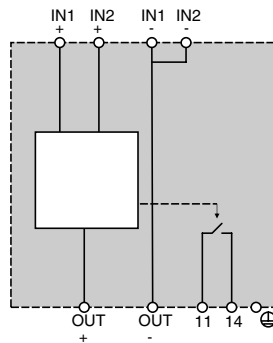

Phaseo™ power supplies

Regulated switch mode power supplies

ABL1 Dedicated range



Introduction

ABL1REM/RPM Phaseo™ Dedicated range regulated switch mode power supplies are specially designed to provide the DC voltage necessary for electrical equipment operating on a safety extra low voltage (SELV). Split into two ranges, they are able to meet all the needs encountered in standard commercial machines.

These single-phase power supplies, with or without anti-harmonic distortion filter, conform to world-wide standards. Switch mode technology provides the quality of the output current with regulation below 3%.

As machine components, **ABL1REM/RPM** Phaseo Dedicated range power supplies are easy to install; only the set-up may vary from one application to another. The ABL1 range has been specially designed for machine manufacturers.

ABL1REM/RPM regulated switch mode power supplies are totally electronic and regulated. They provide the following benefits:

- Wide input voltage range from 85 to 264 V ~ and 120 to 370 V ~ (not indicated on the product).
- Several products with anti-harmonic distortion input filter.
- High degree of output voltage stability, adjustable by potentiometer.
- Built-in thermal overload protection.
- Conformity to world-wide standards.
- Conformity to standard EN 55022 class B.
- UL 508, CSA and TÜV certifications.
- Overload and short-circuit protection.
- Considerably reduced weight.
- Identical mounting accessories for all models.

ABL1 power supplies for electrical equipment are divided into two ranges :

- **ABL1REM**, single-phase:
 - 60 W for the 12 V ~ version,
 - 60 W, 100 W, 150 W and 240 W for the 24 V ~ versions.
- **ABL1RPM**, single-phase with anti-harmonic distortion filter:
 - 100 W for the 12 V ~ version,
 - 100 W, 150 W and 240 W for the 24 V ~ versions.

Electromagnetic compatibility

Levels of conducted and radiated emissions are defined in standards EN 55011 and EN 55022.

The products in the ABL1 range are class B, the strictest level, and can be used without any restrictions due to their low emissions.

Behavior in the event of short-circuits

ABL1 power supplies are equipped with electronic and thermal overload protection. This protection resets itself automatically on elimination of the detected fault, which avoids having to take any action or change a fuse.

Description

ABL1REM/RPM regulated switch mode power supplies include:

- 1 Two mounting holes for M4 x 20 screws.
- 2 115/230 V input voltage selector (on 150 W and 240 W versions only).
- 3 12 AWG (4 mm²) screw clamp terminal block for connection of the AC input voltage and DC output voltage.
- 4 Green LED indicating presence of the DC output voltage.
- 5 Output voltage adjustment potentiometer ($\pm 10\%$).
- 6 Removable, transparent, clip-on cover.

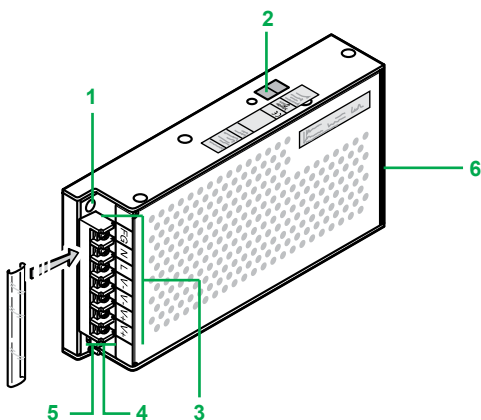

Technical specifications												
Type of power supply			ABL1REM 12050 24025 24042 24062 24100				ABL1RPM 12083 24042 24062 24100					
Product certifications/markings			cULus 508, cCSAus, CSA 22.2 n° 60950-1, UL 60950-1, TÜV, CTick, RoHS, CE									
Conforming to standards	Safety		IEC/EN 60950-1, SELV									
	Generic EMC		EN 50081-1, IEC 61000-6-2 (EN 50082-2), IEC/EN 61000-6-3									
	Low frequency harmonic currents		-				IEC/EN 61000-3-2					
Input circuit												
LED indication			-									
Input voltages	Nominal voltage		V	100 to 240 Vac		100 to 120 Vac 200 to 240 Vac		100 to 240 Vac		100 to 120 Vac 200 to 240 Vac		
	Limit voltage	Vac	V	85 to 264 Vac		85 to 132/170 to 264 Vac		85 to 264 Vac		85 to 132/170 to 264 Vac		
		Vdc compatible	V	120 to 370 Vdc		180 to 370 Vdc ¹		120 to 370 Vdc ¹		180 to 370 Vdc ¹		
	Current consumption	U _{in} = 240 V	A	1	0.7	2.5	3	0.7	2.5	3		
		U _{in} = 100 V	A	2	1.4	5	6	1.7	5	6		
	Permissible frequencies		Hz	47 to 63								
	Maximum inrush current		A	50								
	Power factor			0.65 approx.				0.7 to 0.95 approx. (depending on model)				
	Efficiency at nominal load			> 80%								
	Dissipated power at nominal load		W	15	25	37.5	60	25	37.5	60		
Output circuit												
LED indication			Green LED									
Nominal output values	Voltage (U _{out})		V	2 Vdc 24 Vdc				12 Vdc 24 Vdc				
	Current		A	5	2.5	4.2	6.2	10	8.3	4.2	6.2	10
	Power		W	60	100	150	240	100	150	240		
Precision	Adjustable output voltage		V	10.8–13.2 21.6–26.4				10.8–13.2 21.6–26.4				
	Line and load regulation			± 3%								
Residual ripple - noise		mV	< 200 (peak-peak)									
Holding time for I max.	U _{in} = 240 V		ms	≥ 40								
	U _{in} = 100 V		ms	≥ 10								
Protection	Against shorts circuits			Permanent, automatic restart								
	Against overloads			1.1 to 1.5 I _n								
	Against undervoltages			U > 1.25 U _{out}								
	Thermal			Yes (limiting operation above a temperature between 50 and 60 °C, depending on the load rating)								
Operating and environmental specifications												
Connections	Input		AWG (mm ²)	12 (2 + ground) x 4								
	Output		AWG (mm ²)	12 (2 x 4)		12 (4 x 4)						
Mounting			On panel or on ABL1A01 reversible mounting bracket									
Operating position			All positions with derating									
Connections	Series		Possible (2 max.)									
	Parallel		Possible (2 max.)									
Degree of protection			IP 20, conforming to standard IEC/EN 60950 with clip-on cover over connection terminal block									
Overvoltage category			II									
Environment	Temperature	Operating	°F (°C)	32 to 140 derating from 113 °F (0 to + 60 derating from 45 °C)								
		Storage	°F (°C)	-13 to 185 °F (-25 to +85 °C)								
	Max. relative humidity			20 to 90%								
Vibrations, per EN 61131-2			5 to 9 Hz, amplitude 0.14 in (3.5 mm); and 9 to 150 Hz, acceleration 2 g									
Protection class			According to VDE 0106 1 Class 1									
Degree of pollution			2									
Dielectric strength 50 and 60 Hz for 1 min	Input/output		V rms	3000 Vac								
	Input/ground		V rms	1500 Vac								
	Output/ground		V rms	500 Vac								
Input fuse incorporated			Yes (not interchangeable)									
Emissions according to EN 61000-6-3	Conducted/radiated		IEC/EN 61000-6-3 (generic)									
			IEC/EN 55011, IEC/EN 55022 class B									
Immunity according to EN 61000-6-2			IEC/EN 61000-6-2 (generic)									
	Electrostatic discharge		IEC/EN 61000-4-2 level 3 (4 kV contact/8 kV air)									
	Radiated electromagnetic fields		IEC/EN 61000-4-3 level 3 (10 V/m)									
	Induced electromagnetic fields		IEC/EN 61000-4-6 level 3 (10 V/m)									
	Rapid transients		IEC/EN 61000-4-4 level 3 (2 kV)									
	Surges		IEC/EN 61000-4-5									
	Conducted interference		IEC/EN 61000-4-8 level 4, IEC/EN 61000-4-12 level 3									
	Primary outage		Conforming to standard IEC/EN 61000-4-11 (voltage dips and interruptions)									

Phaseo™ power supplies

Regulated switch mode power supplies

ABL1 Dedicated range

Output specifications

Derating

The ambient temperature is a determining factor which limits the power that an electronic power supply can deliver continuously. Excessively high temperatures around the electronic components significantly reduce their life.

ABL1R•M24100 power supplies (240 W) are mechanically ventilated from an ambient temperature > 104 °F (40 °C) approx., or for a load rating > 90% approx. The rated ambient temperature for **ABL1REM/1RPM** power supplies is 122 °F (+50 °C). Above this, derating is necessary up to a maximum temperature of 140 °F (+60 °C).

The curves below show the power (in relation to the nominal power) which the power supply can deliver continuously, according to the ambient temperature.

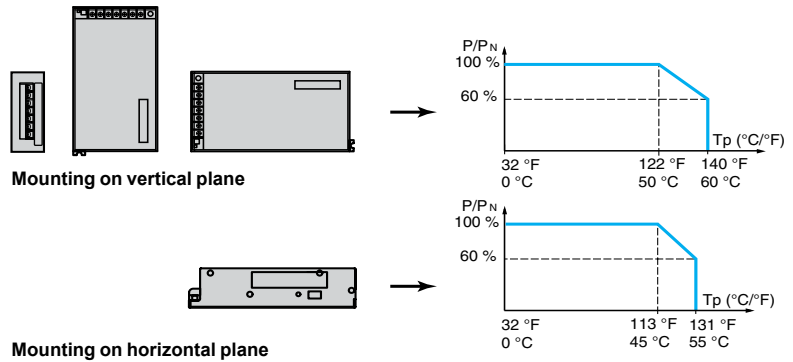

Extreme operating conditions

Derating should be considered in extreme operating conditions:

- Intensive operation (output current permanently close to the nominal current, combined with a high ambient temperature)
- Output voltage set above 24 V (to compensate for line voltage drops, for example)
- Parallel connection to increase the total power

General rules to be complied with

Intensive operation	See derating on above curves. Example for ABL1 mounted vertically: <ul style="list-style-type: none"> ■ Without derating, from 32 to 122 °F (0 to 50 °C) ■ Derating of nominal current by 4%, per additional °C, up to 60 °C
Rise in output voltage	The nominal power is mounted. Increasing the output voltage means that the current delivered will be reduced.
Parallel connection to increase the power	The total power is equal to the sum of the power supplies used, but the maximum ambient temperature for operation is 122 °F (50 °C). To improve heat dissipation, the power supplies must not be in contact with each other.

Note: See page 53 for a schematic drawing of the ABL1 Dedicated Range power supplies.

Output specifications (continued)

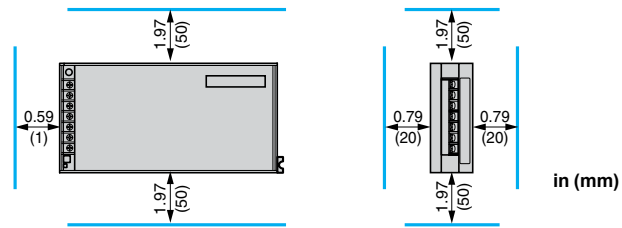

In all cases, there must be adequate convection around the products to help ensure sufficient cooling. There must be a clear space of 1.97 in (50 mm) above and below the power supplies, and of 0.79 in (20 mm) at the sides.

Load limits

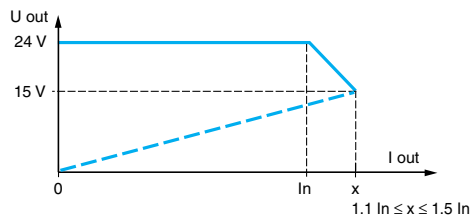

Series or parallel connection

Series connection

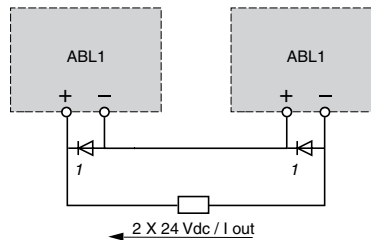

Parallel connection

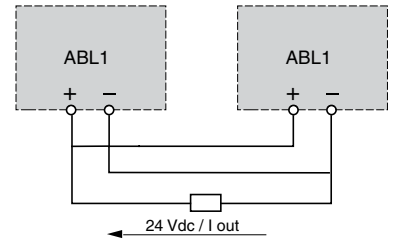

1 8 A / 100 V Shottky diode for **ABL1REM12050 / 1REM24025 / 1R●M24042**
15 A / 100 V Shottky diode for **ABL1RPM12083 / 1R●M24062 / 1R●M24100**

Selection of protection for the power supply primary

Type of mains supply Type of protection (2 poles protected)	~ 115 V single-phase			~ 230 V single-phase		
	Thermal-magnetic circuit-breaker		Class CC fuse	Thermal-magnetic circuit-breaker		Class CC fuse
	GB2 (IEC)	C60N (IEC) C60N (UL)		GB2 (IEC)	C60N (IEC) C60N (UL)	
ABL1REM12050	GB2 DB07	24517	2 A	GB2 DB07	24517	2 A
ABL1REM24025	GB2 DB07	24517	2 A	GB2 DB07	24517	2 A
ABL1RPM12083	GB2 DB07	24517	2 A	GB2 DB07	24517	2 A
ABL1REM24042	GB2 DB07	24517	2 A	GB2 DB07	24517	2 A
ABL1RPM24042	GB2 DB07	24517	2 A	GB2 DB07	24517	2 A
ABL1REM24062	GB2 DB07	24517	2 A	GB2 DB08	24518	4 A
ABL1RPM24062	GB2 DB07	24517	2 A	GB2 DB08	24518	4 A
ABL1REM24100	GB2 DB08	24518	4 A	GB2 DB10	17454	6 A
ABL1RPM24100	GB2 DB08	24518	4 A	GB2 DB10	17454	6 A

Phaseo™ power supplies

Regulated switch mode power supplies

ABL1 Dedicated range



ABL1REM24025



ABL1R●M24042



ABL1R●M24062



ABL1R●M24100

References

Regulated switch mode power supplies: ABL1REM Phaseo™ Dedicated range

Input voltage 47 to 63 Hz	Output voltage	Nominal power	Nominal current	Auto-protect reset	Conforming to standard IEC/EN 61000-3-2	Reference	Weight lbs (kg)
100 to 240 V ~ (1) single-phase wide range	12 V =	60 W	5 A	Automatic	No	ABL1REM12050	1.25 (0.57)
	24 V =	60 W	2.5 A	Automatic	No	ABL1REM24025	1.19 (0.54)
		100 W	4.2 A	Automatic	No	ABL1REM24042	1.62 (0.73)
100 to 120 V ~ 200 to 240 V ~ (2) single-phase	24 V =	150 W	6.2 A	Automatic	No	ABL1REM24062	2.49 (1.13)
		240 W	10 A	Automatic	No	ABL1REM24100	2.35 (1.07)

Regulated switch mode power supplies: ABL1RPM Phaseo Dedicated range

Input voltage 47 to 63 Hz	Output voltage	Nominal power	Nominal current	Auto-protect reset	Conforming to standard IEC/EN 61000-3-2	Reference	Weight lbs (kg)
100 to 240 V ~ (1) single-phase wide range	12 V =	100 W	8.3 A	Automatic	Yes	ABL1RPM12083	1.62 (0.73)
	24 V =	100 W	4.2 A	Automatic	Yes	ABL1RPM24042	1.62 (0.73)
100 to 120 V ~ 200 to 240 V ~ (2) single-phase	24 V =	150 W	6.2 A	Automatic	Yes	ABL1RPM24062	2.49 (1.13)
		240 W	10 A	Automatic	Yes	ABL1RPM24100	3.05 (1.38)

Mounting accessories

Description	For power supplies	Sold in lots of	Unit reference	Weight lbs (kg)
Reversible mounting bracket	For the mounting on the back of cabinet of ABL1R●M●●●● power supply	5	ABL1A01	0.187 (0.085)
Clip-on mounting plate for DIN 35 mm mounting rail	- ABL1REM12050/24025: the plate mounting on DIN requires one mounting plate - ABL1RPM12083 and - ABL1R●M24042/24062/24100: the plate mounting on DIN requires 2 mounting plates - ABL1R●M●●●●: the mounting on the back of cabinet on the DIN rail requires one mounting plate	5	ABL1A02	0.077 (0.035)

(1) Compatible input voltage = 120 to 370 V not indicated on the product.

(2) Compatible input voltage = 180 to 370 V not indicated on the product.

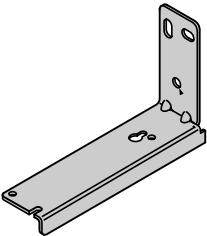

ABL1A01

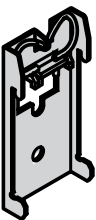

ABL1A02

Wiring diagrams

ABL1REM12050, ABL1REM24025 ABL1REM24042, ABL1REM24062, ABL1RPM●●●●●
ABL1REM24100

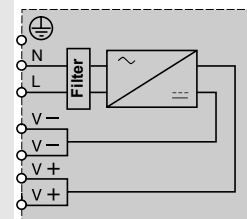
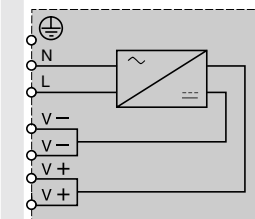
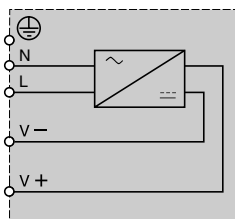

Approximate dimensions

ABL1R●M●●●●●

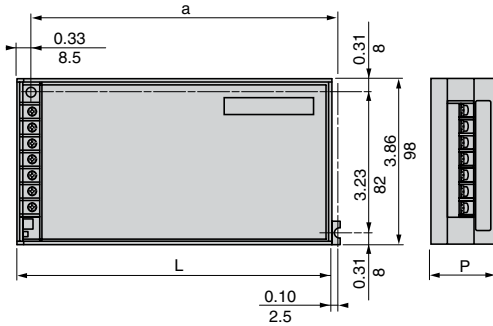

ABL	L	P	a
ABL1REM12050	5.91 (150)	1.50 (38)	5.67 (144)
ABL1REM24025	5.91 (150)	1.50 (38)	5.67 (144)
ABL1REM24042	7.87 (200)	1.50 (38)	7.64 (194)
ABL1REM24062	7.87 (200)	1.97 (50)	7.64 (194)
ABL1REM24100	7.87 (200)	2.56 (65)	7.64 (194)
ABL1RPM12083	7.87 (200)	1.50 (38)	7.64 (194)
ABL1RPM24042	7.87 (200)	1.50 (38)	7.64 (194)
ABL1RPM24062	7.87 (200)	1.97 (50)	7.64 (194)
ABL1RPM24100	7.87 (200)	2.56 (65)	7.64 (194)

in (mm)

ABL1A01

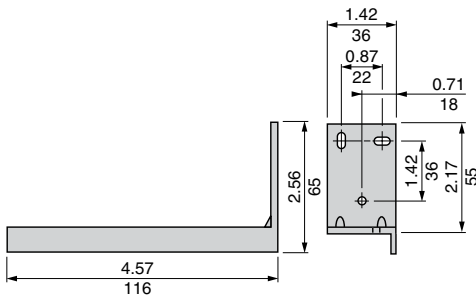

ABL1A02

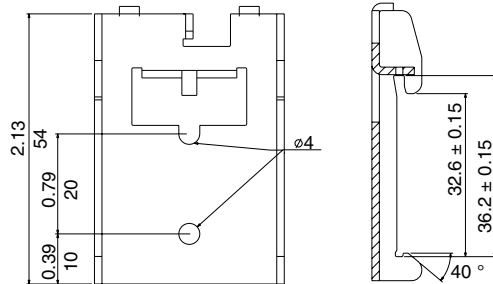

Mounting

ABL1R●M●●●●●

Direct mounting by 2 M4 x 20 screws

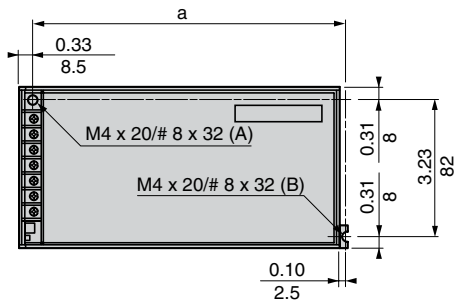

Back-of-cabinet mounting using the ABL1A01 reversible bracket with 3 Ø 4 mm screws

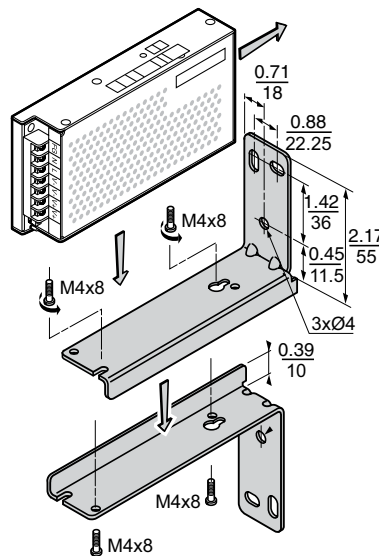
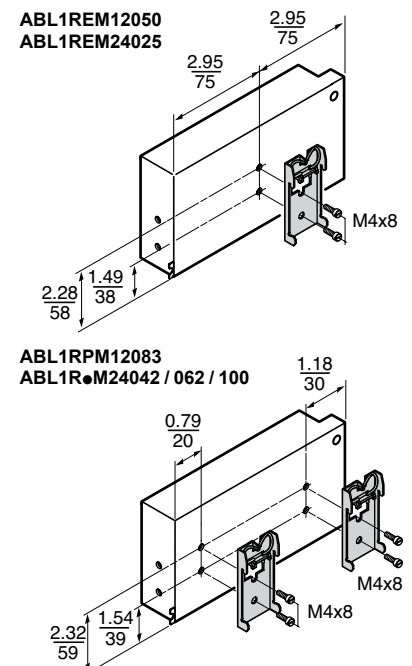
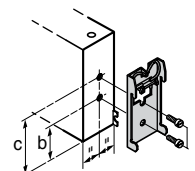

Plate-mounting using the ABL1A02 clip-on plate on a 35 mm DIN rail



Mounting by the back ABL1R●M●●●●●:



Phaseo™ power supplies

Regulated switch mode power supplies

ASIABL AS-Interface™ range

Power supplies for AS-Interface™ cabling system

Consistent with the standard Phaseo™ line, the range of **ASIABL** power supplies is designed to deliver a $\bar{\text{—}}$ voltage, as required by AS-Interface cabling systems. Three versions are available to meet all needs encountered in industrial applications, in enclosures, cells or floor-standing enclosures. These single-phase, electronic, switch mode power supplies guarantee the quality of the output current, in accordance with the electrical specifications and conforming to standard EN 50295.

ASIAPLB300●

Operating on a 100 to 240 V \sim supply, this power supply delivers a voltage of 30 V $\bar{\text{—}}$. Available in 2.4 and 4.8 A ratings, the outgoing terminal block allows the cable to be connected separately to the AS-Interface interface modules and to the AS-Interface master. Input and output LEDs allow fast and continuous diagnostics.



ASIAPLB3002

ASIAPLD300●

Operating on a 100 to 240 V \sim supply, this power supply delivers a voltage of 30 V $\bar{\text{—}}$. Available in 2.4 and 4.8 A ratings, it allows diagnosis and management of ground detected faults on AS-Interface interface modules. In the event of a ground detected fault, the Phaseo power supply stops dialog on the AS-Interface cabling system and puts the installation in a fallback condition. Restarting is only possible after deliberate acknowledgement of the detected fault. Two inputs/outputs enable dialog with a processing unit. The outgoing terminal block is used to connect the AS-Interface cable separately to the interface modules and master modules. Input, output and ground detected fault LED's allow fast and continuous diagnostics.



ASIAPLD3004

ASIAPLM3024

Operating on a 100 to 240 V \sim supply, this product provides two separate power supplies, which are totally independent in the way they operate. Two output voltages – 30 V/2.4 A (AS-Interface line supply) and 24 V/3 A – are available, making it possible to supply the control equipment without an additional power supply. Input and output LEDs allow fast and continuous diagnostics.



ASIAPLM3024

Technical specifications								
Type of power supply			ASIABLB3002	ASIABLB3004	ASIABLD3002	ASIABLD3004	ASIABLM3024	
Functions			Supply to the AS-Interface line (30 V $\overline{\text{---}}$)				30 V $\overline{\text{---}}$ supply	24 V $\overline{\text{---}}$ supply
Product certifications			UL 508, CSA 22-2 n°950, TÜV 60950-1					
Conforming to standards	Safety		IEC/EN 60950-1					
	EMC		EN 50081-1, IEC/EN 61000-6-2, EN 55022 class B					
	Low frequency harmonic currents		No					
Input circuit								
LED indication			Orange LED					
Input voltage	Rated values	V	~ 100 to 240					
	Permissible values	V	~ 85 to 264					
	Current consumption	A	0.5	1	0.5	1		
	Permissible frequencies	Hz	47 to 63					
	Current at switch-on	A	< 30					
	Power factor		0.65					
	Efficiency at nominal load	%	> 83				> 83	> 80
	Dissipated power at nominal load	W	14.7	29.5	14.7	29.5	14.7	36
	Output circuit							
LED indication			Green LED					
Nominal output values	Voltage (U _{Out})	V	30 (AS-Interface)				$\overline{\text{---}}$ 30	$\overline{\text{---}}$ 24
	Current	A	2.4	4.8	2.4	4.8	2.4	3
	Power	W	72	144	72	144	72	72
Precision	Adjustable output voltage	V	–				–	100 to 120 %
	Line and load regulation		3 %					
	Residual ripple - noise	mV	300 - 50					
Holding time for I_{max}	U _{In} min	ms	≥ 10					
Protection	Against short-circuit		Permanent. Automatic restart after elimination of the detected fault					
	Against overload		1.1 I _n					
	Against overvoltage		Tripping if U > 1.2 U _n				U > 1.2 U _n	U > 1.5 U _n
	Against undervoltage		Tripping if U < 0.95 U _n				U < 0.95 U _n	U < 0.8 U _n
Operating specifications								
Connections	Input	mm²	2 x 2.5 screw terminals + ground					
	Output	mm²	2 x 2.5 screw terminals + ground, multiple output					
Environment	Operating temperature	°C	0 to + 60 (derating from 50, see page 14061-EN_Ver7.3/4)					
	Storage temperature	°C	- 25 to + 70					
	Maximum relative humidity		95 % (without condensation or dripping water)					
	Degree of protection		IP 20 (conforming to IEC/EN 60529)					
	Vibrations		IEC/EN 61131-2					
Operating position			Vertical					
MTBF		h	> 100000 (conforming to Bell core, at 40 °C)					
Dielectric strength 50 Hz during 1 min	Input/output	V rms	3000					
	Input/ground	V rms	3000					
	Output/ground (and output/output)	V rms	500					
Input fuse incorporated			Yes (not interchangeable)					
Emission according to EN 61000-6-3	Conducted/radiated		Class B (conforming to EN 55022)					
Immunity according to IEC/EN 61000-6-2	Electrostatic discharge		IEC/EN 61000-4-2 (4 kV contact/8 kV air)					
	Radiated electromagnetic field		IEC/EN 61000-4-3 level 3 (10 V/m)					
	Induced electromagnetic field		IEC/EN 61000-4-6 (10 V/m)					
	Rapid transients		IEC 61000-4-4 level 3 (2 kV),					
	Primary outages		IEC 61000-4-11 (voltage dips and interruptions)					

Output specifications

Derating

The ambient temperature is a determining factor which limits the power that an electronic power supply can deliver continuously. If the temperature around the electronic components is too high, their life will be significantly reduced.

The graph below shows the power (in relation to the nominal power) which the power supply can deliver continuously, according to the ambient temperature.

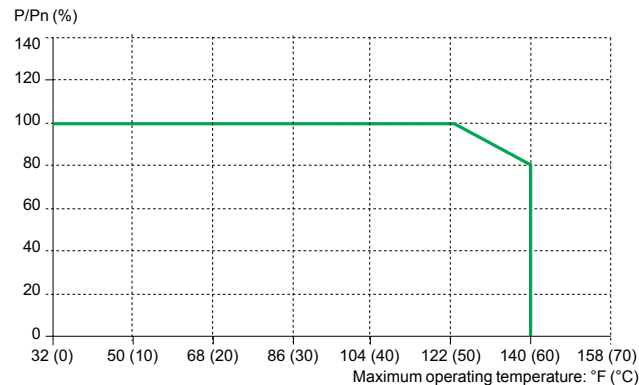

Function diagram

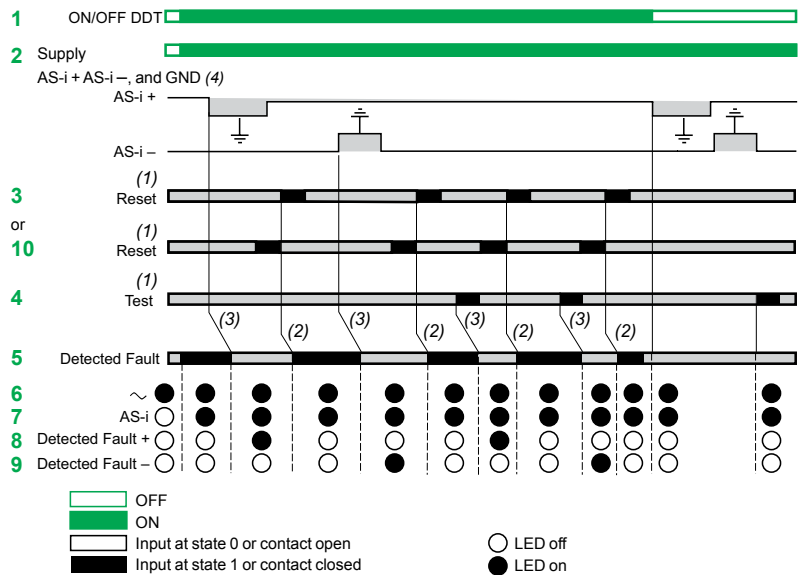
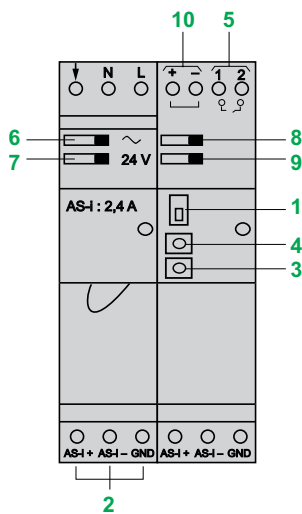

- (1) 30 ms min.
- (2) 15 ms.
- (3) 20 ms.
- (4) Warning: the ground fault detector will only operate if the ground (GND) terminal is connected.

Warning

■ The ground (GND) (4) connection must be made. In the event of disconnection, the built-in detector becomes inoperative. To obtain ground connection diagnostics, it is recommended that an ASIABLD300 power supply be used with built-in insulation control.

■ An appearance of accidental ground detected fault triggers, in the following cases, the activation of built-in protection:

- case 1: detected fault between AS-i "+" and ground,
- case 2: detected fault between AS-i "-" and ground,
- case 3: detected fault between sensors/actuators (supplied by ASIABLD300) and ground.

In cases 1 and 2 with switch 1 ON -> OFF: maintain of detected fault, any exchange between master and slaves.

In case 3 with switch 1 ON -> OFF: restart of exchanges between master and slaves but the states of inputs/outputs of affected module are not guaranteed.

Selection: Upstream protection of power supplies for AS-Interface™ cabling system

Type of mains supply	~ 115 V single-phase			~ 230 V single-phase		
Power supply	Thermal-magnetic supplementary breaker (1)	Class CC fuse	Thermal-magnetic supplementary breaker (2-pole)	Class CC fuse		
Single-pole	GB2CB●●					
2-pole	GB2DB●●	C60N	GB2DB●●	C60N		
ASIABLB3002	GB2 ●B07	MG24517 (2)	2 A	GB2 DB06	MG24516 (2) 2 A	
ASIABLB3004	GB2 ●B08	MG24518 (2)	4 A	GB2 DB07	MG17453 (2) 2 A	
ASIABLD3002	GB2 ●B07	MG24517 (2)	2 A	GB2 DB06	MG24516 (2) 2 A	
ASIABLD3004	GB2 ●B08	MG24518 (2)	4 A	GB2 DB07	MG17453 (2) 2 A	
ASIABLM3024	GB2 ●B07	MG24517 (2)	2 A	GB2 DB06	MG17453 (2) 2 A	

(1) Single-phase protection, replace ● by C; 2-pole protection, replace ● by D.
(2) UL certified circuit breaker.

References



ASIABL●3002

Input voltage	Secondary Output voltage	Nominal power	Nominal current	Auto-protect reset	Ground fault detection	Reference	Weight lbs (kg)
Single phase (N-L1) or 2-phase (L1-L2)							
~ 100 to 240 V - 15%, + 10% 50/60 Hz	30 V	72 W	2,4 A	Auto	No	ASIABLB3002	1.76 (0.800)
		144 W	4,8 A	Auto	No	ASIABLB3004	2.87 (1.300)
	30 V	72 W	2,4 A	Auto	Yes	ASIABLD3002	1.76 (0.800)
		144 W	4,8 A	Auto	Yes	ASIABLD3004	2.87 (1.300)
24 V	30 V	72 W	2,4 A	Auto	No	ASIABLM3024	2.87 (1.300)
	24 V	72 W	3 A				

Dimensions

Common side view
Mounting on 35 and 75 mm DIN rails

ASIABLB3002
ASIABLD3002

ASIABLB3004 / ABLD3004
ASIABLM3024

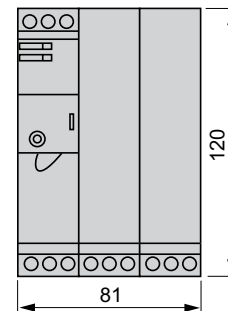
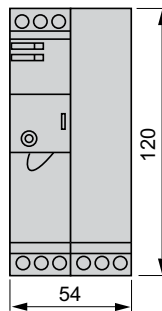
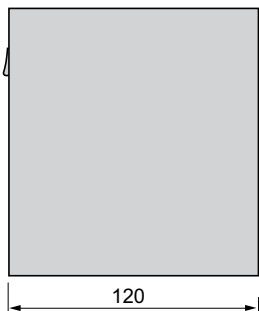

Wiring diagrams

ASIABLB300●

ASIABLD300●

ASIABLM3024

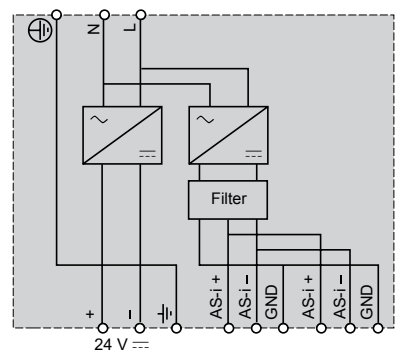
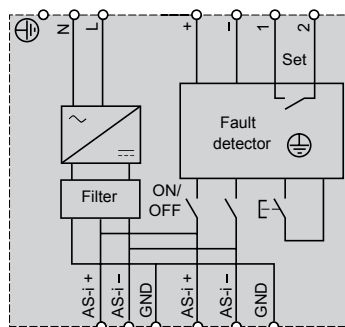
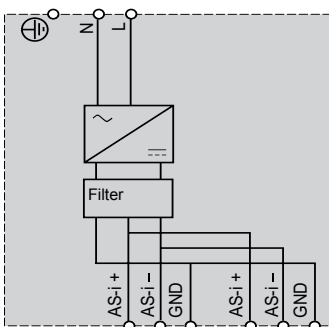

ABL1A01	54
ABL1A02	34
	44
	54
ABL1REM12050	54
ABL1REM24025	54
ABL1REM24042	54
ABL1REM24062	54
ABL1REM24100	54
ABL1RPM12083	54
ABL1RPM24042	54
ABL1RPM24062	54
ABL1RPM24100	54
ABL7RM24025	19
ABL7RP1205	25
ABL7RP4803	25
ABL8BBU24200	34
	44
ABL8BBU24400	34
	44
ABL8BPK24A03	34
	44
ABL8BPK24A07	44
ABL8BPK24A12	34
	44
ABL8BUF24400	34
	44
ABL8DCC05060	34
	38
ABL8DCC12020	34
	38
ABL8FUS01	34
ABL8FUS02	34
	44
ABL8MEM05040	19
ABL8MEM12020	19
ABL8MEM24003	19
ABL8MEM24006	19
ABL8MEM24012	19
ABL8RED24400	34
	48
ABL8REM24030	25
ABL8REM24050	25
ABL8RPM24200	34
ABL8RPS24030	34
ABL8RPS24050	34
ABL8RPS24100	34
ABL8WPS24200	34
ABL8WPS24400	34
ASI20MACC5	34
ASIABLB3002	59
ASIABLB3004	59
ASIABLD3002	59
ASIABLD3004	59
ASIABLM3024	59
LAD90	19
	34
	38
	44
	48
SR2CBL01	34
	44
SR2MEM02	34
	44
SR2USB01	34
	44

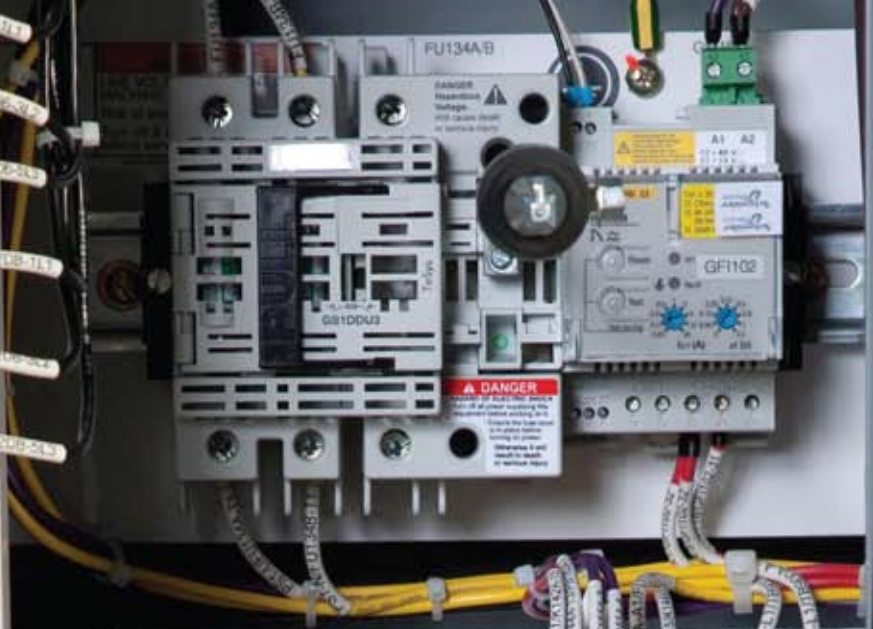

<http://www.schneider-electric.com/>

Schneider Electric USA, Inc.

8001 Knightdale Blvd.
Knightdale, NC 27545

USA Customer Care Center
Tel: 888-778-2733

Schneider Electric Canada

5985 McLaughlin Rd.
Mississauga, Ontario, Canada L5R 1B8
Canada Customer Care Center
Tel: 800-565-6699

The information and dimensions in this catalog are provided for the convenience of our customers. While this information is believed to be accurate, Schneider Electric reserves the right to make updates and changes without prior notification and assumes no liability for any errors or omissions.

AS-Interface, Modicon, Phaseo, Twido, Zelio, Schneider Electric and logo, and "Make the most of your energy" are trademarks or registered trademarks of Schneider Electric or its affiliates in the United States and other countries. Other trademarks used herein are the property of their respective owners.

Design: Schneider Electric
Photos: Schneider Electric