

# Commercial & Industrial Grade Switches

SELECTION GUIDE



# Commercial & Industrial Grade Switch Overview

## PROBLEM SOLVING SOLUTIONS

Look for the **GREEN** icons shown below to assist you in browsing for the ideal switch.



### PILOT LIGHT & ILLUMINATED

Featuring a light in the toggle or rocker, these switches illuminate to alert you from afar if your device is ON or OFF.



### TAMPER-RESISTANT & KEY LOCKING

Switches designed to only be operated by authorized users.



### ANTIMICROBIAL TREATED DEVICES

Made durable in order to withstand harsh chemical cleaning products, stringent washings, and UV lights with minimal wear and tear while inhibiting bacterial growth.



### LEV-LOK MODULAR WIRING DEVICES

Features a simple twist-and-lock wiring module that allows for 3X faster installations and 5X faster swap outs than traditional wiring.



### LEADED

Pre-attached leads save you time by simplifying installation and wiring.



### MOMENTARY

Momentary switches are actuated when pressed, like a gym door or doorbell.



### MAINTAINED

Maintained switches change position when actuated, and remain in that position until actuated again, like an ON/OFF button.



### CANADIAN

A "Canadian" switch is CSA Listed only, Non-Grounding, rated 347 VAC, and has a strap for a 3.531 inch box mount.



FED SPEC



Leviton uses several Nationally Recognized Testing Labs (NRTLs) for certification of switches. UL and CSA are two of these NRTLs. When you see the UL, CSA, or cULus symbols, you can have the confidence that the devices adhere to strict scientific safety, quality or security standards.

In addition to complying with UL general use requirements, when you see the Fed Spec marking you are assured that the switch has been investigated for compliance with US Federal Specification W-S-896 for the purpose of more durability and service life.

# Commercial & Industrial Grade Switches

## SELECTION GUIDE



### TABLE OF CONTENTS

Overview .....	2
Switches .....	4
Toggle Switches .....	5
Decora Plus™ Switches .....	11
Lev-lok® Switches .....	13
Antimicrobial Treated Switches .....	16
Specialty Switches .....	18
Tamper-Resistant .....	19
Key Locking .....	19
Momentary .....	19
Maintained .....	20
Hospital Call .....	20
Low Voltage .....	21
Select Wallplates .....	22
Wiring Diagrams .....	23



## COMMON CATEGORIES

### COMMERCIAL SPECIFICATION GRADE

The perfect balance between performance and value. Commercial grade switches feature a galvanized steel strap, are available in Decora style, and go up to 20 Amp.

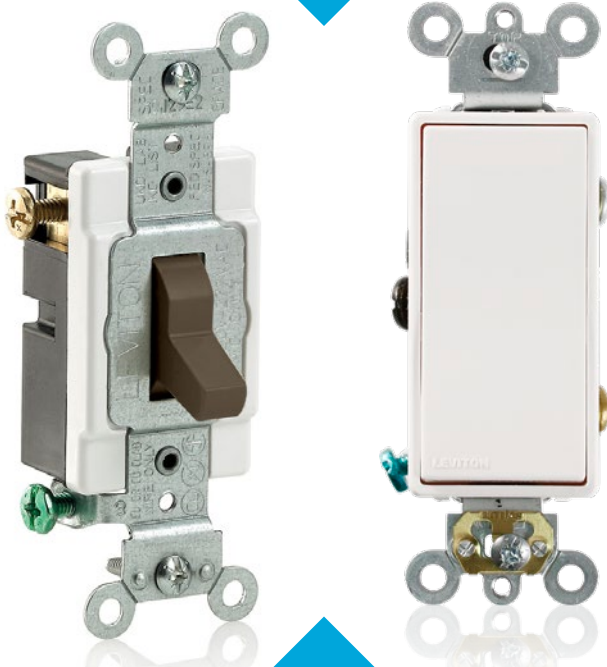

### INDUSTRIAL SPECIFICATION GRADE

The ideal solution for demanding applications requiring robust construction and exceptional electrical performance. Industrial grade switches feature a heavy-duty thicker gauge galvanized steel strap for longer service life, and go up to 30 Amp.

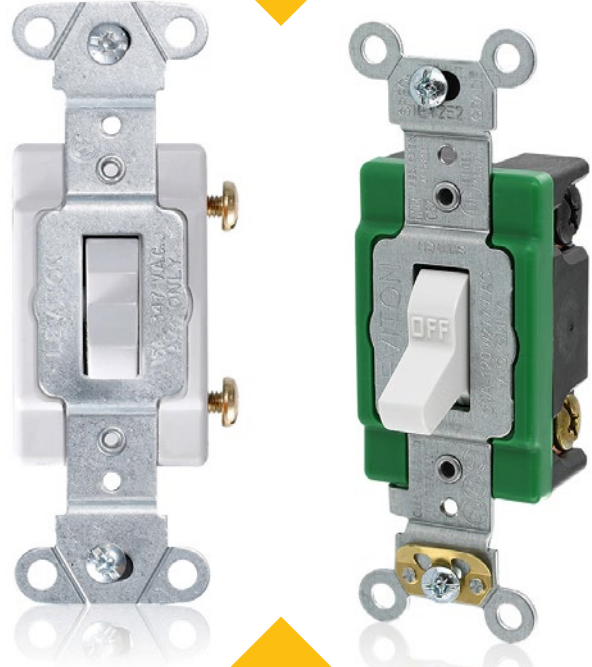

## KEY TERMINOLOGY

Wiring diagrams for the below switch types appear on page 23.

### SINGLE POLE

Controls light(s)/load(s) from one location

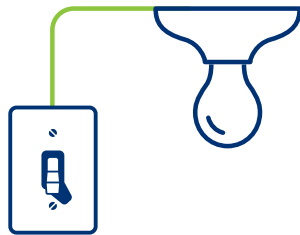

### DOUBLE POLE

Controls small motor loads

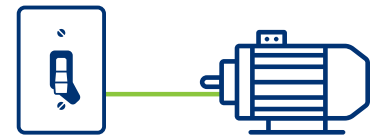

### 3-WAY

Controls light(s)/load(s) from two locations



### 4-WAY

Controls light(s) from three locations  
One 4-way switch and two 3-way switches must be used in a 4-way application

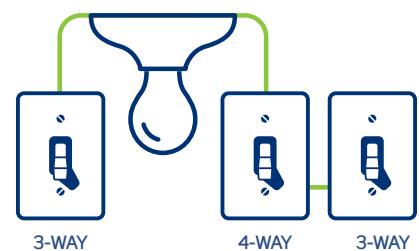

COMMERCIAL SPECIFICATION GRADE						
120/277 V AC						
Features		Color	15 Amp	20 Amp		
<b>Single Pole</b> • Side Wire • Fed Spec Rated	FED SPEC	White	CS115-2W	CS120-2W		
		Ivory	CS115-2I	CS120-2I		
		Lt Almond	CS115-2T	CS120-2T		
		Brown	CS115-2	CS120-2		
		Gray	CS115-2GY	CS120-2GY		
		Black	CS115-2E	CS120-2E		
		<b>Double Pole</b> • Side Wire • Fed Spec Rated	FED SPEC	White	CS215-2W	CS220-2W
				Ivory	CS215-2I	CS220-2I
				Lt Almond	—	CS220-2T
				Brown	CS215-2	CS220-2
Gray	CS215-2GY			CS220-2GY		
Black	—			CS220-2E		
<b>3-Way</b> • Side Wire • Fed Spec Rated	FED SPEC	White	CS315-2W	CS320-2W		
		Ivory	CS315-2I	CS320-2I		
		Lt Almond	CS315-2T	CS320-2T		
		Brown	CS315-2	CS320-2		
		Gray	CS315-2GY	CS320-2GY		
		Black	—	CS320-2E		
<b>4-Way</b> • Side Wire • Fed Spec Rated	FED SPEC	White	CS415-2W	CS420-2W		
		Ivory	CS415-2I	CS420-2I		
		Lt Almond	CS415-2T	CS420-2T		
		Brown	CS415-2	CS420-2		
		Gray	CS415-2GY	CS420-2GY		
		Black	—	CS420-2E		
<b>Single Pole</b> • Back and Side Wire • Fed Spec Rated	FED SPEC	White	CSB1-15W	CSB1-20W		
		Ivory	CSB1-15I	CSB1-20I		
		Lt Almond	CSB1-15T	CSB1-20T		
		Brown	CSB1-15	CSB1-20		
		Gray	CSB1-15G	CSB1-20G		
<b>Double Pole</b> • Back and Side Wire • Fed Spec Rated	FED SPEC	White	CSB2-15W	CSB2-20W		
		Ivory	CSB2-15I	CSB2-20I		
		Lt Almond	CSB2-15T	CSB2-20T		
		Brown	CSB2-15	CSB2-20		
		Gray	—	CSB2-20G		
<b>3-Way</b> • Back and Side Wire • Fed Spec Rated	FED SPEC	White	CSB3-15W	CSB3-20W		
		Ivory	CSB3-15I	CSB3-20I		
		Lt Almond	CSB3-15T	CSB3-20T		
		Brown	CSB3-15	CSB3-20		
		Gray	—	CSB3-20G		
<b>4-Way</b> • Back and Side Wire • Fed Spec Rated	FED SPEC	White	CSB4-15W	CSB4-20W		
		Ivory	CSB4-15I	CSB4-20I		
		Lt Almond	CSB4-15T	CSB4-20T		
		Brown	CSB4-15	CSB4-20		
		Gray	—	CSB4-20G		



STANDARD TOGGLE



COMMERCIAL SPECIFICATION GRADE					
120/277 V AC					
Features		Color	15 Amp	20 Amp	
FRAMED TOGGLE	<b>Single Pole</b>	FED SPEC	White	54501-2W	54521-2W
	<ul style="list-style-type: none"> <li>Framed Toggle</li> <li>Side Wire</li> <li>Fed Spec Rated</li> </ul>		Ivory	54501-2I	54521-2I
			Brown	54501-2	54521-2
			Gray	54501-2GY	54521-2GY
	<b>Double Pole</b>	FED SPEC	White	54502-2W	54522-2W
	<ul style="list-style-type: none"> <li>Framed Toggle</li> <li>Side Wire</li> <li>Fed Spec Rated</li> </ul>		Ivory	54502-2I	54522-2I
			Brown	54502-2	54522-2
	<b>3-Way</b>	FED SPEC	White	54503-2W	54523-2W
	<ul style="list-style-type: none"> <li>Framed Toggle</li> <li>Side Wire</li> <li>Fed Spec Rated</li> </ul>		Ivory	54503-2I	54523-2I
			Brown	54503-2	54523-2
			Gray	54503-2GY	54523-2GY
	<b>4-Way</b>	FED SPEC	White	54504-2W	54524-2W
	<ul style="list-style-type: none"> <li>Framed Toggle</li> <li>Side Wire</li> <li>Fed Spec Rated</li> </ul>		Ivory	54504-2I	54524-2I
			Lt Almond	54504-2T	—
			Brown	54504-2	54524-2
			Gray	54504-2GY	54524-2GY
	<b>Single Pole</b>	FED SPEC	White	1101-CW	—
	<ul style="list-style-type: none"> <li>Framed Toggle</li> <li>Side Wire</li> <li>Non-Grounding</li> <li>Fed Spec Rated</li> </ul>		Ivory	1101-CI	—
			Brown	1101-CB	—
			Gray	1101-CG	—
			Black	1101-CE	—
			White	1102-CW	—
	<b>Double Pole</b>	FED SPEC	Ivory	1102-CI	—
	<ul style="list-style-type: none"> <li>Framed Toggle</li> <li>Side Wire</li> <li>Non-Grounding</li> <li>Fed Spec Rated</li> </ul>		Brown	1102-CB	—
	White		1103-CW	—	
<b>3-Way</b>	FED SPEC	Ivory	1103-CI	—	
<ul style="list-style-type: none"> <li>Framed Toggle</li> <li>Side Wire</li> <li>Non-Grounding</li> <li>Fed Spec Rated</li> </ul>		Brown	1103-CB	—	
		White	1104-CW	—	
<b>4-Way</b>	FED SPEC	Ivory	1104-CI	—	
<ul style="list-style-type: none"> <li>Framed Toggle</li> <li>Side Wire</li> <li>Non-Grounding</li> <li>Fed Spec Rated</li> </ul>		Brown	1104-CB	—	
		Black	1104-CE	—	
		White	5501-LHW	—	
ILLUMINATED	<b>Single Pole</b>	FED SPEC	Ivory	5501-LHI	—
	<ul style="list-style-type: none"> <li>Lighted Handle Locator - Toggle Illuminated when OFF</li> <li>Side Wire</li> <li>Does Not Require a Neutral Wire</li> <li>Fed Spec Rated</li> </ul>		White	5503-LHW	—
	<b>3-Way</b>	FED SPEC	Ivory	5503-LHI	—
	<ul style="list-style-type: none"> <li>Lighted Handle Locator - Toggle Illuminated when OFF</li> <li>Side Wire</li> <li>Does Not Require a Neutral Wire</li> <li>Fed Spec Rated</li> </ul>				



**COMMERCIAL SPECIFICATION GRADE**  
**347 V AC**

Features		Color	15 Amp	20 Amp	30 Amp
FRAMED TOGGLE	<b>Single Pole</b> <ul style="list-style-type: none"> <li>Framed Toggle</li> <li>Side Wire</li> <li>Non-Grounding</li> <li>Canadian</li> </ul> 	White	18201-CW	18202-CW	—
		Ivory	18201-CI	18202-CI	—
		Brown	18201-CB	—	—
		Gray	18201-CG	—	—
	<b>3-Way</b> <ul style="list-style-type: none"> <li>Framed Toggle</li> <li>Side Wire</li> <li>Non-Grounding</li> <li>Canadian</li> </ul> 	White	18203-CW	18204-CW	—
		Ivory	18203-CI	18204-CI	—
		Brown	18203-CB	—	—
		Gray	18203-CG	18204-CG	—

**INDUSTRIAL SPECIFICATION GRADE**  
**120/277 V AC**

Features		Color	15 Amp	20 Amp	30 Amp
STANDARD TOGGLE	<b>Single Pole</b> <ul style="list-style-type: none"> <li>Back and Side Wire</li> <li>Self-Grounding</li> <li>Fed Spec Rated</li> </ul> 	White	1201-2W	1221-2W	3031-2W
		Ivory	1201-2I	1221-2I	3031-2I
		Lt Almond	—	1221-2T	—
		Brown	1201-2	1221-2	3031-2
		Gray	1201-2GY	1221-2GY	—
		Black	—	1221-2E	—
		Red	1201-2R	1221-2R	—
	<b>Double Pole</b> <ul style="list-style-type: none"> <li>Back and Side Wire</li> <li>Self-Grounding</li> <li>Fed Spec Rated</li> </ul> 	White	1202-2W	1222-2W	3032-2W
		Ivory	1202-2I	1222-2I	3032-2I
		Lt Almond	—	1222-2T	—
		Brown	1202-2	1222-2	3032-2
		Gray	1202-2GY	1222-2GY	—
		Black	—	1222-2E	3032-2E
		Red	—	1222-2R	3032-2R
	<b>3-Way</b> <ul style="list-style-type: none"> <li>Back and Side Wire</li> <li>Self-Grounding</li> <li>Fed Spec Rated</li> </ul> 	White	1203-2W	1223-2W	3033-2W
		Ivory	1203-2I	1223-2I	3033-2I
Lt Almond		1203-2T	1223-2T	—	
Brown		1203-2	1223-2	3033-2	
Gray		1203-2GY	1223-2GY	—	
Black		1203-2E	1223-2E	—	
Red		1203-2R	1223-2R	—	
<b>4-Way</b> <ul style="list-style-type: none"> <li>Back and Side Wire</li> <li>Self-Grounding</li> <li>Fed Spec Rated</li> </ul> 	White	1204-2W	1224-2W	—	
	Ivory	1204-2I	1224-2I	—	
	Lt Almond	—	1224-2T	—	
	Brown	1204-2	1224-2	—	
	Gray	1204-2GY	1224-2GY	—	
	Black	—	1224-2E	—	
	Red	—	1224-2R	—	



## INDUSTRIAL SPECIFICATION GRADE

### 120/277 V AC

Features		Color	15 Amp	20 Amp	30 Amp	
STANDARD TOGGLE	<b>Single Pole</b> • Back and Side Wire • Fed Spec Rated		White	—	1221-SW	—
			Ivory	—	1221-SI	—
			Lt Almond	—	1221-ST	—
			Brown	—	1221-S	—
			Gray	—	1221-SGY	—
			Red	—	1221-SR	—
	<b>Double Pole</b> • Back and Side Wire • Fed Spec Rated		White	—	1222-SW	—
			Ivory	—	1222-SI	—
			Brown	—	1222-S	—
	<b>3-Way</b> • Back and Side Wire • Fed Spec Rated		White	—	1223-SW	—
			Ivory	—	1223-SI	—
			Lt Almond	—	1223-ST	—
			Brown	—	1223-S	—
			Gray	—	1223-SGY	—
			Red	—	1223-SR	—
	<b>4-Way</b> • Back and Side Wire • Fed Spec Rated		White	—	1224-SW	—
			Ivory	—	1224-SI	—
			Brown	—	1224-S	—
	<b>Single Pole</b> • Three 6", #12AWG THHN Leads (2 Black & 1 Green Ground) • Self-Grounding • Fed Spec Rated		White	1241-W	1243-W	—
Ivory			1241-I	1243-I	—	
Lt Almond			—	1243-A	—	
Gray			1241-LGY	1243-LGY	—	
White			1242-W	1244-W	—	
<b>3-Way</b> • Four 6", #12AWG THHN Leads (1 Black, 2 Red & 1 Green Ground) • Self-Grounding • Fed Spec Rated		Ivory	1242-I	1244-I	—	
		Lt Almond	—	1244-A	—	
		Gray	—	1244-LGY	—	

### 120 V AC

Features		Color	15 Amp	20 Amp	30 Amp			
ILLUMINATED	<b>Single Pole</b> • Lighted Handle Locator - Toggle Illuminated when OFF • Back and Side Wire • Self-Grounding • Does Not Require a Neutral Wire • Fed Spec Rated		White	1201-LHW	1221-LHW	—		
			Ivory	1201-LHI	1221-LHI	3031-LHI		
			Red	—	1221-LHR	—		
			Clear	1201-LHC	1221-LHC	—		
			<b>3-Way</b> • Lighted Handle Locator - Toggle Illuminated when OFF • Back and Side Wire • Self-Grounding • Does Not Require a Neutral Wire • Fed Spec Rated		White	1203-LHW	1223-LHW	—
					Ivory	1203-LHI	1223-LHI	—
	Red	—			1223-LHR	—		
	Clear	1203-LHC			1223-LHC	—		

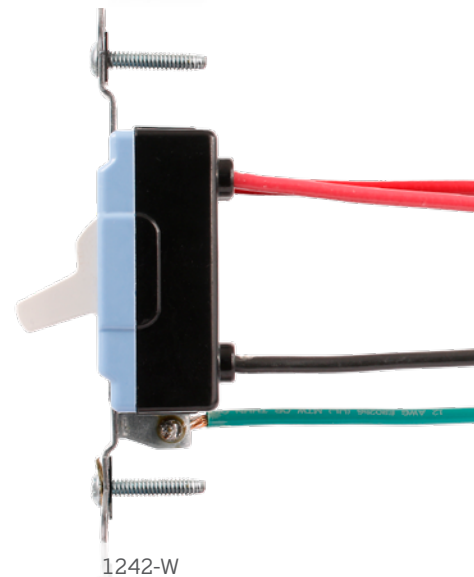







# Toggle Switches

## INDUSTRIAL SPECIFICATION GRADE

### 277 V AC

Features		Color	15 Amp	20 Amp	30 Amp
PILOT LIGHT	<b>3-Way</b>	Red	—	1223-7PR	—
	<ul style="list-style-type: none"> <li>Pilot Light - Toggle Illuminated when ON</li> <li>Back and Side Wire</li> <li>Two 6", #18AWG AWM TEW Leads (1 Black &amp; 1 White)</li> <li>Requires a Neutral Wire</li> <li>Fed Spec Rated</li> </ul>	 			

### 347 V AC

Features		Color	15 Amp	20 Amp	30 Amp
STANDARD TOGGLE	<b>Single Pole</b>	White	18201-W	18221-W	—
		Ivory	18201-I	18221-I	—
		Brown	18201-B	18221-B	—
		Gray	18201-G	18221-G	—
		Red	18201-R	18221-R	—
	<b>Double Pole</b>	Ivory	—	18222-I	—
		Brown	—	18222-B	—
	<b>3-Way</b>	White	18203-W	18223-W	—
		Ivory	18203-I	18223-I	—
		Brown	18203-B	18223-B	—
Gray		18203-G	18223-G	—	
Red		18203-R	18223-R	—	
<b>4-Way</b>	White	—	18224-W	—	
	Ivory	18204-I	18224-I	—	
	Brown	18204-B	18224-B	—	
	Gray	18204-G	—	—	
	Red	18204-R	—	—	



**COMMERCIAL SPECIFICATION GRADE**  
**120/277 V AC**

Features		Color	15 Amp	20 Amp
DECORA PLUS™	<b>Single Pole</b>	White	5691-2W	5621-2W
	• Back and Side Wire	Ivory	5691-2I	5621-2I
	• Self-Grounding	Lt Almond	5691-2T	5621-2T
		Brown	5691-2	5621-2
		Gray	5691-2GY	5621-2GY
		Black	5691-2E	5621-2E
		Red	—	5621-2R
	<b>Double Pole</b>	White	—	5622-2W
	• Back and Side Wire	Ivory	—	5622-2I
	• Self-Grounding	Lt Almond	—	5622-2T
		Gray	—	5622-2GY
		Black	—	5622-2E
		Red	—	5622-2R
	<b>3-Way</b>	White	5693-2W	5623-2W
	• Back and Side Wire	Ivory	5693-2I	5623-2I
	• Self-Grounding	Lt Almond	5693-2T	5623-2T
	Brown	5693-2	5623-2	
	Gray	5693-2GY	5623-2GY	
	Black	5693-2E	5623-2E	
	Red	—	5623-2R	
<b>4-Way</b>	White	—	5624-2W	
• Back and Side Wire	Ivory	—	5624-2I	
• Self-Grounding	Lt Almond	—	5624-2T	
	Brown	—	5624-2	
	Gray	—	5624-2GY	
	Black	—	5624-2E	
	Red	—	5624-2R	



**120 V AC**

Features		Color	15 Amp	20 Amp
PILOT LIGHT	<b>Single Pole</b>	White	—	5628-2W
	• Pilot Light - Rocker Illuminated when ON	Ivory	—	5628-2I
	• Back and Side Wire	Lt Almond	—	5628-2T
	• Requires a Neutral Wire			
	• Self-Grounding			
	<b>3-Way</b>	White	—	5638-2W
• Pilot Light - Rocker Illuminated when ON	Ivory	—	5638-2I	
• Back and Side Wire				
• Two 6", #18AWG AWM TEW Leads (1 Black & 1 White)				
• Requires a Neutral Wire				
• Self-Grounding				



COMMERCIAL SPECIFICATION GRADE							
120 V AC							
Features		Color	15 Amp	20 Amp			
ILLUMINATED	<b>Single-Pole</b>		White	—	5631-2W		
	<ul style="list-style-type: none"> <li>Lighted Rocker Locator - Rocker Illuminated when OFF</li> <li>Back and Side Wire</li> <li>Self-Grounding</li> </ul>		Ivory	—	5631-2I		
			Lt Almond	—	5631-2T		
			Gray	—	5631-2GY		
			Black	—	5631-2E		
ILLUMINATED	<b>Double Pole</b>		White	—	5633-2W		
	<ul style="list-style-type: none"> <li>Lighted Rocker Locator - Rocker Illuminated when OFF</li> <li>Back and Side Wire</li> <li>Self-Grounding</li> </ul>		Ivory	—	5633-2I		
			Lt Almond	—	5633-2T		
			Black	—	5633-2E		
277 V AC							
PILOT LIGHT	<b>Single Pole</b>		White	—	5629-2W		
	<ul style="list-style-type: none"> <li>Pilot Light - Rocker Illuminated when ON</li> <li>Back and Side Wire</li> <li>Requires a Neutral Wire</li> <li>Self-Grounding</li> </ul>						
PILOT LIGHT	<b>3-Way</b>		White	—	5639-2W		
	<ul style="list-style-type: none"> <li>Pilot Light - Rocker Illuminated when ON</li> <li>Back and Side Wire</li> <li>Two 6", #18AWG AWM TEW Leads (1 Black &amp; 1 White)</li> <li>Requires a Neutral Wire</li> <li>Self-Grounding</li> </ul>						
ILLUMINATED	<b>Single Pole</b>		White	—	5649-2W		
	<ul style="list-style-type: none"> <li>Lighted Rocker Locator - Rocker Illuminated when OFF</li> <li>Back and Side Wire</li> <li>Self-Grounding</li> </ul>						
	<b>3-Way</b>			White	—	5659-2W	
	<ul style="list-style-type: none"> <li>Lighted Rocker Locator - Rocker Illuminated when OFF</li> <li>Back and Side Wire</li> <li>Self-Grounding</li> </ul>						
347 V AC							
Features		Color	15 Amp	20 Amp			
DECORA PLUS™	<b>Single Pole</b>		White	5691-CW	5621-CW		
	<ul style="list-style-type: none"> <li>Back and Side Wire</li> <li>Non-Grounding</li> <li>Canadian</li> </ul>		Ivory	5691-CI	5621-CI		
			Gray	5691-CG	—		
			Black	5691-CE	—		
			Red	5691-CR	—		
	DECORA PLUS™	<b>3-Way</b>		White	5693-CW	5623-CW	
		<ul style="list-style-type: none"> <li>Back and Side Wire</li> <li>Non-Grounding</li> <li>Canadian</li> </ul>		Ivory	5693-CI	—	
				Gray	5693-CG	—	
				Black	5693-CE	—	
DECORA PLUS™	<b>4-Way</b>		White	5694-CW	5624-CW		
	<ul style="list-style-type: none"> <li>Back and Side Wire</li> <li>Non-Grounding</li> <li>Canadian</li> </ul>						





## lev-lok® switches

The perfect productivity solution for electrical construction and maintenance applications, the Lev-lok Modular Wiring Device System includes switches, receptacles, USBs, GFCIs and occupancy sensors. Simply connect the leaded wiring module to the back of the device for quick and easy assembly!

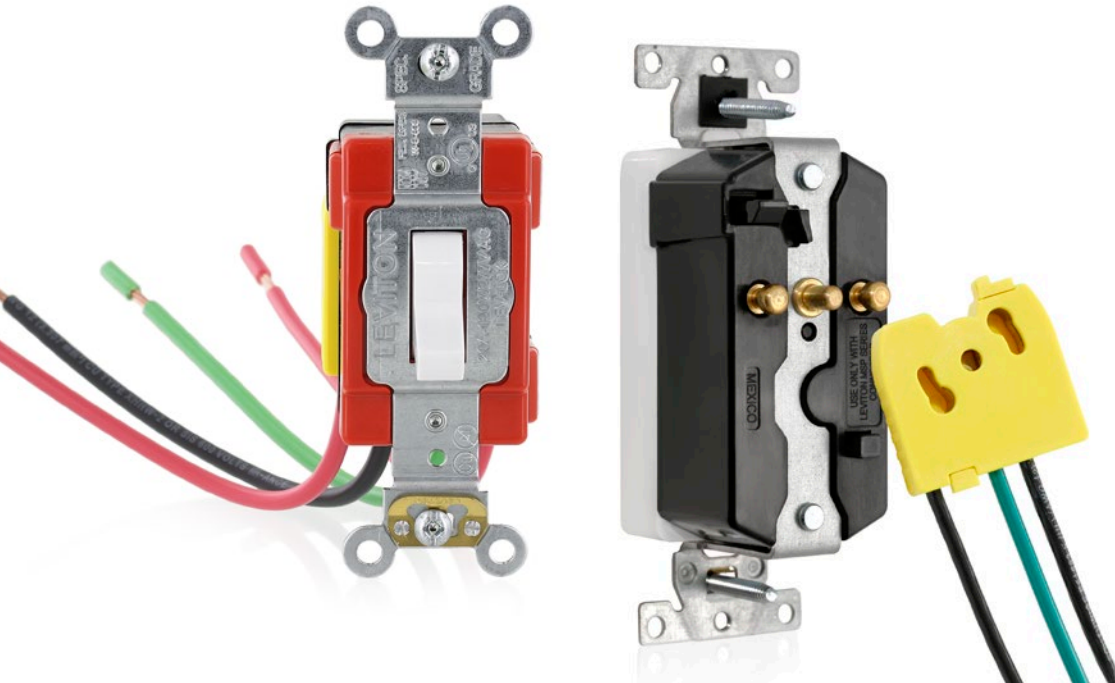

### KEY FEATURES AND BENEFITS

#### Future Proof

It's 5x faster to replace devices in a facility to meet future needs, whether you're updating technology or meeting new requirements.



#### Compress Timelines





Accelerate installation and swap outs to complete projects faster than using traditional wiring.



#### Accurate & Secure Connection

Lev-lok lowers the risk of incorrect installation while providing a safe and secure connection.



INDUSTRIAL SPECIFICATION GRADE		120/277 V AC		
Features	Color	15 Amp	20 Amp	
STANDARD TOGGLE	<b>Single Pole</b> <ul style="list-style-type: none"> <li>Self-Grounding</li> <li>Fed Spec Rated</li> <li>MSPSW mating module required</li> </ul>  	White	M1201-W	M1221-W
		Ivory	M1201-I	M1221-I
		Lt Almond	—	M1221-T
		Brown	—	M1221
		Gray	M1201-GY	M1221-GY
		Black	—	M1221-E
		Red	M1201-R	M1221-R
		Red	M1201-R	M1221-R
	<b>3-Way</b> <ul style="list-style-type: none"> <li>Self-Grounding</li> <li>Fed Spec Rated</li> <li>M3WSW mating module required</li> </ul>  	White	M1203-W	M1223-W
		Ivory	M1203-I	M1223-I
		Lt Almond	—	M1223-T
		Brown	M1203	M1223
Gray		M1203-GY	M1223-GY	
Black		—	M1223-E	
<b>Single Pole</b> <ul style="list-style-type: none"> <li>Antimicrobial Treated</li> <li>Self-Grounding</li> <li>Fed Spec Rated</li> <li>MSPSW mating module required</li> </ul>   	White	—	AM120-W	
	Ivory	—	AM120-I	
	Gray	—	AM120-GY	
	Red	—	AM120-R	
<b>3-Way</b> <ul style="list-style-type: none"> <li>Antimicrobial Treated</li> <li>Self-Grounding</li> <li>Fed Spec Rated</li> <li>M3WSW mating module required</li> </ul>   	White	—	AM320-W	
	Ivory	—	AM320-I	
	Gray	—	AM320-GY	
	Red	—	AM320-R	

## INDUSTRIAL SPECIFICATION GRADE

### 120/277 V AC

Features		Color	15 Amp	20 Amp	
ILLUMINATED	<b>Single Pole</b>				
	<ul style="list-style-type: none"> <li>Lighted Handle Locator - Toggle Illuminated when OFF</li> <li>Self-Grounding</li> <li>Fed Spec Rated</li> <li>MSPSW mating module required</li> </ul>	White	M1201-LHW	M1221-LHW	
		Ivory	—	M1221-LHI	
		Red	—	M1221-LHR	
		Clear	M1201-LHC	M1221-LHC	
ILLUMINATED	<b>3-Way</b>				
	<ul style="list-style-type: none"> <li>Lighted Handle Locator - Toggle Illuminated when OFF</li> <li>Self-Grounding</li> <li>Fed Spec Rated</li> <li>M3SW mating module required</li> </ul>	White	M1203-LHW	M1223-LHW	
		Clear	M1203-LHC	M1223-LHC	
	TAMPER-RESISTANT (KEY)	<b>Single Pole</b>			
		<ul style="list-style-type: none"> <li>Tamper-Resistant (Key)</li> <li>Self-Grounding</li> <li>Fed Spec Rated</li> <li>MSPSW mating module required</li> </ul>	White	—	M1221-WL
			Ivory	M1201-IL	M1221-IL
		Brown	M1201-L	M1221-L	
		Gray	—	M1221-GL	
		Red	—	M1221-RL	
TAMPER-RESISTANT (KEY)	<b>3-Way</b>				
	<ul style="list-style-type: none"> <li>Tamper-Resistant (Key)</li> <li>Self-Grounding</li> <li>Fed Spec Rated</li> <li>M3SW mating module required</li> </ul>	White	—	M1223-WL	
		Ivory	M1203-IL	M1223-IL	
		Brown	M1203-L	M1223-L	
		Gray	—	M1223-GL	
		Red	—	M1223-RL	



M1223-LHC



M1221-WL

## INDUSTRIAL SPECIFICATION GRADE

### 120/277 V AC

Features		Color	15 Amp	20 Amp	
DECORA PLUS™	<b>Single Pole</b>				
	<ul style="list-style-type: none"> <li>Self-Grounding</li> <li>MSPSW mating module required</li> </ul>	White	M5691-W	M5621-W	
		Ivory	M5691-I	M5621-I	
		Lt Almond	M5691-T	M5621-T	
		Brown	—	M5621	
		Gray	M5691-GY	M5621-GY	
		Red	—	M5621-R	
	DECORA PLUS™	<b>3-Way</b>			
		<ul style="list-style-type: none"> <li>Self-Grounding</li> <li>M3SW mating module required</li> </ul>	White	M5693-W	M5623-W
			Ivory	M5693-I	M5623-I
		Lt Almond	M5693-T	M5623-T	
		Brown	—	M5623	
		Gray	M5693-GY	M5623-GY	
ILLUMINATED	<b>Single Pole</b>				
	<ul style="list-style-type: none"> <li>Lighted Rocker Locator - Rocker Illuminated when OFF</li> <li>Self-Grounding</li> <li>MSPSW mating module required</li> </ul>	White	—	M5631-W	
		Ivory	—	M5631-I	
		Lt Almond	—	M5631-T	
	ILLUMINATED	<b>3-Way</b>			
		<ul style="list-style-type: none"> <li>Lighted Rocker Locator - Rocker Illuminated when OFF</li> <li>Self-Grounding</li> <li>M3SW mating module required</li> </ul>	White	—	M5633-W
			Ivory	—	M5633-I
			Lt Almond	—	M5633-T



M5631-I

## MODULES

### FOR SINGLE POLE SWITCHES, 20 A, 347 V AC MAX.

Description	Module Color	Wire Type	Wire Colors	Catalog #
Stranded Wire Leads	Yellow	THHN	Black, Black, Green	MSPSW-ST
Stranded Wire Leads w/Push-in Wire Connectors	Yellow	THHN	Black, Black, Green	MSPSW-WST
Solid Wire Leads	Yellow	THHN	Black, Black, Green	MSPSW-SD
Stranded Wire Leads for 277 V Lighting Applications	Yellow	THHN	Brown, Brown, Green	MSPSW-7ST
Solid Wire Leads for 277 V Lighting Applications	Yellow	THHN	Brown, Brown, Green	MSPSW-7SD

### FOR 3-WAY SWITCHES, 20 A, 347 V AC MAX.

Stranded Wire Leads	Yellow	XHHW-2	Black, Red, Red, Green	M3WSW-ST
Stranded Wire Leads w/Push-in Wire Connectors	Yellow	XHHW-2	Black, Red, Red, Green	M3WSW-WST
Stranded Wire Leads for 277 V Lighting Applications	Yellow	XHHW-2	Brown, Yellow, Yellow, Green	M3WSW-7ST
Solid Wire Leads	Yellow	XHHW-2	Black, Red, Red, Green	M3WSW-SD

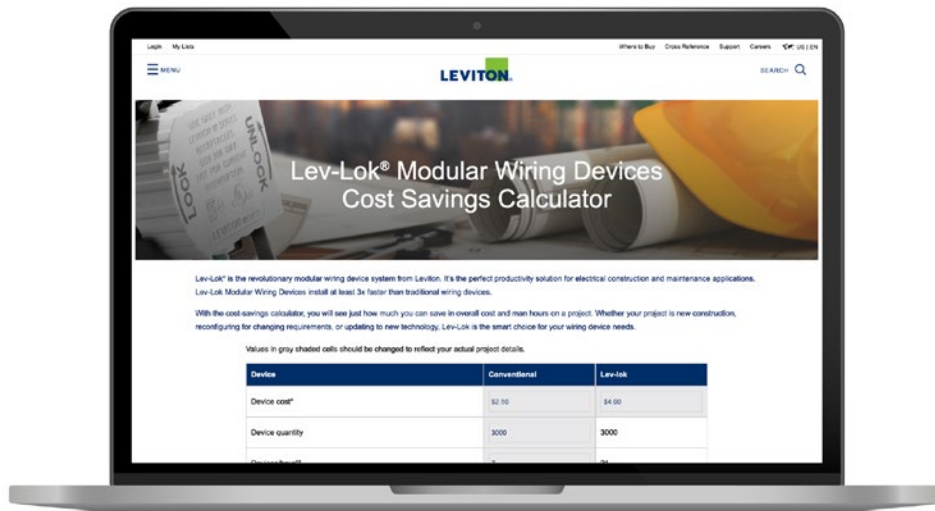

— CALCULATE YOUR SAVINGS ONLINE —  
[www.leviton.com/levlokcalculator](http://www.leviton.com/levlokcalculator)



FOR MORE INFORMATION ON THE FULL LINE: [www.leviton.com/levlok](http://www.leviton.com/levlok)

# Antimicrobial Treated Devices



Antimicrobial treated devices from Leviton contain an EPA registered silver ion additive that protects our switches and wallplates from contamination.

(WALLPLATES SOLD SEPARATELY)



A1221-2W  
Standard Toggle with  
84001-A40 Wallplate  
(SOLD SEPARATELY)

Look for the antimicrobial marking  
on treated wallplates and switches



Also available  
in Lev-Lok  
Modular  
Wiring Versions  
AM320-W Shown



A1223-GY

## INDUSTRIAL SPECIFICATION GRADE

120/277 V AC

### Features

			Color	15 Amp	20 Amp
STANDARD TOGGLE	<b>Single Pole</b>	<ul style="list-style-type: none"> <li>Antimicrobial Treated</li> <li>Back and Side Wire</li> <li>Self-Grounding</li> <li>Fed Spec Rated</li> </ul>	White	—	A1221-2W
			Ivory	—	A1221-2I
			Gray	—	A1221-GY
			Red	—	A1221-2R
	<b>3-Way</b>	<ul style="list-style-type: none"> <li>Antimicrobial Treated</li> <li>Back and Side Wire</li> <li>Self-Grounding</li> <li>Fed Spec Rated</li> </ul>	White	—	A1223-2W
			Ivory	—	A1223-2I
			Gray	—	A1223-GY
			Red	—	A1223-2R
LEV-LOK® MODULAR	<b>Single Pole</b>	<ul style="list-style-type: none"> <li>Antimicrobial Treated</li> <li>Self-Grounding</li> <li>Fed Spec Rated</li> <li>MSPSW mating module required</li> </ul>	White	—	AM120-W
			Ivory	—	AM120-I
			Gray	—	AM120-GY
			Red	—	AM120-R
	<b>3-Way</b>	<ul style="list-style-type: none"> <li>Antimicrobial Treated</li> <li>Self-Grounding</li> <li>Fed Spec Rated</li> <li>M3SWW mating module required</li> </ul>	White	—	AM320-W
			Ivory	—	AM320-I
			Gray	—	AM320-GY
			Red	—	AM320-R

## WALLPLATES

Antimicrobial Treated Single Gang Toggle	84001-A40
Antimicrobial Treated Single Gang Toggle Marked "EMERGENCY"	84001-E4A
Antimicrobial Treated Wallplate Two Gang Toggle	84009-A40







84009-A40  
Toggle Wallplate  
(SOLD SEPARATELY)





## COMMERCIAL SPECIFICATION GRADE

### 120/277 V AC

Features		Color	15 Amp	20 Amp	
DECORA PLUS™	<b>Single Pole</b>		White	—	A5621-2W
	<ul style="list-style-type: none"> <li>• Antimicrobial Treated</li> <li>• Back and Side Wire</li> <li>• Self-Grounding</li> </ul>		Ivory	—	A5621-2I
			Gray	—	A5621-2GY
			Red	—	A5621-2R
	<b>3-Way</b>		White	—	A5623-2W
	<ul style="list-style-type: none"> <li>• Antimicrobial Treated</li> <li>• Back and Side Wire</li> <li>• Self-Grounding</li> </ul>		Ivory	—	A5623-2I
			Gray	—	A5623-2GY
			Red	—	A5623-2R
SPECIALTY	<b>Single Pole Double Throw</b>	 	White	A5657-2W	—
	<ul style="list-style-type: none"> <li>• Antimicrobial Treated</li> <li>• Momentary Contact, Center OFF</li> <li>• Back and Side Wire</li> <li>• Self-Grounding</li> <li>• Available on special request</li> </ul>		Ivory	A5657-2I	—



### 24 V AC/DC

Features		Color	3 Amp		
SPECIALTY	<b>Single Pole Double Throw</b>	 	White	56A81-2W	—
	<ul style="list-style-type: none"> <li>• Antimicrobial Treated</li> <li>• Low Voltage</li> <li>• Momentary Contact, Center OFF</li> <li>• Back and Side Wire</li> <li>• Self-Grounding</li> <li>• Available on special request</li> </ul>		Ivory	56A81-2I	—



A5623-2W Decora Plus™ with 84401-A40 Wallplate (SOLD SEPARATELY)

## WALLPLATES

Antimicrobial Treated Single Gang Decora Plus™	84401-A40
Antimicrobial Treated Single Gang Decora Plus™ Marked "EMERGENCY"	84401-E4A
Antimicrobial Treated Two Gang Decora Plus™	84409-A40



84409-A40 Decora Plus™ Wallplate (SOLD SEPARATELY)

Leviton offers a wide variety of switches that are tailor-made for simple, unique or challenging applications.



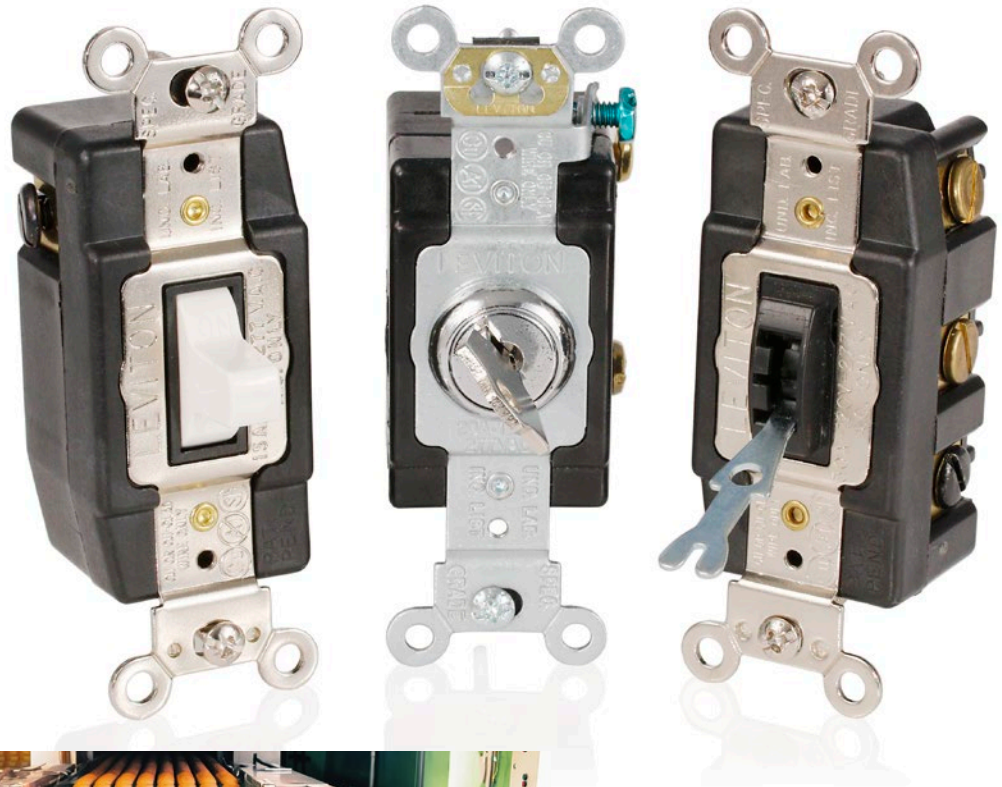

## INCLUDES...

- Tamper-Resistant
- Key Locking
- Momentary
- Maintained
- Hospital Call
- Low Voltage

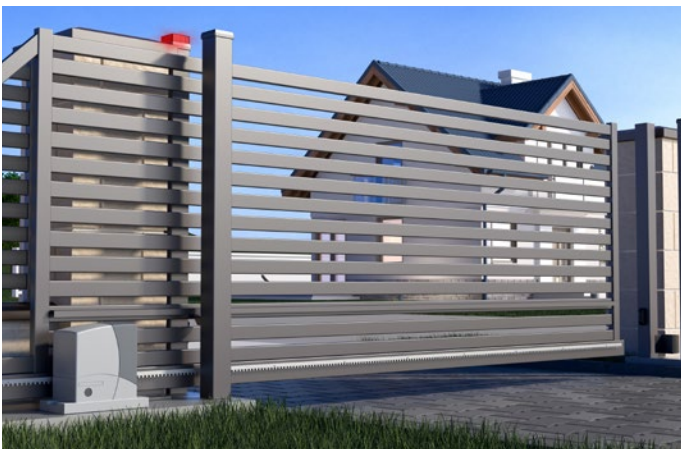

From fitness facilities to pools, conveyor systems to cooling fans, gates to lifts, Leviton has the switch to fit your need. For help choosing the appropriate solutions, contact your local Leviton sales representative.



INDUSTRIAL SPECIFICATION GRADE								
120/277 V AC								
Features		Color	15 Amp	20 Amp	30 Amp			
TAMPER-RESISTANT (KEY)	<b>Single Pole</b>	 	White	—	1221-2WL	—		
	• Tamper-Resistant (Key)		Ivory	1201-2IL	1221-2IL	—		
	• Back and Side Wire		Brown	1201-2L	1221-2L	3031-2L		
	• Self-Grounding		Gray	—	1221-2GL	—		
	• Fed Spec Rated		Red	—	1221-2RL	—		
	<b>Double Pole</b>	 	Ivory	—	1222-2IL	—		
	• Tamper-Resistant (Key)		Brown	1202-2L	1222-2L	3032-2L		
	• Back and Side Wire	 	White	—	1223-2WL	—		
	• Tamper-Resistant (Key)		Ivory	1203-L	1223-2IL	—		
	• Back and Side Wire		Brown	1203-2L	1223-2L	3033-2L		
	• Self-Grounding		Gray	—	1223-2GL	—		
	• Fed Spec Rated	 	White	—	1224-2WL	—		
<b>4-Way</b>	Ivory		—	1224-2IL	—			
• Tamper-Resistant (Key)	Brown		1204-2L	1224-2L	—			
• Back and Side Wire	Gray		—	1224-2GL	—			
• Self-Grounding		Chrome Lock	—	1221-2KL	—			
• Fed Spec Rated			<b>Single Pole</b>	Chrome Lock	—	1222-2KL	—	
• Key Locking				<b>Double Pole</b>	Chrome Lock	—	1223-2KL	—
• Back and Side Wire					<b>3-Way</b>	Chrome Lock	—	1224-2KL
• Self-Grounding		<b>4-Way</b>	Chrome Lock		—	1224-2KL	—	
• Key Locking				<b>Single Pole Double Throw</b>	White	1256-W	1257-W	—
• Back and Side Wire				Ivory	1256-I	1257-I	—	
• Self-Grounding	Lt Almond	—	1257-T	—				
MOMENTARY CONTACT TOGGLE			Brown	1256	1257	1260		
			Gray	1256-GY	1257-GY	—		
			Red	—	1257-R	—		
			Black	—	1257-L	—		
			<b>Single Pole Double Throw</b>			Black	—	1257-L
	• Momentary Contact, Center OFF					<b>Double Pole Double Throw</b>	Brown	—
• Tamper-Resistant (Key)	• Momentary Contact, Center OFF			• Back and Side Wire	• Self-Grounding			
• Back and Side Wire	• Self-Grounding							



## INDUSTRIAL SPECIFICATION GRADE

### 120/277 V AC

Features		Color	15 Amp	20 Amp	30 Amp
MAINTAINED CONTACT TOGGLE	<b>Single Pole Double Throw</b>	White	1281-W	1285-W	—
	• Maintained Contact, Center OFF	Ivory	1281-I	1285-I	1287-I
	• Back and Side Wire	Lt Almond	—	1285-T	—
	• Self-Grounding	Brown	1281	1285	1287
		Gray	—	1285-GY	—
MAINTAINED CONTACT TOGGLE	<b>Double Pole Double Throw</b>	White	1282-W	1286-W	1288-W
	• Maintained Contact, Center OFF	Ivory	1282-I	1286-I	1288-I
	• Back and Side Wire	Brown	1282	1286	1288
TAMPER-RESISTANT (MAINTAINED)	<b>Single Pole Double Throw</b>	Black	1281-L	1285-L	1287-L
	• Maintained Contact, Center OFF				
TAMPER-RESISTANT (MAINTAINED)	• Tamper-Resistant (Key)				
	• Back and Side Wire				
TAMPER-RESISTANT (MAINTAINED)	• Self-Grounding				
	<b>Double Pole Double Throw</b>	Black	—	—	1288-L
TAMPER-RESISTANT (MAINTAINED)	• Maintained Contact, Center OFF				
	• Tamper-Resistant (Key)				
TAMPER-RESISTANT (MAINTAINED)	• Back and Side Wire				
	• Self-Grounding				
HOSPITAL CALL TOGGLE	<b>Single Pole</b>	Ivory	5501-8I	—	—
	• Hospital Call	Brown	5501-8	—	—
HOSPITAL CALL TOGGLE	• Back & Side Wired				
	• Fed Spec Rated				
HOSPITAL CALL TOGGLE	<b>Double Pole</b>	Brown	5502-8	—	—
	• Hospital Call				
HOSPITAL CALL TOGGLE	• Back & Side Wired				
	• Fed Spec Rated				



1287-L



5501-8I

## INDUSTRIAL SPECIFICATION GRADE

### 347 V AC

Features		Color	15 Amp	20 Amp
TAMPER-RESISTANT (KEY)	<b>Single Pole</b>	Brown	18201-LB	18221-LB
	• Tamper-Resistant (Key)			
	• Back and Side Wire			
	• Non-Grounding			
TAMPER-RESISTANT (KEY)	• Canadian			
	<b>Double Pole</b>	Brown	18202-LB	18222-LB
	• Tamper-Resistant (Key)			
	• Back and Side Wire			
TAMPER-RESISTANT (KEY)	• Non-Grounding			
	• Canadian			
	<b>3-Way</b>	Brown	18203-LB	18223-LB
	• Tamper-Resistant (Key)			
TAMPER-RESISTANT (KEY)	• Back and Side Wire			
	• Non-Grounding			
	• Canadian			



18222-LB

## ACCESSORIES

Key for Tamper-Resistant Switch	55500-PRT
Replacement Key for Key Locking Switch	2KL

**INDUSTRIAL SPECIFICATION GRADE**  
**24 V AC/DC**

Features		Color	3 Amp
LOW VOLTAGE TOGGLE	<b>Single Pole</b>	White	12021-2W
	<ul style="list-style-type: none"> <li>• Back &amp; Side Wired</li> <li>• Self-Grounding</li> </ul>	Ivory	12021-2I
	<b>Single Pole Double Throw</b>	White	1081-W
	<ul style="list-style-type: none"> <li>• Back and Side Wire</li> <li>• Momentary Contact, Center OFF</li> <li>• Self-Grounding</li> </ul>	Ivory	1081-I
		Gray	1081-GY
		Red	1081-R

**COMMERCIAL SPECIFICATION GRADE**  
**120/277 V AC**

Features		Color	15 Amp
MOMENTARY CONTACT DECORA PLUS™	<b>Single Pole</b>	White	5655-2W
	<ul style="list-style-type: none"> <li>• Momentary Contact</li> <li>• Back &amp; Side Wired</li> <li>• Self-Grounding</li> </ul>	Ivory	5655-2I
	<b>Single Pole Double Throw</b>	Lt Almond	5655-2T
	<ul style="list-style-type: none"> <li>• Momentary Contact, Center OFF</li> <li>• Back &amp; Side Wired</li> <li>• Self-Grounding</li> </ul>	Black	5655-2E
		White	5657-2W
		Ivory	5657-2I
MAINTAINED CONTACT DECORA PLUS™	<b>Single Pole Double Throw</b>	Lt Almond	5657-2T
	<ul style="list-style-type: none"> <li>• Maintained Contact, Center OFF</li> <li>• Back &amp; Side Wired</li> <li>• Self-Grounding</li> <li>• Rocker imprinted with "HIGH" / "OFF" / "LOW" (On special request only - Catalog No. 5685-BW)</li> </ul>	Brown	5657-2
	<b>Single Pole Double Throw</b>	Gray	5657-2GY
	<ul style="list-style-type: none"> <li>• Maintained Contact, Center OFF</li> <li>• Green Grounding Lead</li> <li>• Back &amp; Side Wired</li> <li>• Self-Grounding</li> </ul>	Black	5657-2E
		White	5685-2W
		Ivory	5685-2I
MOMENTARY CONTACT DECORA PLUS™	<b>Double Pole Double Throw</b>	Lt Almond	5685-2T
	<ul style="list-style-type: none"> <li>• Maintained Contact, Center OFF</li> <li>• Green Grounding Lead</li> <li>• Back &amp; Side Wired</li> <li>• Self-Grounding</li> </ul>	Gray	5685-2GY
		Black	5685-2E
MAINTAINED CONTACT DECORA PLUS™	<b>Double Pole Double Throw</b>	White	5686-2W
	<ul style="list-style-type: none"> <li>• Maintained Contact, Center OFF</li> <li>• Green Grounding Lead</li> <li>• Back &amp; Side Wired</li> <li>• Self-Grounding</li> </ul>	Ivory	5686-2I
		Lt Almond	5686-2T

**COMMERCIAL SPECIFICATION GRADE**  
**24 V AC/DC**

Features		Color	3 Amp
LOW VOLTAGE DECORA PLUS™	<b>Single Pole</b>	White	56021-2W
	<ul style="list-style-type: none"> <li>• Low Voltage</li> <li>• Back and Side Wire</li> <li>• Self-Grounding</li> </ul>	Ivory	56021-2I
	<b>Single Pole Single Throw</b>	Black	56021-2E
	<ul style="list-style-type: none"> <li>• Low Voltage</li> <li>• Momentary Contact, Center OFF</li> <li>• Back and Side Wire</li> <li>• Self-Grounding</li> </ul>	White	56080-2W
		Ivory	56080-2I
		Lt Almond	56080-2T
		Black	56080-2E
	<b>Single Pole Double Throw</b>	White	56081-2W
	<ul style="list-style-type: none"> <li>• Low Voltage</li> <li>• Momentary Contact, Center OFF</li> <li>• Back and Side Wire</li> <li>• Self-Grounding</li> </ul>	Ivory	56081-2I
	Brown	56081-2	
	Red	56081-2R	



1081-W



5685-2W



56021-2W

# Select Wallplates Quick Order Guide

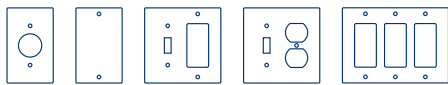

For the **FULL** offering of Leviton wallplates, visit [leviton.com/wallplates](http://leviton.com/wallplates)

## C-SERIES STAINLESS STEEL WALLPLATES

Description		Stainless Steel	
		Type 430	Type 302/304
1-GANG	Toggle Switch	SL1	SS1-40
	Toggle Switch, Midway	SLJ1-C	SSJ1-C40
	Decora®/Decora Plus™/GFCI	SL26	SS26-40
	Decora®/Decora Plus™/GFCI, Midway	SLJ82-C	SSJ82-C40
2-GANG	2 Toggle Switch	SL2	SS2-40
	2 Toggle Switch, Midway	SLJ2-C	SSJ2-C40
	1 Toggle Switch, 1 Duplex Receptacle	SL18	SS18-40
	1 Toggle Switch, 1 Decora®/Decora Plus™/GFCI	SL126	SS126-40
	2 Decora®/Decora Plus™/GFCI	SL262	SS262-40
	2 Decora®/Decora Plus™/GFCI, Midway	SLJ62-C	SSJ62-C40



## SPECIALTY WALLPLATES

Description	Cat. No.
<b>Gasketed Wallplate, Stainless Steel, 1-gang</b> For use with Decora®/Decora Plus™/GFCI/Occupancy Sensors	84401-G40
<b>Gasketed Wallplate, Stainless Steel, 1-gang, White</b> For use with Decora®/Decora Plus™/GFCI/Occupancy Sensors	84409-G40
<b>Gasketed Wallplate, Stainless Steel, 2-gang</b> For use with Decora®/Decora Plus™/GFCI/Occupancy Sensors	84401-G4W
<b>Gasketed Wallplate, Stainless Steel, 2-gang, White</b> For use with Decora®/Decora Plus™/GFCI/Occupancy Sensors	84409-G4W
<b>SPECIALTY Lockout Wallplate for Toggle Switches, Type 302 Stainless Steel</b> Includes Tamper-Resistant Screws and Spanner Wrench (Lock Not Included)	84001-LOK
<b>Wallplate for Key Locking Switches, Type 302 Stainless Steel, 1-gang</b> Includes Tamper-Resistant Screws and Spanner Wrench	84071-40
<b>Wallplate for Key Locking Switches, Type 302 Stainless Steel, 2-gang</b> Includes Tamper-Resistant Screws and Spanner Wrench	84072-40
<b>Wallplate for Key Locking Switches, Type 302 Stainless Steel, 3-gang</b> Includes Tamper-Resistant Screws and Spanner Wrench	84073-40
<b>Wetguard® Watertight (IP66, NEMA 4X) Toggle Switch Cover, FS/FD mount, Yellow</b> For use with 15-40 A Toggle Switches	COVER-S
<b>Wetguard® Watertight (IP66, NEMA 4X) Toggle Switch Cover, FS/FD mount, Gray</b> For use with 15-40 A Toggle Switches	COVER-GS

## SINGLE POLE AND SINGLE POLE ILLUMINATED

- ① Line Hot (Brass Screw)
- ② Load (Brass Screw)
- ③ Ground (Green Screw)

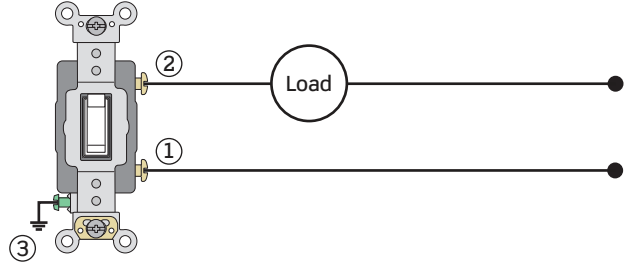

## SINGLE POLE PILOT LIGHT

- ① Line Hot (Black Screw)
- ② Neutral (Silver Screw)
- ③ Load (Brass Screw)
- ④ Ground (Green Screw)

NOTE: Neutral connection required.

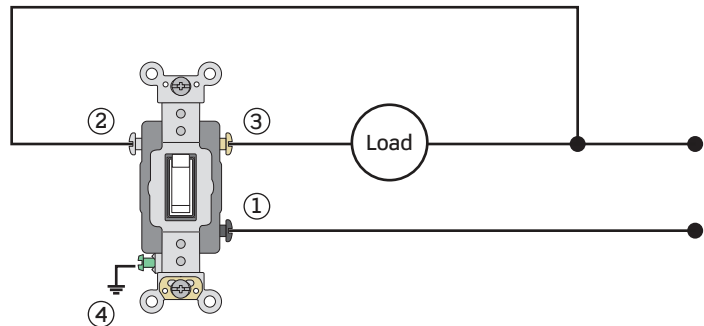

## DOUBLE POLE AND DOUBLE POLE PILOT LIGHT

- ① Line Hot (Black Screw)  
Circuit A
- ② Line Hot (Black Screw)  
Circuit B
- ③ Load (Brass Screw)  
Circuit A
- ④ Load (Brass Screw)  
Circuit B
- ⑤ Ground (Green Screw)

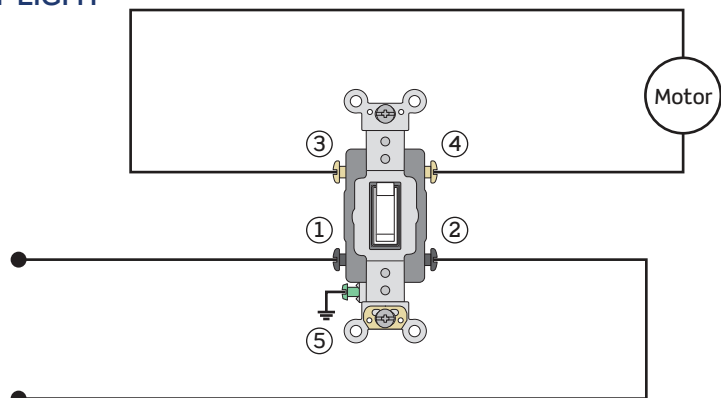

## 3-WAY AND 3-WAY ILLUMINATED

- ① Line Hot / Common (Black Screw)
- ② Travelers (Brass Screw to Brass Screw)
- ③ Load / Common (Black Screw)
- ④ Ground (Green Screw)

NOTE: Do not use this wiring configuration with 3-Way Pilot Light switches.

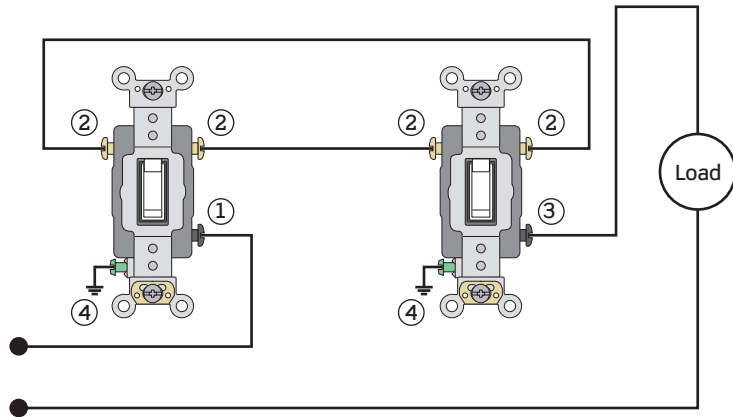

## 3-WAY PILOT LIGHT

- ① Line Hot / Common (Black Screw)
- ② Travelers (Brass Screw to Brass Screw)
- ③ Ground (Green Screw)
- ④ Load / Common (Black Screw)
- ⑤ Black Lead from Switch
- ⑥ White Lead from Switch
- ⑦ Neutral (White Wire)

NOTE: Neutral connection required.  
Black lead must connect to load at both switch locations.  
May require additional wiring to work properly.

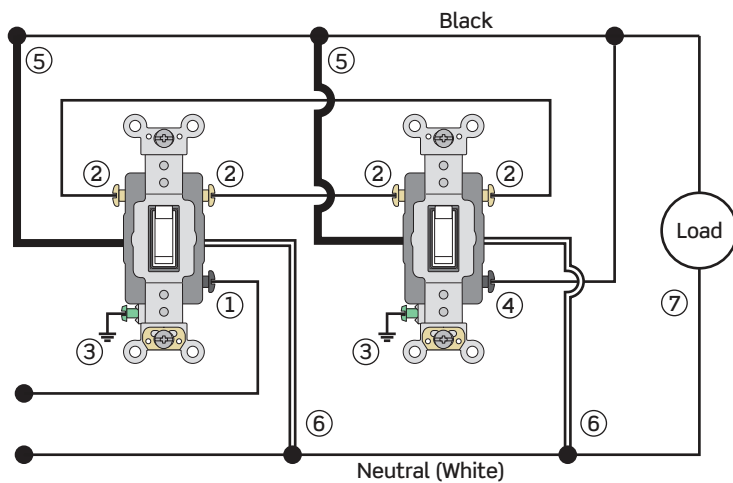

## 4-WAY

- ① Line Hot / Common (Black Screw)
- ② Travelers (Brass Screw from 3-Way to Brass Screw from 4-Way)
- ③ Ground (Green Screw)
- ④ Load / Common (Black Screw)

NOTE: Do not use 3-Way pilot light switches in a 4-Way application.

