

# Weatherproof metallic covers

## Code Keeper® metallic while-in-use covers

### Applications:

- Protects receptacles, switches and plugs for single-gang and two-gang configurations in dry and wet locations
- Provides a lockable cover that complies with OSHA lockout/tagout requirements
- Prevents accidental equipment disconnects, reduces tampering and deters theft and equipment removal

### Features/Benefits:

- Alloy A360 copper-free\* aluminum provides increased corrosion resistance
- Die-cast, metal construction provides long-lasting durability
- NEMA 3R Rating ensures protection against falling rain, sleet and external ice formation when used with appropriate device boxes
- Clear UL® and CSA markings speed approval by inspectors
- Wide range of cover depths and receptacle configurations accommodate almost every common plug and cord size when combined with included adapter plates
- Combination box or device mounting design provides flexibility in installation

### Standard materials:

- Covers and plates: Die-cast aluminum alloy A360 with less than .004 copper content (copper-free)
- Gaskets: Closed-cell foam

### Standard finish:

- Powder-coated finish

### Compliances:

- NEC® Section 406.9(B)
- UL® Listed
- CSA Certified

NEC and National Electrical Code are registered trademarks of the National Fire Protection Association, Inc.

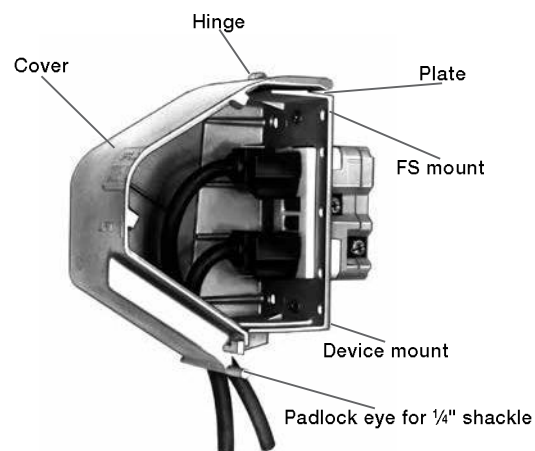

### Sample specifications:

- Code Keeper® covers shall comply with NEC® Section 406.9(B) and be die-cast copper-free\* aluminum alloy A360. Covers shall be finished powder-coated paint.
- Red•Dot® Catalog No. \_\_\_\_\_

\*Less than .004 copper content.

All 15- and 20-ampere, 125- and 250-volt receptacles installed outdoors in a wet location must have an enclosure that is weatherproof whether or not the attachment plug is inserted.

Code-Keeper® is required by the National Electrical Code® Section 406.9(B) for unattended in-use plugs in wet locations.

- Die-cast A360 aluminum alloy (less than .004% copper content)
- NEMA 3R Rating
- Clear UL® and CSA markings
- Wide range of cover depths and receptacle configurations
- Sturdy lockable cover tab complies with OSHA lockout/tagout requirements
- Combination box- or device-mount design (for most styles)
- Powder-coated finish
- “Extra-Duty” per NEC® Section 406.9(B)(1)



CKSUV

Single-gang  
small vertical



CKMU

Single-gang  
medium horizontal



CKMUV

Single-gang  
medium vertical



CKLSVU

Single-gang  
large vertical



2CKU

Two-gang

# Weatherproof metallic covers

## Code Keeper<sup>®</sup> metallic while-in-use covers—single gang

“Extra-Duty” per NEC<sup>®</sup> Section 406.9(B)(1)

CKSUV—Small vertical cover, 2¼" internal depth



Cat. No.	Color	Std. ctn.
CKSUV	Silver	8

Note: Covers packed with gasket and screws.

Use for any of these configurations:

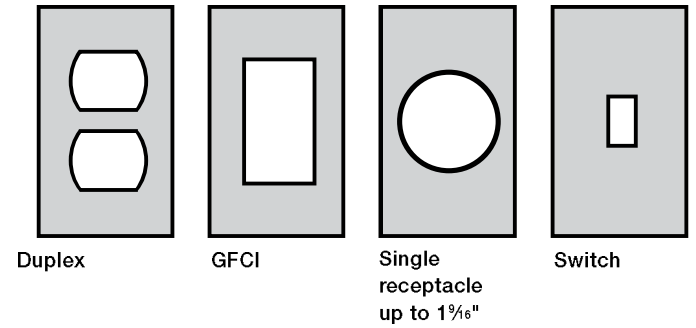

CKMU—Medium horizontal cover, 3¼" internal depth



Cat. No.	Color	Std. ctn.
CKMU	Silver	3

Note: Covers packed with gasket and screws.

Use for any of these configurations:

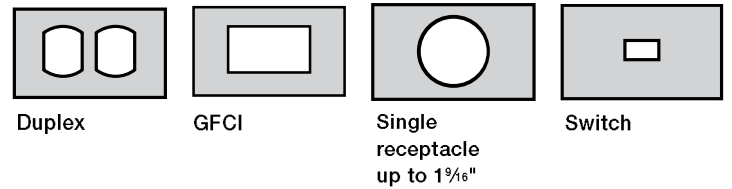

CKMUV—Medium vertical cover, 3¼" internal depth

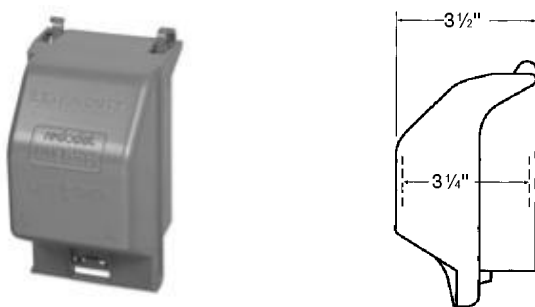

Cat. No.	Color	Std. ctn.
CKMUV	Silver	6

Note: Covers packed with gasket and screws.

Use for any of these configurations:

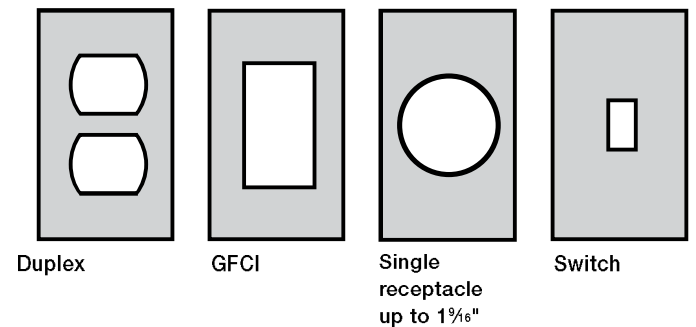

NEC and National Electrical Code are registered trademarks of the National Fire Protection Association, Inc.

# Weatherproof metallic covers

## Code Keeper® metallic while-in-use covers — single gang and two-gang

“Extra-Duty” per NEC® Section 406.9(B)(1)

CKLSVU — Large vertical cover, 4¾" internal depth

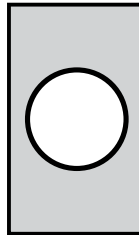
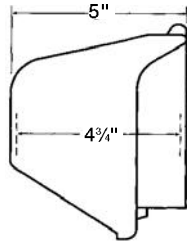

Single receptacle up to 2½"

Cat. No.	Color	Std. ctn.
CKLSVU	Silver	2

Note: Covers packed with gasket and screws.

2CKU — Regular cover, 4¼" internal depth

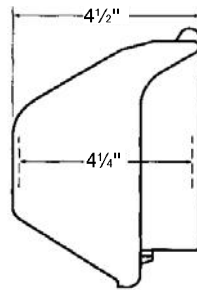

Use for any of these configurations:

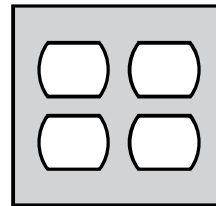

Two-duplex receptacle cover

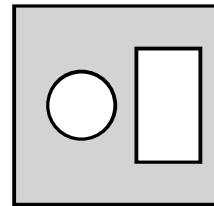

Single up to 1⅜" and GFCI receptacle cover

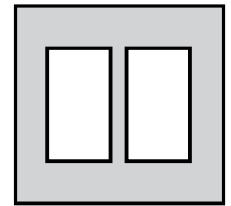

Two-GFCI receptacle cover

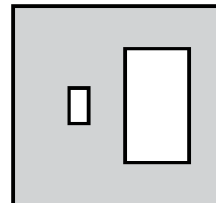

Toggle and GFCI receptacle cover

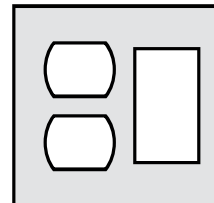

Duplex and GFCI receptacle cover

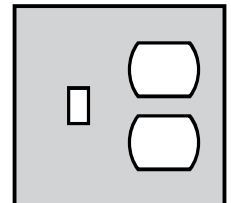

Toggle and duplex receptacle cover

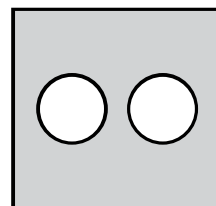

Two-single up to 1⅜" receptacle cover

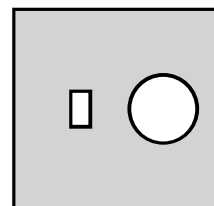

Toggle and single up to 1⅜" receptacle cover

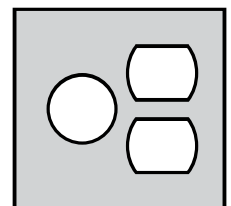

Single up to 1⅜" and duplex receptacle cover

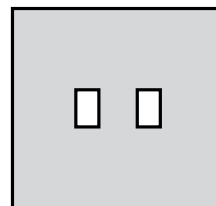

Two-toggle switch cover

Cat. No.	Color	Std. ctn.
2CKU	Silver	2

Note: Covers packed with gasket and screws.