

Installation Instructions

PHOTOSWITCH® Bulletin 42CA Cylindrical Photoelectric Sensors

IMPORTANT: SAVE THESE INSTRUCTIONS FOR FUTURE USE.
Refer to the product catalog pages for additional information.

Description

The 42CA 18 mm cylindrical family of general purpose photoelectric sensors is intended for light to medium duty industrial applications.

The 42CA family provides an indication if the sensor operation is unstable. An indicator flashes if the signal level is too close to the detection threshold. This helps for easy alignment of the sensor and forewarns against detection of a background.

Features

- 18 mm industry standard enclosure
- Wide selection of sensing modes
- Patented ASIC design offers linear sensitivity adjustment, stability indication and excellent noise immunity
- Two LED indicators provide status of power, output, unstable operation and short-circuit protection
- Complementary light and dark operate outputs
- Input to disable light source on transmitted beam emitter

User Interface

LED Color	State	Status
Yellow	OFF	Output de-energized❶
	ON	Output energized❶
Green	OFF	Power is OFF
	ON	Power is ON
	Flashing (6 Hertz)	Unstable (0.5 < Margin < 2)
	Flashing (1.5 Hertz)	Output short-circuit protection active

❶ Black wire or pin 4 of connector.

Specifications

Environmental	
Certifications	cULus and CE Marked for all applicable directives
Operating Environment	IP67
Operating Temperature [C (F)]	-25...+70° (-13...+158°)
Vibration	10...55 Hz, 1 mm amplitude, meets or exceeds IEC 60947-5-2
Shock	30 g with 1 ms pulse duration, meets or exceeds IEC 60947-5-2
Relative Humidity	5...95% (at temp. 50°C (122°F)) noncondensing
Ambient Light Immunity	Incandescent lamp 5000 lux, sunlight 108,000 lux

Optical					
Sensing Modes	Retro	Pol retro	Std diffuse	BGS	Trans beam
Sensing Range	4.8 & 7.2 m	3.8 m	100, 400 & 1000 mm	50 & 100 mm	16 m
Light Source	VR 660 nm	VR 660 nm	IR 880 nm	VR 660 nm	IR 880 nm
LED Indicators	Green and yellow, see User Interface				
Sensitivity Adjustment	Single-turn potentiometer on all standard diffuse, 7.2 m (23.6 ft) retroreflective and transmitted beam models				

Electrical	
Voltage	10...30V DC
Current Consumption	30 mA max
Sensor Protection	Reverse polarity, overload, short circuit

Outputs	
Response Time	1 ms (100 and 400 mm diffuse, 4.8 m retro, 3.8 m pol retro, and TB models) 0.5 m (1000 mm diffuse, 7.2 m retro and BGS models)
Output Type	PNP or NPN by cat. no.
Output Mode	Complementary light or dark operate, selectable light or dark operate for background suppression models
Output Current	100 mA max
Output Leakage Current	10 µA max

Mechanical	
Housing Material	PBT
Lens Material	PMMA
Lens Material	PMMA
Connection Types	2 m cable, 4-pin DC micro (M12) QD
Supplied Accessories	18 mm fastening nuts
Optional Accessories	Mounting brackets, reflectors, cordsets

Approximate Dimensions [mm (in.)]

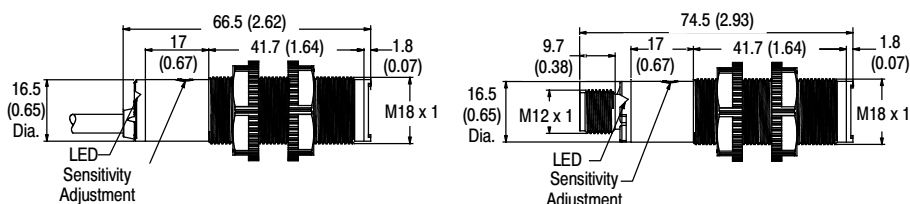

Wiring Diagrams

PNP Models with Complementary Outputs

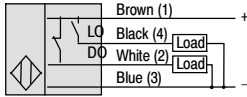

Transmitted Beam Emitter



- For normal operation, black wire (pin 2) needs no connection. To disable light source, connect black wire (pin 2) to -V.

NPN Models with Complementary Outputs

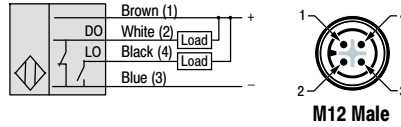

M12 Male

Additional Wiring Options for Background Suppression

NPN Output

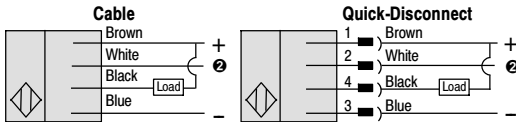

Face View Male Receptacle (Sensor) DC Micro

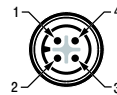

- Open circuit or tie white (2) and brown (1) conductors together for L.O. Tie white (2) and blue (3) conductors together for D.O.

PNP Output

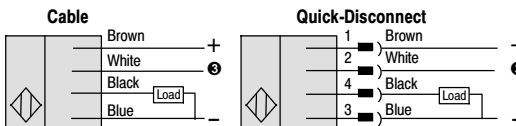

Face View Male Receptacle (Sensor) DC Micro

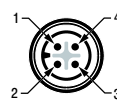

- Tie white (2) and brown (1) conductors together for L.O. Open circuit or tie white (2) and blue (3) conductors together for D.O.

Single Output, Dark Operate Models of Diffuse, Retroreflective and Polarized Retroreflective

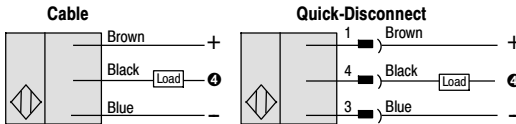

- For NPN type, tie the load to brown (+). For PNP type, tie the load to blue (-).

Typical Response Curves

Standard Diffuse [100 mm]

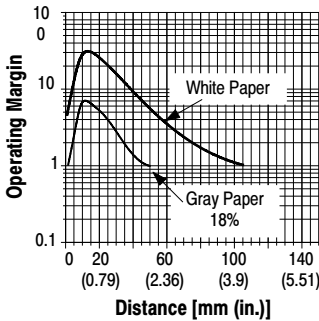

Background Suppression [50 mm]

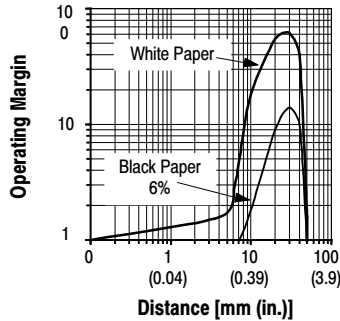

Background Suppression [100 mm]

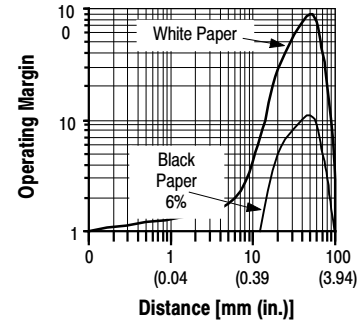

Operating Margin

Retroreflective [4.8 m]

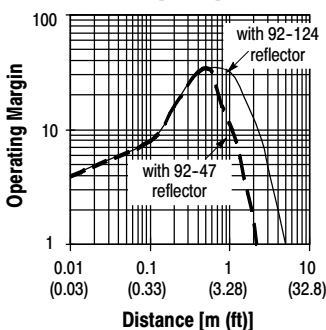

Retroreflective [7.2 m]

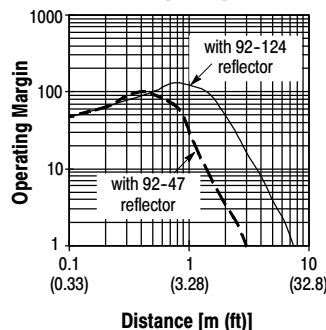

Polarized Retroreflective [3.8 m]

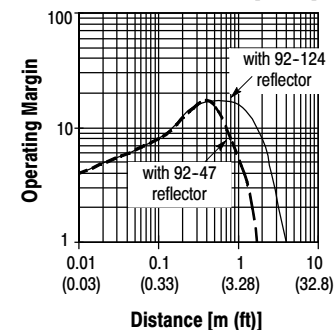

Typical Response Curves (continued)

Beam Pattern

Retroreflective [4.8 m]

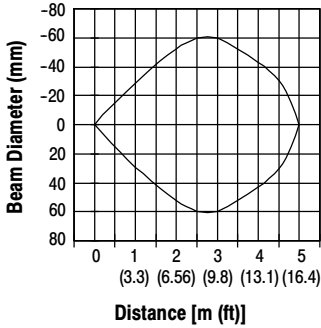

Retroreflective [7.2 m]

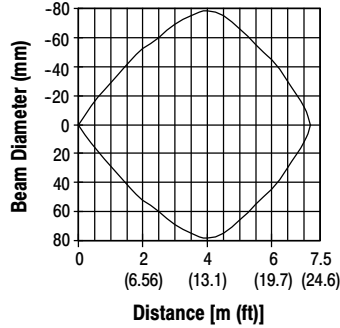

Polarized Retroreflective [3.8 m]

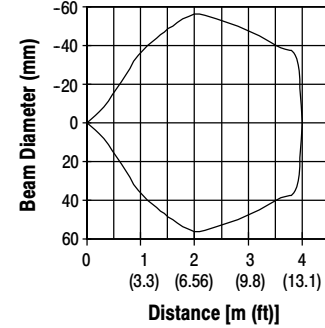

Operating Margin

Standard Diffuse [400 mm]

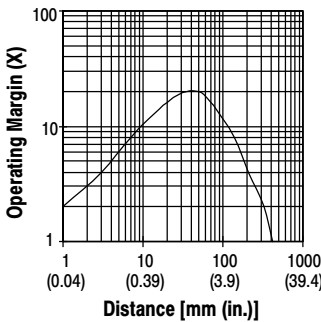

Standard Diffuse [1 m]

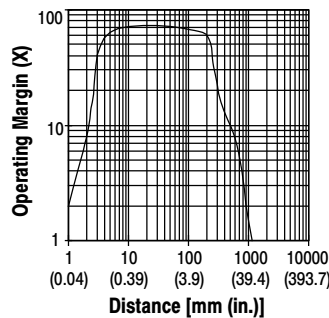

Transmitted Beam [16 m]

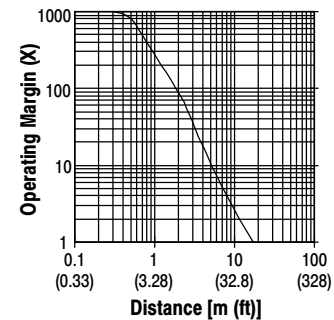

Beam Pattern

Standard Diffuse [400 mm]

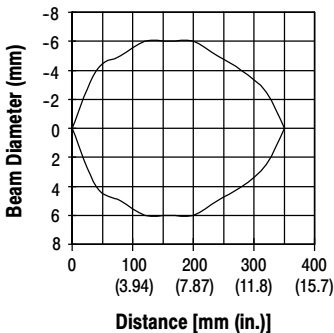

Standard Diffuse [1 m]

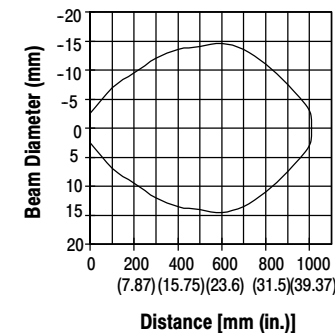

Transmitted Beam [16 m]

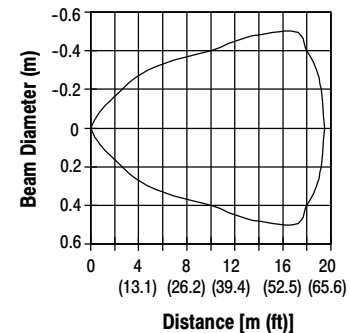

Sensor Alignment

1. Ensure that the sensitivity dial is set at its maximum (factory default) setting.
2. Pan the sensor left, right, up and down to center the beam on the sensed object (for diffuse), reflector (for retroreflective) or transmitter (for transmitted beam). Fix the sensor position when the green LED is ON (not flashing) and the yellow output LED is ON (light sensed and L.O. energized). This set up assures a good margin and that the signal received is greater than twice the signal required to energize the L.O. output.
3.
 - a. For diffuse applications, remove the object being sensed and observe the green LED. If the green LED is ON, the sensor is ready to operate. If the green LED is flashing (at 6 Hz), it indicates that the sensor is receiving more than half the signal required to energize the L.O. output when there should be minimal or no received signal. It

indicates that the sensor is getting close to detection of a background. Stability may be optimized by reducing the reflectivity of the background or reducing the sensitivity. Reducing the sensitivity shortens the sensing range. If sensitivity is reduced, check that the green and yellow LEDs are on when the object is detected (step 2 above). In applications where full range is needed, i.e., sensitivity cannot be reduced, the green LED may be left flashing.

- b. For retroreflective and transmitted beam applications, place the object to be sensed in the beam path and observe the green LED. If the green LED is ON, the sensor is ready to operate. If the green LED is flashing (at 6 Hz), it indicates that the sensor is receiving more than half the signal required to energize the L.O. output when there should be minimal or no received signal. It indicates that the object being detected is letting some light go through (semi-transparent or too small in size). Adjust sensitivity and repeat step 2.

Retroreflective/Polarized Retroreflective

For shiny objects, angle the sensor so that the beam is not perpendicular to the object. For highly reflective materials use a polarized retroreflective sensor.

Transmitted Beam

For applications requiring adjacent sensors, you can alternate the position of the receiver and the emitter to avoid sensor crosstalk. For applications requiring more than two adjacent sensors, you must space adjacent emitters (as well as adjacent receivers) at least 1 m (3.28 ft) apart (see transmitted beam, beam pattern on page).

Mounting the Sensor

Securely mount the sensor on firm, stable surface or support. For installation convenience, we offer the following mounting brackets.

ATTENTION



A mounting, which is subject to excessive vibration or shifting may cause intermittent operation.

Swivel/Tilt Bracket #60-2649

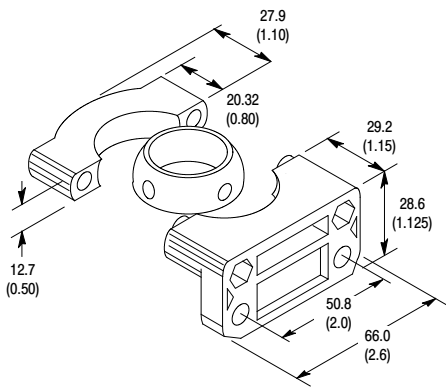

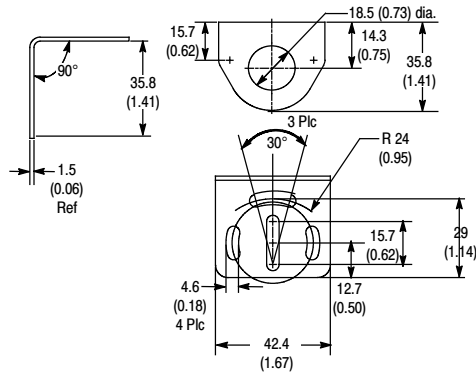

Right Angle Bracket #60-2657

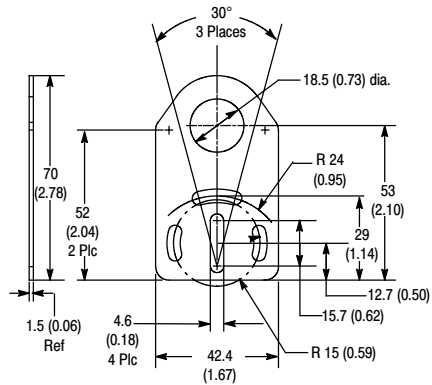

Straight Bracket #60-2656

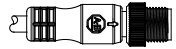

Cordsets & Accessories

Description	Cat. No.
 DC Micro QD Cordset, 4-pin, 2 m	889D-F4AC-2
 Reflector, 0.76 mm (3 in.) diameter with center mount hole	92-124
 Reflector, 32 mm (1.25 in.) dia. Requires adhesive backing.	92-47

www.rockwellautomation.com

Power, Control and Information Solutions Headquarters

Americas: Rockwell Automation, 1201 South Second Street, Milwaukee, WI 53204 USA, Tel: (1) 414.382.2000, Fax: (1) 414.382.4444

Europe/Middle East/Africa: Rockwell Automation, Vorstlaan/Boulevard du Souverain 36, 1170 Brussels, Belgium, Tel: (32) 2 663 0600, Fax: (32) 2 663 0640

Asia Pacific: Rockwell Automation, Level 14, Core F, Cyberport 3, 100 Cyberport Road, Hong Kong, Tel: (852) 2887 4788, Fax: (852) 2508 1846

PN-315686

10000036196 Ver 01