

Plant truxure™

Unity and OPC software

Catalog

January **2018**



Unity Pro
Unity EFB Toolkit
Unity DIF
Unity Loader
Unity specific Libraries



OPC Factory Server

Schneider
 Electric

Quick access to Product information

Select your Catalog, your Training

Digi-Cat

The complete digital catalog for industrial automation



Makes your choice easy every day, everywhere!



With just 3 clicks, you can reach the 7,000 pages of the Industrial Automation & Control catalog, in both English and French.

- Digi-Cat is available on a USB key (for PC). To get your Digi-Cat, please contact your local center
- Download Digi-Cat from this address:

<http://digi-cat.schneider-electric.com/download.html>

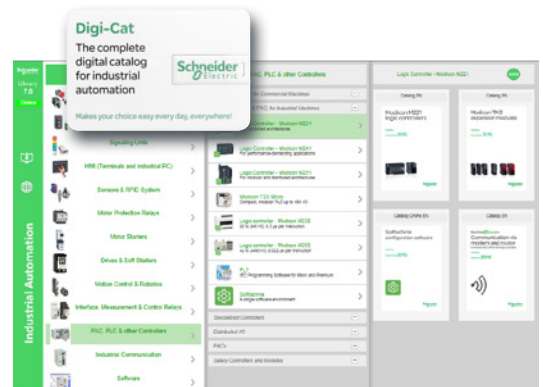

Find your training

- Find the right training for your needs
- Locate the training center with the selector tool, using this address:

<http://www.schneider-electric.com/b2b/en/services/training/technical-training.jsp>

then click on

Find your training center

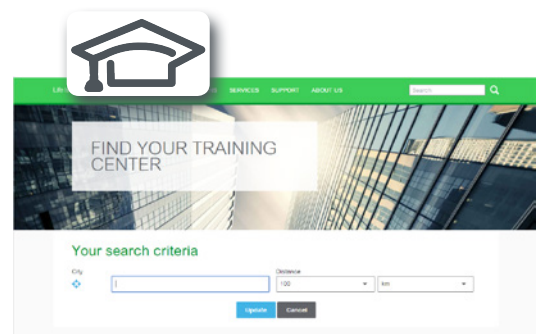

Life Is On



General contents

Unity Pro software

1

Companion software

2

OPC data server software,
Product reference index

3

In this catalog, each time words which refer to Safety without precision, must be understood according to "Functional Safety": IEC61508 & IEC61511.

Unity Pro software

<i>Selection guide</i>	<i>page 1/2</i>
■ Presentation.....	<i>page 1/6</i>
■ Cyber security.....	<i>page 1/6</i>
■ FDT/DTM.....	<i>page 1/6</i>
■ Programming languages	<i>page 1/7</i>
■ Functions	<i>page 1/8</i>
■ Communication drivers	<i>page 1/18</i>
■ Windows OS compatibility.....	<i>page 1/18</i>
■ Unity Pro update.....	<i>page 1/19</i>
■ References	<i>page 1/20</i>



Unity Pro programming software for Modicon M340 **M**, Modicon M580 **M5**, Modicon M580 Safety **M5S**, Modicon Momentum **MM**, Premium **P**, Quantum **Q**, Quantum Safety **QS** and Modicon distributed I/O **D** platforms



IEC 61131-3 languages	Instruction List (IL)	M - MM - D	M - M5 - MM - P - Q - D
	Ladder (LD)	M - MM - D	M - M5 - MM - P - Q - D
	Structured Text (ST)	M - MM - D	M - M5 - MM - P - Q - D
	Function Block Diagram (FBD)	M - MM - D	M - M5 - MM - P - Q - D
	Sequential Function Chart (SFC)/Grafcet	M - MM - D	M - M5 - MM - P - Q - D
Ladder Logic Language LL984		M - MM	M - M5 - MM - Q
Programming services	Multitask programming (Master, fast and event-triggered)	M - MM (master task only) - D	M - M5 - MM (master task only) - P - Q - D
	Multitask programming (Master, fast, auxiliary and event-triggered)		M5
	Functional view and function modules	M - MM - D	M - M5 - MM - P - Q - D
	DFB editor and instances	M - MM - D	M - M5 - MM - P - Q - D
	DDT compound data editors	M - MM - D	M - M5 - MM - P - Q - D
	Data structure instances and tables	M - MM - D	M - M5 - MM - P - Q - D
	EF and EFB libraries	M - MM - D	M - M5 - MM - P - Q - D
	User-definable control loops		P (TSXP572●/3●/4●) - D
	Programmable control loops (with process control FB library)	M - MM - D	M - M5 - MM - P - Q - D
	Safety function block libraries		
	Motion function block (MFB) libraries	M - MM - D	M - M5 - MM - P - Q - D
	Hot Standby PLC redundancy system		P (TSXH5724M/44M) - D
	System and Application diagnostics	M - MM - D	M - M5 - MM - P - Q - D
	Bus and network configuration to slave devices (Modicon distributed I/O, etc.)	M - MM - D	M - M5 - MM - P - Q - D
Debugging and display services	PLC simulator	M - MM - D	M - M5 - MM - P - Q - D
	Hypertext link animations in graphic languages	M - MM - D	M - M5 - MM - P - Q - D
	Step by step execution, Breakpoint, Watchpoint	M - MM - D	M - M5 - MM - P - Q - D
	Trending tool	M - MM - D	M - M5 - MM - P - Q - D
	Operator screens, Animation tables	M - MM - D	M - M5 - MM - P - Q - D
	Diagnostics viewer	M - MM - D	M - M5 - MM - P - Q - D
Other services	Creation of hyperlinks	M - MM - D	M - M5 - MM - P - Q - D
	XML/XVM import/export	M - MM - D	M - M5 - MM - P - Q - D
	Application converters (Modsoft, Concept, ProWORX, PL7)	M	M - M5 - MM - P - Q - D
	Utilities for updating PACs and Advantys operating system	M - MM - D	M - M5 - MM - P - Q - D
	Communication drivers for Modicon platforms	M - MM - D	M - M5 - MM - P - Q - D
	Unity Pro servers - Openness (OFS, 3rd party tools)	M - MM - D	M - M5 - MM - P - Q - D
	Online modification of the configuration		M5 - Q
	Online modification of the program	M - MM - Q	M - M5 - MM - P - Q
	Importing of applications (Modsoft, Concept, ProWORX) written in LL984 language	M - MM	M - MM - Q
	Data dictionary, Dynamic exchange with SCADA through OFS	M - MM - D	M - M5 - MM - P - Q - D
	Static exchange via XML/XVM export files	M - MM - D	M - M5 - MM - P - Q - D
Compatible Modicon platforms	Modicon M340 CPUs M	All models	All models
	Modicon M580 CPUs M5	-	BMEP5810/5820/5830/BMEH5820
	Modicon M580 Safety CPUs M5S	-	BMEP5810/5820/5830/BMEH5820
	Modicon Momentum CPUs MM	171CBU78090/98090/98091	171CBU78090/98090/98091
	Premium CPUs P	-	TSXP57104M/1634M/154M TSXP57204M/2634M/254M TSXP57304M/3634M/354M
	Quantum CPUs Q	-	140CPU31110 140CPU43412U 140CPU53414U
	Quantum Safety CPUs S	-	-
Compatible Modicon distributed I/O D	STB, OTB, TM7, ETB, Momentum	STB, OTB, TM7, ETB, Momentum	STB, OTB, TM7, ETB, Momentum
Software name	Unity Pro Small	Unity Pro Large	Unity Pro Extra Large
Unity Pro package	UNYSPUS●●V1X	UNYSPUL●●V1X	UNYSPUE●●V1X
License, see page	1/21	1/22	1/23

Unity Pro programming software for Modicon M340 **M**, Modicon M580 **M5**, Modicon M580 Safety **M5S**, Modicon Momentum **MM**, Premium **P**, Quantum **Q**, Quantum Safety **QS** and Modicon distributed I/O **D** platforms



	M - M5 - MM - P - Q - D	M - M5 - M5S - MM - P - Q - D
	M - M5 - MM - P - Q - D	M - M5 - M5S - MM - P - Q - D
	M - M5 - MM - P - Q - D	M - M5 - M5S - MM - P - Q - D
	M - M5 - MM - P - Q - D	M - M5 - M5S - MM - P - Q - D
	M - M5 - MM - P - Q - D	M - M5 - M5S - MM - P - Q - D
	M - M5 - MM - P - Q - D	M - M5 - M5S - MM - P - Q - D
	M - M5 - MM - Q	M - M5 - M5S - MM - Q
	M - M5 - MM (master task only) - P - Q - D	M - M5 - M5S - MM (master task only) - P - Q - D
	M5 - P (TSXP575●) - Q (140CPU651/671) - D	M5 - M5S - P (TSXP575●) - Q (140CPU651/671) - D
	M - M5 - MM - P - Q - D	M - M5 - M5S - MM - P - Q - D
	M - M5 - MM - P - Q - D	M - M5 - M5S - MM - P - Q - D
	M - M5 - MM - P - Q - D	M - M5 - M5S - MM - P - Q - D
	M - M5 - MM - P - Q - D	M - M5 - M5S - MM - P - Q - D
	M - M5 - MM - P - Q - D	M - M5 - M5S - MM - P - Q - D
	P (TSXP572●/3●/4●/5●) - D	P (TSXP572●/3●/4●/5●) - D
	M - M5 - MM - P - Q - D	M - M5 - M5S - MM - P - Q - D
		M5S
	M - M5 - MM - P - D	M - M5 - M5S - MM - P - D
	P (TSXH5724M/44M) - Q (140CPU67160) - D	P (TSXH5724M/44M) - Q (140CPU67160) - D
	M - M5 - MM - P - Q - D	M - M5 - M5S - MM - P - Q - D
	M - M5 - MM - P - Q - D	M - M5 - M5S - MM - P - Q - D
	M - M5 - MM - P - Q - D	M - M5 - M5S - MM - P - Q - D
	M - M5 - MM - P - Q - D	M - M5 - M5S - MM - P - Q - D
	M - M5 - MM - P - Q - D	M - M5 - M5S - MM - P - Q - D
	M - M5 - MM - P - Q - D	M - M5 - M5S - MM - P - Q - D
	M - M5 - MM - P - Q - D	M - M5 - M5S - MM - P - Q - D
	M - M5 - MM - P - Q - D	M - M5 - M5S - MM - P - Q - D
	M - M5 - MM - P - Q - D	M - M5 - M5S - MM - P - Q - D
	M - M5 - MM - P - Q - D	M - M5 - M5S - MM - P - Q - D
	M - M5 - MM - P - Q - D	M - M5 - M5S - MM - P - Q - D
	M - M5 - MM - P - Q - D	M - M5 - M5S - MM - P - Q - D
	M - M5 - MM - P - Q - D	M - M5 - M5S - MM - P - Q - D
	M - M5 - MM - P - Q - D	M - M5 - M5S - MM - P - Q - D
	M - M5 - MM - P - Q - D	M - M5 - M5S - MM - P - Q - D
	M - M5 - MM - P - Q - D	M - M5 - M5S - MM - P - Q - D
	M5 - Q	M5 - M5S - Q
	M - M5 - MM - P - Q	M - M5 - M5S - MM - P - Q
	M - M5 - MM - Q	M - M5 - M5S - MM - Q
	M - M5 - P - Q - D	M - M5 - M5S - P - Q - D
	M - M5 - MM - P - Q - D	M - M5 - M5S - MM - P - Q - D
	All models	All models
	All models	All models
	All models	All models
	171CBU78090/98090/98091	171CBU78090/98090/98091
	All models	All models
	All models	All models
	-	-
	STB, OTB, TM7, ETB, Momentum	STB, OTB, TM7, ETB, Momentum
Software name	Unity Pro Small	Unity Pro Extra Large Safety
Unity Pro package	UNYSPUS●●V1X	UNYSPUX●●V1X
License, see page	1/21	1/24

Software

Unity Pro software

Unity Pro V7 XL Safety for Quantum

Unity Pro programming software for Modicon M340 M, Modicon M580 M5, Modicon M580 Safety M5S, Modicon Momentum MM, Premium P, Quantum Q, Quantum Safety QS and Modicon distributed I/O D platforms



IEC 61131-3 languages	Instruction List (IL)	Q
	Ladder (LD)	Q - QS
	Structured Text (ST)	Q
	Function Block Diagram (FBD)	Q - QS
	Sequential Function Chart (SFC)/Grafcet	Q
Ladder Logic Language LL984		Q
Programming services	Multitask programming (Master, fast and event-triggered)	Q
	Multitask programming (Master, fast, auxiliary and event-triggered)	Q (140CPU651/671)
	Functional view and function modules	Q - QS
	DFB editor and instances	Q - QS
	DDT compound data editors	Q
	Data structure instances and tables	Q
	EF and EFB libraries	Q
	User-definable control loops	
	Programmable control loops (with process control FB library)	Q
	Safety function block libraries	QS
	Motion function block (MFB) libraries	
	Hot Standby PLC redundancy system	Q (140CPU67160)
	System and Application diagnostics	Q - QS
	Bus and network configuration to slave devices (Modicon distributed I/O, etc.)	Q
Debugging and display services	PLC simulator	Q - QS
	Hypertext link animations in graphic languages	Q - QS
	Step by step execution, Breakpoint, Watchpoint	Q - QS
	Trending tool	Q - QS
	Operator screens, Animation tables	Q - QS
	Diagnostics viewer	Q - QS
Other services	Creation of hyperlinks	Q - QS
	XML/XVM import/export	Q - QS
	Application converters (Modsoft, Concept, ProWORX, PL7)	Q
	Utilities for updating PACs and Advantys operating system	Q
	Communication drivers for Modicon platforms	Q - QS
	Unity Pro servers - Openness (OFS, 3rd party tools)	Q - QS
	Online modification of the configuration	
	Online modification of the program	
	Importing of applications (Modsoft, Concept, ProWORX) written in LL984 language	Q
	Data dictionary, Dynamic exchange with SCADA through OFS	Q - QS
	Static exchange via XML/XVM export files	Q - QS
Compatible Modicon platforms	Modicon M340 CPUs M	-
	Modicon M580 CPUs M5	-
	Modicon M580 Safety CPUs M5S	-
	Modicon Momentum CPUs MM	-
	Premium CPUs P	-
	Quantum CPUs Q	140CPU31110 140CPU65150/60 140CPU43412U 140CPU65260 140CPU53414U 140CPU67160 140CPU67260/61
	Quantum Safety CPUs S	140CPU65160S 140CPU67160S
Compatible Modicon distributed I/O D		-
Software name	Unity Pro Extra Large Safety	
Unity Pro package	UNYSPUX...V1X	
License, see page	www.schneider-electric.com	

Unity Pro programming software for Modicon M340 M, Modicon M580 M5, Modicon M580 Safety M5S, Modicon Momentum MM, Premium P, Quantum Q, Quantum Safety QS and Modicon distributed I/O D platforms



M - MM - P - D	
M - MM - P - D	
M - MM - P - D	
M - MM - P - D	
M - MM - P - D	
M - MM	
M - MM (master task only) - P - D	
P (TSXP575) - D	
M - MM - P - D	
M - MM - P - D	
M - MM - P - D	
M - MM - P - D	
M - MM - P - D	
P (TSXP572/3/4/5) - D	
M - MM - P - D	
D	
M - MM - P - D	
P (TSXH5724M/44M) - D	
M - MM - P - D	
M - MM - P - D	
M - MM - P - D	
M - MM - P - D	
M - MM - P - D	
M - MM - P - D	
M - MM - P - D	
M - MM - P - D	
M - MM - P - D	
M - MM - P - D	
M - MM - P - D	
M - MM - P - D	
M - MM - P - D	
M - MM - P - D	
M - MM - P - D	
M - MM - P - D	
M - MM - P - D	
M - MM	
M - P - D	
M - MM - P - D	
All models	
-	
-	
171CBU78090/98090/98091	
TSXP57104M/1634M/154M	TSXP574634M/454M
TSXP57204M/2634M/254M	TSXP575634M/554M
TSXP57304M/3634M/354M	TSXP576634M
	TSXH5724M/44M
-	
-	
STB, OTB, TM7, ETB, Momentum	
Unity Pro Extra Large Safety	
UNYSPUX...V1X	

1



Unity Pro

Presentation

This catalog describes Unity Pro software version 13, which is the latest version available.

Unity Pro is the common programming, debugging and operating software for the Modicon M340, M580, M580S, Premium, Momentum and Quantum ranges.

Note: Please, use Unity Pro software V7 for Quantum SIL3 (safety integrity level 3).

Unity Pro is multitasking software offering the following features:

- All-in-one software
- Five IEC 61131-3 programming languages
- LL 984 programming language
- Device integration with FDT/DTM standard
- Integrated, customizable DFB library
- PLC simulator on PC for program validation prior to installation
- Built-in tests and diagnostics
- Wide range of online services
- Cybersecurity

Unity Pro supports the new M580 Safety PACs, mixing process and safety in a single project. It allows to:

- Optimize engineering time
- Simplify programming with IEC61508 functions
- Facilitate maintenance

Cybersecurity

Schneider Electric constantly endeavours to maintain the security of its systems. Security guidelines are available for our customers to ensure their systems are protected from attack.

With the Modicon M340, M580, M580S, Premium, Momentum and Quantum automation platforms:

- Protection against remote programming changes via a password
- Option to enable or disable HTTP or FTP services

With the Modicon M580 automation platform:

- Log of security events in the SYSLOG database
- Extended Ethernet services management (DHCP, etc.) can be set for each user in the Access Control List
- More secure IPsec communication between Unity Pro or SCADA and PAC

FDT/DTM function

Unity Pro facilitates integration of fieldbus architectures into engineering control systems using FDT/DTM technology:

- FDT (*Field Device Tool*) is the container which supports the device DTM.
- DTM (*Device Type Manager*) is the configuration tool for devices with integrated graphic interfaces. It contains the properties specific to each device.

In addition to the FDT/DTM standard, Unity Pro uses specific information from the Master DTM created for the Profibus Remote Master (PRM) module, the HART module, the Premium ISPY101 weighing module, Altivar process drive integration and the Modbus/TCP and EtherNet/IP network modules BMXNOC0401 and BMENOC03●1.

Use of the Master DTM allows Unity Pro to perform the following actions:

- Manage the PAC I/O scan
- Create the application variables based on the description of the process objects available from the connected DTM devices
- Manage synchronization with the PAC configuration
- Create a generic DTM from the description files (GSD or EDS)

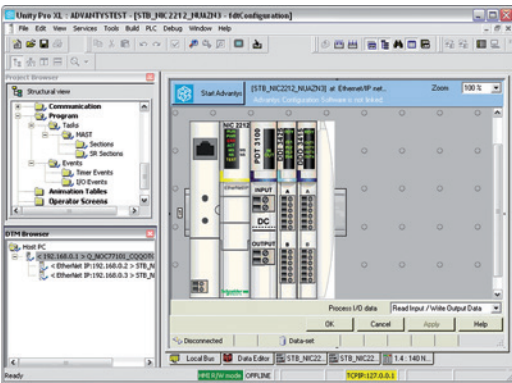

DTM editor (Modicon STB island)

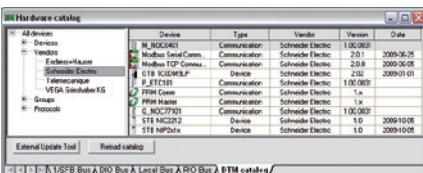

DTM hardware catalog

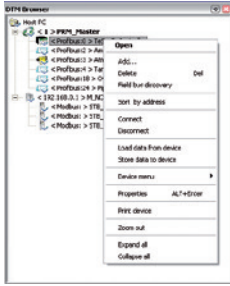

DTM browser and DTM context menu

FDT/DTM function (continued)

The DTM configuration is stored in the PAC memory so that the application can be downloaded in its entirety. It is also saved in the PAC project file (STU), the archive file (STA), and the full application exchange file (ZEF).

A third-party DTM can be installed in the DTM hardware catalog. The DTM hardware catalog can be used to sort or filter the DTM's according to various criteria such as Device, Vendor, Groups or Protocols.

The DTM Browser in Unity Pro:

- Displays the fieldbus topologies in a tree structure
- Allows the user to configure the DTM devices:
 - add and delete DTM's
 - connect and disconnect DTM's to/from their physical devices
 - display and print the properties of a DTM
 - transfer DTM configuration data to and from the physical device
 - functions specific to the DTM, via the Device menu

The fieldbus lookup function scans the physical devices in a fieldbus network and adds the selected devices to the DTM Browser.

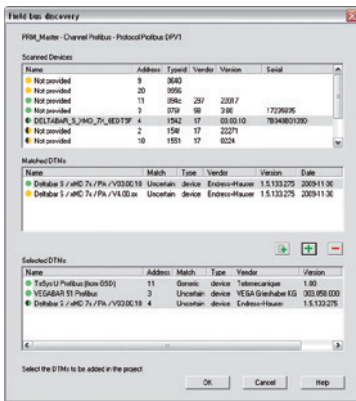

Fieldbus lookup screen

Programming languages

The five IEC 61131-3 compliant languages

The five graphical or textual languages available in Unity Pro are used for programming Modicon M340, Modicon M580, Modicon M580 Safety, Modicon Momentum, Premium and Quantum automation platforms.

The three graphical languages are:

- Ladder (LD) language
- Function Block Diagram (FBD)
- Sequential Function Chart (SFC) or Grafcet

The two textual languages are:

- Structured Text (ST)
- Instruction List (IL)

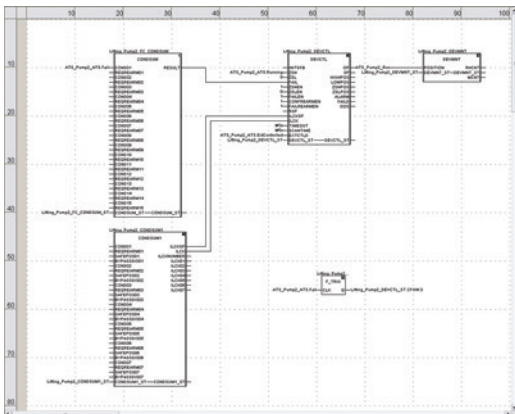

FBD language editor

For these five languages, you can use the standard set of instructions compliant with IEC standard 61131-3 to create applications which can be transferred from one platform to another. Unity Pro software also provides extensions to this standard set of instructions. As they are specific to Modicon M340, Modicon M580, Modicon M580 Safety, Modicon Momentum, Premium and Quantum automation platforms, these extensions support the development of more complex applications in order to maximize the potential of the specific features of each of these platforms.

LL984 language

LL984 (Ladder Logic 984) language enables migration from legacy Modicon ranges. It is used to program Modicon M580, Modicon M580 Safety, Modicon M340, Momentum and Quantum automation platforms.

1



Common Safety on Modicon M580 (1)

Presentation

Unity Pro user-friendly interface for Modicon automation platforms family is now available for safety.

Unity Pro allows to:

- manage a complete control and safety automation system from design to operation and maintenance.
- increase productivity during engineering, commissioning and operation for both process and safety, reducing time to market.

Unity Pro makes it possible to design a common safety architecture by executing:

- safety functions of your process in specific safety tasks,
- standard functions in other tasks.

All X80 safety I/O are managed through safety tasks, and standard and non interfering X80 modules are managed in other tasks. So the mix of safety and standard X80 modules is possible in the same M580 Safety PAC.

IEC 61131-3 compliant languages

FBD and LD are supported in SAFE task.

2 modes for operation and maintenance of SAFE task:

- safety mode: in operation conditions, the safe task is running and is locked for users.
- maintenance mode: dedicated for maintenance operation in safety part of the application.

Data editor

Process and safe data are managed in distinct M580 memory area. Unity Pro allows to easily manage:

- exchange of data between process and safe areas of the project in “Data Editor”
- process data in “Process Data Editor”
- safe data in “Safe Data Editor”

Safety function blocks

Unity Pro supports new M580 Safety offers with IEC61508 programming languages and rich library of safety Function blocks.

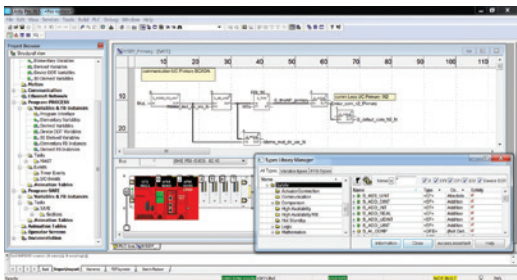

Safety function block

Data editor

The data editor provides a single tool for performing the following editing tasks:

- Declaration of data including variables and function blocks (declaration of their type, instances and attributes)
- Use and archiving of function block data types in different libraries
- Hierarchical view of data structures
- Searching, sorting and filtering of data
- Creation of a hyperlink to access a description from any variable comment

The data is displayed in four tabs:

- “Variables” tab for the creation and management of the following data instances: bits, words, double words, inputs/outputs, tables and structures
- “DDT Types” tab for the creation of derived data types (tables and structures)
- “Function Blocks” tab for the declaration of EFBs and DFBs
- “DFB Types” tab for the creation of DFB user function block data types

Each data element has several attributes, of which:

- Variable name and type are mandatory
- Comment, physical address in the memory and initial values are optional

The data editor columns can be configured (number of columns, order). The attributes associated with a variable can be displayed in a properties window.

This editor can be accessed at any time during programming by selecting variables for data modification or creation.

(1) Available from V13

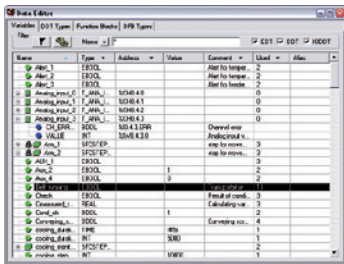

Data editor

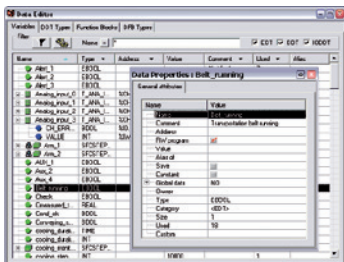

Data properties

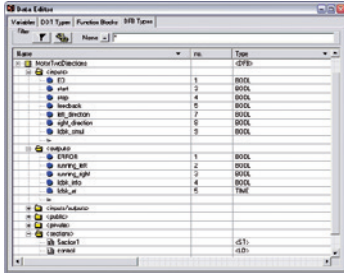

Design

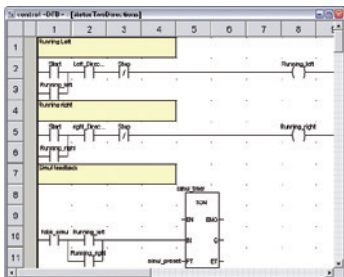

Creating the code

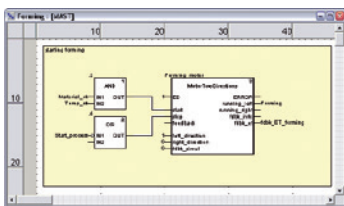

Use within the program

DFB user function blocks

With Unity Pro software, users can create their own function blocks for specific application requirements on Modicon M340, Modicon M580, Modicon M580 Safety, Modicon Momentum, Premium and Quantum platforms.

Once created and saved in the library, these user function blocks can be reused as easily as EFBs (Elementary Function Blocks).

The user function blocks can be used to structure an application. They are used when a program sequence is repeated several times in the application or for freezing a standard programming routine. They can be read-only or read/write. They can be exported to the other Unity Pro applications.

Using a DFB in one or more applications:

- simplifies program design and entry
- improves program readability and understanding
- facilitates program debugging (variables handled by the DFB are identified in the data editor)
- enables the use of private variables specific to the DFBs, which are independent of the application

A DFB is set up in several stages:

- The DFB is designed by assigning a name, a set of parameters (inputs, outputs, public and private internal variables) and a comment to it via the data editor.
- The code is created in one or more sections of the program, with the following languages selected according to requirements: Structured Text, Instruction List, Ladder or Function Block Diagram (ST, IL, LD or FBD).
- The DFB can be stored in a library with an associated version number.
- A DFB instance is created in the data editor or when the function is called in the program editor.
- This instance is used in the program in the same way as an EFB (the instance can be created from within the program).

1

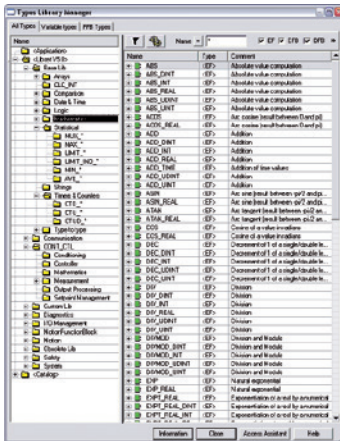

Standard function block libraries

Function block libraries

The function and function block libraries manager contains the elements provided with Unity Pro software. Functions and function blocks are organized into libraries, which themselves consist of families. Depending on the type of PAC selected and the processor model, users will have a subset of these libraries available to write their applications. However, the “Base Lib” library contains a set of functions and function blocks, for the majority of which compatibility is independent of the platforms. In particular, it contains the blocks compliant with IEC 61131-3. The “Base Lib” library is structured into families:

- Timers and counters
- Process control on integers
- Table management
- Comparison
- Date and time management
- Logic processing
- Mathematical processing
- Statistical processing
- Character string processing
- Type-to-type data conversion

The “Base Lib” library, which covers standard automation functions, is supplemented by other, more application-specific libraries and platform-specific functions:

- **Communication library**, providing an easy means of integrating communication programs from PACs with those used by HMI from the PAC application program. Like other function blocks, these EFBs can be used in any language to exchange data between PACs or to deliver data to be displayed on an HMI.
- **Process control library**. The CONT_CTL library can be used to set up process-specific control loops. It offers controller, derivative and integral control functions and additional algorithms, such as EFBs for calculating mean values, selecting a maximum value, detecting edges or assigning a hysteresis to process values, etc.
- **Diagnostics library**, which can be used to monitor actuators and contains EFBs for active diagnostics, reactive diagnostics, interlocking diagnostics, permanent process condition diagnostics, dynamic diagnostics, monitoring of signal groups, etc.
- **I/O management library**, providing services to handle information exchanged with hardware modules (formatting data, scaling, etc.).
- **Motion Function Blocks library**, containing a set of predefined functions and structures to manage motion controlled by drives and servo drives connected on CANopen.
- **Motion library** for motion control and fast counting.
- **System library**, which provides EFBs for the execution of system functions, including: evaluation of scan time, availability of several different system clocks, SFC section monitoring, display of system status, management of files on the memory cartridge of the Modicon M340 processor, M580 processor, etc.
- Finally, a library named “obsolete”, containing the function blocks used by legacy programming software needed to perform application conversions.

Management of user standards

Users can create libraries and families in order to store their own DFBs and DDTs. This enhancement allows users to take advantage of programming standards adapted to their needs, along with version management. This means that it is possible to:

- Check the version of the elements used in an application program against those stored in the library
- Perform an upgrade, if necessary

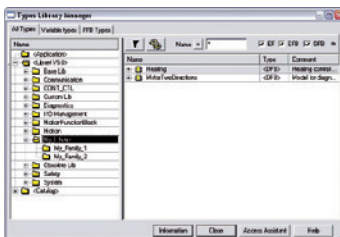

User libraries

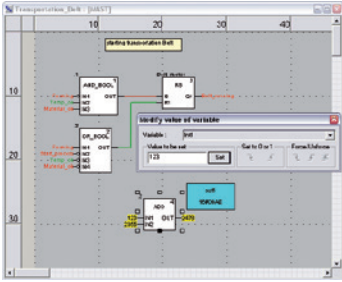

Debugging tools: Dynamic animation/adjustment

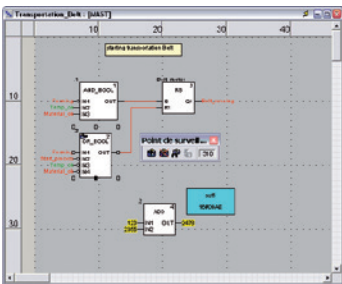

Debugging tools: Watchpoint

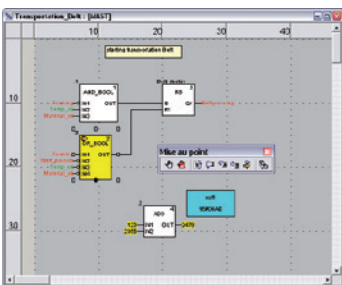

Debugging tools: Breakpoint/step-by-step

Debugging tools

Unity Pro software offers a complete set of tools for debugging Modicon M340, M580, M580S, Momentum, Premium or Quantum applications. A tool palette provides direct access to the main functions:

- Dynamic program animation.
- Setting of watchpoints or breakpoints (not authorized in event-triggered tasks).
- Step-by-step program execution. A function in this mode enables section-by-section execution. Instruction-by-instruction execution can be launched from the previous breakpoint. Three execution commands are therefore possible when the element to be processed is a subroutine (SR) or DFB user block instance:
 - Step Into: this command is used to move to the first element of the SR or DFB
 - Step Over: this command is used to execute the entire SR or DFB
 - Step Out: this command is used to move to the next instruction after the SR or DFB element
- Independent execution of the master (MAST), fast (FAST), auxiliary (AUX) and event-triggered (EVTi) tasks.

Animation of program elements

Dynamic animation is managed section-by-section. A button on the toolbar is used to activate or deactivate animation for each section.

When the PAC is in RUN, this mode can be used to view simultaneously:

- The animation of a program section, regardless of the language used.
- The variables window containing the application objects created automatically from the section viewed.

Animation table

Tables containing the variables of the application to be monitored or modified can be created by data entry or initialized automatically from the selected program section. The tables can be stored in the application and retrieved from there at a later date.

Unity Pro can be used to save, import and export Animation tables with predefined set values. As it allows population of set values along with current values and vice versa in the PAC, the Animation tables can be used as templates to make the application easier to tune.

Debugging DFB user function blocks

The parameters and public variables of these blocks are displayed and animated in real time using animation tables, with the possibility of modifying and forcing the required objects.

In exactly the same way as with other program elements, the watchpoint, breakpoint, step-by-step execution and program code diagnostics functions can be used to analyze the behavior of DFBs. Setting a breakpoint in a DFB user function block instance stops execution of the task containing this block.

Debugging in Sequential Function Chart (SFC) language

The various debugging tools are also available in SFC language. However, unlike other sections (IL, ST, LD or FBD), an SFC section executed step-by-step does not stop execution of the task but instead freezes the SFC chart. Several breakpoints can be declared simultaneously within a single SFC section.

1

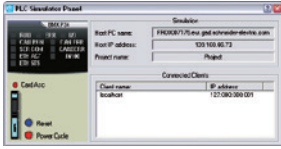

Simulator control panel

PLC simulator

Unity Pro's integrated simulator can be used to test the application program for Modicon M340, M580, M580S, Momentum, Premium or Quantum automation platforms from the PC terminal without having to connect to the processor. The functions provided by the debugging tools are available for debugging the master, fast and auxiliary tasks.

As the simulator does not manage the PLC I/O, animation tables can be used to simulate the state of inputs by forcing them to 0 or 1.

The simulator can be connected to third-party applications via an OPC server with OFS (OPC Factory Server) software.

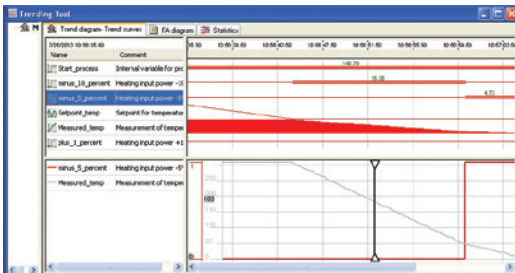

Trending tool control panel

Trending tool

The trending tool allows easy monitoring of variables by detecting operating problems or improving process performance. You can select any variable in your application and start acquisition, save records, and analyze records with integrated tools or Excel. The PAC mast scan can scan up to 16 variables.

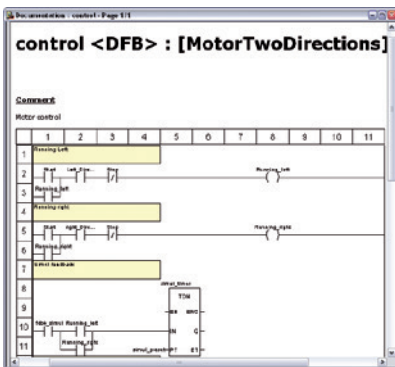

Accessing the documentation editor

Documentation editor

The documentation editor is based on the Documentation Browser, which shows the file structure in tree form.

It allows all or part of the application file to be printed on any graphics printer accessible under Windows and using True Type technology, in A4 or US letter print format.

The documentation editor supports the creation of user-specific files using the following headings:

- Title page
- Contents
- General information
- Footer
- Configuration
- EF, EFB and DFB type function blocks
- User variables
- Communication
- Project structure
- Program
- Animation tables and cross-references
- Runtime screens

System Time stamping

System Mode allows Time Stamping of I/O or internal variables for easy management via OFS and SCADA. Programming or use of any function block is not required as the configuration is easy to perform in Unity Pro Data Editor supported by OFS version 3.51.

Diagnostics integrated in Modicon M340, Modicon M580, Modicon M580 Safety, Premium and Quantum automation platforms

Presentation

System diagnostics

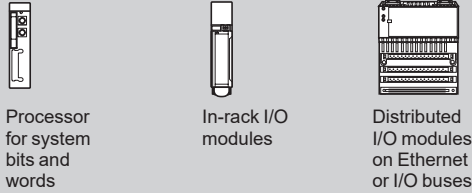

Application diagnostics

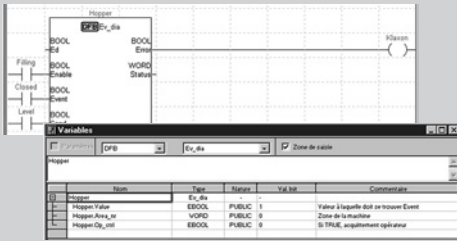

Diagnostics viewers

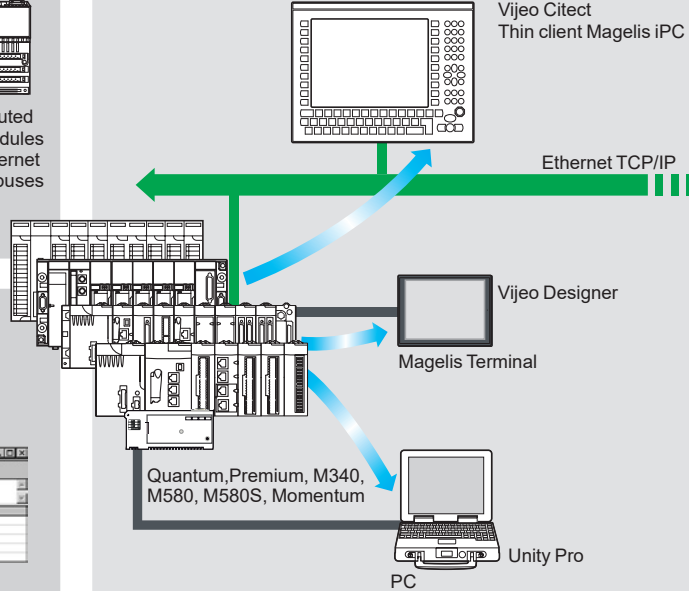

Higher-level M.E.S.

Cell level

Machine level

The diagnostics offer for Modicon M340, M580, M580S, Momentum, Premium and Quantum platforms is based on the following three components:

- System diagnostics
- DFB and EFB diagnostic function blocks (for system and application diagnostics)
- Error message display system, called viewers, supplied as a standard component of Magelis terminal, Vijeo Citect supervisory software and Unity Pro setup software

System diagnostics

The system diagnostics for the Modicon M340, M580, M580S, Momentum, Premium and Quantum platforms support the monitoring of system bits/words, I/O modules and activity times (minimum/maximum) of SFC steps. By simply choosing the relevant option during application configuration, any event will generate time-stamped messages logged in the diagnostic buffer of the PAC.

These events are displayed automatically in a diagnostics viewer (1) without requiring any additional programming.

With Unity Pro integrated diagnostics, this function can be used to perform first-level diagnostics of the elements in the configuration, up to and including each I/O module channel.

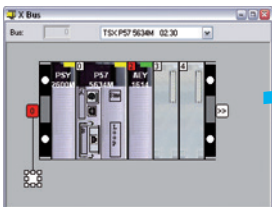

Configuration level

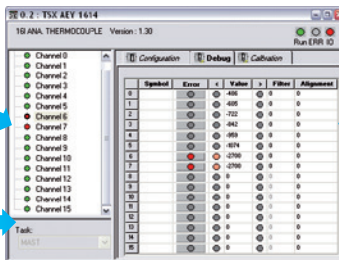

Module level

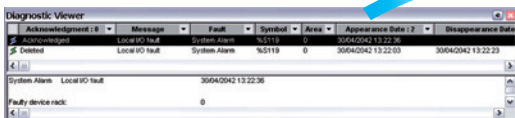

Viewer window (example with Unity Pro software)

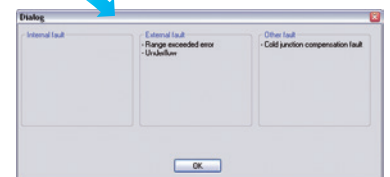

Channel level

(1) Diagnostics viewers are tools for displaying and acknowledging diagnostic error messages. They are supplied as a standard component of Unity Pro and Vijeo Designer software, with Magelis terminals and with the PLC Web server that can be accessed via a thin client Magelis iPC.

1

Modifying the program with the PAC in RUN mode

With Unity Pro, changes can be made to the program when the PAC connected to the programming terminal is in RUN mode. These modifications are performed with the following operations:

- The application contained in the PAC is transferred to the PC terminal running Unity Pro, if necessary.
- Program changes are prepared. These program modifications can be of any type and in any language (IL, ST, LD, FBD and SFC), for example, addition or deletion of SFC steps or actions. The code of a DFB user function block can also be modified (however, modification of its interface is not permitted).
- These program changes are updated in the PAC (in RUN mode).

This function makes it possible to add or modify program code and data in different parts of the application during a single modification session (thus resulting in a uniform, consistent modification with respect to the controlled process). This increased flexibility comes at a cost in terms of the amount of program memory required.

Cross-references function

Unity Pro's cross-references function, which is available in standalone mode (offline) and when connected to the PAC in Run (online), allows users to view the elements of a PAC application when searching for any type of variable. This view indicates where the declared variable is used, as well as how it is used (for writing, reading, etc.). This function also provides access to the Search/Replace function for variable names.

The variable search can be initialized from any editor (language, data, runtime screen, animation table, etc.).

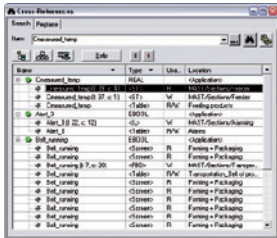

Cross-references table

Import/export function

The import/export function available in Unity Pro supports the following operations from the structural and functional project views:

- Via the import function, reuse of all or part of a previously created project in the current project.
- Via the export function, copying of all or part of the current project to a file for subsequent reuse.

The files generated during export are generally in XML format (1). However, in addition to XML, variables can be exported and imported in the following formats:

- .xvm format compatible with OFS data server software
- source format, in an .scy file compatible with PL7 development software
- text format with separator (TAB) in a .txt file for compatibility with any other system

During an import, a wizard can be used to reassign data to new instances of:

- DFB function blocks
- DDT data structures
- simple data

In addition, when a functional module is imported, the data associated with animation tables and runtime screens is also reassigned.

The XML import function also supports the transfer of a Modicon M340, Modicon M580, Modicon M580 Safety, Premium or Quantum PAC configuration prepared in the SIS Pro costing and configuration tool for use in the creation of a project in Unity Pro. This import function spares the user from having to redefine the PAC configuration when the PAC has already been configured with the SIS Pro tool.

Unity Pro includes an Excel import/export tool that makes it easy to manage the variables using an XML export file in Excel.

(1) XML language is an open, text-based language that provides structural and semantic information.

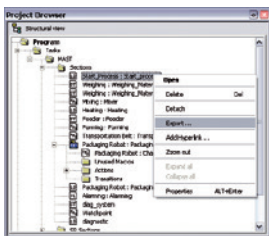

Data export shortcut menu

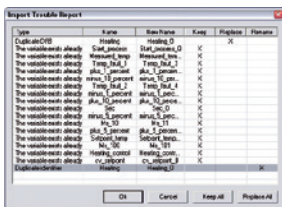

Data import wizard

Application converters

Unity Pro's integrated conversion tools can be used to convert applications created with ModSoft, ProWorX, Concept and PL7 programming software to Unity Pro applications.

Concept/Unity Pro converter (Quantum and Momentum PACs)

This conversion is performed with a Concept application V2.5 or later (it can also be performed in V2.11 or later, but only after an update to V2.5). In order to perform the conversion, the application should be exported to an ASCII file in Concept.

The export file is converted to a Unity Pro source file automatically. This file is then analyzed by Unity Pro. At the end of the procedure, a conversion report is generated and an output window displays any conversion detected error and provides direct access to the part of the program to be modified.

The Concept application converter converts the application to Unity Pro, but does not guarantee that it will operate correctly in real time. It is therefore essential to test or debug all converted applications.

PL7/Unity Pro converter (Premium PAC and Atrium slot PAC)

This conversion is performed with a PL7 application V4 or later (Premium PAC or Atrium slot PAC). In order to perform the conversion, the source file (complete application or user function block) should be exported to PL7.

The conversion procedure is similar to that of the Concept conversion described above.

Note: Applications created with Concept, Modsoft and ProWORX can be converted to LL984. Please contact our Customer Care Center

Unity M580 Application Converter (UMAC)

The conversion from Unity Quantum and Unity Premium applications to Unity M580 applications is performed with UMAC.

UMAC is a standalone software tool that can be installed on a Windows PC. The complete conversion process relies on the use of Unity Pro.

UMAC is available in 2 sizes: Lite and Standard. UMAC Lite is free and downloadable from our website www.schneider-electric.com. UMAC Lite allows to retain the existing configuration while UMAC Standard adapts the code to Modicon M580.



Unity M580 Application Converter tool

Operating system update utilities

The OS-Loader software is designed for updating operating systems on Premium and Quantum platforms. It is supplied with Unity Pro software.

It is used to upgrade Unity processors and modules as well as to upgrade PL7 or Concept processors and modules to make them compatible with Unity Pro.

OS-Loader software supports:

- Premium processors
- Quantum processors
- Ethernet communication modules
- EtherNet/IP communication modules

The operating system updates are performed as follows:

- Uni-Telway RS 485 terminal link for Premium processors
- Modbus or Modbus Plus terminal link for Quantum processors
- Ethernet TCP/IP network for integrated Ethernet port on Premium processors and Premium and Quantum Ethernet modules

Note: For Modicon M340, M580 and Momentum this service is provided by Unity Loader (see page 2/6).

Online modification of the configuration (CCOTF)

This function, also called *Change Configuration On The Fly (CCOTF)*, is used to modify the Modicon M580 or Modicon Quantum configuration online (application in RUN mode):

- Addition or removal of discrete or analog I/O modules
- Modification of configuration parameters of discrete or analog I/O modules (already present or newly installed)

On Quantum, the CCOTF function is supported by standalone processors for the three types of I/O architecture (local, RIO, DIO) using version 5 of Unity Pro, and for Hot Standby processors using version 4.1 or higher of Unity Pro.

The CCOTF function should first be validated in the Unity Pro configuration screen. A confirmation screen appears when the configuration has been modified online.

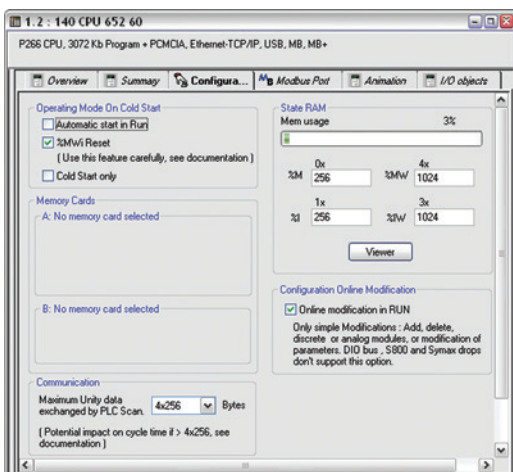

Configuration screen

1

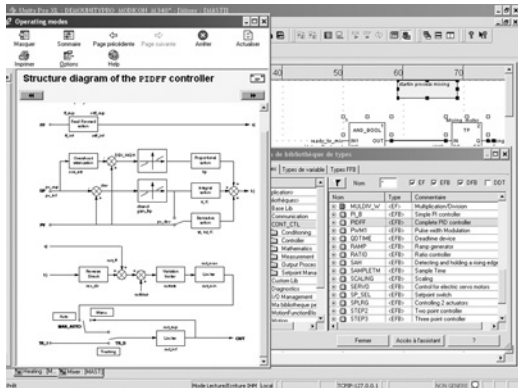

CONT_CTL, programmable process control integrated in Unity Pro

Process control in machines

Unity Pro contains **CONT_CTL**, a library of 36 function blocks used to create control loops for machine control.

The requirements for closed loop control functions in machines are adequately met by Modicon M340, Modicon M580, Modicon M580 Safety, Modicon Momentum, Premium and Quantum platforms thanks to the wealth of functions in the library and the flexibility with which function blocks can be linked together through programming. This solution therefore avoids the need for external controllers and simplifies the overall control architecture of the machine, as well as its design, roll-out and operation.

The EFs or EFBs can be used in any of the Unity Pro languages (LD, ST, IL and FBD). FBD is particularly suitable for accessing control processing operations in Unity Pro through its wizard for entering and viewing parameters and function block variables.

CONT_CTL library functions

The library consists of six function families:

- input data conditioning
- controllers
- mathematical functions
- process value processing
- output value processing
- setpoint management

Input data conditioning

DTIME	Pure time delay
INTEGRATOR	Integrator with limiting
LAG_FILTER	First order time lag
LDLG	Lead/lag function with smoothing
LEAD	Lead function with smoothing
MFLOW	Mass flow calculation based on the measurement of differential pressure or flow speed with pressure and temperature compensation
QDTIME	Dead time term
SCALING	Scaling
TOTALIZER	Integrator (typically of flow) until a limit (typically a volume) is reached, with automatic reset
VEL_LIM	Velocity limiter, with manipulated variable limiting

Controllers

PI_B	Basic PI controller: PI algorithm with a mixed structure (series/parallel)
PIDFF	Complete PID controller: PID algorithm with a parallel or mixed structure (series/parallel)
AUTOTUNE	Automatic tuner setting for the PIDFF (complete PID) controller or the PI_B (simple PI) controller <ul style="list-style-type: none"> □ Identification using Ziegler Nichols type method □ Modeling based on first-order process □ Building of control parameters with criterion for prioritizing either the reaction time to disturbance (dynamic) or the stability of the process
IMC	Model-based controller. The model is a first-order model with delay. This corrector is useful: <ul style="list-style-type: none"> □ When there are serious delays compared with the main time constant of the process; this scenario cannot be satisfactorily resolved by standard PID process control. □ For regulating a non-linear process IMC can handle any stable aperiodic process of any order.

SAMPLETM	Control of controller startup and sampling
STEP2	Simple two-position controller
STEP3	Three-position controller for temperature regulation

Mathematical functions

COMP_DB	Comparison of two values, with dead zone and hysteresis
K_SQRT	Square root, with weighting and threshold, useful for linearization of flow measurements
MULDIV_W	Weighted multiplication/division of 3 numerical values
SUM_W	Weighted summing of 3 numerical values

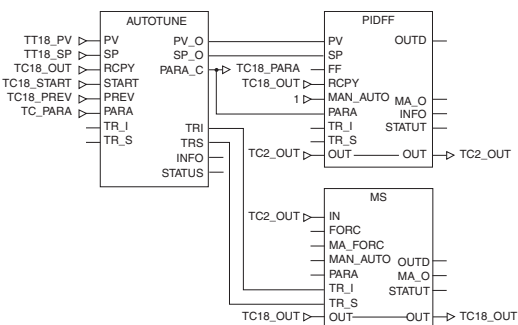

Example: PID controller with MS manual control

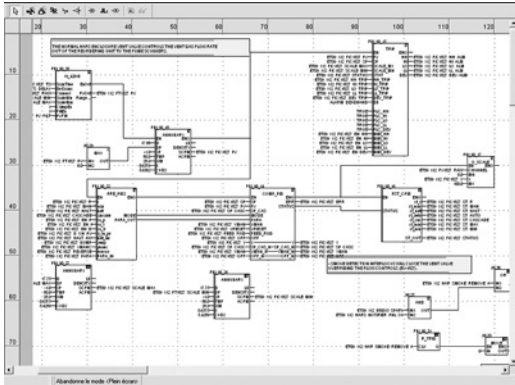

Programming in Unity Pro in offline mode

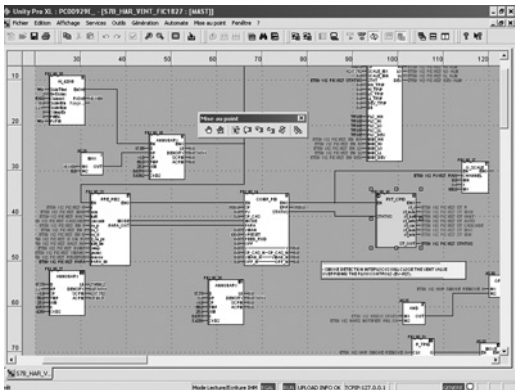

Programming in online mode

Process control in machines (continued)

CONT_CTL library functions (continued)

Process value processing

AVGMV	Moving average with fixed number of samples (50 max.)
AVGMV_K	Moving average with constant correction factor, 10,000 samples max.
DEAD_ZONE	Dead zone
LOOKUP_TABLE1	Linearization of characteristic curves using first-order interpolation
SAH	Detection of a rising edge
HYST_XXX	Detection of high threshold with hysteresis (1)
INDLIM_XXX	Detection of high and low thresholds with hysteresis (1)

Output value processing

MS	Manual control of an output
MS_DB	Manual control of an output with dead zone
PWM1	Control via pulse width modulation
SERVO	Control for servo motors
SPLRG	Control of two <i>Split Range</i> actuators

Setpoint management

RAMP	Ramp generator, with separate ascending and descending ramps
RATIO	Ratio controller
SP_SEL	Selection of setpoint value: local (operator) or <i>remote</i> (processing)

Setting up process control function blocks

Based on the sequencing of function blocks, the FBD language integrated in Unity Pro is a programming language particularly suitable for building control loops. Designers can use FBD to easily associate blocks from the CONT_CTL library with their own DFBs written in Unity Pro's ST, IL or LD language, or in C language.

Debugging, operation

All Unity Pro's standard debugging services (see page 1/11) are available. In particular, the PLC simulator can be used to check correct execution of processing offline.

Compatibility

The CONT_CTL control function block library is available in all versions of Unity Pro. It is compatible with processors in the Modicon M340, Modicon M580, Modicon M580 Safety, Modicon Momentum, Premium and Quantum ranges.

Optional specialized libraries

The CONT_CTL control function block library can be supplemented with optional specialized libraries, to meet specific needs such as predictive control, fuzzy logic controller, HVAC and mass flow calculation (see page 2/8).

Resources

The technical documentation provides many examples of how to set up programmable process control function blocks in FBD, LD, IL and ST languages.

The techniques for adjusting process control loops are described in the document "Process control, Unity V3.0" available online at www.schneider-electric.com.

(1) XXX according to the type of variable: DINT, INT, UINT, UDINT, REAL.

1

Communication drivers

The most commonly used communication drivers for Modicon M340, M580, M580S, Momentum, Premium and Quantum platforms are installed at the same time as the Unity Pro software.

Unity Pro also includes the following drivers, which can be installed as required (1):

Protocol - Hardware	Windows® 7 32-bit and 64-bit editions	Windows® 10 32-bit and 64-bit editions
Fip adaptor - CUSBFIP		
Modbus Serial - COM port		
PCIway - Atrium TPCI57 PCI card		
Uni-Telway - COM port		
USB for high end PLC		
XIP - XWay on TCP/IP		

Driver available Driver not available

Upgrade kits for Concept, PL7 Pro and ProWORX software

The Concept, PL7 Pro and ProWORX upgrade kits allow users who already have one of these programs from the installed base, and who have a current subscription, to obtain Unity Pro version V4.1 software at a reduced price.

These upgrades are only available for licenses of the same type (e.g. from Concept XL group license to Unity Pro Extra Large group license).

Composition and Windows® OS compatibility

Unity Pro multilingual software packages are compatible with Windows 7 Professional (32-bit and 64-bit), Windows 10 (32-bit and 64-bit) and Windows Server 2012 R2 operating systems. On 64-bit Windows 7, the installation of Service Pack 1 (SP1) is mandatory in order to use Unity Pro V13. A 64-bit Windows operating system with 4 GB RAM minimum is recommended for projects using DTMs.

Note: Unity Pro requires .NET Framework 3.5 and .NET Framework 4.5.2.

They include:

- Documentation in electronic format in six languages (English, French, German, Italian, Spanish and Chinese)
- Converters for converting applications created with Concept, PL7 and Unity M580 application converter (UMAC) programming software
- PLC simulator

Cables for connecting the processor to the programming PC need to be ordered separately.

(1) Also available separately under reference **TLXCDDR20M**.

Software

Unity Pro software

Small/Large/Extra Large/Extra Large Safety

Unity Pro update

Customers are notified automatically when a new Unity Pro update becomes available. They can then access the software update manager directly, download the update and install it locally on their workstation.

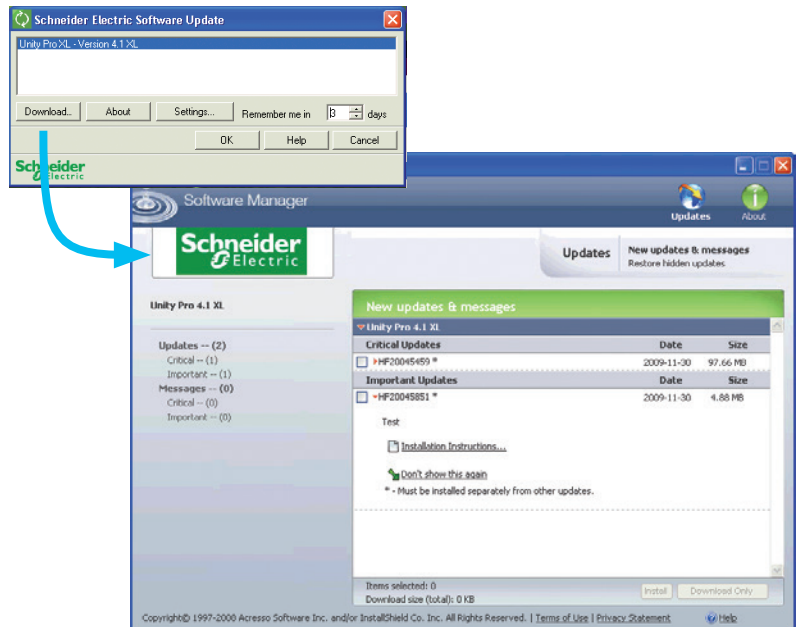

Note: The latest firmware versions can be downloaded from our website www.schneider-electric.com.



Unity Pro

Unity Pro version 13 software

Unity Pro software packages

These software packages are for programming and setting up Unity automation platforms. The software is available in three versions:

- **Unity Pro Small** (see page 1/21)
- **Unity Pro Large** (see page 1/22)
- **Unity Pro Extra Large** (see page 1/23)
- **Unity Pro Extra Large Safety** (see page 1/24)

Upgrade kits for Concept, PL7 Pro and ProWORX software

These upgrade kits allow users who already have these software programs from the installed base and who have a **current subscription** to obtain Unity Pro version V13 software at a reduced price. These upgrades are only available for licenses of the same type (e.g. from Concept XL group license to Unity Pro Extra Large group license). See page 1/23.

Subscription renewal of Unity Pro software packages

If the user renews the subscription support **before** the end of renewal date:

- The new subscription period starts automatically at the end of the previous one.
- New versions of the software are sent to the customer during the subscription period.

Expired subscription renewal of Unity Pro software packages (1)

If the user renews the subscription **after** the end of the renewal date:

- The latest version of the software is sent to the customer.
- The customer must register within three months for the new subscription period.
- The new subscription period starts at the time of registration.
- New versions of the software are sent to the customer during the subscription period.
- There is no subscription support during the time elapsed between the two periods.

Composition and Windows OS compatibility

Unity Pro multilingual software packages are compatible with Windows 7 (32-bit and 64-bit), Windows 10 (32-bit and 64-bit) and Windows Server 2012 R2 operating systems.

The packages comprise:

- A Unity Pro V13 DVD in six languages (English, French, German, Italian, Spanish and Chinese)
- An Advantys V11 minimum configuration software CD
- A one-year service subscription

(1) Automatic renewals for Unity Pro new versions are possible during the first year of subscription. Please contact our Customer Care Center for more information.

Software

Unity Pro software

Small

Unity Pro Small version 13 software

For Modicon M340: **All models**
 For Modicon Momentum: **171CBU78090/98090/98091**
 For distributed I/O: **Modicon ETB, TM7, OTB, STB, Momentum**

Unity Pro Small version 13 software packages (1) (2)

Description	License type	Reference	Weight kg/lb
Unity Pro Small software packages	Single (1 station)	UNYSPUSFUV1X	–
	Group (3 stations)	UNYSPUSFGV1X	–
	Team (10 stations)	UNYSPUSFTV1X	–
Software upgrades from: - Concept S - PL7 Micro - ProWORX NxT/32 Lite	Single (1 station)	UNYSPUSZUV1X	–
	Group (3 stations)	UNYSPUSZGV1X	–
	Team (10 stations)	UNYSPUSZTV1X	–

License type extensions for Unity Pro Small version 13

From	To	Reference	Weight kg/lb
Single (1 station)	Group (3 stations)	UNYSPUSZUGV1X	–
Group (3 stations)	Team (10 stations)	UNYSPUSZGTV1X	–

(1) For compatibility of Unity software/automation platforms and distributed I/O, refer to the selection guide on page 1/2.

(2) Automatic renewals for Unity Pro new versions are possible during the first year of subscription. Please contact our Customer Care Center for more information.

Software

Unity Pro software

Large

1



Unity Pro

Unity Pro Large version 13 software

For Modicon M340: **All models**
 For Modicon M580: **BMEH5820/BMEP5810/5820/5830**
 For Modicon Momentum: **171CBU78090/98090/98091**
 For Modicon Premium: **TSX571e...4e**
 For Modicon Quantum: **140CPU31110/43412U/53414U**
 For distributed I/O: **Modicon ETB, TM7, OTB, STB, Momentum**

Unity Pro Large version 13 software packages (1) (2)

Description	License type	Reference	Weight kg/lb
Unity Pro Large software packages	Single (1 station)	UNYSPULFUV1X	–
	Group (3 stations)	UNYSPULFGV1X	–
	Team (10 stations)	UNYSPULFTV1X	–
	Facility (≤ 100 stations)	UNYSPULFFV1X	–
Software upgrades from: - Concept S, M - PL7 Micro, Junior, Pro - ProWORX NxT/32 Lite	Single (1 station)	UNYSPULZUV1X	–
	Group (3 stations)	UNYSPULZGV1X	–
	Team (10 stations)	UNYSPULZTV1X	–
	Facility (≤ 100 stations)	UNYSPULZFV1X	–

License type extensions for Unity Pro Large version 13

From	To	Reference	Weight kg/lb
Single (1 station)	Group (3 stations)	UNYSPULZUGV1X	–
Group (3 stations)	Team (10 stations)	UNYSPULZGTV1X	–

Upgrade to Unity Pro Large from Unity Pro Small

Type of upgrade The number of stations is unchanged	Reference	Weight kg/lb
Small to Large Single (1 station)	UNYSPULZSUV1X	–
Small to Large Group (3 stations)	UNYSPULZSGV1X	–
Small to Large Team (10 stations)	UNYSPULZSTV1X	–

Upgrade to Unity Pro Large from Unity Pro Medium

Type of upgrade The number of stations is unchanged	Reference	Weight kg/lb
Small to Large Single (1 station)	UNYSPULZMUV1X	–
Small to Large Group (3 stations)	UNYSPULZMGV1X	–
Small to Large Team (10 stations)	UNYSPULZMTV1X	–

(1) For compatibility of Unity software/automation platforms and distributed I/O, refer to the selection guide on page 1/2.

(2) Automatic renewals for Unity Pro new versions are possible during the first year of subscription. Please contact our Customer Care Center for more information.

Software

Unity Pro software

Extra Large

Unity Pro Extra Large version 13 software

For Modicon M340: **All models**
 For Modicon M580: **All models**
 For Modicon Momentum: **171CBU78090/98090/98091**
 For Modicon Premium: **TSX571e...6e**
 For Modicon Quantum: **140CPU31110/43412U/53414U/65150/65160/65260/67160/67260/67261**
 For distributed I/O: **Modicon ETB, TM7, OTB, STB, Momentum**

Unity Pro Extra Large version 13 software packages (1) (2)

Description	License type	Reference	Weight kg/lb
Unity Pro Extra Large software packages	Single (1 station)	UNYSPUEFUV1X	–
	Group (3 stations)	UNYSPUEFGV1X	–
	Team (10 stations)	UNYSPUEFTV1X	–
	Facility (≤ 100 stations)	UNYSPUEFFV1X	–
Software upgrades from: - Concept S, XL - PL7 Micro, Junior, Pro - ProWORX NxT Lite, Full - ProWORX 32 Lite, Full	Single (1 station)	UNYSPUEZUV1X	–
	Group (3 stations)	UNYSPUEZGV1X	–
	Team (10 stations)	UNYSPUEZTV1X	–
	Facility (≤ 100 stations)	UNYSPUEZFV1X	–

License type extensions for Unity Pro Extra Large

From	To	Reference	Weight kg/lb
Single (1 station)	Group (3 stations)	UNYSPUEZUGV1X	–
Group (3 stations)	Team (10 stations)	UNYSPUEZGTV1X	–

Upgrade to Unity Pro Extra Large from Unity Pro Large

Type of upgrade	Reference	Weight kg/lb
The number of stations is unchanged		
Large to Pro Extra Large Single (1 station)	UNYSPUEZLUV1X	–
Large to Pro Extra Large Group (3 stations)	UNYSPUEZLGV1X	–
Large to Pro Extra Large Team (10 stations)	UNYSPUEZLTV1X	–

Unity Pro Extra Large Educational version 13 software packages (1) (2)

Description	License type	Reference	Weight kg/lb
Unity Pro Educational software package	Facility (≤ 100 stations)	UNYSPUEEFV1X	–

(1) For compatibility of Unity software/automation platforms and distributed I/O, refer to Unity Pro Extra Large in the selection guide on page 1/3.

(2) Automatic renewals for Unity Pro new versions are possible during the first year of subscription. Please contact our Customer Care Center for more information.

Software

Unity Pro software

Extra Large Safety

1



Unity Pro

Unity Pro Extra Large Safety software

For Modicon M340: **All models**
 For Modicon M580: **All models**
 For Modicon M580 Safety : **All models**
 For Modicon Momentum: **171CBU78090/98090/98091**
 For Modicon Premium: **TSX571e...6e**
 For Modicon Quantum: **140CPU31110/43412U/53414U/65150/65160/65260/67160/67260/67261**
 For distributed I/O: **Modicon ETB, TM7, OTB, STB, Momentum**

Unity Pro Extra Large safety software packages (1) (2)

Description	License type	Reference	Weight kg/lb
Unity Pro Extra Large software packages	Single (1 station)	UNYSPUXFUV1X	–
	Group (3 stations)	UNYSPUXFGV1X	–
	Team (10 stations)	UNYSPUXFTV1X	–
	Facility (≤ 100 stations)	UNYSPUXFFV1X	–

License type extensions for Unity Pro Extra Large Safety

From	To	Reference	Weight kg/lb
Single (1 station)	Group (3 stations)	UNYSPUXZUGV1X	–
Group (3 stations)	Team (10 stations)	UNYSPUXZGTV1X	–
Team (10 stations)	Facility (≤ 100 stations)	UNYSPUXZTFV1X	–

Upgrade to Unity Pro Extra Large Safety from Unity Pro Large

Type of upgrade	Reference	Weight kg/lb
The number of stations is unchanged		
Large to Pro Extra Large Safety Single (1 station)	UNYSPUXZEUV1X	–
Large to Pro Extra Large Safety Group (3 stations)	UNYSPUXZEGV1X	–
Large to Pro Extra Large Safety Team (10 stations)	UNYSPUXZETV1X	–
Large to Pro Extra Large Safety Facility (≤ 100 stations)	UNYSPUXZEFV1X	–

Unity Pro Extra Large Educational software packages (1) (2)

Description	License type	Reference	Weight kg/lb
Unity Pro Educational software package	Facility (≤ 100 stations)	UNYSPUXEFV1X	–

(1) For compatibility of Unity software/automation platforms and distributed I/O, refer to Unity Pro Extra Large in the selection guide on page 1/3.

(2) Automatic renewals for Unity Pro new versions are possible during the first year of subscription. Please contact our Customer Care Center for more information.



BMXXCAUSBH018



TSXPCX1031



TSXCUSB485



TCSWAAC13FB

Accessories for connecting to the PC programming terminal

Description	Use		Length m/ft	Reference	Weight kg/lb
	From processor port	To PC port			
PC terminal connection cables (PC to PAC) (1)	USB mini B port BMXP341000/200/2002 BMEP58	USB port	1.8/ 5.91	BMXXCAUSBH018	0.065/ 0.143
			4.5/ 14.8	BMXXCAUSBH045	0.110/ 0.243
	Mini-DIN port Premium TSX571	RS 232D (9-way SUB-D connector)	2.5/ 8.20	TSXPCX1031	0.170/ 0.375
		USB port (USB/ RS 485 converter)	0.4/ 1.31	TSXCUSB485 (2)	0.144/ 0.318
		USB port (mini-DIN/ RJ45 cordset)	2.5/ 8.20	TSXCRJMD25 (2)	0.150/ 0.331
	Modbus port 15-way SUB-D Quantum 140CPU31110 140CPU43412A 140CPU53414B	RS 232D (9-way SUB-D connector)	3.7/ 12.1 15/ 49.2	990NAA26320 990NAA26350	0.300/ 0.661 0.180/ 0.397
	USB port Premium TSX575 Quantum 140CPU6	USB port	3.3/ 10.8	UNYXCAUSB033	–
	Modbus port, RJ45 connector Quantum 140CPU6	RJ 45 connector	1/ 3.28	110XCA28201	–
			3/ 9.84	110XCA28202	–
			6/ 19.7	110XCA28203	–

PC terminal connection cables (PC SUB-D to Modicon STB I/O)	HE 13 connector Modicon STB I/O network interface module (NIM)	RS 232D (3) (9-way SUB-D connector)	2/ 6.56	STBXCA4002	0.210/ 0.463
USB/SUB-D adaptor (PC USB to Modicon STB I/O)	HE 13 connector Modicon STB I/O network interface module (NIM) with Modicon STB I/O	USB port (4)	–	SR2CBL06	0.185/ 0.408

Description	Use	Reference	Weight kg/lb
Universal Bluetooth® interface (UBI)	<p>Provides Bluetooth® connectivity for products such as the Modicon M340/Premium platforms and Altivar/Lexium servo drives, via their serial port (RS 485).</p> <p>Used for setup and maintenance of products. Designed for permanent installation and can be fitted on the inside or outside of electrical enclosures.</p> <ul style="list-style-type: none"> ■ Protocols supported: Modbus and Uni-Telway ■ Powered via the product's RS 485 serial port ■ Max. range in direct line of sight: 20 m/65.6 ft <p>The kit comprises:</p> <ul style="list-style-type: none"> ■ A Universal Bluetooth® interface (UBI) ■ An RJ45/mini-DIN cable (length 1 m/3.28 ft) ■ An RJ45/RJ45 cable (length 1 m/3.28 ft) ■ A fixing clamp for installation inside the electrical enclosure ■ A CD with configuration software and user manual 	TCSWAAC13FB	0.320/ 0.705

(1) The **490NTW00002** and **490NTW00002U** RJ45 ConneXium cables (2 m/6.56 ft) can be used to connect the PC to the SERVICE port of M580 CPUs or X80 drop. Please consult our website www.schneider-electric.com.

(2) The **TSXCUSB485** converter requires use of the **TSXCRJMD25** mini-DIN/RJ45 cordset.

(3) Use the **SR2CBL06** cable for connection on a USB port (4).

(4) Adapter equipped with a USB connector (PC side) and a 9-way SUB-D connector (STBXCA4002 cable side); requires the **STBXCA4002** cable (9-way SUB-D/HE 13) for connection to the HE 13 connector on the Modicon STB NIM.

Unity EFB Toolkit software

- Presentation, setup page 2/2
- References page 2/3

Unity DIF software

- Presentation, setup page 2/4
- References page 2/5

Unity Loader software

- Presentation..... page 2/6
- References page 2/7

Unity Specific libraries

- Presentation..... page 2/8
- References page 2/9





Unity EFB Toolkit

Presentation

Unity EFB Toolkit software helps to develop EFs and EFBs in “C” programming language. As an option with Unity Pro, it can be used to extend the standard Unity Pro function blocks in order to increase functionality. This software comes with *Microsoft Visual Studio*, which can be used to debug the function blocks developed in the Unity Pro PLC simulator. Unity EFB Toolkit also includes a service for creating and managing families of function blocks and integrating them in Unity Pro.

Setup

Unity EFB Toolkit manages the whole process of developing Unity Pro function blocks:

- User-friendly graphical user interface with automatic file organization
- Powerful tools for testing and debugging
- Management of compatibilities and software versions of created functions
- Generation of executable files for subsequent installation of functions on different Unity Pro stations

Managing function block families

EFB Toolkit helps to create and manage function block families. The function blocks developed, also known as EF/EFBs, are stored in families. It makes it possible to create an organized library of functions written in “C” language. Once created, these function block families are installed on the Unity Pro stations for the purpose of extending the standard Unity Pro libraries. Integration in Unity Pro can be executed from Unity EFB Toolkit or via the tool for updating Unity Pro libraries, which allows these families to be distributed without the use of any other software.

Developing function blocks

The EFB Toolkit software allows the user to create a function block as follows:

- Declaration of the function block interface in the same way as for the DFBs in Unity Pro
- Definition of all data types needed (elementary, structures, tables)
- Support of public and private variables
- Generation of all files and the block “C” coding frame (the user only adds functionality to this frame)
- Granting access to numerous internal PAC services, such as the real-time clock, PAC variables and data, system words and math functions, including high-precision numerical processing in “double” format
- Structure of the function block family (compilation/link for all Unity Pro automation platforms)
- Provision of a debugging environment: the function blocks created can easily be debugged in *Microsoft Visual Studio* by downloading a Unity Pro application containing the function developed in the Unity Pro PLC simulator. The debugging functions in *Microsoft Visual Studio*, especially breakpoints, step-by-step operations, display of the code/data and manipulation of the data, can be accessed without restriction.
- Support for managing Unity Pro versions, important during the function block maintenance phase

Compatibility

Unity EFB Toolkit is compatible with Unity Pro Medium, Large and Extra Large. EFs and EFBs can be developed for Modicon Premium, Quantum, M340, M580 and Unity Momentum platforms.

The latest available EFB Toolkit version is V8.0:

- OS compatibility Windows® 7 (32-bit and 64-bit), Windows® 8.1 (32-bit and 64-bit) and Windows® Server 2008 (64-bit).
- Minimum supported version of Unity Pro is V6.0 and above if installation is on the same system.
- The generated libraries can be installed on lower Unity Pro versions on different systems.

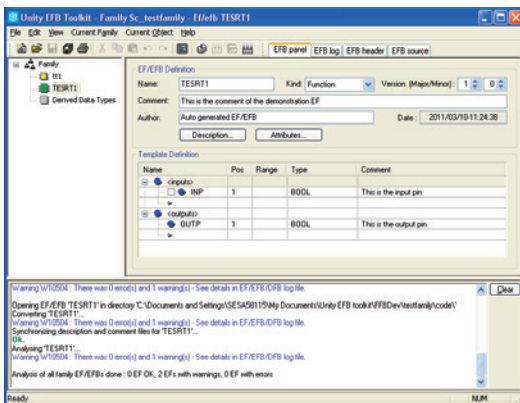

EFB Toolkit: Managing function block families

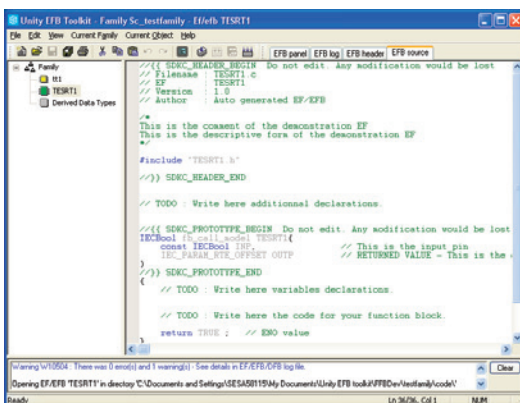

EFB Toolkit: Editor

Software

Unity Pro software
Unity EFB Toolkit software

References

Unity EFB Toolkit and its documentation are supplied in electronic format on DVD-ROM in English.

EFB Toolkit package includes:

- Unity EFB Toolkit DVD
- GNU Compiler CD
- Microsoft Visual Studio DVD

Description	Type	Language	Reference	Weight kg/lb
Unity EFB Toolkit software	Single license (1 station)	English (software and electronic documentation)	UNYSPUZFUCD80	–



Unity DIF

Presentation

Unity DIF software helps to compare two Unity Pro application files and represents differences in a graphical format similar to Unity Pro graphics for consistency and better understanding. The differences are displayed graphically and textually based on the type of section chosen. Unity DIF improves productivity during the main life stages of a control system, mainly during development and debugging of applications and commissioning, operation and maintenance of the installation.

Setup

Unity DIF compares two Unity Pro application files (XEF, ZEF, STU and STA) and detects anything ADDED, DELETED and MODIFIED. The user interface and graphical representation of differences are similar to Unity Pro for consistency and ease of understanding the differences.

Unity DIF can be launched in several ways:

- From Unity Pro
- From the Windows Start menu
- From a command line interface

Unity DIF can provide differences for the following sections:

- PAC Configuration (Hardware and Network)
- Derived Data Types
- Derived FB Types
- Variables and FB Instance
- Motion
- Communication
- Programs
- Animation Table
- Operator Screen
- DTM Catalog
- Project Settings

The result of the comparison can be printed or saved in .pdf and .txt file formats.

Windows® OS Compatibility

Unity DIF is compatible with Windows 7 (32-bit and 64-bit), Windows 10 (32-bit and 64-bit) and Windows Server 2008 R2 (64-bit).

Comparison (1)

The base and compare files have to be selected by the user, and the results of the comparison will be displayed with respect to the base file as reference.

Before initiating comparison, the user can select his preference of required section for comparison.

Displaying results

Upon comparison, the section summary will be loaded with the complete list of differences. The user can navigate through the project browser window or using the F7 and F8 keys.

The differences will be highlighted in three different colors signifying Added, Deleted or Modified types. Colors can be customized as per the user's preference. The detailed report can be generated through Print or can be Saved for later reference.

Unity DIF also supports command line processing and .txt report generation for interfacing with Partner software.

(1) Comparison of STU and STA requires Unity Pro to be available.

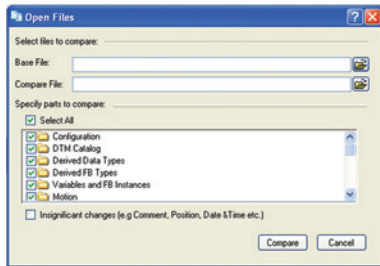

Selection of elements to compare

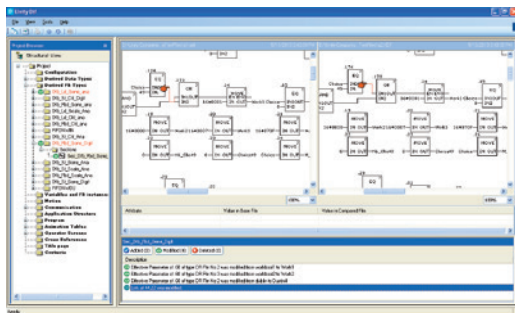

Displaying results

Software

Unity Pro software
Unity DIF software

References

Unity DIF software is free and downloadable from our website:
www.schneider-electric.com.

Compatibility: Unity Pro V2.1 or later.

Description	Language	Type	Reference	Weight kg/lb
Unity DIF software	English (software and electronic documentation)	Single license (1 station)	UNYDFFXZZSPA80 (1)	–

(1) Available on our website www.schneider-electric.com.



Unity Loader

Presentation

Unity Loader is companion software to Unity Pro and is used to perform maintenance operations on automation applications. Its easy setup and the small size of its executable make it a vital tool for updating Unity Pro projects without needing to use Unity Pro. It can also be used for updating the embedded software on Modicon M340, M580, M580S or Momentum Unity PACs or on Modicon X80 I/O modules. It performs the following main functions:

- Transferring automation project components, such as the program and data, from the PC to the PAC or the PAC to the PC
- Transferring files and user Web pages stored in the memory card of Modicon M340 PACs
- Transferring the firmware from the PC to Modicon M340, M580, M580S or Momentum Unity PACs or to Modicon X80 I/O modules

Software graphic interface

The interface is easy to use and has four tabs for access to different operations:

- The “**Project**” tab manages the transfer of projects (program and data) between the PC and the PAC CPU. The software transfers the program (application file format: .stu; archive file format: .sta) and data (located and unlocated; data file format: .dat) of a Unity Pro project in both directions. The program and data files created by Unity Loader are compatible with Unity Pro. When it is connected to the PAC, Unity Loader displays the information associated with the data read in the PAC. This information is displayed on the PC for the selected files. The user decides which project elements will be transferred by a single command after validation of the required transfers.
 - *Modicon M340 PACs and BMXRMS●●8MFP memory card only:* the files and user Web pages can be transferred from the memory card to the PC and vice versa.
 - *BMXNOE0110 with flash memory card only:* Web pages stored in the flash memory can be transferred from the module to the PC and vice versa.
- The “**Firmware**” tab can be used to update the firmware in the Modicon M340, M580, M580S or Momentum Unity PACs or on Modicon X80 I/O modules. The screen displays the detailed content of the firmware versions existing in the module and on the PC. Firmware updating works in the same way as project transfers.
- The “**Options**” tabs is used to configure the working environment, especially the location of files on the PC and the selection of one of the six languages supported (English, French, German, Italian, Spanish and Chinese) for the user interface and online help.
- The “**About...**” tab displays information about the software.

Note: Regardless of which tab is selected, the connection status with the PAC is continuously displayed, together with commands for connection/disconnection and changing the PAC operating mode.

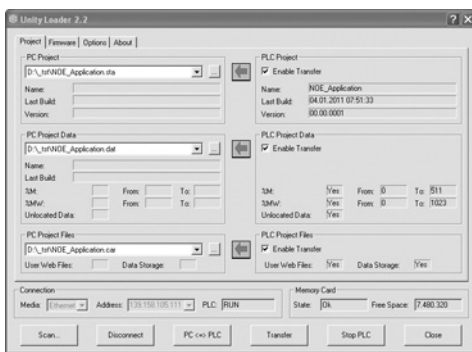

Unity Loader: Project tab

Modicon M340 PAC and BMXRMS●●8MFP memory card only

The Unity Loader software can download the project files and the firmware (controller or module) onto a flash memory card (**BMXRMS●●8MFP** only) plugged into the PAC CPU.

This firmware download can then be used to update a remote Modicon M340 PAC.

Automation of Unity Loader commands

Projects can be downloaded/uploaded between a PAC and a supervisory station equipped with Unity Loader software by means of a command file included in the supervisory application.

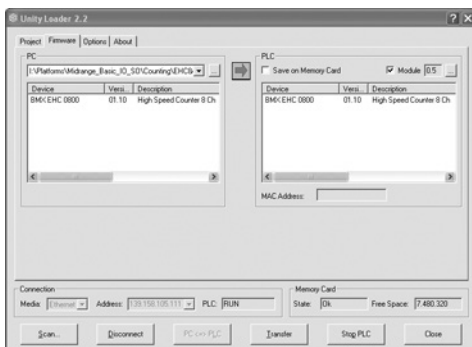

Unity Loader: Firmware tab



Unity Loader

Communication between the PC and the PAC

Unity Loader supports the following PC-to-PAC communication:

- Modicon Quantum Unity Pro PACs: Modbus communication, transfer of project components only
- Modicon Premium Unity Pro PACs: Unitelway communication, transfer of project components only
- Modicon M340, M580 or Momentum Unity PACs or Modicon X80 I/O modules: communication via Ethernet and USB ports, transfer of project components and firmware. See the table below:

Reference	Type of module	Ethernet port	USB port
BMXP342000	M340 CPU with Modbus	Supported	Supported
BMXP342010/20103	M340 CPU with CANopen	Supported	Supported
BMXP342020	M340 CPU with integrated Ethernet port	Supported	Supported
BMXP342030/20302	M340 CPU with integrated Ethernet port	Supported	Supported
BMXNOE0100/0110	X80 module Ethernet Modbus/TCP	Supported	Supported
BMXAMI/ART/AMO/AMM	X80 module Analog I/O	Supported if CPU has integrated Ethernet port	Supported
BMXEHC0200/0800	X80 module Counter	Supported if CPU has integrated Ethernet port	Supported
BMXMSP0200	X80 module Motion control	Supported if CPU has integrated Ethernet port	Supported
BMEP58 10XX/20XX/30XX/40XX	M580 CPUs	Supported	Supported
BMENOC03•1	M580 communication module	Supported	Supported
171CBU78090	Momentum Unity CPU with integrated port	Supported	Supported
171CBU98090/ 171CBU98091	Momentum Unity CPU with integrated port	Supported	Supported

Supported Supported if CPU has integrated Ethernet port

For Ethernet networks, Unity Loader contains a network scanner which can be used to scan a range of network addresses. Once a recognized Modicon M340, M580 or Momentum Unity PAC has been selected, data transfer operations can be performed.

References

Unity Loader is supplied with Unity Pro Small, Large and Extra Large. It can also be downloaded free of charge from our website www.schneider-electric.com, download section.

Compatibility

Unity Loader is independent of Unity Pro and compatible with Modicon M340, M580 or Momentum Unity PACs, Unity Pro Quantum PACs via Modbus and Unity Pro Premium PAC via Unitelway. The program files and PAC data files are compatible between Unity Pro and Unity Loader.

Description	Type	Reference	Weight kg/lb
Unity Loader software	Single license (1 station)	Software can be downloaded free of charge from our website www.schneider-electric.com	–



Unity specific Libraries

2

Presentation

The CONT_CTL process control function block library supplied with Unity Pro software can be supplemented with optional specialized libraries so as to meet specific needs such as:

- Predictive control
- Fuzzy logic controller
- HVAC
- Mass flow calculation

Fuzzy Control Library

This library is used in particular in the water treatment field, for example for controlling chlorine levels in fresh water pools or controlling water levels in high-level reservoirs.

Flow Calculation Library

This library is used in the vertical Oil & Gas field, for measuring the gas flow in compliance with the *American Gas Association (AGA)* standard. This version of the library includes the AGA3, AGA7 and AGA8 function blocks.

TeSys Library

This library provides function blocks for TeSys T and TeSys U starter-controllers for M340 and Premium platforms. It includes function blocks and a help function for Unity Pro.

PCR Library for Unity Pro and Concept

This library is used for predictive control of process applications. Originally developed for reactors, predictive control can be used in other industrial sectors. Schneider Electric's *Companion Unity & Libraries* team works in partnership with the French company *Sherpa Engineering*, who specialize in predictive control consultancy services.

Heating Ventilation & Air Conditioning Library

This library is used in the HVAC field and deals with repetitive temperature control and humidity problems using ventilation equipment.

System Library for Unity Pro

This library offers functional blocks that are derived from Devices and Process Library but only has Unity Pro components (DFBs). The Devices and Process Library supports several Schneider Electric devices including TeSys T and TeSys U starters-controllers, Modicon STB distributed inputs/ outputs, power meters, Altivar variable speed drives, Icla and Lexium integrated drives, SEPAM digital protection relays, various fieldbus communications and other standard objects for motors. There are approximately 100 objects in the library.



Unity specific Libraries

Specific libraries depending on the software used

Specific libraries depending on the software used (see below) can be ordered separately.

Control libraries

Description	Target software	Type	Reference	Weight kg/lb
PCR Library	Unity Pro and Concept	Single license (1 station)	UNYLPCZAUWB	–
Fuzzy Control Library	Unity Pro	Single license (1 station)	UNYLFZZAUWB12	–
TeSys Library			UNYLTSSZAUWB10	–
Heating Ventilation & Air Conditioning Library			UNYLHVZAUWB10	–
Flow Calculation Library			UNYLAGZAUWB20	–
GPL (General Purpose Library) Version 2017		(1)	(1)	–

System libraries for Unity Pro

Description	Target software	Type	Reference	Weight kg/lb
Enhanced Process Library (2)	UAG	Single license (1 station)	UAGSBTCFUCD10	–
Devices and Process Library (2)			UAGSBTDFUWB13	–

(1) PSx GPL Library is available for free.

(2) Compatible with Unity Pro V5.0 max. For Unity Pro ≥ V6.0, please consult our Customer Care Center.

3 - OPC data server software, Product reference index

OPC data server software

- Presentation page 3/2
- Architectures page 3/3
- Setup page 3/5
- Functions page 3/6
- References page 3/7
- Time stamping system page 3/8
- Presentation page 3/8
- Architectures page 3/8
- Performance page 3/9

Product reference index

- Product reference index page 3/10





OPC Factory Server

3



Presentation

Based on the OLE for Process Control (OPC) standard, Schneider Electric's OPC Factory Server (OFS) software allows "client" software applications, such as supervisors/SCADA and customized interfaces, to access the data of Schneider Electric automation system and electrical distribution devices connected to networks or fieldbuses in real time.

It also allows communication with third-party devices supporting Modbus and Modbus/TCP protocols.

OFS enables simpler, more open and transparent communication between your software applications and your devices. These are just some of the advantages that result in a complete interoperability solution that is central to your process.

In version V3.6, the OFS provides the following additional features:

- **OPC DA** (OPC Data Access)
- **.NET API interface**
- Native support for a redundant link with the PAC
- Access to time-stamped variables in the PAC or X80 drops
- V3.6 is compatible with Wonderware WSP environment (OPC DA compatible only). More details are available on the Wonderware Global Customer Support site

There are two versions of the OFS V3.6 offer supporting the OPC DA protocol:

- **OFS Small:** Data server for 1,000 items (1).
- **OFS Large:** Data server with an unlimited number of items (1).

Devices and protocols supported

OFS software is a multi-device data server: it allows simultaneous use of several communication protocols, and it provides client applications with a set of services for accessing control system items that may be local or remote, via physical address or via symbol.

Devices supported:

- Modicon Quantum, Premium, M340, M580, Micro, Compact and Momentum PACs
- Schneider Electric TSX Series 7 and April Series 1000 PACs
- Modbus serial devices connected via Schneider Electric gateways: TSXETG10●●, EGX●●● ranges, etc.
- Uni-Telway serial devices connected via Schneider Electric gateways (TSXETG1010)

Networks and protocols supported:

- Modbus: Modbus serial, Modbus Plus, Modbus/TCP
- X-Way/Uni-TE: Uni-Telway, Fipway, ISAWay, PClway

Redundant link on Modbus/TCP

The OFS V3.6 incorporates native support for a redundant link with the PAC in order to optimize system availability without any impact on the SCADA application. OFS automatically changes over from the primary to the standby communication path in case of a communication fault.

Openness

The development of specialized interfaces is simpler with OFS V3.6 software, which is aimed at two types of user in particular:

■ **End users** who want either to interface their supervision or human/machine interface applications with Schneider Electric equipment, or to develop applications on a PC (supervisory control screens, Excel spreadsheets etc.) requiring access to control system data.

■ **Suppliers of control system or industrial data processing software** (supervision, human/machine interfaces, etc.) seeking to develop, within their standard products, an OPC Client interface capable of accessing data in Schneider Electric equipment via the OFS server.

(1) "item": variable, structure, table etc. in the Unity Pro application.



OPC Factory Server: Home page

Supported architectures

The OFS server allows four access modes:

- A purely local mode
- Remote access from an OPC DA client
- Remote access from an OPC.NET client

Local access

The client application and the OFS server are on the same PC.

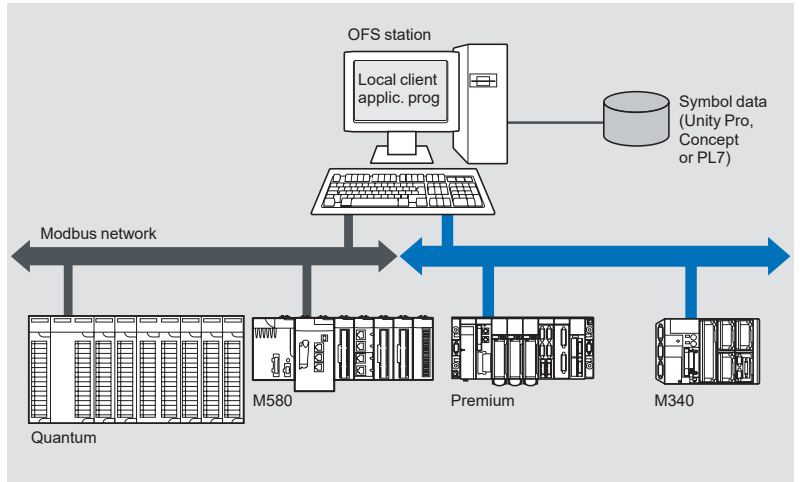

Remote access from an OPC DA client

The client application and the OFS data server are on remote stations.

Communication between the client station and the OFS server is conducted through the DCOM layer (Microsoft) via the OPC DA protocol.

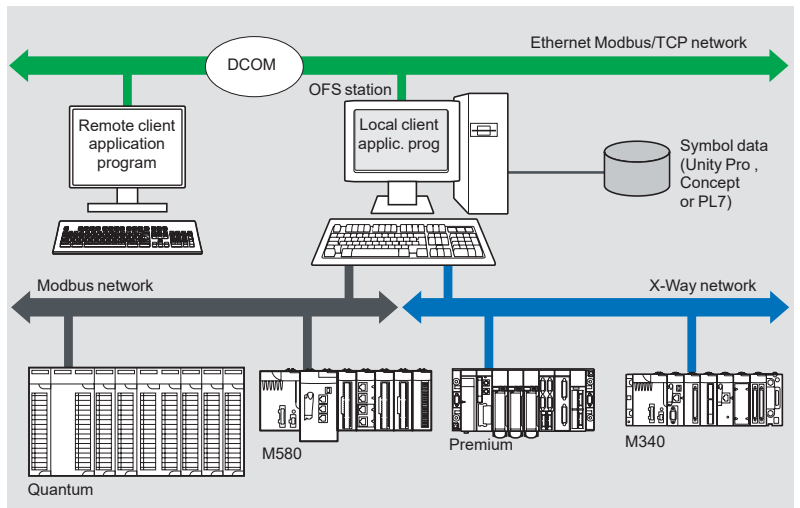

Architectures supported (continued)

Remote access from an OPC .NET client

The .NET client application program and the OFS data server are on remote stations. Communication between the client station and the OFS server is conducted through the DCOM layer (Microsoft) via the OPC DA protocol.

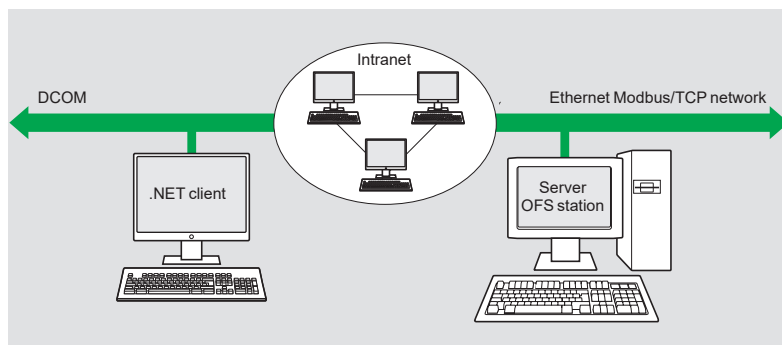

The .NET Microsoft compatibility of the OFS server has been developed to allow an OPC .NET client to access OFS server items on an Intranet network via the OPC .NET API interface.

This interface provides interoperability between existing OPC applications and applications developed in the standard .NET environment.

Setup

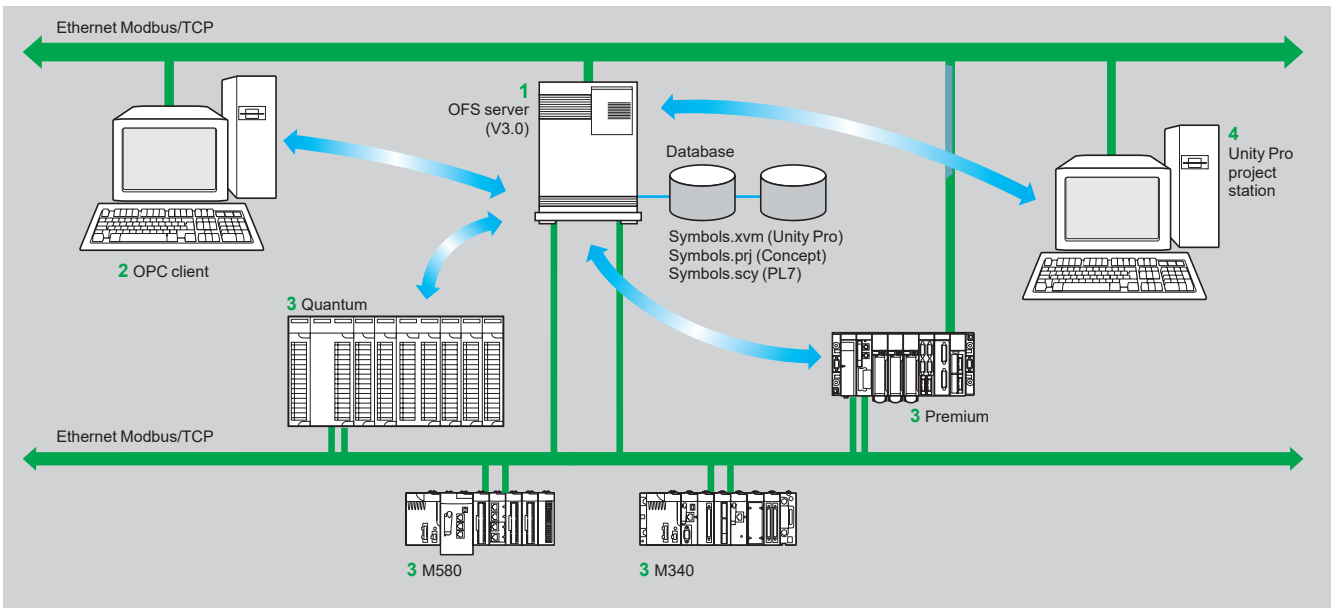

The OFS server **1** is at the center of the data exchanges. It makes variables exchanged between the OPC client **2** and the PAC **3** consistent in one of three ways, using a symbol (or variables) database:

- The variables database is either the Unity Pro project **4**, or the Concept project. In both these cases, Unity Pro or Concept needs to be installed on the OFS server station.
- Or the variables database is an export file (SCY for PL7, XVM for Unity Pro). PL7 and Unity Pro are not required in either of these cases.
- Or the variables database is the PAC itself. In this case neither Unity Pro nor an export file is needed. This does not apply to Momentum and TSX Micro PACs. If an inconsistency is detected (following online modification of the PAC program for example), OFS resynchronizes itself automatically as a background task, without breaking communication between the PAC and the OPC client. For this function the following minimum versions are required:
 - OFS V3.35
 - Unity Pro V6.0
 - Modicon M340 V2.3, M580 V1.0, Premium V2.9 and Quantum V3.0 PACs

Function

Development of client applications

OFS software has 4 types of interface:

■ **OLE Automation interface (OPC DA)**

Particularly suitable for end users, this enables the development of OPC client applications in Visual Basic, in Visual Basic for Excel, and in C++.

■ **OLE Custom interface (OPC DA)**

Used primarily by suppliers of automated control system or industrial IT products, this interface enables the development of applications in C++ in order to access the OFS software OPC server. It is aimed at software development experts in particular, so that they can integrate the client application into their standard products. It is the interface with the highest performance, in terms of access time to data stored in the OPC server. It requires extensive knowledge of C++ programming to set up.

■ **OPC .NET API wrapper interface**

The .NET Microsoft compatibility of the OFS data server gives an OPC .NET client standard access to OFS server items via an Intranet network, thus providing greater interoperability with standard .NET environments.

Note: In this case, communication between the OPC .NET client and the OFS server is conducted through the DCOM layer (or COM layer in a local configuration) via the OPC DA protocol.



OPC Factory Server

References

OFS V3.6 software for PC compatible stations (minimum configuration: Pentium 566 MHz processor, 128 MB of RAM) running Windows® 7 (32-bit or 64-bit) or Windows 8 (32-bit or 64-bit).

The OFS V3.6 offer comprises:

- OPC server software
- OPC server simulator (for debugging the application when no PACs are present)
- OFS server configuration software
- An example of OPC client for setting up applications
- The setup documentation on DVD-ROM
- A reference document on “time stamping system” solutions
- A tool to help with sizing and configuring “time stamping system” solutions

Supplied on DVD-ROM, the software operates independently on a PC. It interfaces with the variable export files generated by PL7, ProWORX, Concept, and Unity Pro software.

It also provides a direct dynamic link to the Unity Pro and Concept applications.

OFS V3.6 software is available in two versions :

■ **Small Version TLXCDS●OFS36**

- Maximum of 1,000 items (1)
- Protocol supported: OPC DA
- Single station and 10-station site licenses

■ **Large Version TLXCDL●OFS36**

- Unlimited number of items (1)
- Protocol supported: OPC DA
- Single station, 10-station and 200-station site licenses

OPC Factory Server V3.6 Small

Description	License type	Reference	Weight kg/lb
OPC Factory Server V3.6 Small software ■ Maximum of 1000 items (1) ■ Protocols supported: OPC DA and OPC UA	Single station	TLXCDSUOFS36	–
	10 stations	TLXCDSTOFS36	–

OPC Factory Server V3.6 Large

Description	License type	Reference	Weight kg/lb
OPC Factory Server V3.6 Large software ■ Unlimited number of items (1) ■ Protocols supported: OPC DA, OPC XML-DA and OPC UA	Single station	TLXCDLUOFS36	–
	10 stations	TLXCDLTOFS36	–
	200 stations	TLXCDFOFS36	–

OPC Factory Server V3.6 upgrades

Description	Reference	Weight kg/lb
Update for OPC Factory Server V3.6 Small	TLXCDUPDSOFS	–
Update for OPC Factory Server V3.6 Large	TLXCDUPDLOFS	–

(1) “item”: variable, structure, table etc. in the Unity Pro application.

Presentation

The time stamping system is a complete solution providing a SCADA with a sequence of events that are time-stamped at source, enabling the user to analyze the source of any abnormal behavior in an automated system.

The SOE (sequence of events) is displayed in the alarm log or in the list of events for a client such as a SCADA.

Each event in the SOE is a change of value (transition) of a discrete I/O detected by a time stamping module.

Advantages

Using the time stamping system has the following advantages:

- No PAC programming
- Direct communication between the time stamping modules and the client. If the time stamping modules are in an Ethernet I/O drop, the bandwidth of the PAC communication is not used
- Consistency of the I/O values between the process (time stamping modules) and the client
- Consistency is maintained irrespective of the operating mode
- No loss of events under normal operating conditions
- Management of Hot Standby configurations on the PAC and/or SCADA redundancy

Composition of a time stamping architecture

BMXCRA31210 and BMECRA31210 modules

This time stamping module can be at the source of any discrete I/O signal located in the drop with a resolution of 10 ms.

To avoid losing any events, all events are stored and kept in a buffer located in the product until OFS takes them.

Synchronization of the CRA module uses the NTP protocol.

BMXERT1604T module

This module has 16 discrete inputs which carry out the time stamping on source outputs with a resolution of 1 ms.

To avoid losing any events, the events are stored and kept in a buffer located in the product until OFS takes them.

This module can be placed either in an RIO drop, or in a local rack equipped with a BM●CRA31210 module.

The CRA module is synchronized via the DCF 77 or IRIG-B standards.

OFS V3.6

OFS V3.6 is used to access events stored in the various buffers in the architecture and to notify the SCADA of them via the standard OPC DA protocol.

Time stamped variables can be provided by the BMXERT1604T, discrete modules plugged into X80 drops, or even by the CPU since Unity V10.

Vijeo Citect V7.3

Vijeo Citect V7.3 receives events transmitted by OFS and displays them in the SOE or in the list of alarms.

Wonderware WSP

A specific OFS V3.6 version dedicated to the Wonderware platform is available on the Wonderware Global Customer Support site.

The OFS-WSP driver has the same features as OPC V3.6 – Large apart from the following:

- It is licensed from a Wonderware environment only. It cannot be run outside a Wonderware environment
- It contains the server, the simulator, a sample client, configuration tool, configuration manager, and a user manual
- It is OPC DA compatible only (No OPC UA – No OPC XML)

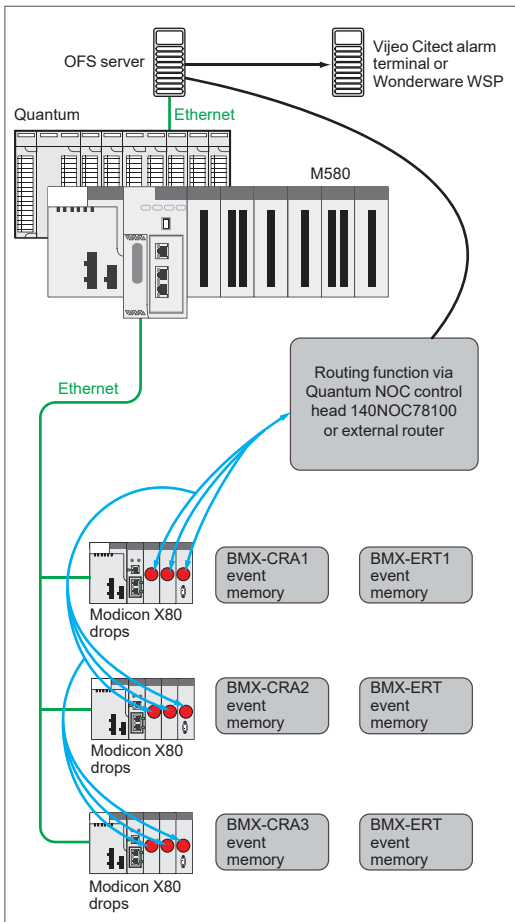

Example of a time stamping architecture

Performance

Performance	Event source module	Value
Between two identical source modules in the same rack	BMXERT1604T	1.6 < resolution < 3.3 ms
	BM•CRA31210	10 ms
Between two different inputs in the same source module	BMXERT1604T	1 ms
	BM•CRA31210	1 scan
Maximum number of events scanned	BMXERT1604T	400 events (1)
	BM•CRA31210	2,048 events (1)
Maximum number of I/O and memory available	BMXERT1604T	16 discrete inputs on module 512 events in internal buffer
	BM•CRA31210	256 discrete I/O configured 4,000 events in internal buffer
Maximum number of source modules in an Ethernet remote drop	BM•CRA31210	1 per drop
	BMXERT•••••	9 per drop
Maximum number of event sources controlled	BMXERT•••••	500 sources per second (1)

(1) This maximum value is not an absolute value. It depends on the overall system dynamics (total number of scanned items and number of events generated by the system).

3

#			
110XCA28201	1/25	UNYSPULZSUV1X	1/22
110XCA28202	1/25	UNYSPULZTV1X	1/22
110XCA28203	1/25	UNYSPULZUGV1X	1/22
990NAA26320	1/25	UNYSPULZUV1X	1/22
990NAA26350	1/25	UNYSPUSFGV1X	1/21
		UNYSPUSFTV1X	1/21
		UNYSPUSFUV1X	1/21
		UNYSPUSZGTV1X	1/21
		UNYSPUSZGV1X	1/21
		UNYSPUSZTV1X	1/21
		UNYSPUSZUGV1X	1/21
		UNYSPUSZUV1X	1/21
		UNYSPUXEFV1X	1/24
		UNYSPUXFFV1X	1/24
		UNYSPUXFGV1X	1/24
		UNYSPUXFTV1X	1/24
		UNYSPUXFUV1X	1/24
		UNYSPUXZEFV1X	1/24
		UNYSPUXZEGV1X	1/24
		UNYSPUXZETV1X	1/24
		UNYSPUXZEUV1X	1/24
		UNYSPUXZGTV1X	1/24
		UNYSPUXZTFV1X	1/24
		UNYSPUXZUGV1X	1/24
		UNYSPUZFUCD80	2/3
		UNYXCAUSB033	1/25
B			
BMXXCAUSBH018	1/25		
BMXXCAUSBH045	1/25		
S			
SR2CBL06	1/25		
STBXCA4002	1/25		
T			
TCSWAAC13FB	1/25		
TLXCDLFOFS36	3/7		
TLXCDLTOFS36	3/7		
TLXCDLUOFS36	3/7		
TLXCDESTOFS36	3/7		
TLXCDSUOFS36	3/7		
TLXCDUPDLOFS	3/7		
TLXCDUPDSOFS	3/7		
TSXCRJMD25	1/25		
TSXCUSB485	1/25		
TSXPCX1031	1/25		
U			
UAGSBTCFUCD10	2/9		
UAGSBTDFUWB13	2/9		
UNYDFFXZZSPA80	2/5		
UNYLAGZAUWB20	2/9		
UNYLFZZAUWB12	2/9		
UNYLVZAUWB10	2/9		
UNYLPZAUWB	2/9		
UNYLTSAUWB10	2/9		
UNYSPUEEFV1X	1/23		
UNYSPUEFFV1X	1/23		
UNYSPUEFGV1X	1/23		
UNYSPUEFTV1X	1/23		
UNYSPUEFUV1X	1/23		
UNYSPUEZV1X	1/23		
UNYSPUEZGTV1X	1/23		
UNYSPUEZGV1X	1/23		
UNYSPUEZLGV1X	1/23		
UNYSPUEZLTV1X	1/23		
UNYSPUEZLUV1X	1/23		
UNYSPUEZTV1X	1/23		
UNYSPUEZUGV1X	1/23		
UNYSPUEZUV1X	1/23		
UNYSPULFFV1X	1/22		
UNYSPULFGV1X	1/22		
UNYSPULFTV1X	1/22		
UNYSPULFUV1X	1/22		
UNYSPULZV1X	1/22		
UNYSPULZGTV1X	1/22		
UNYSPULZGV1X	1/22		
UNYSPULZMGV1X	1/22		
UNYSPULZMTV1X	1/22		
UNYSPULZMUV1X	1/22		
UNYSPULZSGV1X	1/22		
UNYSPULZSTV1X	1/22		

Schneider Electric Industries SAS

Head Office
35, rue Joseph Monier
F-92500 Rueil-Malmaison
France

www.schneider-electric.com

The information provided in this documentation contains general descriptions and/or technical characteristics of the performance of the products contained herein. This documentation is not intended as a substitute for and is not to be used for determining suitability or reliability of these products for specific user applications. It is the duty of any such user or integrator to perform the appropriate and complete risk analysis, evaluation and testing of the products with respect to the relevant specific application or use thereof. Neither Schneider Electric nor any of its affiliates or subsidiaries shall be responsible or liable for misuse of the information contained herein.

Design: Schneider Electric
Photos: Schneider Electric