

# Altivar 312

Variable speed drives  
for asynchronous motors

## DeviceNet communication manual

09/2012

*DeviceNet*<sup>®</sup>  
CONFORMANCE TESTED





# Contents

---

Important Information	4
Before you begin	5
Documentation structure	6
Introduction	7
Hardware setup	8
Wiring to the network	11
Configuration	14
Configuring by the drive HMI	16
Integration of the ATV312 in a DeviceNet network	21
Diagnostics by the drive HMI	27
Supervision and control in LINE mode	28
Supported CIP objects	32

# Important Information

---

## NOTICE

Read these instructions carefully, and look at the equipment to become familiar with the device before trying to install, operate, or maintain it. The following special messages may appear throughout this documentation or on the equipment to warn of potential hazards or to call attention to information that clarifies or simplifies a procedure.



The addition of this symbol to a Danger or Warning safety label indicates that an electrical hazard exists, which will result in personal injury if the instructions are not followed.



This is the safety alert symbol. It is used to alert you to potential personal injury hazards. Obey all safety messages that follow this symbol to avoid possible injury or death.

## **DANGER**

**DANGER** indicates an imminently hazardous situation, which, if not avoided, **will result** in death or serious injury.

## **WARNING**

**WARNING** indicates a potentially hazardous situation, which, if not avoided, **can result** in death, serious injury or equipment damage.

## **CAUTION**

**CAUTION** indicates a potentially hazardous situation, which, if not avoided, **can result** in injury or equipment damage.

## **CAUTION**

**CAUTION**, used without the safety alert symbol, indicates a potentially hazardous situation which, if not avoided, **can result** in equipment damage.

## PLEASE NOTE

The word "drive" as used in this manual refers to the controller portion of the adjustable speed drive as defined by NEC.

Electrical equipment should be installed, operated, serviced, and maintained only by qualified personnel. No responsibility is assumed by Schneider Electric for any consequences arising out of the use of this product.

© 2012 Schneider Electric. All Rights Reserved.

# Before you begin

Read and understand these instructions before performing any procedure with this drive.

## DANGER

### HAZARD OF ELECTRIC SHOCK, EXPLOSION, OR ARC FLASH

- Read and understand this manual before installing or operating the Altivar 312 drive. Installation, adjustment, repair, and maintenance must be performed by qualified personnel.
- The user is responsible for compliance with all international and national electrical code requirements with respect to grounding of all equipment.
- Many parts of this drive, including the printed circuit boards, operate at the line voltage. DO NOT TOUCH. Use only electrically insulated tools.
- DO NOT touch unshielded components or terminal strip screw connections with voltage present.
- DO NOT short across terminals PA/+ and PC/- or across the DC bus capacitors.
- Before servicing the drive:
  - Disconnect all power, including external control power that may be present.
  - Place a "DO NOT TURN ON" label on all power disconnects.
  - Lock all power disconnects in the open position.
  - WAIT 15 MINUTES to allow the DC bus capacitors to discharge.
  - Measure the voltage of the DC bus between the PA/+ and PC/- terminals to ensure that the voltage is less than 42 Vdc.
  - If the DC bus capacitors do not discharge completely, contact your local Schneider Electric representative. Do not repair or operate the drive
- Install and close all covers before applying power or starting and stopping the drive.

**Failure to follow these instructions will result in death or serious injury.**

## DANGER

### UNINTENDED EQUIPMENT OPERATION

- Read and understand this manual before installing or operating the Altivar 312 drive.
- Any changes made to the parameter settings must be performed by qualified personnel.

**Failure to follow these instructions will result in death or serious injury.**

## WARNING

### DAMAGED DRIVE EQUIPMENT

Do not operate or install any drive or drive accessory that appears damaged.

**Failure to follow these instructions can result in death, serious injury, or equipment damage.**

## WARNING

### LOSS OF CONTROL

- The designer of any control scheme must consider the potential failure modes of control paths and, for certain critical control functions, provide a means to achieve a safe state during and after a path failure. Examples of critical control functions are emergency stop and overtravel stop.
- Separate or redundant control paths must be provided for critical control functions.
- System control paths may include communication links. Consideration must be given to the implications of unanticipated transmission delays or failures of the link.<sup>a</sup>

**Failure to follow these instructions can result in death, serious injury, or equipment damage.**

a. For additional information, refer to NEMA ICS 1.1 (latest edition), "Safety Guidelines for the Application, Installation, and Maintenance of Solid State Control" and to NEMA ICS 7.1 (latest edition), "Safety Standards for Construction and Guide for Selection, Installation and Operation of Adjustable-Speed Drive Systems."

# Documentation structure

---

The following Altivar 312 technical documents are available on the Schneider Electric website ([www.schneider-electric.com](http://www.schneider-electric.com)) as well as on DVD-ROM (reference VW3A8200).

## Installation manual

This manual describes how to install and wire the drive.

## Programming manual

This manual describes the functions, parameters and use of the drive terminal (integrated display terminal, optional graphic display terminal and optional remote terminal).

The communication functions are not described in this manual, but in the manual for the bus or network used.

## Simplified manual

This manual is a simplified version of the User manual. This manual is delivered with the drive.

## Quick Start sheet

The Quick Start describes how to wire and configure the drive to start motor quickly and simply for simple applications. This document is delivered with the drive.

## Communication manuals: CANopen, DeviceNet, Modbus and Profibus

These manuals describe the assembly, connection to the bus or network, signaling, diagnostics, and configuration of the communication-specific parameters.

They also describe the protocol communication services.

## Communication variables guide

This manual defines the drive control processes and the drive variables which can be accessed by the communication buses: Modbus, CANopen, ...

# Introduction

---

## Presentation

The DeviceNet communication card (catalog number VW3A312 09) is used to connect an Altivar 312 drive to a DeviceNet network.

The communication card has an open-style 5-pin connector for connection to the network.

Data exchanges give access to all Altivar 312 functions:

- Command,
- Monitoring,
- Diagnostics.

DeviceNet cables and connecting accessories must be ordered separately.

The graphic display terminal or the integrated display terminal can be used to access numerous functions for communication diagnostics.

## Notation

### Drive terminal displays

The graphic display terminal menus, available with the remote graphic display terminal option are shown in square brackets.

Example: [1.9 COMMUNICATION].

The integrated 7-segment display terminal menus are shown in round brackets.

Example: (COM-).

Parameter names are displayed on the graphic display terminal in square brackets.

Example: [Fallback speed]

Parameter codes are displayed on the integrated 7-segment display terminal in round brackets.

Example: (LFF).

### Formats

Hexadecimal values are written as follows: 16#

Binary values are written as follows: 2#

## Vocabulary

Depending on DeviceNet document and tools, equivalent wordings are used. The table below shows vocabulary used in the present document and other corresponding definitions.

In this document	Other	Comments
Node address	DeviceNet address, MAC ID	
Data rate	Baud rate	
kbit/s	kbps	
Setpoint	Reference, target	
Path	Object Address	Class, instance, attribute

The reader should avoid mixing two terms:

- DeviceNet scanner, which is the master device on the DeviceNet network.
- Communication scanner, which is a function inside the Altivar drive.

## Abbreviations

Req. = Required

Opt. = Optional

# Hardware setup

## Presentation

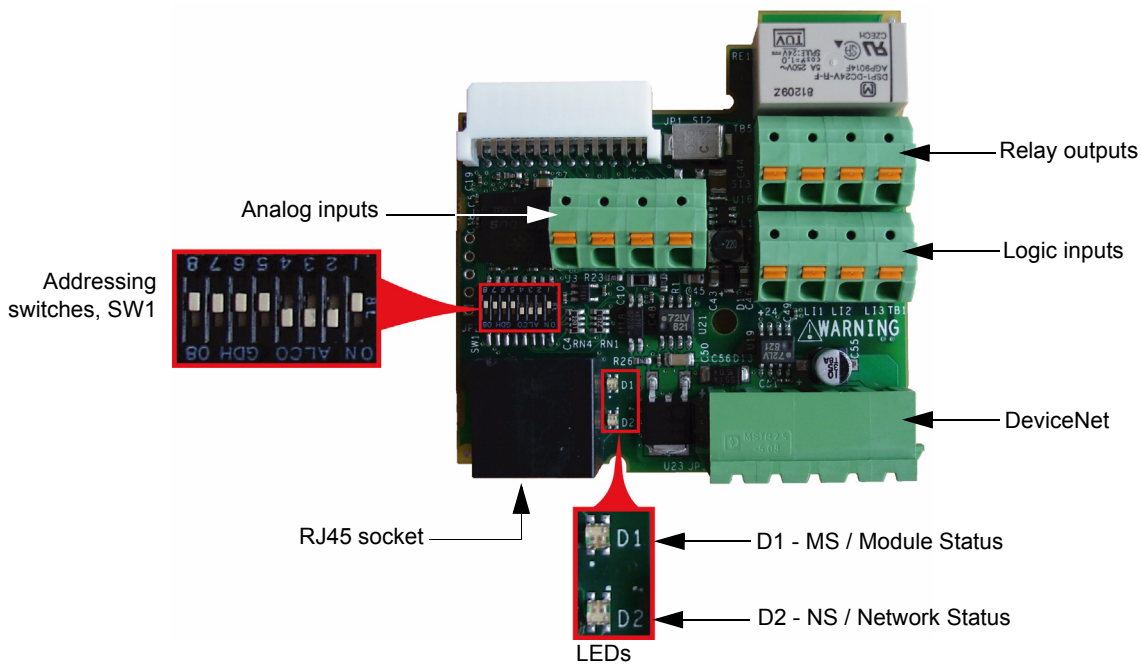

## Receipt

- Check that the card reference printed on the label is the same as that on the delivery note corresponding to the purchase order.
- Remove the option card from its packaging and check that it has not been damaged in transit.

## Installing the card in the drive

### **⚠ DANGER**

#### **UNINTENDED EQUIPMENT OPERATION**

- Do not plug or unplug the terminal board while drive is powered.
- Check the tightening of the fixing screw after any manipulation on the terminal board.

**Failure to follow these instructions will result in death or serious injury.**

### **⚡ ⚠ DANGER**

#### **HAZARD OF ELECTRIC SHOCK, EXPLOSION, OR ARC FLASH**

Do not touch the terminal board before:

- removing power on the drive,
- removing any voltage on input and output terminals.

**Failure to follow these instructions will result in death or serious injury.**



# Hardware setup

Install the card in ATV312 as follows:

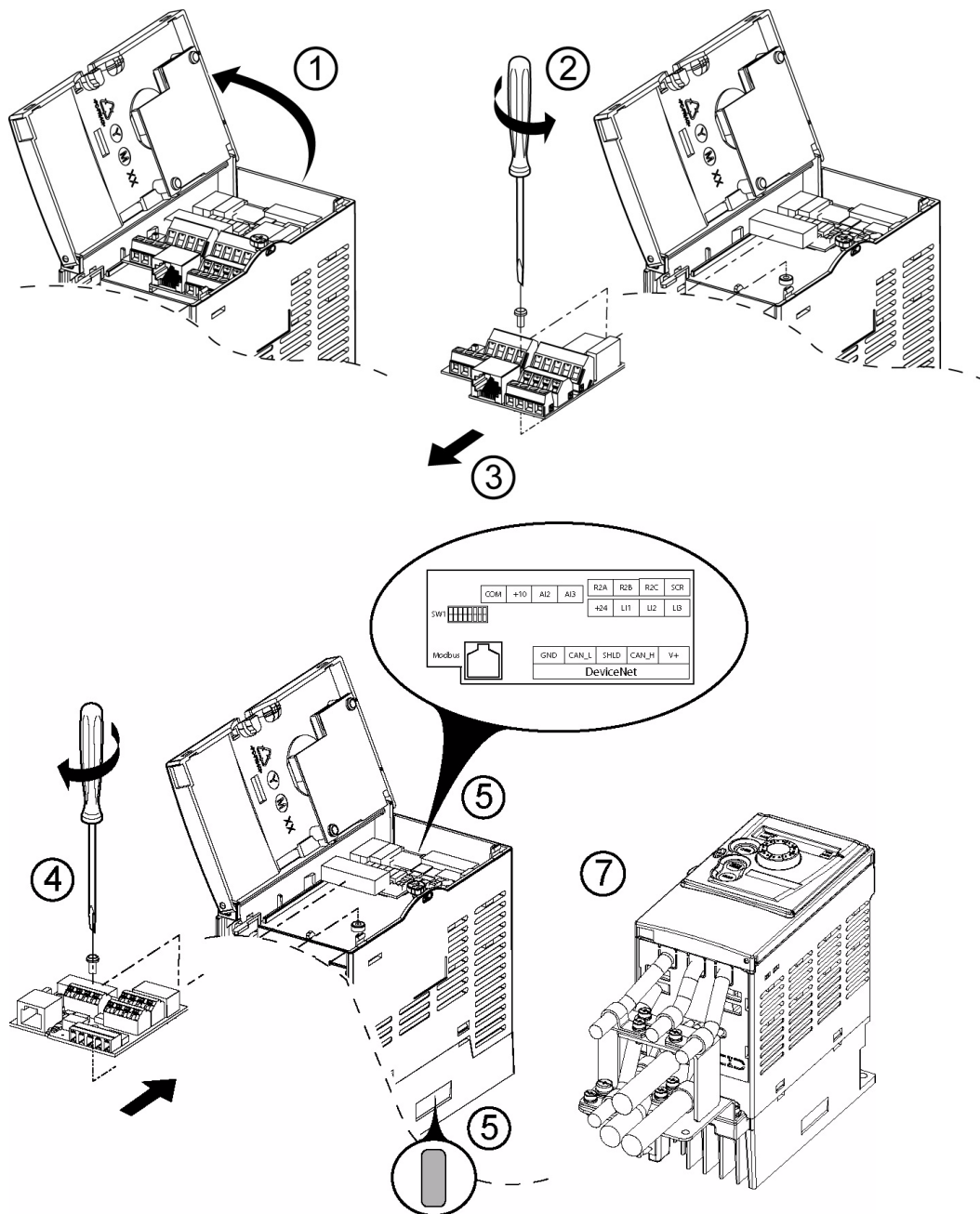

1. Open the ATV312 front cover. Remove the plastic cover plate from the power terminals (see Installation manual).

2 & 3. Remove the terminal board fixing screw and take off the ATV312 standard terminal board. (Be careful not to lose the terminal board fixing screw when removed since it may be used again.) This step does not apply if you are using an ATV312.... B (product without standard IO terminal).

4. Install the DeviceNet card and secure it with the board fixing screw. (M3 tapping screw tightening torque: 0.7 to 0.8Nm)

5. Stick the new cabling label above the DeviceNet option card. Stick the DeviceNet card nameplate near the ATV312 nameplate. (Be careful not to cover slits on the ATV312 enclosure)

6. Perform wiring on the DeviceNet card (see page 11).

7. Wire and screw the EMC clamps for the DeviceNet cables (and control wires if required).

**Note:** To install or remove the terminal board, make it slide in or out in parallel with board.

## Characteristics and functions of the terminals

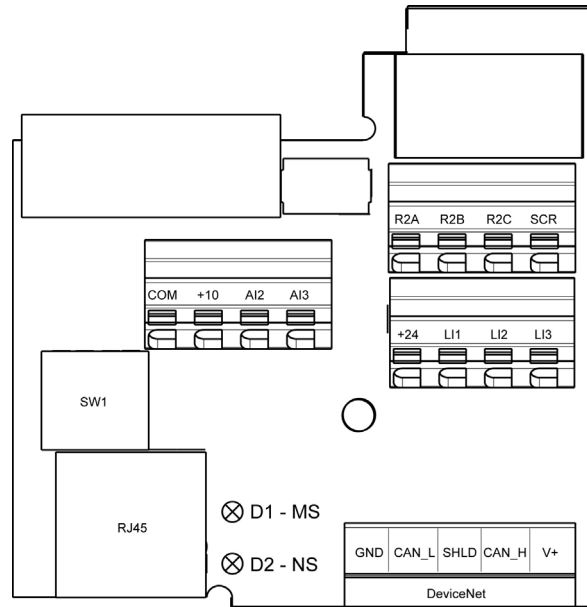

Terminal	Function	Electrical characteristics
R2A R2B R2C	Configurable relay outputs: 1 relay logic output, one "N/C" contact and one "N/O" contact with common point.	<ul style="list-style-type: none"> <li>• Minimum switching capacity: 10 mA for 5 V <math>\text{---}</math></li> <li>• Maximum switching capacity on resistive load (<math>\cos \varphi = 1</math> and <math>L/R = 0</math> ms): 5 A for 250 V <math>\sim</math> and 30 V <math>\text{---}</math></li> <li>• Maximum switching capacity on inductive load (<math>\cos \varphi = 0.4</math> and <math>L/R = 7</math> ms): 2 A for 250 V <math>\sim</math> and 30 V <math>\text{---}</math></li> <li>• Sampling time: 8 ms</li> <li>• Service life: 100,000 operations at maximum switching power</li> </ul>
SCR	(Screen)	<p>Communication shield terminal. This terminal is not connected to other circuits in this board. Ground this terminal in a location separated from the ground of power line.</p>
COM	Analog I/O common	0 V
+10	Power supply for reference potentiometer (2.2 to 10 k $\Omega$ )	<ul style="list-style-type: none"> <li>• +10 V (+ 8% - 0%)</li> <li>• 10 mA max</li> <li>• Protected against short-circuits and overloads</li> </ul>
AI2	Analog voltage input	<p>Bipolar analog input <math>0 \pm 10</math> V (maximum safe voltage <math>\pm 30</math> V) <b>The + or - polarity of the voltage on AI2 affects the direction of the setpoint and therefore the direction of operation.</b></p> <ul style="list-style-type: none"> <li>• Impedance: 30 k<math>\Omega</math></li> <li>• Resolution: 0.01 V, 10-bit + sign converter</li> <li>• Precision <math>\pm 4.3\%</math>, linearity <math>\pm 0.2\%</math>, of maximum value</li> <li>• Sampling time: 8 ms</li> <li>• Operation with shielded cable 100 m maximum</li> </ul>
AI3	Analog current input	<p>Analog current input X-Y mA by programming X and Y from 0 to 20 mA: • Impedance: 250 <math>\Omega</math></p>
+24	Logic input power supply	<ul style="list-style-type: none"> <li>• + 24 V protected against short-circuits and overloads, minimum 19 V, maximum 30 V</li> <li>• Maximum customer current available: 100 mA</li> </ul>
LI1 LI2 LI3	Logic inputs	<p>Programmable logic inputs in source mode</p> <ul style="list-style-type: none"> <li>• Impedance: 3.5 k<math>\Omega</math></li> <li>• + 24 V internal or 24 V external power supply (min. 19 V, max. 30 V)</li> <li>• Max. current: 100 mA</li> <li>• Max. sampling time: 4 ms</li> </ul> <p>Positive logic State 0 if &lt; 5 V or logic input not wired, state 1 if &gt; 11 V</p>
RJ45	Communication port	Connection for SoMove software, Modbus, remote display, loader tools.
SW1	Addressing switches	See page <a href="#">15</a> .
DeviceNet	Communication	DeviceNet open style connector for connection to the fieldbus, see page <a href="#">11</a> .
D1 - MS	Module Status LED	See page <a href="#">27</a> .
D2 - NS	Network Status LED	See page <a href="#">27</a> .

# Wiring to the network

## Connection to the Modbus base port

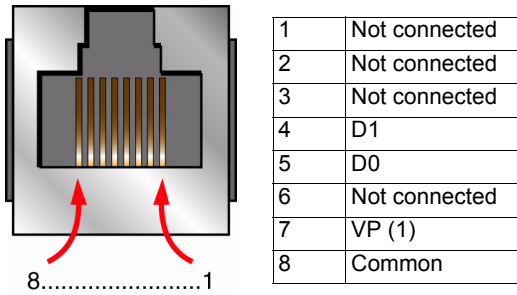

(1) Reserved for RS232/RS485 converter

## Wiring the DeviceNet connector

The figures and the table below show the pin-outs of the card connectors. The removable DeviceNet female connector attaches to the network cable.

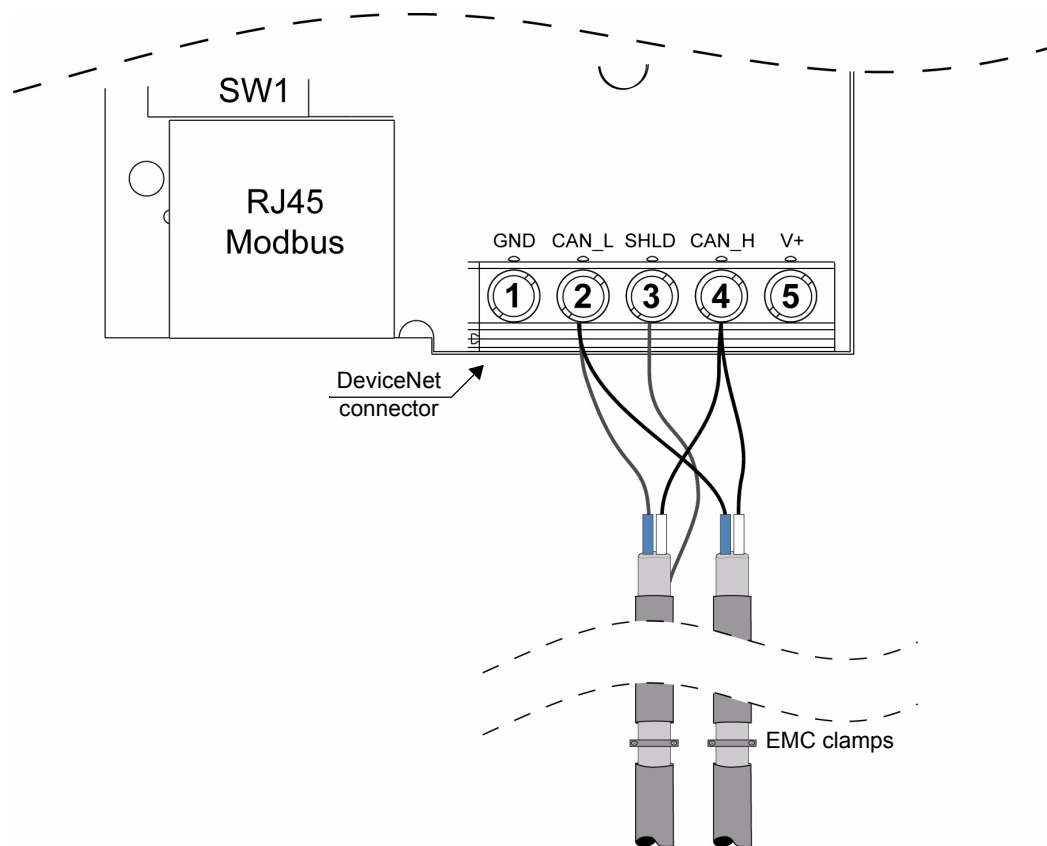

Pin	Name	Color
1	GND	Black
2	CAN_L	Blue
3	SHIELD	Bare
4	CAN_H	White
5	V+	Red

Line termination: If the drive is the first or the last device on the DeviceNet network, a line terminator (121 Ohm resistor) must be wired on the removable DeviceNet female connector, between pins 2 and 4 (CAN\_L and CAN\_H).

# Wiring to the network

## Cable routing practices

When wiring Altivar 312 drives to a DeviceNet network, follow all wiring practices required by national and local electrical codes.

Also observe the following guidelines:

- Avoid areas of high temperature, moisture, vibration, or other mechanical stress.
- Secure the cable where necessary to prevent its weight and the weight of other cables from pulling or twisting the cable.
- Use cable ducts, raceways, or other structures to protect the cable. Use these structures for signal wiring paths. They must not contain power wiring.
- Avoid sources of electrical interference that can induce noise into the cable. Use the maximum practicable separation from such sources.

When planning cable routing within a building, follow these guidelines:

- Maintain a minimum separation of 1 m (40 in) from the following equipment:
  - air conditioners and large blowers,
  - elevators and escalators,
  - radios and televisions,
  - intercom and security systems,
  - fluorescent, incandescent, and neon lighting fixtures.
- Maintain a minimum separation of 3 m (118 in) from the following equipment:
  - line and motor power wiring,
  - transformers,
  - generators,
  - alternators.

When wiring in electrical equipment rooms or large electrical equipment line-ups, observe the following guidelines for cable segregation and separation of circuits:

- Use metallic conduit for drive wiring. Do not run control network and power wiring in the same conduit.
- Separate non-metallic conduits or cable trays used to carry power wiring from metallic conduit carrying low-level control network wiring by at least 300 mm (11.9 in).
- Separate metallic conduits carrying power wiring or low-level control network wiring by at least 80 mm (3.15 in).
- Cross the metallic conduits and non-metallic conduits at right angles whenever power and control network wiring cross.
- Attenuate conducted emissions from the drive to the line in some installations to prevent interference with telecommunication, radio, and sensitive electronic equipment. Such instances may require attenuating filters. Consult the Altivar catalog for selection and application of these filters.

The ODVA standards (Release 2.0) specify 7 types of cables for use in DeviceNet networks:

- Thick cable
- Thin cable
- Flat cable
- Cable I
- Cable II
- Cable IV
- Cable V

The table below lists main specifications of cables. For more information, refer to the ODVA specifications.

Type of cable	Data conductor pair size	Power conductor pair size	Data impedance
Thick cable	18 AWG	15 AWG	120 Ohm +/- 10 % (at 1 MHz)
Thin cable	24 AWG	22 AWG	120 Ohm +/- 10 % (at 1 MHz)
Flat cable	16 AWG	16 AWG	120 Ohm +/- 10 % (at 500 kHz)
Cable I	24 AWG	22 AWG	120 Ohm +/- 10 % (at 1 MHz)
Cable II	18 AWG	15 AWG	120 Ohm +/- 10 % (at 1 MHz)
Cable IV	18 AWG	16 AWG	120 Ohm +/- 10 % (at 500 kHz)
Cable V	18 AWG	16 AWG	120 Ohm +/- 10 % (at 500 kHz)

# Wiring to the network

---

The maximum permissible length of the network cable depends on the data rate and the type of cable.

Type of cable	Data rate		
	125 kbit/s	250 kbit/s	500 kbit/s
Thick cable	500 m (1640 ft)	250 m (820 ft)	100 m (328 ft)
Thin cable	100 m (328 ft)	100 m (328 ft)	100 m (328 ft)
Flat cable	420 m (1378 ft)	200 m (656 ft)	75 m (246 ft)
Cable I	100 m (328 ft)	100 m (328 ft)	100 m (328 ft)
Cable II	500 m (1640 ft)	250 m (820 ft)	100 m (328 ft)
Cable IV	-	-	-
Cable V	420 m (1378 ft)	200 m (656 ft)	75 m (246 ft)

For maximum length of the drops refer to table, whatever type of cable:

Data rate	Cumulative drop	Maximum drop
125 kbit/s	156 m (516 ft)	6 m (20 ft)
250 kbit/s	78 m (256 ft)	6 m (20 ft)
500 kbit/s	39 m (128 ft)	6 m (20 ft)

# Configuration

## Drive behaviour at first Power on with a PROFIBUS DP option card

At the first power on, the message (CFF) [Incorrect config.] appears on the product.  
Press Enter to see [Restore config.] (FCS) menu.  
Select the [Config. CFG] (InI) parameter to recover the factory settings.

For more information, see the [Restore config.] (FCS) parameter in ATV312 programming manual on [www.schneider-electric.com](http://www.schneider-electric.com)

### **⚠ DANGER**

#### **UNINTENDED EQUIPMENT OPERATION**

Check that the modification of the current configuration is compatible with the wiring diagram used.

**Failure to follow these instructions will result in death or serious injury.**

## Coding the switches

### Switches description

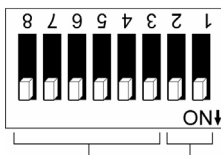

High = OFF = 0  
Low = ON = 1

Node address      Data rate

### Overriding the switches

When switches 2 and 1 are set in position low (ON = 1), the data rate of the drive must be set by a network tool (refer to the chapter "Integration of the ATV312 in a DeviceNet network", page 21). Default values are 125 kbit/s and node address 63.

### Coding the data rate

All devices connected to the DeviceNet network must communicate at the same data rate: 125, 250, or 500 kbit/s. The table below shows the switch settings that configure the DeviceNet data rate on the drive.

Switch 2	Switch 1	Data rate
0	0	125 kbit/s
0	1	250 kbit/s
1	0	500 kbit/s
1	1	The DeviceNet data rate of the drive must be set by a network tool.

Any change to the switch setting takes effect at the next power-up.

# Configuration

## Coding the node address

All devices connected to the DeviceNet network must have a unique address, ranging from 0 to 63 (decimal).

The table below lists the switch setting for each valid node address. Any change to the switch setting takes effect at the next power-up.

Node address	Switches 876543	Node address	Switches 876543	Node address	Switches 876543	Node address	Switches 876543
0	00 0000	16	01 0000	32	10 0000	48	11 0000
1	00 0001	17	01 0001	33	10 0001	49	11 0001
2	00 0010	18	01 0010	34	10 0010	50	11 0010
3	00 0011	19	01 0011	35	10 0011	51	11 0011
4	00 0100	20	01 0100	36	10 0100	52	11 0100
5	00 0101	21	01 0101	37	10 0101	53	11 0101
6	00 0110	22	01 0110	38	10 0110	54	11 0110
7	00 0111	23	01 0111	39	10 0111	55	11 0111
8	00 1000	24	01 1000	40	10 1000	56	11 1000
9	00 1001	25	01 1001	41	10 1001	57	11 1001
10	00 1010	26	01 1010	42	10 1010	58	11 1010
11	00 1011	27	01 1011	43	10 1011	59	11 1011
12	00 1100	28	01 1100	44	10 1100	60	11 1100
13	00 1101	29	01 1101	45	10 1101	61	11 1101
14	00 1110	30	01 1110	46	10 1110	62	11 1110
15	00 1111	31	01 1111	47	10 1111	63	11 1111

## Examples

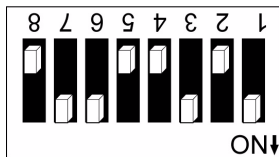

Data rate = 250 kbit/s (switches 1 and 2 = 2#01)  
Node address = 25 (switches 3 to 8 = 2#01 1001)

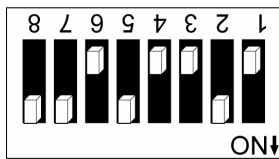

Data rate = 500 kbit/s (switches 1 and 2 = 2#10)  
Node address = 52 (switches 3 to 8 = 2#11 0100)

# Configuring by the drive HMI

## Configuring the control

### Principle

By the configuration of the control, it is possible to decide from what channel the drive receives its commands and setpoint, either permanently or depending on a switching command.

Numerous configurations are possible. For more information, refer to the Programming manual and Communication parameters manual. The following configurations are some of the possibilities available.

The choice of the assembly set is defined by the application at the DeviceNet scanner level. It cannot be set at the device level. See the paragraph "Assembly Selection" in the chapter "Integration of the ATV312 in a DeviceNet network", page [26](#).

#### □ Control with native profile

- 100: Native profile control input made of CMD and LFR
- 101: Native profile control output made of ETA and RFR

Please refer to the chapter "Supervision and control in LINE mode", page [28](#).

#### □ Control according to ODVA AC drive profile

The ODVA AC drive profile is activated when one of the following assemblies is selected:

- 20: Basic speed control output
- 21: Extended speed control output
- 70: Basic speed control input
- 71: Extended speed control input

The advantage of using the ODVA drive profile standard is the interchangeability with other brands.

The DeviceNet card translates the commands, behaviour and monitoring information from of ODVA profile (on the network) to the Drivecom profile (in the drive).

## Available configurations

#### □ If you use the native profile:

- 100: Native command Word and speed reference (CMD and LFRD)
- 101: Native status and current speed (ETA and RFRD)

The examples below are only possible if you use the communication scanner.

#### □ If you use the ODVA AC drive profile, that is, the assemblies:

- 20: Basic speed control output

Byte	Bit 7	Bit 6	Bit 5	Bit 4	Bit 3	Bit 2	Bit 1	Bit 0
0						Fault reset		Run fwd
1								
2	Speed reference (Low byte)							
3	Speed reference (High byte)							

- 21: Extended speed control output

Byte	Bit 7	Bit 6	Bit 5	Bit 4	Bit 3	Bit 2	Bit 1	Bit 0
0		NetRef	NetCtrl			Fault reset	Run rev	Run fwd
1								
2	Speed reference (Low byte)							
3	Speed reference (High byte)							



# Configuring by the drive HMI

- 70: Basic speed control input

Byte	Bit 7	Bit 6	Bit 5	Bit 4	Bit 3	Bit 2	Bit 1	Bit 0
0						Running1		Faulted
1								
2	Speed actual (Low byte)							
3	Speed actual (High byte)							

- 71: Extended speed control input

Byte	Bit 7	Bit 6	Bit 5	Bit 4	Bit 3	Bit 2	Bit 1	Bit 0
0	At reference	Ref from net	Ctrl from net	Ready	Running2 (Rev)	Running1 (Fwd)	Warning	Faulted
1	Drive state							
2	Speed actual (Low byte)							
3	Speed actual (High byte)							

## Control signal of an ATV312 from DeviceNet or from a communication card

There are several ways to control an ATV 312 from a communication card:

- The control word and the speed reference are controlled from the network in the same time.
- The control word and the speed reference come from separate sources.

However separate mode is only allowed when the [\[ACCESS LEVEL\] \(LAC\)](#) parameter in the [\[COMMAND\] \(CtL-\)](#) menu is set to L3. The Control of the drive is also detailed in the programming manual of the ATV312 in the chapter "Control Menu".

### Control of the drive when LAC = L1 or L2

There is now particular settings, the channels are managed in order of priority.

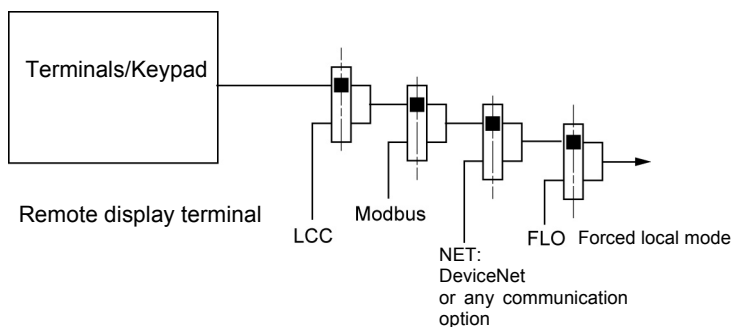

### Control of the drive when LAC = L3

When configured with LAC = L3 several configurations are possible:

#### Control and reference come from the communication card

The command and the target come from DeviceNet. Control is in native profile (CiA402).

# Configuring by the drive HMI

Configure the following parameters:

Parameter	Value	Comment
Profile	Combined native profile (CiA402)	The run commands are in native profile (CiA402), the command and the target come from the same channel.
Target 1 configuration	Network card	The command comes from DeviceNet.

Configuration via the graphic display terminal or the integrated display terminal:

Menu	Parameter	Value
[COMMAND] (CtL-)	[Profile] (CHCF)	[Not separ.] (SIM) (factory setting)
	[Ref.1 channel] (Fr1)	[Network] (nEt)

## Control via DeviceNet or the terminals in native profile (CiA402)

The command and the target both come from DeviceNet or the terminals. Input LI3 at the terminals is used to switch between DeviceNet and the terminals.

Control is in native profile (CiA402).

Configure the following parameters:

Parameter	Value	Comment
Profile	Combined native profile (CiA402)	The run commands are in native profile (CiA402), the command and the target come from the same channel.
Target 1 configuration	Network card	Target 1 comes from DeviceNet.
Target 2 configuration	Analog input 2 on the terminals	Target 2 comes from input AI2 on the terminals.
Target switching	Input LI3	Input LI3 switches the target (1 ↔ 2) and the command.

Configuration via the graphic display terminal or the integrated display terminal:

Menu	Parameter	Value
[COMMAND] (CtL-)	[Profile] (CHCF)	[Not separ.] (SIM)
	[Ref.1 channel] (Fr1)	[Network] (nEt)
	[Ref.2 channel] (Fr2)	[AI2] (AI2)
	[Ref 2 switching] (rFC)	[LI3] (LI3)

## Control is separated from reference channel

### Control via DeviceNet or the terminals in native profile (CiA402)

The command and the target both come from DeviceNet or the terminals. Input LI3 at the terminals is used to switch between DeviceNet and the terminals.

Control is in native profile (CiA402).

Configure the following parameters:

Parameter	Value	Comment
Profile	Separate native profile (CiA402)	The run commands are in Drivecom profile, the command and the setpoint can come from different channels.
Target 1 configuration	Network card	Target 1 comes from DeviceNet.
Target 2 configuration	Analog input 2 on the terminals	Target 2 comes from input AI2 on the terminals.
Target switching	Input LI3	Input LI3 switches the target (1 ↔ 2) and the command.
Command 1 configuration	Network card	Command 1 comes from DeviceNet.
Command 2 configuration	Terminals	Command 2 comes from the terminals.
Command switching	Input LI3	Input LI3 switches the command.

# Configuring by the drive HMI

Menu	Parameter	Value
[COMMAND] (CtL-)	[Profile] (CHCF) is configured in not separate mode	[Not separ.] (SIM)
	[Cmd channel 1] (Cd1) Channel 1 is used with the communication	[Network] (nEt)
	[Cmd channel 2] (Cd2) Channel 2 is used with the terminal blocks	[Terminal] (tEr)
	[Cmd switching] (CCS) LI3 is used for switching between channel 1 and 2. (see also the programming manual of the ATV312 for more details)	[LI3] (LI3)
	[Ref.1 channel] (Fr1)	[Network] (nEt)
	[Ref.2 channel] (Fr2)	[AI2] (AI2)
	[Ref 2 switching] (rFC)	[LI3] (LI3)

For more information, see the chapter "Assembly selection", page [26](#).

## Control and reference with assembly sets 20/70 or 21/71

The ODVA profile 20/70 or 21/71 integrates a control/reference switching. See command word 20 and 21 page [16](#), and status word 70 or 71 page [17](#).

Configure the drive as described below.

NetRef and NetCtrl need to be associated to a command bit (C2XX).

Menu	Parameter	Value
[COMMAND] (CtL-)	[Ref.1 channel] (Fr1)	[Network] (nEt): Reference via network communication protocol
	[Ref.2 channel] (Fr2)	[AI2] (AI2): Analog input AI2 OR [AI3] (AI3): Analog input AI3
	[Ref.2 switching] (rFC)	[C213] (C213): Bit 13 of network control word
	[Profile] (CHCF)	[Separate] (SEP): Separate mode
	[Cmd channel 1] (Cd1)	[Network] (nEt): Control via the network
	[Cmd channel 2] (Cd2)	[Terminal] (tEr): Control via terminals
	[Cmd switching] (CCS)	[C212] (C212): Bit 12 of network control word (See the ATV312 programming manual for more details)

## Explicit Messaging

### Class Code

Hexadecimal	Decimal
16#70 to 16#A8	112 to 424

The drive parameters are grouped in classes:

- Each application class has only 1 instance.
- Each instance groups 200 parameters.
- Each attribute in an instance relates to a parameter.
- The first parameter registered in the first application.

### Examples

Class code = ((ADL - 3000)/200) + 70hex

Attribute ID = (ADL modulo 200)+1

Instance = 1

Drive logical address	Hexadecimal path
3 000	16# 70 / 01 / 01
3 100	16# 70 / 01 / 65
3 201	16# 71 / 01 / 02

**NOTE:** ADL = Parameter Number = Modbus@.

# Configuring by the drive HMI

## Communication fault management

The behaviour of the drive in case of communication interruption is described in the ATV312 programming manual.

The communication between the master (external management system) and the drive is broken:  
In this case, the drive will generate an (CnF) error message.

The communication card is not working properly:  
In this case, the drive will generate a (COF) message.

Code	Name	Probable cause	Remedy
CFF	[INCORRECT CONFIG.]	<ul style="list-style-type: none"><li>The current configuration is inconsistent.</li><li>Addition or removal of an option</li></ul>	<ul style="list-style-type: none"><li>Return to factory settings or retrieve the backup configuration, if it is valid. See the [Restore config.] (FCS) parameter in ATV312 programming manual.</li></ul>
CnF	[NETWORK FAULT]	<ul style="list-style-type: none"><li>Communication detected fault on the communication card</li></ul>	<ul style="list-style-type: none"><li>Check the environment (electromagnetic compatibility).</li><li>Check the wiring.</li><li>Check the time out.</li><li>Replace the option card.</li><li>See the [CANopen fault mgt] (COL) parameter in the ATV312 programming manual to define the stop mode with a (CnF).</li></ul>
COF	[CANopen FAULT]	<ul style="list-style-type: none"><li>Interruption in communication between the option card and the drive</li></ul>	<ul style="list-style-type: none"><li>Check the communication bus.</li><li>Check the option card.</li></ul>
ILF	[INTERNAL LINK FAULT]	<ul style="list-style-type: none"><li>Interruption in communication between the option card and the drive</li></ul>	<ul style="list-style-type: none"><li>Replace the option card.</li></ul>

(CnF) [Network fault]: Option card fault code

This parameter is read-only and is only visible if an option card is present.  
The fault code remains saved in the parameter, even if the cause disappears.  
The parameter is reset after the drive is disconnected and then reconnected.

The values of this parameter is:

1: Time out on the reception of the periodic variables addressed to the drive

For the full list of the fault detected codes, see ATV312 programming manual on [www.schneider-electric.com](http://www.schneider-electric.com)

# Integration of the ATV312 in a DeviceNet network

This chapter describes how to integrate an Altivar 312 in a DeviceNet network controlled by a Rockwell Automation PLC.

## Installing the eds file

The eds file of the VW3 A312 09 communication card can be downloaded from Schneider Electric website ([www.schneider-electric.com](http://www.schneider-electric.com)).

1. To install the new eds file, you can launch the EDS wizard from RSNetWorx for DeviceNet by selecting **Tools > FDS Wizard**.

**Note:** We recommend to use a recent version of RSNetWorx (V7.0 or later).

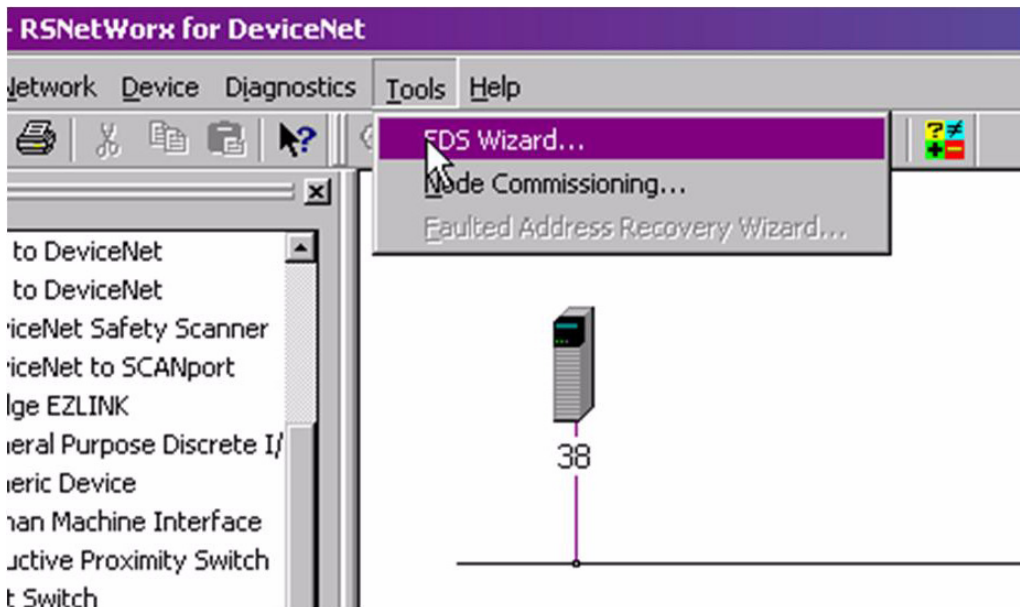

2. Click **Next**.



# Integration of the ATV312 in a DeviceNet network

3. Select **Register an EDS file(s)**, and then click **Next**.

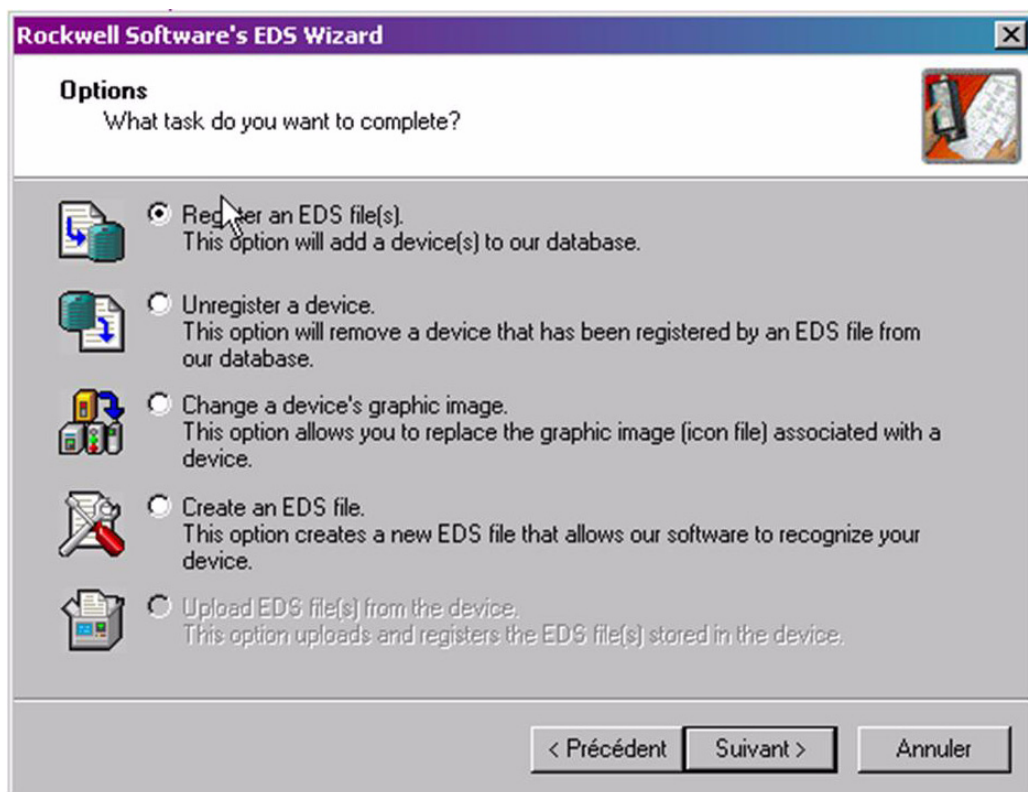

4. Select the location where the eds file has been recorded, and then click **Next**.

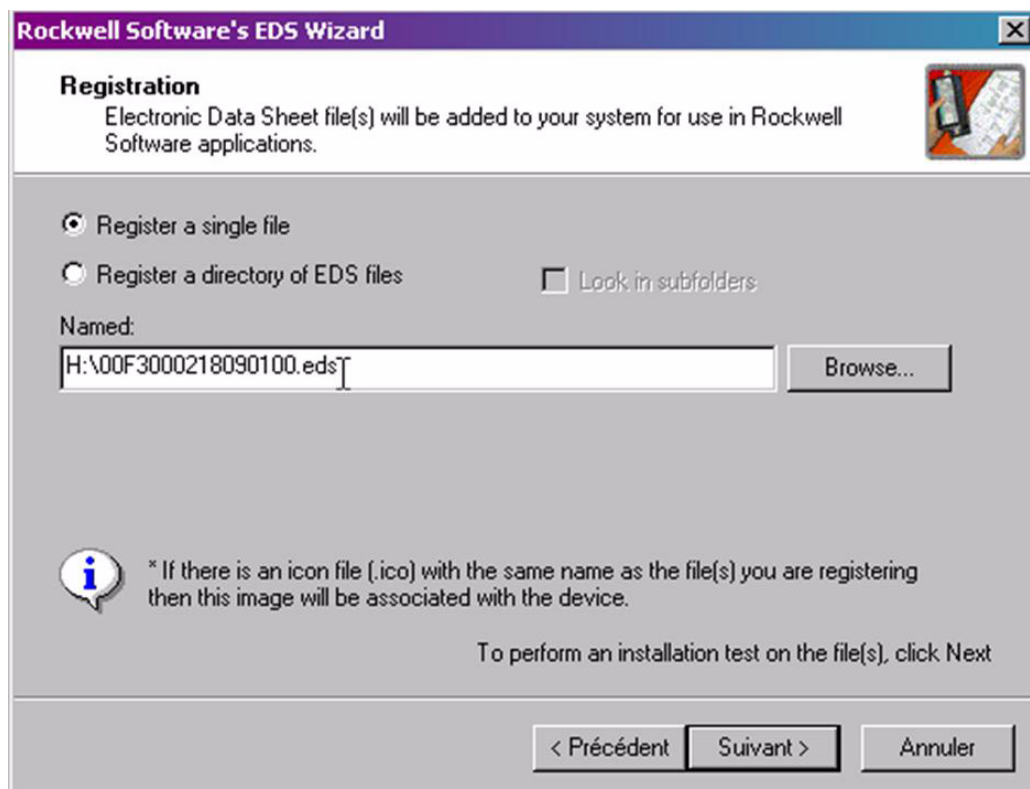

# Integration of the ATV312 in a DeviceNet network

You should get the following result, that indicates that the eds file has been successfully imported.

5. Click **Next**.

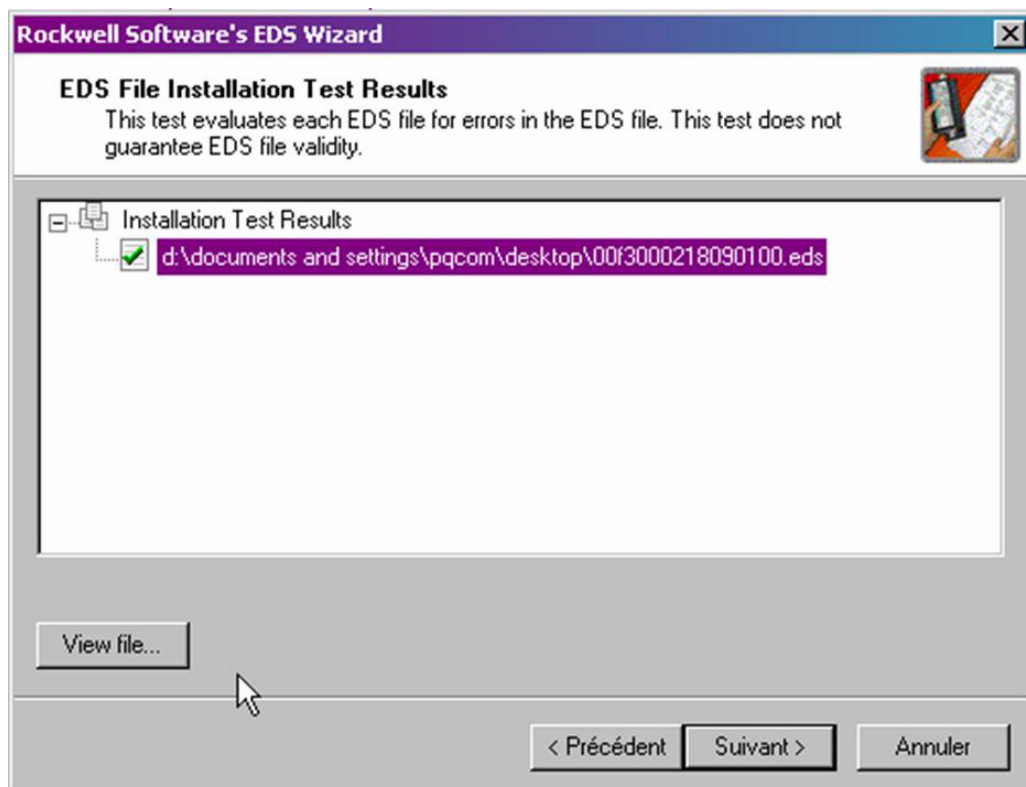

6. The wizard will propose you to change the icon picture associated to the device.  
If you don't need to change the icon file, click **Next** to terminate the eds registration.

7. Click **Finish**.

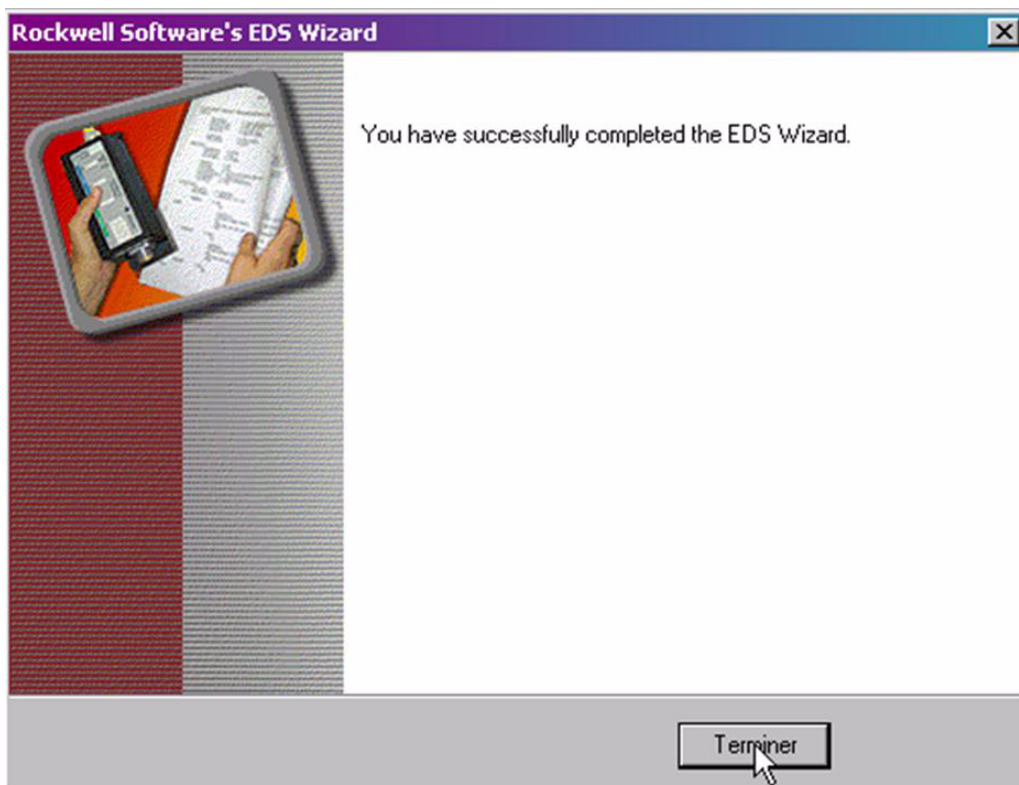

# Integration of the ATV312 in a DeviceNet network

## Configuration of the DeviceNet Module in the Rockwell PLC

In the example, the module is installed in the first slot of the local base plate of a 1755 CPU:

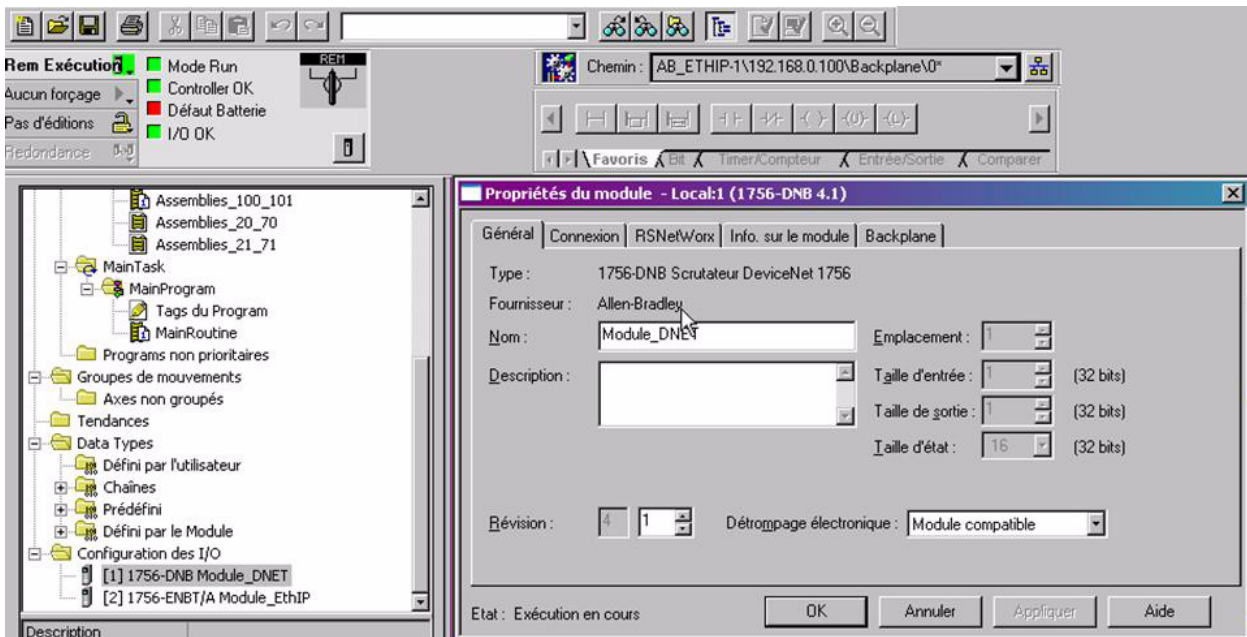

The DeviceNet module is identified with the following symbol: **Module\_DNET**. This identifier will be used later with tools like the Class Instance Editor.

## Configuring the implicit exchanges

The ATV312 allows the use of 3 assemblies set as described in the chapter "Configuring by the drive HMI", page 16. In the 3 cases, the input size and the output size are the same. (Command word and speed reference = 4 bytes, status word and actual speed = 4 bytes)

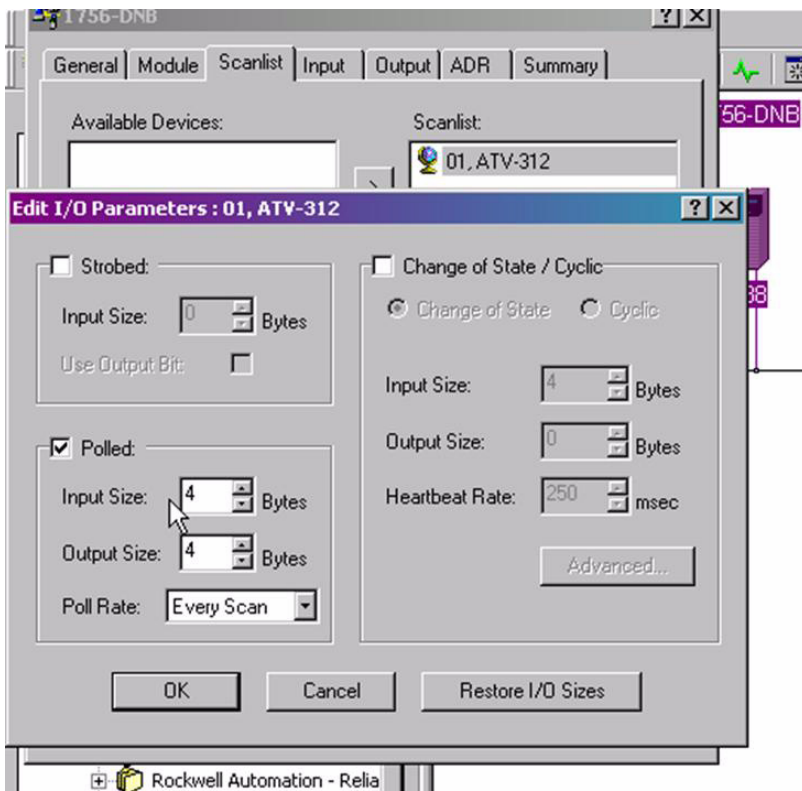



# Integration of the ATV312 in a DeviceNet network

## Class Instance Editor

With the Class Instance Editor, you can directly access to the Device objects and use the methods Get/set to edit drive parameters. The indication about the Class, Instance, Attribute of the ATV 312 objects is detailed in the chapter "Supported CIP objects" of this manual, page [28](#).

The screenshot displays the Class Instance Editor software interface. On the left, a 'Hardware' tree lists various device classes, including 'Vendor' and 'Rockwell Automation' products. The main workspace shows a network diagram with two nodes, 'ATV-312' and '1756-DNB', connected to a central bus. A 'Class Instance Editor - [Node 1]' dialog box is open, showing configuration options for a transaction. The 'Execute Transaction Arguments' section includes a 'Service Code' dropdown set to 'Get Single Attribute', an 'Object Address' table with Class, Instance, and Attribute values all set to 1, and a checked 'Send the attribute ID' option. The 'Receive Data' section shows 'Output size format' set to 'Byte' and 'Output radix format' set to 'Hexadecimal'. A 'Messages' window at the bottom shows a log entry: 'DNET:0101 4/08/2009 10:25:22 Mode changed to online. The online path is W\FR63983D\IAB\_ETHIP-1\192.168.0.100\Backplane\1\A.' The status bar at the bottom indicates 'Ready' and 'Online - Not Browsing'.

Message Code	Date	Description
DNET:0101	4/08/2009 10:25:22	Mode changed to online. The online path is W\FR63983D\IAB_ETHIP-1\192.168.0.100\Backplane\1\A.

# Integration of the ATV312 in a DeviceNet network

## Assembly selection

The choice of the assembly set should be done from the PLC, by applying the required assembly number to the following objects:

- Output assembly: 5/0/64
- Input assembly: 5/0/65

The default setting of these assemblies is 21/71.

It is recommended to set by program (when PLC starts) the assemblies needed for the application.

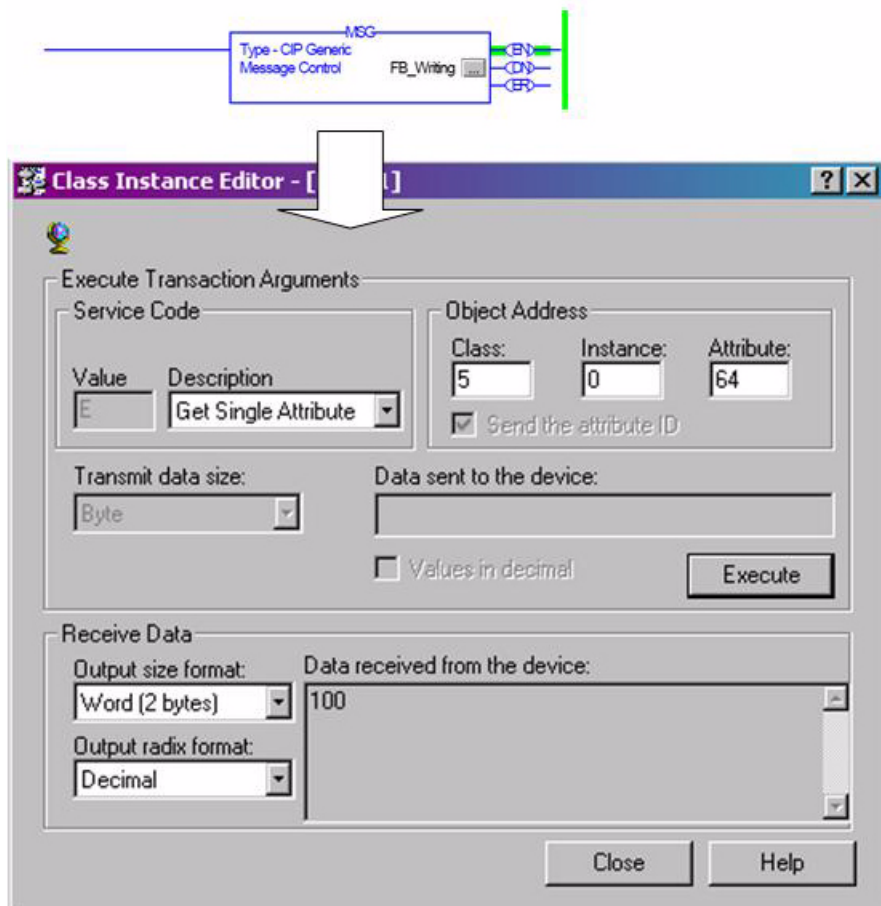

# Diagnostics by the drive HMI

## Signalling LEDs

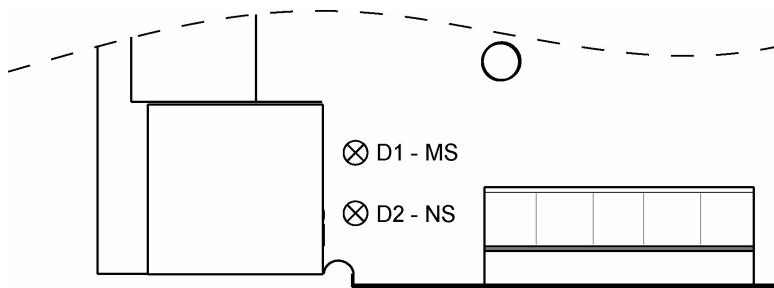

Two LED indicators are placed on the board.  
The behaviour is described in the following chapter.

### LED "D1 - MS" - Module Status

LED State	Indicates
Off	No power
<b>Flashing Green</b> (1 Hz)	Needs commissioning due to configuration missing, incomplete or incorrect. Device may be in standby state. See the identity object.
Green	Operating in normal condition
Red	Unrecoverable detected fault(s), EXCEPTION, Fatal event

### LED "D2 - NS" - Network Status

LED State	Indicates
Off	Not online / No power
<b>Flashing Green</b> (1 Hz)	On-line, no connections established
Green	On-line, one or more connections are established
<b>Flashing Red</b> (1 Hz)	One or more connections timed-out
Red	Critical link failure, Fatal event

### Start-up sequence

A LED test is performed during start-up, after module init is complete.

Step	Module Status LED "D1 - MS"	Network Status LED "D2 - NS"
1	0.25s  0.25s	Turned off
2	0.25s	0.25s  0.25s
3	0.25s	Turned off
Finished	Standard indication	Standard indication

### LED states

LED state	Visual description of the LED state
	The LED is <b>OFF</b>
	The LED is <b>FLASHING</b>
	The LED is <b>ON</b>

# Supervision and control in LINE mode

## IEC 61800-7 status chart

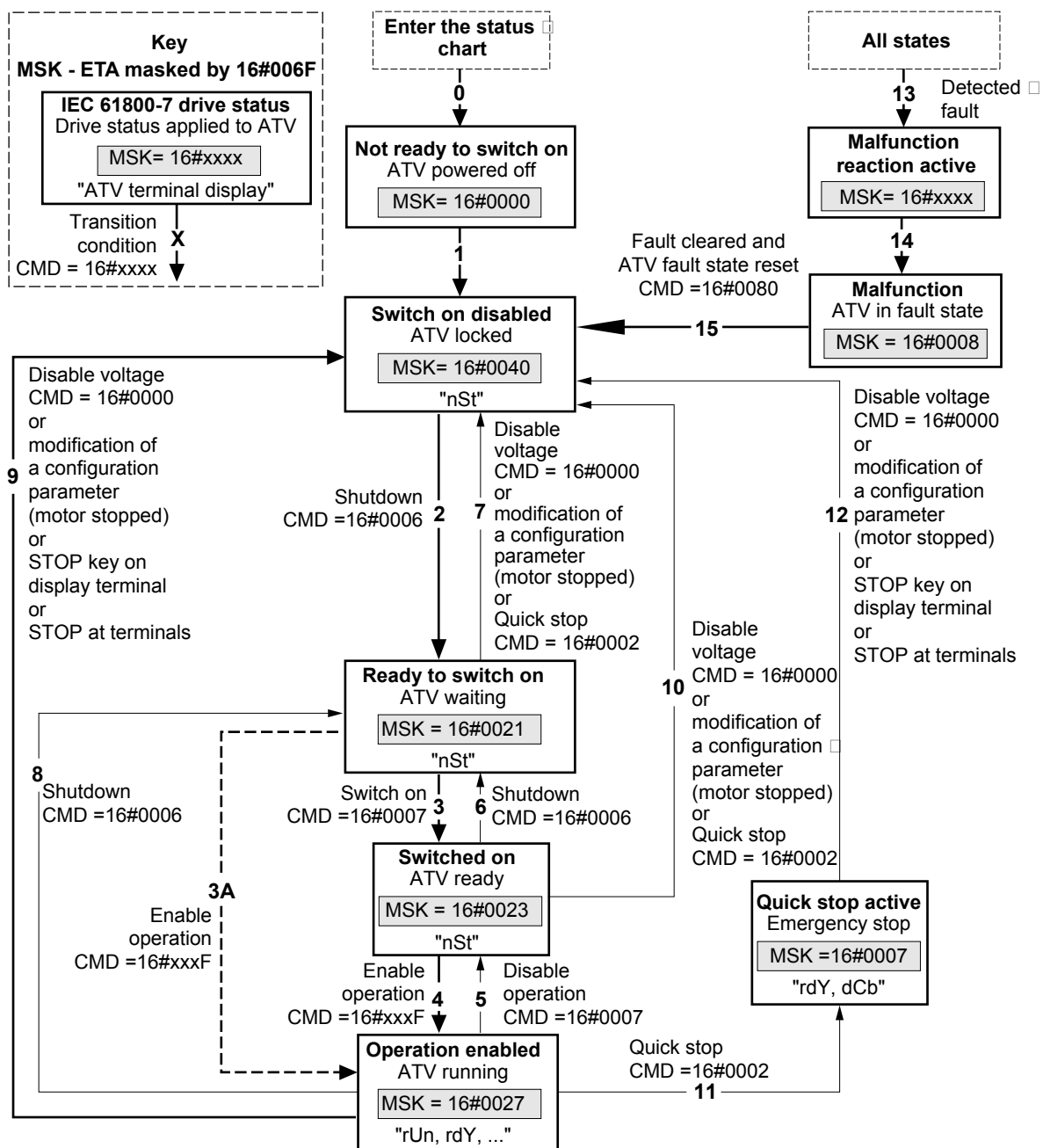

<b>Examples:</b> ETA = 16#0627 : Normal stop or □ Forward operation, speed reached ETA = 16#8627 : Reverse operation, speed reached ETA = 16#0227 : Forward operation, ACC or DEC ETA = 16#8227 : Reverse operation, ACC or DEC	<b>Examples (default configuration):</b> CMD = 16#000F : Forward operation CMD = 16#080F : Reverse operation CMD = 16#100F : Stop (configured by "Stt") CMD = 16#200F : DC injection stop CMD = 16#400F : Fast stop
--	--

Exiting the "Operation enabled" status via a "Disable voltage" (9) or "Shutdown" (8) command causes a freewheel stop.

# Supervision and control in LINE mode

---

The Altivar control process using the communication bus is based on the CiA 402 profile status chart compatible with the IEC 61800-7 standard. Each state represents an aspect of the internal behaviour of the drive.

This chart evolves according to whether the control word is sent (CMD W8501) or an event occurs (example: lock following malfunction). The drive status can be identified by the value of the status word (ETA W3201).

## **Not ready to switch on** (Initialization):

Communication is being initialized.  
Transient state invisible to the communication bus.

## **Switch on disabled** (Configuration):

Initialization of the drive is complete.  
The configuration and adjustment parameters can be modified.  
If all or part of the configuration and settings are to be loaded, we recommend disabling the consistency check function during the transfer (CMI W8504, bit 15 = 1). On completion of the transfer, the consistency check must be enabled (CMI W8504, bit 15 = 0).  
The drive is locked.

## **Ready to switch on and Switched on** (Drive initialized):

The drive is locked.  
The power stage of the drive is ready to operate, but voltage has not yet been applied to the output.  
The configuration and adjustment parameters can be modified, but modifying a configuration parameter returns the drive to the "Switch on disabled" state.

## **Operation enabled** (Operational):

The drive is unlocked and voltage can be applied to the motor terminals.  
[\[Auto tuning\] \(tUn\)](#) requires an injection of current. The drive must therefore be in this state to perform this command.  
The adjustment parameters can be modified even if a run command or a DC injection current is present. However, a configuration parameter can only be modified if the motor is stopped, and this returns the drive to the "Switch on disabled" state.

## **Quick stop active** (Emergency stop active):

Fast stop  
Restarting is only possible after the drive has changed to the "Switch on disabled" state.

## **Malfunction reaction active** (Reaction on fault detection):

Transient state during which the drive performs an action appropriate to the type of detected fault.

## **Malfunction** (Detected fault):

The drive is locked.

## **Difference between a fast stop and a Quick stop**

A fast stop (CMD = 16#400F) is a stop on a short ramp that maintains the drive in the "Operation enabled" state.  
The drive remains locked after a fast stop.  
A run command can be executed immediately after a fast stop.

A Quick stop (CMD = 16#0002) is an emergency stop that causes a stop on a short ramp followed by locking in the "Quick stop active" state.  
To be able to restart the drive, you must first change to the "Switch on disabled" state via the "Disable voltage" command (CMD = 16#0000).  
It is not possible, therefore, to execute a run command immediately after a Quick stop.

### **Note:**

In access level L1 or L2 (parameter LAC):

- Priorities between channels are managed by the drive.
- At switch-on, the drive is in control via the terminals and changes automatically to the "Operation enabled" state. This means that, when a run command is applied (for example: CMD = 16#000F), it starts without needing to follow the IEC 61800-7 status chart procedure.

When the drive is controlled via a communication bus, it is advisable to configure the access level LAC = L3:

- The active channel is set by configuring the following parameters: [\[Profile\] \(CHCF\)](#), [\[Ref. 2 switching\] \(rFC\)](#), [\[Cmd switching\] \(CCS\)](#), [\[Cmd channel 1\] \(Cd1\)](#), [\[Cmd channel 2\] \(Cd2\)](#), [\[Ref. 1 channel\] \(Fr1\)](#) and [\[Ref. 2 channel\] \(Fr2\)](#).
- At switch-on, the drive configured for control via the bus changes to the "Switch on disabled" state. This means that it must follow the IEC 61800-7 status chart procedure to be able to start, and to help prevent any unwanted behaviour.

# Supervision and control in LINE mode

## CMD control word (W8501)

bit 7	bit 6	bit 5	bit 4	bit 3	bit 2	bit 1	bit 0
Fault state reset	0	0	0	Enable operation	Quick stop (active at 0)	Enable voltage	Switch on
bit 15	bit 14	bit 13	bit 12	bit 11	bit 10	bit 9	bit 8
(1)	(1)	(1)	(1)	(1)	0	0	0

(1) This bit action depends on the [\[ACCESS LEVEL\] \(LAC\)](#) parameter and the functions configured by the user. For example, to use bit 15 to switch the ramp, simply configure LAC = L3 (Access to advanced functions and management of mixed modes) and set the [\[Ramp switch ass.\] \(rPS\)](#) configuration parameter to Cd15.

Command	Transition address	Final state	bit 7	bit 3	bit 2	bit 1	bit 0	Typical value of CMD (W8501)
			Reset	Enable operation	Quick stop	Enable voltage	Switch on	
Shut down	2, 6, 8	Ready to switch on	x	x	1	1	0	16#0006
Switch on	3	Switched on	x	x	1	1	1	16#0007
Enable operation	4	Operation enabled	x	1	1	1	1	16#000F
Disable operation	5	Switched on	x	0	1	1	1	16#0007
Disable voltage	7, 9, 10, 12	Switch on disabled	x	x	x	0	x	16#0000
Quick stop	11	Quick stop active	x	x	0	1	x	16#0002
	7, 10	Switch on disabled						
Fault state reset	15	Switch on disabled	0 → 1	x	x	x	x	16#0080

x: State not significant  
 0 → 1: Change from 0 to 1

# Supervision and control in LINE mode

## ETA status word (W3201)

bit 7	bit 6	bit 5	bit 4
Alarm	Switch on disabled	Quick stop active at 0	0

bit 3	bit 2	bit 1	bit 0
Malfunction	Operation enabled	Switched on	Ready to switch on

bit 15	bit 14	bit 13	bit 12
Direction of rotation	Stop via STOP key	0	0

bit 11	bit 10	bit 9	bit 8
Reference exceeded	Reference reached	Forced local mode (active at 0)	0

State	bit 6	bit 5	bit 3	bit 2	bit 1	bit 0	MSK = ETA (W3201) masked by 16#006F
	Switch on disabled	Quick stop	Malfunction	Operation enabled	Switched on	Ready to switch on	
Not ready to switch on	0	x	0	0	0	0	16#0000 16#0020
Switch on disabled	1	x	0	0	0	0	16#0040 16#0060
Ready to switch on	0	1	0	0	0	1	16#0021
Switched on	0	1	0	0	1	1	16#0023
Operation enabled	0	1	0	1	1	1	16#0027
Malfunction	0	x	1	0	0	0	16#0008 16#0028
Malfunction reaction active	0	x	1	1	1	1	16#000F 16#002F
Quick stop active	0	0	0	1	1	1	16#0007

x: State not significant

# Supported CIP objects

CIP require some mandatory objects; these are implemented as well as some vendor specific objects.

## Standard CIP objects

Object name	Class	Description
Identity object	0x01	The identification object
Message router object	0x02	Message router
DeviceNet object	0x03	DeviceNet object
Assembly object	0x04	Assembly object
Connection object	0x05	Connection object
Motor data object	0x28	Defines motor data for the motor connected to this device
Control supervisor object	0x29	Manages drive functions, operational states and control
AC/DC drive object	0x2A	Provides drive configuration
Acknowledge handler object	0x2B	Object that acknowledges IO messages

## Schneider Electric objects

Object name	Class	Description
Application objects	0x70	Object used to access ATV312 parameters

## DeviceNet Object model

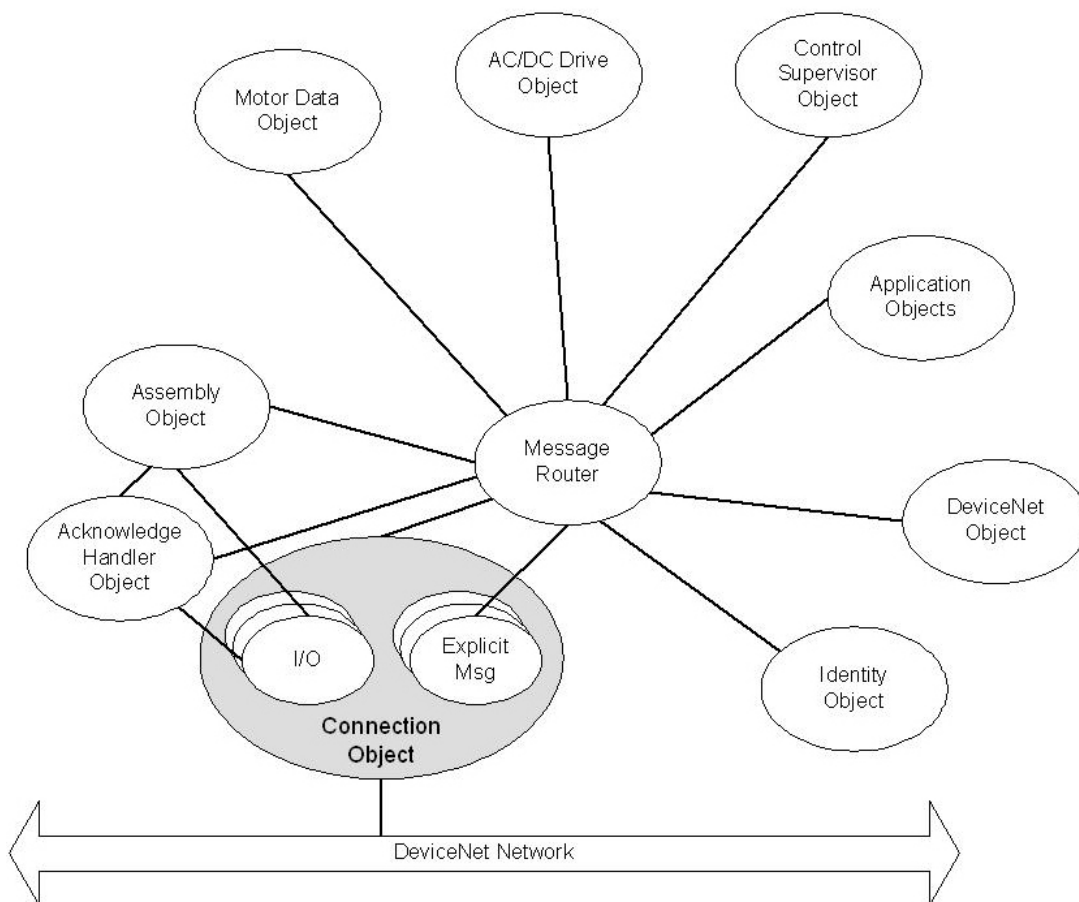



# Supported CIP objects

## Identity object (Class 0x01)

### Services

Class services	Get_Attribute_Single
Instance services	Get_Attribute_Single Reset

### Class attributes

#	Access	Name	Type	Value	Description
1	Get	Revision	UINT	0x0001	Revision 1

### Instance attributes

#	Access	Name	Type	Value	Description
1	Get	Vendor ID	UINT	0x00F3	
2	Get	Device type	UINT	0x0002	AC Drive: <ul style="list-style-type: none"><li>• Vendor Name: Schneider Electric</li><li>• Vendor ID: 0x00F3</li><li>• Product code: 0XXXXX</li><li>• Product Name: ATV-312</li><li>• Catalog: ATV-312</li><li>• EDS file name: 00F30002XXXX0100.EDS</li></ul>
3	Get	Product code	UINT	6153	
4	Get	Revision	Struct of:		
		Major revision	USINT	N/A	Firmware major version
		Minor revision	USINT	N/A	Firmware minor version
5	Get	Status	WORD	-	Status of the device, see table below.
6	Get	Serial number	UDINT	Serial number	The low 4 bytes of the drive serial number
7	Get	Product name	SHORT_STRING	ATV312	
100	Get	Fatal log	Array of UINT8	N/A	

# Supported CIP objects

Bit	Status attribute
Bit 0	Owned, shall be set when at least one connection is configured
Bit 1	Reserved, set to 0
Bit 2	Configured (1)
Bit 3	Reserved, set to 0
Bit 4-7	See extended device status
Bit 8	Is set for minor recoverable faults (2)
Bit 9	Is set for minor unrecoverable faults (2)
Bit 10	Is set for major recoverable faults (2)
Bit 11	Is set for major unrecoverable faults (2)
Bit 12-15	Reserved, set to 0

Extended device status (Bit 4-7)
0000 = Unknown
0010 = Faulted I/O connection
0011 = No I/O connection established
0100 = Non volatile configuration bad
0101 = Major Fault
0110 = Connection in run mode
0111 = Connection in idle mode

(1) This bit shows if the product has other settings than "out-of box". The value is set to true if the module's NV storage is changed from default and the value is currently in use.

(2) See error codes table below.

## Error codes

Fault type	Fault source
Minor Recoverable Faults	Duplicate MACID, Switch value changed
Minor Unrecoverable Faults	
Major Recoverable Faults	Non-Volatile Fault (CRC-error on read), Faulted, Connection to ATV312 lost
Major Unrecoverable Faults	Non-Volatile Fault (CRC-error on write)

# Supported CIP objects

---

## Message router (Class 0x02)

### Services

Class services	No class services supported
Instance services	No instance services supported

### Class attributes

No supported class attributes

### Instance attributes

No supported instance attributes

# Supported CIP objects

## DeviceNet object (Class 0x03)

### Services

Class services	Get_Attribute_Single
Instance services	Get_Attribute_Single Set_Attribute_Single Allocate_Master/Slave_Connection_Set (0x4B) Release_group_2_Identifier_Set (0x4C)

### Class attributes

#	Access	Name	Type	Value	Description
1	Get	Revision	UINT	0x0002	Revision 2

### Instance attributes

#	Access	Name	Type	Value	Description
1	Get	MAC ID	USINT	N/A	The used node address 0-63
2	Get	Baud Rate	USINT	N/A	The used baud rate: 0 = 125 k baud 1 = 250 k baud 2 = 500 k baud
3	Get/Set	BOI	BOOL	N/A	Bus off interrupt, default = FALSE
4	Get/Set	Bus off Counter	USINT	N/A	Bus off counter
5	Get	Allocation Information	Struct of:		
		Allocation choice byte	BYTE	N/A	Allocation choice byte
		Master's MAC ID	USINT	N/A	MAC ID of master
6	Get	MAC ID Switch Changed	BOOL	N/A	0 - No change 1 - The Node Address switch have changed since last power-up/reset
7	Get	Baud Rate Switch Changed	BOOL	N/A	0 - No change 1 - The Baud Rate switch have changed since last power-up/reset
8	Get	Mac ID Switch Value	USINT	N/A	Actual value of Node Address switch 0-63
9	Get	Baud Rate Switch Value	USINT	N/A	Actual value of Baud Rate switch 0-3
10	Get/Set	Quick Connect	BOOL	0 = Disable 1 = Enable	Enable/Disable of Quick Connect feature. Disabled by default. Stored in NVRAM.

# Supported CIP objects

## Assembly object (Class 0x04)

The Assembly object uses static assemblies. The default assembly instance IDs used are in the vendor specific range. The assembly object contains the process data to/from the module.

### Services

Class services	Get_Attribute_Single
Instance services	Get_Attribute_Single Set_Attribute_Single

### Class attributes

#	Access	Name	Type	Value	Description
1	Get	Revision	UINT	2	Revision 2
2	Get	Max Instance	UINT	101	Max instance 101

### Instance attributes

#	Access	Name	Type	Value	Description
3	Get/Set	Data	ARRAY of BYTE	-	Data produced/consumed by the module

### Consuming instances (Output assemblies)

Write requests are rejected if there's an I/O connection against the instance.

#### Instance 20 - Basic speed control output

Byte	Bit 7	Bit 6	Bit 5	Bit 4	Bit 3	Bit 2	Bit 1	Bit 0
0						Fault reset		Run fwd
1								
2	Speed reference (Low byte)							
3	Speed reference (High byte)							

#### Instance 21 - Extended speed control output

Byte	Bit 7	Bit 6	Bit 5	Bit 4	Bit 3	Bit 2	Bit 1	Bit 0
0		NetRef	NetCtrl			Fault reset	Run rev	Run fwd
1								
2	Speed reference (Low byte)							
3	Speed reference (High byte)							

#### Instance 100 - Transparent output

Byte	Bit 7	Bit 6	Bit 5	Bit 4	Bit 3	Bit 2	Bit 1	Bit 0
0	DRIVECOM control word (ATV: 6040) (Low Byte)							
1	DRIVECOM control word (ATV: 6040) (High Byte)							
2	Reference speed (ATV:6042) (Low Byte)							
3	Reference speed (ATV:6042) (High Byte)							

# Supported CIP objects

## Producing instances (Input assemblies)

### Instance 70 - Basic speed control input

Byte	Bit 7	Bit 6	Bit 5	Bit 4	Bit 3	Bit 2	Bit 1	Bit 0
0						Running1		Faulted
1								
2	Speed actual (Low byte)							
3	Speed actual (High byte)							

### Instance 71 - Extended speed control input

Byte	Bit 7	Bit 6	Bit 5	Bit 4	Bit 3	Bit 2	Bit 1	Bit 0
0	At reference	Ref from net	Ctrl from net	Ready	Running2 (Rev)	Running1 (Fwd)	Warning	Faulted
1	Drive state							
2	Speed actual (Low byte)							
3	Speed actual (High byte)							

### Instance 101 - Transparent input

Byte	Bit 7	Bit 6	Bit 5	Bit 4	Bit 3	Bit 2	Bit 1	Bit 0
0	DRIVECOM status word (ATV: 6041) (Low Byte)							
1	DRIVECOM status word (ATV: 6041) (High Byte)							
2	Output speed (ATV: 6044) (Low Byte)							
3	Output speed (ATV: 6044) (High Byte)							

# Supported CIP objects

---

## Data definitions output assemblies

Name	Class	Instance	Attribute	Description
Run rev	Control Supervisor	1	4	
Run fwd	Control Supervisor	1	3	
Fault reset	Control Supervisor	1	12	
Speed reference	AC/DC Drive	1	8	
NetCtrl	Control Supervisor	1	5	
NetRef	AC/DC Drive	1	4	

## Data definitions input assemblies

Name	Class	Instance	Attribute	Description
Faulted	Control Supervisor	1	10	
Warning	Control Supervisor	1	11	
Running1 (Fwd)	Control Supervisor	1	7	
Running2 (Rev)	Control Supervisor	1	8	
Ready	Control Supervisor	1	9	
Ctrl from net	Control Supervisor	1	15	
Ref from net	AC/DC Drive	1	29	
At reference	AC/DC Drive	1	3	
Drive state	Control Supervisor	1	6	CIP state machine state
Speed actual	AC/DC Drive	1	7	

# Supported CIP objects

---

## Connection object (Class 0x05)

### Services

Class services	Get_Attribute_Single Set_Attribute_Single
Instance services	Get_Attribute_Single Set_Attribute_Single

### Class attributes

#	Access	Name	Type	Value	Description
1	Get	Revision	UINT	0x0001	Revision 1
100	Get/Set	Polled/ COS/ Cyclic Consuming Instance	UINT	20, 21, 100	Default value is assembly instance 21. For a change to this attribute will require a restart of the ATV-312-DEV to have effect. (When read the stored value is returned). Stored in NVRAM.
101	Get/Set	Polled/ COS/ Cyclic Producing Instance	UINT	70, 71, 101	Default value is assembly instance 71. For a change to this attribute will require a restart of the ATV-312-DEV to have effect. (When read the stored value is returned). Stored in NVRAM.

### Instance descriptions

Instance 1 = Explicit messaging connection (Predefined in DeviceNet object)

Instance 2 = Polled connection / COS/Cyclic consuming connection

Instance 4 = COS/Cyclic producing connection

Instances 10-14 = Explicit server instances



# Supported CIP objects

## Instances 1, 10-14 (Explicit messaging) attributes

#	Access	Name	Type	Value	Description
1	Get	State	USINT	N/A	0 = Non existent 1 = Configuring 2 = Waiting for connection ID 3 = Established 4 = Time out 5 = Deferred Delete
2	Get	Instance type	USINT	0	Explicit messaging connection
3	Get	Transport Class trigger	BYTE	0x83	Server, Transport class 3
4	Get	Produced connection ID	UINT	N/A	CAN ID for transmission
5	Get	Consumed connection ID	UINT	N/A	CAN ID for reception
6	Get	Initial Comm Characteristics	BYTE	21 (Inst 1) 33 (Inst 10-14)	The message group over which the communication occurs.
7	Get	Produced Connection Size	UINT	0x0040	64 Bytes
8	Get	Consumed Connection Size	UINT	0x0040	64 Bytes
9	Get/Set	Expected Packet Rate	UINT	0x09C8	Timing associated with this connection (2504ms)
12	Get/Set (1)	Watchdog timeout action	USINT	1	1 = Auto delete 3 = Deferred delete
13	Get	Produced Connection path length	UINT	0	Number of bytes in the produced connection path attribute
14	Get	Produced Connection path	EPATH	No value	No connection path
15	Get	Consumed Connection path length	UINT	0	Number of bytes in the consumed connection path attribute
16	Get	Consumed Connection path	EPATH	No value	No connection path
17	Get	Production Inhibit Time	UINT	0	Minimum time between new data production
18	Get/Set	Connection Timeout Multiplier	USINT	0	Specifies the multiplier applied to the expected packet rate value to derive the value for the Inactivity/ Watchdog Timer. 0 = x4 1 = x8 2 = x16 3 = x32 4 = x64 5 = x128 6 = x256 7 = x512 8 - 255 = Reserved

(1) Only settable for instance 1

## Supported CIP objects

### Instance 2 (Poll or "COS/Cyclic consuming") attributes

#	Access	Name	Type	Value	Description
1	Get	State	USINT	N/A	0 = Non existent 1 = Configuring 2 = Waiting for connection ID 3 = Established 4 = Time out
2	Get	Instance type	USINT	1	IO Connection
3	Get	Transport Class trigger	BYTE	0x82	Server, Polled, Class 2
				0x80	Server, COS/Cyclic, Class 0, No Ack
				0x82	Server, COS/Cyclic, Class 2 Acknowledged
4	Get	Produced connection ID	UINT	N/A	CAN ID for transmission
				0xFFFF	Not consuming (COS/Cyclic)
5	Get	Consumed connection ID	UINT	N/A	CAN ID for reception (Polled)
6	Get	Initial Comm Characteristics	BYTE	0x01 (Polled)	Produces over message group 1 Consumes over message group 2
				0xF1 (COS/Cyclic, No Ack)	Consuming only over message group 2
				0x01 (COS/Cyclic, Ack)	Produces over message group 1 (Ack) Consumes over message group 2
7	Get	Produced Connection Size	UINT	N/A	Size of produced data/mapped process data. (Polled)
				0	COS/Cyclic
8	Get	Consumed Connection Size	UINT	N/A	Size of consumed data/mapped process data
9	Get/Set	Expected Packet Rate	UINT	N/A	Timing associated with this connection
12	Get	Watchdog timeout action	USINT	0	0 = Transition to the timed out state
13	Get	Produced Connection path length	UINT	0x0007 (Polled)	Number of bytes in the produced connection path attribute
				0x0000 (COS/Cyclic)	
14	Get	Produced Connection path	EPATH	0x20 0x04 0x25 0x11 0x11 0x30 0x03 (Polled)	Path to producing object 11 = Producing instance number in assembly object
				No value (COS/Cyclic)	No producing object
15	Get	Consumed Connection path length	UINT	0x0007	Number of bytes in the consumed connection path attribute
16	Get	Consumed Connection path	EPATH	0x20 0x04 0x25 0x11 0x11 0x30 0x03	Path to consuming object 11 = Consuming instance number in assembly object
17	Get	Production Inhibit Time	UINT	0	Minimum time between new data production

## Supported CIP objects

---

#	Access	Name	Type	Value	Description
18	Get/Set	Connection Timeout Multiplier	USINT	0	Specifies the multiplier applied to the expected packet rate value to derive the value for the Inactivity/ Watchdog Timer. 0 = x4 1 = x8 2 = x16 3 = x32 4 = x64 5 = x128 6 = x256 7 = x512 8 - 255 = Reserved

# Supported CIP objects

## Instance 4 (COS/Cyclic producing) attributes

#	Access	Name	Type	Value	Description
1	Get	State	USINT	N/A	0 = Non existent 1 = Configuring 2 = Waiting for connection ID 3 = Established 4 = Time out
2	Get	Instance type	USINT	1	IO Connection
3	Get	Transport Class trigger	BYTE	0x00	Client, Cyclic, Class 0 (No Ack)
				0x10	Client, COS, Class 0 (No Ack)
				0x02	Client, Cyclic, Class 2 (Acknowledged)
				0x12	Client, COS, Class 2 (Acknowledged)
4	Get	Produced connection ID	UINT	N/A	CAN ID for transmission
5	Get	Consumed connection ID	UINT	0xFFFF	Not acknowledged
				N/A	CAN ID for reception (Acknowledged)
6	Get	Initial Comm Characteristics	BYTE	0x0F (No ACK)	Producing only over message group 1
				0x01 (Acknowledged)	Produces over message group 1 Consumes over message group 2 (Ack)
7	Get	Produced Connection Size	UINT	N/A	Size of produced data on this connection
8	Get	Consumed Connection Size	UINT	0	Consumes 0 bytes on this connection
9	Get/Set	Expected Packet Rate	UINT	N/A	Timing associated with this connection
12	Get	Watchdog timeout action	USINT	0	0 = Transition to the timed out state
13	Get	Produced Connection path length	UINT	0x0007	Number of bytes in the produced connection path attribute
14	Get	Produced Connection path	EPATH	0x20 0x04 0x25 0x11 0x11 0x30 0x03	Path to producing object 11 = Producing instance number in assembly object
15	Get	Consumed Connection path length	UINT	0x0000 (No ACK)	Number of bytes in the consumed connection path attribute
				0x0005 (Acknowledged)	
16	Get	Consumed Connection path	EPATH	No value (No ACK)	Empty
				0x20 0x2B 0x25 0x01 0x00 (Acknowledged)	Acknowledge Handler Object, Instance 1
17	Get/Set	Production Inhibit Time	UINT	0	Minimum time between new data production
18	Get/Set	Connection Timeout Multiplier	USINT	0	Specifies the multiplier applied to the expected packet rate value to derive the value for the Inactivity/ Watchdog Timer. 0 = x4 1 = x8 2 = x16 3 = x32 4 = x64 5 = x128 6 = x256 7 = x512 8 - 255 = Reserved

# Supported CIP objects

---

## Motor data object (Class 0x28)

This object serves as a database for motor parameters.

### Services

Class services	Get_Attribute_Single
Instance services	Get_Attribute_Single Set_Attribute_Single

### Class attributes

#	Access	Name	Type	Value	Description
1	Get	Revision	UINT	0x0001	Revision of the object

### Instance attributes for Schneider Electric brand

#	Access	Name	Type	Value	Description
3	Get/Set	MotorType	USINT	N/A	7 - Squirrel Cage Induction Motor
6	Get/Set	RatedCurrent	UINT	N/A	Rated Stator Current Units: [100mA]
7	Get/Set	RatedVoltage	UINT	N/A	Rated Base Voltage Units: [V]

# Supported CIP objects

## Control Supervisor Object (Class 0x29)

This object models all the management functions for devices within the "Hierarchy of Motor Control Devices". The behaviour of motor control devices is described in the State Transition Diagram and the State Event Matrix.

### Services

Class services	Get_Attribute_Single
Instance services	Get_Attribute_Single Set_Attribute_Single Reset

### Class attributes

#	Access	Name	Type	Value	Description
1	Get	Revision	UINT	0x0001	Revision of the object

### Instance attributes

#	Access	Name	Type	Value	Description
3	Get/Set	Run1	BOOL	N/A	Run forward See Run/Stop Event Triggers
4	Get/Set	Run2	BOOL	N/A	Run reverse See Run/Stop Event Triggers
5	Get/Set	NetCtrl	BOOL	N/A	Requests Run/Stop control to be local or from network. 0 = Local Control 1 = Network Control
6	Get	State	USINT	N/A	1 = Startup 2 = Not_Ready 3 = Ready 4 = Enabled 5 = Stopping 6 = Fault_Strop 7 = Faulted For ATV312 DRIVECOM status to State translation, see page <a href="#">47</a> .
7	Get	Running1	BOOL	N/A	Enabled or Stopping or Fault_Stop
8	Get	Running2	BOOL	0	Running2 is always 0 since negative speed indicated on the Actual speed reference.
9	Get	Ready	BOOL	N/A	1 = Ready or Enabled or Stopping 0 = Other state
10	Get	Faulted	BOOL	N/A	0 = No Faults present 1 = Fault Occurred (latched) <a href="#">ATV:6041#3</a>
11	Get	Warning	BOOL	N/A	0 = No Warnings present 1 = Warning (not latched)
12	Get/Set	FaultRst	BOOL	N/A	0->1 = Fault Reset 0 = No Action <a href="#">ATV:6040#7</a>
15	Get	CtrlFromNet	BOOL	N/A	Status of Run/Stop control source. 0 = Control is local 1 = Control is from network

# Supported CIP objects

## Control supervisor state diagram

The state transition diagram is specified by the drive profile. Note that the state machine shall be updated independently of if the drive is controlled locally or remote.

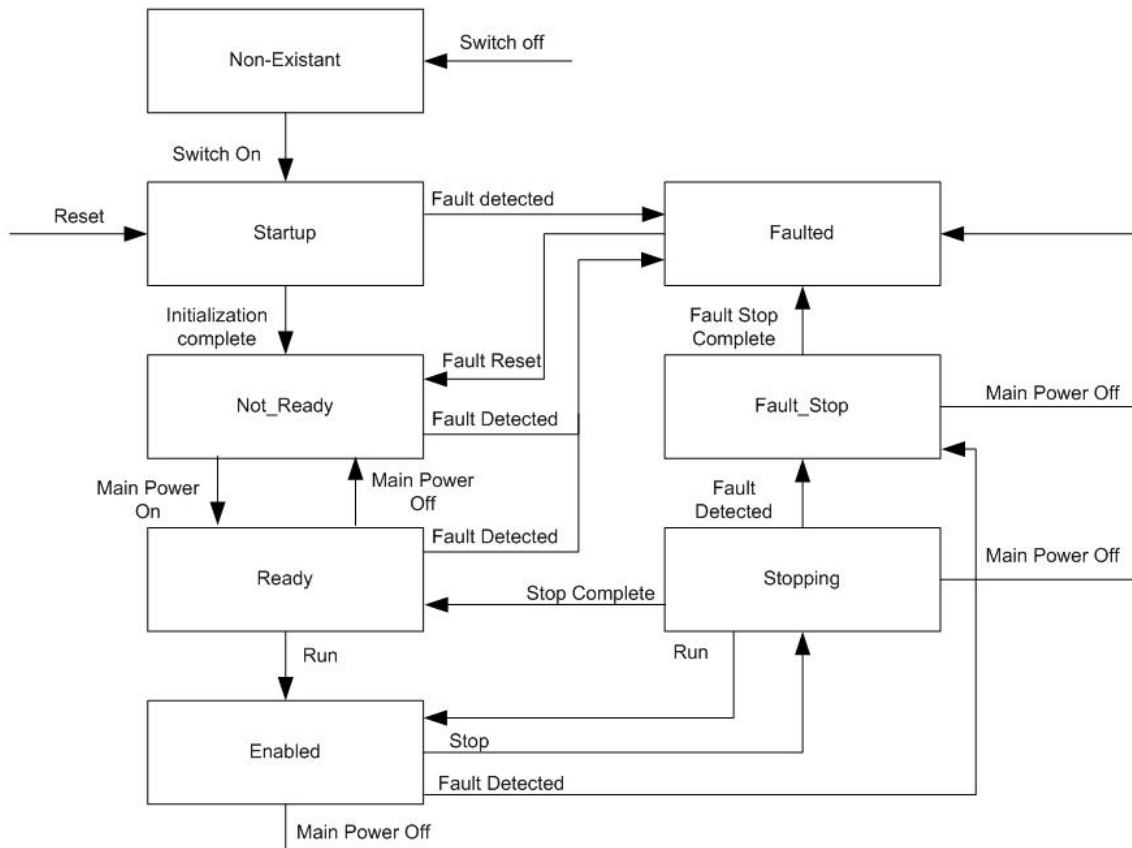

## DRIVECOM status to CS state translation

The CS state is get from ATV312 DRIVECOM status according to the table below:

CS state	DRIVECOM state	MSK (DRIVECOM status & 0x006F)
Startup	Not ready to switch on	0x0000 0x0020
Not_Ready	Switch on disabled	0x0040 0x0060
Ready	Ready to switch on	0x0021
	Switched on	0x0023
Enabled	Operation enabled	0x0027
	cmdd Bit 3 = 0	0x0027
Stopping	Quick stop active	0x0007
	Malfunction reaction active	0x000F 0x002F
Faulted	Malfunction	0x0008 0x0028

# Supported CIP objects

## Run/Stop event triggers

Run/Stop events are generated from Run1 and Run2 attributes according to the table below:

Run1	Run2	Trigger Event	Run Type	DRIVECOM command
0	0	Stop	N/A	Operation enable state Other states: Shutdown
0->1	0	Run	Run1	Enable operation
0	0->1	Run	Run2	Enable operation
0->1	0->1	No Action	N/A	Last command still valid
1	1	No Action	N/A	Last command still valid
1->0	1	Run	Run2	Enable operation Reversed speed reference
1	1->0	Run	Run1	Enable operation

The following table defines how DRIVECOM commands are generated in the DRIVECOM control word. All other bits are unaffected.

DRIVECOM command	DRIVECOM control word			
	Bit 3	Bit 2	Bit 1	Bit 0
Shutdown	0	1	1	0
Disable operation	0	1	1	1
Enable operation	1	1	1	1



# Supported CIP objects

---

## AC/DC drive object (Class 0x2A)

This object models the functions specific to an AC or DC Drive. e.g. speed ramp, torque control etc.

### Services

Class services	No services implemented
Instance services	Get_Attribute_Single Set_Attribute_Single

### Class attributes

No attributes are implemented at class level.

### Instance attributes for Schneider Electric brand

#	Access	Name	Type	Value	Description
3	Get	AtReference	BOOL	N/A	1 = Drive actual at reference <a href="#">ATV:6041#10</a>
4	Get/Set	NetRef	BOOL	N/A	Request speed reference to be local or from network. 0 = Local speed setpoint 1 = Network speed setpoint
6	Get	DriveMode	USINT	0	0 = Vendor specific mode
7	Get	SpeedActual	INT	N/A	Actual drive speed Units: RPM <a href="#">ATV:6044</a> [RPM]
8	Get/Set	SpeedRef	INT	N/A	Speed reference Units: RPM <a href="#">ATV:6042</a> [RPM]
29	Get	RefFromNet	BOOL	N/A	Status of speed reference. 0 = Local speed reference 1 = Network speed reference

# Supported CIP objects

---

## Acknowledge handler object (Class 0x2B)

### Services

Class services	Get_Attribute_Single
Instance services	Get_Attribute_Single Set_Attribute_Single

### Class attributes

#	Access	Name	Type	Value	Description
1	Get	Revision	UINT	0x0001	Revision of the object

### Instance 1 attributes

#	Access	Name	Type	Value	Description
1	Get/Set	Acknowledge Timer	UINT	16	Time to wait for acknowledge (in ms) before resending
2	Get/Set	Retry Limit	USINT	1	Number of Ack timeouts before retry limit reached event
3	Get	Producing connection Instance	UINT	4	Connection instance, which contains the path of the producing I/O application object, which will be notified of Ack Handler events.

# Supported CIP objects

---

## Application objects (Class 0x70)

This object allows access to all parameters in the ATV-312 by converting CANopen Index and Sub-index to CIP instance and attributes. The CANopen Index and Sub-index are linearly mapped to CIP instance and attribute. CIP Get\_Attribute\_Single service is converted to the CANopen request code 0x40 and the Set\_Attribute\_Single service the CANopen request code 0x2B.

### Services

Class services	Get_Attribute_Single
Instance services	Get_Attribute_Single Set_Attribute_Single

### Class attributes

#	Access	Name	Type	Value	Description
1	Get	Revision	UINT	0x0001	Revision of the object

### Instance attributes

#	Access	Name	Type	Value	Description
1	Get/Set	Parameter with Sub-index 0	N/A	N/A	
...	...	...	...	...	...
N	Get/Set	Parameter with Sub-index N	N/A	N/A	





