

# Machine Etruxure™

## Preventa solutions for efficient machine safety

Catalog

April 2015



# How can you fit a 6000-page catalog in your pocket ?

Schneider Electric provides you with the complete set of industrial automation catalogs all on a handy USB key for PC or in an application for tablets



## Digi-Cat, a handy USB key for PC



- > Convenient to carry
- > Always up-to-date
- > Environmentally friendly
- > Easy-to-share format

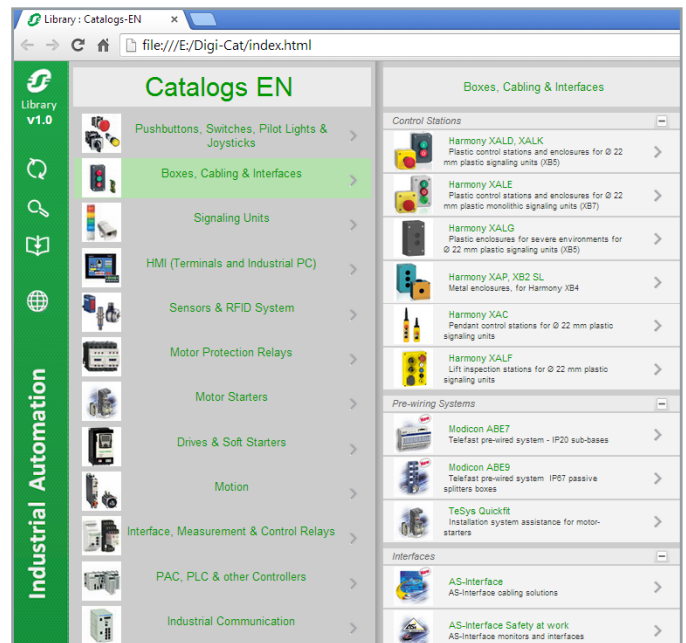

Contact your local representative to get your own Digi-Cat



## e-Library, the app for tablets

If you have an iPad®:

- > Go to the App Store and search for e-Library
- > or scan the QR code



If you have an Android tablet:

- > Go to the Google Play Store™ and search for eLibrary
- > or scan the QR code



---

General presentation .....

1

Safety chain solution, Safety functions ....

2

Safety products .....

3

# Chapter 1

# General presentation



Technical information on products listed in this catalog is  
available at: [www.schneider-electric.com](http://www.schneider-electric.com)

- **Schneider Electric Safety Approach**
  - Product Approach ..... page 1/2
  - Solution Approach ..... page 1/3
- **Services we provide**
  - Machine Solutions Services & Support ..... page 1/4
  - Schneider Electric Library for SISTEMA ..... page 1/5
- **Safety Legislation and Standards**
  - Industrial accidents ..... page 1/6
  - European legislation ..... page 1/7
  - Certification and CE marking ..... page 1/8
  - Standards ..... page 1/10
  - Standards to be applied
    - > The process ..... page 1/11
    - > Standard to be applied according to the design selected for the safety-related machine control system ..... page 1/11
  - Risk and Safety ..... page 1/12
  - Risk Assessment
    - > Assessment of machinery related risk ..... page 1/13
    - > Risk estimation ..... page 1/14
  - How to choose between EN/ISO 13849 and EN/IEC 62061 ..... page 1/15
  - Standard EN/ISO 13849-1 ..... page 1/16
  - Standard EN/IEC 62061 ..... page 1/20

Product Approach

Schneider Electric Safety Approach

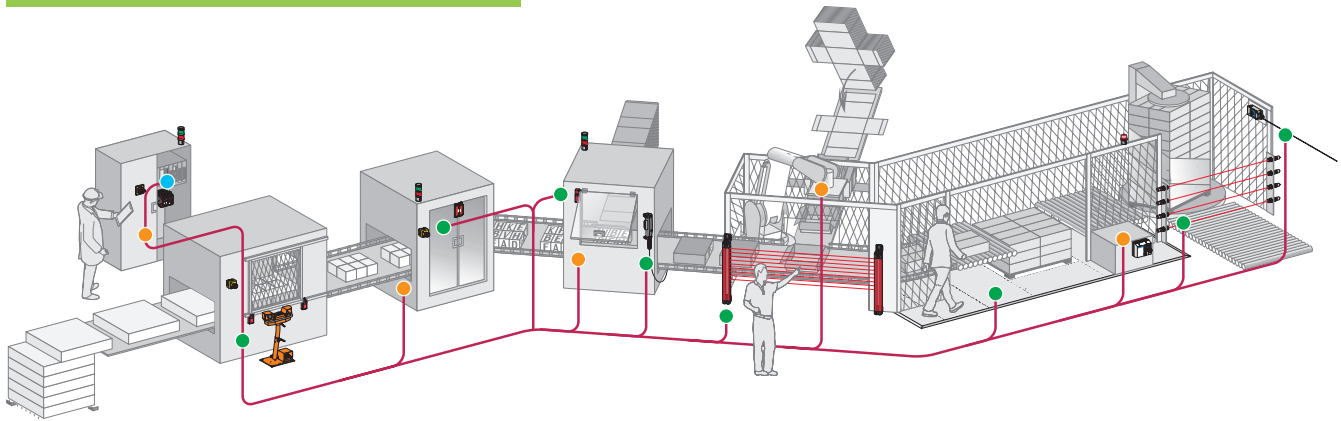

**Schneider Electric is one provider of the complete safety chain.**

In addition to moral obligation and economic consequences, the law requires that machinery operates safely in the interests of accident prevention. Preventa offers an extensive range of safety products, compliant with international standards, designed to provide the most comprehensive protection for personnel and equipment.

**Acquire the information**

- > Generic protective measures - Emergency stop
- > Two hand control stations and enabling switches for starting and enabling of dangerous movements
- > Protective guard devices used as part of safeguarding systems to control the access under specific conditions of reduced risk
- > Light curtains to detect approach to dangerous and limited areas

**Monitor and processing**

- > Safety modules manage one safety function, monitoring inputs from safety devices and managing the outputs to contactors and drives
- > Safety controllers: configurable safety device capable of managing multiple safety functions simultaneously
- > Safety PLCs: programmable electronic systems for complex distributed safety applications

**Stop the machine**

- > Contactors to cut-off the electrical power supply to the motors with mechanically linked mirror auxiliary contacts integrated for the feedback loop diagnosis used by the safety modules, controller and PLCs
- > Variable speed drives and servo drives provide controlled stopping of the machine by using embedded safety functions
- > Rotary switch disconnectors: for equipment isolation from the electrical supply and for emergency stop by direct interruption of the power supply

### Solution Approach

### Schneider Electric Safety Approach

#### One provider for the complete safety chain

- > Emergency stop
- > Perimeter guarding
- > Guard monitoring
- > Enabling movement
- > Speed monitoring
- > Position monitoring

The Safety Chain Solutions are TÜV certified safety architectures based upon the most common safety functions required on and around a machine. The safety chain solutions enable you to save time and costs when designing and manufacturing your machine in accordance with the European Machinery Directive.

#### Each solution comes with:

- > Bill of materials and the system description file
- > Wiring diagram
- > Layout of solution indicating performance level (PL) and safety integrity level (SIL)
- > Description of the Performance Level and Safety Integrity Level calculation for the safety function
- > Sistema Library file with corresponding solution
- > TÜV certification

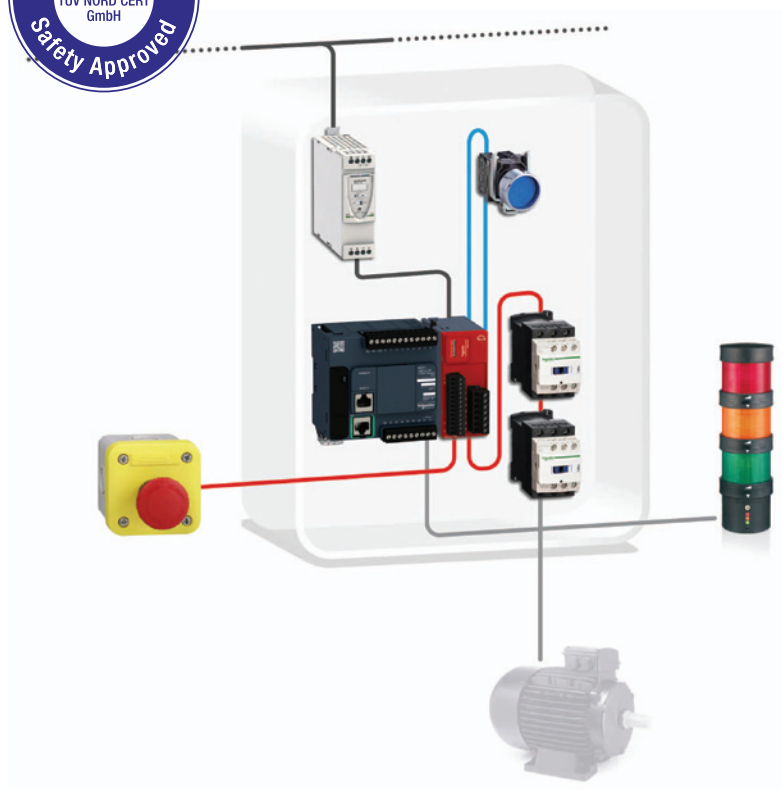

1

### Machine Solutions Services & Support

### Service and support that are behind you all the way

#### Design



#### We find the best solution for your needs

- > Based on your needs, System and Architecture Experts and Application Design Experts (SAE/ADE) work out innovative technical solutions including
  - > Co-engineering
  - > Tests
  - > Validation

#### We understand your pain points

- > Consulting

#### We execute the solution with a full service agreement

- > Our solution design and project centers (Flex-Centres) are committed to quality and results and provide:
  - > Project and program management
  - > Software and hardware engineering
  - > Tests, validation, and commissioning

#### We improve your team's competencies

- > In class training and on site training

#### Build



#### We ensure the delivery of your solution

- > Availability of components through a large worldwide network of distributors
- > Collaboration, management, and delivery through local partners
- > With Schneider Electric as your turnkey solution partner we include in our solutions:
  - > Project management and responsibility
  - > Engineered systems
  - > Third-party components management

#### We provide on-site services and support

- > Qualified personnel to deliver on-site engineering and technical services

#### We improve your service team's competencies

- > Service and commissioning training

#### Operate



#### We provide international sales and after-sales services for you and your customers

- > Maintenance contracts
- > Spares parts
- > Repairs
- > Normal and express deliveries
- > Service expertise:
  - > Error diagnosis and repair
  - > Environmental measurements ( EMC, field bus, thermography, power quality analyses, etc.)
- > Customer International Support (CIS) as a single point of contact:
  - > A network of 190 dedicated local country experts
  - > A web-based collaborative platform for efficient communication

#### Improve



#### Improve your machine ranges

- > Consulting

#### We improve your customer's machines in their production line

- > Audits
- > Retrofitting
- > Migration and upgrade
- > Training



## Schneider Electric Library for SISTEMA

To support the EN/ISO 13849-1 standard, IFA, the German Institute for Occupational Health, has developed SISTEMA, a free-to-download software utility that designers and verifiers can use to evaluate the safety of the machine in the context of the standard.

The tool permits the designer to model the structure of the safety-related control components based on the designated architectures of the standard, permitting automated calculation of the reliability values with various levels of detail, including that of the attained PL.

Using SISTEMA, relevant risk parameters are entered step-by-step into input dialogs. Each parameter change is reflected immediately on the user interface together with its impact on the whole system.

Schneider Electric publishes software libraries for its safety components which contain relevant reliability data. This can be imported into SISTEMA and combined, the two eliminate time-consuming consultation of tables and calculation of formulae and the final results can be printed out in a summary document.

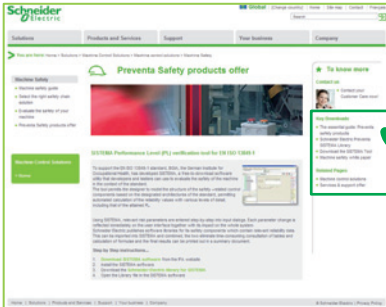

Schneider Electric library for SISTEMA

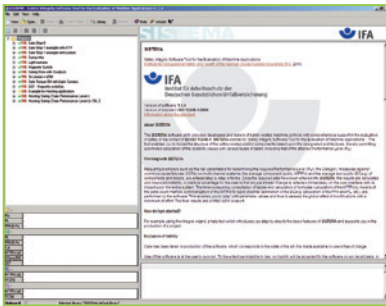

SISTEMA software

### Industrial accidents

An industrial accident occurs through work or in the workplace and causes minor to serious injury to a person using a machine, feeding it or carrying out special work on it (fitter, operator, maintenance personnel, etc.).

#### Causes of accidents in the workplace

- > Human-related factors (designers, users):
  - > poor grasp of machine design
  - > over-familiarity with danger through habit and failure to take dangerous situations seriously
  - > underestimation of hazards, causing people to ignore safe working procedure
  - > loss of concentration on tasks to be performed (e.g. fatigue)
  - > failure to comply with procedures
  - > stressful working conditions (noise, work rates, etc.)
  - > uncertainty of employment which can lead to inadequate training
  - > inadequate or bad maintenance, generating unsuspected hazards
- > Machine-related factors:
  - > inadequate guards
  - > inherent machine hazards (e.g. reciprocal motion of a machine, unexpected starting or stopping)
  - > machines not suited to the application or environment (e.g. sound alarms deadened by the noise of surrounding machinery)
- > Plant-related factors:
  - > movement of personnel from machine to machine (automated production line)
  - > machinery from different manufacturers and using different technologies
  - > flow of materials or products between machines

#### Consequences

- > Risk of varying degrees of physical injury to the user
- > stoppage of the machine involved
- > stoppage of similar machine installations for inspection, for example by health and safety inspectors
- > if necessary, modifications to make machinery safe
- > change of personnel and training new personnel for the job
- > damage to the company brand image

#### Conclusion

Damages for physical injuries are equivalent to about 20 thousand million euro paid out each year in the European Union. Decisive action is required to reduce the number of accidents in the workplace. The first essentials are adequate company policies and efficient organisation. Reducing the number of industrial accidents and injuries depends on the safety of machines and equipment.

#### Types of potential hazard

The potential hazards of a machine can be classified into three main groups, as illustrated below:

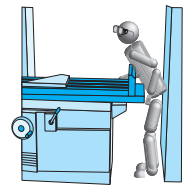
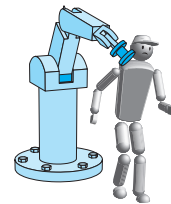
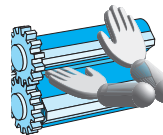
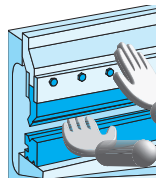

#### Mechanical hazards

*Puncturing, cutting, shearing, fractures, severing*

*Catching, entanglement, drawing in, trapping*

*Impact*

*Crushing*

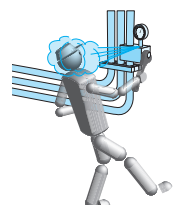
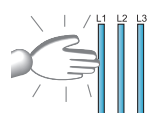

#### Electrical hazards

#### Physical and chemical hazards

*Electric shock, electrocution, burns*

*Discharge of dangerous substances*

*Burns*

### European legislation

**Safety has become a key issue for businesses. Social developments in association with technological progress have had a profound impact on legislation and on regulations for the use of building electrical automation equipment.**

#### Social issues

The safety-conscious nature of our western societies has led the legislature to increase the number of requirements and establish stricter rules, while the high cost of accidents has prompted companies to make efforts in the same direction.

#### Technological issues

Increasing levels of automation have led to new restrictions. In some case it is difficult, if not dangerous, to stop a machine suddenly and it is necessary to perform a safe shut down sequence before allowing personnel to enter into a production cell. The increasingly widespread use of electronics and software has required a different approach to the solutions adopted; empirical rules are no longer enough. Selection includes a reliability calculation to determine the behavior of the system. In this context, the specification and design phase are crucial. Studies show that more than 2/3rds of incidents are due to bad design and inadequate specifications. At this stage it is therefore necessary to estimate potential risks and select the most appropriate solutions to reduce their consequences. Standards are available to assist and guide the designer.

Manufacturers of components and solutions help their customers by offering complete, ready-to-use functions which, when combined in accordance with the regulations, satisfy the customer's needs and meet legislative requirements. In this chapter, we will present a simplified process. To make a choice, the customer will then be able to refer to the safety functions chapter and to the safety products chapters.

European legislation requires that preventive action be taken to preserve and protect the quality of the environment and human health. To achieve these objectives, European Directives have been prepared which must be applied by plant operators and by manufacturers of equipment and machines. It also assigns responsibility for possible accidents.

- > Notwithstanding the constraints, machine safety has the following positive repercussions:
  - > prevention of industrial accidents
  - > protection of workers and personnel by means of suitable safety measures that take into account the machine's application and the local environment
- > This makes it possible to reduce direct and indirect related costs:
  - > by reducing physical harm
  - > by reducing insurance premiums
  - > by reducing production losses and possible delay penalties
  - > by limiting damages and costs for maintenance
- > Safe operation involves two principles: safety and reliability of the process:
  - > safety is the ability of a device to keep the risk incurred by persons within acceptable limits
  - > reliability of operation is the ability of a system or device to perform its function at any moment in time and for a specified duration
- > Safety must be taken into account right from the beginning of the design stage and kept in place throughout all stages of a machine's life cycle: transport, installation, commissioning, maintenance, dismantling

The main purpose of the Machinery Directive 2006/42/EC is to compel manufacturers to guarantee a minimum safety level for machinery and equipment sold within the European Union. This version has been replacing the 98/37/EC version since January 2010.

To allow free circulation of machinery within the European Union, the CE marking must be applied to the machine and an EC declaration of conformity is issued to the purchaser. This directive came into effect in January 1995 and has been enforced since January 1997 for all machines.

The user has obligations defined by the Use of Work Equipment directive 89/655/EEC which can in most cases be met by using machinery compliant with relevant standards.

These standards are complex. After a brief presentation of the structure of the standards system, we will provide the practical guide to the typical standards to be applied according to the selected control system design.

### Certification and CE marking

#### Certification and CE marking

There are 6 stages in the process for certification and affixing of the CE marking on machines:

- 1 Apply all the relevant directives
- 2 Conform to the essential health and safety requirements
- 3 Draw up the technical documentation
- 4 If applicable proceed with the conformity examination
- 5 Draw up the Declaration of Conformity
- 6 Affix the CE marking

#### The Machinery Directive

The Machinery Directive is an example of the “New approach” for the harmonization of products in terms of technical specifications and standards. It is based on:

- > Essential health and safety requirements which must be complied with before the machine is put on the market
- > A voluntary harmonization process of standards undertaken by the European Standards Committee (CEN) and the European committee for electro-technical standardization (CENELEC)
- > Conformity of evaluation procedures adapted to the types of risk and associated with machine types
- > The CE marking, affixed by the manufacturer to indicate that the machine conforms to the applicable directives; machines bearing this marking can circulate freely within the European Union

The directive has considerably simplified the multiple national legislations which were in force and has therefore removed many barriers which made trading difficult in the European Union. This has also made it possible to reduce the social cost of accidents. The directives do not apply to pre-existing machines within the EU unless they are substantially modified. A list of the machines requiring special attestation procedures can be found in the Machinery Directive Annex 4.

#### The essential requirements

Annexe I of the Machinery Directive groups together the essential health and safety requirements, for putting machines and safety components on the market and into service in Europe.

It follows that:

- > If all the requirements of the directive are complied with, no member state of the European Union can oppose circulation of this product
- > If the requirements of the directive are not complied with, putting the product on the market may be prohibited or withdrawal of the product from the market may be required

In the European Union, this concerns not only manufacturers or their distributors, but also importers and resellers who import these machines or put them into service. Second-hand machines within the EU are not covered, but used machines that have been modified or refurbished can be considered to be new machines.

#### The harmonized standards

The simplest way to demonstrate conformity with the directives is to conform to the European Harmonized Standards. When, for a product listed in Annex 4 of the Machinery Directive, there is no harmonized standard, or the existing standards are not relevant to cover the essential health and safety requirements, or if the manufacturer considers that these standards are not applicable to their product, they can apply for approval by an outside Notified Body.

These bodies are approved by the Member States after having shown that they have the recognized expertise to give such an opinion (TÜV, BGIA, INRS, BSI Product Services, etc.).

Although the Notified Body has a certain number of responsibilities under the Directive, it is always the manufacturer or their representative who remain responsible for conformity of the product.

### Certification and CE marking (continued)

#### Declaration of conformity

In accordance with Article 1 of the Machinery Directive, the manufacturer or their authorized representative established in the European Union must draw up a European Declaration of Conformity for each machine (or safety component). This is in order to certify that the machine or safety component conforms to the Directive.

Before putting a product on the market, the manufacturer or their representative must prepare a technical file.

#### CE marking

Finally, the CE mark must be affixed to the machine by the manufacturer or their authorized representative in the European Union. This marking has been obligatory since 1st January 1995 and can only be affixed if the machine conforms to all the applicable directives, such as:

- > The Machinery Directive 2006/42/ECC
- > The Electromagnetic Compatibility (EMC) directive 2004/108/EC
- > The Low Voltage Directive 2006/95/EC

There are other directives such as the protection of persons, lifts, medical equipment, etc., which may also be applicable.

The CE marking is the machine's passport in the European Union, which allows it to be marketed in all countries within the Union without taking into account regulations in each individual country.

#### CE marking procedure

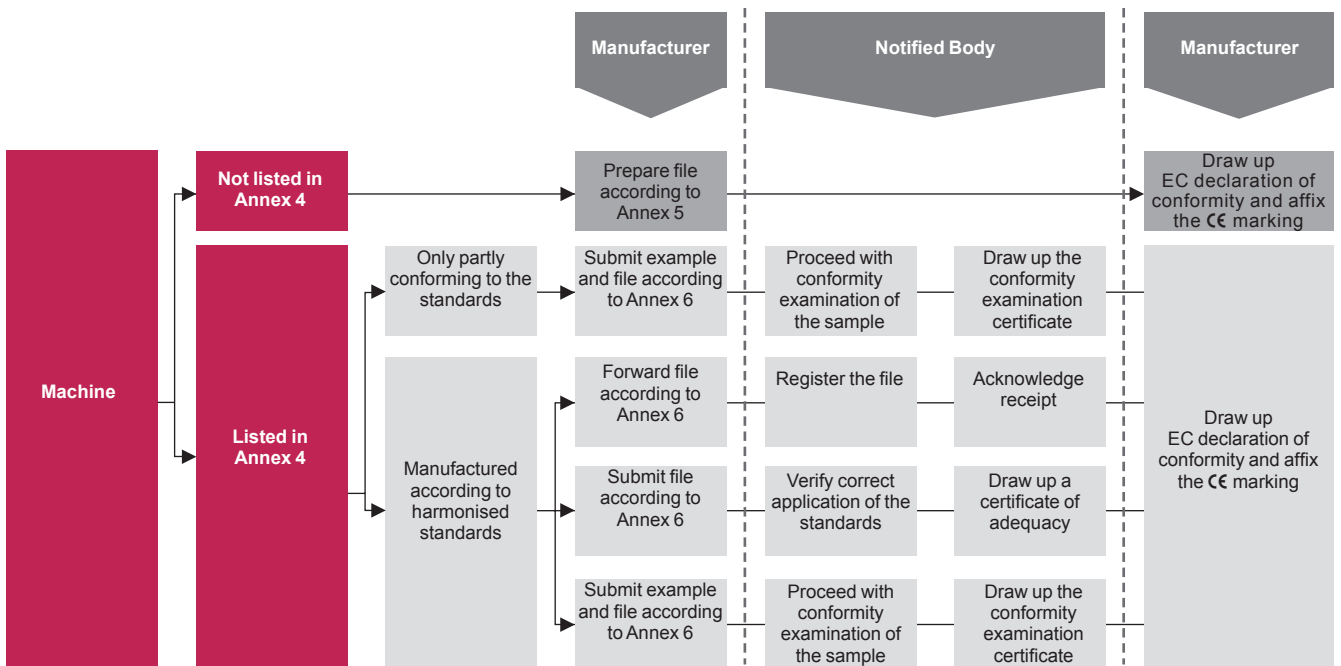

### Standards

### Introduction

The harmonized European safety standards establish technical specifications which comply with the minimum safety requirements defined in the related directives. Compliance with all applicable harmonized European standards can be assumed to ensure compliance with the related directives. The main purpose is to guarantee a minimum safety level for machinery and equipment sold within the EU market and allow the free circulation of machinery within the European Union.

#### The 3 groups of European standards

- > **Type A** standards  
Basic safety standards which specify the basic concepts, design principles and general aspects valid for all types of machine: e.g. EN/ISO 12100
- > **Type B** standards  
Standards relating to specific aspects of safety or to a particular device that can be used on a wide range of machines
- > **Type B1** standards  
Standards relating to specific safety aspects of machines: e.g. EN/IEC 60204-1 Electrical equipment of machines
- > **Type B2** standards  
Standards relating to specific products such as two-hand control stations (EN 574), guard switches (EN 1088/ISO 14119), emergency stops (EN/ISO 13850), etc
- > **Type C** standards  
Standards relating to various families or groups of machines (e.g.: hydraulic presses EN 693, robots, etc) and giving detailed applicable requirements

#### A selection of standards

Standards	Type	Subject
EN/ISO 12100	A	Machinery safety - General principles for design, risk assessment and risk reduction
EN 574	B	Two-hand control devices - Functional aspects and design principles
EN/ISO 13850	B	Emergency stop - Principles for design
EN/IEC 62061	B	Functional safety of safety-related electrical, electronic and electronic programmable control systems
EN/ISO 13849-1	B	Machinery safety - Safety-related parts of control systems - Part 1 General principles for design
EN/ISO 13849-2	B	Machinery safety - Safety-related parts of control systems - Part 2 Validation
EN 349	B	Minimum gaps to avoid crushing parts of the human body
EN 294	B	Safety distances to prevent hazardous zones being reached by upper limbs
EN 811	B	Safety distances to prevent hazardous zones being reached by lower limbs
EN/IEC 60204-1	B	Machinery safety - Electrical equipment of machines - Part 1: general requirements
EN 999/ISO 13855	B	Positioning of protective equipment in respect of approach speeds of body parts
EN 1088/ISO 14119	B	Interlocking devices associated with guards - Principles for design and selection
EN/IEC 61496-1	B	Electro-sensitive protective equipment
EN/IEC 60947-5-1	B	Electromechanical control circuit devices
EN 842	B	Visual danger signals - General requirements, design and testing
EN 1037	B	Prevention of unexpected start-up
EN 953	B	General requirements for the design and construction of fixed and movable guards
EN/IEC 61800-5-2	B	Adjustable speed electrical power drive systems. Part 5-2: Safety requirements – Functional
EN 201	C	Machinery for plastics and rubber - Injection moulding machines – Safety requirements
EN 692	C	Mechanical presses - Safety requirements
EN 693	C	Hydraulic presses - Safety requirements
EN 289	C	Machinery for plastics and rubber - Presses - Safety requirements
EN 422	C	Blow moulding machines for producing hollow parts - Design and construction requirements
EN/ISO 10218-1	C	Manipulating industrial robots - Safety requirements
EN 415-4	C	Safety of packaging machines - Part 4: palletisers and depalletisers
EN 619	C	Safety and EMC requirements for equipment for mechanical handling of unit loads
EN 620	C	Safety and EMC requirements for fixed belt conveyors for bulk material
EN 746-3	C	Industrial thermo processing equipment - Part 3: safety requirements for the generation and use of atmosphere gases

### Standards to be applied

### The process

#### European Machinery Directive 2006/42/EC

Compliance with the following standards ensure compliance with the Machinery Directive (this new version of the Machinery Directive 2006/42/EC has been replacing 98/37/EC since January 2010).

**EN/ISO 12100: 2010:** General principles for design, risk assessment and risk reduction.

The purpose of this standard is to provide designers with an overall framework and guidance to enable them to produce machines that are safe for their intended use.

**Standards** to be apply according to the design selected for the safety-related machine control system.

#### Remarks:

The use of either the EN/ISO 13849 or EN/IEC 62061 standards gives presumption of conformity to the new 2006/42/EC directive.

**EN/IEC 60204-1:** Electrical equipment of machines

Standard EN/IEC 60204-1 completes the safety standards by giving setting-up rules for each component of a machine's electrical functions.

It specifies, amongst other things:

- > the type of connection terminals and disconnection and breaking devices
- > the type of electric shock protection
- > the type of control circuits
- > the type of conductors and wiring rules
- > the type of motor protection

### Standard to be applied according to the design selected for the safety related machine control system

#### Safety standards to be applied according to type of architecture selected

Based on the generic definition of the risk, the standards classify necessary safety levels in different discrete levels corresponding for each one to a probability of dangerous failure per hour:

- > PL (Performance Level) for standard EN/ISO 13849-1
- > SIL (Safety Integrity Level) for standard EN/IEC 62061

European Machinery Directive 2006/42/EC

Machinery safety  
General principles for design, risk assessment  
and risk reduction  
EN/ISO 12100: 2010

**EN/ISO 13849-1**  
**EN/ISO 13849-2**

Machinery safety  
Safety-related parts of  
control systems

**EN/IEC 62061**

Machinery safety  
Functional safety of  
safety-related electrical,  
electronic and  
programmable electronic  
control systems

Machinery safety  
EN/IEC 60204-1  
Electrical equipment of machines

Certification and **CE** marking in accordance with the  
Machinery Directive

Standards to be applied for the design of machines

### Risk and safety

Safety is the absence of risks which could cause injury to or damage the health of persons. Functional safety is a part of safety that depends on the correct operation of safety functions.

According to the requirements of standard EN/ISO 12100: 2010, the machine designer's job is to reduce all risks to a value lower than the acceptable risk. For more details concerning the sources of accidents and risk prevention, the reader is referred on page 1/6.

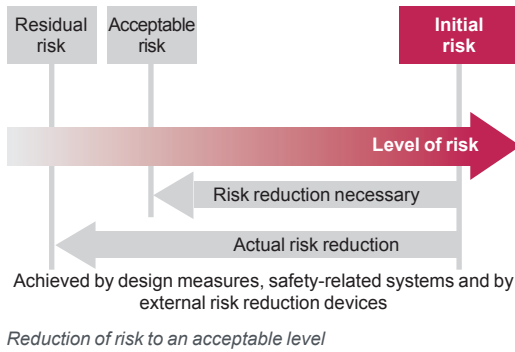

This standard recognizes two sources of hazardous phenomena:

- > Moving transmission parts
- > Moving parts contributing to the work

It gives guidelines for the selection and installation of devices which can be used to protect persons and identifies those measures that are implemented by the machine designer and those dependent on its user.

**The measures taken by the machine designer may be:**

- > Inherent in the design
- > Selection of guards and additional measures, including control systems
- > Information for the user

**The measures taken by the user may be (non-exhaustive list):**

- > Organization, procedures, etc.
- > Personal protective equipment
- > Training

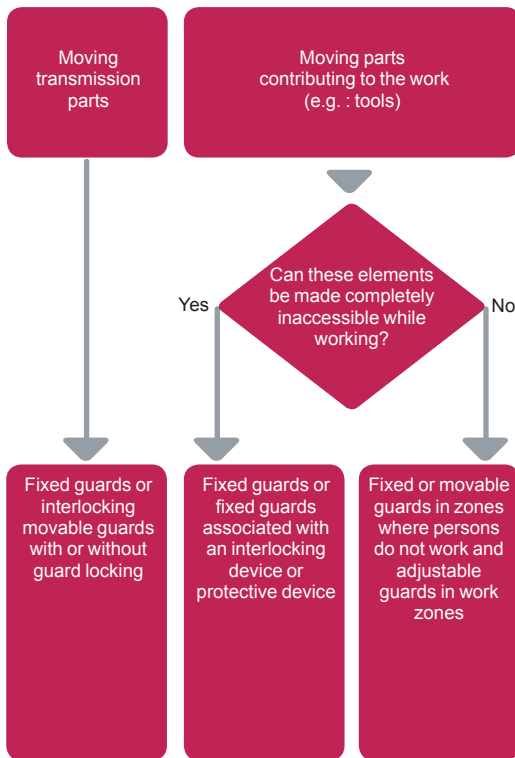

Selection of the protection system  
(EN/ISO 12100: 2010)



### Risk Assessment

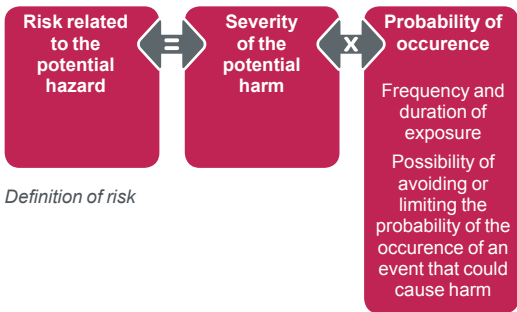

Definition of risk

### Assessment of machinery related risk

#### European legislation

Machines are sources of potential risk and the Machinery Directive requires a risk assessment to ensure that any potential risk is reduced to less than the acceptable risk.

Standard EN/ISO 12100 defines risk as follows: risk is the severity multiplied by the possibility of occurrence. It defines an iterative process for achieving machine safety, which states that the risks for each potential hazard can be determined in four stages. This method provides the basis for the requisite risk reduction.

#### Risk assessment

- > Risk assessment consists of a series of logic steps which make it possible to systematically analyze and evaluate machinery-related risks
- > Risk assessment is followed, whenever necessary, by a reduction of the risk. This definition taken from standard EN/ISO 12100 is based on an iterative process represented in the diagram opposite

#### Determination of machine limits

Risk assessment starts by determining the limits of the machine at all stages of its life cycle:

- > Transport, assembly, installation
- > Commissioning
- > Use
- > De-commissioning, dismantling

The use limitations must then be specified:

- > Operating modes
- > Level of training required
- > Space limits (amplitude, movement)
- > Time limits (life cycle, frequency of maintenance)

#### Identification of the potential hazard

If a potential hazard exists, a hazardous phenomenon will cause harm if measures are not taken.

All the tasks associated with the machine's life cycle must be identified, such as:

- > Assembly, transport and installation
- > Adjustment, testing
- > Learning, programming
- > Tool changing
- > Feeding, removal of product from the machine
- > Starting, stopping
- > Emergency Stops, restarting after an unexpected stop
- > Maintenance, cleaning, etc.

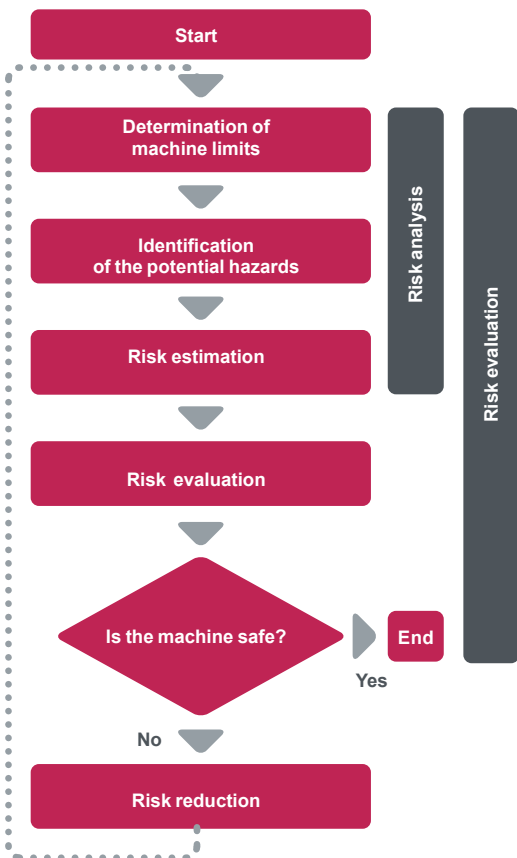

Logic steps for risk analysis

1

### Risk Assessment

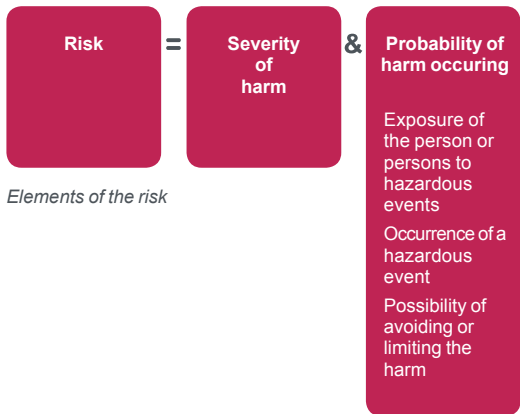

### Risk estimation

The risk is a function of the severity of the harm and the probability that this harm will occur.

- > The severity of the harm takes into account:
  - > The severity of injuries (slight, serious, death)
  - > The extent of the harm (number of persons)
- > The probability of the harm occurring takes into account:
  - > Exposure to the hazard (nature of access, time spent in the hazardous zone, number of persons exposed, frequency of access, etc.)
  - > The occurrence of a hazardous event (accident history, comparison of risks, etc.)
  - > The possibility of avoiding or limiting the harm (experience, awareness of the risk, etc.)

### Risk assessment

On the basis of the risk assessment, the designer has to define the safety related control system.

To achieve that, the designer will choose one of the two standards appropriate to the application:

- > either standard EN/ISO 13849-1, which defines performance levels (PL)
- > or standard EN/IEC 62061, which defines safety integrity level (SIL)



- $\lambda$  rate of control system failures
- $\lambda_D$  rate of dangerous failures
- $\lambda_{DU}$  rate of undetected dangerous failures
- $\lambda_{DD}$  rate of detected dangerous failures
- $\lambda_S$  rate of safe failures
- $\lambda_{SU}$  rate of undetected safe failures
- $\lambda_{SD}$  rate of detected safe failures

Breakdown of the probability of failures

### Risk reduction

The process of risk reduction for dangerous events starts by:

- > Intrinsic prevention (inherently safe design)
- > Definition of the appropriate protective means (guards, carters, fix fences, etc.)
- > Personal training

If the selected preventive measure depends on a safety related control system, the designer has to perform an iterative process for the design of the safety relative control system.

- > The first stage is to define the necessary safety-related control functions:
  - > either through the choice of components
  - > or by adapting the control system architecture. Redundancy (double circuit components), for example, significantly increases the reliability of the solution
- > Once the limits of available technologies have been reached, it will not be possible to further reduce the rate of dangerous failures. To achieve the required level of safety, it will be necessary to use a diagnostic system that allows dangerous failures to be detected

**How to choose between EN/ISO 13849 and EN/IEC 62061**

**Select the applicable standard**

Based on the generic definition of the risk, the standards classify necessary safety levels in different discrete levels corresponding for each one to a probability of dangerous failure per hour:

- > PL (Performance Level) for standard EN/ISO 13849-1
- > SIL (Safety Integrity Level) for standard EN/IEC 62061

The table below gives the relationship between the performance level (PL) and the Safety Integrity Level (SIL).

PL	ISL	Probability of dangerous failures per hour 1/h
a	No correspondance	$\geq 10^{-5} \dots < 10^{-4}$
b	1	$\geq 3 \times 10^{-6} \dots < 10^{-5}$
c	1	$\geq 10^{-6} \dots < 3 \times 10^{-6}$
d	2	$\geq 10^{-7} \dots < 10^{-6}$
e	3	$\geq 10^{-8} \dots < 10^{-7}$

**Recommended application of IEC 62061 and ISO 13849-1**

Annex	Technology implementing the safety related control fuction (S)	ISO 13849-1	IEC 62061
A	Non electrical, e.g. hydraulics	X	Not covered
B	Electromechanical, e.g. relays, or non-complex electronics	Restricted to designated architectures (see Note 1) and up to PL=e	All architectures and up to SIL 3
C	Complex electronics, e.g. programmable	Restricted to designated architectures (see Note 1) and up to PL=d	All architectures and up to SIL 3
D	A combined with B	Restricted to designated architectures (see Note 1) and up to PL=e	X see Note 3
E	C combined with B	Restricted to designated architectures (see Note 1) and up to PL=d	All architectures and up to SIL 3
F	C combined with A, or C combined with A and B	X see Note 2	X see Note 3

"X" indicates that this item is dealt with by the standard shown in the column heading.

**Note 1** Designated architecture are defined in Annex B of EN/ISO 13849-1 to give a simplified approach for qualification of performance level

**Note 2** For complex electronics: use of designated architecture according to EN/ISO 13849-1 up to PL=d or any architecture according to EN/IEC 62061

**Note 3** For non-electrical technology use parts according to EN/ISO 13849-1 as subsystems.

For building specific complex sub-systems or for higher level requirements including software, standard EN/IEC 61508 relating to systems must be used.

1

**Standard EN/ISO 13849-1**  
Standards to be applied according to the design selected for the safety-related machine control system

### Introduction to Functional Safety of Machinery

The functional safety standards are intended to encourage designers to focus more on the functions that are necessary to reduce each individual risk, and on the performance required for each function, rather than simply relying on particular components. These standards make it possible to achieve greater levels of safety throughout the machine's life.

- > Under the previous standard, EN 954-1, categories (B, 1, 2, 3 and 4) dictated how a safety-related electrical control circuit must behave under fault conditions. Designers can follow either EN/ISO 13849-1 or EN/IEC 62061 to demonstrate conformity with the Machinery Directive. These two standards consider not only whether a fault will occur, but also how likely it is to occur
- > This means there is a quantifiable, probabilistic element in compliance: machine builders must be able to determine whether their safety circuit meets the required safety integrity level (SIL) or performance level (PL). Panel builders and designers should be aware that manufacturers of the components used in safety circuits (such as safety detection components, safety logic solvers and output devices like contactors) must provide detailed data on their products

### Standard EN/ISO 13849-1 Machinery safety - Safety-related parts of control systems

Standard EN/ISO 13849-1 is an evolution of standard EN 954-1.

#### Field of application of the standard

This standard gives safety requirements and advice relating to principles for the design and integration of safety-related parts of control systems (SRP/CS), including software design. For these parts, it specifies the characteristics, including the performance level, needed to achieve these safety functions. It applies to the SRP/CS of all types of machine, regardless of the technology and type of energy used (electric, hydraulic, pneumatic, mechanical, etc.).

#### Process

Risk assessment as defined in standard EN/ISO 12100 leads to decisions on risk reduction measures.

If these measures depend on a control system, then EN/ISO 12100 can apply. It defines a **6-stage design process**:

- 1 - Selection of the essential safety functions that SRP/CS must perform. For each safety function, specify the required characteristics
- 2 - Determine the required performance level (PLr)
- 3 - Design and technical creation of safety functions: identify the parts that perform the safety function
- 4 - Evaluate the performance level PL for each safety-related part
- 5 - Check that the performance level PL achieved is greater than or equal to the required level (PLr)
- 6 - Check that all requirements are satisfied

We will now illustrate these stages, taking as an example a safety function where a severe injury can be caused by a trolley not stopping at the end of the Jib and thus causing the trolley to fall. A person can be exposed to this dangerous situation around the hoisting machine.

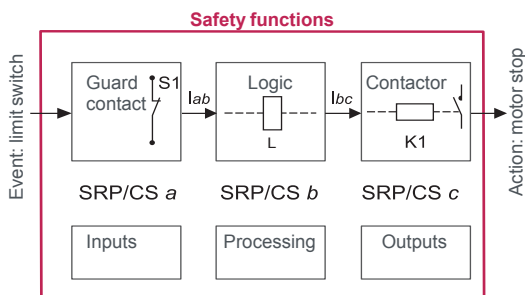

Representation of the safety function

#### Stage 1 - Selection of safety functions

The diagram opposite shows a safety function which consists of several parts:

- > The input actuated by opening of the guard (SRP/CSa)
- > The control logic, limited in this example to opening or closing of a contactor coil (SRP/CSb)
- > The power output that controls the motor (SRP/CSc)
- > The connections (lab, lbc)

#### Stage 2 - Estimation of required performance level (PLr)

Considering our example of the person coming into area where the dangerous hoisting machine is operating we now estimate the risk using the risk graph.

The parameters to be considered are:

- > **S** Severity of the injury
  - > **S1** Slight injury, normally reversible
  - > **S2** Serious, normally irreversible, including death
- > **F** Frequency and/or duration of exposure to the hazardous phenomenon
  - > **F1** Rare to fairly frequent and/or short duration of exposure
  - > **F2** Frequent to permanent and/or long duration of exposure
- > **P** Possibility of avoiding the hazardous phenomena or limiting the harm
  - > **P1** Possible under certain circumstances
  - > **P2** Virtually impossible

**Risk related to the potential hazard**

$$= \text{Severity of the potential harm} \times \text{Probability of occurrence:}$$

- Frequency and duration of exposure
- Possibility of avoiding or limiting the probability of the occurrence of an event that could cause the harm

Risk analysis

**Standard EN/ISO 13849-1**  
**Machinery safety - Safety-related parts of control systems (continued)**  
**Process (continued)**

**Stage 2 - Estimation of required performance level (PLr) (continued)**

For our example: a serious injury S1 can be caused by being exposed near the hoisting machine as if there is no safe guarding to ensure the trolley stops the load and trolley will fall. After considering the severity of the injury we investigate the frequency and/or duration of the possible entry to the dangerous area. Here we define the frequency of exposure to the hazard is low F1 (occasional presence) as there are restrictions to enter the area. The last step is based upon the possibility to avoid the hazard and limiting the harm as the visibility around the dangerous machine is monitored by the operator and in this case there is a possibility to avoid the harm under certain conditions so we define it as P1.  
**The result of the estimation gives a required performance level PLr = c.**

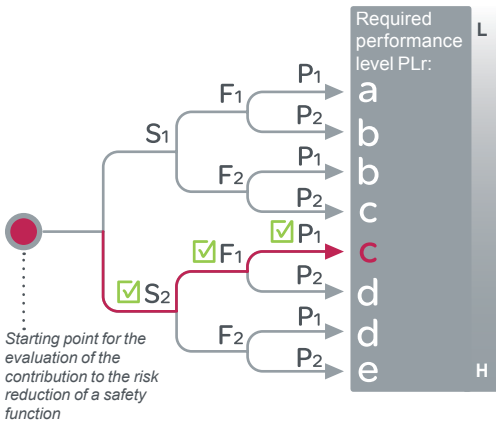

Estimation of required performance level

- S = Severity of injury**  
 S1 = Slight (normally reversible injury)  
 S2 = Serious (normally irreversible) injury including death
- F = Frequency and/or exposure time to the hazard**  
 F1 = Seldom to less often and/or the exposure time is short  
 F2 = Frequent to continuous and/or the exposure time is long
- P = Possibility of avoiding the hazard or limiting the harm**  
 P1 = Possible under specific conditions  
 P2 = Scarcely possible
- L = Low contribution to risk reduction  
 H = High contribution to risk reduction  
 → Estimation

**Stage 3 - Design and creation of the safety functions**

At this point, we need to describe the PL calculation method. For a SRP/CS (or a combination of SRP/CS), PL could be estimated with the figure shown on page 1/19, after estimation of several factors such as :  
 > Hardware and software system structure (categories)  
 > Mechanism of failures, diagnostic coverage (DC)  
 > Components reliability, Mean Time To dangerous Failure (MTTF<sub>d</sub>)  
 > Common Cause Failure (CCF)

**> Categories (Cat.) and designated architectures**

The table below summarises system behaviour in the event of a failure and the principles used to achieve the safety, for the 5 categories defined:

Cat.	System behaviour	Designated architectures
B	A fault can lead to loss of the safety function	
1	As for category B but the probability of this occurrence is lower than for the category B	
2	A fault can lead to loss of the safety function between two periodic inspections and loss of the safety function is detected by the control system at the next test.	
3	For a single fault, the safety function is always ensured. Only some faults will be detected. The accumulation of undetected faults can lead to loss of the safety function.	
4	When faults occur, the safety function is always ensured. Faults will be detected in time to prevent loss of the safety function	

Key:  
 im: Interconnecting means  
 c: Cross monitoring  
 l, l1, l2: Logic  
 m: Monitoring  
 O, O1, O2: Output device, e.g. main contactor  
 TE: Test equipment  
 OTE: Output of TE

**> MTTF<sub>d</sub> (Mean Time To dangerous Failure)**

The value of the MTTF<sub>d</sub> of each channel is given in 3 levels (see table below) and shall be taken into account for each channel (e.g. single channel, each channel of a redundant system) individually.

Reliability levels of components	
Index	Range
Low	3 years ≤ MTTF <sub>d</sub> < 10 years
Medium	10 years ≤ MTTF <sub>d</sub> < 30 years
High	30 years ≤ MTTF <sub>d</sub> < 100 years

A MTTF<sub>d</sub> of less than 3 years should never be found, because this would mean that after one year in operation, 30% of all those components in use would have failed to a dangerous state. The maximum value is limited to 100 years because devices dealing with a significant risk should not depend on the reliability of a single component. Additional measures such as redundancy and tests are required.

**Standard EN/ISO 13849-1**  
Standards to be applied according to the design selected for the safety-related machine control system

**Standard EN/ISO 13849-1**  
Machinery safety - Safety-related parts of control systems (continued)

Process (continued)

**Stage 3- (continued)**

> Diagnostic coverage (DC): this term is expressed as a percentage and quantifies the ability to diagnose a dangerous failure  
For example, in the event of welding of a N/C contact in a relay, the state of the N/O contact could incorrectly indicate the opening of the circuit, unless the relay has mechanically linked N/O and N/C contacts, when the fault can be detected.  
The standard recognises four levels:

**Diagnostic coverage (DC)**

Denotation	Range
Nil	DC < 60%
Low	60% ≤ DC < 90%
Medium	90% ≤ DC < 99%
High	99% ≤ DC

> Relationship between Categories, DC and MTTF<sub>d</sub> of each channel and the PL

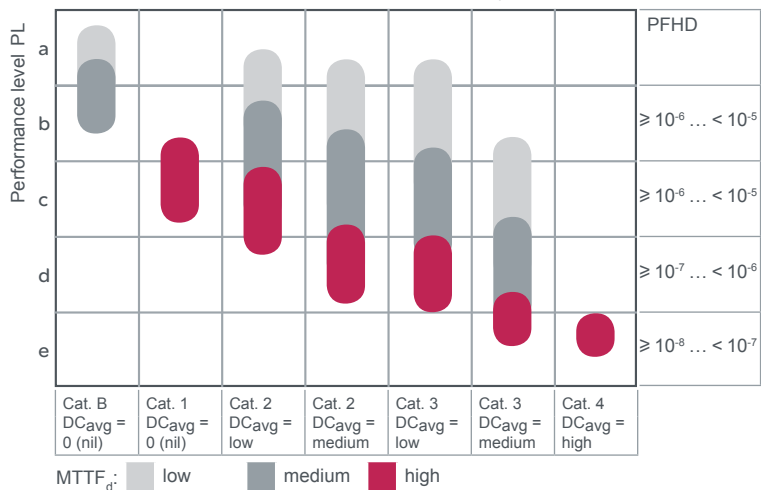

> Using the above chart we can now select the most appropriate architecture, the required Diagnostic coverage as well as ensure the products selected have the right MTTF<sub>d</sub> values

> As we require PL= "c" the chart states as a minimum a category 1 architecture with a Diagnostic coverage of 0 (Nil) and a MTTF<sub>d</sub> of High is required. It is possible to use architectures with higher categories to solve the safety function needs

> We start with determining the architecture required to solve the function. We use the following Category 1 architecture (see page 1/19)

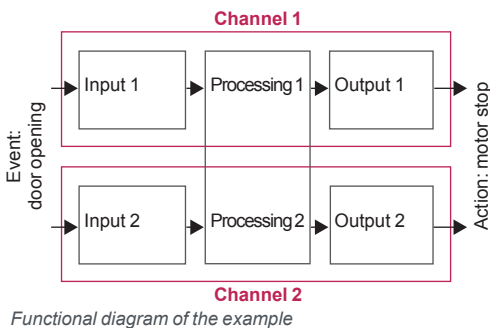

> In our example, to reach the PL = e, the solution will therefore have to correspond to category 4 with redundant circuit; the function scheme is shown opposite with two channels in parallel

> a high diagnostic capability

> a high MTTF<sub>d</sub>

For our application, we could suggest a redundant relay scheme but it is nowadays easier to use safety function blocks. The solution is illustrated below.

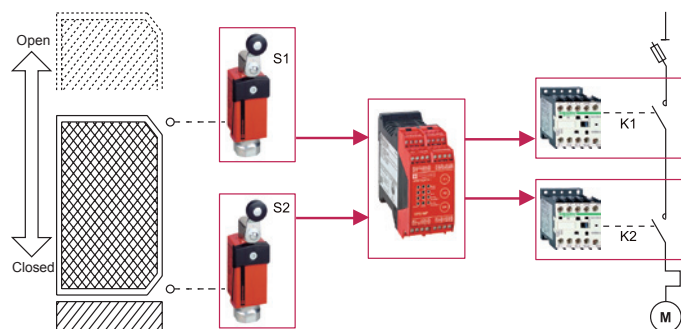

The process suggested by the standard is iterative and a few estimations are therefore necessary in order to obtain the expected result. In view of the required performance level, we have chosen a solution with redundant circuit.

**Standard EN/ISO 13849-1**  
**Machinery safety - Safety-related parts of control systems (continued)**  
**Process (continued)**

**Stage 4 - Evaluate the performance level PL for each safety-related part**  
 Based on the information in the supplier's catalogue and Annex E of the standard, we obtain the following values:

Example	B <sub>10</sub> (number of operations) / % dangerous failure	MTTF <sub>d</sub>	DC
SRP/CS <sub>a</sub> : Safety limit switches	10.000.000 / 20% dangerous failure	7102	99%
SRP/CS <sub>b</sub> : XPS AK safety module	-	154.5	99.99%
SRP/CS <sub>c</sub> : LCK contactor	1.000.000 / 73% dangerous failure	194	99%

For electromechanical products, the MTTF<sub>d</sub> is calculated on the basis of the total number of operations that the product can perform, using B<sub>10d</sub> values:  
 In our case, the machine operates for 220 days per year, 8 hours per day with a cycle of 90 s.

$N = 220 \times 8 \times (3600 / 90) = 70\,400$  operations/year  
 $MTTF_d = B_{10d} / (0.1 \times N)$  and  $B_{10d} = B_{10} / \% \text{ dangerous failure.}$

For the safety switches, the  $MTTF_d = (1 / 0.20 \times 10\,000\,000) / (0.1) \times 70\,400 = 7102$  years

For the contactors, the  $MTTF_d = (1 / 0.73 \times 1\,000\,000) / (0.1) \times 70\,400 = 194$  years  
 The MTTF<sub>d</sub> for each channel will then be calculated using the formula:

$$\frac{1}{MTTF_d} = \frac{1}{MTTF_{da}} + \frac{1}{MTTF_{db}} + \frac{1}{MTTF_{dc}}$$

i.e. 85 years for each channel.

A similar formula is used to calculate the diagnostic capability

$$DC_{avg} = \frac{\frac{DC_a}{MTTF_{da}} + \frac{DC_b}{MTTF_{db}} + \frac{DC_c}{MTTF_{dc}}}{\frac{1}{MTTF_{da}} + \frac{1}{MTTF_{db}} + \frac{1}{MTTF_{dc}}}$$

The result of the calculation in our example gives a value of 99%

**Stage 5 - Checking that required performance level is achieved**

The result of the above calculations is summarised below:

- > a redundant architecture: category 4
- > a mean time to failure > 30 years: high MTTF<sub>d</sub>
- > a diagnostic capability of 99%: high DC

Looking at this table, we confirm that PL level e is achieved:

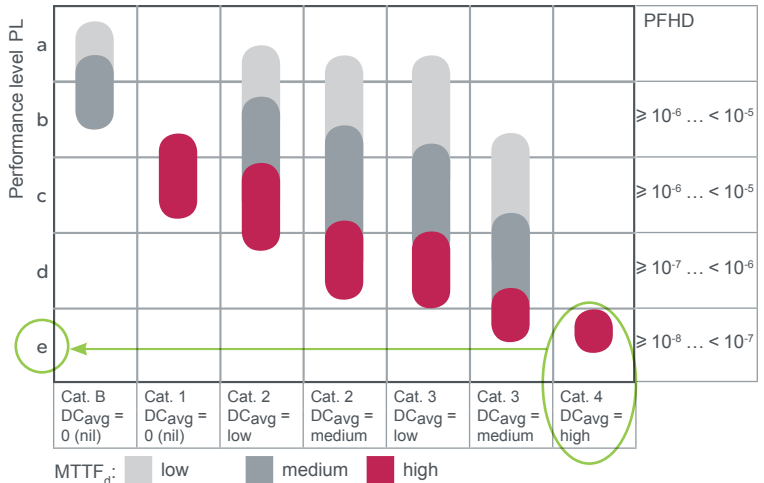

Checking the PL

**Stage 6 - Validation of the required performance level**

The design of SRP/CS must be validated and must show that the combination of SRP/CS performing each safety function satisfies all the applicable requirements of EN/ISO 13849.

**Standard EN/IEC 62061**  
Standards to be applied according to the design selected for the safety-related machine control system

**Standard EN/IEC 62061**  
Machinery safety - Safety-Related Electrical Control systems (SRECS)

**Functional Safety of safety-related electrical, electronic and electronic programmable control systems**

**Field of application of the standard**

Safety-related electrical control systems in machines (SRECS) are playing an increasing role in ensuring the overall safety of machines and are more and more frequently using complex electronic technology.

This standard is specific to the machine sector within the framework of EN/IEC 61508. It gives rules for the integration of sub-systems designed in accordance with EN/ISO 13849. It does not specify the operating requirements of non-electrical control components in machines (for example: hydraulic, pneumatic).

**Functional approach to safety**

As with EN/ISO 13849-1, the process using the EN/IEC 62061 starts with analysis of the risks (EN/ISO 12100) in order to be able to determine the safety requirements.

**A particular feature of this standard is that it prompts the user to make a functional analysis of the architecture, then split it into sub-functions and analyse their interactions before deciding on a hardware solution for them (the SRECS).**

- > A functional safety plan must be drawn up and documented for each design project. It must include:
  - > A specification of the safety requirements for the safety functions (SRCF) that is in two parts:
    - > Description of the functions and interfaces, operating modes, function priorities, frequency of operation, etc.
    - > Specification of the safety integrity requirements for each function, expressed in terms of **SIL** (Safety Integrity Level)
  - > The structured and documented design process for electrical control systems (SRECS)
  - > The procedures and resources for recording and maintaining appropriate information
  - > The process for management and modification of the configuration, taking into account organisation and authorised personnel
  - > The verification and validation plan

> **Functional safety**

The decisive advantage of this approach is that of being able to offer a failure calculation method that incorporates all the parameters that can affect the reliability of electrical systems, whatever the technology used.

The method consists of assigning a SIL to each function, taking into account the following parameters:

- > The probability of a dangerous failure of the components (PFH<sub>d</sub>)
- > The type of architecture; with or without redundancy, with or without diagnostic device making it possible to avoid some of the dangerous failures
- > Common cause failures (power cuts, overvoltage, loss of communication network, etc.) (CCF)
- > The probability of a dangerous transmission error where digital communication is used
- > Electromagnetic interference (EMC)



**Standard EN/IEC 62061**  
**Machinery safety - Safety-Related Electrical Control systems (SRECS) (continued)**  
**Process**

Designing a system is split into 5 stages after having drawn up the functional safety plan:

- 1 - Based on the safety requirements specification (SRS), assign a safety level (SIL) and identify the basic structure of the electrical control system (SRECS), describe each related function (SRCF)
- 2 - Break down each function into a function block structure (FB)
- 3 - List the safety requirements for each function block and assign the function blocks to the sub-systems within the architecture
- 4 - Select the components for each sub-system
- 5 - Design the diagnostic function and check that the specified safety level (SIL) is achieved.

**Stage 1 - Assign a safety integrity level (SIL) and identify the structure of the SRECS**

Based on the risk assessment performed in accordance with standard EN/ISO 12100, estimation of the required SIL is performed for each hazardous phenomenon and is broken down into parameters, see illustration opposite.

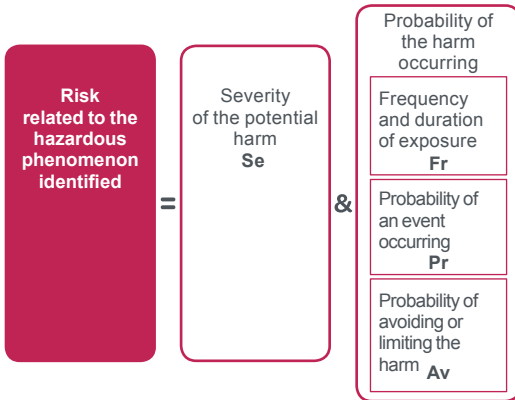

> Severity Se

The severity of injuries or damage to health can be estimated by taking into account reversible injuries, irreversible injuries and death.

The classification is shown in the table below:

Consequence	Severity Se
Irreversible: death, loss of an eye or an arm	4
Irreversible: shattered limb, loss of a finger	3
Reversible: requires the attention of a medical practitioner	2
Reversible: requires first aid	1

> Probability of the harm occurring

Each of the three parameters Fr, Pr, Av must be estimated separately using the most unfavourable case. It is strongly recommended that a task analysis model be used in order to ensure that estimation of the probability of the harm occurring is correctly taken into account.

> Frequency and duration of exposure Fr

The level of exposure is linked to the need to access the hazardous zone (normal operation, maintenance, ...) and the type of access (manual feeding, adjustment, ...). It must then be possible to estimate the average frequency of exposure and its duration.

The classification is shown in the table below:

Frequency of dangerous exposure	Fr
≤ 1 hour	5
>1 hour... ≤ 1 day	5
> 1 day... ≤ 2 weeks	4
2 weeks... ≤ 1 year	3
> 1 year	2

> Probability of occurrence of a hazardous event Pr.

Two basic concepts must be taken into account:

- > the predictability of the dangerous components in the various parts of the machine in its various operating modes (normal, maintenance, troubleshooting), paying particular attention to unexpected restarting
- > behaviour of the persons interacting with the machine, such as stress, fatigue, inexperience, etc.

Probability of occurrence of a dangerous event	Pr
Very high	5
Probable	4
Possible	3
Almost impossible	2
Negligible	1

**SRECS: Safety-related control system**

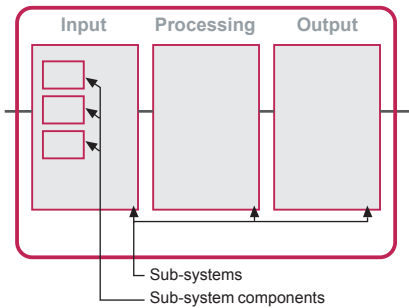

Stage 1: Basic structure of the electrical control system

1

**Standard EN/IEC 62061**  
Standards to be applied according to the design selected for the safety-related machine control system

**Standard EN/IEC 62061**  
Machinery safety - Safety-Related Electrical Control systems (SRECS) (continued)  
Process (continued)

**Stage 1 -(continued)**

> Probability of avoiding or limiting the harm Av  
This parameter is linked to the design of the machine. It takes into account the suddenness of the occurrence of the hazardous event, the nature of the dangerous component (cutting, temperature, electrical) and the possibility for a person to identify a hazardous phenomenon.

Probability of avoiding or limiting the harm	Av
Impossible	5
Almost impossible	3
Probable	1

> Assignment of the **SIL**

Estimation is made with the help of the table below.  
In our example, the degree of severity is 3 because there is a risk of a finger being amputated; this value is shown in the first column of the table.  
All the other parameters must be added together in order to select one of the classes (vertical columns in the table below), which gives us:  
 > Fr = 5 accessed several times a day  
 > Pr = 4 hazardous event probable  
 > Av = 3 probability of avoiding almost impossible  
 Therefore a class CI = 5 + 4 + 3 = 12  
 A level of SIL 2 must be achieved by the safety-related electrical control system(s) (SRECS) on the machine.

Se	Class CI				
	3-4	5-7	8-10	11-13	14-15
4	SIL 2	SIL 2	SIL 2	SIL 3	SIL 3
3	-	-	SIL 1	SIL 2	SIL 3
2	-	-	-	SIL 1	SIL 2
1	-	-	-	-	SIL 1

SRECS  
Objective SIL 2

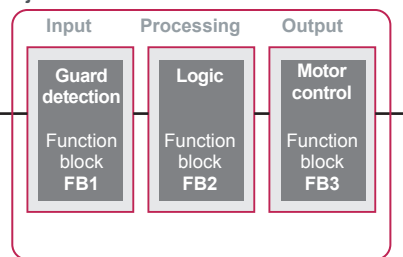

Stage 2: Break down into function blocks

> Basic structure of the **SRECS**

Without going into detail about the hardware components to be used, the system is broken down into sub-systems. In our case, we find the 3 sub-systems that will perform the input, processing and output functions. The figure opposite illustrates this stage, using the terminology given in the standard.

**Stage 2 - Break down each function into a function block structure (FB)**

A function block (FB) is the result of a detailed break down of a safety-related function.

The function block structure gives an initial concept of the SRECS architecture. The safety requirements of each block are deduced from the specification of the safety requirements of the system's function.

SRECS

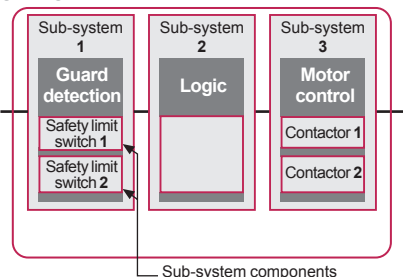

Stage 3: Assignment of function blocks

**Stage 3 - List the safety requirements for each function block and assign the function blocks to the sub-systems within the architecture**

Each function block is assigned to a sub-system in the SRECS architecture. A failure of any sub-system will lead to the failure of the safety-related control function. More than one function block may be assigned to each sub-system. Each sub-system may include sub-system elements and, if necessary, diagnostic functions in order to ensure that anomalies can be detected and the appropriate action taken.

These diagnostic functions (D) are considered as separate functions; they may be performed within the sub-system, by another internal or external sub-system.

**Standard EN/IEC 62061**  
**Machinery safety - Safety-Related Electrical Control systems (SRECS) (continued)**  
**Process (continued)**

**Stage 4 - Select the components for each sub-system**

The products shown in the illustration opposite are selected. If the sensors and contactors are the same as in the previous example, a safety module XPS AK will be chosen. In this example, we take a cycle of 450s which means the duty cycle C is 8 operations per hour.

As the safety integrity level required for the entire system is SIL 2, each of the components must achieve this level.

The manufacturer's catalogue gives the following values:

Safety limit switches 1 and 2:  $B_{10} = 10\,000\,000$  operations, the proportion of dangerous failures is 20%, lifetime is 10 years.

- > Safety module:  $PFH_d = 7.389 \cdot 10^{-9}$
- > Contactors 1 and 2:  $B_{10} = 1\,000\,000$  operations, the proportion of dangerous failures = 73%, lifetime is 20 years

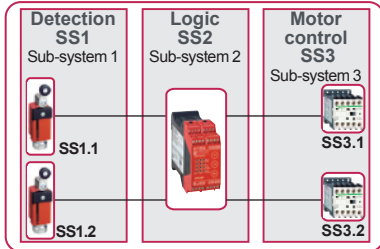

Stage 4: Component selection

**Stage 5 - Design the diagnostic function**

The SIL of the sub-system depends not only on the components, but also on the architecture selected. For our example, we will choose architectures B and D of the standard.

In our architecture, the safety module performs diagnostics not only on itself, but also on the safety limit switches.

We have three sub-systems for which the safety levels must be determined:

- > SS1: two redundant safety limit switches in a sub-system with a type D architecture
- > SS2: a SIL 3 safety module (obtained on the basis of the PFH provided by the manufacturer)
- > SS3: two redundant contactors built in accordance with a type B architecture

The calculation method can be found in the machine safety guide, so we will only give the final result. This method takes into account the following parameters:

- >  $B_{10}$ : number of operations at which 10% of the population fail
- > C: Duty cycle (number of operations per hour)
- >  $\lambda_D$ : rate of dangerous failures ( $\lambda_D = \lambda \times$  portion of dangerous failures in %)
- >  $\beta$ : common cause failure coefficient, which is 10% here and 10% is the worst case: see Annex F
- > T1: Proof Test Interval or life time whichever is smaller, as provided by the supplier
- > T2: diagnostic test interval
- > DC: Diagnostic coverage rate =  $\lambda_{DD}/\lambda_D$ , ratio between the rate of detected failures and the rate of dangerous failures

We obtain:

- > for SS1  $PFH_d = 1.6 \cdot 10^{-9}$
- > for SS3  $PFH_d = 1.06 \cdot 10^{-7}$

The total probability of dangerous failures per hour is:

- >  $PFH_{DSRECS} = PFH_{DSS1} + PFH_{DSS2} + PFH_{DSS3}$
- >  $PFH_{DSRECS} = 1.6 \cdot 10^{-9} + 7,38 \cdot 10^{-9} + 1.06 \cdot 10^{-7} = 1.15 \cdot 10^{-7}$

Which corresponds to the expected result (table below) of a SIL = 2 .

Comment: A level of SIL 3 could have been achieved by using mirror contacts to create a feedback loop on the contactors, i.e. a sub-system architecture type D.

**Checking the required SIL**

SIL	Probability of dangerous failures per hour (PFHd)
3	$\geq 10^{-8} \dots < 10^{-7}$
2	$\geq 10^{-7} \dots < 10^{-6}$
1	$\geq 10^{-6} \dots < 10^{-5}$

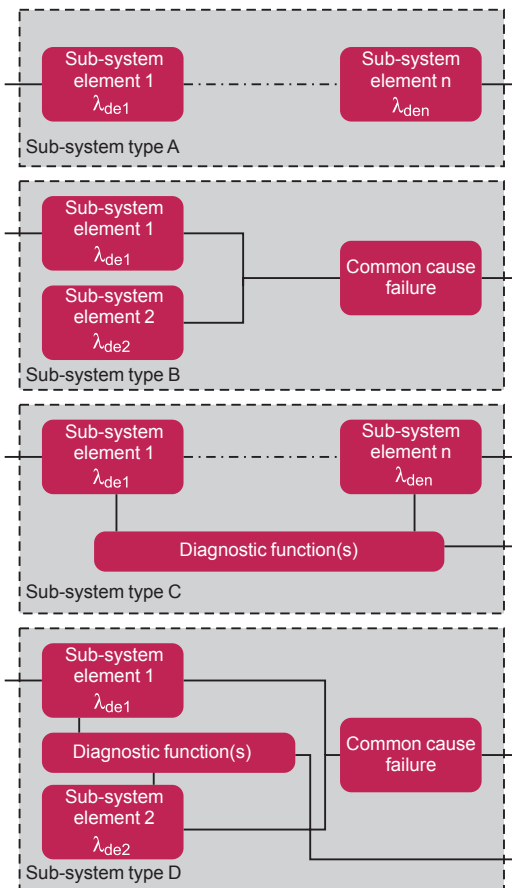

Types of sub-system architecture

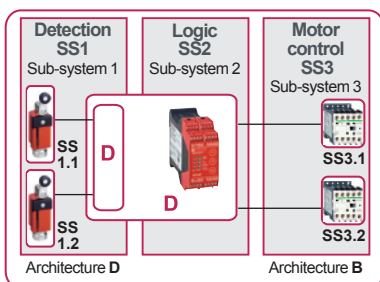

Stage 5: Design of the diagnostic function

# Chapter 2

# Safety chain solution



Technical information on products listed in this catalog is  
available at: [www.schneider-electric.com](http://www.schneider-electric.com)

■ Safety chain solutions

- Selection guide..... page 2/2
- Functions ..... pages 2/3 to 2/24

■ Safety functions with detailed description

- Emergency stop
  - > Explanation of function..... page 2/26
  - > Typical architecture..... page 2/26
- Guard monitoring
  - > Explanation of function..... page 2/27
  - > Typical architecture..... page 2/28
- Perimeter guarding
  - > Explanation of function..... page 2/29
  - > Typical architecture..... page 2/29
- Enabling movement
  - > Explanation of function..... page 2/30
  - > Typical architecture..... page 2/30
- Speed monitoring
  - > Explanation of function..... page 2/31
  - > Typical architecture..... page 2/32
- Position monitoring
  - > Explanation of function..... page 2/33
  - > Typical architecture..... page 2/33



Function	Processing device	Input / Output	Cat. PL, SIL / Stop Cat. <i>see page</i>	
<b>Emergency Stop</b> 	<b>with Embedded Safety Module</b>	Emergency Stop Pushbutton / Contactor	<b>Cat.3 PL d, SIL 2 / Stop Category 0</b> <i>see page 2/3</i>	
		Emergency Stop Pushbutton / Contactor	<b>Cat.4 PL e, SIL 3 / Stop Category 0</b> <i>see page 2/4</i>	
	<b>with Embedded Safety PLC</b>	Emergency Stop Push Button / PacDrive 3 Drive	<b>Cat.4 PL e, SIL 3 / Stop Category 0</b> <i>see page 2/5</i>	
<b>Guard Monitoring</b> 	<b>with Safety Module</b>	Limit switch / Contactor	<b>Cat.3 PL d, SIL 2 / Stop Category 0</b> <i>see page 2/6</i>	
		Coded Magnetic Switch / Variable Speed Drive	<b>Cat.4 PL e, SIL 3 / Stop Category 1</b> <i>see page 2/7</i>	
		Guard switch / Variable Speed Drive	<b>Cat.3 PL d, SIL 2 / Stop Category 1</b> <i>see page 2/8</i>	
		Coded Magnetic Switch / Servo Drive	<b>Cat.3 PL d, SIL 2 / Stop Category 1</b> <i>see page 2/9</i>	
		Guard switch / Contactor	<b>Cat.4 PL e, SIL 3 / Stop Category 0</b> <i>see page 2/10</i>	
		Coded Magnetic Switch / Contactor	<b>Cat.4 PL e, SIL 3 / Stop Category 0</b> <i>see page 2/11</i>	
		<b>with Embedded Safety Module</b>	Guard switch / Contactor	<b>Cat.4 PL e, SIL 3 / Stop Category 0</b> <i>see page 2/12</i>
		<b>with Safety Controller</b>	Limit Switch / Contactor	<b>Cat.4 PL e, SIL 3 / Stop Category 0</b> <i>see page 2/13</i>
		<b>with Embedded Safety PLC</b>	Guard Switch with lock/ PacDrive 3 Drive	<b>Cat.4 PL e, SIL 3 / Stop Category 1</b> <i>see page 2/14</i>
		<b>with Embedded Safety Servo Drive</b>	Coded Magnetic Switch / Embedded Safety Servo Drive	<b>Cat.4 PL e, SIL 3 / Stop Category 2</b> <i>see page 2/15</i>
	<b>with Well Tried Components</b>	Limit Switch / Motor Starter	<b>Cat.3 PL c, SIL 1 / Stop Category 0</b> <i>see page 2/16</i>	
<b>Enabling movement</b> 	<b>with Safety Controller</b>	Two Hand Control Station / Contactor	<b>Cat.4 PL e, SIL 3 / Stop Category 0</b> <i>see page 2/17</i>	
<b>Speed Monitoring</b> 	<b>with Safety Module</b>	Remanent Voltage detection and limit switch and Guard switch with lock / Contactor	<b>Cat.4 PL e, SIL 3 / Stop Category 0</b> <i>see page 2/18</i>	
	<b>with Embedded Safety PLC</b>	Selector Switch / PacDrive 3 Drive	<b>Cat.4 PL e, SIL 3 / Safe Limited Speed</b> <i>see page 2/19</i>	
<b>Position Monitoring</b> 	<b>with Embedded Safety PLC</b>	Limit Switch / PacDrive 3 Drive	<b>Cat.4 PL e, SIL 3 / Stop Category 2</b> <i>see page 2/20</i>	
<b>Perimeter Guarding</b> 	<b>with Safety Module</b>	Safety Mat / Contactor	<b>Cat.3 PL d, SIL 2 / Stop Category 0</b> <i>see page 2/21</i>	
		Single Beam Light curtains / Contactor	<b>Cat.3 PL c, SIL 1 / Stop Category 0</b> <i>see page 2/22</i>	
	<b>with Embedded Safety Module</b>	Light curtain / Contactor	<b>Cat.4 PL e, SIL 3 / Stop Category 0</b> <i>see page 2/23</i>	
		Light curtain / Variable Speed Drive	<b>Cat.3 PL d, SIL 2 / Stop Category 1</b> <i>see page 2/24</i>	

### Emergency Stop with Embedded Safety Module

Emergency Stop Pushbutton / Contactor  
Cat.3 PL d, SIL 2 / Stop Category 0

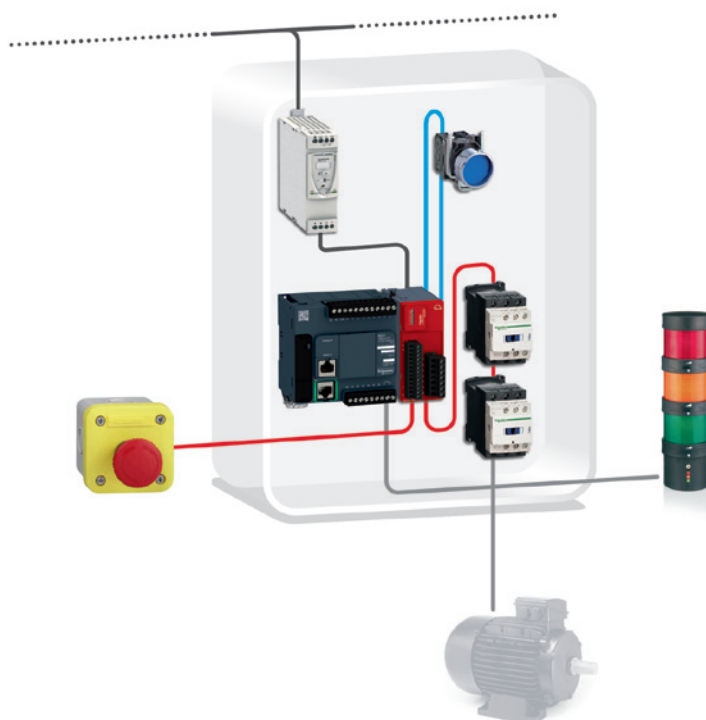
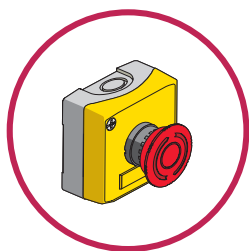

#### Related Products

- Switches, pushbuttons, emergency stop - Harmony XB4
- Switch mode Power supply - Phaseo ABL8
- Safety Module - Modicon TM3SAC5R(G)
- Safety switches - Preventa XCS
- Contactor - TeSys D
- Modular beacon and tower light - Harmony XVB

#### Function

Safety-related stop function initiated by Emergency stop push button to minimize the consequences of possibly harmful event.

The pushing of emergency stop push button is detected from opening contacts, which are checked by the safety module.

Opening these contacts causes the deactivation of the safety module outputs (stop category 0 according to EN/IEC 60204-1), which results in a switch-off of the motor power supply to minimize hazard in case of emergency by means of the contactors (K1 and K2).

#### Typical applications

- > Machine-tools or similar machines with low inertia (no rundown time), where the access to the hazardous area is limited to maintenance interventions

**Emergency Stop with Embedded Safety Module**  
**Emergency Stop Pushbutton / Contactor**  
**Cat.4 PL e, SIL 3 / Stop Category 0**

2

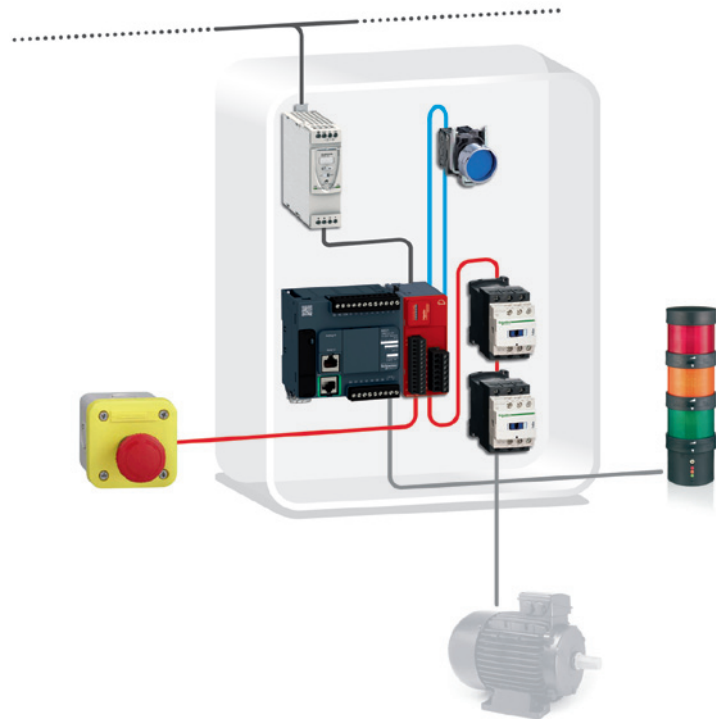
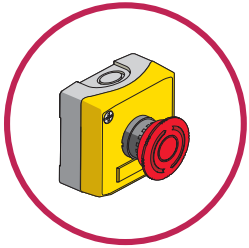

#### Related Products

- Switches, pushbuttons, emergency stop - Harmony XB4
- Switch mode Power supply - Phaseo ABL8
- Safety Module - Modicon TM3SAF5R(G)
- Safety switches - Preventa XCS
- Contactor - TeSys D
- Modular beacon and tower light - Harmony XVB

#### Function

Safety-related stop function initiated by Emergency stop push button to minimize the consequences of possibly harmful event.

The pushing of emergency stop push button is detected from opening contacts, which are checked by the safety module.

Opening these contacts causes the deactivation of the safety module outputs (stop category 0 according to EN/IEC 60204-1), which results in a switch-off of the motor power supply to minimize hazard in case of emergency by means of the contactors (K1 and K2).

The main contactors are monitored by the safety module to detect e.g. contact welding, by means of their mirror contacts.

#### Typical applications

- > Machine-tools or similar machines with low inertia (no rundown time), where the access to the hazardous area is limited to maintenance interventions



Emergency Stop with Embedded Safety  
PLC  
Emergency Stop Push Button / PacDrive 3  
Drive  
Cat.4 PL e, SIL 3 / Stop Category 0

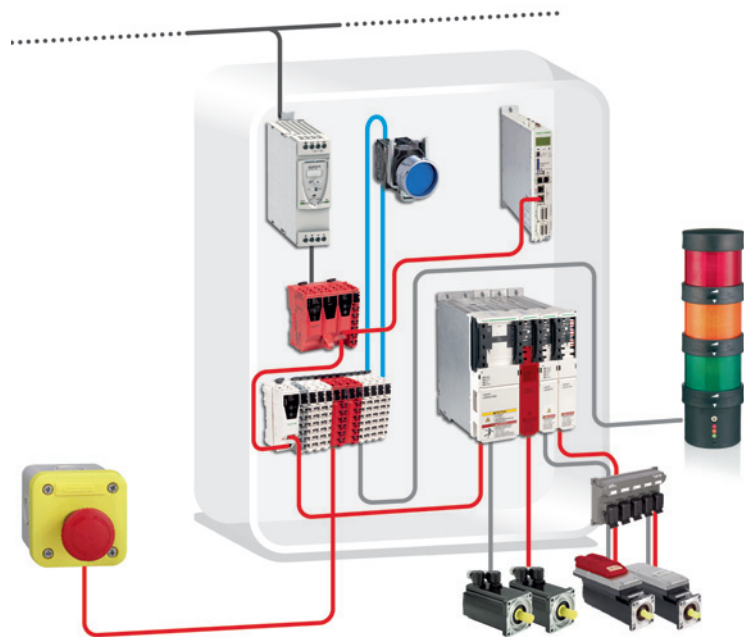
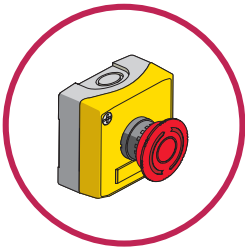

2

#### Related Products

- Switches, pushbuttons, emergency stop - Harmony XB4
- Switch mode Power supply - Phaseo ABL8
- Preventa Safety PLC TM5SLC●● (TM5SPS, SDIO, BC)
- Safety switches - Preventa XCS
- PacDrive 3
- Harmony XVB

#### Function

Safety-related stop function initiated by any stop or emergency stop command to halt the machine and to unlock the moveable guard that prevents the access to the hazardous area before the machine comes to a standstill.

Emergency stop command is detected by using an emergency stop push button in positive actuation mode, which are then checked by the safety PLC allowing detection of the opening contacts.

Actuation of the emergency stop or stop contacts initiates the functional stopping of the machine by cutting-off torque from the motor. As electric motors run down, a remanent voltage is produced in the windings of the motor due to residual magnetism. This voltage is measured so as to detect the stopped condition of the motor, providing the unlock signal for the electrically locked moveable guard and for engaging brakes after the motor has come to a standstill.

The continuity of the wiring between the motor windings and the inputs of the safety modules are also monitored to prevent a cable breakage or fault being seen as a stopped motor.

#### Typical applications

- > Machine tools, robots, production test equipment, test benches
- > Papermaking machines, textile production machines, calendars in the rubber industry
- > Process lines in plastics, chemicals or metal production, rolling-mills
- > Cement crushing machines, cement kilns, mixers, centrifuges, extrusion machines
- > Drilling machines
- > Conveyors, materials handling machines, hoisting equipment (cranes, gantries, etc.)
- > Pumps, fans, etc.

**Guard Monitoring with Safety Module**  
**Limit switch / Contactor**  
**Cat.3 PL d, SIL 2 / Stop Category 0**

2

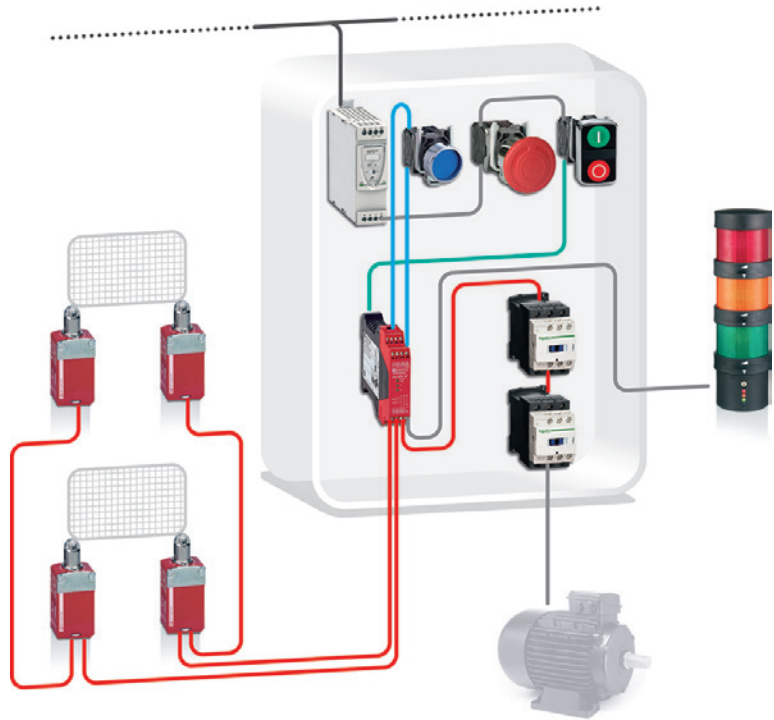

**Related Products**

- Switches, pushbuttons, emergency stop - Harmony XB4
- Switch mode Power supply - Phaseo ABL8
- Safety Module - Preventa XPSAC
- Safety switches - Preventa XCS
- Contactor - TeSys D
- Modular beacon and tower light - Harmony XVB

**Function**

Safety-related stop function initiated by the moveable guards designed to help protecting from the the access to a hazardous zone. The opening of each guard is detected by using two limit switches in combination mode (positive mode + negative mode), which are checked by the safety module allowing detection of the opening or the removal of the protective guard. Opening of any of these guards causes the deactivation of the safety module outputs (stop category 0 according to EN/IEC 60204-1), which results in a switch-off of the motor power supply to prevent possible hazardous movements or states by means of the contactors (K1 and K2). The main contactors are monitored by the safety module to detect e.g. contact welding, by means of their mirror contacts.

**Typical applications**

- > Assembling, textile, printing or similar machines where the access to the hazardous area is limited to maintenance interventions

Guard Monitoring with Safety Module  
Coded Magnetic Switch -  
Variable Speed Drive  
Cat.4 PL e, SIL 3 / Stop Category 1

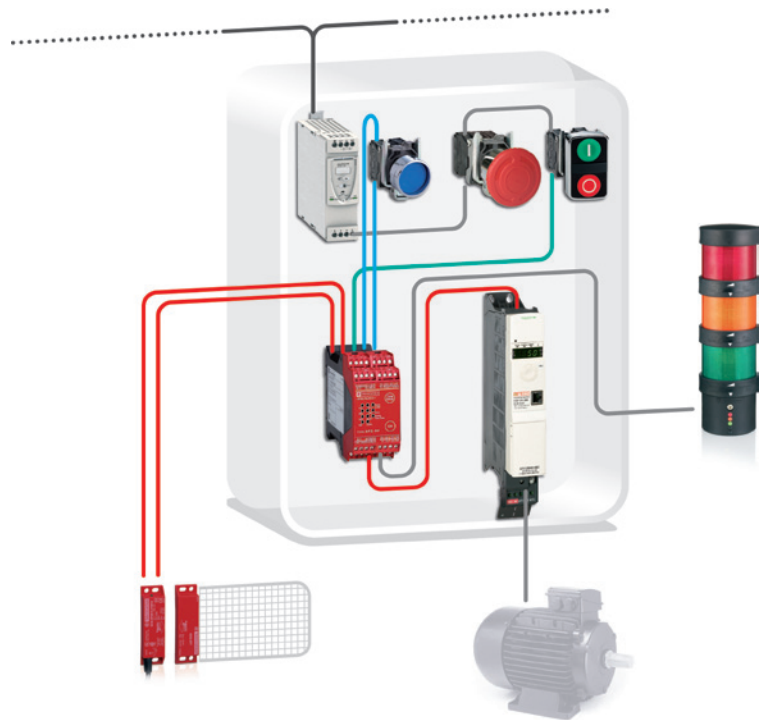

#### Related Products

- Switches, pushbuttons, emergency stop - Harmony XB4
- Safety Module - Preventa XPSAV
- Coded magnetic switches - Preventa XCSDM
- Variable speed drive - Altivar 32
- Modular beacon and tower lights -Harmony XVB
- Switch mode Power supply - Phaseo ABL8

#### Function

Safety-related stop function initiated by a moveable guard that helps protecting from the access to the hazardous area.

Controlled stopping with power maintained to the actuator (drive) to achieve stopping (i.e. braking), then cut-off of power when standstill is reached (Safe Stop 1). The hazardous movement is interrupted either if the stop button (S2) or the emergency stop device (S3) is actuated.

Opening of this guard is detected by a magnetic switch, which initiates the functional stopping of the drive, i.e. by a braking ramp (stop category 1 in accordance with EN/IEC 60204-1).

After the delay time monitored by the safety module has elapsed, the safety delayed outputs are deactivated. The drive is then halted, by the "safe torque off" (STO) safety function integrated within it, which prevents the motor from restarting unintentionally.

The switching of the STO and LI3 input is monitored by the drive. The power stage is disabled if the time offset is exceeded. The motor can no longer generate torque and coasts down without braking.

The safety module also monitors the consistent actuation of the redundant coded magnetic switch contacts to detect possible failure, before restart of the machine movement is permitted.

#### Typical applications

- > Machines that use drives in their movements due to high speed and precision needed (i.e. textile, wood-working or simple packaging machines), when the delayed initiation of the stopping in the event of a fault must not involve an unacceptably high residual risk

Guard Monitoring with Safety Module  
Guard switch / Variable Speed Drive  
Cat.3 PL d, SIL 2 / Stop Category 1

2

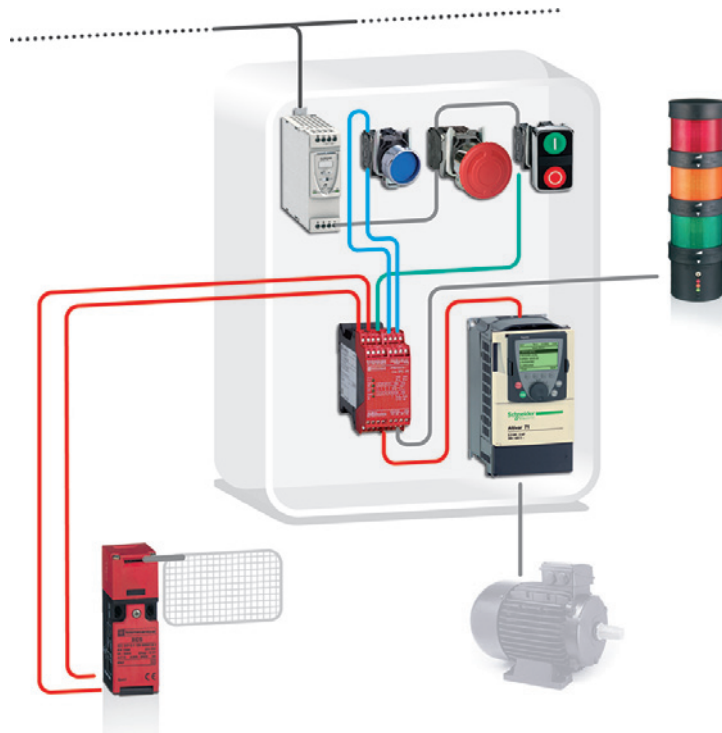

#### Related Products

- Switches, pushbuttons, emergency stop - Harmony XB4
- Emergency stop function - Harmony XALK
- Switch mode Power supply - Phaseo ABL8
- Safety Guard switches - Preventa XCSB, XCS
- Safety module - Preventa XPSATE
- Variable speed drive - Altivar 71
- Modular beacon and tower lights - Harmony XVB

#### Function

Safety-related stop function initiated by a moveable guard that helps protecting from the access to the hazardous area.

Controlled stopping with power maintained to the actuator (drive) to achieve stopping (i.e. braking), then cut-off of power when standstill is reached (Safe Stop 1). The hazardous movement is interrupted either if the stop button (S2) or the emergency stop device (S3) is actuated. (\*)

Opening of this guard is detected by a safety guard switch, which initiates the functional stopping of the drive, i.e. by a braking ramp (stop category 1 in accordance with EN/IEC 60204-1).

After the delay time monitored by the safety module has elapsed, the safety delayed outputs are deactivated. The drive is then halted, by the "safe torque off" (STO) safety function integrated within it, which prevents the motor from restarting unintentionally.

The safety module also monitors the consistent actuation of the redundant guard switch contacts to detect possible failure, before restart of the machine movement is permitted.

(\*) The function for stopping in an emergency is a protective measure which complements the safety functions for the safeguarding of hazardous zones according to EN/ISO 12100-2.

#### Typical applications

- > Machines that use drives in their movements due to high speed and precision needed (i.e. stacker-cranes used on automatic storage and retrieval systems), when the delayed initiation of the stopping in the event of a fault must not involve an unacceptably high residual risk

Guard Monitoring with Safety Module  
Coded Magnetic Switch / Servo Drive  
Cat.3 PL d, SIL 2 / Stop Category 1

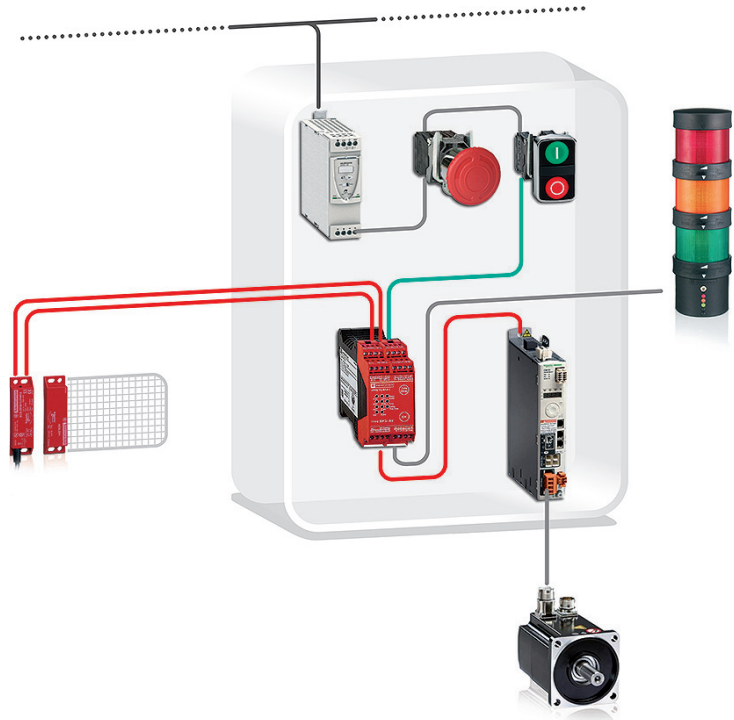

#### Related Products

- Switches, pushbuttons, emergency stop - Harmony XB4
- Switch mode Power supply - Phaseo ABL8
- Coded magnetic system - Preventa XCSDM
- Safety Module - Preventa XPSAV
- Servo Drive - Lexium 32
- Modular beacon and tower lights - Harmony XVB

#### Function

Safety-related stop function initiated by any of the moveable guards that helps protecting from the access to the hazardous area.

Controlled stop with power available to the actuators (servo-drive) to achieve the stop (i.e. by controlled braking). Power is not interrupted until the stop is achieved (Safe Stop 1).

After activating the function, the servo motor is braked in a controlled manner, maintaining the power on the actuators. The power is then cut after the machine has come to a halt.

Opening of a guard is detected by a coded magnetic switch system that activates via the safety module the "Halt" function on the servo-drive; any active movement is decelerated via the adjusted ramp.

After the delay time monitored by the safety module has elapsed, the safety delayed outputs (stop category 1 in accordance with EN/IEC 60204-1) are deactivated. The servo-drive power stage is then disabled, via the "safe torque off" (STO) safety function integrated within it, which prevents the servo-motor from restarting unintentionally.

The switching of the two redundant STO inputs is monitored by the servo-drive. The power stage is disabled and an error message is generated if the time offset (< 1 sec) is exceeded. The servo-motor can no longer generate torque and coasts down without braking.

The safety module also monitors the consistent actuation of the magnetic switch contacts to detect possible failure, before restart of the machine movement is permitted.

Opening or removal of the protective guard is detected by means of the coded magnetic switch system, which are particularly usable for guards without accurate guidance and for use in difficult environments (dust, liquids, etc.).

#### Typical applications

- > Packaging, printing, or similar machines that use servo-drives in their movements due to high speed and precision needed, on which non-braking stopping would result in a impermissibly long run-down of the hazardous tool movements

Guard Monitoring with Safety Module  
Guard switch / Contactor  
Cat.4 PL e, SIL 3 / Stop Category 0

2

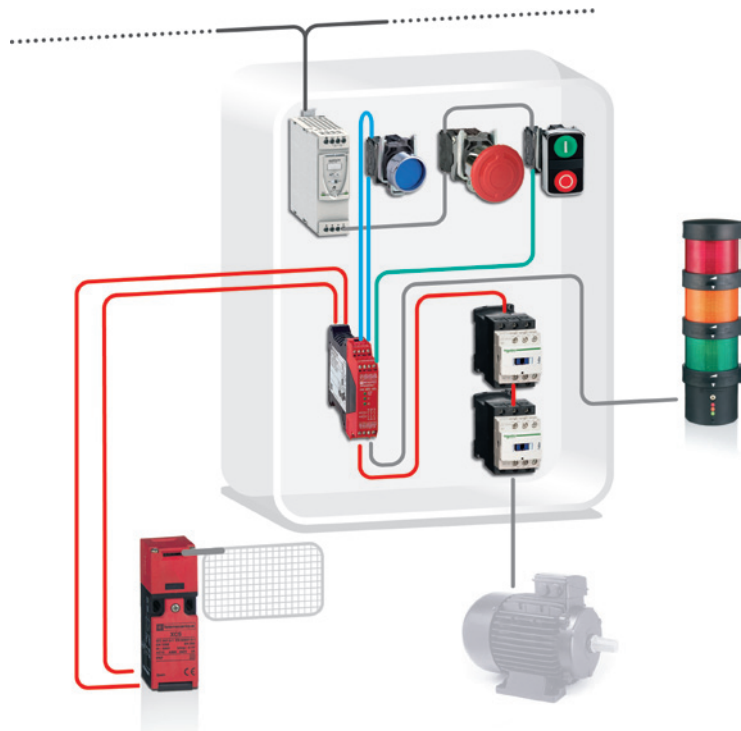

#### Related Products

- Switches, pushbuttons, emergency stop - Harmony XB4
- Switch mode Power supply - Phaseo ABL8
- Safety Module - Preventa XPSAF
- Safety Guard switches - Preventa XCSB, XCS
- Contactor - TeSys D
- Modular beacon and tower light - Harmony XVB

#### Function

Safety-related stop function initiated by a moveable guard designed to help protecting from the access to a hazardous zone.

The opening of this guard is detected by using a guard switch, which is checked by the safety module allowing detection of the opening or the removal of the protective guard according to EN1088.

Opening of this guard causes the deactivation of the safety module outputs (stop category 0 according to EN/IEC 60204-1), which results in a switch-off of the motor power supply to prevent possible hazardous movements or states by means of the contactors (K1 and K2).

The main contactors are monitored by the safety module to detect e.g. contact welding, by means of their mirror contacts.

#### Typical applications

- > Assembling, machining centers or similar machines tools, where the access to the hazardous area is frequent or with long exposure time

Guard Monitoring with Safety Module  
Coded Magnetic Switch / Contactor  
Cat.4 PL e, SIL 3 / Stop Category 0

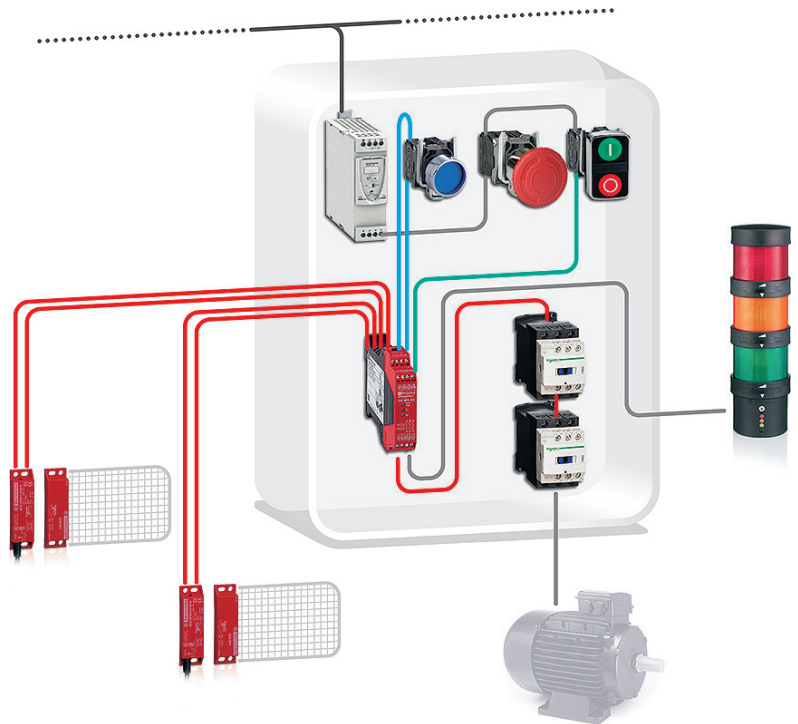

2

#### Related Products

- Switches, pushbuttons, emergency stop - Harmony XB4
- Switch mode Power supply - Phaseo ABL8
- Safety Module - Preventa XPSDM
- Coded magnetic system - Preventa XCSDM
- Contactor - TeSys D
- Modular beacon and tower light - Harmony XVb

#### Function

Safety-related stop function initiated by any of the moveable guards that helps protecting from the access to the hazardous area.

The opening of each guard is detected by using magnetic switches, which are checked by the safety module by means of a combination of contacts (normally closed and normally open).

Opening of any of these guards causes the deactivation of the safety module outputs, which results in the switching-off of the motor power supply by means of the contactors K1 and K2 (stop category 0 according to EN/IEC 60204-1) to help prevent possible hazardous movements or states.

The main contactors are monitored by the safety module to detect contact welding by means of the mirror contacts.

The safety module also monitors the consistent actuation of the magnetic switch contacts to detect any failure, before restart of the machine movement is permitted. Opening or removal of the protective guard is detected by means of the coded magnetic switches, which are particularly useful for guards without accurate guidance and for use in difficult environments (dust, liquids, etc.).

#### Typical applications

- > Assembling, packaging or similar compacted machines with a short rundown time and where the access to the hazardous area is very frequent

**Guard Monitoring with Embedded Safety Module**

Guard switch / Contactor  
 Cat.4 PL e, SIL 3 / Stop Category 0

2

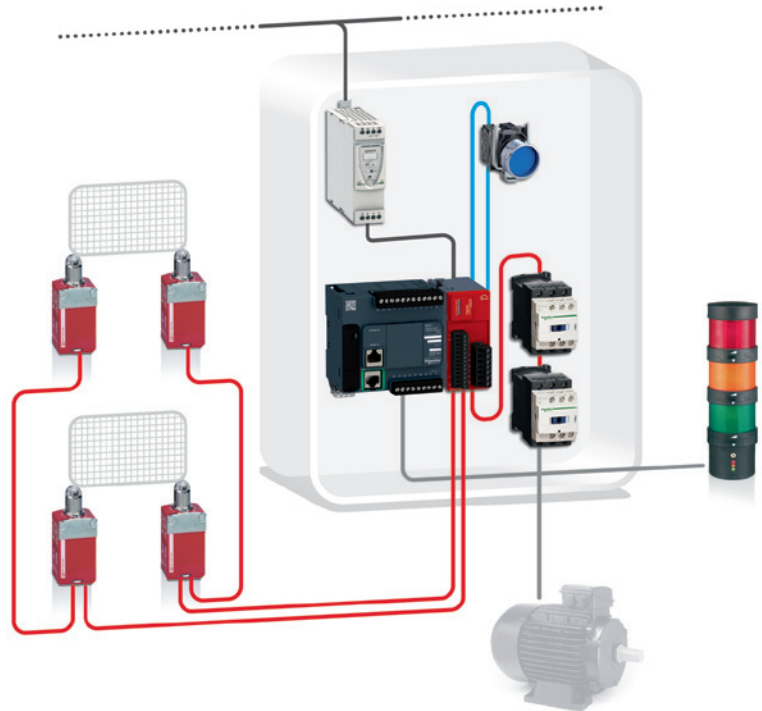

**Related Products**

- Switches, pushbuttons, emergency stop - Harmony XB4
- Switch mode Power supply - Phaseo ABL8
- Safety Module - Modicon TM3SAF5R(G)
- Safety switches - Preventa XCS
- Contactor - TeSys D
- Modular beacon and tower light - Harmony XVB

**Function**

Safety-related stop function initiated by a moveable guard designed to help protecting from the access to a hazardous zone.  
 The opening of this guard is detected by using a guard switch, which is checked by the safety module allowing detection of the opening or the removal of the protective guard according to EN1088.  
 Opening of this guard causes the deactivation of the safety module outputs (stop category 0 according to EN/IEC 60204-1), which results in a switch-off of the motor power supply to prevent possible hazardous movements or states by means of the contactors (K1 and K2).  
 The main contactors are monitored by the safety module to detect e.g. contact welding, by means of their mirror contacts.

**Typical applications**

- > Assembling, machining centers or similar machines tools, where the access to the hazardous area is frequent or with long exposure time



Guard Monitoring with Safety Controller  
Limit Switch / Contactor  
Cat.4 PL e, SIL 3 / Stop Category 0

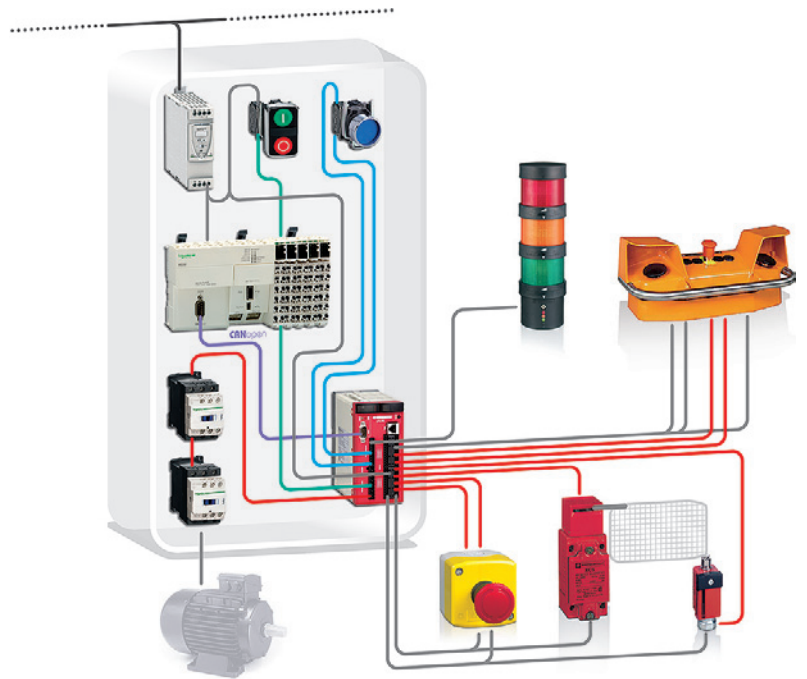

2

#### Related Products

- Switches, pushbuttons - Harmony XB4
- Emergency stop control station - Harmony XALK
- Two-Hand control station - Preventa XY2 SB
- Switch mode Power supply - Phaseo ABL8
- Logic controller - Modicon M258
- Guard interlock switch and safety
- switches - Preventa XCS
- Safety Controller - Preventa XPS MC
- Contactor - TeSys D
- Modular beacon and tower light - Harmony XVB

#### Function

Safety-related stop function initiated by a moveable guard that helps protecting from the access to a hazardous zone.

The guard opening is detected by using a solenoid locked switch in combination with a limit switch in positive operating mode, which are checked by the safety module allowing detection of the opening or removal of the protective guard.

Opening of the moveable guard causes the deactivation of the safety module outputs which results in switching-off the motor power supply by means of the contactors K1 and K2 to help prevent possible hazardous movements (stop category 0 according to EN/IEC 60204-1).

The motor can be also de-energized when the emergency stop device (S1) is actuated.\*

The main contactors are monitored by the safety controller to detect for example contact welding, by means of the mirror contacts.

The safety controller also monitors the consistent actuation of the limit switch contacts to detect failure, before restart of the machine movement is permitted.\*

(\* ) The function for stopping in an emergency is a protective measure which complements the safety functions for the safeguarding of hazardous zones according to EN/ISO 12100-2.

#### Typical applications

- > Plastic injection, eccentric press or similar complex machines with 4 or more safety functions included, where a centralized safety controller would be required

### Guard Monitoring with Embedded Safety PLC

Guard Switch with lock/ PacDrive 3 Drive  
Cat.4 PL e, SIL 3 / Stop Category 1

2

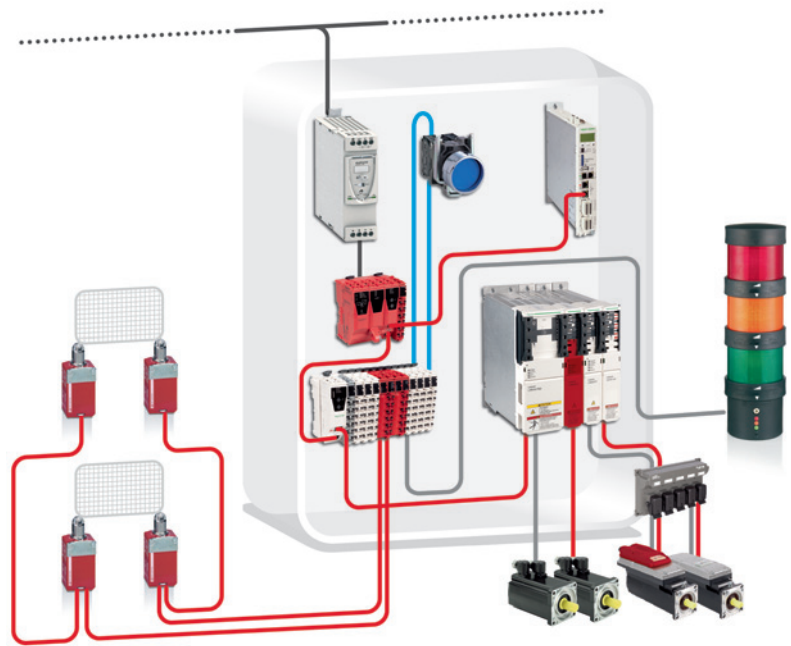

#### Related Products

- Switches, pushbuttons, emergency stop - Harmony XB4
- Switch mode Power supply - Phaseo ABL8
- Preventa Safety PLC TM5SLC●● (TM5 Slices > SPS, SDIO, BC)
- Safety switches - Preventa XCS
- PacDrive 3
- Harmony XVB

#### Function

Safety-related stop function initiated by a moveable guard that helps preventing access to the hazardous area.

Controlled stopping with power maintained to the actuator (drive) to achieve stopping (i.e. braking), then cut-off of power when standstill is reached (Safe Stop 1). The hazardous movement is interrupted either if the stop button or the emergency stop device is actuated. Opening of this guard is detected by limit switches, which initiates the functional stopping of the drive, i.e. by a braking ramp (stop category 1 in accordance with EN/IEC 60204-1).

After the delay time monitored by the drive has elapsed, drive halts itself, by the "safe torque off" (STO) safety function integrated within it, which prevents the motor from restarting unintentionally. The switching of the STO and input is monitored by the drive. When the motor can no longer generate torque, the safety PLC is notified and it can provide the unlock signal for the electrically locked movable guard or engaging brakes.

The safety module also monitors the consistent actuation of the redundant limit switch contacts to detect possible failure, before restart of the machine movement is permitted.

#### Typical applications

- > Machine tools, robots, production test equipment, test benches
- > Papermaking machines, textile production machines, calendars in the rubber industry
- > Process lines in plastics, chemicals or metal production, rolling-mills
- > Cement crushing machines, cement kilns, mixers, centrifuges, extrusion machines
- > Drilling machines
- > Conveyors, materials handling machines, hoisting equipment (cranes, gantries, etc.)
- > Pumps, fans, etc.

Guard Monitoring with Embedded Safety  
Servo Drive  
Coded Magnetic Switch / Embedded Safety  
Servo Drive  
Cat.4 PL e, SIL 3 / Stop Category 2

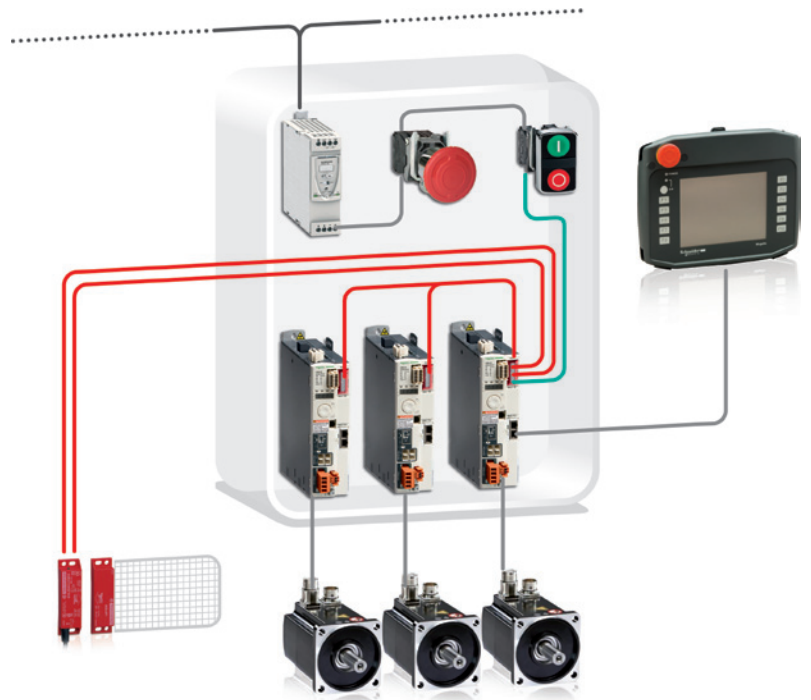

2

#### Related Products

- Switches, pushbuttons, emergency stop - Harmony XB4
- Guard switches - Preventa XCSLE
- Enhanced Safety Module (eSM) - Lexium 32M
- Servo drive - Lexium 32M
- Human machine interface - Magelis XBT GH
- Modular beacon and tower lights - Harmony XVB
- Switch mode Power supply - Phaseo ABL8

#### Function

Safety-related stop function realized by a moveable guard that helps protecting from the access to the hazardous area.

The hazardous movement is interrupted either if the stop button (S2) or the emergency stop device (S3) is actuated, which initiates the functional stopping of the servo-drive, i.e. by a deceleration ramp.

The Safe Stop 2 safety function is used to achieve a category 2 safe stop in accordance with EN/IEC 61800-5-2, where the servo motor is braked in a controlled manner, maintaining the power on the actuators.

The safety function SS2 (Safe Stop 2), integrated in the enhanced safety module (eSM) card, monitors the deceleration and the standstill position.

When the SS2 function is triggered, a deceleration of movement is monitored with the specified monitoring ramp up to standstill. The motor is then immobilized by the "safe operating stop" (SOS) function, which is used to monitor any deviation from the standstill position.

If the monitored deceleration ramp is violated or the monitored standstill position is not maintained, the drive is halted by the "safe torque off" (STO) function, which prevents the motor from restarting unintentionally.

The eSM card also monitors the consistent actuation of the redundant switch contacts from the magnetic switch to detect possible failure, before restart of the machine movement is permitted.

#### Typical applications

- > Packaging, printing, or similar machines that use servo-drives in their movements due to high speed and precision needed, on which non-braking stopping would result in a impermissibly long run-down of the hazardous tool movements

2

**Guard Monitoring with Well Tried Components**  
**Limit Switch / Motor Starter**  
**Cat.3 PL c, SIL 1 / Stop Category 0**

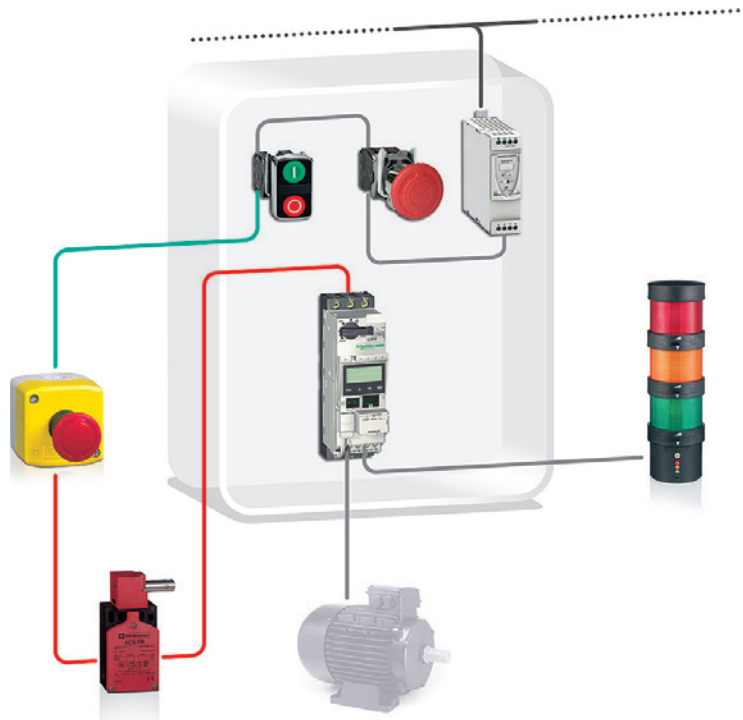

**Related Products**

- Switches, pushbuttons, emergency stop - Harmony XB4
- Emergency stop function - Harmony XALK
- Switch mode Power supply - Phaseo ABL8
- Motor starter - TeSys U
- Safety Guard switches - Preventa XCS
- Modular beacon and tower lights - Harmony XVB

**Function**

Stop function initiated by a moveable protective guard.  
 Opening of this guard is detected by a guard switch, which interrupts the control voltage of the motor starter (stop category 0 according to EN/IEC 60204-1) to help preventing possible hazardous movements.  
 The break contact of this guard switch interrupts the control circuit directly when the protective guard is not in the safe position.  
 The motor is also de-energized when either of the emergency stop devices (S1 or S2) are actuated.(\*)  
 The safety function is fully dependent upon the reliability of the components.

(\* ) The function for stopping in an emergency is a protective measure which complements the safety functions for the safeguarding of hazardous zones according to EN/ISO 12100-2.

**Typical applications**

- > Machine-tools or similar machines with low inertia (no rundown time), where the access to the hazardous area is limited to maintenance interventions

Enabling movement with Safety Controller  
Two Hand Control Station / Contactor  
Cat.4 PL e, SIL 3 / Stop Category 0

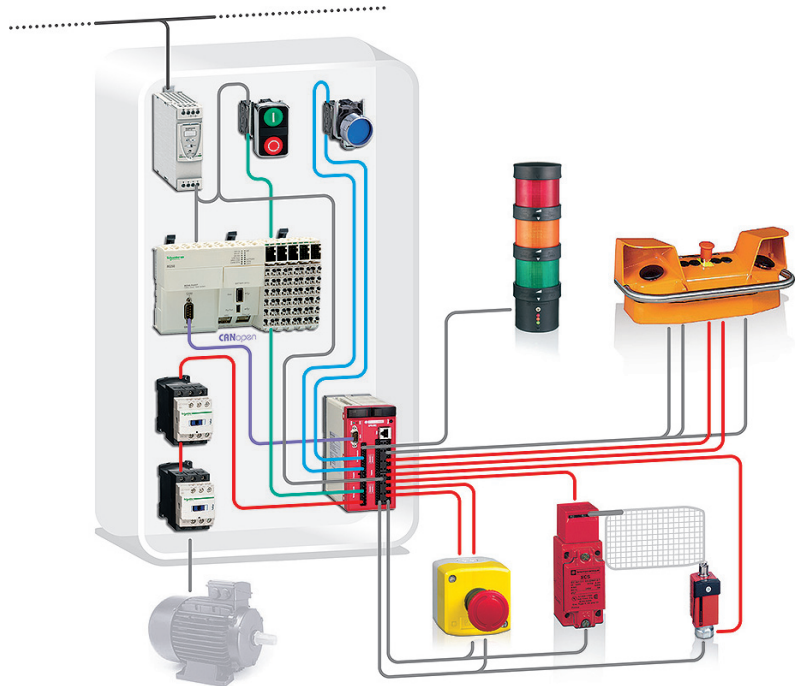
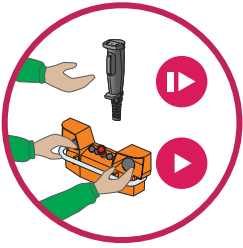

2

#### Related Products

- Switches, pushbuttons - Harmony XB4
- Emergency stop control station - Harmony XALK
- Two-Hand control station - Preventa XY2SB
- Switch mode Power supply - Phaseo ABL8
- Logic controller - Modicon M258
- Guard interlock switch - Preventa XCS
- Safety Controller - Preventa XPS MC
- Contactor - TeSys D
- Modular beacon and tower light - Harmony XVB

#### Function

Safety-related function to help control the location of the operator's hands outside the hazardous area during a hazardous movement of the machine.

To initiate a movement, both actuators (two-hand control pushbuttons S3 and S4) must be activated synchronously (within an interval less than 0,5 sec.) to energize the contactors (K1 and K2). When at least one of the two pushbuttons is released, the energization is cancelled and remains blocked until both pushbuttons are released and pressed again synchronously.

The logic device (Safety Controller) monitors operation of the actuators (pushbuttons). Faults in the actuating mechanism as well as the cable wiring are detected in S3/S4 by the use of two contacts employing a normally open (NO) and normally closed (NC) combination.

Faults in K1/K2 (with mirror contacts) are detected in the safety controller and lead to de-energization of the contactors (K1 and K2).

#### Typical applications

- > Hydraulic, eccentric press or similar complex machines with 4 or more safety functions included, where a centralized safety controller would be required

Speed Monitoring with Safety Module  
 Remanent Voltage detection and limit  
 switch and Guard switch with lock /  
 Contactor  
 Cat.4 PL e, SIL 3 / Stop Category 0

2

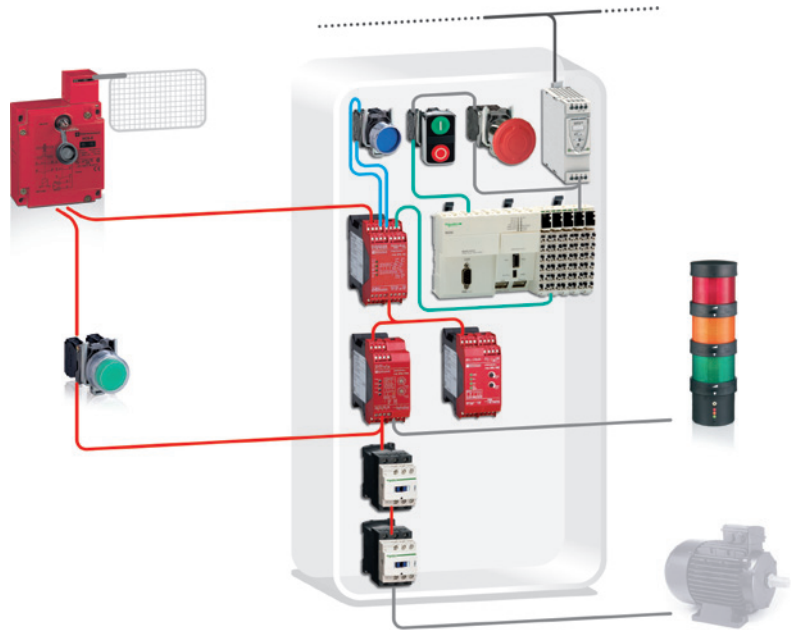
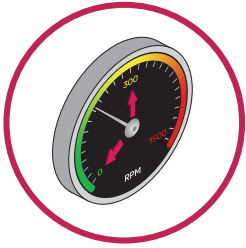

#### Related Products

- Switches, pushbuttons, emergency stop - Harmony XB4
- Switch mode Power supply - Phaseo ABL8
- Logic controller - Modicon M258
- Guard lock switch - Preventa XCSE
- Safety Module - Preventa XPS
- Contactor - TeSys D
- Modular beacon and tower lights - Harmony XVB

#### Function

Safety-related stop function initiated by any stop or emergency stop command to halt the machine and to unlock the moveable guard that prevents the access to the hazardous area before the machine comes to a standstill. Guard opening is detected by using a solenoid locking guard switch in combination with a limit switch in positive actuation mode, which are then checked by the safety module allowing detection of the opening or removal of the protective guard. Actuation of the emergency stop or stop contacts initiates the functional stopping of the machine by switching-off the motor power supply. As electric motors run down, a remanent voltage is produced in the windings of the motor due to residual magnetism. This voltage is measured so as to detect the stopped condition of the motor, providing the unlock signal for the electrically locked movable guard and for engaging brakes after the motor has come to a standstill. The continuity of the wiring between the motor windings and the inputs of the safety module is also monitored to prevent a cable breakage or fault being seen as a stopped motor. The main contactors are monitored by the safety modules by means of the mirror contacts to detect e.g. contact welding. The safety modules also monitor the consistent actuation of the limit switch contacts to detect failure, before restart of the machine movement is permitted.

#### Typical applications

- > On metal, wood work or similar high inertia machines with a long run-down of the hazardous tool movements, and where an electronically interlock guard is used to protect the hazardous area

### Speed Monitoring with Embedded Safety PLC

Selector Switch / PacDrive 3 Drive  
Cat.4 PL e, SIL 3 / Safe Limited Speed

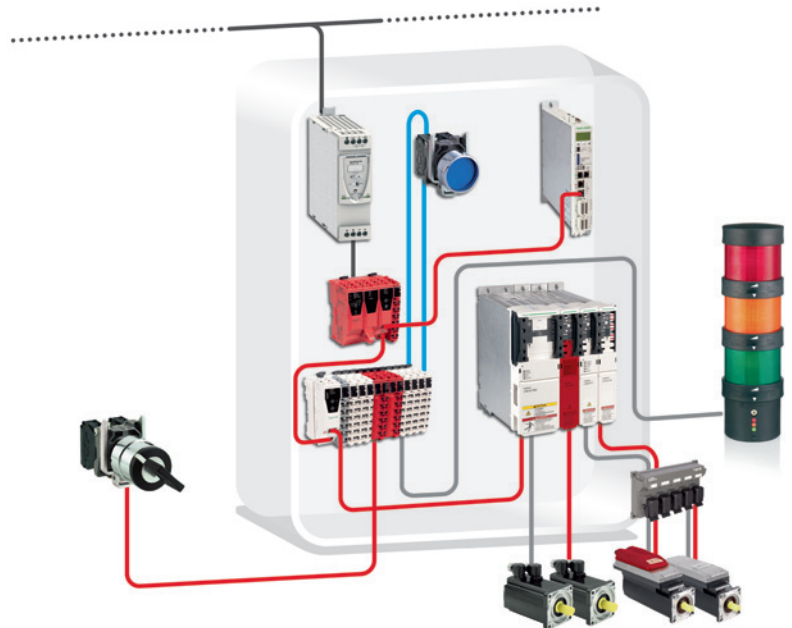
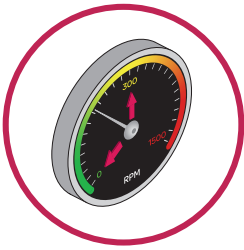

#### Related Products

- Switches, pushbuttons, emergency stop - Harmony XB4
- Switch mode Power supply - Phaseo ABL8
- Preventa Safety PLC TM5SLC●● (TM5 Slices> SPS, SDIO, BC)
- Safety switches - Preventa XCS
- PacDrive 3
- Harmony XVB

#### Function

Safety-related Speed monitoring function initiated by a safe command to control the machine and to unlock the moveable guard that prevents the access to the hazardous area before the machine comes to a safe speed.

Selector switch status change is detected by using a selector switch or standard PLC signal for change in operating mode, which are then checked by the safety PLC allowing detection of the change in operating mode of the machine.

Actuation of the selector switch or standard PLC signal initiates the control rampdown of the machine by drive controller. As electric motors run down, monitored by built in encoder, then speed will be continuously monitored. If at any time the speed of the motor exceeds the specified limit, SS1 or STO function is initiated for monitored stop or free whiling stop.

The continuity of the wiring between the motor windings and the inputs of the safety modules are also monitored to prevent a cable breakage or fault being seen as a stopped motor.

The safety modules also monitor the consistent actuation of the limit switch contacts to detect failure, before restart of the machine movement is permitted.

#### Typical applications

- > Machine tools, robots, production test equipment, test benches
- > Papermaking machines, textile production machines, calendars in the rubber industry
- > Process lines in plastics, chemicals or metal production, rolling-mills
- > Cement crushing machines, cement kilns, mixers, centrifuges, extrusion machines
- > Drilling machines
- > Conveyors, materials handling machines, hoisting equipment (cranes, gantries, etc.)
- > Pumps, fans, etc.

**Position Monitoring with Embedded Safety PLC**  
**Limit Switch / PacDrive 3 Drive**  
**Cat.4 PL e, SIL 3 / Stop Category 2**

2

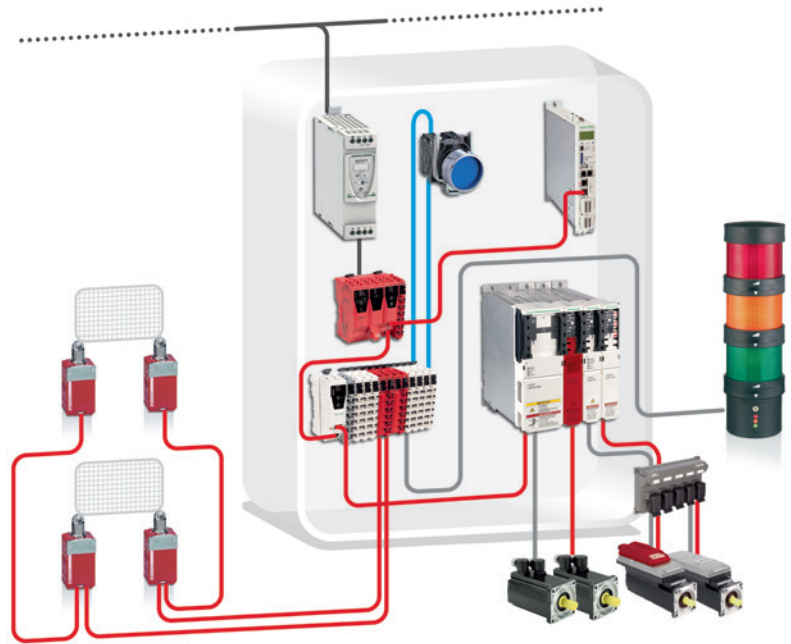
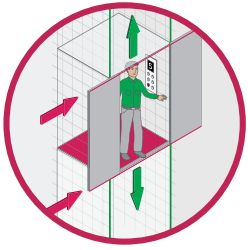

**Related Products**

- Switches, pushbuttons, emergency stop - Harmony XB4
- Switch mode Power supply - Phaseo ABL8
- Preventa Safety PLC TM5SLC●● (TM5 Slices> SPS, SDIO, BC)
- Safety Switches - Preventa XCS
- PacDrive 3
- Harmony XVB

**Function**

Safety-related stop function initiated by any stop or emergency stop command to halt the machine and to unlock the moveable guard that prevents the access to the hazardous area before the machine comes to a standstill. Guard opening is detected by using a Coded magnetic switch, which are then checked by the safety PLC allowing detection of the opening or removal of the protective guard. Actuation of the stop contacts initiates the functional stopping of the machine by control ramp down of the motor then monitor the motor position, for the stand still. If the position of the motor is violated the SS1 or STO will be initiated. The continuity of the wiring between the motor windings and the inputs of the safety modules are also monitored to prevent a cable breakage or fault being seen as a stopped motor. The main contactors are monitored by the safety modules by means of the mirror contacts to detect e.g. contact welding. The safety modules also monitor the consistent actuation of the coded magnetic switch contacts to detect failure, before restart of the machine movement is permitted.

**Typical applications**

- > Machine tools, robots, production test equipment, test benches
- > Papermaking machines, textile production machines, calendars in the rubber industry
- > Process lines in plastics, chemicals or metal production, rolling-mills
- > Cement crushing machines, cement kilns, mixers, centrifuges, extrusion machines
- > Drilling machines
- > Conveyors, materials handling machines, hoisting equipment (cranes, gantries, etc.)
- > Pumps, fans, etc.



Perimeter Guarding with Safety Module  
 Safety Mat / Contactor  
 Cat.3 PL d, SIL 2 / Stop Category 0

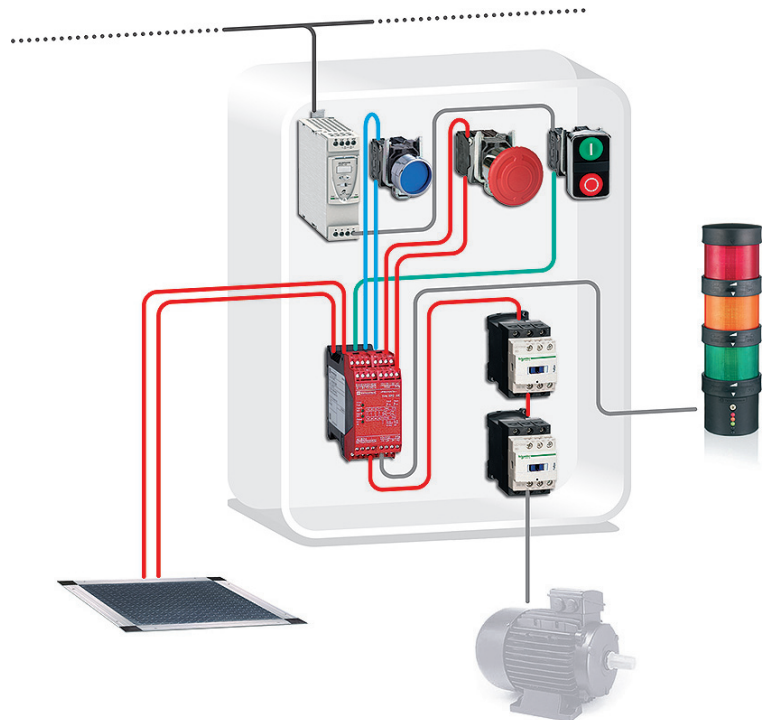
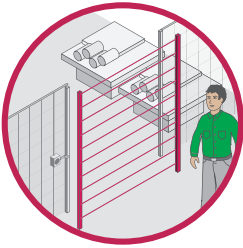

#### Related Products

- Switches, pushbuttons, emergency stop - Harmony XB4
- Switch mode Power supply - Phaseo ABL8
- Safety Module - Preventa XPSAK
- Safety Mats - Preventa XY2TP
- Contactor - Tesys D
- Modular beacon and tower lights - Harmony XVB

#### Function

Safety-related stop function initiated by any of the safety mats installed around the different potentially hazardous zones defined by the dangerous movement of the machine.

The hazardous movement is interrupted either if the emergency stop device (S1) or any of the safety mats (SM1 or SM2) is actuated.

Stepping on the safety mat deactivates the safety module outputs, which results in the switching-off of the motor power supply by means of the contactors K1 and K2 (stop category 0 in accordance with EN/IEC 60204-1) in order to prevent possible hazardous movements or states.

The safety mat provides a protection zone between machine operator and any dangerous movements and enables free access for the loading and unloading of the machine.

The safety module monitors the consistent actuation of the redundant safety mat contacts to detect possible failures.

The main contactors are also monitored by the safety module by means of the mirror contacts, to detect contact welding.

The resetting of the function can be performed manually or automatically, depending on the configuration of the safety module, before renewed start-up of the machine movement. (\*)

(\*) The function for stopping in an emergency is a protective measure which complements the safety functions for the safeguarding of hazardous zones according to EN/ISO 12100-2.

#### Typical applications

- > Machines which use a free and very frequent access to the hazardous area, where a high number of interventions are needed

Perimeter Guarding with Safety Module  
Single Beam Light curtains / Contactor  
Cat.3 PL c, SIL 1 / Stop Category 0

2

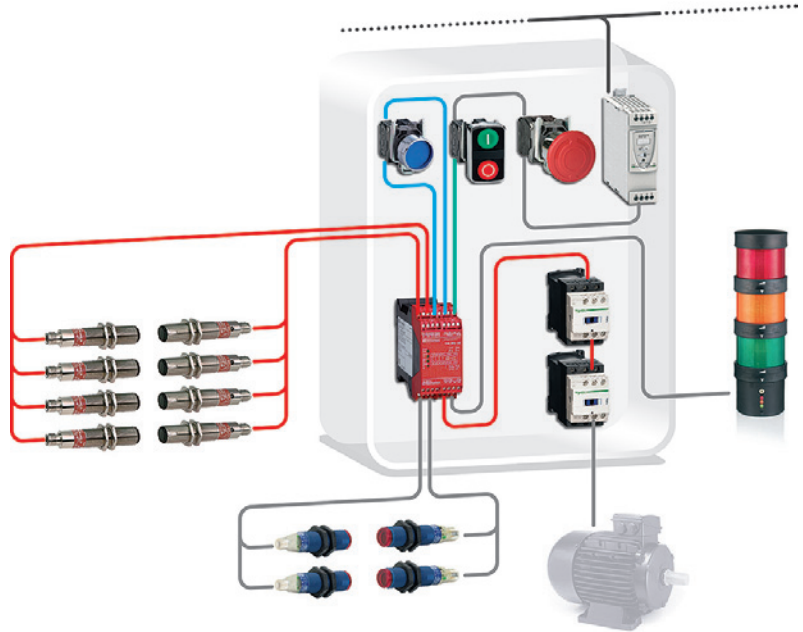
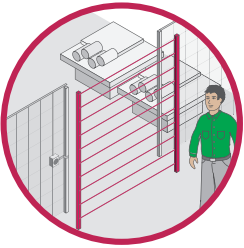

**Related Products**

- Switches, pushbutton, emergency stop - Harmony XB4
- Switch mode Power supply - Phaseo ABL8
- Safety light curtains, single-beam for body detections - Preventa XU2S
- Photo-electric sensors - OsiSense XU
- Safety Module - Preventa XPSCM
- Contactor - Tesys D
- Modular beacon and tower lights - Harmony XVB

**Function**

Safety-related stop function initiated by several single-beam photo-electric devices used as protective equipment (ESPE Type 2 according to EN/IEC 61496-1 and EN/IEC 61496-2).

An interruption of the detection field causes the safety outputs to open. The deactivation of the safety outputs results in the switching-off of the motor power supply by means of the contactor (K1) to help to prevent possible hazardous movements or states. The photo-electric devices (B1...B4) are cyclically tested and monitored by the safety module to detect possible failures.

A muting function can be enabled by means of photo-electric sensors (A1, A2). It allows the light curtain's detection function to be temporarily inhibited without triggering the stop function.

During the muting time interval, materials can be transported through the hazardous area and the muting indicator light (H1) indicates to the operator this temporary disabling of protection.

**Typical applications**

- > Palletizing stations with automatic control system where pallets would pass frequently through the hazardous area

### Perimeter Guarding with Embedded Safety Module

Light curtain / Contactor

Cat.4 PL e, SIL 3 / Stop Category 0

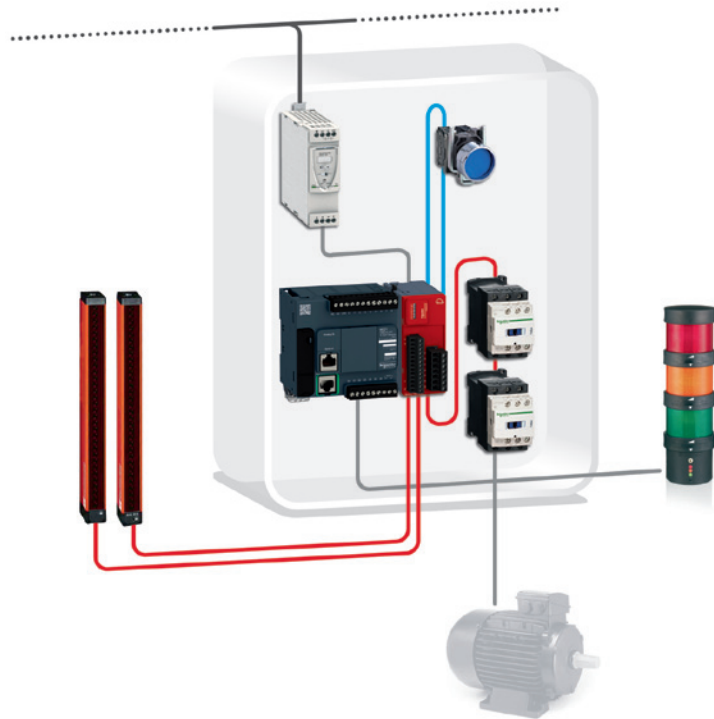
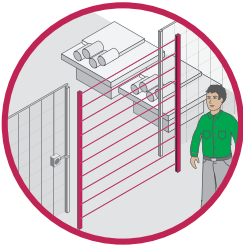

#### Related Products

- Switches, pushbuttons, emergency stop - Harmony XB4
- Switch mode Power supply - Phaseo ABL8
- Safety light curtains, single-beam for body detections - Preventa XU2S
- Photo-electric sensors - OsiSense XU
- Safety Module - Modicon TM3SAK6R(G)
- Contactor - Tesys D
- Modular beacon and tower lights - Harmony XVB

#### Function

Safety-related stop function initiated by safety light curtain (ESPE Type 4 according to EN/IEC 61496-1 and EN/IEC 61496-2).

An interruption of the detection field causes the safety outputs to open. The deactivation of the safety outputs results in the switching-off of the motor power supply by means of the contactor (K1) to help to prevent possible hazardous movements or states.

The safety light curtain receivers and outputs are cyclically tested and monitored by the safety light curtain to detect possible failures.

#### Typical applications

- > Palletizing stations with automatic control system where pallets would pass frequently through the hazardous area

2

**Perimeter Guarding with Embedded Safety Module**  
**Light curtain / Variable Speed Drive**  
**Cat.3 PL d, SIL 2 / Stop Category 1**

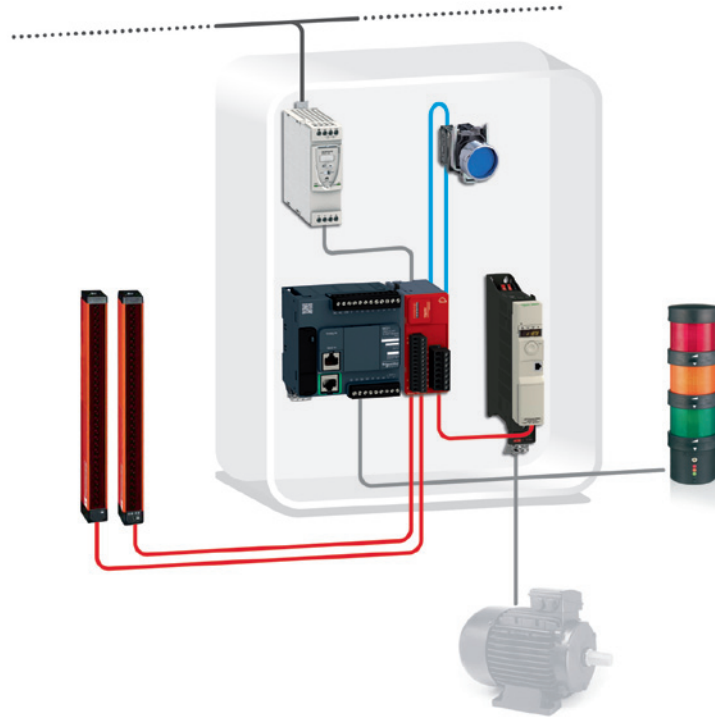
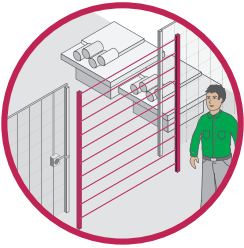

**Related Products**

- Switches, pushbuttons, emergency stop - Harmony XB4
- Switch mode Power supply - Phaseo ABL8
- Safety Module - Modicon TM3SAFL5R(G)
- Safety light curtains
- Variable speed drive - Altivar 32
- Modular beacon and tower lights - Harmony XVB

**Function**

Safety-related stop function initiated by a safety light curtain (ESPE Type 4 according to EN/IEC 61496-1 and EN/IEC 61496-2). Controlled stopping with power maintained to the drive to achieve stopping (i.e. braking), then cut-off of power when standstill is reached (Safe Stop 1). The hazardous movement is interrupted either if the stop button (S2) or the emergency stop device (S3) is actuated. An interruption of the detection field initiates the functional stopping of the drive, i.e. by a braking ramp (stop category 1 in accordance with EN/IEC 60204-1). After the delay time monitored by the drive has elapsed, the drive is halted, by the “safe torque off” (STO) safety function integrated within it, which prevents the motor from restarting unintentionally. The switching of the LI3 input is monitored by the drive. The power stage is disabled when the time offset is exceeded.

**Typical applications**

- > Machines that use drives in their movements due to high speed and precision needed (i.e. textile, wood-working or simple packaging machines), when the delayed initiation of the stopping in the event of a fault must not involve an unacceptably high residual risk



2

### Emergency stop

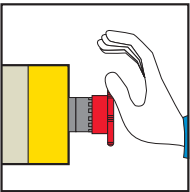
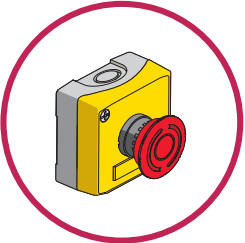

Stop category 0:  
Emergency stop function

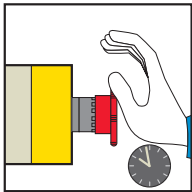

Stop category 1

### Explanation of function

International standard EN/ISO 13850 (replaces standard EN 418) specifies the functional requirements and design principles of emergency stop devices.

**Stop types:**  
Stop category 0 and/or stop category 1 and/or stop category 2 stop functions shall be provided as indicated by the risk assessment and the functional requirements of the machine:

**Stop Category 0:**  
Stopping by immediate removal of power to the machine actuators (i.e. an uncontrolled stop – stopping of machine motion by removing electrical power to the machine actuators)

**Stop Category 1:**  
A controlled stop (stopping of machine motion with electrical power to the machine actuators maintained during the stopping process) with power available to the machine actuators to achieve the stop and then removal of power when the stop is achieved

**Stop Category 2:**  
A controlled stop with power left available to the machine actuators

For the Emergency stop function either Stop Category 0 or Stop Category 1 is chosen according to the risk assessment results. It applies to all machines, whatever type of energy is used to control this function. When the emergency stop instruction ceases, the effect must be maintained until it is reset. Manual resetting must only be possible in the location where the instruction was given. Resetting must not start the machine, but simply enable the starting cycle. Restarting of the machine must not be possible until the emergency stop has been reset.

Where required, facilities to connect protective devices and interlocks shall be provided. If such a protective device or interlock causes a stop of the machine, it may be necessary for that condition to be signalled to the logic of the control system. The reset of the stop function shall not initiate any hazardous situation. Where more than one control station is provided, stop commands from any control station shall be effective when required by the risk assessment of the machine. In addition to the requirements for the emergency stop function has the following requirements:

- It shall override all other functions and operations in all modes
- Power to the machine actuators that can cause a hazardous situation(s) shall be either removed immediately (stop category 0) or shall be controlled in such a way to stop the hazardous motion as quickly as possible (stop category 1) without creating other hazards
- Reset shall not initiate a restart

The choice between these two stopping methods is determined by an evaluation of the machine-related risks. This function includes several sub-functions either Safe Torque off (stop category 0), Safe Stop 1 (stop category 1) or Safe Stop 2 (stop category 2) and is represented by the drawings opposite.

- The operator interface may be:
- Pushbutton equipped with a mushroom head
  - Cable actuated switch
  - Foot switch

### Typical architecture

- Safety chain solution:**
- > Emergency Stop with Embedded Safety Module / Emergency Stop Pushbutton / Contactor / Cat.3 PL d, SIL2, Stop Category 0
  - > Emergency Stop with Embedded Safety Module / Emergency Stop Pushbutton / Contactor / Cat.4 PL e, SIL3, Stop Category 0
  - > Emergency Stop with Modular Safety Controller / Emergency Stop Pushbutton / Contactor / Cat.4 PL e, SIL3, Stop Category 0
  - > Emergency Stop with Embedded Safety PLC / Emergency Stop Pushbutton / PacDrive 3 drive STO / Cat.4 PL e, SIL3 / Stop Category 0

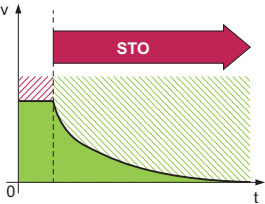

STO: Safe Torque Off

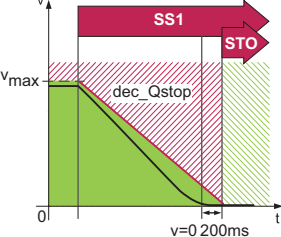

SS1: Safe Stop 1, STO: Safe Torque Off

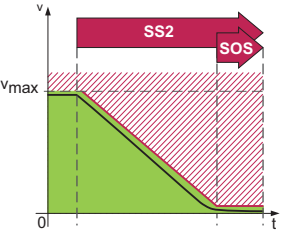

SS2: Safe Stop 2, SOS: Safe Operating Stop

### Guard monitoring

### Explanation of function

#### Guards without guard locking device

On a large number of potentially dangerous machines, the operator must be kept at a distance during operation, but needs to take action when the machine is stopped to position a part, remove a product or adjust a tool.

An effective means of protection is to install a guard which, according to the type of installation, will cut-off the power to the motor if an attempt is made to open it during the machine operating phase.

In all cases, it must not be possible to restart the machine until the guard is closed. Depending on the level of protection required, the system will comprise two conventional limit switches or a combination of protected, actuator operated guard switches to prevent tampering.

#### Guards with guard locking device

This type of guard is necessary for potentially dangerous machines with high inertia (long rundown time).

The guard is interlocked (by a solenoid for example); it cannot be opened until the machine has come to a complete standstill.

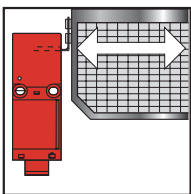

Guard without guard locking device

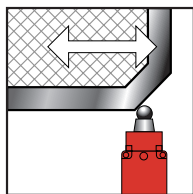

Guard with guard locking device

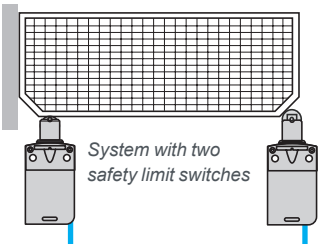

System with two safety limit switches

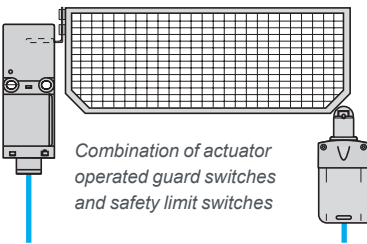

Combination of actuator operated guard switches and safety limit switches

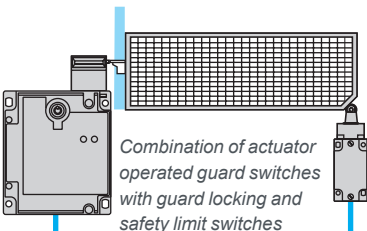

Combination of actuator operated guard switches with guard locking and safety limit switches

### Typical architecture

#### Safety chain solution:

- > Guard Monitoring with Well Tried Components / Limit switch / Motor Starter / Cat.3 PL c, SIL 1 / Stop Category 0
- > Guard Monitoring with Safety Module / Limit switch / Contactor / Cat.3 PL d, SIL 2 / Stop Category 0
- > Guard Monitoring with Safety Module / Guard switch with lock / Contactor / Cat.4 PL e, SIL 3 / Stop Category 0
- > Guard Monitoring with Safety Module / Guard switch with lock / Variable speed drive / Cat.3 PL d, SIL 2 / Stop Category 1
- > Guard Monitoring with Embedded Safety Module / Guard switch with lock / Contactor / Cat.4 PL e, SIL 3 / Stop Category 0
- > Guard Monitoring with Safety Controller / Limit switch / Contactor / Cat.4 PL e, SIL 3 / Stop Category 0
- > Guard Monitoring with Modular Safety Controller / Guard switch with lock / Contactor / Cat.4 PL e, SIL 3 / Stop Category 0
- > Guard Monitoring with Embedded Safety PLC / Guard switch with lock / PacDrive 3 Drive SS1 / Cat.4 PL e, SIL 3 / Stop Category 1

### Guard Monitoring

### Explanation of function

2



**Coded magnetic guard switch and system**  
 A non-contact solution is often used on industrial machines fitted with a door or guards with imprecise guiding.  
 It is particularly suitable for machines subjected to frequent washing or splashing of liquids as well as small machines with a single guard for self-contained systems. Depending on the models used, the sensing distance will be between 5 and 10 mm. The reed contacts used for the coded magnetic switches cannot withstand short circuits and the switches always incorporate a resistor in series. Their operation can therefore only be guaranteed with the associated processing module. The Hall-effect self-contained systems with integral processing module do not require any further processing of the signal.

The illustrations opposite show the functions of coded magnetic guard switches and of a system.

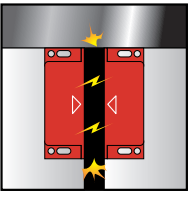

Coded magnetic guard switch

### Typical architecture

- Safety chain solution:**
- > Guard Monitoring with Safety Module / Coded Magnetic switch / Contactor / Cat.4 PL e, SIL 3 / Stop Category 0
  - > Guard Monitoring with Safety Module / Coded Magnetic switch / Variable speed drive / Cat.4 PL e, SIL 3 / Stop Category 1
  - > Guard Monitoring with Safety Module / Coded Magnetic switch / Servos drive / Cat.4 PL e, SIL 3 / Stop Category 1
  - > Guard Monitoring with Embedded Safety Servo Drive / Coded Magnetic switch / Embedded Safety Servo drive / Cat.4 PL e, SIL 3 / Stop Category 2

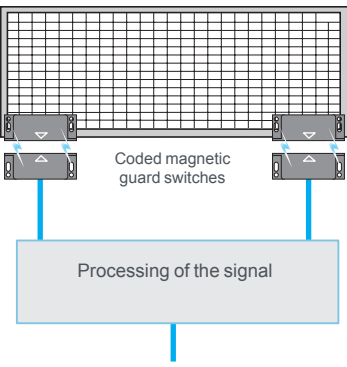

Functions of coded magnetic guard switches

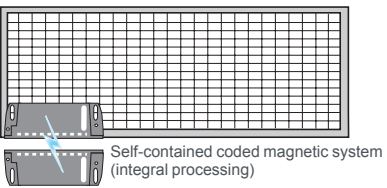

Functions of a coded magnetic guard switch system



### Perimeter guarding

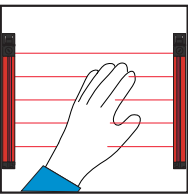
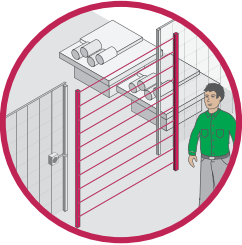

Safety light curtain

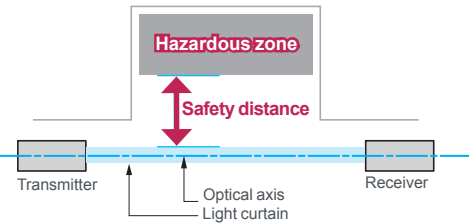

Safety mat

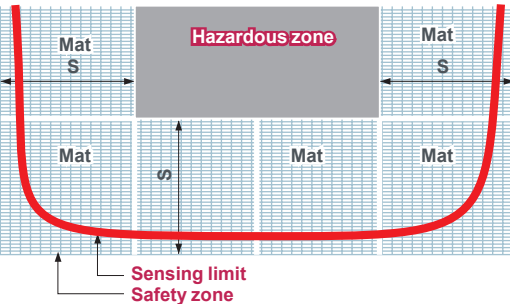

Example of a safety mat application

### Explanation of function

#### Safety light curtains

Safety light curtains are electro-sensitive systems (Electro-Sensitive Protective Equipment) designed to protect persons working in the vicinity of machinery, by stopping dangerous movements when a light beam is broken.

The absence of a door or guard reduces loading, inspection or tool changing times. This type of system, defined by standards EN/IEC 61496-1 and EN/IEC 61496-2, is frequently used with machines such as:

- presses
- machine tools
- assembly lines, etc.

The machine must be designed so that it is impossible to gain access to dangerous movements without breaking one or more of the light beams. In addition, the movement must be stopped whatever the entry speed of the operator into the hazardous zone.

The diagram opposite illustrates the operation of a light curtain.

### Typical architecture

#### Safety chain solution:

- > Perimeter Guarding with Safety Module / Single beam Light Curtains / Contactor / Cat.3 PL c, SIL 1 / Stop Category 0
- > Perimeter Guarding with Embedded Safety Module / Light Curtain / Contactor / Cat.4 PL e, SIL 3 / Stop Category 0
- > Perimeter Guarding with Embedded Safety Module / Light Curtain / Variable Speed Drive / Cat .3 PL d, SIL 2 / Stop Category 1
- > Perimeter Guarding with Modular Safety Controller / Light Curtain / Contactor / Cat.4 PL e, SIL 3 / Stop Category 0

### Explanation of function

#### Safety mats

Safety mats are used to detect persons walking across or standing on the mat or objects falling onto the mat. Standards EN 1760-1/ISO 13856 define their performance.

Any detection of an object on the mat initiates stopping of any dangerous machine movement.

Restarting can be controlled manually or automatically, depending on the configuration of the associated processing unit.

When pressure is applied, the mat distorts locally and the integrated sensors are short-circuited.

The special design of these sensors requires that the mat and the detection module be matched.

In general, several mats are used to cover the safety zone.

The safety distance **S**, defined by the standard, takes into account the speed at which a person can cross the safety zone to reach the hazardous zone.

### Typical architecture

#### Safety chain solution:

- > Perimeter Guarding with Safety Module / Safety Mat / Contactor / Cat.3 PL d, SIL2 / Stop Category 0

### Enabling movement

### Explanation of function

2

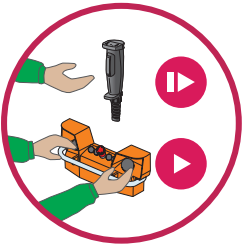

#### Two-hand control stations

Standards ISO 13851 and EN 574 define this device. It requires simultaneous operation by both hands in order to start and maintain operation of a machine. It therefore provides protection exclusively for the person operating it.

A diagram representing the function is given opposite; it must meet the following requirements:

- > Concurrent, maintained operation of the two input controls for the same period of time
- > Synchronous operation; the delay between the two signals must not exceed 0.5 s
- > Prevention of accidental operation (mechanical guard)
- > Protection against tampering

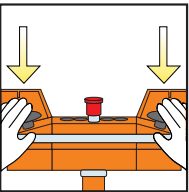

Two-hand control stations

Enabling switches, allow authorized personnel to carry out maintenance, adjustment or programming operations within hazardous zones of machines, provided certain conditions are met. These devices conform to standards EN/IEC 60947-5-8 and EN/IEC 60204-1. In effect, to gain access, these operations, often performed at reduced speed, must be selected by authorized personnel using selectors with key or equivalent.

Important note: the enabling switch alone must not lead to the actuation of any dangerous movements associated with the machine; a secondary, intentional, control action is required from the operator. All devices which conform to the standard must be identified by the marking scheme shown opposite.

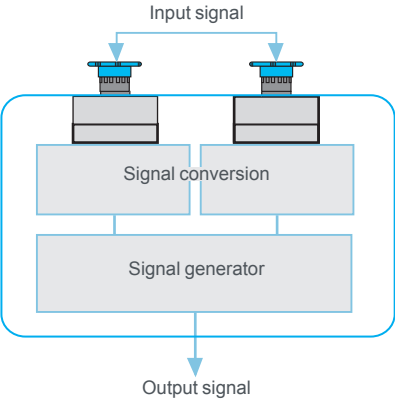

Functions of a two-hand control station

#### Enabling Switch

##### Operating principle

The three possible states are:

- > Position 0: contact open (control operator at rest)
- > Position 1: contact closed (control operator depressed to normal enabling position)
- > Position 2: contact open (control operator fully depressed)

When the switch is depressed in position 1, it must return to position 0 when released. The switch must change from position 1 to position 2 when pressed more firmly. When it is released from position 2 to position 0, the switching contact must not close.

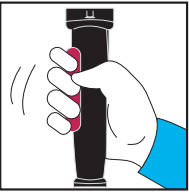

Enabling Switch

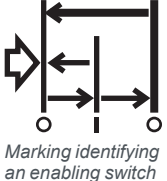

Marking identifying an enabling switch

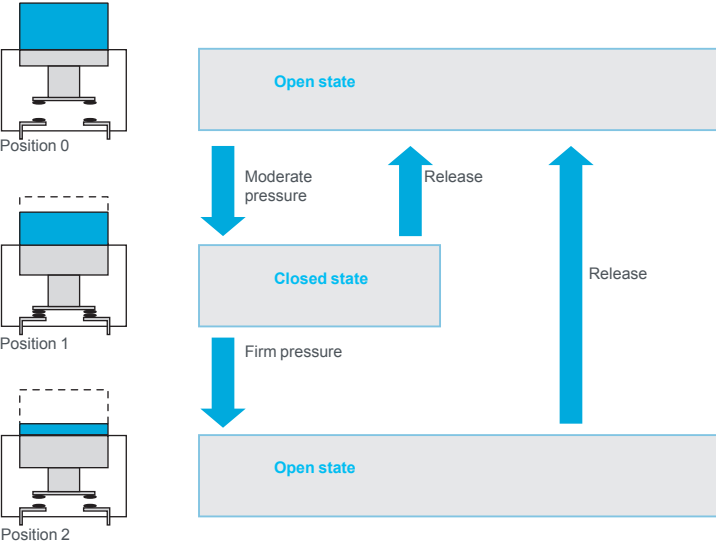

Operating principle of an enabling switch

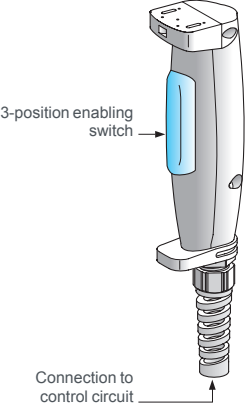

Enabling switch XY2 AU1:  
2 enabling functions, 3 positions + 1 N/C

### Typical architecture

#### Safety chain solution:

- > Enable Machine Movement with Safety Controller / Two Hand Control Station / Contactor / Cat.4 PL e, SIL 3
- > Enable Machine Movement with Modular Safety Controller / Two Hand Control Station / Contactor / Cat.4 PL e, SIL 3

### Speed monitoring

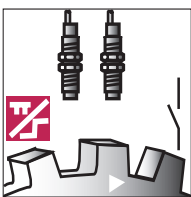
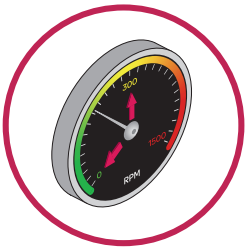

Speed monitoring

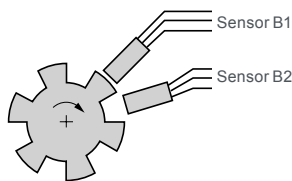

Sensor control

### Explanation of function

#### Zero speed monitoring

##### Detection principle

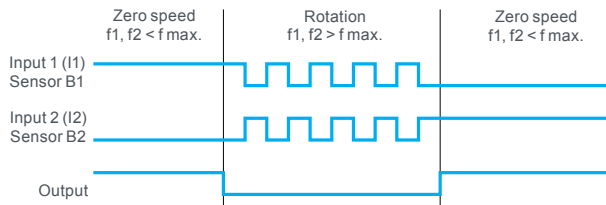

The two sensors to be arranged that only one sensor is activated at any given time. If the inputs are in the low state, the zero speed signal will disappear after  $t=1/f$  seconds and an open-circuit will be indicated. If the 2 inputs are in the high state, the zero speed signal will disappear after  $t=1/f$  seconds and a short-circuit will be indicated. If the 2 inputs are in the high or low state after starting, no enabling will take place.

### Sensor States and Behavior

Switch-on Sequence			
State of Sensor 1	0	0 (1)	1
State of Sensor 2	0	1 (1)	1
Behavior	Error Message	Zero Speed	Notification (2)
Output	0	1	0
Operation			
State of Sensor 1	0	0 (1)	1
State of Sensor 2	0	1 (1)	1
Behavior	Error Message	Zero Speed	Notification
Output	0	1	1

(1) If the state of the sensors is inverse (0/1, 1/0), the behavior is identical.  
 (2) If the firmware version is earlier than 2.34 an error message (short circuit between inputs) appears instead of a notification. This error message must be acknowledged with the reset button.

#### Detection principle 2

Preventa safety modules XPSVNE for zero speed detection are used to detect the stop condition of electric motors. Their most common applications include: providing the unlock signal for electrically interlocked sliding or removable machine guards, controlling rotation direction signals for reversing motors and engaging locking brakes after a motor has come to a standstill.

As electric motors run down, a remanent voltage is produced in the windings of the motor due to residual magnetism. This voltage is proportional to the speed of the motor and, therefore, decreases as the motor comes to a standstill.

This remanent voltage is measured in a redundant manner so as to detect the stop condition of the motor. The cabling between the motor windings and the inputs of the XPSVNE module is also monitored to prevent a cabling breakage or fault being seen as a stopped motor.

A transformer should not be used to connect the motor to terminals Z1, Z2 and Z3 since there is no monitoring of the connection with the motor winding via the resistance monitoring.

Modules XPSVNE are suitable for detecting the stop condition of all types of AC or DC motor driven machines which, when the motor runs down, produce a remanent voltage in the windings due to residual magnetism. These machines can be controlled by electronic devices, such as variable speed drives or DC injection brakes. The input lters for standard XPSVNE modules are designed for a frequency of up to 60 Hz.

For motors operating at a frequency higher than 60 Hz, which therefore produce a high frequency remanent voltage, special modules XPSVNE●●●●HS should be used. Modules XPSVNE have t2 potentiometers mounted on the front face of the module which allow independent adjustment of the switching threshold for each input circuit. This allows adjustment for different types of motors and application requirements. To aid diagnostics, modules XPSVNE have 4 LEDs and 2 solid-state outputs to provide information on the status of the zero speed detection circuit.

2

### Speed monitoring

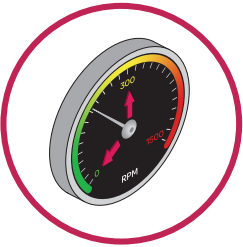

### Explanation of function

#### Motion safety functions

##### Safety-limited speed

The SLS function prevents the motor from exceeding the specified speed limit.

When this function is initiated the machine starts to decelerate to the specified safe speed  $v_2$  with in the specified time  $t_2$ . Once the machine reaches the safe speed  $v_2$  then the function will monitor the speed stays below safe speed  $v_2$ .

In case of speed exceeding specified speed during time  $t_2$  and further, safety function will initiate either SS1 or STO to stop the machine in minimum time.

##### Safe maximum speed

The SMS function provides a safe output signal to indicate whether the motor speed is below a specified limit.

This safety function is an optional function to set an upper limit parameter for continuous monitoring. If the speed of the machine exceeds the specified value then specified safe output will change its state.

##### Safe direction

The SDI function prevents the motor shaft from moving in the unintended direction.

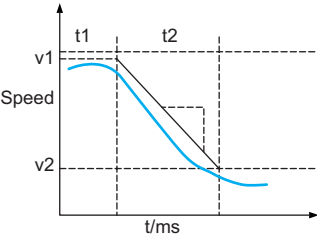

Safety-limited speed

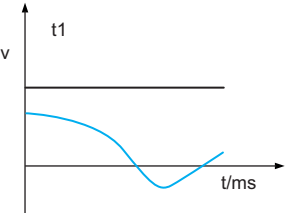

Safe maximum speed

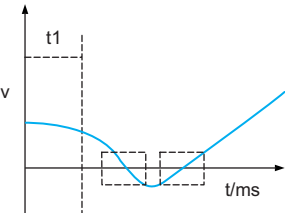

Safe direction

### Typical architecture

#### Safety chain solution:

- > Speed Monitoring with Safety Module / Remanent Voltage detection and limit switch and Guard switch with lock / Contactor / Cat.4 PL e, SIL 3 / Stop Category 0
- > Speed Monitoring with Modular Safety Controller / Safety Encoder / Contactor / Cat.4 PL e, SIL 3 / Stop Category 0
- > Speed Monitoring with Embedded Safety PLC / Selector Switch / PacDrive 3 Drive SLS / Cat.4 PL e, SIL 3 / Safe Limited Speed

### Position monitoring

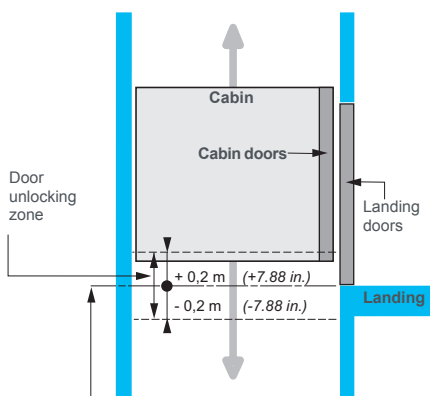
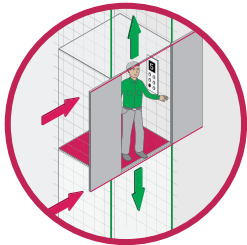

Landing indicator (stop reference point)  
Vertical position monitoring



Safe operating stop (SOS)

### Explanation of function

#### Vertical position monitoring

When the cabin is parked at a landing, with the doors open, some lifts automatically correct their level (isolevelling) in relation to the landing in order to compensate for any differences generated by modification of the load in the cabin.

During this operation, European standard EN-81 recommends that the presence of the cabin be checked within a zone of +/- 0.2 m around the landing (door unlocking zone), by means of a safety circuit which will cause the cabin to stop if it moves out of the specified zone.

The use of the safety module XPS EDA, which checks the presence of the cabin in the specified zone at two points, meets this requirement.

The module incorporates two safety outputs and two solid-state outputs for signaling functions. Four LEDs on the front face of the module provide visual indication of the status of the safety circuit.

The position of the cabin in relation to the landing is detected by two limit switches in the lift shaft. It is also possible to use non-contact sensors (magnetic sensors with reed contact).

When the cabin reaches the preset position and when it is within the permissible tolerances in relation to the landing, the two safety circuits in safety module XPS EDA close and allow isolevelling of the cabin with the doors open. Any change in one of the input signals (cabin outside the specified zone) or detection of a fault (break in the wiring, short-circuit, etc.) causes immediate opening of the safety outputs in the XPS EDA module and subsequent stopping of the cabin.

#### Motion safety function:

##### Safe operating stop (SOS)

The SOS function prevents the motor from deviating more than a defined amount from the stopped position. The drive provides energy to the motor to enable it to resist external forces. The Safe Operating Stop function is most commonly used in conjunction with the Safe Stop 2 function where the machine movement enters into zero speed the Safe Operating Stop is enabled.

### Typical architecture

#### Safety chain solution:

- > Position Monitoring with Embedded Safety PLC / Coded Magnetic Switch / PacDrive 3 Drive SS2 / Cat.4 PL e, SIL 3 / Stop Category 2

# Chapter 3

# Safety product offer



Technical information on products listed in this catalog is  
available at: [www.schneider-electric.com](http://www.schneider-electric.com)

■ **Acquire the information**

□ **Emergency stop and Emergency switching off functions**

- Selection guide* ..... page 3/2
- Ø 16: Harmony® XB6 ..... page 3/5
- Ø 22: Harmony® XB4 metal ..... page 3/9
- Ø 22: Harmony® XB5 plastic ..... page 3/18
- Ø 22: Harmony® XB7 monolithic ..... page 3/27
- Ø 30: Harmony® 9001K / SK ..... page 3/28
- Magelis XBTGH Advanced hand-held panel ..... page 3/30

□ **Control units for safety application**

- Selection guide* ..... page 3/32
- Control station ..... page 3/34
- Wireless remote control system: Harmony® eXLhoist ..... page 3/56
- Enabling grip ..... page 3/60
- Two hand control station ..... page 3/62

□ **Complementary safety products**

- Safety light curtains, Emergency stop rope pull switches,  
Safety switches ..... page 3/66

■ **Monitor and processing**

□ **Preventa safety relays**

- Selection guide* ..... page 3/68
- Preventa safety relays XPS ..... page 3/74

□ **Modicon TM3 safety modules**

- General presentation ..... page 3/94
- Selection guide* ..... page 3/96
- Modicon TM3 safety functional modules ..... page 3/98

□ **Preventa safety controllers**

- Selection guide* ..... page 3/102
- Preventa safety controllers XPSMP ..... page 3/104
- Preventa safety controllers XPSMC ..... page 3/106

□ **Preventa safety modular controllers**

- Preventa safety controllers XPSMCM ..... page 3/110

■ **Stop the Machine**

□ **Mini-VARIO and VARIO switch disconnectors**

- Selection guide* ..... page 3/128
- Mini-VARIO switch disconnectors for standard applications ..... page 3/130
- VARIO switch disconnectors for high performance applications ..... page 3/132
- Mini-VARIO and VARIO switch disconnectors ..... page 3/134
- VARIO enclosed switch disconnectors, pre-assembled ..... page 3/138
- VARIO enclosed switch disconnectors, Add-on modules ..... page 3/140

□ **TeSys D low consumption contactors** ..... page 3/142

□ **TeSys contactors 5, from 6 to 16 A** ..... page 3/144

□ **TeSys protection components** ..... page 3/146

□ **Variable speed drives** ..... page 3/148

□ **Motion control Lexium 32, Lexium 28** ..... page 3/149

■ **Related products to safety**

- Selection guide* ..... page 3/152

□ **Illuminated beacons** ..... page 3/154

□ **Rotating beacons** ..... page 3/162

□ **Sirens & alarms** ..... page 3/164

■ **Products reference index**

- **Index of references** ..... 3/166

# Aquire the information

Control and signaling units  
Emergency stop function



Type of products	Pilot lights	Pushbuttons, selector switches and pilot lights			Biometric switches	
<b>Description of range</b>	<ul style="list-style-type: none"> <li>LED pilot lights</li> </ul>	<ul style="list-style-type: none"> <li>Pushbuttons</li> <li>Multiple-headed pushbuttons</li> <li>Emergency Stop pushbuttons</li> <li>Selector switches and key switches</li> <li>Illuminated pushbuttons</li> <li>Pilot lights</li> </ul>			<ul style="list-style-type: none"> <li>Fingerprint readers 24V ---</li> <li>Stand-alone biometric switches</li> <li>Stand-alone USB biometric switches</li> <li>USB biometric switches dedicated to Schneider HMI (1)</li> </ul>	
<b>Features</b>	<b>Products</b>	Monolithic, compact, low consumption	Complete units or sub-assemblies (body + head)			Monolithic
	<b>Bezel</b>	Double insulated	Double insulated (3)	Metal, chromium plated or black	Double insulated	Double insulated, dark grey
	<b>Shape of head</b>	Circular	Circular, square or rectangular	Circular	Circular or square	–
<b>Drilling or cut-out for fixing</b>		Ø 8 mm and Ø 12 mm/0.315 in. and 0.472 in.	Ø 16 mm/0.630 in.	Ø 22 mm/0.866 in.		
<b>Degree of protection</b>	Conforming to IEC 60529	IP 40 IP 65 with seal	IP 65	IP 66 IP 69K (Selector switches and key switches, multiple-headed pushbuttons and Emergency Stop pushbuttons with bellows)		IP 65 (control button)
	Conforming to UL 508 and CSA C22-2 N° 14	–	Enclosure type 4, 4X and 13			Enclosure type 12
<b>Cabling</b>		Tags for 2.8 x 0.5 mm/0.110 x 0.020 in. connectors or threaded connector	Faston connectors Solder pins for printed circuit boards (3) Fast connector socket (4)	Spring clamp terminal connections Screw clamp terminal connections Faston connectors Connector With adaptor for printed circuit board		Cable or connectors
<b>Mounting</b>	<b>Panel thickness</b>	1...8 mm/0.039...0.315 in.	1...6 mm/0.039...0.236 in.			
<b>Type references</b>		<b>XVLA</b>	<b>XB6, XB6E</b>	<b>XB4</b>	<b>XB5</b>	<b>XB5S</b>
<b>See page</b>		–	3/5	3/9	3/18	–

(1) Compatible with Magelis iPC, STU, OT, GXO, GT (except GT1000 series), GK, GH, and GTO models.  
(2) Wireless and batteryless pushbutton and receiver ready-paired at the factory.

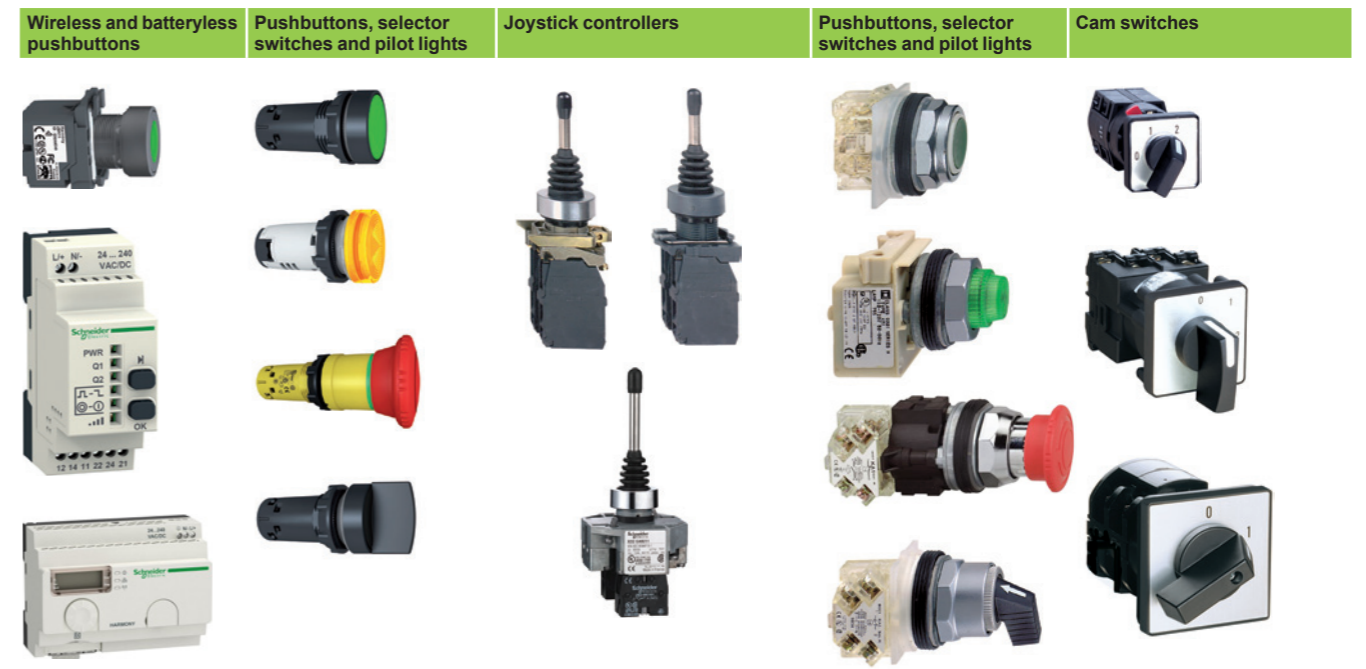

Wireless and batteryless pushbuttons	Pushbuttons, selector switches and pilot lights	Joystick controllers	Pushbuttons, selector switches and pilot lights	Cam switches		
<ul style="list-style-type: none"> <li>Wireless and batteryless pushbuttons and rope pull switch</li> <li>Configurable receivers</li> <li>Access point</li> <li>Relay-antenna</li> <li>Mobile handy box or plastic boxes for wall mounting</li> </ul>	<ul style="list-style-type: none"> <li>Pushbuttons</li> <li>Emergency Stop and Emergency switching off pushbuttons</li> <li>Selector switches and key switches</li> <li>Illuminated pushbuttons</li> <li>Pilot lights</li> </ul>	<ul style="list-style-type: none"> <li>2 or 4 direction</li> <li>Stay put or spring return</li> </ul>	<ul style="list-style-type: none"> <li>Pushbuttons</li> <li>Emergency Stop buttons</li> <li>Selector switches and key switches</li> <li>Illuminated pushbuttons</li> <li>Pilot lights</li> </ul>	<ul style="list-style-type: none"> <li>Switches</li> <li>Stepping switches</li> <li>Reversing and changeover switches</li> <li>Ammeter switches</li> <li>Voltmeter switches</li> <li>Reversing switches</li> <li>Star-delta and reversing star-delta switches</li> <li>Pole change switches</li> </ul>		
Ready-to-use packs (2) and "components" range	Monolithic	Complete units or sub-assemblies (body + head with lever)	Complete units or sub-assemblies (body + head)	Complete units or sub-assemblies (body + front panel + head)		
Metal, chromium plated or double insulated, black	Double insulated, dark grey (or white for pilot lights)	Metal, chromium plated	Double insulated, black	Metal, chromium plated or double insulated, black		
Transmitter with circular head	Circular	Circular	Hexagonal	Square		
Ø 22 mm/0.866 in.			Ø 30 mm/1.181 in.	Ø 16 or Ø 22 mm/0.630 or 0.866 in.: series K10 Ø 22 mm/0.866 in. and multifixing: series K1/K2 4 holes, 48 or 68 centres: series K30...K150		
IP 65	IP 65 (control buttons and pilot lights) IP 54 (Emergency switching off pushbuttons)	IP 65	IP 66	IP 65	IP 66	IP 65: series K10 IP 40, IP 65 with seal: series K1/K2 IP 40: series K30...K150
Enclosure type 12	Enclosure type 3 (pushbuttons and Emergency stop) and 4 (pilot lights)	Enclosure type 4, 4X and 13		Enclosure type 4 and 13 (9001K) Enclosure type 4, 4X, 13 (9001SK)		–
Wireless (transmitter) Through cable (receiver)	Screw and captive clamp terminal connections Faston clip connections (pilot lights)	Screw and captive clamp terminal connections				
1...6 mm/0.039...0.236 in.					0.5...6 mm/0.020...0.236 in. (depending on model)	
<b>XB5R, XB4R</b>	<b>XB7</b>	<b>XD4PA</b>	<b>XD2GA</b>	<b>XD5PA</b>	<b>9001K, 9001SK</b>	<b>K10, K1, K2, K30, K50, K63, K115, K150</b>
–	3/27	–	–	–	3/29	–

(3) For Harmony® XB6 only.  
(4) For Harmony® XB6E only.



# Acquire the information

Control units Ø 16 plastic

Harmony XB6E monolithic and XB6 modular

Emergency stop pushbuttons

## Presentation

The Ø 16 mm/0.630 in. Harmony XB6 and XB6E plastic range of Emergency stop pushbuttons is compact and thus suitable for installation on small machines and control panels. Their reduced diameter makes them suitable for applications where mounting space is less. Designed for control of machines and installations, these functions meet the requirements of majority of industrial applications.

- This range includes:
  - Ø 32 mm/1.260 in. Emergency stop trigger action pushbuttons for Start/Stop control of machines and installations, adjustment and parametering (contact functions),
  - Ø 32 mm/1.260 in. Illuminated Emergency stop pushbuttons for control and signaling (contact functions and signaling functions),
  - Fast connector sockets with push-in technology,
  - Various accessories.

## Installation

- Harmony XB6 and XB6E products are both simple and quick to install:
  - Mounting by single installer (self-maintaining of the head in its cut-out)
  - Clip-together component system (head, body, contact blocks and LED)
- Type of connection:
  - For XB6 and XB6E: faston connector
  - For XB6E: fast connector socket

## Environment

The performance features of these range meet the most demanding international standards and approvals:

- Degrees of protection:
  - For XB6 and XB6E: IP 65 conforming to standard IEC 60529
  - For XB6: NEMA type 4, 4X and 13 conforming to standard UL 50 and CSA C22-2 n° 94 (except key switches)
- International standards:
  - For XB6 and XB6E: EN/IEC 60947-5-5
  - For XB6: conform to standards EN/IEC 60204-1 and EN/ISO 13850, to Machinery Directive 98/37/EC and to standard EN/IEC 60947-5-5
- Product certifications:
  - For XB6E: UR, CCC,
  - For XB6: UL, CSA, CCC, GOST

# Acquire the information

Control units Ø 16 plastic

Harmony XB6E monolithic

Emergency stop pushbuttons and accessories



XB6ETI522P



XB6ETN521P

## Emergency stop mushroom head pushbutton

### Illuminated

Shape of head	Type of push	Type of contacts	Reference		Weight kg/lb
			With 12 V LED	With 24 V LED	
Circular, Ø 32 mm /1.260 in.	Trigger action, turn to release, pull to release	N/C			0.027/0.060
		2	XB6ETI522P	XB6ETI523P	

### Non-illuminated

Shape of head	Type of push	Type of contacts	Reference		Weight kg/lb
			With 12 V LED	With 24 V LED	
Circular, Ø 32 mm /1.260 in.	Trigger action, turn to release, pull to release	N/C			0.027/0.060
		2	XB6ETN521P		

## Accessories

### Labels for Emergency stop mushroom head pushbutton

Shape	Color	Marking	Sold in lots of	Reference	Weight kg/lb
Circular	Yellow	EMERGENCY STOP	10	ZB6Y56	0.010/0.022



# Acquire the information

Control units Ø 16 plastic

Harmony XB6 modular

Emergency stop pushbuttons and circular legends

3



PF514167  
XB6AS8349B



PF514167  
XB6AS9349B



110770  
ZB6AS834





110771  
ZB6AS934



DG12,14,38  
ZB6Y7130



## Emergency stop trigger action and mechanical latching pushbuttons

Shape of head	Type of reset	Type of contacts	Diameter of push mm/in.	Color	Reference	Weight kg/lb
		 N/O  N/C				

### Complete units

	Turn to release	1	2	30/1.181	Red	<b>XB6AS8349B</b> (ZB6Z4B + ZB6AS834)	0.041/0.090
	Key release (key n° 200)	1	2	30/1.181	Red	<b>XB6AS9349B</b> (ZB6Z4B + ZB6AS934)	0.056/0.123

### Heads only

	Turn to release			30/1.181	Red	<b>ZB6AS834</b>	0.035/0.077
	Key release (key n° 200)			30/1.181	Red	<b>ZB6AS934</b>	0.050/0.110

## Circular legends for Emergency Stop mushroom head pushbuttons (yellow)

Diameter mm/in.	Marking on yellow background	Reference	Weight kg/lb
45/1.772	Without (1)	<b>ZB6Y7001</b>	0.001/0.002
	ARRET D'URGENCE (1)	<b>ZB6Y7130</b>	0.001/0.002
	EMERGENCY STOP (1)	<b>ZB6Y7330</b>	0.001/0.002
	PARADA EMERGENCIA (1)	<b>ZB6Y7430</b>	0.001/0.002
	ARRESTO EMERGENZA (1)	<b>ZB6Y7630</b>	0.001/0.002
	NOT-HALT (1)	<b>ZB6Y7230</b>	0.001/0.002

(1) For complying with EN/ISO 13850 standard, paragraph 4.4.6., Emergency Stop function logo  has been added.

# Acquire the information

Control units Ø 16 plastic

Harmony XB6 modular

Complete bodies and accessories



ZB6Z1B



ZB6Y009



ZB6Y011



ZB6Y010



ZB6Y003



ZB6Y005

## Complete bodies

Description	Supply voltage V	Type of contacts		Reference	Weight kg/lb
		N/O	N/C		
<b>Faston connectors</b>					
Direct supply	≤ 250	1	–	ZB6Z1B	0.004/0.009
Fixing collar + contact block		–	1	ZB6Z2B	0.004/0.009
		2	–	ZB6Z3B	0.006/0.013
		–	2	ZB6Z4B	0.006/0.013
		1	1	ZB6Z5B	0.006/0.013

## Accessories

Description	Application	Sold in lots of	Reference	Weight kg/lb	
<b>Body accessories</b>					
Body/fixing collar	For mounting contact blocks and light source	10	ZB6Y009	0.002/0.004	
Body bracket (fixing screws included)	Printed circuit board mounting	4	ZB6Y011	0.010/0.022	
<b>Mounting accessories</b>					
Plug-in socket adapter	Printed circuit board mounting	10	ZB6Y010	0.004/0.009	
Dummy contact block housing (without contacts)	Printed circuit board mounting	Without pins for printed circuit	10	ZB6Y006	0.001/0.002
		With pins for printed circuit	10	ZB6Y006A	0.001/0.002
Adapter for XAL control station (Ø 22 mm / 0.866 in. to Ø 16 mm / 0.630 in. reducer)	Ø 16/0.630 in. circular, square or rectangular units	5	ZB6Y006A	0.001/0.002	
<b>Miscellaneous accessories</b>					
Anti-rotation plate	Selector switches, Emergency stop buttons	10	ZB6Y003	0.001/0.002	
Nut	Securing head on support	10	ZB6Y002	0.001/0.002	
Dismantling tool	Removal of contact blocks from body/fixing collar	5	ZB6Y018	0.005/0.011	
Extractor	Removal of pushbutton caps	5	ZB6Y016	0.010/0.022	
Bezel tightening tool + bulb extractor	Tightening and slackening the bezel and changing bulbs	2	ZB6Y905	0.006/0.013	
Metal assembly tool	Tightening of fixing nut	1	ZB6Y906	0.022/0.049	
Dismantling tool kit, comprising 3 tools	Removal of contacts, fixing nuts and pushbutton caps	1	ZB6Y019	0.030/0.066	
Female Faston connector	–	100	ZB6Y004	0.002/0.004	
Blanking plug	–	10	ZB6Y005	0.001/0.002	

# Acquire the information

## Control units Ø 22

### Emergency stop and Emergency switching off functions

#### Presentation

The Ø 22 mm/0.866 in. Harmony XB4 metal, XB5 plastic, and XB7 plastic range of Emergency stop and Emergency switching off functions combines simplicity of installation, flexibility, robustness, ergonomics and reliability. Designed for control of machines and installations, these functions meet the requirements of majority of industrial applications.

Following are broad and comprehensive offer under this range:

- Emergency stop trigger action and mechanically latching pushbuttons (conforming to standards EN/IEC 60204-1 and EN/ISO 13850)
- Emergency switching off mechanically latching pushbuttons (conforming to standard IEC 60364-5-53)
- Legends and legend holders
- Accessories and spare parts

#### Installation

- These products are both simple and quick to install:
  - Mounting by single installer (self-maintaining of the head in its cut-out)
  - Clip-together component system (head, body, contact blocks and LED)
  - Fixing by a single locking screw
  - Anti-loosening system for screw clamp terminals of contact blocks.
- Various types of connection are available:
  - Screw clamp terminal connector
  - Spring clamp terminal connector
  - Faston connector
  - Plug-in connector

#### Environment

The performance features of these range meet the most demanding international standards and approvals:

- Degrees of protection:
 

The range includes products for use in difficult industrial environments, due to:

  - Their high degree of protection for harsh environments (IP 66 / IP 69K with bellows)
  - Their resistance to high pressure cleaning
  - Their "all climates" TH compatibility
  - A wide choice of contact blocks with various breaking capacities (low, standard or high power switching)
  - For XB7: IP 65 for Emergency stop pushbuttons
- International standards:
  - Emergency stop function: Mushroom head Emergency stop trigger action and mechanical latching pushbuttons conform to standards EN/IEC 60204-1 and EN/ISO 13850, to Machinery Directive 2006/42/EC and to standard EN/IEC 60947-5-5.
  - Emergency switching off function: Mushroom head switching off mechanical latching pushbuttons conform to standards IEC 60364-5-53 and EN/IEC 60947-5-5.

For XB7,

  - Emergency stop function: EN/IEC 60947-5-5, EN/ISO 13850 and EN/IEC 60204-1
  - Emergency switching off function: EN/IEC 60364-5-53
- Product certifications:
  - UL 508, CSA C22-2 n° 14, and GB 14048.5
  - International certifications: UL, CSA, CCC, EAC
  - Marine certifications for XB4 and XB5: BV, RINA, LROS, DNV, GL



Please consult our Customer Care Centre for a full explanation of these standards and directives.



# Acquire the information



Control units Ø 22 - Harmony XB4, metal  
 Emergency stop and Emergency switching off functions  
 Conforming to EN/IEC 60204-1, 60364-5-53,  
 EN/ISO 13850 and Machinery Directive 2006/42/EC

## Emergency stop and switching off pushbuttons with trigger action and mechanical latching (1) (2)

Screw clamp terminal connections (Schneider Electric anti-loosening system)

Shape of head	Type of reset	Type of contact		Push Ø mm/in.	Color	Reference	Weight kg/lb
							

Complete units								
	Push-pull	-	1	40/1.575	Red	<b>XB4BT842</b> (ZB4BZ105 + ZB4BT84)	0.125/0.276	
			1	40/1.575	Red	<b>XB4BT845</b> (ZB4BZ105 + ZB4BT84)	0.136/0.300	
	Turn to release	-	1	40/1.575	Red	<b>XB4BS8442</b> (ZB4BZ102 + ZB4BS844)	0.118/0.260	
			1	40/1.575	Red	<b>XB4BS8445</b> (ZB4BZ102 + ZB4BS844)	0.130/0.287	
			-	2	40/1.575	Red	<b>XB4BS8444</b> (ZB4BZ104 + ZB4BS844)	0.130/0.287
			1	2	40/1.575	Red	<b>XB4BS84441</b> (ZB4BZ141 + ZB4BS844)	0.140/0.309
	Key release (key n°455) (3)		1	40/1.575	Red	<b>XB4BS9445</b> (ZB4BZ105 + ZB4BS944)	0.170/0.375	

Heads only							
	Push-pull			30/1.181	Red	<b>ZB4BT844</b>	0.078/0.172
				40/1.575	Red	<b>ZB4BT84</b>	0.078/0.172
				60/2.362	Red	<b>ZB4BX84</b>	0.098/0.216
	Turn to release			30/1.181	Red	<b>ZB4BS834</b>	0.068/0.150
				40/1.575	Red	<b>ZB4BS844</b>	0.073/0.161
				60/2.362	Red	<b>ZB4BS864</b>	0.093/0.205
	Key release (key n° 455) 2 keys included with head (5) (3)			30/1.181	Red	<b>ZB4BS934</b>	0.094/0.207
				40/1.575	Red	<b>ZB4BS944 (4)</b>	0.098/0.216
				60/2.362	Red	<b>ZB4BS964</b>	0.118/0.260

## Illuminated Emergency switching off function only, mechanical latching pushbuttons (1)

Screw clamp terminal connections (Schneider Electric anti-loosening system)

Shape of head	Type of reset	Push Ø mm/in.	Color	Reference	Weight kg/lb
---------------	---------------	---------------	-------	-----------	--------------

Heads only (6)					
	Push-pull	40/1.575	Red	<b>ZB4BW643</b>	0.051/0.112



(1) Recommended maximum number of contacts constituting the body (fixing collar + contact) associated with the head, see page 12 of Harmony XB4 catalog DIA5ED21212EN.  
 (2) It is recommended that a legend or yellow background is used.  
 (3) The symbol  indicates key withdrawal position(s).  
 (4) Other key numbers:  
 - key n° 421E: add suffix **12** to the reference.  
 - key n° 458A: add suffix **10** to the reference.  
 - key n° 520E: add suffix **14** to the reference.  
 - key n° 3131A: add suffix **20** to the reference.  
 - key n° 4A185: add suffix **D** to the reference.  
 Example: To order a Ø 40 mm/1.575 in. red mushroom head for a trigger action and mechanical latching Emergency stop pushbutton, with release by key n° 421E, the reference becomes: **ZB4BS94412**.  
 (5) For specific keys with other numbers, please consult our Customer Care Centre.  
 (6) Only for use with bodies comprising a light source with integral LED.

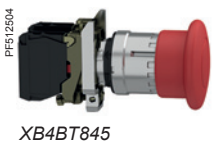

XB4BT845

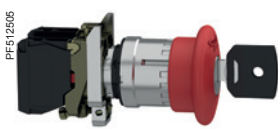

XB4BS9445

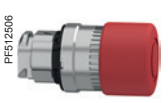

ZB4BT844

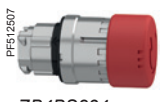

ZB4BS834



ZB4BS964



# Aquire the information

Control units Ø 22 - Harmony XB4, metal  
Emergency stop and Emergency switching off functions  
Circular yellow legends for Emergency stop

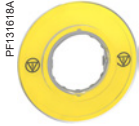

ZBY9121



ZBY9420



ZBZ28

### Circular yellow legends for Emergency stop (1)

Description	Marking	Color	Sold in lots of	Reference	Weight kg/lb
Ø 60 mm/2.362 in. legend for Emergency stop function	-	Yellow	5	ZBY9121	0.007/0.015
	EMERGENCY STOP	Yellow	5	ZBY9320	0.007/0.015
	ARRET D'URGENCE	Yellow	5	ZBY9120	0.007/0.015
	NOT HALT	Yellow	5	ZBY9220	0.007/0.015
	PARADA DE EMERGENCIA	Yellow	5	ZBY9420	0.007/0.015
	ARRESTO DI EMERGENZA	Yellow	5	ZBY9620	0.007/0.015

### Bellows for harsh environments (IP 69K) (2)

For use in	Material	For use with	Color	Sold in lots of	Unit reference	Weight kg/lb
Environments subject to humidity, dust, high pressure cleaning, etc.	Silicone	Emergency stop / Switching off function	Yellow	2	ZBZ28	0.009/0.020
		Other functions	Black	2	ZBZ58	0.009/0.020

### Heads with black metal bezel

To order, add a figure 7 to the references selected above.  
Example: ZB4BT844 becomes ZB4BT8447.

(1) Other legend models for Emergency stop and Emergency switching off function see page 3/17.



(2) Not compatible with Ø 30 mm/1.181 in. pushbutton.

# Acquire the information

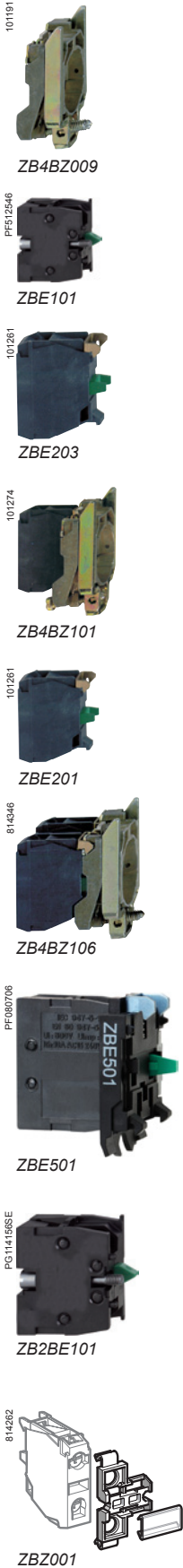



Control units Ø 22 - Harmony XB4, metal  
Body/contact assemblies - Screw clamp terminal  
connections



Body/fixing collar			
For use with	Sold in lots of	Unit reference	Weight kg/lb
Electrical block (contact or light)	10	ZB4BZ009	0.038/0.084

Contact functions (1)							
Screw clamp terminal connections (Schneider Electric anti-loosening system)							
Description	Type of contact	Description			Sold in lots of	Unit reference	Weight kg/lb

Contacts for standard applications							
Contact blocks	Single		1	–	5	ZBE101	0.011/0.024
			–	1	5	ZBE102	0.011/0.024
	Double		2	–	5	ZBE203	0.020/0.044
			–	2	5	ZBE204	0.020/0.044
			1	1	5	ZBE205	0.020/0.044
	Single with body/fixing collar		1	–	1	ZB4BZ101	0.053/0.117
			–	1	1	ZB4BZ102	0.053/0.117
			2	–	1	ZB4BZ103	0.062/0.137
			–	2	1	ZB4BZ104	0.062/0.137
			1	1	1	ZB4BZ105	0.062/0.137
		1	2	1	ZB4BZ141	0.072/0.159	

Contacts for specific applications							
Low power switching	Single	Standard	1	–	5	ZBE1016	0.012/0.026
			–	1	5	ZBE1026	0.012/0.026
		Dusty environment(2) (IP 5X, 50 µm dust)	1	–	5	ZBE1016P	0.012/0.026
			–	1	5	ZBE1026P	0.012/0.026
Staggered contacts	Single	Early make N/O 	1	–	5	ZBE201	0.011/0.024
		Late break N/C 	–	1	5	ZBE202	0.011/0.024
	Single with body/fixing collar	Overlapping N/O+N/C 	1	1	5	ZB4BZ106	0.062/0.137
		Staggered N/O+N/O 	2	–	5	ZB4BZ107	0.062/0.137

High power switching	Single	Standard (3)	1	–	1	ZBE501	0.020/0.044
			–	1	1	ZBE502	0.020/0.044
			2	–	1	ZBE503	0.032/0.071
			–	2	1	ZBE504	0.032/0.071
			1	1	1	ZBE505	0.032/0.071
Additional contact blocks for high power switching	Single	Standard (4)	1	–	1	ZB2BE101	0.020/0.044
			–	1	1	ZB2BE102	0.020/0.044

Clip-on legend holder, sheet of blank legends and labelling software			
Description	Sold in lots of	Unit reference	Weight kg/lb
Clip-on legend-holder for electrical blocks with screw clamp terminal connections(5). For identification of an XB4B control or signaling unit	10	ZBZ001	0.001/0.002
Sheet of 50 blank legends for legend holder ZBZ001	10	ZBY001	0.023/0.051
“SIS Label” labelling software for legend design (ZBY001 legends)(for design of legends in English, French, German, Italian, Spanish)	1	XBY2U	0.100/0.220

- (1) The contact blocks enable variable composition of body/contact assemblies. Maximum number of rows possible: 3. Either 3 rows of 3 single contacts or 1 row of 3 double contacts + 1 row of 3 single contacts (double contacts occupy the first 2 rows). Maximum number of contacts is specified on page ???36072/2.
- (2) It is not possible to fit an additional contact block on the back of these contact blocks.
- (3) It is not possible to use these contacts with light blocks.
- (4) To be fitted on the back of ZBE50● contacts.
- (5) This legend holder is not compatible with high power switching contacts.





# Acquire the information

## Control units Ø 22 - Harmony XB4, metal

### Light blocks - "Test light" - Protection

3



ZBVB1



ZBV5B



ZBZG156



ZBZM156

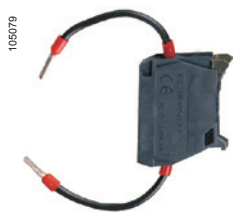

ZBZVG

Light blocks					
Description	Supply voltage(V)	Color of light source	Sold in lots of	Unit reference	Weight kg/lb
<b>Light blocks with screw clamp terminal connections</b> (Schneider Electric anti-loosening system)					
<b>Integral LED</b> (to combine with heads for integral LED)	≈ 12 (50/60 Hz)	White	5	<b>ZBVJ1</b>	0.017/0.037
		Green	5	<b>ZBVJ3</b>	0.017/0.037
		Red	5	<b>ZBVJ4</b>	0.017/0.037
		Orange	5	<b>ZBVJ5</b>	0.017/0.037
		Blue	5	<b>ZBVJ6</b>	0.017/0.037
	≈ 24 (50/60 Hz)	White	5	<b>ZBVB1</b>	0.017/0.037
		Green	5	<b>ZBVB3</b>	0.017/0.037
		Red	5	<b>ZBVB4</b>	0.017/0.037
		Orange	5	<b>ZBVB5</b>	0.017/0.037
		Blue	5	<b>ZBVB6</b>	0.017/0.037
	≈ 24...120 (50/60 Hz)	White	5	<b>ZBVBG1</b>	0.017/0.037
		Green	5	<b>ZBVBG3</b>	0.017/0.037
		Red	5	<b>ZBVBG4</b>	0.017/0.037
		Orange	5	<b>ZBVBG5</b>	0.017/0.037
		Blue	5	<b>ZBVBG6</b>	0.017/0.037
	≈ 110...120 (50/60 Hz)	White	5	<b>ZBVG1</b>	0.017/0.037
		Green	5	<b>ZBVG3</b>	0.017/0.037
		Red	5	<b>ZBVG4</b>	0.017/0.037
		Orange	5	<b>ZBVG5</b>	0.017/0.037
		Blue	5	<b>ZBVG6</b>	0.017/0.037
≈ 230...240 (50/60 Hz)	White	5	<b>ZBVM1</b>	0.017/0.037	
	Green	5	<b>ZBVM3</b>	0.017/0.037	
	Red	5	<b>ZBVM4</b>	0.017/0.037	
	Orange	5	<b>ZBVM5</b>	0.017/0.037	
	Blue	5	<b>ZBVM6</b>	0.017/0.037	

Flashing light blocks with screw clamp terminal connections					
(Schneider Electric anti-loosening system)					
Description	Supply voltage(V)	Color of light source	Sold in lots of	Unit reference	Weight kg/lb
<b>Integral LED</b> (to combine with heads for integral LED)	≈ 24 (50/60 Hz)	White	5	<b>ZBV18B1</b>	0.017/0.037
		Green	5	<b>ZBV18B3</b>	0.017/0.037
		Red	5	<b>ZBV18B4</b>	0.017/0.037
		Orange	5	<b>ZBV18B5</b>	0.017/0.037
		Blue	5	<b>ZBV18B6</b>	0.017/0.037
		≈ 110...120 (50/60 Hz)	White	5	<b>ZBV18G1</b>
	Green		5	<b>ZBV18G3</b>	0.017/0.037
	Red		5	<b>ZBV18G4</b>	0.017/0.037
	Orange		5	<b>ZBV18G5</b>	0.017/0.037
	Blue		5	<b>ZBV18G6</b>	0.017/0.037
	≈ 230...240 (50/60 Hz)		White	5	<b>ZBV18M1</b>
		Green	5	<b>ZBV18M3</b>	0.017/0.037
		Red	5	<b>ZBV18M4</b>	0.017/0.037
		Orange	5	<b>ZBV18M5</b>	0.017/0.037
		Blue	5	<b>ZBV18M6</b>	0.017/0.037

For use with	Supply voltage(V)	Description	Reference	Weight kg/lb
<b>Transformer blocks for 24 V light blocks (1)</b>				
Light blocks with integral LED	≈ 400 V - 50Hz	Transformer 400 V - 24 V ~	<b>ZBV5B (2)</b>	0.090/0.198

Blocks for "test light" function				
Light blocks	Supply voltage(V)	Description	Reference	Weight kg/lb
Light blocks	≈ 12 and 24 ≈ 24...120	Single module, 1 connecting wire	<b>ZBZG156 (3)</b>	0.010/0.022
Light blocks with integral LED	≈ 48...230	Double module, with connecting wires	<b>ZBZG156 (3)</b>	0.010/0.022

LED suppressors				
For use with	Supply voltage(V)	Level of protection	Reference	Weight kg/lb
Light blocks with integral LED fitted with screw clamp terminal connections	≈ 120	25...120 VA	<b>ZBZVG</b>	0.010/0.022
	≈ 230	30...230 VA	<b>ZBZVM</b>	0.010/0.022

(1) To be used with 2 dummy contact blocks **ZBE000**.

(2) To order ~ 440...460 V - 60 Hz transformer blocks, please replace "5" in the reference by "8": **ZBV5B** becomes **ZBV8B**. To order ~ 550...600 V - 60 Hz transformer blocks, please replace "5" by "9": **ZBV5B** becomes **ZBV9B**.

(3) Block for use with ≈ light blocks with integral LED types **ZBVJ●**, **ZBVB●**, **ZBVBG●** or with direct supply light block for BA 9s bulb, **ZBV6**.

(4) Block for use ~ light blocks integral LED types **ZBVG●**, **ZBVM●**, see connection on our website [www.schneider-electric.com](http://www.schneider-electric.com).

## Acquire the information

Control units Ø 22 - Harmony XB4, metal  
Body/contact assemblies - Spring clamp terminal connections



ZB4BZ009



ZBE1015

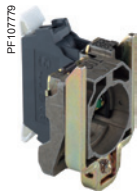

ZB4BZ1015



ZBVB35

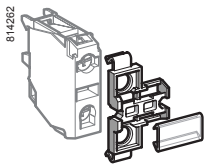

ZBZ001

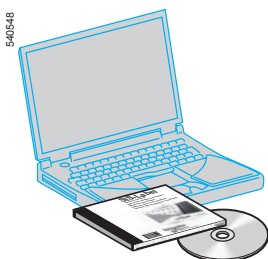

XBY2U

### Body/fixing collar

For use with	Sold in lots of	Unit reference	Weight kg/lb
Electrical block (contact or light)	10	ZB4BZ009	0.038/0.084

### Contact functions Spring clamp terminal connections (1)

Description	Type of contact	N/O	N/C	Sold in lots of	Unit reference	Weight kg/lb
<b>Contacts for standard applications</b>						
Contact blocks	Single	1	–	4	ZBE1015	0.011/0.024
		–	1	4	ZBE1025	0.011/0.024
	Single with body/fixing collar	1	–	1	ZB4BZ1015	0.053/0.117
		–	1	1	ZB4BZ1025	0.053/0.117
		2	–	1	ZB4BZ1035	0.062/0.137
		–	2	1	ZB4BZ1045	0.062/0.137
1	1	1	ZB4BZ1055	0.062/0.137		

### Light blocks Spring clamp terminal connections (1)

Description	Supply voltage V	Color of light source	Sold in lots of	Unit reference	Weight kg/lb	
Integral LED (to combine with heads for integral LED)	~ 12 (50/60 Hz)	White	4	ZBVJ15	0.016/0.035	
		Green	4	ZBVJ35	0.016/0.035	
		Red	4	ZBVJ45	0.016/0.035	
		Orange	4	ZBVJ55	0.016/0.035	
		Blue	4	ZBVJ65	0.016/0.035	
		White	4	ZBVB15	0.016/0.035	
	~ 24 (50/60 Hz)	Green	4	ZBVB35	0.016/0.035	
		Red	4	ZBVB45	0.016/0.035	
		Orange	4	ZBVB55	0.016/0.035	
		Blue	4	ZBVB65	0.016/0.035	
		~ 110...120 (50/60 Hz)	White	4	ZBVG15	0.016/0.035
			Green	4	ZBVG35	0.016/0.035
Red	4		ZBVG45	0.016/0.035		
Orange	4		ZBVG55	0.016/0.035		
~ 230...240 (50/60 Hz)	Blue	4	ZBVG65	0.016/0.035		
	White	4	ZBVM15	0.016/0.035		
	Green	4	ZBVM35	0.016/0.035		
	Red	4	ZBVM45	0.016/0.035		
Integral LED + body/fixing collar	~ 110...120 (50/60 Hz)	Orange	4	ZBVM55	0.016/0.035	
		Blue	4	ZBVM65	0.016/0.035	
		Green	4	ZB4BVG35	0.053/0.117	
		Red	4	ZB4BVG45	0.053/0.117	

### Sheet of 50 blank legends

For use with	Sold in lots of	Unit reference	Weight kg/lb
Legend holder ZBZ001	10	ZBY001	0.023/0.051

### "SIS Label" labelling software (for legends ZBY001)

For legend design	Sold in lots of	Unit reference	Weight kg/lb
for English, French, German, Italian, Spanish	10	XBY2U	0.100/0.220

(1) It is not possible to fit an additional block on the back of these contact or light blocks.

# Aquire the information

Control units Ø 22 - Harmony XB4, metal  
Body/contact assemblies - Faston connectors

3



ZBE1023



ZBE2043

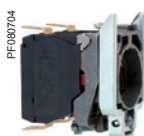

ZB4BZ1043

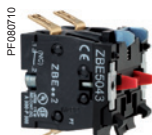

ZBE5043

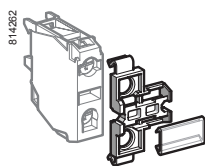

ZBZ001

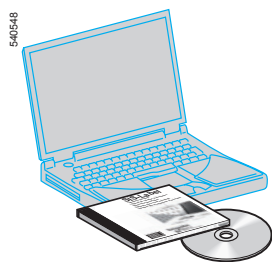

XBY2U

Contact functions <sup>(1)</sup>						
Faston connectors (Ø 6.35 or 2 x 2.8 mm/0.250 or 2 x 0.110 in.)						
(Schneider Electric anti-loosening system)						
Description	Type of contact			Sold in lots of	Unit reference	Weight kg/lb
		N/O	N/C			

Contacts for standard applications						
Contact blocks	Single	1	–	5	ZBE1013	0.011/0.024
		–	1	5	ZBE1023	0.011/0.024
	Double	2	–	5	ZBE2033	0.020/0.044
		–	2	5	ZBE2043	0.020/0.044
		1	1	5	ZBE2053	0.020/0.044
	Single with body/fixing collar	1	–	1	ZB4BZ1013 (2)	0.053/0.117
		–	1	1	ZB4BZ1023 (2)	0.053/0.117
		2	–	1	ZB4BZ1033	0.062/0.137
		–	2	1	ZB4BZ1043	0.062/0.137
1		1	1	ZB4BZ1053	0.062/0.137	

Application	Type of contact	Description			Sold in lots of	Unit reference	Weight kg/lb
			N/O	N/C			

Contacts for specific applications							
Low power switching	Single	Standard	1	–	5	ZBE10163 (2)	0.012/0.026
			–	1	5	ZBE10263 (2)	0.012/0.026
		Dusty environments <sup>(3)</sup> (IP 5X, 50 µm dust)	1	–	5	ZBE1016P3 (2)	0.012/0.026
			–	1	5	ZBE1026P3 (2)	0.012/0.026
Staggered contacts	Single	Early make	1	–	5	ZBE2013 (2)	0.011/0.024
			–	1	5	ZBE2023 (2)	0.011/0.024
		Late break	–	1	5	ZBE2033 (2)	0.011/0.024
			–	1	5	ZBE2043 (2)	0.011/0.024
High power switching	Single	Standard <sup>(4)</sup>	1	–	1	ZBE5013	0.021/0.046
			–	1	1	ZBE5023	0.021/0.046
			2	–	1	ZBE5033	0.033/0.073
			–	2	1	ZBE5043	0.033/0.073
			1	1	1	ZBE5053	0.033/0.073

Clip-on legend holder for electrical blocks with screw clamp terminal connections <sup>(5)</sup>			
For use with	Sold in lots of	Unit reference	Weight kg/lb
Identification of an XB4B control or signaling unit	10	ZBZ001	0.001/0.002

Sheet of 50 blank legends			
Legend holder ZBZ001	10	ZBY001	0.023/0.051

“SIS Label” labelling software (for legends ZBY001)			
For legend design for English, French, German, Italian, Spanish	1	XBY2U	0.100/0.220

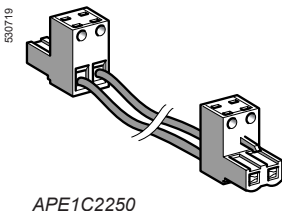
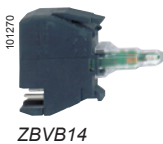

- (1) The contact blocks enable variable composition of body/contact assemblies. Maximum number of rows possible: 3. Either 3 rows of 3 single contacts or 1 row of 3 double contacts + 1 row of 3 single contacts (double contacts occupy the first 2 rows).
- (2) To order products with screw clamp terminal connections for lugs, replace the 3 at the end of the reference with a 9. Example: ZBE1013 becomes ZBE1019.
- (3) It is not possible to fit an additional contact block on the back of these contact blocks.
- (4) It is not possible to use these contacts with light blocks.
- (5) This legend holder is not compatible with high power switching contact blocks.



### Body/fixing collar

For use with	Sold in lots of	Unit reference	Weight kg/lb
Electrical block (contact or light)	10	ZB4BZ009	0.038/0.084

### Contact functions Plug-in connector (1)

Description	Type of contact			Sold in lots of	Unit reference	Weight kg/lb
<b>Contacts for standard applications</b>						
Contact blocks	Single	1	–	5	ZBE1014	0.011/0.024
		–	1	5	ZBE1024	0.011/0.024
Contact blocks	Single with body/fixing collar	1	–	1	ZB4BZ1014	0.050/0.110
		–	1	1	ZB4BZ1024	0.050/0.110
		2	–	1	ZB4BZ1034	0.058/0.128
		–	2	1	ZB4BZ1044	0.058/0.128
		1	1	1	ZB4BZ1054	0.058/0.128
		1	2	1	ZB4BZ1414	0.064/0.141

### Light blocks Plug-in connector

Description	Supply voltage (V)	Color of light source	Sold in lots of	Unit reference	Weight kg/lb
Integral LED (to combine with heads for integral LED)	~ 24 (50/60 Hz)	White	5	ZBVB14	0.016/0.035
		Green	5	ZBVB34	0.016/0.035
		Red	5	ZBVB44	0.016/0.035
		Orange	5	ZBVB54	0.016/0.035
		Blue	5	ZBVB64	0.016/0.035
		~ 110...120 (50/60 Hz)	White	5	ZBVG14
	Green	5	ZBVG34	0.016/0.035	
	Red	5	ZBVG44	0.016/0.035	
	Orange	5	ZBVG54	0.016/0.035	
	Blue	5	ZBVG64	0.016/0.035	
	~ 230...240 (50/60 Hz)	White	5	ZBVM14	0.016/0.035
	Green	5	ZBVM34	0.016/0.035	
Red	5	ZBVM44	0.016/0.035		
Orange	5	ZBVM54	0.016/0.035		
Blue	5	ZBVM64	0.016/0.035		

**Protected LED**

### Connecting cables and connector

Description	Number of connectors	Wire c. s. a. mm <sup>2</sup> /AWG	Length Ø mm/in.	Sold in lots of	Unit reference	Weight kg/lb
Cables with connectors 2-pin, Ø 5.08 mm/0.200 in. pitch	1	0.75/19	500/19.685	8	APE1C2150	0.120/0.265
	2	0.75/19	500/19.685	8	APE1C2250	0.180/0.397
Spring terminal connector 2-pin, Ø 5.08 mm/0.200 in. pitch	–	0.2 to 0.5	– /25 to 14	10	APE1PRE21	0.003/0.007

(1) It is not possible to fit an additional contact block on the back of these contact blocks.

# Acquire the information

## Control units Ø 22 - Harmony XB4, metal

### Circular yellow legends

#### Circular yellow legends for mushroom head pushbuttons

Diameter mm/in.	Conforming to standards	Marking on Yellow background	Sold in lots of	Unit Reference	Weight kg/lb
<b>Used for "Emergency stop" function (1)</b>					
90/3.543	EN/IEC 60204-1 and EN/ISO 13850	–	10	ZBY8140	0.008/0.018
		ARRET D'URGENCE	10	ZBY8130	0.008/0.018
		EMERGENCY STOP	10	ZBY8330	0.008/0.018
		NOT-HALT	10	ZBY8230	0.008/0.018
		PARADA DE EMERGENCIA	10	ZBY8430	0.008/0.018
		ARRESTO DE EMERGENZA	10	ZBY8630	0.008/0.018
<b>Used for "Emergency switching off" function</b>					
60/2.362	EN/IEC 60204-1	–	10	ZBY9101	0.004/0.009
		COUPURE D'URGENCE	10	ZBY9160	0.004/0.009
		EMERGENCY SWITCHING OFF	10	ZBY9360	0.004/0.009
		NOT-AUS	10	ZBY9260	0.004/0.009
		DESCONEXION DE EMERGENCIA	10	ZBY9460	0.004/0.009
		INTERRUZIONE DI EMERGENZA	10	ZBY9660	0.004/0.009
90/3.543	EN/IEC 60204-1	–	10	ZBY8101	0.008/0.018
		COUPURE D'URGENCE	10	ZBY8160	0.008/0.018
		EMERGENCY SWITCHING OFF	10	ZBY8360	0.008/0.018
		NOT-AUS	10	ZBY8260	0.008/0.018
		DESCONEXION DE EMERGENCIA	10	ZBY8460	0.008/0.018
		INTERRUZIONE DI EMERGENZA	10	ZBY8660	0.008/0.018

(1) For complying with EN/ISO 13850 standard, paragraph 4.4.6., Emergency Stop function logo  has been added.

DFB39842



ZBY9160

3

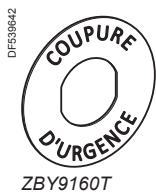
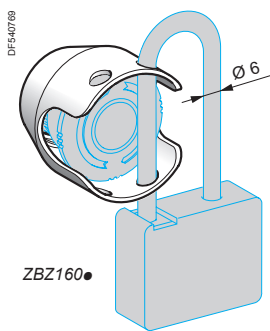
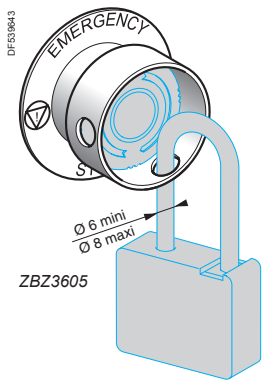

### Accessories for mushroom head pushbuttons

Description	Exclusive use with the following Ø 40 mm / 1.575 in. trigger action pushbuttons	Color	Reference	Weight kg/lb
-------------	---	-------	-----------	--------------

<b>Padlocking kit</b> (1) (2) For Emergency stop (3) and Emergency switching off function (4), (padlockable)	XB4BS844●, XB4BS9445, ZB4BS844, ZB4BS944●.	Yellow	<b>ZBZ3605</b>	0.045/0.099
<b>Metal guards</b> For Emergency stop (3) function Padlockable (2)	XB4BT8●, XB4BS8●, XB4BS9●, ZB4BT8●, ZB4BS8●, ZB4BS9●.	Chromium plated	<b>ZBZ1600</b>	0.046/0.101
		Black	<b>ZBZ1602</b>	0.046/0.101
		Red	<b>ZBZ1604</b>	0.046/0.101
		Blue	<b>ZBZ1606</b>	0.046/0.101

Description	Marking	Color	Reference	Weight kg/lb
Ø 60 mm/2.362 in. legend for padlocking device ZBZ3605 For Emergency stop function (3)	Without	Yellow	<b>ZBY9140T</b>	0.004/0.009
	ARRET D'URGENCE	Yellow	<b>ZBY9130T</b>	0.004/0.009
	EMERGENCY STOP	Yellow	<b>ZBY9330T</b>	0.004/0.009
Ø 60 mm/2.362 in. legend for padlocking device ZBZ3605 For Emergency stop function (3)	NOT-HALT	Yellow	<b>ZBY9230T</b>	0.004/0.009
	Without	Yellow	<b>ZBY9101T</b>	0.004/0.009
Ø 60 mm/2.362 in. legend for padlocking device ZBZ3605 For Emergency switching off function (4)	COUPURE D'URGENCE	Yellow	<b>ZBY9160T</b>	0.004/0.009
	EMERGENCY SWITCHING OFF	Yellow	<b>ZBY9360T</b>	0.004/0.009
	NOT-AUS	Yellow	<b>ZBY9260T</b>	0.004/0.009

Description	Marking	Color	Sold in lots of	Reference	Weight kg/lb
Ø 60 mm/2.362 in. legend for Emergency stop function	–	Yellow	5	<b>ZBY9121</b>	0.007/0.015
	EMERGENCY STOP	Yellow	5	<b>ZBY9320</b>	0.007/0.015
	ARRET D'URGENCE	Yellow	5	<b>ZBY9120</b>	0.007/0.015
	NOT HALT	Yellow	5	<b>ZBY9220</b>	0.007/0.015
	PARADA DE EMERGENCIA	Yellow	5	<b>ZBY9420</b>	0.007/0.015
	ARRESTO DI EMERGENZA	Yellow	5	<b>ZBY9620</b>	0.007/0.015

### Other accessories

Description	For use with	Color	Reference	Weight kg/lb
<b>Plastic guard</b>	Selector switches and key switches	Black	<b>ZBZ2102</b>	0.005/0.011
<b>Padlockable flaps</b>	Pushbuttons	Black	<b>ZB4BZ62</b>	0.076/0.168
		Red	<b>ZB4BZ64</b>	0.076/0.168
		Yellow	<b>ZB4BZ65</b>	0.076/0.168
		Blue	<b>ZB4BZ66</b>	0.076/0.168

(1) Standard circular legends are not compatible with this product. Use special legends **ZBY9●●●T**.

(2) No isolation function is possible when this guard is fitted.

(3) Ensures conformity with standards EN/IEC 60204-1 and EN/ISO 13850.

(4) Ensures conformity with standard EN/IEC 60204-1.

(5) Only when mounted on control stations. Use legends **ZBY9●●●T**.

# Acquire the information

Control units Ø 22 - Harmony XB5, plastic  
 Emergency stop and Emergency switching off functions  
 Conforming to EN/IEC 60204-1, 60364-5-53,  
 EN/ISO 13850 and Machinery Directive 2006/42/EC

3

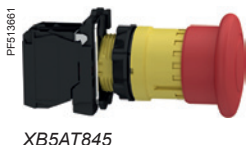

XB5AT845

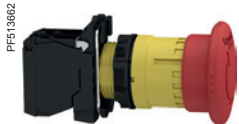

XB5AS8445

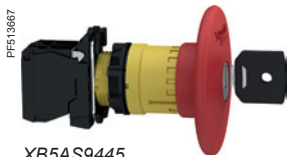

XB5AS9445



ZB5AT84



ZB5AS844



ZB5AS834



ZB5AS934

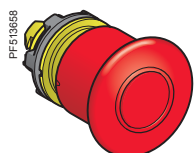

ZB5AT8643M

## Emergency stop and switching off pushbuttons with trigger action and mechanical latching (1) (2)

Screw clamp terminal connections (Schneider Electric anti-loosening system)

Shape of head	Type of reset	Type of contact	Push	Color	Reference	Weight kg/lb
			Ø (mm)/in.			

### Complete units

	Push-pull	-	1	40/1.575	Red	<b>XB5AT842</b> (ZB5AZ102 + ZB5AT84)	0.065/0.143
		1	1	40/1.575	Red	<b>XB5AT845</b> (ZB5AZ105 + ZB5AT84)	0.076/0.168
	Turn to release	-	1	40/1.575	Red	<b>XB5AS8442</b> (ZB5AZ102 + ZB5AS844)	0.060/0.132
		1	1	40/1.575	Red	<b>XB5AS8445</b> (ZB5AZ105 + ZB5AS844)	0.072/0.159
		-	2	40/1.575	Red	<b>XB5AS8444</b> (ZB5AZ104 + ZB5AS844)	0.072/0.159
	Key release (key n° 455) (3)	-	1	40/1.575	Red	<b>XB5AS9442</b> (ZB5AZ102 + ZB5AS944)	0.075/0.165
		1	1	40/1.575	Red	<b>XB5AS9445</b> (ZB5AZ105 + ZB5AS944)	0.112/0.247

### Heads only

	Push-pull	30/1.181	Red	<b>ZB5AT844</b>	0.049/0.108
		40/1.575	Red	<b>ZB5AT84</b>	0.049/0.108
		60/2.362	Red	<b>ZB5AX84</b>	0.067/0.148
	Turn to release	30/1.181	Red	<b>ZB5AS834</b>	0.042/0.002
		40/1.575	Red	<b>ZB5AS844</b>	0.046/0.002
	Key release (key n° 455) (2 keys included with head) (5)(3)	30/1.181	Red	<b>ZB5AS934</b>	0.068/0.003
		40/1.575	Red	<b>ZB5AS944 (4)</b>	0.071/0.003
		60/2.362	Red	<b>ZB5AS964</b>	0.092/0.004
		40/1.575	Red	<b>ZB5AS944D</b>	0.071/0.003

## Illuminated Emergency stop and Emergency switching off functions, mechanical latching pushbuttons with mechanical state indicator (1)

For elevator inspection box applications

Shape of head	Type of reset	Push	Unit	Weight kg/lb
		Ø mm/in.	Color reference	

### Heads only (6)

	Push-pull (7)	40/1.575	Red	<b>ZB5AT8643M</b>	0.034/0.075
--	---------------	----------	-----	-------------------	-------------

## Illuminated Emergency switching off function only, mechanical latching pushbuttons (1)

Screw clamp terminal connections (Schneider Electric anti-loosening system)

Shape of head	Type of reset	Push	Color	Reference	Weight kg/lb
		Ø (mm)/in.			
	Turn to release	40/1.575	Red	<b>ZB5AW743</b>	0.022/0.049

(1) Recommended maximum number of contacts constituting the body (fixing collar and contact) associated with the head, see page 12 of Harmony XB5 catalog DIA5ED2121213EN.

(2) It is recommended that a legend or yellow background is used.

(3) The symbol indicates key withdrawal position(s).

(4) Other key numbers:

- key n° 421E: add suffix **12** to the reference.
- key n° 458A: add suffix **10** to the reference.
- key n° 520E: add suffix **14** to the reference.
- key n° 3131A: add suffix **20** to the reference.
- key n° 4A185: add suffix **D** to the reference.

Example: To order a Ø 40 mm/1.575 in. red mushroom head for a trigger action and mechanical latching Emergency stop pushbutton, with release by key n° 421E, the reference becomes: **ZB5AS94412**.

(5) For specific keys with other numbers, please consult our Customer Care Centre.

(6) Only for use with bodies comprising a light source with integral LED.

(7) Cannot be used with metal guards **ZBZ160**.

# Acquire the information

Control units Ø 22 - Harmony XB5, plastic  
General safe stop and circular yellow legends for  
Emergency stop



ZB5AT82Y

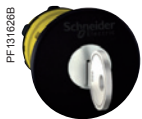

ZB5AS942Y



ZBY9121



ZBY9420



ZBZ28

## General safe stops

General safe stops are used to stop the operation of a machine in a safe manner. These devices cannot be used as Emergency stop and must not be associated with a Yellow background. The general safe stop are made with Yellow bezel and Black head.

Shape of head	Type of reset	Push		Reference	Weight kg/lb
		Ø (mm)/in.	Color		
	Push-pull	40/1.575	Black	ZB5AT82Y	0.050/0.110
	Turn to release	40/1.575	Black	ZB5AS842Y	0.046/0.101
	Key release (key n° 455) 2 keys included with head (2)	40/1.575	Black	ZB5AS942Y	0.071/0.157

## Circular yellow legends for Emergency stop (1)

Description	Marking	Color	Sold in lots of	Reference	Weight kg/lb
Ø 60 mm /2.362 in. legend for Emergency stop function	-	Yellow	5	ZBY9121	0.007/0.015
	EMERGENCY STOP	Yellow	5	ZBY9320	0.007/0.015
	ARRET D'URGENCE	Yellow	5	ZBY9120	0.007/0.015
	NOT HALT	Yellow	5	ZBY9220	0.007/0.015
	PARADA DE EMERGENCIA	Yellow	5	ZBY9420	0.007/0.015
	ARRESTO DI EMERGENZA	Yellow	5	ZBY9620	0.007/0.015

## Bellows for harsh environments (IP 69K) (3)

Description	Material	For use with	Color	Sold in lots of	Unit reference	Weight kg/lb
For use in environments subject to humidity, dust, high pressure cleaning, etc.	Silicone	Emergency stop / Switching off function	Yellow	2	ZBZ28	0.009/0.020
		Other functions	Black	2	ZBZ58	0.009/0.020

(1) Other legend models for Emergency stop and Emergency switching off function, see page 58 of catalog DIA5D2121212EN

(2) The symbol indicates key withdrawal position(s).

(3) Not compatible with Ø 30 mm/1.181 in. pushbuttons.



# Acquire the information

Control units Ø 22 - Harmony XB5, plastic  
Body/contact assemblies - Screw clamp terminal connections



ZB5AZ009



ZBE101



ZBE203



ZB5AZ101



ZBE201



ZB5AZ107



ZBE501



ZB2BE101

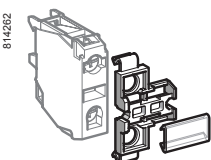

ZBZ001

## Body/fixing collar

For use with	Sold in lots of	Unit reference	Weight kg/lb
Electrical block (contact or light)	10	ZB5AZ009	0.006/0.013

## Contact functions (1)

### Screw clamp terminal connections (Schneider Electric anti-loosening system)

Application	Type of contact	Description	Symbol	Sold in lots of	Unit reference	Weight kg/lb
			N/O			
			N/C			

## Contacts for standard applications

Contacts for standard applications	Single	Double	Single with body/fixing collar	Symbol	Sold in lots of	Unit reference	Weight kg/lb
Contacts for standard applications	1	–	5	ZBE101	0.011/0.024		
	–	1	5	ZBE102	0.011/0.024		
	2	–	5	ZBE203	0.020/0.044		
	–	2	5	ZBE204	0.020/0.044		
	1	1	5	ZBE205	0.020/0.044		
	1	–	1	ZB5AZ101	0.021/0.046		
	–	1	1	ZB5AZ102	0.021/0.046		
	2	–	1	ZB5AZ103	0.030/0.066		
	–	2	1	ZB5AZ104	0.030/0.066		
	1	1	1	ZB5AZ105	0.030/0.066		
1	2	1	ZB5AZ141	0.040/0.088			

## Contacts for specific applications

Low power switching	Single	Standard	Symbol	Sold in lots of	Unit reference	Weight kg/lb
Low power switching	1	–	5	ZBE1016	0.012/0.026	
	–	1	5	ZBE1026	0.012/0.026	
	1	–	5	ZBE1016P	0.012/0.026	
	–	1	5	ZBE1026P	0.012/0.026	
Staggered contacts	1	–	5	ZBE201	0.011/0.024	
	–	1	5	ZBE202	0.011/0.024	
	1	1	5	ZB4BZ106	0.062/0.137	
	2	–	5	ZB4BZ107	0.062/0.137	
High power switching	1	–	1	ZBE501	0.020/0.044	
	–	1	1	ZBE502	0.020/0.044	
	2	–	1	ZBE503	0.032/0.071	
	–	2	1	ZBE504	0.032/0.071	
	1	1	1	ZBE505	0.032/0.071	
Additional contact blocks for high power switching	1	–	1	ZB2BE101	0.020/0.044	
	–	1	1	ZB2BE102	0.020/0.044	

## Clip-on legend holder, sheet of blank legends and labelling software

Description	Sold in lots of	Unit reference	Weight kg/lb
Clip-on legend-holder for electrical blocks with screw clamp terminal connections (5). For identification of an XB4B control or signaling unit	10	ZBZ001	0.001/0.002
Sheet of 50 blank legends for legend holder ZBZ001	10	ZBY001	0.023/0.051
"SIS Label" labelling software for legend design (ZBY001 legends) (for design of legends in English, French, German, Italian, Spanish)	1	XBY2U	0.100/0.220

(1) The contact blocks enable variable composition of body/contact assemblies. Maximum number of rows possible: 3. Either 3 rows of 3 single contacts or 1 row of 3 double contacts + 1 row of 3 single contacts (double contacts occupy the first 2 rows). Maximum number of contacts is specified on page 12 of Harmony XB5 catalog DIA5ED2121213EN.  
 (2) It is not possible to fit an additional contact block on the back of these contact blocks.  
 (3) It is not possible to fit an additional contact block on the back of these contact blocks or to use these contacts with light blocks.  
 (4) To be fitted on the back of ZBE50● contacts.  
 (5) This legend holder is not compatible with high power switching contacts.

# Acquire the information

Control units Ø 22 - Harmony XB5, plastic  
Light blocks - "Test light" - Protection

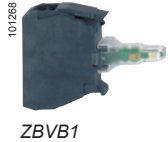

ZBVB1



ZBV5B



ZBZG156



ZBZM156



ZBZVG

### Light blocks

Description	Supply voltage(V)	Color of light source	Sold in lots of	Unit reference	Weight kg/lb
<b>Light blocks with screw clamp terminal connections</b> (SchneiderElectric anti-loosening system)					
<b>Integral LED</b> (to combine with heads for integral LED)	~ 12 (50/60 Hz)	White	5	<b>ZBVJ1</b>	0.017/0.037
		Green	5	<b>ZBVJ3</b>	0.017/0.037
		Red	5	<b>ZBVJ4</b>	0.017/0.037
		Orange	5	<b>ZBVJ5</b>	0.017/0.037
		Blue	5	<b>ZBVJ6</b>	0.017/0.037
	~ 24 (50/60 Hz)	White	5	<b>ZBVB1</b>	0.017/0.037
		Green	5	<b>ZBVB3</b>	0.017/0.037
		Red	5	<b>ZBVB4</b>	0.017/0.037
		Orange	5	<b>ZBVB5</b>	0.017/0.037
		Blue	5	<b>ZBVB6</b>	0.017/0.037
	~ 24...120 (50/60 Hz)	White	5	<b>ZBVBG1</b>	0.017/0.037
		Green	5	<b>ZBVBG3</b>	0.017/0.037
		Red	5	<b>ZBVBG4</b>	0.017/0.037
		Orange	5	<b>ZBVBG5</b>	0.017/0.037
		Blue	5	<b>ZBVBG6</b>	0.017/0.037
	~ 110...120 (50/60 Hz)	White	5	<b>ZBVG1</b>	0.017/0.037
		Green	5	<b>ZBVG3</b>	0.017/0.037
		Red	5	<b>ZBVG4</b>	0.017/0.037
		Orange	5	<b>ZBVG5</b>	0.017/0.037
		Blue	5	<b>ZBVG6</b>	0.017/0.037
	~ 230...240 (50/60 Hz)	White	5	<b>ZBVM1</b>	0.017/0.037
		Green	5	<b>ZBVM3</b>	0.017/0.037
		Red	5	<b>ZBVM4</b>	0.017/0.037
		Orange	5	<b>ZBVM5</b>	0.017/0.037
		Blue	5	<b>ZBVM6</b>	0.017/0.037

### Flashing light blocks with screw clamp terminal connections

(Schneider Electric anti-loosening system)					
<b>Integral LED</b> (to combine with heads for integral LED)	~ 24 (50/60 Hz)	White	5	<b>ZBV18B1</b>	0.017/0.037
		Green	5	<b>ZBV18B3</b>	0.017/0.037
		Red	5	<b>ZBV18B4</b>	0.017/0.037
		Orange	5	<b>ZBV18B5</b>	0.017/0.037
		Blue	5	<b>ZBV18B6</b>	0.017/0.037
	~ 110...120 (50/60 Hz)	White	5	<b>ZBV18G1</b>	0.017/0.037
		Green	5	<b>ZBV18G3</b>	0.017/0.037
		Red	5	<b>ZBV18G4</b>	0.017/0.037
		Orange	5	<b>ZBV18G5</b>	0.017/0.037
		Blue	5	<b>ZBV18G6</b>	0.017/0.037
	~ 230...240 (50/60 Hz)	White	5	<b>ZBV18M1</b>	0.017/0.037
		Green	5	<b>ZBV18M3</b>	0.017/0.037
		Red	5	<b>ZBV18M4</b>	0.017/0.037
		Orange	5	<b>ZBV18M5</b>	0.017/0.037
		Blue	5	<b>ZBV18M6</b>	0.017/0.037

For use with	Supply voltage(V)	Description	Reference	Weight kg/lb
--------------	-------------------	-------------	-----------	--------------

**Transformer blocks for 24 V light blocks (1)**  
Light blocks with integral LED ~ 400 V - 50Hz Transformer 400 V - 24 V ~ **ZBV5B (2)** 0.090/0.198

### Blocks for "test light" function

<b>Light blocks</b>	~ 12 and 24 ~ 24...120	Single module, 1 connecting wire	<b>ZBZG156 (3)</b>	0.010/0.022
<b>Light blocks with integral LED</b>	~ 48...230	Double module, with connecting wires	<b>ZBZG156 (3)</b>	0.010/0.022

### LED suppressors

For use with	Supply voltage(V)	Level of protection	Reference	Weight kg/lb
<b>Light blocks with integral LED fitted with screw clamp terminal connections</b>	~ 120	25...120 VA	<b>ZBZVG</b>	0.010/0.022
	~ 230	30...230 VA	<b>ZBZVM</b>	0.010/0.022

(1) To be used with 2 dummy contact blocks **ZBE000**.  
 (2) To order ~ 440...460 V - 60 Hz transformer blocks, please replace "5" in the reference by "8": **ZBV5B** becomes **ZBV8B**. To order ~ 550...600 V - 60 Hz transformer blocks, please replace "5" by "9": **ZBV5B** becomes **ZBV9B**.  
 (3) Block for use with ~ light blocks with integral LED types **ZBVJ●**, **ZBVB●**, **ZBVBG●** or with direct supply light block for BA 9s bulb, **ZBV6**.  
 (4) Block for use ~ light blocks integral LED types **ZBVG●**, **ZBVM●**, see connection on our website [www.schneider-electric.com](http://www.schneider-electric.com).

# Acquire the information

Control units Ø 22 - Harmony XB5, plastic  
Body/contact assemblies - Spring clamp terminal connections

814688



ZB5AZ009

PF107777



ZBE1015

3

PF107781



ZB5AZ1015

PF080711



ZBVB35

814262

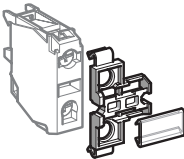

ZBZ001

540548



XBY2U

### Body/fixing collar

For use with	Sold in lots of	Unit reference	Weight kg/lb
Electrical block (contact or light)	10	ZB5AZ009	0.006/0.013

### Contact functions Spring clamp terminal connections (1)

Description	Type of contact			Sold in lots of	Unit reference	Weight kg/lb
		N/O	N/C			

### Contacts for standard applications

Contact blocks	Single			Sold in lots of	Unit reference	Weight kg/lb
	1	-	4	4	ZBE1015	0.011/0.024
	-	1	4	4	ZBE1025	0.011/0.024
	1	-	1	1	ZB5AZ1015	0.021/0.046
	-	1	1	1	ZB5AZ1025	0.021/0.046
	2	-	1	1	ZB5AZ1035	0.030/0.066
	-	2	1	1	ZB5AZ1045	0.030/0.066
	1	1	1	1	ZB5AZ1055	0.030/0.066

### Light blocks Spring clamp terminal connections (1)

Description	Supply voltage V	Color of light source	Sold in lots of	Unit reference	Weight kg/lb
Integral LED (to combine with heads for integral LED)	~ 12 (50/60 Hz)	White	4	ZBVJ15	0.016/0.035
		Green	4	ZBVJ35	0.016/0.035
		Red	4	ZBVJ45	0.016/0.035
		Orange	4	ZBVJ55	0.016/0.035
		Blue	4	ZBVJ65	0.016/0.035
	~ 24 (50/60 Hz)	White	4	ZBVB15	0.016/0.035
		Green	4	ZBVB35	0.016/0.035
		Red	4	ZBVB45	0.016/0.035
		Orange	4	ZBVB55	0.016/0.035
		Blue	4	ZBVB65	0.016/0.035
	~ 110...120 (50/60 Hz)	White	4	ZBVG15	0.016/0.035
		Green	4	ZBVG35	0.016/0.035
		Red	4	ZBVG45	0.016/0.035
		Orange	4	ZBVG55	0.016/0.035
		Blue	4	ZBVG65	0.016/0.035
	~ 230...240 (50/60 Hz)	White	4	ZBVM15	0.016/0.035
		Green	4	ZBVM35	0.016/0.035
		Red	4	ZBVM45	0.016/0.035
		Orange	4	ZBVM55	0.016/0.035
		Blue	4	ZBVM65	0.016/0.035

### Sheet of 50 blank legends

For use with	Sold in lots of	Unit reference	Weight kg/lb
Legend holder ZBZ001	10	ZBY001	0.023/0.051

### "SIS Label" labelling software (for legends ZBY001)

For legend design for English, French, German, Italian, Spanish	Sold in lots of	Unit reference	Weight kg/lb
	10	XBY2U	0.100/0.220

(1) It is not possible to fit an additional block on the back of these contact or light blocks.

# Acquire the information

Control units Ø 22 - Harmony XB5, plastic  
Body/contact assemblies - Faston connectors



ZBE1023



ZBE2043

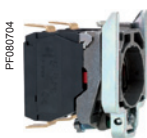

ZB4BZ1043

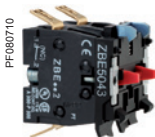

ZBE5043

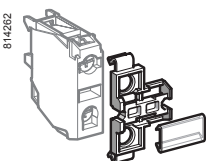

ZBZ001

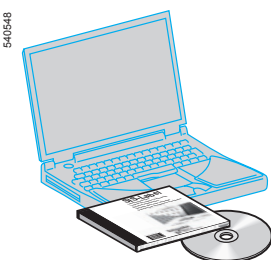

XBY2U

## Contact functions <sup>(1)</sup>

Faston connectors (Ø 6.35 or 2 x 2.8 mm/0.250 or 2 x 0.110 in.)

### Contacts for standard applications

Description	Type of contact	Symbol		Sold in lots of	Unit reference	Weight kg/lb
		N/O	N/C			
Contact blocks	Single	1	–	5	ZBE1013	0.011/0.024
		–	1	5	ZBE1023	0.011/0.024
	Double	2	–	5	ZBE2033	0.020/0.044
		–	2	5	ZBE2043	0.020/0.044
	Single with body/fixing collar	1	1	5	ZBE2053	0.020/0.044
		1	–	1	ZB5AZ1013 <sup>(2)</sup>	0.021/0.046
–		1	1	ZB5AZ1023 <sup>(2)</sup>	0.021/0.046	
		2	–	1	ZB5AZ1033	0.030/0.066
		–	2	1	ZB5AZ1043	0.030/0.066
		1	1	1	ZB5AZ1053	0.030/0.066

### Contacts for specific applications

Application	Type of contact	Description	Symbol		Sold in lots of	Unit reference	Weight kg/lb
			N/O	N/C			
Low power switching	Single	Standard	1	–	5	ZBE10163 <sup>(2)</sup>	0.012/0.026
			–	1	5	ZBE10263 <sup>(2)</sup>	0.012/0.026
		Dusty environments <sup>(3)</sup> (IP 5X, 50 µm dust)	1	–	5	ZBE1016P3 <sup>(2)</sup>	0.012/0.026
			–	1	5	ZBE1026P3 <sup>(2)</sup>	0.012/0.026
Staggered contacts	Single	Early make	1	–	5	ZBE2013 <sup>(2)</sup>	0.011/0.024
			N/O				
		Late break	–	1	5	ZBE2023 <sup>(2)</sup>	0.011/0.024
			N/C				
High power switching	Single	Standard <sup>(4)</sup>	1	–	1	ZBE5013	0.021/0.046
			–	1	1	ZBE5023	0.021/0.046
			2	–	1	ZBE5033	0.033/0.073
			–	2	1	ZBE5043	0.033/0.073
			1	1	1	ZBE5053	0.033/0.073

## Clip-on legend holder for electrical blocks with screw clamp terminal connections <sup>(5)</sup>

For use with	Sold in lots of	Unit reference	Weight kg/lb
Identification of an XB5A control or signaling unit	10	ZBZ001	0.001/0.002

## Sheet of 50 blank legends

Legend holder ZBZ001	10	ZBY001	0.023/0.051
----------------------	----	--------	-------------

## “SIS Label” labelling software (for legends ZBY001)

For legend design for English, French, German, Italian, Spanish	1	XBY2U	0.100/0.220
---	---	-------	-------------

- <sup>(1)</sup> The contact blocks enable variable composition of body/contact assemblies. Maximum number of rows possible: 3. Either 3 rows of 3 single contacts or 1 row of 3 double contacts + 1 row of 3 single contacts (double contacts occupy the first 2 rows).
- <sup>(2)</sup> To order products with screw clamp terminal connections for lugs, replace the 3 at the end of the reference with a 9. Example: ZBE1013 becomes ZBE1019.
- <sup>(3)</sup> It is not possible to fit an additional contact block on the back of these contact blocks.
- <sup>(4)</sup> It is not possible to use these contacts with light blocks.
- <sup>(5)</sup> This legend holder is not compatible with high power switching contacts.

# Acquire the information

Control units Ø 22 - Harmony XB5, plastic  
Body/contact assemblies - Plug-in connector



ZB5AZ009



ZBE1014



ZBE1024



ZB5AZ1014



ZB5AZ1024



ZBVB14

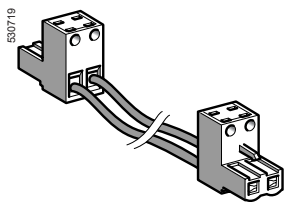

APE1C2250

### Body/fixing collar

For use with	Sold in lots of	Unit reference	Weight kg/lb
Electrical block (contact or light)	10	ZB5AZ009	0.006/0.013

### Contact functions Plug-in connector (1)

Description	Type of contact	N/O	N/C	Sold in lots of	Unit reference	Weight kg/lb
-------------	-----------------	-----	-----	-----------------	----------------	--------------

### Contacts for standard applications

Contact blocks	Single	1	–	5	ZBE1014	0.011/0.024
		–	1	5	ZBE1024	0.011/0.024
	Single with body/fixing collar	1	–	1	ZB5AZ1014	0.018/0.040
		–	1	1	ZB5AZ1024	0.018/0.040
		2	–	1	ZB5AZ1034	0.026/0.057
		–	2	1	ZB5AZ1044	0.026/0.057
		1	1	1	ZB5AZ1054	0.026/0.057
		1	2	1	ZB5AZ1414	0.036/0.079

### Light blocks Plug-in connector

Description	Supply voltage (V)	Color of light source	Sold in lots of	Unit reference	Weight kg/lb
Integral LED (to combine with heads for integral LED)	≈ 24 (50/60 Hz)	White	5	ZBVB14	0.016/0.035
		Green	5	ZBVB34	0.016/0.035
		Red	5	ZBVB44	0.016/0.035
		Orange	5	ZBVB54	0.016/0.035
		Blue	5	ZBVB64	0.016/0.035
		~ 110...120 (50/60 Hz)	White	5	ZBVG14
	Green	5	ZBVG34	0.016/0.035	
	Red	5	ZBVG44	0.016/0.035	
	Orange	5	ZBVG54	0.016/0.035	
	Blue	5	ZBVG64	0.016/0.035	
	~ 230...240 (50/60 Hz)	White	5	ZBVM14	0.016/0.035
	Green	5	ZBVM34	0.016/0.035	
Red	5	ZBVM44	0.016/0.035		
Orange	5	ZBVM54	0.016/0.035		
Blue	5	ZBVM64	0.016/0.035		

### Connecting cables and connector

Description	Number of connectors	Wire c. s. a. mm <sup>2</sup> /AWG	Length Ø mm/in.	Sold in lots of	Unit reference	Weight kg/lb
Cables with connectors 2-pin, Ø 5.08 mm/0.200 in. pitch	1	0.75/19	500/19.685	8	APE1C2150	0.120/0.265
	2	0.75/19	500/19.685	8	APE1C2250	0.180/0.397
Spring terminal connector 2-pin, Ø 5.08 mm/0.200 in. pitch	–	0.2 to 0.5 – /25 to 14	–	10	APE1PRE21	0.003/0.007

(1) It is not possible to fit an additional contact block on the back of these contact blocks.

3

# Acquire the information

## Control units Ø 22 - Harmony XB5, plastic

### Circular yellow legends



ZBY9130



ZBY9160

#### Circular yellow legends for mushroom head pushbuttons

Diameter mm/in.	Conforming to standards	Marking on Yellow background	Sold in lots of	Unit Reference	Weight kg/lb
<b>Used for "Emergency stop" function (1)</b>					
90/3.543	EN/IEC 60204-1 and EN/ISO 13850	–	10	ZBY8140	0.008/0.018
		ARRET D'URGENCE	10	ZBY8130	0.008/0.018
		EMERGENCY STOP	10	ZBY8330	0.008/0.018
		NOT-HALT	10	ZBY8230	0.008/0.018
		PARADA DE EMERGENCIA	10	ZBY8430	0.008/0.018
		ARRESTO DE EMERGENZA	10	ZBY8630	0.008/0.018
<b>Used for "Emergency switching off" function</b>					
60/2.362	EN/IEC 60204-1	–	10	ZBY9101	0.004/0.009
		COUPURE D'URGENCE	10	ZBY9160	0.004/0.009
		EMERGENCY SWITCHING OFF	10	ZBY9360	0.004/0.009
		NOT-AUS	10	ZBY9260	0.004/0.009
		DESCONEXION DE EMERGENCIA	10	ZBY9460	0.004/0.009
		INTERRUZIONE DI EMERGENZA	10	ZBY9660	0.004/0.009
90/3.543	EN/IEC 60204-1	–	10	ZBY8101	0.008/0.018
		COUPURE D'URGENCE	10	ZBY8160	0.008/0.018
		EMERGENCY SWITCHING OFF	10	ZBY8360	0.008/0.018
		NOT-AUS	10	ZBY8260	0.008/0.018
		DESCONEXION DE EMERGENCIA	10	ZBY8460	0.008/0.018
		INTERRUZIONE DI EMERGENZA	10	ZBY8660	0.008/0.018

(1) For complying with EN/ISO 13850 standard, paragraph 4.4.6., Emergency Stop function logo  has been added.

# Acquire the information

## Control units Ø 22 - Harmony XB5, plastic

### Accessories for pushbuttons

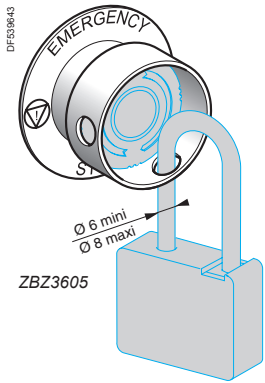

ZBZ3605

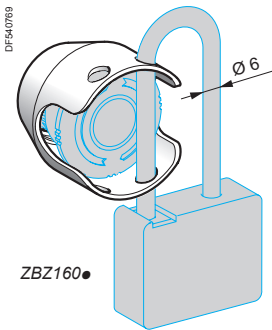

ZBZ160



ZBY9160T



ZBY9121



ZBY9420



ZB4BZ64

#### Accessories for mushroom head pushbuttons

Description	Exclusive use with the following Ø 40 mm / 1.575 in. trigger action pushbuttons	Color	Reference	Weight kg/lb
-------------	---	-------	-----------	--------------

<b>Padlocking kit</b> (1) (2) For Emergency stop (3) and Emergency switching off function (4), (padlockable)	XB5AS844●, XB5AS944●, ZB5AS844, ZB5AS944●	Yellow	<b>ZBZ3605</b>	0.045/0.099
<b>Metal guards</b> For Emergency stop (3) function Padlockable (2)	XB5AT8●, XB5AS8●, XB5AS9●, ZB5AT8●, ZB5AS8●, ZB5AS9●	Chromium plated	<b>ZBZ1600</b>	0.046/0.101
		Black	<b>ZBZ1602</b>	0.046/0.101
		Red	<b>ZBZ1604</b>	0.046/0.101
		Blue	<b>ZBZ1606</b>	0.046/0.101

Description	Marking	Color	Reference	Weight kg/lb
Ø 60 mm / 2.362 in. legend for padlocking device ZBZ3605 For Emergency stop function (3)	Without	Yellow	<b>ZBY9140T</b>	0.004/0.009
	ARRET D'URGENCE	Yellow	<b>ZBY9130T</b>	0.004/0.009
	EMERGENCY STOP	Yellow	<b>ZBY9330T</b>	0.004/0.009
Ø 60 mm / 2.362 in. legend for padlocking device ZBZ3605 For Emergency switching off function (4)	NOT-HALT	Yellow	<b>ZBY9230T</b>	0.004/0.009
	Without	Yellow	<b>ZBY9101T</b>	0.004/0.009
Ø 60 mm / 2.362 in. legend for padlocking device ZBZ3605 For Emergency switching off function (4)	COUPURE D'URGENCE	Yellow	<b>ZBY9160T</b>	0.004/0.009
	EMERGENCY SWITCHING OFF	Yellow	<b>ZBY9360T</b>	0.004/0.009
	NOT-AUS	Yellow	<b>ZBY9260T</b>	0.004/0.009

Description	Marking	Color	Sold in lots of	Reference	Weight kg/lb
Ø 60 mm / 2.362 in. legend for Emergency stop function	-	Yellow	5	<b>ZBY9121</b>	0.007/0.015
	EMERGENCY STOP	Yellow	5	<b>ZBY9320</b>	0.007/0.015
	ARRET D'URGENCE	Yellow	5	<b>ZBY9120</b>	0.007/0.015
	NOT HALT	Yellow	5	<b>ZBY9220</b>	0.007/0.015
	PARADA DE EMERGENCIA	Yellow	5	<b>ZBY9420</b>	0.007/0.015
	ARRESTO DI EMERGENZA	Yellow	5	<b>ZBY9620</b>	0.007/0.015

#### Other accessories

Description	For use with	Color	Reference	Weight kg/lb
<b>Plastic guard</b>	Selector switches and key switches	Black	<b>ZBZ2102</b>	0.005/0.011
<b>Padlockable flaps</b>	Pushbuttons	Black	<b>ZB4BZ62</b>	0.076/0.168
		Red	<b>ZB4BZ64</b>	0.076/0.168
		Yellow	<b>ZB4BZ65</b>	0.076/0.168
		Blue	<b>ZB4BZ66</b>	0.076/0.168

(1) Standard circular legends are not compatible with this product. Use special legends ZBY9●●●T.

(2) No isolation function is possible when this guard is fitted.

(3) Ensures conformity with standards EN/IEC 60204-1 and EN/ISO 13850.

(4) Ensures conformity with standard EN/IEC 60204-1.

(5) Only when mounted on control stations. Use legends ZBY9●●●T.





# Acquire the information

Control units Ø 22 - Harmony XB7, monolithic  
Emergency stop pushbuttons, circular legends



XB7NS842

## Emergency stop and emergency switching off function with mechanical latching

Shape of head	Type of push	Standards			Sold in lots of	Unit reference	Weight kg/lb
<b>Contacts for standard applications</b>							
	Turn to release	EN/IEC 60204-1, EN/ISO 13850, EN/IEC 60947-5-5, Machinery directive 2006/42/EC and UL	-	1	10	<b>XB7NS8442</b>	0.045/0.099
			1	1	10	<b>XB7NS8445</b>	0.045/0.099
	Push-pull		-	2	10	<b>XB7NS8444</b>	0.045/0.099
			-	1	10	<b>XB7NT842</b>	0.040/0.088
	Key release (n° 455)		1	1	10	<b>XB7NT845</b>	0.040/0.088
			-	2	10	<b>XB7NT844</b>	0.040/0.088
			-	2	10	<b>XB7NS9444</b>	0.072/0.159
			-	1	10	<b>XB7NS9445</b>	0.072/0.159

## Circular legends, yellow, for mushroom head pushbuttons

Description	Marking on yellow background	Sold in lots of	Unit reference	Weight kg/lb
<b>Used for "Emergency stop" function (1)</b>				
Ø 60 mm/2.362 in. circular legend compatible with Emergency stop	-	5	<b>ZBY9121</b>	0.007/0.015
	ARRET D'URGENCE	5	<b>ZBY9320</b>	0.007/0.015
	EMERGENCY STOP	5	<b>ZBY9120</b>	0.007/0.015
	NOT-HALT	5	<b>ZBY9220</b>	0.007/0.015
	PARADA DE EMERGENCIA	5	<b>ZBY9420</b>	0.007/0.015
	ARRESTO DE EMERGENZA	5	<b>ZBY9620</b>	0.007/0.015
Ø 90 mm/3.543 in. circular legend compatible with Emergency stop	-	10	<b>ZBY8140</b>	0.008/0.018
	ARRET D'URGENCE	10	<b>ZBY8130</b>	0.008/0.018
	EMERGENCY STOP	10	<b>ZBY8330</b>	0.008/0.018
	NOT-HALT	10	<b>ZBY8230</b>	0.008/0.018
	PARADA DE EMERGENCIA	10	<b>ZBY8430</b>	0.008/0.018
	ARRESTO DE EMERGENZA	10	<b>ZBY8630</b>	0.008/0.018

(1) For compliance with standard EN/ISO 13850, paragraph 4.4.6, the Emergency stop logo  has been added.



ZBY9130



# Acquire the information

Control units Ø 30  
Harmony 9001K & SK range  
Emergency stop pushbuttons

## Presentation

The Ø 30 mm/1.181 in. Harmony 9001 range of Emergency stop and Emergency switching off functions is robust and meet a great number of applications in heavy industries such as: petrochemical, metallurgy, mining, oil and gas, wastewater treatment, and automobile manufacturing.

- Two family of products are available :
  - The Harmony 9001K control and signalling units offering good robustness with a chromium plated metal bezel
  - The Harmony 9001SK control and signalling units, with a double insulated bezel designed for applications requiring a high resistance to corrosion
- This range includes:
  - Emergency stop trigger action and mechanical latching pushbuttons (conforming to standards EN/IEC 60204-1 and EN/ISO 13850)
  - Choice of accessories and spare parts common to both families,
  - Choice of aluminium or plastic legend plates.

## Installation

- Harmony 9001 products are both simple and quick to install:
  - Block setting by single installer with a single screw contact block,
  - Automatic self-grounding operators without additional wiring,
  - Easy function identification thanks to the coloured contact blocks,
  - Clear window for status of contact operation and troubleshooting,
  - Side-by-side and/or stacked mounting of contact blocks to minimize enclosure space requirements.
- Connection is made through screw clamp terminals (cross headed slotted screw)

## Environment

The performance features of these range meet the most demanding international standards and approvals:

- Degrees of protection:

Products are originally oil-tight, dust-tight and water-tight. No boot needs to be added.

  - For 9001K chromium plated metal bezel: IP 66 according to IEC 61140 and NEMA type 1, 2, 3, 3R, 4, 12 and 13
  - For 9001SK plastic bezel: IP 66 according to IEC 61140 and NEMA type 1, 2, 3, 3R, 4, 4X, 12 et 13.
- International standards:
  - EN/IEC 60204/1 et EN/ISO 13850 for Emergency stop mushroom head pushbuttons (if used with the Emergency stop legend plates)
- Product certifications:
  - International certifications: UL, CSA, NOM, RoHS, GOST

# Acquire the information

Control units Ø 30

Harmony 9001K & SK range

Emergency stop pushbuttons, contact blocks, and circular yellow legends



9001KR16H13



9001SKR16H13

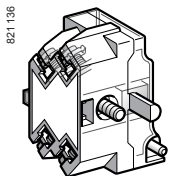

9001KA1

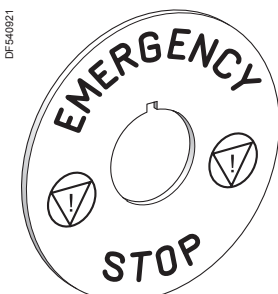

9001 KN8330

## Emergency stop mushroom head pushbutton (with chromium plated metal bezel)

Shape of head	Type of push	Head color & material	Type of contacts			Reference	Weight kg/lb
			N/O	N/C	C/O		
Circular, Ø 40 mm 1.575 in.	2 positions (1) Turn to Release plastic Trigger action	Red, Turn to Release plastic	1	1	–	9001KR16H13	0.141/0.311
			2	2	–	9001KR16H2	0.141/0.311
			–	–	–	9001KR16 (2)	0.141/0.311

## Emergency stop mushroom head pushbutton (with double insulated bezel)

Circular, Ø 40 mm 1.575 in.	2 positions Turn to release Trigger action (1)	1	1	–	9001SKR16H13	0.141/0.311
		2	2	–	9001SKR16H2	0.141/0.311
		–	–	–	9001SKR16 (2)	0.141/0.311

## Contact blocks with protected terminals

Description	Type of contacts			Reference	Weight kg/lb
	N/O	N/C	C/O		
Standard contact blocks	–	–	1	9001KA1 (3)	0.027/0.060
	1	–	–	9001KA2 (3)	0.023/0.051
	–	1	–	9001KA3 (3)	0.023/0.051
Late break contact blocks	–	–	1	9001KA4	0.027/0.060
	–	1	–	9001KA5	0.023/0.051
Early break contact blocks	1	–	–	9001KA6	0.023/0.051
Logic reed contact blocks Hermetically sealed	1	–	–	9001KA41 (3)	0.045/0.099
	–	1	–	9001KA42 (3)	0.045/0.099
	–	–	1	9001KA43 (3)	0.045/0.099
Power reed contact blocks Hermetically sealed	1	–	1	9001KA51 (3)	0.045/0.099
	–	1	–	9001KA52 (3)	0.045/0.099
	–	–	1	9001KA53 (3)	0.045/0.099

## Emergency stop legend plate (plastic)

Description	Legend plate colour	Marking	Reference	Weight kg/lb
Ø 60 mm 2.362 in.	Yellow	EMERGENCY STOP	9001KN9330	0.005/0.011
Ø 90 mm 3.543 in.	Yellow	EMERGENCY STOP	9001KN8330	0.005/0.011

(1) Emergency stop device, conforms to EN/IEC 60204-1 and EN/ISO 13850 when used with Emergency Stop legend plate 9001KN8330 or 9001KN9330.

(2) Supplied without contact block. Contact blocks to be ordered separately.

(3) It is possible to mount up to 3 levels of contact blocks (maximum of 6 contacts blocks) on 9001 K and 9001 SK references. For additional contact blocks to be installed by the customer, please refer to our site [www.schneider-electric.com](http://www.schneider-electric.com).

# Aquire the information

Operator dialogue terminals  
 Magelis™ XBTGH Advanced hand-held panel  
 Emergency stop function



Magelis XBTGH with emergency stop

3

## Presentation

The Magelis XBTGH Advanced hand-held panel offers a portable touch screen terminal with 5.7" color screen and a safety device: Emergency stop.

The emergency stop button with 2 NC safety contacts and 1 NO auxiliary contact is used to stop the machine during emergency.

## Operation

These terminals are available in multifunction levels (5.7" ) which features new information and communication technologies:

- High level of communication (embedded Ethernet, multi-link, Web server and FTP)
- External storage of data (Compact Flash memory card and USB memory stick) for storing production data and backing up applications
- Multimedia data with integrated image and sound management (digital or analog camera)
- Management of peripherals: Printers, bar code readers, loudspeakers, etc.

## Communication

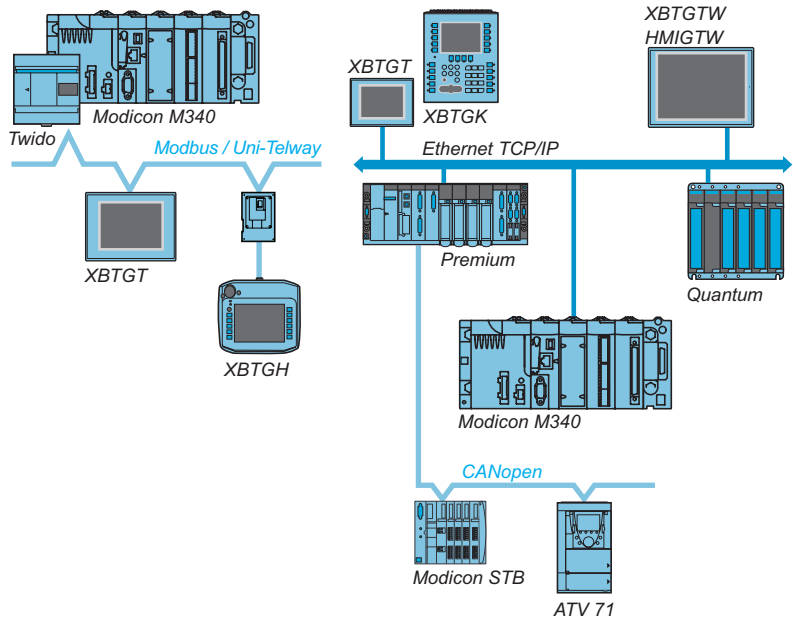

Magelis Standard Advanced panel communicate with PLCs via one or two integrated serial links, using communication protocols:

- Schneider Electric (Uni-TE, Modbus)
- Third-party: Mitsubishi Electric, Omron, Allen-Bradley and Siemens

# Acquire the information

## Operator dialogue terminals

### Magelis™ XBTGH Advanced hand-held panel

#### Emergency stop function



XBTGH2460



XBTZGJBOX



XBTZGHL●●

### XBTGH Advanced hand-held panel (1)

Type of front panel	Number of ports	Application memory capacity	Compact Flash memory	Video input	Number of Ethernet ports	Reference	Weight kg/lb
<b>Multifunction, 5.7" screen</b>							
TFT color mode screen and Emergency stop button	1 COM1 1 USB	32 MB	Yes	No	1	XBTGH2460 (2)	–

### Connection components

Description	Usage	Length m/ft.	Reference	Weight kg/lb
Junction box for XBTGH	Specifically for the XBTGH terminal, it enables: <ul style="list-style-type: none"> <li>■ 24 V <math>\overline{\text{DC}}</math> power supply to XBTGH terminal</li> <li>■ Connection of various safety inputs/outputs</li> <li>■ Connection on multi-protocol serial link (9-way SUB-D) or Ethernet TCP/IP (RJ45)</li> </ul> Can be mounted on 35 mm $\overline{\text{DIN}}$ rail	–	XBTZGJBOX (2) (3)	–
Interface cable for XBTGH	For connecting XBTGH terminal to junction box XBTZGJBOX	3/9.84	XBTZGHL3	–
		5/16.40	XBTZGHL5	–
		10/32.80	XBTZGHL10	–
		20/65.62	XBTZGHL20 (4)	–

(1) For more information on Magelis XBTGH functions, description and connection accessories, please refer to Magelis XBTGH Advanced hand-held panel catalog in our website [www.schneider-electric.com](http://www.schneider-electric.com).

(2) The XBTGH terminal is connected to junction box XBTZGJBOX using cable XBTZGHL●●, to be ordered separately.

(3) A junction box is required at each XBTGH terminal connection point.

(4) With this cable, the following limitations apply to the junction box:

- no RS 232C serial link
- an isolation box cannot be used
- 24 V  $\overline{\text{DC}}$  supply voltage tolerance of approximately 10%

# Aquire the information

## Control units for safety applications

**Applications**

**Control stations for:**  
 - assembly and packaging machines,  
 - paper, cardboard and woodworking machines,  
 - food/beverage processing, chemical and automobile industries, mechanical presses

**Wireless remote control system Harmony eXlhoist for hoisting applications**  
 - industrial cranes,  
 - Construction cranes: tower cranes and self erecting cranes crane operator control



<b>Features</b>		
<b>Conformity to standards</b>	EN/IEC 60947-1, EN/IEC 60947-5-1, EN/IEC 60947-5-4, EN/IEC 60947-5-5, EN/ISO 13850 and EN/IEC 60204-1 (Emergency Stop trigger action and mechanical latching mushroom head pushbuttons), IEC 60364-5-53 (Emergency switching off mechanical latching mushroom head pushbuttons) CSA C22-2 n° 14, UL 508 and GB 14048.5	In-built protection against unintended operation is compliant with SIL1, PL c Wireless emergency stop is certified SIL3, PL e  Product certifications - for base station: UL/CSA, CE, EAC - for wireless control device: UL/CSA, CE, EAC  Radio agreement: ANATEL, SRRC, FCC, RSS, ICASA, ARIB
<b>Protective treatment</b>	Standard version, "TH"	-
<b>Ambient temperature</b>	For operation For storage	-25...+70 °C -20...+60 °C -40...+70 °C -20...45 °C
<b>Electric shock protection conforming to IEC 61140</b>	Class II	100 gn conforming to IEC 60068-2-27
<b>Degree of protection conforming to IEC 60529, UL 508 and CSA C22-2 n° 14</b>	IP 66 Enclosure type 4, 4X and 13	IP 65 for base station IP 65 and NEMA 4 for wireless control device
<b>Positive operation</b>	N/C contacts with positive opening operation $\ominus$ conf. to EN/IEC 60947-5-1 Appendix K	2 configurable auxiliary push-button 6 configurable motion push-button
<b>Rated insulation voltage</b>	Standard single and double blocks with screw clamp terminals: Ui = 600 V, degree of pollution 3 Blocks for plug-in connector or Faston connectors, standard blocks for printed circuit board connection, contact blocks for high power switching: Ui = 250 V, degree of pollution 3 conforming to EN/IEC 60947-1	-
<b>Rated impulse withstand voltage conforming to EN/IEC 60947-1</b>	Standard single and double blocks with screw clamp terminals: Uimp = 6 kV Blocks for plug-in connector: Uimp = 4 kV Standard blocks for printed circuit board connection: Uimp = 4 kV Contact blocks for high power switching: Uimp = 4 kV	-
<b>Type references</b>	<b>XALK</b>	<b>XAR</b>
<b>Pages</b>	3/34	3/56

**Enabling grip switch for:**  
 - robots,  
 - machine tools,  
 - labellers

**Ergonomic two-hand control stations for machine tool control**



<b>Features</b>		
<b>Conformity to standards</b>	EN/IEC 60947-1, EN/IEC 60947-5-1, EN/IEC 60204-1, cUL us 508, CSA C22-2 n° 14	EN/IEC 60947-5-1, EN 574/ISO 13851
<b>Protective treatment</b>	Standard version, "TC"	Standard version, "TC"
<b>Ambient temperature</b>	For operation For storage	-10...+60 °C -25...+70 °C -40...+70 °C -40...+70 °C
<b>Electric shock protection conforming to IEC 61140</b>	Class II	Class I
<b>Degree of protection conforming to IEC 60529, UL 508 and CSA C22-2 n° 14</b>	IP 66 IP 65 with pushbutton	IP 65
<b>Positive operation</b>	2-contact, 3-position with positive opening operation $\ominus$ conf. to EN/IEC 60947-5-1 Appendix K	N/C contacts with positive opening operation $\ominus$ conf. to EN/IEC 60947-5-1 Appendix K
<b>Rated insulation voltage</b>	Ui = 250 V Ui = 125 V for pushbutton conforming to EN/IEC 60947-1	Ui = 600 V, degree of pollution 3 conforming to EN/IEC 60947-1
<b>Rated impulse withstand voltage conforming to EN/IEC 60947-1</b>	Uimp = 2.5 kV	Uimp = 6 kV
<b>Type references</b>	<b>XY2AU</b>	<b>XY2SB</b>
<b>Pages</b>	3/60	3/62

# Acquire the information



## Control stations and enclosures

### Plastic control stations XALD and XALK

For Harmony® XB5 control and signaling units Ø 22  
Complete stations (screw clamp terminal connections)

#### Start or Stop function

■ Light grey "RAL 7035" base, dark grey "RAL 7016" lid

Description	Type of push	Dimensions (1) w x h x d mm	Type of contact		Marking	Reference	Weight kg				
											
<b>Marking on pushbutton</b>											
1 spring return pushbutton	Flush, green	68 x 68 x 62	1	-	I	<b>XALD102 (2)</b>	0.135				
					Marche	<b>XALD104 (2)</b>	0.156				
					Start	<b>XALD103 (2)</b>	0.156				
			1	1	I	<b>XALD102E</b>	0.165				
					Flush, red	68 x 68 x 62	-	1	O	<b>XALD112</b>	0.156
									Arrêt	<b>XALD117</b>	0.156
			1	1	O	<b>XALD112E</b>	0.165				
					Projecting, red	68 x 68 x 66.5	-	1	O	<b>XALD115 (2)</b>	0.157
									Arrêt	<b>XALD118</b>	0.157
			1	1	Stop	<b>XALD114E</b>	0.165				
					Stop	<b>XALD114 (2)</b>	0.165				
<b>Marking on legend holder and legend below head</b>											
1 spring return pushbutton	Flush, green	68 x 68 x 62	1	-	Marche	<b>XALD101 (2)</b>	0.157				
					Start	<b>XALD101H29 (2)</b>	0.157				
	Flush, red	68 x 68 x 62	-	1	Arrêt	<b>XALD111</b>	0.157				
					Stop	<b>XALD111H29 (2)</b>	0.157				
1 mushroom head pushbutton, Ø 40 mm, spring return	Red	68 x 68 x 86	-	1	Arrêt	<b>XALD164 (2)</b>	0.182				
					Stop	<b>XALD164H29H7</b>	0.182				

(1) Please see our website [www.schneider-electric.com](http://www.schneider-electric.com) for more precised information about dimensions of components.

(2) Please add H7 for UL/CSA conformity, example: XALK102H7.



XALD102



XALD115



XALD101



XALD111



XALD164

# Acquire the information

## Control stations and enclosures

### Plastic control stations XALD and XALK

For Harmony® XB5 control and signaling units Ø 22  
Complete stations (screw clamp terminal connections)

Emergency stop function: Mushroom head Emergency stop trigger action and mechanical latching pushbuttons conform to standards EN/IEC 60204-1 and EN/ISO 13850, to Machinery Directive 2006/42/EC and to standard EN/IEC 60947-5-5.

Emergency switching off function: Mushroom head switching off mechanical latching pushbuttons conform to standards IEC 60364-5-53 and EN/IEC 60947-5-5.

Please consult our Customer Care Centre for a full explanation of these standards and directives.

#### Emergency stop and Emergency switching off functions with trigger action and mechanical latching

■ Light grey "RAL 7035" base, yellow "RAL 1021" lid

■ Conformity to standards EN/IEC 60204-1, EN/ISO 13850 (1), EN/IEC 60947-5-5 and to Machinery directive 2006/42/CE (2)

Description	Dimensions (3) w x h x d mm	Type of contact		Marking	Reference	Weight kg
						
<b>Unmarked</b>						
1 mushroom head pushbutton, Ø 40 mm, red Turn to release	68 x 68 x 92.5	–	1	–	XALK178 (4)	0.194
		–	2	–	XALK178F (4)	0.194
		1	1	–	XALK178E (4)	0.194
		1	2	–	XALK178G (4)	0.194
1 mushroom head pushbutton, Ø 40 mm, red Key release (key n° 455)	68 x 68 x 114.5	–	1	–	XALK188 (4)	0.188
		–	2	–	XALK188F	0.188
		1	1	–	XALK188E (4)	0.188
		1	2	–	XALK188G	0.188
1 mushroom head pushbutton, Ø 40 mm, red Push-pull	68 x 68 x 91.5	–	1	–	XALK198 (4)	0.193
<b>Marked</b>						
1 mushroom head pushbutton, Ø 40 mm, red Turn to release	68 x 68 x 92.5	–	1	NODSTOP	XALK178H26	0.194
		–	1	EMERGENCY STOP	XALK178H29 (4)	0.194
		–	1	NOT HALT	XALK178H44	0.194
		–	1	NODSTOPP	XALK178H49	0.194
		–	2	NODSTOP	XALK178FH26	0.194
		–	2	EMERGENCY STOP	XALK178FH29	0.194
		–	2	NOT HALT	XALK178FH44	0.194
		–	2	NODSTOPP	XALK178FH49	0.194
		1	2	NODSTOP	XALK178GTH26 (5)	0.197
		1	2	EMERGENCY STOP	XALK178GTH29 (5)	0.197
		1	2	NOT HALT	XALK178GTH44 (5)	0.197
		–	2	NODSTOP	XALK188GTH26 (5)	0.188

(1) Our Customer Care Centre may provide a control station type XALK188 with marking of the Emergency stop function and of the logo in conformity with the requests of EN/ISO 13850 standard, paragraph 4.4.6.

(2) Please consult our Customer Care Centre for full details of these standards and directives.

(3) Please see our website [www.schneider-electric.com](http://www.schneider-electric.com) for more precised information about dimensions of components.

(4) Please add H7 for UL/CSA conformity, example: XALK178H7.

(5) T for direct head mounting on cover with ZB5AZ009 fixing base.



XALK178●



XALK188●



XALK198

# Acquire the information

## Control stations and enclosures

### Plastic control stations XALD and XALK

For Harmony® XB5 control and signaling units Ø 22  
Complete stations (screw clamp terminal connections)

#### Start-Stop function

■ Light grey "RAL 7035" base, yellow "RAL 1021" lid

Description	Dimensions (3) w x h x d mm	Type of contact		Marking	Reference	Weight kg
		N/O	N/C			

#### Marking on pushbutton (2)

2 spring return pushbuttons: - 1 flush, green - 1 flush, red	68 x 106 x 62	1	–	I	XALD213 (3)	0.233
		–	1	O		
2 spring return pushbuttons: - 1 flush, green - 1 projecting, red	68 x 106 x 66.5	1	–	Marche	XALD224 (3)	0.233
		–	1	Arrêt		
2 spring return pushbuttons: - 1 flush, green - 1 projecting, red	68 x 106 x 66.5	1	–	Start	XALD215 (3)	0.233
		–	1	Stop		
2 spring return pushbuttons: - 1 flush, green - 1 projecting, red	68 x 106 x 66.5	1	1	I	XALD213E	0.252
		–	1	O		

#### Marking on legend holder and legend below head

2 spring return pushbuttons: - 1 flush, green - 1 projecting, red	68 x 106 x 62	1	–	Marche	XALD211 (3)	0.233
		–	1	Arrêt		
2 spring return pushbuttons: - 1 flush, green - 1 projecting, red	68 x 106 x 62	1	–	Start	XALD211H29 (3)	0.233
		–	1	Stop		
2 spring return pushbuttons, flush type, green	68 x 106 x 62	1	–	Ouverture	XALD241	0.233
		1	–	Fermeture		
1 selector switch with standard handle 2-position stay put	68 x 106 x 80	1	–	O-I	XALD134 (3)	0.163
		1	–	Arrêt-Marche		
1 key switch (key n° 455), key withdrawal from left-hand position	68 x 106 x 105.5	1	–	Start	XALD133H7	0.163
		1	–	Stop		
1 key switch (key n° 455), key withdrawal from left-hand position	68 x 106 x 105.5	1	–	O-I	XALD144 (3)	0.187
		1	–	Arrêt-Marche		
1 key switch (key n° 455), key withdrawal from left-hand position	68 x 106 x 105.5	1	1	O-I	XALD144E (3)	0.196
		1	1	O-I		

Description	Dimensions (3) w x h x d mm	Type of contact		Marking	Pilot light supply V	Reference	Weight kg
		N/O	N/C				

#### With pilot light and marking on pushbutton (2)

2 spring return pushbuttons and 1 pilot light with integral red LED	68 x 136 x 64.5	1	–	I	≈ 24	XALD363B	0.261
		–	1	O	≈ 120		
		–	1	O	≈ 230		

#### With pilot light and marking on legend holder and legend below head

2 spring return pushbuttons and 1 pilot light with integral red LED	68 x 136 x 64.5	1	–	Marche	≈ 24	XALD361B	0.261
		–	1	Arrêt	≈ 230		

(1) Please see our website [www.schneider-electric.com](http://www.schneider-electric.com) for more precised information about dimensions of components.

(2) Push supplied with cap not clipped-in, allowing orientation through 90° in 360° steps.

(3) Please add H7 for UL/CSA conformity, example: XALD213H7.

3



XALD224



XALD211H29



XALD134



XALD144



XALD363B



# Acquire the information



## Control stations and enclosures

### Plastic control stations XALD and XALK

For Harmony® XB5 control and signaling units Ø 22  
Complete stations (screw clamp terminal connections)

#### Two function

■ Light grey "RAL 7035" base, yellow "RAL 1021" lid



Description	Dimensions (1) w x h x d mm	Type of contact		Marking	Reference	Weight kg
						
<b>Marking on pushbutton (2)</b>						
<b>2 spring return pushbuttons:</b>						
- 1 flush, white	68 x 106 x 62	1	–	↑	XALD222 (4)	0.233
- 1 flush, black		1	–	↓		
				→	XALD223	0.233
				↔		
		1	1	↑	XALD222E	0.233
		1	1	↓		



XALD222

#### Three function

■ Light grey "RAL 7035" base, yellow "RAL 1021" lid

Description	Dimensions (1) w x h x d mm	Type of contact		Marking	Reference	Weight kg
						
<b>Marking on pushbutton (2)</b>						
<b>3 spring return pushbuttons:</b>						
- 1 flush, green	68 x 136 x 62	1	–	I	XALD339 (4)	0.298
- 1 flush, red		–	1	O		
- 1 flush, green		1	–	II		
<b>3 spring return pushbuttons:</b>						
- 1 flush, white	68 x 136 x 62	1	–	↑	XALD324 (4)	0.298
- 1 flush, red		–	1	O		
- 1 flush, black		1	–	↓		
				↑	XALD326 (4)	0.298
				Stop		
				↓		
				→	XALD334 (4)	0.298
				O		
				↔		
		1	1	↑	XALD324E	0.317
		1	1	O		
		1	1	↓		
<b>3 spring return pushbuttons:</b>						
- 1 flush, white	68 x 136 x 62	1	–	↑	XALD325	0.299
- 1 projecting, red		–	1	O		
- 1 flush, black		1	–	↓		
<b>2 spring return + 1 mushroom head pushbuttons:</b>						
- 1 flush, white	68 x 136 x 87.5	1	–	↑	XALD328 (4)	0.317
- 1 mushroom head, red (3)		–	1	O		
- 1 flush, black		1	–	↓		
<b>Marking on legend holder and legend below head</b>						
<b>3 spring return pushbuttons:</b>						
- 1 flush, green	68 x 136 x 62	1	–	Avant	XALD311 (4)	0.299
- 1 flush, red		–	1	Arrêt		
- 1 flush, green		1	–	Arrière		
				FORWARD	XALD311H29H7	0.299
				STOP		
				REVERSE		
				Montée	XALD321	0.299
				Arrêt		
				Descente		
				UP	XALD321H29H7	0.299
				STOP		
				DOWN		



XALD339



XALD334



XALD321

(1) Please see our website [www.schneider-electric.com](http://www.schneider-electric.com) for more precised information about dimensions of components.

(2) Push supplied with cap not clipped-in, allowing orientation through 90° in 360° steps.

(3) Standard turn to release, latching, Ø 30 mm.

(4) Please add H7 for UL/CSA conformity, example: XALD22H7.

# Acquire the information

## Control stations and enclosures

### Plastic control stations XALD and XALK

For Harmony® XB5 control and signaling units Ø 22 Stations for customer assembly: empty enclosures









XALD02

3



XALK01H29

Empty control stations (lid fixing screws and nut material: stainless steel type A4, AISI 316)					
Description	Text and logo	Dimensions (1) w x h x d mm	Number of cut-outs	Reference	Weight kg
Light grey "RAL 7035" base Dark grey "RAL 7016" lid	Without	68 x 68 x 53	1	XALD01	0.136
		68 x 106 x 53	2	XALD02	0.193
		68 x 136 x 53	3	XALD03	0.238
		68 x 166 x 53	4	XALD04	0.278
		68 x 196 x 53	5	XALD05	0.322
Light grey "RAL 7035" base Yellow "RAL 1021" lid For Emergency stop function	Without	68 x 68 x 53	1	XALK01 (5)	0.136
		68 x 106 x 53	2	XALK02	0.193
		68 x 136 x 53	3	XALK03 (5)	0.238
		68 x 166 x 53	4	XALK04	0.278
		68 x 196 x 53	5	XALK05	0.322
	With text «ARRET D'URGENCE» (2) and logo (3) 	68 x 68 x 53	1	XALK01HFR	0.136
	With text «EMERGENCY STOP» (2) and logo (3) 	68 x 68 x 53	1	XALK01H29	0.136
	With text «NOT HALT» (2) and logo (3) 	68 x 68 x 53	1	XALK01H44	0.136
	Without	68 x 68 x 53	1	XALK01T (6)	0.136
	With text «ARRET D'URGENCE» (2) and logo (3) 	68 x 68 x 53	1	XALK01THFR (6)	0.136
	With text «NODSTOP» (2) and logo (3) 	68 x 68 x 53	1	XALK01TH26 (6)	0.136
	With text «EMERGENCY STOP» (2) and logo (3) 	68 x 68 x 53	1	XALK01TH29 (6)	0.136
<b>CSA + UL certified (4)</b>					
Light grey "RAL 7035" base Dark grey "RAL 7016" lid	Without	68 x 68 x 53	1	XALD01H7	0.136
		68 x 106 x 53	2	XALD02H7	0.205
		68 x 136 x 53	3	XALD03H7	0.238
		68 x 136 x 53	3	XALD04H7	0.238
		68 x 136 x 53	3	XALD05H7	0.238

(1) Please see our website [www.schneider-electric.com](http://www.schneider-electric.com) for more precised information about dimensions of components.

(2) For supply of the text in an other language, please consult our Customer Care Centre.

(3) For complying with ISO 13850 standard, paragraph 4.4.6., Emergency Stop function logo  has been added.

(4) Volt-free commoning/earth terminal included.

(5) Please add H7 for UL/CSA conformity, example: XALD01H7.

(6) T for direct head mounting on cover with ZB5AZ009 fixing base.

# Acquire the information

## Control stations and enclosures

### Plastic control stations XALD and XALK

For Harmony® XB5 control and signaling units Ø 22  
Stations for customer assembly: electrical blocks

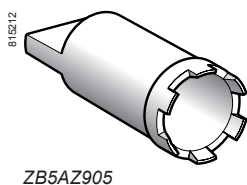

#### Electrical blocks and accessories for mounting in back of enclosure

Description	Description	Color	Sold in lots of	Unit reference	Weight kg
<b>Electrical blocks with screw clamp terminal connections</b>					
Standard contact blocks (1)	N/O contact	–	5	ZENL1111	0.015
	N/C contact	–	5	ZENL1121	0.015
Light blocks with integral LED (1)	≈ 24 V	White	5	ZALVB1	0.015
		Green	5	ZALVB3	0.015
		Red	5	ZALVB4	0.015
		Yellow	5	ZALVB5	0.015
		Blue	5	ZALVB6	0.015
		~ 110...120 V	White	5	ZALVG1
	Green	5	ZALVG3	0.015	
	Red	5	ZALVG4	0.015	
	Yellow	5	ZALVG5	0.015	
	Blue	5	ZALVG6	0.015	
	~ 230...240 V	White	5	ZALVM1	0.015
		Green	5	ZALVM3	0.015
		Red	5	ZALVM4	0.015
		Yellow	5	ZALVM5	0.015
		Blue	5	ZALVM6	0.015

Description	For use with	Sold in lots of	Unit reference	Weight kg
<b>Accessories for electrical blocks</b>				
Blanking plug	Ø 22 mm units	10	ZB5SZ3	0.008
Nut	Head fixing	10	ZB5AZ901	0.002
Volt-free terminal	Commoning/earth	10	XALZ09	0.003
Bezel tool	For tightening nut ZB5AZ901	1	ZB5AZ905	0.016

#### Electrical blocks and accessories for mounting beneath heads

Description	Description	Color	Sold in lots of	Unit reference	Weight kg
<b>Electrical blocks with screw clamp terminal connections (2) (for use with body/fixing collar ZB5AZ009)</b>					
Standard contact blocks	N/O contact	–	5	ZBE101	0.016
	N/C contact	–	5	ZBE102	0.016
Light blocks with integral LED	≈ 24 V	White	5	ZBVB1	0.016
		Green	5	ZBVB3	0.016
		Red	5	ZBVB4	0.016
		Yellow	5	ZBVB5	0.016
		Blue	5	ZBVB6	0.016
		~ 110...120 V	White	5	ZBVG1
	Green	5	ZBVG3	0.016	
	Red	5	ZBVG4	0.016	
	Yellow	5	ZBVG5	0.016	
	Blue	5	ZBVG6	0.016	
	~ 230...240 V	White	5	ZBVM1	0.016
		Green	5	ZBVM3	0.016
		Red	5	ZBVM4	0.016
		Yellow	5	ZBVM5	0.016
		Blue	5	ZBVM6	0.016

Description	For use with	Voltage	Level of protection	Unit reference	Weight kg
<b>Accessories for electrical blocks</b>					
LED suppressors for high powers (≥ 30 VA)	Electrical light blocks with integral LED	~ 120 V	25...120 VA	ZBZVG	0.010
		~ 230 V	30...230 VA	ZBZVM	0.010
Body/fixing collar Sold in lots of 10	Electrical blocks (contact or light)	–	–	ZB5AZ009	0.006

(1) A maximum of 3 electrical blocks can be fitted per associated head.

(2) For electrical blocks for printed circuit board connection: please consult our Customer Care Centre.





# Acquire the information

## Control stations and enclosures

### Plastic control stations XALD and XALK

For Harmony® XB5 control and signaling units Ø 22  
Stations for customer assembly: heads

#### Heads for spring return pushbuttons - unmarked

Shape of head	Type of push	Color of cap	Reference	Weight kg
	Without cap (1)	–	ZB5AA0	0.022
	Flush, with set of 6 colored caps	6 colors (2)	ZB5AA9	0.027
	Flush	White	ZB5AA1	0.018
		Black	ZB5AA2	0.018
		Green	ZB5AA3	0.018
		Red	ZB5AA4	0.018
		Yellow	ZB5AA5	0.018
		Blue	ZB5AA6	0.018
	Grey	ZB5AA8	0.018	
	Flush with transparent cap, for insertion of legend (3)	White	ZB5AA18	0.018
		Green	ZB5AA38	0.018
		Red	ZB5AA48	0.018
		Yellow	ZB5AA58	0.018
		Blue	ZB5AA68	0.018
	Booted (colored silicone) Can be replaced without dismantling the head	White	ZB5AP1S	0.014
		Black	ZB5AP2S	0.014
		Green	ZB5AP3S	0.014
		Red	ZB5AP4S	0.014
		Yellow	ZB5AP5S	0.014
		Blue	ZB5AP6S	0.014
	Projecting	White	ZB5AL1	0.019
		Black	ZB5AL2	0.019
		Green	ZB5AL3	0.019
		Red	ZB5AL4	0.019
		Yellow	ZB5AL5	0.019
		Blue	ZB5AL6	0.019
	Flush (high guard)	White	ZB5AA14	0.020
		Black	ZB5AA24	0.020
		Green	ZB5AA34	0.020
		Red	ZB5AA44	0.020
		Yellow	ZB5AA54	0.020
		Blue	ZB5AA64	0.020
	Recessed (high guard)	White	ZB5AA16	0.019
		Black	ZB5AA26	0.019
		Green	ZB5AA36	0.019
		Red	ZB5AA46	0.019
		Yellow	ZB5AA56	0.019
		Blue	ZB5AA66	0.019
	Flush	White	ZB5CA1	0.019
		Black	ZB5CA2	0.019
		Green	ZB5CA3	0.019
		Red	ZB5CA4	0.019
		Yellow	ZB5CA5	0.019
		Blue	ZB5CA6	0.019
	Projecting	White	ZB5CL1	0.021
		Black	ZB5CL2	0.021
		Green	ZB5CL3	0.021
		Red	ZB5CL4	0.021
		Yellow	ZB5CL5	0.021
		Blue	ZB5CL6	0.021

(1) Cap to be ordered separately, see page 3/53.

(2) Head supplied with 6 different colored caps (white, black, green, red, yellow, blue).

(3) For legend ordering information, see page 3/52.



# Acquire the information

Control stations and enclosures

Plastic control stations XALD and XALK

For Harmony® XB5 control and signaling units Ø 22

Stations for customer assembly: heads



ZB5AA331



ZB5AA432



ZB5AL232



ZB5AC24



ZB5AC2

## Heads for spring return pushbuttons - marked

Shape of head	Type of push	Marking	Color	Color of cap	Reference	Weight kg		
	Flush (1)	I	White	Green	ZB5AA331	0.018		
			Black	White	ZB5AA131	0.018		
		II	White	Green	ZB5AA336	0.018		
			Black	White	ZB5AA136	0.018		
		START	White	Green	ZB5AA333	0.018		
			Black	White	ZB5AA133	0.018		
		ON	White	Green	ZB5AA341	0.018		
			Black	White	ZB5AA141	0.018		
		MARCHE	White	Green	ZB5AA342	0.018		
			Black	White	ZB5AA142	0.018		
				O	White	Black	ZB5AA245	0.018
					Black	White	ZB5AA145	0.018
		ARRET	White		White	Red	ZB5AA432	0.018
					Black	Black	ZB5AA232	0.018
		ARRET	White		White	Red	ZB5AA433	0.018
					Black	Black	ZB5AA233	0.018
		STOP	White		White	Red	ZB5AA434	0.018
					Black	Black	ZB5AA234	0.018
		OFF	White		White	Red	ZB5AA435	0.018
					Black	Black	ZB5AA235	0.018
UP	Black		White	White	ZB5AA343	0.018		
			Black	Black	ZB5AA344	0.018		
DOWN	White		White	Black	ZB5AA335	0.018		
			Black	White	ZB5AA334	0.018		
	Projecting (1)	O	White	Red	ZB5AL432	0.019		
			Black	Black	ZB5AL232	0.019		
		ARRET	White	White	Red	ZB5AL433	0.019	
				Black	Black	ZB5AL233	0.019	
		STOP	White	White	Red	ZB5AL434	0.019	
				Black	Black	ZB5AL234	0.019	
		OFF	White	White	Red	ZB5AL435	0.019	
				Black	Black	ZB5AL235	0.019	
			Flush (1)	I	White	Green	ZB5CA331	0.019
					White	Red	ZB5CA432	0.019
				+	White	Black	ZB5CA2934	0.019
					White	Black	ZB5CA2912	0.019
R	White			Blue	ZB5CA6939	0.019		

## Mushroom heads for spring return pushbuttons

Shape of head	Diameter of push mm	Color of push	Reference	Weight kg
	30	Black	ZB5AC24	0.027
		Green	ZB5AC34	0.027
		Red	ZB5AC44	0.027
		Yellow	ZB5AC54	0.027
		Blue	ZB5AC64	0.027
	40	Black	ZB5AC2	0.046
		Green	ZB5AC3	0.046
		Red	ZB5AC4	0.046
		Yellow	ZB5AC5	0.046
		Blue	ZB5AC6	0.046

(1) Push supplied with cap not clipped-in, allowing orientation through 90° in 360° steps.

# Aquire the information

## Control stations and enclosures

### Plastic control stations XALD and XALK





For Harmony® XB5 control and signaling units Ø 22  
Stations for customer assembly: heads

Emergency stop function: Mushroom head Emergency stop trigger action and mechanical latching pushbuttons conform to standards EN/IEC 60204-1 and EN/ISO 13850, to Machinery Directive 2006/42/EC and to standard EN/IEC 60947-5-5.

Emergency switching off function: Mushroom head switching off mechanical latching pushbuttons conform to standards IEC 60364-5-53 and EN/IEC 60947-5-5.

Please consult our Customer Care Centre for a full explanation of these standards and directives.

#### Emergency stop and switching off pushbuttons with trigger action and mechanical latching

Shape of head	Type of push	Diameter of push mm	Color of push	Reference	Weight kg
	Trigger action Push-pull	30	Red	<b>ZB5AT844</b> (1)	0.050
		40	Red	<b>ZB5AT84</b> (1)	0.050
	Trigger action Turn to release	30	Red	<b>ZB5AS834</b> (1)	0.042
		40	Red	<b>ZB5AS844</b> (1)	0.046
	Trigger action Key release (key n° 4A185)	30	Red	<b>ZB5AS934</b> (1) (3)	0.068
		40	Red	<b>ZB5AS944</b> (1)	0.071
		60	Red	<b>ZB5AS964</b> (1)	0.092
	Trigger action Key release (key n° 4A185)	40	Red	<b>ZB5AS944D</b> (1)	0.071

815243





ZB5AS844

815246



ZB5AS934

#### Emergency switching off, mechanical latching pushbuttons

Shape of head	Type of push	Diameter of push mm	Color of push	Reference	Weight kg
	Push-pull	30	Black	<b>ZB5AT24</b> (2)	0.044
		40	Black	<b>ZB5AT2</b> (2)	0.049
	Turn to release	30	Black	<b>ZB5AS42</b> (2)	0.040
		40	Black	<b>ZB5AS52</b> (2)	0.044
			Yellow	<b>ZB5AS55</b> (2)	0.044
	Key release (key n° 4A185) (3)	30	Black	<b>ZB5AS72</b> (2)	0.040
		40	Black	<b>ZB5AS12</b> (2)	0.044

(1) Mushroom head Emergency stop trigger action and mechanical latching pushbuttons conform to standards EN/IEC 60204-1 and EN/ISO 13850, to Machinery Directive 2006/42/EC and to standard EN/IEC 60947-5-5.

(2) Mushroom head switching off mechanical latching pushbuttons conform to standards IEC 60364-5-53 and EN/IEC 60947-5-5. Please consult our Customer Care Centre for full details of these standards and directives.

(3) Other key numbers:

- key n° 421E: add suffix **12** to the reference.
- key n° 458A: add suffix **10** to the reference.
- key n° 520E: add suffix **14** to the reference.
- key n° 3131A: add suffix **20** to the reference.

Example: The reference for a Ø 40 mushroom head for a trigger action latching pushbutton with release by key n° 421E becomes: **ZB5AS94412**.

# Acquire the information

## Control stations and enclosures

### Plastic control stations XALD and XALK

For Harmony® XB5 control and signaling units Ø 22

Stations for customer assembly: heads



ZB5AD2

Heads for selector switches (1)					
Shape of head	Type of operator	Number and type of positions		Reference	Weight kg
	Standard handle, black	2 - stay put		ZB5AD2	0.017
		2 - spring return from right to left		ZB5AD4	0.020
		3 - stay put		ZB5AD3	0.017
		3 - spring return to centre		ZB5AD5	0.017
		3 - spring return from left to centre		ZB5AD7	0.017
		3 - spring return from right to centre		ZB5AD8	0.017
	Standard handle, white	2 - stay put		ZB5AD201	0.017
		2 - spring return from right to left		ZB5AD401	0.020
		3 - stay put		ZB5AD301	0.017
		3 - spring return to centre		ZB5AD501	0.017
		3 - spring return from left to centre		ZB5AD701	0.017
		3 - spring return from right to centre		ZB5AD801	0.017
	Standard handle, green	2 - stay put		ZB5AD203	0.017
		2 - spring return from right to left		ZB5AD403	0.020
		3 - stay put		ZB5AD303	0.017
		3 - spring return to centre		ZB5AD503	0.017
		3 - spring return from left to centre		ZB5AD703	0.017
		3 - spring return from right to centre		ZB5AD803	0.017

(1) Can only be used for actuation of end of row (side) mounted contacts.

# Aquire the information

## Control stations and enclosures

### Plastic control stations XALD and XALK

For Harmony® XB5 control and signaling units Ø 22  
Stations for customer assembly: heads



Heads for selector switches (1) (continued)				
Shape of head	Type of operator	Number and type of positions	Reference	Weight kg
	Standard handle, red	2 - stay put	ZB5AD204	0.017
		2 - spring return from right to left	ZB5AD404	0.020
		3 - stay put	ZB5AD304	0.017
		3 - spring return to centre	ZB5AD504	0.017
		3 - spring return from left to centre	ZB5AD704	0.017
		3 - spring return from right to centre	ZB5AD804	0.017
	Standard handle, yellow	2 - stay put	ZB5AD205	0.017
		2 - spring return from right to left	ZB5AD405	0.020
		3 - stay put	ZB5AD305	0.017
		3 - spring return to centre	ZB5AD505	0.017
		3 - spring return from left to centre	ZB5AD705	0.017
		3 - spring return from right to centre	ZB5AD805	0.017
	Standard handle, blue	2 - stay put	ZB5AD206	0.017
		2 - spring return from right to left	ZB5AD406	0.020
		3 - stay put	ZB5AD306	0.017
		3 - spring return to centre	ZB5AD506	0.017
		3 - spring return from left to centre	ZB5AD706	0.017
		3 - spring return from right to centre	ZB5AD806	0.017
	Long handle, black	2 - stay put	ZB5AJ2	0.017
		2 - spring return from right to left	ZB5AJ4	0.020
		3 - stay put	ZB5AJ3	0.017
		3 - spring return to centre	ZB5AJ5	0.017
		3 - spring return from left to centre	ZB5AJ7	0.017
		3 - spring return from right to centre	ZB5AJ8	0.017

(1) Can only be used for actuation of end of row (side) mounted contacts.





# Acquire the information

## Control stations and enclosures

### Plastic control stations XALD and XALK

For Harmony® XB5 control and signaling units Ø 22

Stations for customer assembly: heads

#### Heads for selector switches (1) (continued)



Knurled knob,  
black

Shape of head	Type of operator	Number and type of positions (2)	Reference	Weight kg
		2 - stay put	<b>ZB5AD29</b>	0.020
		2 - spring return from right to left	<b>ZB5AD49</b>	0.024
		3 - stay put	<b>ZB5AD39</b>	0.020
		3 - spring return to centre	<b>ZB5AD59</b>	0.020
		3 - spring return from left to centre	<b>ZB5AD79</b>	0.020
		3 - spring return from right to centre	<b>ZB5AD89</b>	0.020



Key switch with  
key n° 455 (3) (4)

		2 - stay put	<b>ZB5AG2</b>	0.057
			<b>ZB5AG02</b>	0.057
			<b>ZB5AG4</b>	0.057
		2 - spring return from right to left	<b>ZB5AG6</b>	0.061
		3 - stay put	<b>ZB5AG0</b>	0.057
			<b>ZB5AG3</b>	0.057
			<b>ZB5AG5</b>	0.057
			<b>ZB5AG9</b>	0.057
			<b>ZB5AG09</b>	0.057
		3 - spring return from left to centre	<b>ZB5AG1</b>	0.057
		3 - spring return to centre	<b>ZB5AG7</b>	0.057
		3 - spring return from right to centre	<b>ZB5AG8</b>	0.057
			<b>ZB5AG05</b>	0.057
			<b>ZB5AG08</b>	0.057



(1) Can only be used for actuation of end of row (side) mounted contacts.

(2) The symbol "K" indicates key withdrawal position(s).

(3) Other key numbers:

- key n° 421E: add suffix **12** to the reference,
- key n° 458A: add suffix **10** to the reference,
- key n° 520E: add suffix **14** to the reference,
- key n° 3131A: add suffix **20** to the reference.

Example:

For a key switch head with key n° 421E, 2-position stay put with key withdrawal from the left-hand position, the reference becomes: **ZB5AG212**.

(4) For specific keys with other numbers, please consult our Customer Care Centre.

# Acquire the information

## Control stations and enclosures

### Plastic control stations XALD and XALK

For Harmony® XB5 control and signaling units Ø 22  
Stations for customer assembly: heads



Heads for selector switches (1) (continued)					
Shape of head	Type of operator	Number and type of positions (2)		Reference	Weight kg
	Key switch with key n° 8D1	2 - stay put		ZB5AG2D	0.057
				ZB5AG02D	0.057
				ZB5AG4D	0.057
		2 - spring return from right to left		ZB5AG6D	0.061
		3 - stay put		ZB5AG0D	0.057
				ZB5AG3D	0.057
				ZB5AG5D	0.057
				ZB5AG9D	0.057
				ZB5AG09D	0.057
				ZB5AG03D	0.057
		3 - spring return from left to centre		ZB5AG04D	0.057
				ZB5AG06D	0.057
				ZB5AG1D	0.057
		3 - spring return from right to centre		ZB5AG07D	0.057
				ZB5AG8D	0.057
				ZB5AG08D	0.057
		3 - spring return to centre		ZB5AG05D	0.057
				ZB5AG7D	0.057



Heads for toggle switches						
Shape of head	Description	Lever	Type of position	Reference	Weight kg	
	2-position	Black	Stay put	ZB5AD28	0.023	
			Spring return	ZB5AD48	0.023	
			White	Stay put	ZB5AD2801	0.023
			Red	Stay put	ZB5AD2804	0.023
			Blue	Stay put	ZB5AD2806	0.023

(1) Can only be used for actuation of end of row (side) mounted contacts.  
(2) The symbol "D" indicates key withdrawal position(s).

# Acquire the information

## Control stations and enclosures

### Plastic control stations XALD and XALK

For Harmony® XB5 control and signaling units Ø 22  
Stations for customer assembly: heads



#### Heads for pilot lights

Shape of head	For use with body comprising light source type	Color of lens	Reference	Weight kg
<b>With plain lens</b>				
	With integral LED <b>Protected LED</b>	White	ZB5AV013	0.017
		Green	ZB5AV033	0.017
		Red	ZB5AV043	0.017
		Yellow	ZB5AV053	0.017
		Blue	ZB5AV063	0.017
	With integral LED <b>Protected LED</b>	White	ZB5CV013	0.020
		Green	ZB5CV033	0.020
		Red	ZB5CV043	0.020
		Yellow	ZB5CV053	0.020
		Blue	ZB5CV063	0.020
		5 colors (1)	ZB5CV003	0.028
<b>With plain lens, for insertion of legend (2)</b>				
	With integral LED <b>Protected LED</b>	White	ZB5AV013E	0.017
		Green	ZB5AV033E	0.017
		Red	ZB5AV043E	0.017
		Yellow	ZB5AV053E	0.017
		Blue	ZB5AV063E	0.017
<b>With grooved lens (3)</b>				
	With integral LED <b>Protected LED</b>	White	ZB5AV013S	0.017
		Green	ZB5AV033S	0.017
		Red	ZB5AV043S	0.017
		Yellow	ZB5AV053S	0.017
		Blue	ZB5AV063S	0.017



#### Heads for spring return illuminated pushbuttons

Shape of head	Type of push	Color	Reference	Weight kg
<b>Only for use with bodies comprising a light source with integral LED</b>				
	Flush, plain lens	White	ZB5AW313	0.017
		Green	ZB5AW333	0.017
		Red	ZB5AW343	0.017
		Yellow	ZB5AW353	0.017
		Blue	ZB5AW363	0.017
	Flush, grooved lens (3)	White	ZB5AW313S	0.016
		Green	ZB5AW333S	0.016
		Red	ZB5AW343S	0.016
		Yellow	ZB5AW353S	0.016
		Blue	ZB5AW363S	0.016
	Flush for insertion of legend (1)	White	ZB5AA18	0.018
		Green	ZB5AA38	0.018
		Red	ZB5AA48	0.018
		Yellow	ZB5AA58	0.018
		Blue	ZB5AA68	0.018
	Projecting	White	ZB5AW113	0.018
		Green	ZB5AW133	0.018
		Red	ZB5AW143	0.018
		Yellow	ZB5AW153	0.018
		Blue	ZB5AW163	0.018
	Flush for insertion of legend (1)	White	ZB5CW313	0.023
		Green	ZB5CW333	0.023
		Red	ZB5CW343	0.023
		Yellow	ZB5CW353	0.023
		Blue	ZB5CW363	0.023

**Other versions** Heads for flush pushbuttons with illuminated ring.  
Please consult our Customer Care Centre.

(1) Head supplied with 5 different colored lenses (white, green, red, yellow, blue) for insertion of legend. For legend ordering information: see page 3/52.

(2) For legend ordering information: see page 3/52.

(3) For use in bright ambient light conditions (for example, outdoors in sunlight).















# Acquire the information

## Control stations and enclosures



### Plastic control stations XALD and XALK

For Harmony® XB5 control and signaling units Ø 22  
Stations for customer assembly: heads

#### Heads for illuminated selector switches with standard handle

Shape of head	Number and type of positions	Color of handle	Reference	Weight kg
<b>Only for use with bodies comprising a light source with integral LED</b>				
 ZB5AK1263	 	White	<b>ZB5AK1213</b>	0.021
		Green	<b>ZB5AK1233</b>	0.021
		Red	<b>ZB5AK1243</b>	0.021
		Yellow	<b>ZB5AK1253</b>	0.021
		Blue	<b>ZB5AK1263</b>	0.021
 ZB5AK1463	 	White	<b>ZB5AK1413</b>	0.021
		Green	<b>ZB5AK1433</b>	0.021
		Red	<b>ZB5AK1443</b>	0.021
		Yellow	<b>ZB5AK1453</b>	0.021
		Blue	<b>ZB5AK1463</b>	0.021
	 	White	<b>ZB5AK1313</b>	0.021
		Green	<b>ZB5AK1333</b>	0.021
		Red	<b>ZB5AK1343</b>	0.021
		Yellow	<b>ZB5AK1353</b>	0.021
		Blue	<b>ZB5AK1363</b>	0.021
	 	White	<b>ZB5AK1513</b>	0.021
		Green	<b>ZB5AK1533</b>	0.021
		Red	<b>ZB5AK1543</b>	0.021
		Yellow	<b>ZB5AK1553</b>	0.021
		Blue	<b>ZB5AK1563</b>	0.021
	 	White	<b>ZB5AK1813</b>	0.021
		Green	<b>ZB5AK1833</b>	0.021
		Red	<b>ZB5AK1843</b>	0.021
		Yellow	<b>ZB5AK1853</b>	0.021
		Blue	<b>ZB5AK1863</b>	0.021
	 	White	<b>ZB5AK1713</b>	0.021
		Green	<b>ZB5AK1733</b>	0.021
		Red	<b>ZB5AK1743</b>	0.021
		Yellow	<b>ZB5AK1753</b>	0.021
		Blue	<b>ZB5AK1763</b>	0.021

#### Heads for Ø 40 illuminated, latching, mushroom head pushbuttons (1)

Shape of head	Type of push	Color of push	Reference	Weight kg
<b>Only for use with bodies comprising a light source with integral LED</b>				
 ZB5AW743	 	White	<b>ZB5AW713</b>	0.022
		Green	<b>ZB5AW733</b>	0.022
		Red	<b>ZB5AW743</b>	0.022
		Yellow	<b>ZB5AW753</b>	0.022
		Blue	<b>ZB5AW763</b>	0.022

(1) Use electrical blocks type ZBE10●, specifically designed for "mounting beneath heads", see page 3/39.

# Acquire the information

## Control stations and enclosures

### Plastic control stations XALD and XALK

For Harmony® XB5 control and signaling units Ø 22  
Stations for customer assembly: accessories

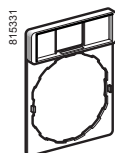

ZBZ32

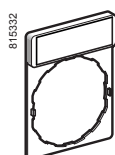

ZBY101

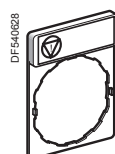

ZBY4140



ZBY2107

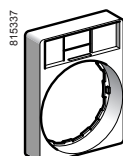

ZBZ34

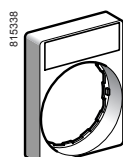

ZBYH101

#### Standard (30 x 40 mm) legend holders for 8 x 27 mm legends <sup>(1)</sup>

Description	Legend Color	Marking	Sold in lots of	Unit reference	Weight kg		
<b>Without legend</b>	–	–	10	ZBZ32	0.001		
<b>With blank legend</b> (for engraving)	Black or red background	–	10	ZBY2101	0.002		
	White or yellow background	–	10	ZBY4101	0.002		
<b>With 8 x 27 mm legend</b> (with international marking)	Black or red background	O (black background)	1	ZBY2146	0.002		
		O (red background)	1	ZBY2931	0.002		
		I	1	ZBY2147	0.002		
		II	1	ZBY2148	0.002		
		O-I	1	ZBY2178	0.002		
		I-II	1	ZBY2179	0.002		
		I-O-II	1	ZBY2186	0.002		
		AUTO	1	ZBY2115	0.002		
		STOP	1	ZBY2304	0.002		
		Yellow background	⊕	1	ZBY4140 (2)	0.002	
		<b>With 8 x 27 mm legend</b> (with French language marking)	Black or red background (3)	ARRET (red background)	1	ZBY2104	0.002
				ARRET (black background)	1	ZBY0104	0.002
				ARRET GENERAL	1	ZBY2129	0.002
				ARRET REARMEMENT	1	ZBY2133	0.002
ARRET MARCHÉ	1			ZBY2166	0.002		
ARRIERE	1			ZBY2106	0.002		
AUTO CYCLE-CYCLE	1			ZBY2198	0.002		
AUTO CYCLE-MAIN	1			ZBY2199	0.002		
AUTO-MAIN	1			ZBY2164	0.002		
AUTO-O-MAIN	1			ZBY2185	0.002		
AVANT	1			ZBY2105	0.002		
AVANT-O-ARRIERE	1			ZBY2184	0.002		
C-P-C NORMAL	1			ZBY2165	0.002		
CYCLE-MAIN	1			ZBY2197	0.002		
DECLENCHÉMENT	1			ZBY2132	0.002		
DEFAUT (black background)	1			ZBY2134	0.002		
DEFAUT (red background)	1			ZBY2135	0.002		
DEPART CYCLE	1			ZBY2195	0.002		
DESCENTE	1			ZBY2108	0.002		
DROITE	1			ZBY2109	0.002		
ENCLENCHÉMENT	1			ZBY2131	0.002		
EN SERVICE	1			ZBY2111	0.002		
FERMETURE	1			ZBY2114	0.002		
GAUCHE	1			ZBY2110	0.002		
HORS SERVICE	1			ZBY2112	0.002		
HORS-EN	1			ZBY2167	0.002		
LENT	1			ZBY2127	0.002		
MAIN	1			ZBY2116	0.002		
MARCHÉ	1			ZBY2103	0.002		
MONTEE	1			ZBY2107	0.002		
OUVERTURE	1	ZBY2113	0.002				
PHASE / PHASE	1	ZBY2196	0.002				
REARMEMENT (red bckgrnd.)	1	ZBY2123	0.002				
REARMEMENT (black bckgrnd.)	1	ZBY0123	0.002				
SOUS TENSION	1	ZBY2126	0.002				
VITE	1	ZBY2128	0.002				
Red background	ARRET D'URGENCE	1	ZBY2130 (2)	0.002			

#### 30 x 40 mm legend holders (flush mounting with bezel) for 8 x 27 mm legends

Description	For use with	Color	Sold in lots of	Unit reference	Weight kg
<b>Without legend</b>	Circular heads	–	10	ZBZ34	0.003
	Square heads	–	10	ZBCZ34	0.002
<b>With blank legend</b>	Circular heads	Black or red background	10	ZBY2H101	0.004
		White or yellow background	10	ZBY4H101	0.004
	Square heads	Black or red background	10	ZBCY2H101	0.002
		White or yellow background	10	ZBCY4H101	0.002

(1) Legends: see page 3/50.

(2) For complying with ISO 13850 standard, paragraph 4.4.6., Emergency Stop function logo ⊕ has been added.

(3) "Start" functions: white characters on black background. "Stop" functions: white characters on red background (unless otherwise stated above).

# Acquire the information

Control stations and enclosures  
Plastic control stations XALD and XALK

For Harmony® XB5 control and signaling units Ø 22

Stations for customer assembly: accessories

## Standard (30 x 40 mm) legend holders with 8 x 27 mm legend (continued)

Description	Legend	Marking	Reference	Weight kg		
With 8 x 27 mm legend (with English marking)	Black or red background (1)	AUTO-HAND	ZBY2364	0.002		
		AUTO-O-HAND	ZBY2385	0.002		
		CLOSE	ZBY2314	0.002		
		DOWN	ZBY2308	0.002		
		FAST	ZBY2328	0.002		
		FORWARD	ZBY2305	0.002		
		HAND	ZBY2316	0.002		
		HAND-OFF-AUTO	ZBY2387	0.002		
		INCH	ZBY2321	0.002		
		LEFT	ZBY2310	0.002		
		OFF	ZBY2312	0.002		
		OFF-ON	ZBY2367	0.002		
		ON	ZBY2311	0.002		
		OPEN	ZBY2313	0.002		
		POWER ON	ZBY2326	0.002		
		RESET (red background)	ZBY2323	0.002		
		RESET (black background)	ZBY2322	0.002		
		REVERSE	ZBY2306	0.002		
		RIGHT	ZBY2309	0.002		
		RUN	ZBY2334	0.002		
		SLOW	ZBY2327	0.002		
		START	ZBY2303	0.002		
		STOP-START	ZBY2366	0.002		
		UP	ZBY2307	0.002		
			Red background	EMERGENCY STOP	ZBY2330 (2)	0.002
		With 8 x 27 mm legend (with German marking)	Black or red background (1)	AB	ZBY2208	0.002
				AUF	ZBY2207	0.002
				AUS	ZBY2204	0.002
				AUS-EIN	ZBY2266	0.002
				AUS-IN BETRIEB	ZBY2267	0.002
				AUS-RUCKSTELLUND	ZBY2233	0.002
				AUSSCHALTEN	ZBY2232	0.002
				AUTO-HAND	ZBY2364	0.002
AUTO-O-HAND	ZBY2385			0.002		
AUTOZYKL-HAND	ZBY2299			0.002		
AUTOZYKL-1 ZYKL	ZBY2298			0.002		
C-P-C-NORMAL	ZBY2265			0.002		
EIN	ZBY2203			0.002		
EINSCHALTEN	ZBY2231			0.002		
HAND	ZBY2316			0.002		
LANGSAM	ZBY2227			0.002		
LINKS	ZBY2210			0.002		
NOT-AUS (red background)	ZBY2230			0.002		
ÖFFNEN	ZBY2213			0.002		
RECHTS	ZBY2209			0.002		
RUCKSTELLUNG	ZBY2223			0.002		
SCHLIESSEN	ZBY2214			0.002		
SCHNELL	ZBY2228			0.002		
SPANNUNG EIN	ZBY2226			0.002		
STEUERUNG AUS	ZBY2212			0.002		
STEUERUNG EIN	ZBY2211			0.002		
STORUNG (black background)	ZBY2234			0.002		
STORUNG (red background)	ZBY2235			0.002		
VOR	ZBY2205			0.002		
VOR-O-ZURUCK	ZBY2284			0.002		
ZURUCK	ZBY2206			0.002		
ZYKLUS-HAND	ZBY2297			0.002		
ZYKLUS-START	ZBY2295			0.002		
	Red background	NOT-HALT	ZBY2229 (2)	0.002		
	Yellow background	NOT-HALT	ZBY22420001 (2)	0.002		

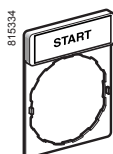

ZBY2303



ZBY0140

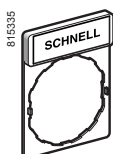

ZBY2228

(1) "Start" functions: white characters on black background. "Stop" functions: white characters on red background (unless otherwise stated above).

(2) For complying with ISO 13850 standard, paragraph 4.4.6., Emergency Stop function logo  has been added.

## Acquire the information

Control stations and enclosures  
Plastic control stations XALD and XALK

For Harmony® XB5 control and signaling units Ø 22

Stations for customer assembly: accessories

522035

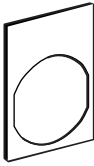

ZALY4

Legends (30 x 42 mm) for engraving				
Description	Color of background	Sold in lots of	Unit reference	Weight kg
Legends for engraving 2 lines of text	Black or red	10	ZALY2	0.001
	White or yellow	10	ZALY4	0.001

Legends (8 x 27 mm) for engraving				
For use with	Color of background	Sold in lots of	Unit reference	Weight kg
30 x 40 mm legend holder	Black or red	10	ZBY0101	0.001
	White or yellow	10	ZBY0102	0.001
	Yellow	10	ZBY0140 (1)	0.001

Sheets of 76 (8 x 27 mm) peel-off legends				
For use with	Supplied with	Sold in lots of	Unit reference	Weight kg
30 x 40 mm legend holders ZBZ32 and ZBZ34	Backing board and protective transparent cover	10	ZBY4100	0.043

8 x 27 mm marked legends (for 30 x 40 mm legend holders ZBZ32 and ZBZ34)				
Language	Color of background	Marking	Reference	Weight kg
International	Black or red (2)	O (black background)	ZBY02146	0.001
		O (red background)	ZBY02931	0.001
		I	ZBY02147	0.001
		II	ZBY02148	0.001
		O-I	ZBY02178	0.001
		I-II	ZBY02179	0.001
		I-O-II	ZBY02186	0.001
		AUTO	ZBY02115	0.001
		STOP	ZBY02304	0.001
French	Black or red (2)	ARRET (red background)	ZBY02104	0.001
		ARRET (black background)	ZBY00104	0.001
		ARRET GENERAL	ZBY02129	0.001
		ARRET REARMEMENT	ZBY02133	0.001
		ARRET-MARCHE	ZBY02166	0.001
		ARRIERE	ZBY02106	0.001
		AUTO CYCLE-CYCLE	ZBY02198	0.001
		AUTO CYCLE-MAIN	ZBY02199	0.001
		AUTO-MAIN	ZBY02164	0.001
		AUTO-O-MAIN	ZBY02185	0.001
		AVANT	ZBY02105	0.001
		AVANT-O-ARRIERE	ZBY02184	0.001
		C-P-C-NORMAL	ZBY02165	0.001
		CYCLE-MAIN	ZBY02197	0.001
		DECLenchement	ZBY02132	0.001
		DEFAULT (black background)	ZBY02134	0.001
		DEFAULT (red background)	ZBY02135	0.001
		DEPART CYCLE	ZBY02195	0.001
		DESCENTE	ZBY02108	0.001
		DROITE	ZBY02109	0.001
		ENCLenchement	ZBY02131	0.001
		EN SERVICE	ZBY02111	0.001
		FERMETURE	ZBY02114	0.001
		GAUCHE	ZBY02110	0.001
		HORS SERVICE	ZBY02112	0.001
		HORS-EN	ZBY02167	0.001
		LENT	ZBY02127	0.001
		MAIN	ZBY02116	0.001
		MARCHE	ZBY02103	0.001
		MONTEE	ZBY02107	0.001
OUVERTURE	ZBY02113	0.001		
PHASE / PHASE	ZBY02196	0.001		
REARMEMENT (red background)	ZBY02123	0.001		
REARMEMENT (black background)	ZBY00123	0.001		
SOUS TENSION	ZBY02126	0.001		
VITE	ZBY02128	0.001		
Red	ARRET D'URGENCE	ZBY02130 (1)	0.001	

815339



ZBY02178

815340



ZBY0104

(1) For complying with ISO 13850 standard, paragraph 4.4.6., Emergency Stop function logo  has been added.

(2) "Start" functions: white characters on black background. "Stop" functions: white characters on red background (unless otherwise stated above).

# Aquire the information

## Control stations and enclosures Plastic control stations XALD and XALK

For Harmony® XB5 control and signaling units Ø 22 Stations for customer assembly: accessories

### 8 x 27 mm marked legends (for 30 x 40 mm legend holders ZBZ32 and ZBZ34) (continued)

Language	Color of background	Marking	Reference	Weight kg
English	Black or red (1)	AUTO-HAND	ZBY02364	0.001
		AUTO-O-HAND	ZBY02385	0.001
		CLOSE	ZBY02314	0.001
		DOWN	ZBY02308	0.001
		FAST	ZBY02328	0.001
		FORWARD	ZBY02305	0.001
		HAND	ZBY02316	0.001
		HAND-OFF-AUTO	ZBY02387	0.001
		INCH	ZBY02321	0.001
		LEFT	ZBY02310	0.001
		OFF	ZBY02312	0.001
		OFF-ON	ZBY02367	0.001
		ON	ZBY02311	0.001
		OPEN	ZBY02313	0.001
		POWER ON	ZBY02326	0.001
		RESET (red background)	ZBY02323	0.001
		RESET (black background)	ZBY02322	0.001
		REVERSE	ZBY02306	0.001
		RIGHT	ZBY02309	0.001
		RUN	ZBY02334	0.001
		SLOW	ZBY02327	0.001
		START	ZBY02303	0.001
		STOP-START	ZBY02366	0.001
		UP	ZBY02307	0.001
	Red	EMERGENCY STOP	ZBY02330 (2)	0.001
German	Black or red (1)	AB	ZBY02208	0.001
		AUF	ZBY02207	0.001
		AUS	ZBY02204	0.001
		AUS-EIN	ZBY02266	0.001
		AUS-IN BETRIEB	ZBY02267	0.001
		AUS-RUCKSTELLUNG	ZBY02233	0.001
		AUSSCHALLEN	ZBY02232	0.001
		AUTO-HAND	ZBY02364	0.001
		AUTO-O-HAND	ZBY02385	0.001
		AUTOZYKL-HAND	ZBY02299	0.001
		AUTOZYKL- 1 ZYKL	ZBY02298	0.001
		C-P-C-NORMAL	ZBY02265	0.001
		EIN	ZBY02203	0.001
		EINSCHALTEN	ZBY02231	0.001
		HAND	ZBY02316	0.001
		LANGSAM	ZBY02227	0.001
		LINKS	ZBY02210	0.001
		NOT-AUS (red background)	ZBY02230	0.001
		ÖFFNEN	ZBY02213	0.001
		RECHTS	ZBY02209	0.001
		RUCKSTELLUNG	ZBY02223	0.001
		SCHLIESSEN	ZBY02214	0.001
		SCHNELL	ZBY02228	0.001
		SPANNUNG EIN	ZBY02226	0.001
		STEUERUNG AUS	ZBY02212	0.001
		STEUERUNG EIN	ZBY02211	0.001
		STORUNG (black background)	ZBY02234	0.001
		STORUNG (red background)	ZBY02235	0.001
		VOR	ZBY02205	0.001
		VOR-O-ZURUCK	ZBY02284	0.001
		ZURUCK	ZBY02206	0.001
		ZYKLUS-HAND	ZBY02297	0.001
		ZYKLUS-START	ZBY02295	0.001
	Red	NOT-HALT	ZBY02229 (2)	0.001
	Yellow	NOT-HALT	ZBY022420001 (2)	0.001

(1) "Start" functions: white characters on black background. "Stop" functions: white characters on red background (unless otherwise stated above).

(2) For complying with ISO 13850 standard, paragraph 4.4.6., Emergency Stop function logo  has been added.

815341

START

ZBY02303

3

815342

SCHNELL

ZBY02228



# Acquire the information

Control stations and enclosures  
Plastic control stations XALD and XALK

For Harmony® XB5 control and signaling units Ø 22 Stations for customer assembly: accessories

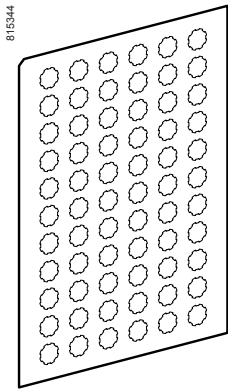

ZBY1●●●

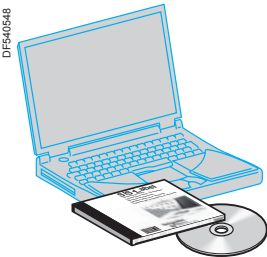

XB2U



ZBY9130

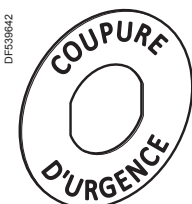

ZBY9160

## Legends for pushbuttons, switches and pilot lights XB5 A

Description	Marking	Sold in lots of	Unit reference	Weight kg	
Sheets of 66 circular peel-off transparent self-adhesive legends	Without	10	ZBY1101	0.017	
	International	O	10	ZBY1146	0.017
		I	10	ZBY1147	0.017
		II	10	ZBY1148	0.017
		III	10	ZBY1149	0.017
		AUTO	10	ZBY1115	0.017
		STOP	10	ZBY1304	0.017
		↑	10	ZBY1912	0.017
	French	ARRET	10	ZBY1104	0.017
		ARRIERE	10	ZBY1106	0.017
		AVANT	10	ZBY1105	0.017
		AUTO	10	ZBY1115	0.017
		DESCENTE	10	ZBY1108	0.017
		MAIN	10	ZBY1116	0.017
		MARCHE	10	ZBY1103	0.017
	English	MONTEE	10	ZBY1107	0.017
		HAND	10	ZBY1316	0.017
		OFF	10	ZBY1312	0.017
		ON	10	ZBY1311	0.017
German	START	10	ZBY1303	0.017	
	AB	10	ZBY1208	0.017	
	AUF	10	ZBY1207	0.017	
	AUS	10	ZBY1204	0.017	
	EIN	10	ZBY1203	0.017	
	ZU	10	ZBY1214	0.017	
Strip of 66 square peel-off transparent self-adhesive legends	Without	10	ZBCY1101	0.017	

## “SIS Label” labelling software (for legend sheets ZBY1101, ZBY4100 and ZBCY1101)

Application	Reference	Weight kg
Legend design for English, French, German, Italian and Spanish	ZBY001, ZBY0101, ZBY0102, ZBY1101, ZBY4100, ZBY5100, ZBY5101 AND ZBY5102	XB2U 0.100

## Circular yellow legends for mushroom head pushbuttons

Used for “Emergency stop” function						
Diameter mm	Conforming to standards	Marking on yellow background	Reference (1)	Weight kg		
60	EN/IEC 60204-1 and EN/ISO 13850	–	ZBY9140	0.004		
		ARRET D'URGENCE	ZBY9130	0.004		
		EMERGENCY STOP	ZBY9330	0.004		
		NOT-HALT	ZBY9230	0.004		
		PARADA DE EMERGENCIA	ZBY9430	0.004		
		ARRESTO DI EMERGENZA	ZBY9630	0.004		
		60 (2)	EN/IEC 60204-1 and EN/ISO 13850	–	ZBY9121	0.004
60	EN/IEC 60204-1 and EN/ISO 13850	ARRET D'URGENCE	ZBY9120	0.004		
		EMERGENCY STOP	ZBY9320	0.004		
		NOT-HALT	ZBY9220	0.004		
		PARADA DI EMERGENCIA	ZBY9420	0.004		
		ARRESTO DE EMERGENZA	ZBY9620	0.004		
		90	EN/IEC 60204-1 and EN/ISO 13850	–	ZBY8140	0.008
		ARRET D'URGENCE	ZBY8130	0.008		
EMERGENCY STOP	ZBY8330	0.008				
NOT-HALT	ZBY8230	0.008				
PARADA DE EMERGENCIA	ZBY8430	0.008				
ARRESTO DI EMERGENZA	ZBY8630	0.008				
Used for “Emergency switching off” function						
60	EN/IEC 60204-1	–	ZBY9101	0.004		
		COUPURE D'URGENCE	ZBY9160	0.004		
		EMERGENCY SWITCHING OFF	ZBY9360	0.004		
		NOT-AUS	ZBY9260	0.004		
		DESCONEXION DE EMERGENCIA	ZBY9460	0.004		
		INTERRUZIONE DI EMERGENZA	ZBY9660	0.004		
90	EN/IEC 60204-1	–	ZBY8101	0.008		
		COUPURE D'URGENCE	ZBY8160	0.008		
		EMERGENCY SWITCHING OFF	ZBY8360	0.008		
		NOT-AUS	ZBY8260	0.008		
		DESCONEXION DE EMERGENCIA	ZBY8460	0.008		
		INTERRUZIONE DI EMERGENZA	ZBY8660	0.008		

(1) For complying with ISO 13850 standard, paragraph 4.4.6., Emergency Stop function logo  has been added.  
(2) 3D legends for Emergency stop pushbuttons.

# Acquire the information

## Control stations and enclosures Plastic control stations XALD and XALK

For Harmony® XB5 control and signaling units Ø 22 Stations for customer assembly: accessories

815197

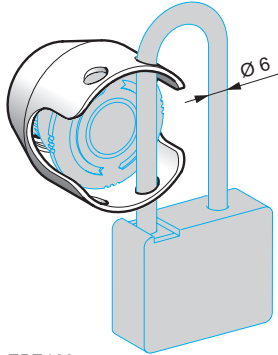

### Metal guards (1)

Description	For use with	Color	Reference	Weight kg
<b>Metal guards</b> Padlockable	Emergency stop function only with the following Ø 40 trigger action pushbuttons: XB5AT8●, XB5AS8●, XB5AS9●, ZB5AT8●, ZB5AS8●, ZB5AS9●.	Chromium plated	<b>ZBZ1600</b>	0.046
		Black	<b>ZBZ1602</b>	0.046
		Red	<b>ZBZ1604</b>	0.046
		Blue	<b>ZBZ1606</b>	0.046

### Pushbutton caps - unmarked

For use with	Cap Type	Color	Sold in lots of	Unit reference	Weight kg	
<b>Circular pushbutton heads</b> ZB5AA supplied without cap	Flush	White	10	<b>ZBA1</b>	0.001	
		Black	10	<b>ZBA2</b>	0.001	
		Green	10	<b>ZBA3</b>	0.001	
		Red	10	<b>ZBA4</b>	0.001	
		Yellow	10	<b>ZBA5</b>	0.001	
		Blue	10	<b>ZBA6</b>	0.001	
		6 colors (2)	1	<b>ZBA9</b>	0.006	
		Projecting	White	10	<b>ZBL1</b>	0.001
			Black	10	<b>ZBL2</b>	0.001
	Green		10	<b>ZBL3</b>	0.001	
	Red		10	<b>ZBL4</b>	0.001	
	Yellow		10	<b>ZBL5</b>	0.001	
	Blue		10	<b>ZBL6</b>	0.001	
	6 colors (2)		1	<b>ZBL9</b>	0.006	

3

ZBZ160●

815347



ZBA●

815348



ZBL●

815349



ZBA333

### Pushbutton caps - marked (3) (sold in lots of 10)

For use with	Type of push	Marking		Color of cap	Unit reference	Weight kg
		Text	Color			
<b>Circular pushbutton heads</b> ZB5AA supplied without cap	Flush	I	White	Green	<b>ZBA331</b>	0.001
			Black	White	<b>ZBA131</b>	0.001
		II	White	Green	<b>ZBA336</b>	0.001
			Black	White	<b>ZBA136</b>	0.001
		III	White	Green	<b>ZBA337</b>	0.001
			Black	White	<b>ZBA137</b>	0.001
		IV	White	Green	<b>ZBA338</b>	0.001
			Black	White	<b>ZBA138</b>	0.001
		START	White	Green	<b>ZBA333</b>	0.001
			Black	White	<b>ZBA133</b>	0.001
		ON	White	Green	<b>ZBA341</b>	0.001
			Black	White	<b>ZBA141</b>	0.001
		MARCHE	White	Green	<b>ZBA342</b>	0.001
			Black	White	<b>ZBA142</b>	0.001
		⊕	White	Black	<b>ZBA245</b>	0.001
			Black	White	<b>ZBA145</b>	0.001
		UP	Black	White	<b>ZBA343</b>	0.001
		DOWN	White	Black	<b>ZBA344</b>	0.001
		↑	White	Black	<b>ZBA335</b>	0.001
			Black	White	<b>ZBA334</b>	0.001
		O	White	Red	<b>ZBA432</b>	0.001
				Black	<b>ZBA232</b>	0.001
		ARRET	White	Red	<b>ZBA433</b>	0.001
				Black	<b>ZBA233</b>	0.001
		STOP	White	Red	<b>ZBA434</b>	0.001
				Black	<b>ZBA234</b>	0.001
		OFF	White	Red	<b>ZBA435</b>	0.001
				Black	<b>ZBA235</b>	0.001
		⚠	White	Green	<b>ZBA346</b>	0.001
		R	White	Blue	<b>ZBA639</b>	0.001
+	White	Black	<b>ZBA2934</b>	0.001		
-	White	Black	<b>ZBA2935</b>	0.001		

(1) These guards can be used in conjunction with a legend holder, but only those for mounting directly beneath the head. See page 3/39.

(2) Set of 6 different colored caps: white, black, green, red, yellow, blue.

(3) Can be clipped-in at 90° steps through 360°.

# Acquire the information

## Control stations and enclosures

### Plastic control stations XALD and XALK

For Harmony® XB5 control and signaling units Ø 22 Stations for customer assembly: accessories

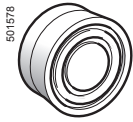

ZB2BP01●



ZBV01●3

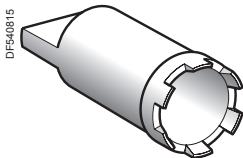

ZB5AZ905



ZB5SZ3

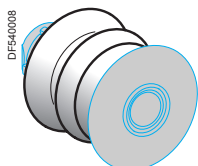

ZBZ●8



ZBG455

### Colored boots

Description	Color	Sold in lots of	Unit reference	Weight kg
<b>Colored boots</b> (can be replaced without dismantling the head)	Black	10	ZB2BP012	0.003
	Green	10	ZB2BP013	0.003
	Red	10	ZB2BP014	0.003
	Yellow	10	ZB2BP015	0.003
	Blue	10	ZB2BP016	0.003

### Lens caps

#### Circular lens caps for light sources with integral LED

<b>Pilot lights</b>	White	10	ZBV0113	0.002
	Green	10	ZBV0133	0.002
	Red	10	ZBV0143	0.002
	Yellow	10	ZBV0153	0.002
	Blue	10	ZBV0163	0.002
	5 different colored grooved lenses (1)	1	ZBV0103S	0.010
<b>Illuminated pushbuttons, with flush push</b>	White	10	ZBW9113	0.002
	Green	10	ZBW9133	0.002
	Red	10	ZBW9143	0.002
	Yellow	10	ZBW9153	0.002
	Blue	10	ZBW9163	0.002
<b>Illuminated pushbuttons, with projecting push</b>	White	10	ZBW9313	0.002
	Green	10	ZBW9333	0.002
	Red	10	ZBW9343	0.002
	Yellow	10	ZBW9353	0.002
	Blue	10	ZBW9363	0.002

#### Square lens caps for light sources with integral LED

<b>Pilot lights</b>	White	10	ZBCV0113	0.002
	Green	10	ZBCV0133	0.002
	Red	10	ZBCV0143	0.002
	Yellow	10	ZBCV0153	0.002
	Blue	10	ZBCV0163	0.002
<b>Illuminated pushbuttons, with flush push</b>	White	10	ZBCW9113	0.002
	Green	10	ZBCW9133	0.002
	Red	10	ZBCW9143	0.002
	Yellow	10	ZBCW9153	0.002
	Blue	10	ZBCW9163	0.002
<b>Illuminated pushbuttons, with projecting push</b>	White	10	ZBCW9313	0.002
	Green	10	ZBCW9333	0.002
	Red	10	ZBCW9343	0.002
	Yellow	10	ZBCW9353	0.002
	Blue	10	ZBCW9363	0.002

### Miscellaneous accessories

Description	For use with	Sold in lots of	Color	Unit reference	Weight kg
<b>Bezel tool</b>	ZB5AZ901 head	10	–	ZB5AZ905	0.016
<b>Plastic blanking plugs</b> (with fixing nut)	Square shape for Ø 22 units (2)	10	Black	ZB5SZ5	0.009
	Circular shape for Ø 22 units	10	Black	ZB5SZ3	0.009
<b>Terminal branch</b>	XALD and XALK control stations	10		XALZ09	0.003
<b>Bellow seals (IP 69K)</b> (3)	Control station with 1 cut-out, installed in harsh environment + Emergency Stop pushbutton type ZB5 (see page 3/42)	2	Black	ZBZ28	0.009
			Yellow	ZBZ58	0.009

### Replacement keys for Emergency stop key release heads and key switches

Description	Key number	Reference	Weight kg
<b>Set of 2 keys (4)</b>	455	ZBG455	0.013
	421E	ZBG421E	0.014
	458A	ZBG458A	0.014
	520E	ZBG520E	0.014
	3131A	ZBG3131A	0.014

- (1) Set of 5 different colored lenses: white, green, red, yellow and blue.  
 (2) Body/fixing collar ZB5AZ009 necessary for fixation, to be ordered separately.  
 (3) Not compatible with Ø 30 mm Emergency Stop heads.  
 (4) Other key numbers are available.

# Aquire the information

## Wireless remote control system

### Harmony eXLhoist

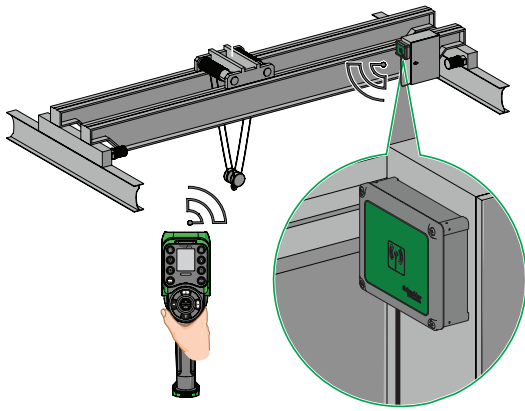

Example of overhead travelling cranes

3

#### Presentation

The Harmony eXLhoist range of wireless remote control systems provide complete and innovative crane operator control solutions to: improve the machine and crane operator efficiency, enhance safety for people and equipment, and to reduce installation and maintenance downtime.

The remote control system XARS is a combination of remote control device (or transmitter: XART) and base station (or receiver: XARB), which transmits commands and information from the operator to the machine and vice versa by a wireless transmission means.

The XARS system offers movement in 3 directions (for example: hoist, bridge, and trolley) at 2 speed levels (low and high) for each movement.

The 2 modes available in the system are:

- Single mode: the remote control device controls one base station
- Tandem mode (1): the remote control device controls 2 base stations simultaneously.

#### Radio communication

Each base station have a unique identification code (2) managed by Schneider Electric. The frequency of radio communication is 2.4 GHz and the automatic frequency hopping permits up to 50 systems working at same time in an 100 x 100 m/328 x 328 ft area.

#### eXLhoist Configuration software

A free of charge software with graphic user interface can be downloaded by the customer to configure the remote control station. This software has a standard Windows® interface. The configuration file is password protected and allows to configure the following parameters:

- Base station pairing to remote control device
- Relays-pushbuttons assignment and interlock
- Access and re-start sequence
- Time-out duration to standby
- Machine number assignment



Configuration software window

#### Environment

The degree of protection for Harmony eXLhoist are:

- IP 65 for base station
- IP 65 and NEMA 4 for wireless control device
- Product certifications for base station: UL/CSA, CE, EAC
- Product certifications for wireless control device: UL/CSA, CE, EAC.

(1) Tandem mode will be available in 2<sup>nd</sup> quarter 2015

(2) Third-party device cannot communicate with remote control system.

## Aquire the information

### Wireless remote control system

### Harmony eXLhoist

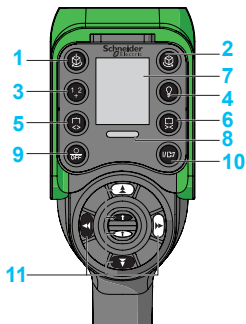

Front view ZART12D remote device

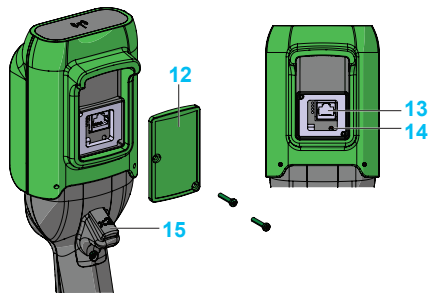

Rear view of remote device

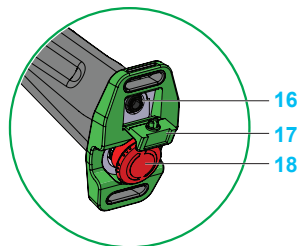

Bottom view of remote device handle

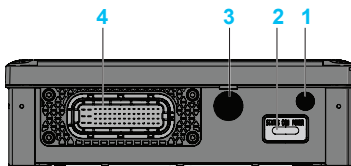

Bottom view of ZARB•H base station

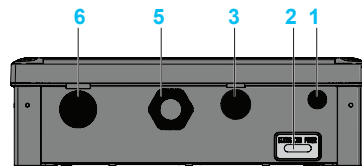

Bottom view of ZARB•W base station

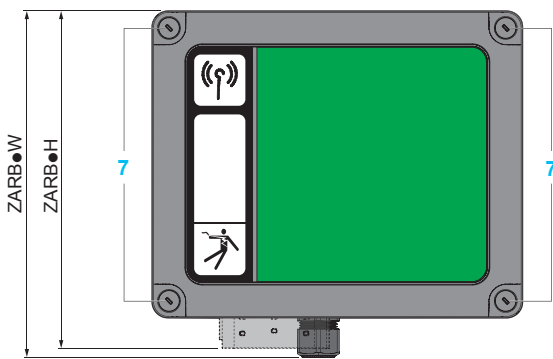

Front view of base station with the cover

### Description

#### Remote control device

The base station has following controls:

- 1-6 Auxiliary buttons (For ZART8D and ZART8L only 5 and 6 buttons are available)
- 7 Display (for ZART8L only LED display)
- 8 E-stop LED
- 9 OFF/ Stop button
- 10 ON/ Start/ Horn button
- 11 Motion buttons
- 12 Cover
- 13 RJ45 connector
- 14 Reset button
- 15 Trigger button
- 16 Connector for charging remote device
- 17 Cover of the connector
- 18 E-stop button

#### Base station

The base station has following controls:

- 1 M12 for external antenna (1)
- 2 Status LEDs
- 3 M20 for the Safeguarding function input wires (1)
- 4 62 pins connector (1)
- 5 M25 for output wires (2)
- 6 M25 for detected applicative alarms input wires (1)
- 7 4 holes for standard mounting on support (1)

(1) Covered by cap

(2) Covered by cable gland

# Acquire the information

## Wireless remote control system

### Harmony eXLhoist



ZART8L



ZART8D

Remote control device				
Description	Characteristics		Reference	Weight kg/lb
	Motion pushbuttons	Auxiliary pushbuttons		
With LEDs	6	2	ZART8L	0.65/1.433
With display	6	2	ZART8D	0.65/1.433
With display	6	6	ZART12D	0.65/1.433

3



ZARB12H



ZARB18W

Base station					
Description	Characteristics			Reference	Weight kg/lb
	Outputs	Inputs	Power supply V		
Wired connection- cable gland	12 relays + 2 safety relays	-	≈ 24...240	ZARB12W	1.45/3.197
Industrial plug connection	12 relays + 2 safety relays	-	≈ 24...48	ZARB12H	1.45/3.197
Wired connection- cable gland	18 relays + 2 safety relays	18 digital (12 limiters + 6 alarms)	≈ 24...240	ZARB18W	1.45/3.197
Industrial plug connection	18 relays + 2 safety relays	18 digital (12 limiters + 6 alarms)	≈ 24...48	ZARB18H	1.45/3.197



XARS12D18H



Wireless remote control				
Description	Characteristics		Reference	Weight kg/lb
	Special functions	Connection		
Complete unit (without charger device)	-	Wiring	XARS8L12W (ZART8L + ZARB12W)	2.1/4.640
	-	Industrial plug	XARS8L12H (ZART8L + ZARB12H)	2.1/4.640
Limiter protection (1) Movement monitoring	-	Wiring	XARS8D18W (ZART8D + ZARB18W)	2.1/4.640
		Industrial plug	XARS8D18H (ZART8D + ZARB18H)	2.1/4.640
-	-	Wiring	XARS12D18W (ZART12D + ZARB18W)	2.1/4.640
		Industrial plug	XARS12D18H (ZART12D + ZARB18H)	2.1/4.640

(1) Limiter protection function for Tandem mode will be available in 2<sup>nd</sup> quarter 2015.

# Acquire the information

## Wireless remote control system

### Harmony eXLhoist

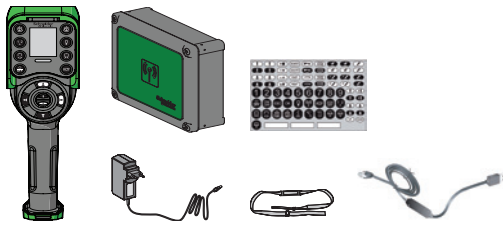

XARSK8L12W

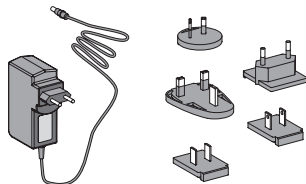

ZARC01



ZARC02

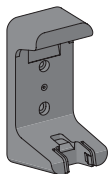

ZARC04



ZARC07



TCSMCNAM3M002P

#### Kits

Description	Characteristics	Reference	Weight kg/lb
Starting kit comprising of Remote control system + accessories + USB/RJ45 cable	ZART8L + ZARB12W + ZARC01 + ZARC02 + TCSMCNAM3M002P	<b>XARSK8L12W</b>	2.8/6.173
	ZART8L + ZARB12H + ZARC01 + ZARC02 + TCSMCNAM3M002P	<b>XARSK8L12H</b>	2.8/6.173
	ZART8D + ZARB18W + ZARC01 + ZARC02 + TCSMCNAM3M002P	<b>XARSK8D18W</b>	2.8/6.173
	ZART8D + ZARB18H + ZARC01 + ZARC02 + TCSMCNAM3M002P	<b>XARSK8D18H</b>	2.8/6.173
	ZART12D + ZARB18H + ZARC01 + ZARC02 + TCSMCNAM3M002P	<b>XARSK12D18W</b>	2.8/6.173
	ZART12D + ZARB18H + ZARC01 + ZARC02 + TCSMCNAM3M002P	<b>XARSK12D18H</b>	2.8/6.173

#### Accessories

Description	Characteristics	Reference	Weight kg/lb
Charger for remote device	~100...240 V power supply	<b>ZARC01</b>	0.350/0.772
Shoulder belt for remote device	2m/6.56 ft length	<b>ZARC02</b>	0.100/0.220
External antenna for Base station (1)	with 2m/6.56 ft cable and bracket included	<b>ZARC03</b>	0.200/0.441
Holder for remote device	104 x 239 mm/4.09 x 9.41 in.	<b>ZARC04</b>	0.250/0.551
Connector plug female	with cable 1.5 m/4.92 ft	<b>ZARC05</b>	2/4.409
Cable gland kit with wire grommets	1 x M25 + 1 x M20	<b>ZARC06</b>	0.05/0.110
Kit for adhesive labels for remote device	in Black and White	<b>ZARC07</b>	0.150/0.331
Kit for adhesive labels for remote device and crane equipment	multi color	<b>ZARC08</b>	0.250/0.551
Fixation kit	silent block + magnet and metal support	<b>ZARC09</b>	0.1/0.220
Connector plug female	with cable 3 m/9.84 ft	<b>ZARC12</b>	4/8.818
Connector plug female	with cable 5 m/16.40 ft	<b>ZARC18</b>	7/15.432
Connector cable	USB to RJ45	<b>TCSMCNAM3M002P</b>	0.100/0.220

(1) Use of this accessory allows to increase radio range in severe environment conditions.

### Operating principle

Enabling switches, comprising an XY2 AU grip and an XPS VC monitoring module, allow authorised personnel to undertake adjustment, programming or maintenance operations near machine equipment hazardous zones, providing certain conditions are met.

In effect, to gain access, these operations, often performed at reduced speed, must be selected by authorised personnel using selectors, with or without keys. Once selection is made, the enabling switch temporarily assumes control of the hazardous zone's usual protection measures. Important note: the enabling switch alone must not lead to the actuation of any dangerous movements associated with the machine; a secondary, intentional control action is required from the operator. In addition, each person in the hazardous zone must be provided with an enabling switch to ensure their own safety.

### Environment

Conforming to standards	Products		IEC/EN 60947-1 , IEC/EN 60947-5-1, cUL us 508 and CSA C22-2 n° 14
	Machine assemblies		IEC/EN 60204-1
Maximum safety level (1)			PL e, category 4 conforming to EN/ISO 13849-1 and SIL 3 conforming to EN/IEC 61508
Reliability data B10d			5,000,000 (data value for a service life of 10 years: can be limited by contact and mechanical wear)
Protective treatment			Standard version: TC
Ambient air temperature	Operation	°C	- 10...+ 60
	Storage	°C	- 40...+70
Vibration resistance			6 gn (5...55 Hz) conforming to IEC 60068-2-6
Shock resistance			10 gn (11 ms) conforming to IEC 60068-2-27
Electric shock protection			Class II conforming to IEC/EN 61140
Degree of protection			IP 66 conforming to IEC 60529, IP 65 with a pushbutton, IK 06 conforming to EN 50102
Mechanical durability		Op. cycle	1 million
Enclosure			Double insulated enclosure made of PA66
Cable diameter		mm	7...13

### Contact block characteristics

Rated operational characteristics			~ AC-15 : C300 or Ue = 250 V, Ie = 1.5 A or Ue = 125 V, Ie = 0.75 A --- DC-13 : R300 or Ue = 250 V, Ie = 0.1 A or Ue = 125 V, Ie = 0.22 A conforming to IEC 60947-5-1 Appendix A
Thermal current (Ithe)	A		5
Rated insulation voltage (Ui)	V		250, degree of pollution III (II inside) conforming to IEC 60947-1 125, contact 7-8
Rated impulse withstand voltage (Uimp)	kV		2.5 conforming to EN 60947-1
Positive operation			2 3-position contacts with positive opening operation conforming to IEC 60947-5-1 appendix K
Contact operation			Slow break
Resistance across terminals	mΩ		≤ 50
Actuation force			1...2: 12 N 2...3: 50 N
Terminal referencing			Numbered conforming to CENELEC EN 50013
Short-circuit protection			4 A cartridge fuse type gG (gl)
Connection	mm²		Terminal block, 1 x 0.34...1 x 1.5

(1) Using an appropriate and correctly connected control system.



# Acquire the information

Enabling switches

For safety circuits

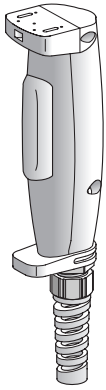

XY2AU●



XY2AZ1



XY2AZ2

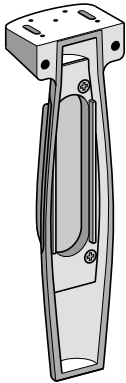

XY2AZ3

## References

Number of contacts	Contact type	Contact blocks and scheme	Reference	Weight kg
3	2 enabling 3 positions + 1 N/C		XY2AU1	0.310
	2 enabling 3 positions + 1 N/C + 1 N/O supplementary contact		XY2AU2	0.320

## Separate components and spare parts

Description	Reference	Weight kg
Grip support	XY2AZ1	0.215
Cover kit for key actuator XCSZ01 or XCSZ11 only applicable to XY2AU1	XY2AZ2	0.015
Cover	XY2AZ3	0.060

# Aquire the information

## Two-hand ergonomic control stations

### With Harmony XB4 B control units

Presentation

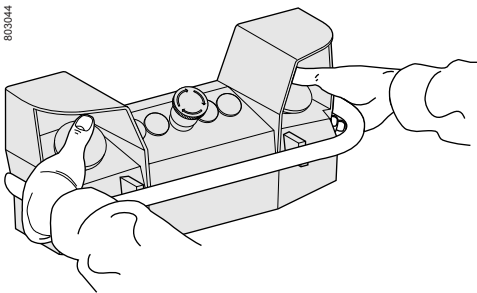
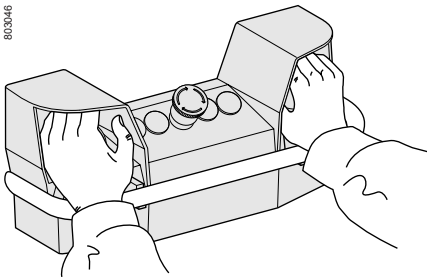
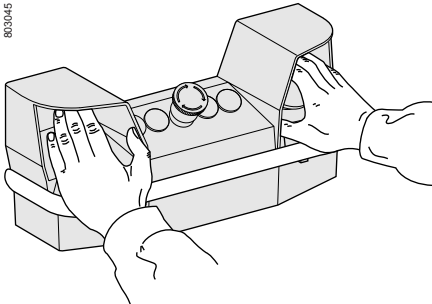
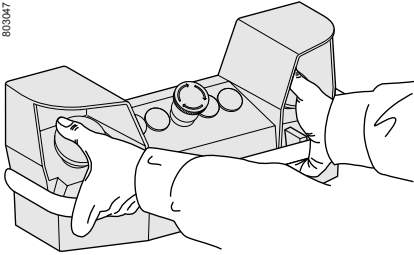

The design of the control station incorporates features to significantly reduce occupational illnesses associated with repetitive movements of the hands, particularly "carpal tunnel syndrome".

The health and comfort of the machine operator is assured by:

- the numerous alternative hand positions for operating the 2 pushbutton actuators, see diagrams to left,

- a hand rail,
- simple and fast adjustments of control station position.

This two-hand control station protects machine operators against both industrial accidents and illnesses related to their occupation.

It conforms to the following European safety standards:

- EN 574/ISO 13851 (two-hand control),
- EN 999 (approach speeds of parts of the human body and positioning of safety devices).

The control station can be mounted:

- directly on the machine housing,
- on a pedestal, enabling 3 directional adjustment:
  - height,
  - rake,
  - skew.

The use of a two-hand control station in conjunction with a safety module type XPS BCE or XPS BF provides type IIIC two-hand control conforming to EN 574/ISO 13851 and PL e / Category 4 according to EN/ISO 13859-1.

The range comprises:

- two-hand control stations with or without pre-wired terminal blocks,
- kits (control station + pedestal), with or without pre-wired terminal blocks.

The products are supplied with an installation manual, which is also available as a separate item.

3

### Description

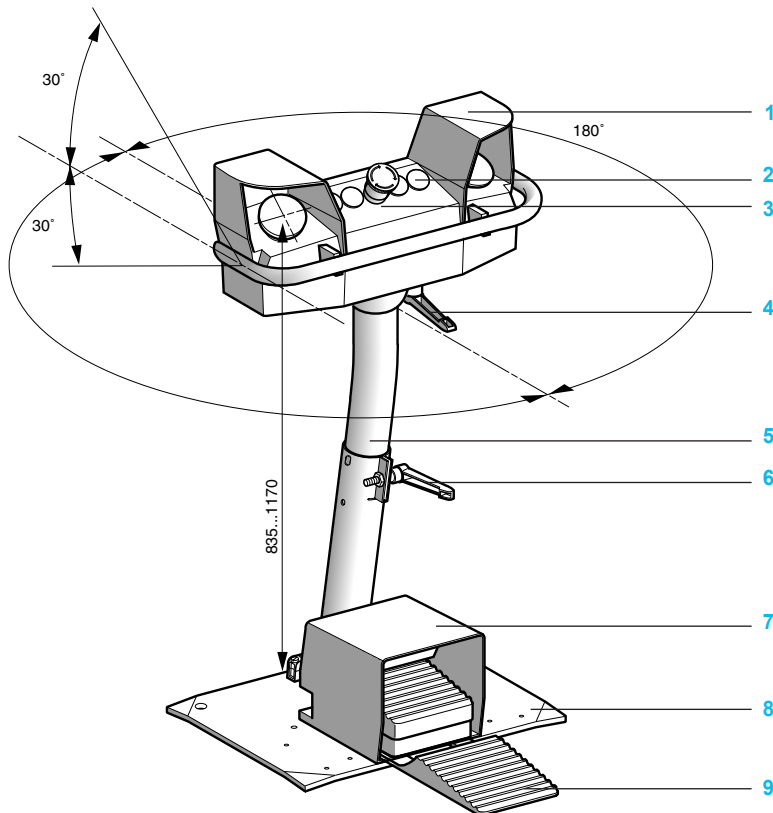

The control station **1** has five cut-outs ( $\varnothing$  22 mm) **2** as standard. Five additional cut-outs are possible **3**. Its pedestal **5** enables the following quick and simple adjustments:

- Control station rake ( $\pm 30^\circ$ ) using handle **4**.
- Control station skew ( $\pm 180^\circ$ ) using handle **6**.
- Control station height (835 to 1170 mm) using handle **6**.

The baseplate **8** can be fitted with safety foot switches XPE R **9**, together with their protective covers **7**.

### Characteristics

<b>Environment</b>				EN/IEC 60947-5-1, EN 574/ISO 13851
<b>Conformity to standards</b>				PL e, category 4 conforming to EN/ISO 13849-1 and SIL 3 conforming to EN/IEC 61508
<b>Maximum safety level (1)</b>				25,000,000 (data value for a service life of 10 years: can be limited by contact and mechanical wear)
<b>Reliability data B10d</b>		Contact block Harmony XB4B		Orange RAL 2008
<b>Colour</b>				"TC"
<b>Protective treatment</b>				- 25...+ 70
<b>Ambient air temperature</b>		For operation	°C	- 40...+ 70
		For storage	°C	
<b>Vibration resistance</b>		Conforming to EN/IEC 60068-2-6		5 gn (2...500 Hz)
<b>Shock resistance</b>		Conforming to EN/IEC 60068-2-27		10 gn (duration 11 ms)
<b>Electric shock protection</b>		Conforming to EN/IEC 61140		Class I
<b>Degree of protection</b>		Conforming to EN/IEC 60529		IP 65
<b>Mechanical life</b>		Number of operating cycles		1 million
<b>Contact block characteristics</b>				
<b>Rated operational characteristics</b>		~ AC-15		A600 or Ue = 240 V and Ie = 3 A
		≡ DC-13		Q600 or Ue = 250 V and Ie = 0.27 A conforming to EN/IEC 60947-5-1 Appendix A
<b>Rated insulation voltage</b>		Conforming to EN/IEC 60947-1	V	Ui = 600, degree of pollution 3
		Conforming to UL 508 and CSA C22-2 n° 14	V	Ui = 600
<b>Rated impulse withstand voltage</b>		Conforming to EN/IEC 60947-1	kV	Uimp = 6
<b>Contact operation</b>		Slow break, with positive opening operation		N/C + N/O break before make on each black actuator pushbutton N/C + N/C simultaneous on Emergency stop pushbutton N/C + N/O break before make on Lock out pushbutton
<b>Positive operation</b>		Conforming to EN/IEC 60947-5-1 Appendix K		N/C contact with positive opening operation
<b>Terminal referencing</b>				Conforming to CENELEC EN 50013
<b>Short-circuit protection</b>		Conforming to EN/IEC 269		10 A cartridge fuse type gG (gl)
<b>Connection</b>		Screw clamp terminals	mm <sup>2</sup>	Minimum clamping capacity: 1 x 0.22 or 1 x 0.22 + 1 x 0.34 Maximum clamping capacity: 1 x 2.5 or 2 x 1.5
<b>Electrical durability</b>		Conforming to EN/IEC 60947-5-1 Appendix C	V	24
		a.c. supply for 1 million operating cycles utilisation category AC-15	A	120
			A	4
			V	24
		d.c. supply for 1 million operating cycles utilisation category DC-13	A	110
			A	0.5
<b>Electrical reliability</b>		Failure rate According to EN/IEC 60947-5-4		At 17 V and 5 mA, $\lambda < 10^{-8}$ At 5 V and 1 mA, $\lambda < 10^{-6}$

(1) Using an appropriate and correctly connected control system.

# Acquire the information

## Two-hand ergonomic control stations

### With Harmony XB4 B control units



XY2SB7●

3

#### Two-hand control stations - painted

Description	Mushroom head		Reference	Weight kg
	Function and colour	Contacts		
2 control pushbuttons with N/C + N/O break before make contacts and 1 mushroom head pushbutton	Emergency stop Red	N/C + N/C slow break	XY2SB71	4.000
	Lock out (Schalt Sperre) Yellow	N/C + N/O break before make		
2 control pushbuttons with N/C + N/O break before make contacts and 1 mushroom head pushbutton, with pre-wired terminal block	Emergency stop Red	N/C + N/C slow break	XY2SB72	4.000
	Lock out (Schalt Sperre) Yellow	N/C + N/O break before make		

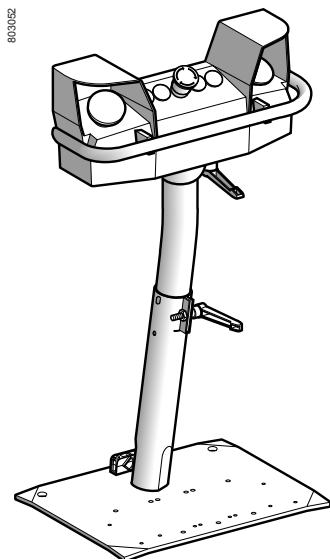

XY2SB7●4

#### Kits (control station + pedestal)

Description	Mushroom head		Reference	Weight kg
	Function and colour	Contacts		
2 control pushbuttons and 1 mushroom head Emergency stop pushbutton + pedestal XY2SB90	Emergency stop Red	N/C + N/C slow break	XY2SB714	17.000
	Emergency stop Red	N/C + N/C slow break		
2 control pushbuttons and 1 mushroom head Emergency stop pushbutton, with pre-wired terminal block + pedestal XY2SB90	Emergency stop Red	N/C + N/C slow break	XY2SB724	17.000
	Emergency stop Red	N/C + N/C slow break		

#### Documentation

Description	For use with	Reference	Weight kg
Installation manual	All control stations XY2SB7●●	XCOM2514	0.200

# Acquire the information

## Two-hand ergonomic control stations

### With Harmony XB4 B control units

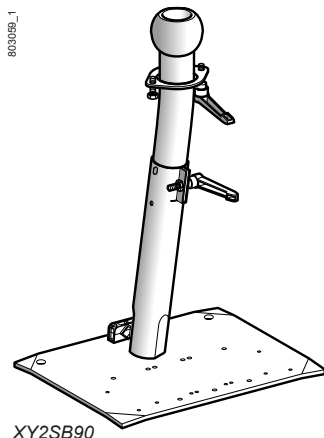

XY2SB90



XY2SB98

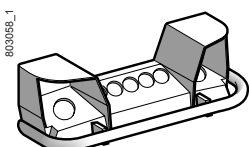

XY2SB511



XY2SB99

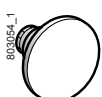

ZB4 BR216



ZB4 BS844



ZB4 BS845S

### Separate components and spare parts

#### Various accessories

Description	For use with	Colour	Unit reference	Weight kg
<b>Metal pedestal adjustable height</b>	XY2SB●●	Orange	<b>XY2SB90</b>	13.000
<b>Collar for guard rail (welded fixing)</b>	XY2SB90	Orange	<b>XY2SB98</b>	0.800
<b>Control station top without control devices</b>	–	Orange	<b>XY2SB511</b>	2.500
<b>Control station base</b>	–	Orange	<b>XY2SB531</b>	1.200
<b>Double protective metal cover</b>	Metal pedestal XY2SB90 and foot switches type XPE R	Orange	<b>XY2SB96</b>	4.370
<b>Replacement handle (sold in lots of 5)</b>	Metal pedestal XY2SB90	Black	<b>XY2SB93</b>	0.155
<b>Replacement seals</b>	–	–	<b>XY2SB99</b>	0.300
<b>Adaptor (sold in lots of 5)</b>	ISO M25	–	<b>DE9RA2125</b>	0.010

<b>Fixing nut (sold in lots of 5)</b>	Adaptor	–	<b>DE9EC21</b>	0.005
---------------------------------------	---------	---	----------------	-------

#### Control units (1)

Description	Component part	Colour	Reference	Weight kg
<b>Pushbutton actuator</b>	Ø 60 mm mushroom head	Black	<b>ZB4BR216</b>	0.095
	N/C + N/O body/contact assembly	–	<b>ZB4BZ105</b>	0.055
<b>Emergency stop pushbutton</b>	Ø 40 mm mushroom head	Red	<b>ZB4BS844</b>	0.060
	N/C + N/C body/contact assembly	–	<b>ZB4BZ104</b>	0.055
<b>Lock out pushbutton</b>	Ø 40 mm mushroom head	Yellow, marked "Schaltsperr"	<b>ZB4BS845S</b>	0.060
	N/C + N/O body/contact assembly	–	<b>ZB4BZ105</b>	0.055

(1) Other XB4 B control and signalling units are suitable for use on the control stations. Please refer to our "Human Machine Interface catalogue".

## Aquire the information

Complementary safety products  
Safety light curtains  
Emergency stop rope pull switches  
Safety switches

3



# Acquire the information

Complementary safety products  
Safety light curtains  
Emergency stop rope pull switches  
Safety switches

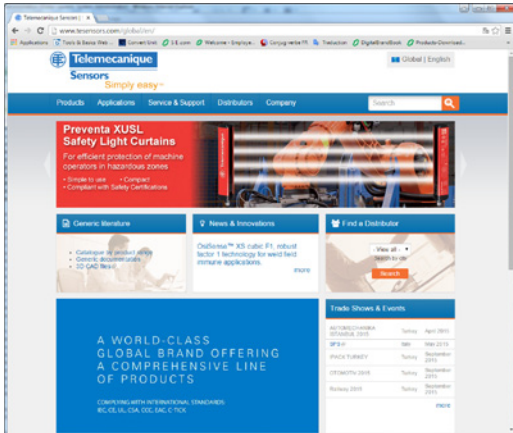

Schneider Electric recommends his partner **Telemecanique Sensors**, which proposes few ranges of safety products:

- > Please discover this offer on the web site: <http://www.tesensors.com/global>
- > Access to the catalog by product at this URL: <http://www.tesensors.com/global/en/product/catalog/>

## Safety light curtains Preventa XUSL

Catalogue



## Emergency stop rope pull switches Preventa XY2C

Catalogue



## Safety switches Preventa XCS

Catalogue



# Monitor and Processing

## Preventa safety modules

Applications

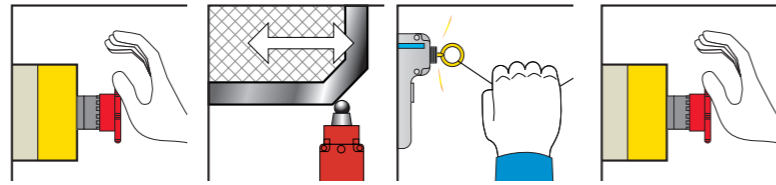

For Emergency stop and switch monitoring

For Emergency stop and protective guard applications

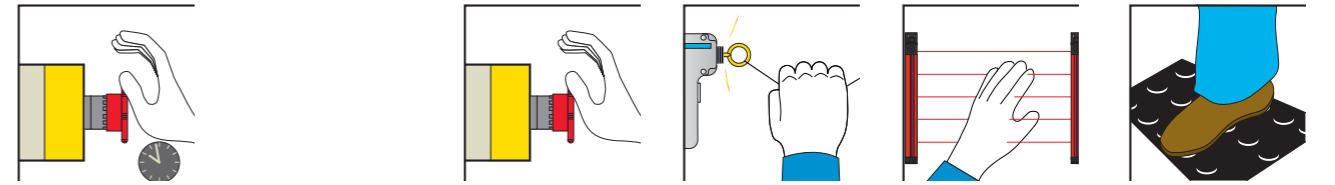

For Emergency stop and switch monitoring

For Emergency stop, switch or solid-state output safety light curtain monitoring

For Emergency stop, switch, sensing mat/edges or solid-state output safety light curtain monitoring



<b>Maximum achievable safety level</b>	PLe/Category 4 conforming to EN/ISO 13849-1, SILCL3 conforming to EN/IEC 61508 and EN/IEC 62061			
<b>Conformity to standards</b>	EN/IEC 60204-1, EN 1088/ISO 14119, EN/ISO 13850, EN/IEC 60947-1, EN/IEC 60947-5-1			
<b>Product certifications</b>	UL, CSA, TÜV			

PLe/Category 4 conforming to EN/ISO 13849-1, SILCL3 conforming to EN/IEC 61508 and EN/IEC 62061	PLe/Category 4 conforming to EN/ISO 13849-1, SILCL3 conforming to EN/IEC 61508 and EN/IEC 62061	PLe/Category 4 (instantaneous safety outputs) and PLd/Category 3 (time delay safety outputs) conforming to EN/ISO 13849-1, SILCL3 (instantaneous safety outputs) and SILCL2 (time delay safety outputs) conforming to EN/IEC 61508 and EN/IEC 62061	PLe/Category 4 conforming to EN/ISO 13849-1, SILCL3 conforming to EN/IEC 62061
EN/IEC 60204-1, EN 1088/ISO 14119, EN/ISO 13850, EN/IEC 60947-1, EN/IEC 60947-5-1	EN/IEC 60204-1, EN 1088/ISO 14119, EN/ISO 13850, EN/IEC 60947-1, EN/IEC 60947-5-1	EN/IEC 60204-1, EN/ISO 13850, EN 1088/ISO 14119, EN/IEC 60947-1, EN/IEC 60947-5-1	EN 62061, EN ISO 13849-1, EN 50156-1, EN 60204-1, EN/IEC 61496-1, EN/IEC 60947-5-1
UL, CSA, TÜV	UL, CSA, BG	UL, CSA, TÜV	UL, CSA, TÜV

<b>Number of circuits</b>	Safety	3 NO	3 NO	2 NO instantaneous + 3 NO time delay	3 NO instantaneous + 3 NO time delay
	Additional	1 solid-state output for signalling to PLC	1 relay output for signalling to PLC	4 solid-state outputs for signalling to PLC	1 NC
<b>Display</b>	2 LEDs				
<b>Supply voltage</b>	~ and 24 V $\overline{\text{---}}$ 48 V $\sim$ 115 V $\sim$ 230 V $\sim$				

3 NO	3 NO	2 NO instantaneous + 3 NO time delay	3 NO instantaneous + 3 NO time delay
1 solid-state output for signalling to PLC	1 relay output for signalling to PLC	4 solid-state outputs for signalling to PLC	1 NC
2 LEDs	2 LEDs	4 LEDs	5 LEDs
~ and 24 V $\overline{\text{---}}$ 48 V $\sim$ 115 V $\sim$ 230 V $\sim$			

<b>Synchronisation time between inputs</b>	Unlimited	Unlimited	75 ms (automatic start)	1
<b>Input channel voltage</b>	24 V $\overline{\text{---}}$ / $\overline{\text{---}}$ 48 V $\sim$ 115 V $\sim$ /230 V $\sim$			
<b>Module type</b>	<b>XPSAC</b>	<b>XPSAXE</b>	<b>XPSATE</b>	<b>XPSATR</b>
<b>Pages</b>	3/74	3/74	3/75	3/76

Unlimited or 1.5 s (depending on wiring)	Unlimited	Unlimited	Unlimited or 2 s, 4 s (depending on wiring)
24 V $\overline{\text{---}}$ / $\overline{\text{---}}$	24 V $\overline{\text{---}}$ / $\overline{\text{---}}$	$\overline{\text{---}}$ 24 V/ $\overline{\text{---}}$	24 V $\overline{\text{---}}$ / $\overline{\text{---}}$
–	–	–	–
<b>XPSAV</b>	<b>XPSABV</b>	<b>XPSAF</b>	<b>XPSAK</b>
3/75	3/75	3/77	3/80

PLe/Category 4 conforming to EN/ISO 13849-1, SILCL3 conforming to EN/IEC 61508 and EN/IEC 62061	PLe/Category 4 (instantaneous safety outputs) and PLd/Category 3 (time delay safety outputs) conforming to EN/ISO 13849-1, SILCL3 (instantaneous safety outputs) and SILCL2 (time delay safety outputs) conforming to EN/IEC 61508 and EN/IEC 62061	PLe/Category 4 conforming to EN/ISO 13849-1, SILCL3 conforming to EN/IEC 61508 and EN/IEC 62061	PLe/Category 4 conforming to EN/ISO 13849-1, SILCL3 conforming to EN/IEC 61508 and EN/IEC 62061	PLe/Category 4 conforming to EN/ISO 13849-1, SILCL3 conforming to EN/IEC 61508 and EN/IEC 62061	PLe/Category 4 conforming to EN/ISO 13849-1, SILCL3 conforming to EN/IEC 61508 and EN/IEC 62061
EN/IEC 60204-1, EN 1088/ISO 14119, EN/ISO 13850, EN/IEC 60947-1, EN/IEC 60947-5-1	EN/IEC 60204-1, EN/IEC 60947-1, EN/ISO 13850, EN/ISO 13850, EN/IEC 60947-1, EN 1088/ISO 14119	EN/IEC 60204-1, EN 1088/ISO 14119, EN/ISO 13850, EN/IEC 60947-1, EN/IEC 60947-5-1	EN/IEC 60204-1, EN 1088/ISO 14119, EN/ISO 13850, EN/IEC 60947-1, EN/IEC 60947-5-1, EN/IEC 61496-1 (type 4)	EN/IEC 60204-1, EN 1088/ISO 14119, EN/ISO 13850, EN/IEC 60947-1, EN/IEC 60947-5-1	EN/IEC 60204-1, EN 1088/ISO 14119, EN/ISO 13850, EN/IEC 60947-1, EN/IEC 60947-5-1
UL, CSA, TÜV	UL, CSA, BG	UL, CSA, TÜV	UL, CSA, TÜV	UL, CSA, TÜV	UL, CSA, TÜV

3 NO instantaneous + 3 NO time delay	2 NO instantaneous + 1 NO time delay	3 NO	7 NO	3 NO instantaneous
3 solid-state outputs for signalling to PLC	–	–	2 NC + 4 solid-state outputs for signalling to PLC	1 NC + 4 solid-state outputs for signalling to PLC
11 LEDs	3 LEDs	3 LEDs	4 LEDs	4 LEDs
24 V $\overline{\text{---}}$	24 V $\overline{\text{---}}$	$\sim$ and 24 V $\overline{\text{---}}$	~ and 24 V $\overline{\text{---}}$ 115 V $\sim$ and 24 V $\overline{\text{---}}$ 230 V $\sim$ and 24 V $\overline{\text{---}}$	~ and 24 V $\overline{\text{---}}$ 48 V $\sim$ 110 V $\sim$ and 24 V $\overline{\text{---}}$ 120 V $\sim$ and 24 V $\overline{\text{---}}$ 230 V $\sim$ and 24 V $\overline{\text{---}}$



Applications

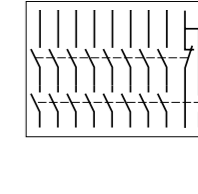
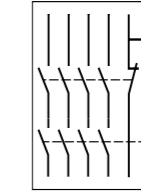
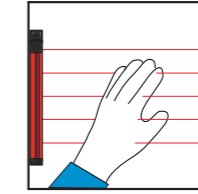
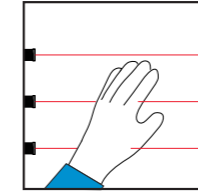
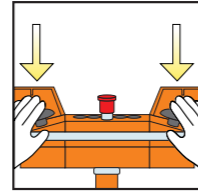
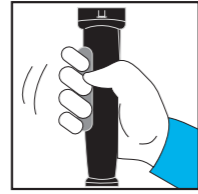

Modules	For enabling switch monitoring	For electrical monitoring of two-hand control stations			For control of 1 to 4 single-beam photo-electric sensors XU2 S (transmitter-receiver pair)	For monitoring type 2 and type 4 light curtains Compact and slim ranges	For extending the number of safety contacts		
---------	--------------------------------	--	--	--	--	---	---	--	--



Maximum achievable safety level	PLe/Category 4 conforming to EN/ISO 13849-1, SILCL3 conforming to EN/IEC 61508 and EN/IEC 62061	PLc/Category 1 conforming to EN/ISO 13849-1, SILCL1 conforming to EN/IEC 62061	PLe/Category 4 conforming to EN/ISO 13849-1, SILCL3 conforming to EN/IEC 61508 and EN/IEC 62061	PLe/Category 4 conforming to EN/ISO 13849-1, SILCL3 conforming to EN/IEC 61508 and EN/IEC 62061	PLc/Category 2 conforming to EN/ISO 13849-1, SILCL1 conforming to EN/IEC 61508 and EN/IEC 62061	PLe/Category 4 conforming to EN/ISO 13849-1, SILCL3 conforming to EN/IEC 61508 and EN/IEC 62061	PLe/Category 4 conforming to EN/ISO 13849-1, SILCL3 conforming to EN/IEC 61508 and EN/IEC 62061 (when connected to the appropriate module)	PLe/Category 4 conforming to EN/ISO 13849-1, SILCL3 conforming to EN/IEC 61508 and EN/IEC 62061 (when connected to the appropriate module)
Conformity to standards	EN/IEC 60204-1, EN 61326, EN/IEC 60947-1, EN/IEC 60947-5-1	EN 574 type III A, EN/IEC 60204-1, EN/IEC 60947-1, EN 62061	EN/IEC 60204-1, EN/IEC 60947-1, EN/IEC 60947-5-1, EN 574 type III C/ISO 13851	EN/IEC 60204-1, EN/IEC 60947-1, EN 574 type III C/ISO 13851	EN/IEC 61496-1, EN/IEC 61496-2, EN/IEC 60204-1, EN/IEC 60947-1, EN/IEC 60947-5-1	EN/IEC 61496-1, EN/IEC 61496-2, EN/IEC 60204-1, EN/IEC 60947-1, EN/IEC 60947-5-1	EN/IEC 60204-1, EN/IEC 60947-1, EN/IEC 60947-5-1	EN/IEC 60204-1, EN/IEC 60947-1, EN/IEC 60947-5-1
Product certifications	UL, CSA, TÜV	UL, CSA, TÜV	UL, CSA, BG	UL, CSA, TÜV	UL, CSA, IFA	UL, CSA, TÜV	UL, CSA, BG	UL, CSA, TÜV

Number of circuits	Safety	2 NO	1 NO	2 NO	2 NO	2 NO	2 solid-state	4 NO	8 NO
	Additional	2 solid-state outputs for signalling to PLC	1 NC	1 NC	2 solid-state outputs for signalling to PLC	4 solid-state PNP NO outputs for signalling to PLC	1 PNP + 1 NPN output for signalling to PLC	2 NC	1 NC
Display	3 LEDs	2 LEDs	3 LEDs	3 LEDs	4 LEDs	14 LEDs + 2-digit display	2 LEDs	3 LEDs	
Supply voltage	24 V $\dots$	$\sim$ and 24 V $\dots$ 115/230 V $\sim$	$\sim$ and 24 V $\dots$ 115/120 V $\sim$ 230 V $\sim$	24 V $\dots$	24 V $\dots$	24 V $\dots$	$\sim$ and 24 V $\dots$	$\sim$ and 24 V $\dots$ 115 V $\sim$ 230 V $\sim$	
Synchronisation time between inputs	–	500 ms	500 ms	500 ms	–	3 s or infinite	–	–	
Input channel voltage	24 V/48 V version	24 V $\dots$	24 V $\dots$	24 V $\dots$	–	–	–	–	
	115 V/230 V version	–	24 V $\sim$ /24 V	–	–	–	–	–	

Module type	<b>XPSVC</b>	<b>XPSBAE</b>	<b>XPSBCE</b>	<b>XPSBF</b>	<b>XPSCM</b>	<b>XPSLCM</b>	<b>XPSECME</b>	<b>XPSECPE</b>
-------------	--------------	---------------	---------------	--------------	--------------	---------------	----------------	----------------

Pages	3/81	3/82	3/82	3/82	3/83	3/84	3/85	3/85
-------	------	------	------	------	------	------	------	------

Applications

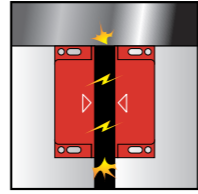
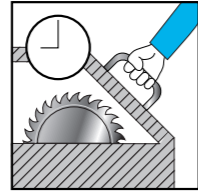

**Modules**

For the monitoring of applications requiring safety time delays

For coded magnetic switch monitoring

For 2 max.

For 6 max.

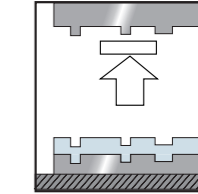
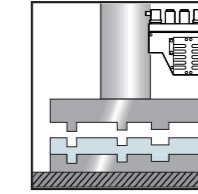
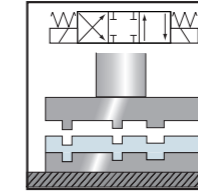
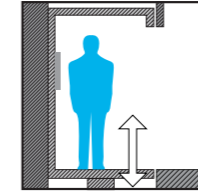
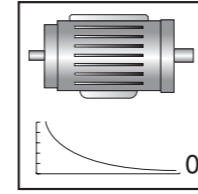

For zero speed detection of AC or DC motors which produce a remanent voltage in their windings due to residual magnetism

For lift control

For dynamic monitoring of hydraulic valves on linear presses

For dynamic monitoring of double-bodied solenoid valves

For safety stop at top dead centre with automatic overtravel monitoring and control



<b>Maximum achievable safety level</b>	PL d/Category 3 conforming to EN/ISO 13849-1, SILCL 2 conforming to EN/IEC 62061	PL d/Category 3 conforming to EN/ISO 13849-1, SILCL 2 conforming to EN/IEC 62061	PL e/Category 4 conforming to EN/ISO 13849-1 SILCL 3 conforming to EN/IEC 62061	PL e/Category 4 conforming to EN/ISO 13849-1 SILCL 3 conforming to EN/IEC 62061
<b>Conformity to standards</b>	EN/IEC 60204-1, EN/IEC 60947-1, EN/IEC 60947-5-1	EN/IEC 60204-1, EN/IEC 60947-1, EN/IEC 60947-5-1	EN/IEC 60204-1, EN 1088/ISO 14119, EN/IEC 60947-1, EN/IEC 60947-5-1, EN/IEC 60947-5-3	EN/IEC 60204-1, EN 1088/ISO 14119, EN/IEC 60947-1, EN/IEC 60947-5-1, EN/IEC 60947-5-3
<b>Product certifications</b>	UL, CSA, TÜV	UL, CSA, TÜV	UL, CSA, TÜV	UL, CSA, TÜV

<b>Number of circuits</b>	Safety	1 NO time delayed	1 NO pulse type	2 NO
	Additional	2 NC + 2 solid-state outputs for signalling to PLC		2 solid-state outputs for signalling to PLC
<b>Display</b>	4 LEDs		3 LEDs	15 LEDs
<b>Supply voltage</b>	~ and 24 V $\overline{\text{---}}$ 115 V $\sim$ 230 V $\sim$		$\overline{\text{---}}$ 24 V	

<b>Synchronisation time between inputs</b>	–	–	500 ms
--	---	---	--------

<b>Module type</b>	<b>XPSTSA</b>	<b>XPSTSW</b>	<b>XPSDMB</b>	<b>XPSDME</b>
--------------------	---------------	---------------	---------------	---------------

<b>Pages</b>	3/86	3/86	3/87	3/87
--------------	------	------	------	------

PL d/Category 3 conforming to EN/ISO 13849-1, SILCL 2 conforming to EN/IEC 62061,	PL e/Category 4 conforming to EN/ISO 13849-1, SILCL 3 conforming to EN/IEC 62061	PL e/Category 4 conforming to EN/ISO 13849-1, SILCL 3 conforming to EN/IEC 62061	PL e/Category 4 conforming to EN/ISO 13849-1, SILCL 3 conforming to EN/IEC 62061	PL e/Category 4 conforming to EN/ISO 13849-1, SILCL 3 conforming to EN/IEC 62061
EN/IEC 60204-1, EN/IEC 60947-1, EN/IEC 60947-5-1	EN 81-1, EN 81-2, EN/IEC 60947-5-1, EN 12015, EN 12016	EN 693, EN/IEC 60204-1, EN/IEC 60947-1, EN/IEC 60947-5-1	EN 692, EN/IEC 60204-1, EN/IEC 60947-1, EN/IEC 60947-5-1	EN 692, EN/IEC 60204-1, EN/IEC 60947-1, EN/IEC 60947-5-1
UL, CSA, TÜV	TÜV	UL, CSA, TÜV	UL, CSA, TÜV	UL, CSA, TÜV

1 NO + 1 NC	2 NO	2 NO + 1 NC	1 NO + 1 NC	3 NO
2 solid-state outputs for signalling to PLC		–	4 solid-state outputs for signalling to PLC	
4 LEDs	4 LEDs	8 LEDs		
24 V $\overline{\text{---}}$ 115 V $\sim$ 230 V $\sim$	$\sim$ and 24 V $\overline{\text{---}}$	24 V $\overline{\text{---}}$	24 V $\overline{\text{---}}$ 115 V $\sim$ 230 V $\sim$	– 115 V $\sim$ 230 V $\sim$

–	Infinite	–	–	–
---	----------	---	---	---

<b>XPSVNE</b>	<b>XPSEDA</b>	<b>XPSPVT</b>	<b>XPSPVK</b>	<b>XPSOT</b>
---------------	---------------	---------------	---------------	--------------

3/88	3/89	3/90	3/91	3/93
------	------	------	------	------

# Monitor and Processing

## Preventa safety modules types XPSAC, XPSAXE

For Emergency stop and switch monitoring

### Operating principle

Safety modules **XPSAC** and **XPSAXE** are used for monitoring Emergency stop circuits conforming to standards EN/ISO 13850 and EN/IEC 60204-1 and also meet the safety requirements for the electrical monitoring of switches in protective devices conforming to standard EN/ISO 14119. They provide protection for both the machine operator and the machine by immediately stopping the dangerous movement on receipt of a stop instruction from the operator, or on detection of a fault in the safety circuit itself.

To aid diagnostics, the modules have LEDs which provide information on the monitoring circuit status.

- The **XPSAC** module has 3 safety outputs and a solid-state output for signalling to the PLC.
- The **XPSAXE** module has 3 safety outputs and a relay output for signalling to the PLC

3

### References

Description	Connection	Number of instantaneous opening safety circuits	Additional outputs	Supply	Reference	Weight kg/lb
Safety modules for Emergency stop and switch monitoring	Captive screw clamp terminals Terminal block integrated in module	3	1 solid-state	~ and ≡ 24 V	<b>XPSAC5121</b>	0.160/ 0.353
				~ 48 V	<b>XPSAC1321</b>	0.210/ 0.463
				~ 115 V	<b>XPSAC3421</b>	0.210/ 0.463
				~ 230 V	<b>XPSAC3721</b>	0.210/ 0.463
	Captive screw clamp 3 terminals Terminal block removable from module	3	1 solid-state	~ and ≡ 24 V	<b>XPSAC5121P</b>	0.160/ 0.353
				~ 48 V	<b>XPSAC1321P</b>	0.210/ 0.463
				~ 115 V	<b>XPSAC3421P</b>	0.210/ 0.463
				~ 230 V	<b>XPSAC3721P</b>	0.210/ 0.463
			1 relay	~ and ≡ 24 V	<b>XPSAXE5120P</b>	0.229/ 0.505
	Spring terminals Terminal block removable from module	3	1 relay	~ and ≡ 24 V	<b>XPSAXE5120C</b>	0.229/ 0.505



XPSAC●●●●



XPSAC●●●●P



XPSAXE5120P



XPSAXE5120C

### Operating principle

Safety modules **XPSAV**, **XPSABV** and **XPSATE** are used for monitoring Emergency stop circuits conforming to standards EN/ISO 13850 and EN/IEC 60204-1 and also meet the safety requirements for the electrical monitoring

of switches in protection devices conforming to standard EN/ISO 14119.

They provide protective for both the machine operator and the machine by immediately stopping the dangerous movement on receipt of a stop instruction from the operator, or on detection of a fault in the safety circuit itself.

In addition to the stop category 0 instantaneous opening safety outputs (3 for **XPSAV**, 2 for **XPSABV** and 2 for **XPSATE**), the modules incorporate stop category 1 time delay outputs (3 for **XPSAV**, 1 for **XPSABV** and 3 for **XPSATE**) which allow for controlled deceleration of the motor components until a complete stop is achieved (for example, motor braking by variable speed drive).

At the end of the preset delay, the supply is disconnected by opening the time delay output circuits.

- For module **XPSAV**, the time delay of the 3 output circuits is adjustable, in 15 preset values, between 0 and 300 seconds using selector buttons.

- For module **XPSABV**, the time delay of the 3 output circuits is adjustable between 0.15 and 3 seconds or 1.5 and 30 seconds, depending on the model, using a selector switch.

- For module **XPSATE**, the time delay of the 3 output circuits is adjustable between 0 and 30 seconds using a 12-position selector switch.

Module **XPSAV** also incorporates 3 solid-state signalling outputs for signalling to the process PLC.

Module **XPSATE** incorporates 4 solid-state signalling outputs for signalling to the process PLC.

To aid diagnostics, the modules have LEDs which provide information on the monitoring circuit status.

The Start button monitoring function is configurable depending on the wiring.

### References

Description	Connection	Number of safety circuits	Additional outputs	Setting range of time delay	Supply	Reference	Weight kg/lb
<b>Safety modules for Emergency stop and switch monitoring</b>	Captive screw clamp terminals Terminal block integrated in module	6 NO (3 NO time delay)	3 solid-state	0...300 s	~ 24 V	<b>XPSAV11113</b>	0.320/ 0.705
	Captive screw clamp terminals Terminal block removable from module	6 NO (3 NO time delay)	3 solid-state	0...300 s	~ 24 V	<b>XPSAV11113P</b>	0.320/ 0.705
	Captive screw clamp terminals Terminal block integrated in module	6 NO (3 NO time delay)	3 solid-state	0...300 s (Start delay 0,5 s)	~ 24 V	<b>XPSAV11113T050</b>	0.320/ 0.705
	Captive screw clamp terminals Terminal block integrated in module	6 NO (3 NO time delay)	3 solid-state	0.1 ...2 s	~ 24 V	<b>XPSAV11113Z002</b>	0.320/ 0.705
	Captive screw clamp terminals Terminal block removable from module	3 NO (1 NO time delay)	–	0,15...3 s	~ 24 V	<b>XPSABV1133P</b>	0.280/ 0.617
	Spring terminals Terminal block removable from module	3 NO (1 NO time delay)	–	0,15...3 s	~ 24 V	<b>XPSABV1133C</b>	0.275/ 0.606
	Captive screw clamp terminals Terminal block removable from module	3 NO (1 NO time delay)	–	1,5...30 s	~ 24 V	<b>XPSABV11330P</b>	0.280/ 0.617
	Spring terminals Terminal block removable from module	3 NO (1 NO time delay)	–	1,5...30 s	~ 24 V	<b>XPSABV11330C</b>	0.275/ 0.606
	Captive screw clamp terminals Terminal block integrated in module	5 NO (3 NO time delay)	4 solid-state	0...30 s	~ and ~ 24 V	<b>XPSATE5110</b>	0.280/ 0.617
	Captive screw clamp terminals Terminal block removable from module	5 NO (3 NO time delay)	4 solid-state	0...30 s	~ and ~ 24 V	<b>XPSATE5110P</b>	0.280/ 0.617
	Captive screw clamp terminals Terminal block integrated in module	5 NO (3 NO time delay)	4 solid-state	0...30 s	~ 115 V	<b>XPSATE3410</b>	0.380/ 0.838
	Captive screw clamp terminals Terminal block removable from module	5 NO (3 NO time delay)	4 solid-state	0...30 s	~ 115 V	<b>XPSATE3410P</b>	0.380/ 0.838
Captive screw clamp terminals Terminal block integrated in module	5 NO (3 NO time delay)	4 solid-state	0...30 s	~ 230 V	<b>XPSATE3710</b>	0.380/ 0.838	
Captive screw clamp terminals Terminal block removable from module	5 NO (3 NO time delay)	4 solid-state	0...30 s	~ 230 V	<b>XPSATE3710P</b>	0.380/ 0.838	



XPSAV11113



XPSAV11113P



XPSABV1133P



XPSABV11330C



XPSATE5110

### Operating principle

Safety modules **XPSATR** meet the requirements of Performance Level PL e/Category 4 conforming to standard EN ISO 13849-1.

Safety modules **XPSATR** are electronic, redundant and self-monitoring devices with positively driven relays.

They are used for monitoring Emergency stop circuits (single or two-channel) and protective guard applications.

The modules are conforming to standards EN/ISO 13850 and EN 60204-1.

They provide protection for both the machine operator and the machine by immediately stopping the dangerous movement on receipt of a stop instruction from the operator, or on detection of a fault in the safety circuit itself.

**XPSATR** incorporate 3 NO and 1 NC not delayed contacts and 3 delayed NO contacts.

To aid diagnostics, the modules have 5 LEDs on the front face which provide information on the monitoring circuit status.

### References

Description	Connection	Number of safety circuits	Additional outputs	Time setting range	Supply	Reference	Weight kg/lb
Safety modules for emergency stop and safety guards monitoring	Captive screw clamp terminals Terminal block removable from module	3 NO + 3 NO time delay	1 NC	0.1...3 s	≡ 24 V	<b>XPSATR1153P</b>	0.330/ 0.728
				0.1...3 s	~ 115...230 V	<b>XPSATR3953P</b>	0.350/ 0.772
				0...30 s	≡ 24 V	<b>XPSATR11530P</b>	0.330/ 0.728
				0...30 s	~ 115...230 V	<b>XPSATR39530P</b>	0.350/ 0.772
	Cage clamp terminals Terminal block removable from module	3 NO + 3 NO time delay	1 NC	0.1...3 s	≡ 24 V	<b>XPSATR1153C</b>	0.330/ 0.728
				0.1...3 s	~ 115...230 V	<b>XPSATR3953C</b>	0.350/ 0.772
				0...30 s	≡ 24 V	<b>XPSATR11530C</b>	0.330/ 0.728
				0...30 s	~ 115...230 V	<b>XPSATR39530C</b>	0.350/ 0.772



XPSATR●●●●P



XPSATR●●●●C

# Monitor and Processing

## Preventa safety modules type XPSAF

### For Emergency stop and switch monitoring

#### Operating principle

Safety modules **XPSAF** meet the requirements of Performance Level PL e/Category 4 conforming to standard EN/ISO 13849-1.

They are used for:

- Monitoring Emergency stop circuits conforming to standards EN/ISO 13850 and EN/IEC 60204-1.
- Electrical monitoring of switches activated by protection devices conforming to standard EN/ISO 14119.

Housed in a compact enclosure, the modules have 3 safety outputs.

Preventa safety modules **XPSAF●●●●P** incorporate removable terminal blocks, thus optimising machine maintenance.

To aid diagnostics, the modules have 3 LEDs on the front face which provide information on the monitoring circuit status.

The Start button monitoring function is configurable depending on the wiring.

3

#### References

Description	Connection	Number of safety circuits	Supply	Reference	Weight kg/ lb
Safety modules for Emergency stop and switch monitoring	Captive screw clamp terminals Terminal block integrated in module	3	~ and 24 V	<b>XPSAF5130</b>	0.250/ 0.551
	Captive screw clamp terminals Terminal block removable from module	3	~ and 24 V	<b>XPSAF5130P</b>	0.250/ 0.551



XPSAF5130

# Monitor and Processing

## Preventa safety modules type XPSAFL

For Emergency stop, switch and safety light curtain monitoring

### Operating principle

Safety modules **XPSAFL** meet the requirements of Performance Level PL e/Category 4 conforming to standard EN/ISO 13849-1.

They are used for:

- Monitoring Emergency stop circuits conforming to standards EN/ISO 13850 and EN/IEC 60204-1.
- Electrical monitoring of switches activated by protection devices conforming to standard EN/ISO 14119.

They can also be used for monitoring type 4 light curtains conforming to EN 61496-1 that have solid-state safety outputs (for example, light curtains type XUS L, see page 30304-EN/2). This system conforms to Performance Level PL e/Category 4 in accordance with EN/ISO 13849-1.

Housed in a compact enclosure, the modules have 3 safety outputs. Preventa safety modules **XPSAFL●●●P** incorporate removable terminal blocks, thus optimising machine maintenance. To aid diagnostics, the modules have 3 LEDs on the front face which provide information on the monitoring circuit status.

The Start button monitoring function is configurable depending on the wiring.

3

### References

Description	Connection	Number of safety circuits	Supply	Reference	Weight kg/lb
Safety modules for Emergency stop, switch and safety light curtain monitoring	Captive screw clamp terminals Terminal block integrated in module	3	~ and = 24 V	<b>XPSAFL5130</b>	0.250/ 0.551
	Captive screw clamp terminals Terminal block removable from module	3	~ and = 24 V	<b>XPSAFL5130P</b>	0.250/ 0.551



XPSAFL5130

# Monitor and Processing

## Preventa safety modules type XPSAR

For Emergency stop, switch or safety light curtain monitoring

### Operating principle

Safety modules **XPSAR** meet the requirements of Performance Level PL e/ Category 4 conforming to standard EN/ISO 13849-1 and are designed for the following safety applications:

- Monitoring Emergency stop circuits conforming to EN/ISO 13850 and EN/IEC 60204-1.
- Electrical monitoring of switches activated by protection devices conforming to standard EN/ISO 14119.
- Monitoring type 4 light curtains conforming to EN/IEC 61496-1 that have solid-state safety outputs with test function (light curtains XUS L).

In addition to 7 safety outputs, modules **XPSAR** incorporate 2 relay signalling outputs and 4 solid-state signalling outputs for signalling to the process PLC.

Safety modules **XPSAR●●●●●P** incorporate removable terminal blocks, thus optimising machine maintenance.

To aid diagnostics, the modules have 4 LEDs on the front face which provide information on the monitoring circuit status.

The Start button monitoring function is configurable depending on the wiring.

### References

Description	Connection	Number of safety circuits	Additional outputs/ solid-state outputs to PLC	Supply	Reference	Weight kg/ lb	
Safety modules for Emergency stop, switch or safety light curtain monitoring	Captive screw clamp terminals, Terminal block integrated in module	7	2/4	~ and ☐ 24 V	<b>XPSAR311144</b>	0.300/ 0.661	
				~ 115 V ☐ 24 V	<b>XPSAR351144</b>	0.400/ 0.882	
				~ 230 V ☐ 24 V	<b>XPSAR371144</b>	0.400/ 0.882	
	Captive screw clamp terminals, Terminal block removable from module	7	2/4		~ and ☐ 24 V	<b>XPSAR311144P</b>	0.300/ 0.661
					~ 115 V ☐ 24 V	<b>XPSAR351144P</b>	0.400/ 0.882
					~ 230 V ☐ 24 V	<b>XPSAR371144P</b>	0.400/ 0.882



XPSAR3●1144



# Monitor and Processing

## Preventa safety modules type XPSAK

For Emergency stop, switch, sensing mat/edges or safety light curtain monitoring

### Operating principle

Safety modules **XPSAK** meet the requirements of Performance Level PL e/Category 4 conforming to standard EN/ISO 13849-1.

They are used for:

- Monitoring Emergency stop circuits conforming to standards EN/ISO 13850 and EN/IEC 60204-1.
- Electrical monitoring of switches activated by protection devices, with optional selection of synchronisation time between signals.
- Monitoring 4-wire sensing mats or edges.
- Monitoring type 4 light curtains conforming to EN/IEC 61496-1 which have solid-state safety outputs with test function (light curtains XUSL).

Housed in a compact enclosure, the modules have 3 safety outputs, a relay signalling output and 4 solid-state signalling outputs for signalling to the process PLC.

Preventa safety modules **XPSAK●●●●P** incorporate removable terminal blocks, thus optimising machine maintenance.

To aid diagnostics, the modules have 4 LEDs on the front face which provide information on the monitoring circuit status.

The Start button monitoring function is configurable depending on the wiring.

3

### References

Description	Connection	Number of safety circuits	Additional outputs / Solid-state outputs for PLC	Supply	Reference	Weight kg/ lb
Safety modules for Emergency stop, switch, sensing mat/edges or safety light curtain monitoring	Captive screw clamp terminals Terminal block integrated in module	3	1 / 4	~ and --- 24 V	<b>XPSAK311144</b>	0.300/ 0.661
				~ 110 V --- 24 V	<b>XPSAK361144</b>	0.400/ 0.882
				~ 120 V --- 24 V	<b>XPSAK351144</b>	0.400/ 0.882
				~ 230 V --- 24 V	<b>XPSAK371144</b>	0.400/ 0.882
	Captive screw clamp terminals Terminal block removable from module	3	1 / 4	~ and --- 24 V	<b>XPSAK311144P</b>	0.300/ 0.661
				~ 48 V	<b>XPSAK331144P</b>	0.300/ 0.661
				~ 110 V --- 24 V	<b>XPSAK361144P</b>	0.400/ 0.882
				~ 120 V --- 24 V	<b>XPSAK351144P</b>	0.400/ 0.882
				~ 230 V --- 24 V	<b>XPSAK371144P</b>	0.400/ 0.882



XPSAK3●1144

### Operating principle

The enabling grip switch system, comprising an enabling switch XY2AU and a monitoring module **XPSVC**, enables authorised personnel to carry out adjustment, programming or maintenance operations within hazardous zones of machines providing certain conditions are met.

To be accessible, such operations are often carried out at reduced speed, and must be intentionally selected by authorised persons by means of a selector switch or key switch. Once the selection is made, the enabling switch system temporarily takes over from the hazardous zone's usual protection measures.

Caution: The enabling switch system alone must not cause dangerous movements of the machine to be activated; a second intentional control action on the part of the operator is required. In addition, each person remaining in the hazardous zone must be provided with an individual enabling switch to ensure their own safety.



XPSVC1132

References						
Description	Connection	Number of safety circuits	Solid-state outputs for PLC	Supply	Reference	Weight kg/lb
Safety modules for enabling switch monitoring	Captive screw clamp terminals Terminal block integrated in module	2 NO	2	☰ 24	XPSVC1132	0.250/ 0.551
	Captive screw clamp terminals Terminal block removable from module	2 NO	2	☰ 24	XPSVC1132P	0.250/ 0.551

### Operating principle

Two-hand control stations are designed to provide protection against hand injury. They require machine operators to keep their hands clear of the dangerous movement zone. The use of two-hand control is an individual protective measure, which can safely protect only one operator. Separate two-hand control stations must be provided for each operator in a multiple-worker environment.

Safety modules **XPSBAE**, **BCE** and **BF** for two-hand control stations comply with the requirements of European standard EN 574/ISO 13851 for two-hand control systems.

The control stations must be designed and installed such that they cannot be activated involuntarily or easily rendered inoperative. Depending on the application, the requirements of type C standards specific to the machinery involved must be met (additional personal protection methods may have to be considered).

To initiate a dangerous movement, both operators (two-hand control pushbuttons) must be activated within an interval  $\leq 0.5$  s (synchronous activation). If one of the two pushbuttons is released during a dangerous operation, the control sequence is cancelled. Resumption of the dangerous operation is possible only if both pushbuttons are returned to their initial position and reactivated within the required time interval.

The safety distance between the control units and the hazardous zone must be sufficient to ensure that when only one operator is released, the hazardous zone cannot be reached before the dangerous movement has been completed or stopped.

3



XPSBAE●●●●P



XPSBAE●●●●C



XPSBCE●●●●P



XPSBCE●●●●C



XPSBF1132

### Selection

#### Requirements of standard EN 574/ISO 13851

Standard EN 574/ISO 13851 defines the selection of two-hand controls according to its behavior. The following table details the 3 types of two-hand control conforming to EN 574/ISO 13851. For each type, it lists the operating characteristics and minimum requirements.

	Type I	Type II	Type III		
			A	B	C
Use of both hands (simultaneous action)					
Link between input and output signals					
Output signal inhibited					
Prevention of accidental operation					
Tamper-proof					
Output signal reinitialised					
Synchronous action (specified time limit)					
Use of proven components (Category 1 conforming to EN/ISO 13849-1)			XPSBAE		
Redundancy with partial error detection (Category 3 conforming to EN/ISO 13849-1)				XPSBCE XPSBF	
Redundancy + Self-monitoring (Category 4 conforming to EN/ISO 13849-1)					XPSBCE XPSBF
Two-hand control station	XY2SB●●				

Conforming to standard EN/ISO 13849-1

Meets the requirements of standard EN 574/ISO 13851

### References

Description	Type conforming to standard EN 574	Connection	Number of safety circuits	Additional outputs	Supply	Reference	Weight kg/ lb
Safety modules for electrical monitoring of two-hand control stations	III A	Captive screw clamp terminals	1 NO	1 NC	~ and 24 V $\overline{\text{---}}$	XPSBAE5120P	0.100/ 0.220
		Terminal block removable from module			~ 115/230V	XPSBAE3920P	0.100/ 0.220
		Spring terminals	1 NO	1 NC	~ and 24 V $\overline{\text{---}}$	XPSBAE5120C	0.100/ 0.220
	III C	Terminal block removable from module			~ 115/230V	XPSBAE3920C	0.100/ 0.220
		Captive screw clamp terminals	2 NO	1 NC relay	~ and 24 V $\overline{\text{---}}$	XPSBCE3110P	0.272/ 0.600
		Terminal block removable from module			~ 115/120 V	XPSBCE3410P	0.322/ 0.710
				~ 230 V	XPSBCE3710P	0.322/ 0.710	
		Spring terminals	2 NO	1 NC relay	~ and 24 V $\overline{\text{---}}$	XPSBCE3110C	0.272/ 0.600
		Terminal block removable from module			~ 115 /120 V	XPSBCE3410C	0.322/ 0.710
					~ 230 V	XPSBCE3710C	0.322/ 0.710
		Captive screw clamp terminals	2 NO	2 solid-state	$\overline{\text{---}}$ 24 V	XPSBF1132	0.150/ 0.331
		Terminal block removable from module	2 NO	2 solid-state	$\overline{\text{---}}$ 24 V	XPSBF1132P	0.150/ 0.331

# Monitor and Processing

## Preventa safety modules and single-beam photo-electric sensors

With a test input associated with a built-in “muting” function

### Operating principle

XPSCM safety modules used in conjunction with XU2S single-beam photo-electric sensors (periodically tested), establish a category 2 light curtain conforming to IEC/EN 61496 parts 1 and 2.

The connection of 1 to 4 pairs of XU2S photo-electric sensors makes it possible to create a protected zone up to 1200 mm high conforming to EN 999/ISO 13855 and 8 m long.

The built-in “muting” function allows the automatic passage of parts to be machined, or loaded pallets, without interrupting the transportation movement.

When the system is switched on by the start command (in series with the main circuit feedback loop) and the light protection is not interrupted, the main circuit is closed by the two safety relays of the XPSCM module.

An interruption of the protective field causes the safety outputs to open instantaneously, and the process PLC receives a stop command. The LED on the XPSCM front panel changes from green to red. The “open” state is maintained until the module is restarted using the start button.

The “muting” function allows the light curtain protection to be inhibited. This can be used to authorise the passage of a materials trolley through the light curtain without tripping the main circuit. The “muting” function cannot be activated by supplying the inhibition sensors unless the safety outputs have been switched on beforehand.

To trigger the “muting” function, the inhibition devices must be activated within the 3 second time interval. This synchronisation time for the two inhibition inputs can be deactivated by connecting two configuration terminals. The “muting” cycle has a maximum duration of 60 seconds. During this period, materials can be transported through the protection field without deactivating the safety outputs. The 60 second limit value of the “muting” cycle may be made infinite by connecting two configuration terminals.

During the “muting” process, a light indicating the “muting” status is controlled by the XPSCM module. An fault at indicator light level (short-circuit, open circuit) will be immediately recognised and deactivate the “muting” function. The indicator light comes on when a “muting” signal is generated and indicates the inhibition of the protection function.

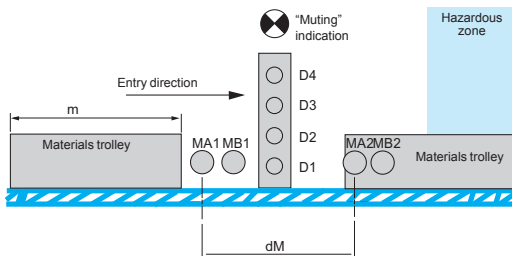

D1, D2, D3, D4: monitoring photo-electric sensors.  
MA1, MB1, MA2, MB2: “muting” photo-electric sensors.  
m = trolley length (including material)  
dM = distance between MA1, MB1 and MA2, MB2.

### Conditions to be observed for the “muting” function

- The “muting” sensors must either be:
  - Thru-beam type, sensing distance 8 m: XU2S18PP340L5 (or XU2S18PP340D).
  - Thru-beam type, sensing distance 15 m: XUB2BKSNL2T (or XUB2BKSNM12T) + XUB2BPANL2R (or XUB2BPANM12R).
  - Polarised reflex type, sensing distance 2 m: XUB9BPNAL2 (or XUB9BPNAM12) + XUZC50.
  - Polarised reflex type, sensing distance 5 m: XUM9APCNL2 (or XUM9APCNM8) or XUM9BPANL2 + XUZC50.
  - Limit switches.
- $dM \leq m$  to obtain continuous validation of the “muting” function.
- Avoid the intrusion of persons during the “muting” phase. This phase is indicated by the indicator light connected to the “muting” indicator output of the XPSCM module.
- A materials trolley must provide the “muting” signal before entering the protection field and cease it once it has cleared all the sensors of the protection field on exiting.

### References

Description	Type of terminal block connection	Number of safety circuits	Additional safety outputs	Supply	Reference	Weight kg/ lb
Safety modules for monitoring single-beam photo-electric sensors, with a built-in “muting” function	Integrated in module	2	4	24 V $\overline{\text{---}}$	XPSCM1144	0.350/ 0.772
	Removable from module	2	4	24 V $\overline{\text{---}}$	XPSCM1144P	0.350/ 0.772



XPSCM1144●

# Monitor and Processing

## Safety monitoring module

### Preventa XPSLCM

for the “muting” function of type 2 and type 4 safety light curtains

3

#### Operating principle

XPSLCM safety modules are used with type 4 light curtains conforming to EN/IEC 61496-1 to provide a system inhibiting the light curtain protection, i.e. “muting”. This function enables the automatic passage of parts for machining or loaded pallets, without interrupting the transportation movement within the zone protected by the electro-sensitive protection equipment (ESPE) system. In addition to the electro-sensitive protection and XPSLCM safety modules, the system comprises 4 to 8 inhibition sensors, 2 indicator lights and a key switch to reset the system to the initial state in the event of a sequence error.

When the system is switched on by the start command and the light curtain protection not interrupted, the main circuit is closed by the safety outputs of the XPSLCM modules (solid-state safety outputs). In addition to safety outputs, the modules incorporate signalling outputs for sending system status information to the PLC. Either 5 or 14 LEDs and a 2-digit display, mounted on the front face of the module, provide information on the safety circuit status.

An interruption of the protection field monitored by the electro-sensitive protection equipment causes instantaneous opening of the safety outputs; the process PLC receives a stop command and the LED display mounted on the front face indicates the change of state of the safety circuits. The “open” state is maintained until the module is restarted using the Start button.

The “muting” function cannot be activated by supplying the inhibition sensors unless the safety outputs have been switched on beforehand. To trigger the “muting” function, the inhibition devices must be activated within the 3 second time interval. During the activated “muting” phase, materials can be transported through the protection field without deactivating the safety outputs. In the event of intrusion into the hazardous zone, a person cannot activate the inhibition sensors in the same way and the system stops.

Whilst the “muting” function is activated, a “muting” status indicator light is controlled by the XPSLCM module. A fault at indicator light level (short-circuit, open circuit) is immediately recognised and deactivates the “muting” function. The indicator light only illuminates when a “muting” signal is generated and indicates the inhibition of the protection function.

#### Conditions to be observed for the “muting” function

- The “muting” sensors must either be:
  - Thru-beam type, sensing distance 15 m: XUM2APCNL2 (or XUM2APCNM8) or XUM2BPANL2 or XUM2BPNL2.
  - Polarised reflex type, sensing distance 5 m: XUM9APCNL2 (or XUM9APCNM8) or XUM9BPANL2 or XUM9BPNL2 + XUZC50.
  - Polarised reflex type, sensing distance 11 m: XUX9APANT16 (or XUX9APANM12) or XUX9APBNT16 (or XUX9APBNM12) + XUZC50.
  - Limit switches
- $dM \leq m$  to obtain continuous validation of the “muting” function.
- Avoid the intrusion of persons during the “muting” phase. This phase is indicated by the indicator light connected to the “muting” indicator output of the XPSLCM module.
- A materials trolley must provide the “muting” signal before entering the protection field and cease it once it has cleared all the sensors of the protection field on exiting.

#### References

Description	Type of terminal block connection	Number of safety circuits	Auxiliary outputs	Supply	Reference	Weight kg/ lb
Safety module for “muting” function	Removable from module	2 PNP	1 PNP + 1 NPN	24 V $\overline{\text{DC}}$	XPSLCM1150	0.660/ 1.455

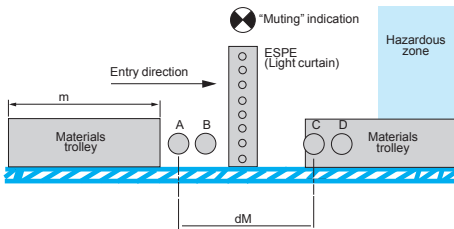

ESPE: electro-sensitive protection equipment (light curtain).  
A, B, D, C: “muting” sensors.  
m: trolley length and dM = distance between A, B and D, C.

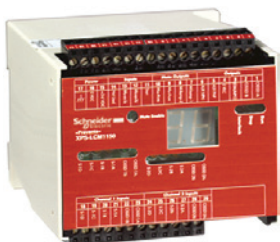

XPSLCM1150

# Monitor and Processing

## Preventa safety modules types XPSECME, XPSECPE

For extending the number of safety contacts

### Operating principle

Safety modules **XPSECME** and **XPSECPE**, for extending the number of safety contacts, are available as additions to Preventa XPSbase modules (Emergency stop, limit switch, two-hand control, etc.). They are used to extend the number of safety output contacts of the base modules.

### References

Description	Connection	Number of safety circuits	Additional outputs	Supply	Reference	Weight kg/lb
<b>Safety modules for extending the number of safety contacts, for use with XPSbase modules</b>	Captive screw clamp terminals Terminal block removable from module	4	2	~ and = 24 V	<b>XPSECME5131P</b>	0.270/ 0.595
	Spring terminals Terminal block removable from module	4	2	~ and = 24 V	<b>XPSECME5131C</b>	0.270/ 0.595
	Captive screw clamp terminals Terminal block removable from module	8	1	~ and = 24 V	<b>XPSECPE5131P</b>	0.550/ 1.213
	Spring terminals Terminal block removable from module	8	1	~ and = 24 V	<b>XPSECPE5131C</b>	0.650/ 1.433
	Captive screw clamp terminals Terminal block removable from module	8	1	~ 115...230 V	<b>XPSECPE3910P</b>	0.650/ 1.433
	Spring terminals Terminal block removable from module	8	1	~ 115...230 V	<b>XPSECPE3910C</b>	0.650/ 1.433



XPSECME5131P



XPSECME5131C



XPSECPE5131P



XPSECPE5131C

# Monitor and Processing

## Preventa safety modules types XPSTSA, XPSTSW

For safety time delays

### Operating principle

Safety modules **XPSTSA** and **XPSTSW** are used in applications requiring safety time delays:

- modules **XPSTSA** in applications with interlocking on high inertia machines with long rundown time (guards unlocked after safety time delay has elapsed),
- modules **XPSTSW** in applications with a safety switchover contact (shunting contact in association with XPSVN modules for zero speed detection, solenoid valve monitoring, etc.).

The time delay of safety circuits can be set to 16 preset values, using 2 selectors located on the front face of the modules.

To aid diagnostics, the modules have LEDs which provide information on the monitoring circuit status and 2 solid-state outputs for signalling to the process PLC. In addition, their removable terminal blocks optimise machine maintenance.

3

### References

Description	Connection	Number of safety circuits	Additional outputs / Solid-state outputs to PLC	Supply	Reference	Weight kg/ lb
Safety modules for applications with interlocking on high inertia machines	Captive screw clamp terminals Terminal block removable from module	1 delayed	2 NC / 2	~ and --- 24 V	XPSTSA5142P	0.250/ 0.551
				~ 115 V	XPSTSA3442P	0.360/ 0.774
				~ 230 V	XPSTSA3742P	0.360/ 0.774
Safety modules for applications with safety switchover contact	Captive screw clamp terminals Terminal block removable from module	1 pulse type	2 NC / 2	~ and --- 24 V	XPSTSW5142P	0.250/ 0.551
				~ 115 V	XPSTSW3442P	0.360/ 0.774
				~ 230 V	XPSTSW3742P	0.360/ 0.774



XPSTSA●●●●P



XPSTSW●●●●P

# Monitor and Processing

## Preventa safety modules types XPSDMB, XPSDME

For coded magnetic switch monitoring

### Operating principle

Safety modules **XPSDMB** and **XPSDME** are specifically designed for monitoring coded magnetic safety switches. They incorporate two safety outputs and two solid-state outputs for signalling to the process PLC. Conforming to Performance Level PL e/Category 4 conforming to EN/ISO 13849-1, modules **XPSDMB** can monitor two independent sensors and modules **XPSDME** can monitor up to six independent sensors.

To monitor a higher number of magnetic switches using these safety modules, the magnetic switches can be connected in series parallel, while meeting the requirements of Performance Level PL d/Category 3 conforming to standard EN/ISO 13849-1.

Safety modules **XPSDM●●●●P** incorporate removable terminal blocks, thus optimising machine maintenance. To aid diagnostics, the modules have LEDs on the front face which provide information on the monitoring circuit status.



XPSDMB1132



XPSDME1132

References							
Description	Connection	Number of safety circuits	Synchro time between inputs	Solid-state outputs for PLC	Supply	Reference	Weight kg/lb
<b>Safety module for monitoring 2 coded magnetic switches</b>	Captive screw clamp terminals Terminal block integrated in module	2 NO	< 0.5 s	2	≡ 24 V	<b>XPSDMB1132</b>	0.250/ 0.551
<b>Safety module for monitoring 6 coded magnetic switches</b>	Captive screw clamp terminals Terminal block integrated in module	2 NO	< 0.5 s	2	≡ 24 V	<b>XPSDME1132</b>	0.300/ 0.661
<b>Safety module for monitoring 2 coded magnetic switches</b>	Captive screw clamp terminals Terminal block removable from module	2 NO	< 0.5 s	2	≡ 24 V	<b>XPSDMB1132P</b>	0.250/ 0.551
<b>Safety module for monitoring 6 coded magnetic switches</b>	Captive screw clamp terminals Terminal block removable from module	2 NO	< 0.5 s	2	≡ 24 V	<b>XPSDME1132P</b>	0.300/ 0.661
<b>Safety module for monitoring 6 coded magnetic switches</b>	Captive screw clamp terminals Terminal block integrated in module	2 NO	< 2.2 s	2	≡ 24 V	<b>XPSDME1132TS220</b>	0.300/ 0.661



### Operating principle

Preventa safety modules **XPSVNE** for zero speed detection are used to detect the stop condition of electric motors. Their most common applications include: providing the unlock signal for electrically interlocked sliding or removable machine guards, controlling rotation direction signals for reversing motors and engaging locking brakes after a motor has come to a standstill.

As electric motors run down, a remanent voltage is produced in the windings of the motor due to residual magnetism. This voltage is proportional to the speed of the motor and, therefore, decreases as the motor comes to a standstill.

This remanent voltage is measured in a redundant manner so as to detect the stop condition of the motor. The cabling between the motor windings and the inputs of the **XPSVNE** module is also monitored to prevent a cabling breakage or fault being seen as a stopped motor.

A transformer should not be used to connect the motor to terminals Z1, Z2 and Z3 since there is no monitoring of the connection with the motor winding via the resistance monitoring.

Modules **XPSVNE** are suitable for detecting the stop condition of all types of AC or DC motor driven machines which, when the motor runs down, produce a remanent voltage in the windings due to residual magnetism. These machines can be controlled by electronic devices, such as variable speed drives or DC injection brakes. The input filters for standard **XPSVNE** modules are designed for a frequency of up to 60 Hz.

For motors operating at a frequency higher than 60 Hz, which therefore produce a high frequency remanent voltage, special modules **XPSVNE●●●●HS** should be used.

Modules **XPSVNE** have 2 potentiometers mounted on the front face of the module which allow independent adjustment of the switching threshold for each input circuit. This allows adjustment for different types of motors and application requirements.

To aid diagnostics, modules **XPSVNE** have 4 LEDs and 2 solid-state outputs to provide information on the status of the zero speed detection circuit.



XPSVNE●●●●●●

### References

Description	Connection	Number of safety circuits/ Solid-state outputs for PLC	Supply	Frequency of motor power supply	Reference	Weight kg/ lb
Safety modules for zero speed detection	Captive screw clamp terminals	2/ 2	∩ 24 V	≤ 60 Hz	XPSVNE1142P	0.500/ 1.102
				> 60 Hz	XPSVNE1142HSP	0.500/ 1.102
	Terminal block removable from module		∩ 115 V	≤ 60 Hz	XPSVNE3442P	0.600/ 1.333
				> 60 Hz	XPSVNE3442HSP	0.600/ 1.323
			∩ 230 V	≤ 60 Hz	XPSVNE3742P	0.600/ 1.323
				> 60 Hz	XPSVNE3742HSP	0.600/ 1.323

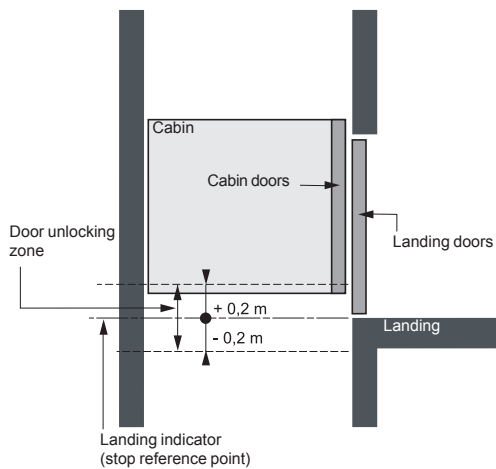

### Operating principle

When the cabin is parked at a landing, with the doors open, some lifts automatically correct their level (isolevelling) in relation to the landing in order to compensate for any differences generated by modification of the load in the cabin. During this operation, European standard EN/IEC 81 recommends that the presence of the cabin be checked within a zone of  $\pm 0.2$  m around the landing (door unlocking zone), by means of a safety circuit which will cause the cabin to stop if it moves out of the specified zone.

The use of the safety module **XPSEDA**, which checks the presence of the cabin in the specified zone at two points, meets this requirement. The module incorporates two safety outputs and two solid-state outputs for signalling functions. Four LEDs on the front face of the module provide visual indication of the status of the safety circuit.

The position of the cabin in relation to the landing is detected by two limit switches in the lift shaft. It is also possible to use non-contact sensors (magnetic sensors with reed contact).

When the cabin reaches the preset position and when it is within the permissible tolerances in relation to the landing, the two safety circuits in safety module **XPSEDA** close and allow isolevelling of the cabin with the doors open. Any change in one of the input signals (cabin outside the specified zone) or detection of a fault (break in the wiring, short-circuit, etc.) causes immediate opening of the safety outputs in the **XPSEDA** module and subsequent stopping of the cabin.

3

### References

Description	Connection	Number of safety circuits	Solid-state outputs for PLC	Supply	Reference	Weight kg/lb
Safety module for lift control	Captive screw clamp terminals Terminal block integrated in module	2	2	$\sim$ and $\text{---}$ 24 V	XPSEDA5142	0.180/ 0.397



XPSEDA5142

# Monitor and Processing

## Preventa safety module type XPSPVT

For dynamic monitoring of hydraulic valves on linear presses

3

### Operating principle

Safety module **XPSPVT** is specifically designed for monitoring hydraulic safety system valves which control the movements of potentially dangerous machines. The operating principle of this module is explained in the circuit diagram of a hydraulic safety system for linear presses (see below).

This hydraulic safety system features a 3 position piston which controls the up and down stroke of the operating cylinder. The circuit is equipped with a safety valve to complete the redundant system. This circuit must be activated to enable the up and down stroke of the cylinder.

If either of the 2 pistons becomes defective (for example, due to a broken spring or to oil contamination), and the valve piston shifts from its normal position towards the open position, the **XPSPVT** module will detect it and prevent resumption of the piston stroke.

Proximity sensors integrated in the valve to detect the piston positions and connected to the **XPSPVT** module must be damped when the valve coils are in the de-energised state (zero position).

The sensor circuits of the **XPSPVT** module are designed to allow connection of NPN and PNP proximity sensors or sensing components. Either 2-wire or 3-wire types can be used.

Hydraulic safety system circuit operating on a linear press.  
Monitoring of valves in position 0.

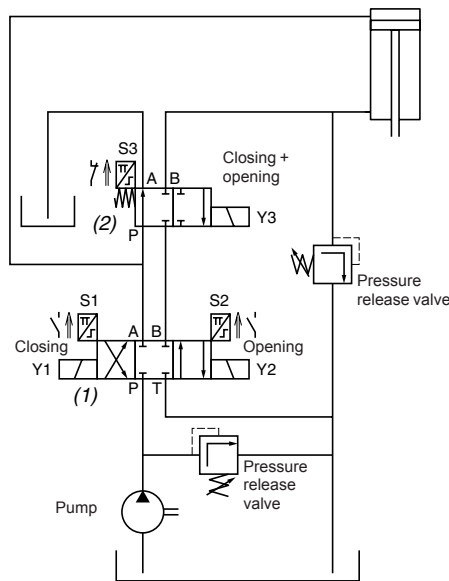

(1) 3 position hydraulic valve.  
(2) 2 position hydraulic valve.



XPSPVT1180

Reference				
Description	Display	Supply	Reference	Weight kg/ lb
Safety module for dynamic monitoring of hydraulic valves on linear presses	8 LEDs	24 V ~	XPSPVT1180	0.540/ 1.190

# Monitor and Processing

## Preventa safety modules type XPSPVK

For dynamic monitoring of double-bodied solenoid valves

### Operating principle

Safety module **XPSPVK** is specially designed for dynamic monitoring of the safety valves in eccentric presses, conforming to European standard EN 692.

This standard establishes the specifications related to safety control systems for presses equipped with friction clutches.

To meet the requirements of this standard, the clutch/brake control must be monitored dynamically.

This function is provided by a double-bodied solenoid valve (safety valve for presses) which performs the functions of two valves mounted in one body.

The position of the two valve pistons can be monitored by proximity sensors, mechanical limit switches or pressure switches.

Module **XPSPVK** checks for the correct operation of the double-bodied safety valves at 3 points in the cycle.

- Start at top dead centre: checks the rest position of the two valves.
- Take-on point (transfer function): checks that the two valves are in the “activated” (energised) position.
- Press stop trigger point: checks that the two valves return to the rest position.

Return must be simultaneous for both valves within a defined time period.

To set up an automatic disconnect of the **XPSPVK** module at the first machine stroke, a NC auxiliary contact mounted on the main control contactor or on another contactor/relay, activated at the same time, can be wired to terminals 7 and 8 in parallel with the RESET button.

If a fault is detected during the cycle, the **XPSPVK** module will stop the slide stroke and will also inhibit the start of another cycle.

3

### References

Description	Display	Supply	Reference	Weight kg/ lb
Safety modules for dynamic monitoring of double-bodied solenoid valves	8 LEDs	24 V $\overline{\text{---}}$	<b>XPSPVK1184</b>	0.700/ 1.543
		115 V $\sim$	<b>XPSPVK3484</b>	0.900/ 1.984
		230 V $\sim$	<b>XPSPVK3784</b>	0.900/ 1.984



XPSPVK

# Monitor and Processing

## Preventa safety modules type XPSOT

For safety stop with automatic overtravel monitoring and control

### Operating principle

Safety module **XPSOT** is used on eccentric presses to monitor overtravel and ensure that the press slide stops in a non-dangerous position, i.e. top dead centre (TDC), during normal (non-emergency) operation.

Use of this module, designed in accordance with standard EN 692 relating to mechanical press safety, makes it possible to create a redundant, self-monitoring control system.

The two essential functions of this safety module are to:

- **Trigger the end of cycle stop sequences slightly before top dead centre (at point A) so as to come to a complete stop at TDC.**

After TDC, the permissible overtravel is approximately 10°. The safety module immediately detects any overtravel. Overtravel is indicative of braking device deterioration and, in this case, jog mode must be used to move the slide back to TDC. The next cycle will be inhibited to allow maintenance to be performed on the braking device (cam 1).

- Take over control monitoring during the dangerous part of the cycle (slide downstroke). Any stop instruction issued between TDC (0°) and point C (approximately 150° after TDC) causes an immediate stop of the press. **This approximate value of 150° corresponds to the 8 mm tool closure dimension (safety point).**

When a stop instruction is issued after this safety point, the press completes the cycle and comes to a complete stop at TDC (cam 2).

Control of the dangerous part of the cycle (generally the slide downstroke) is usually activated from a two-hand control station associated with a safety module (type **XPSBCE**).

Overtravel monitoring is performed **on each cycle** by safety module **XPSOT**.

### Operating principle (continued)

Press diagram

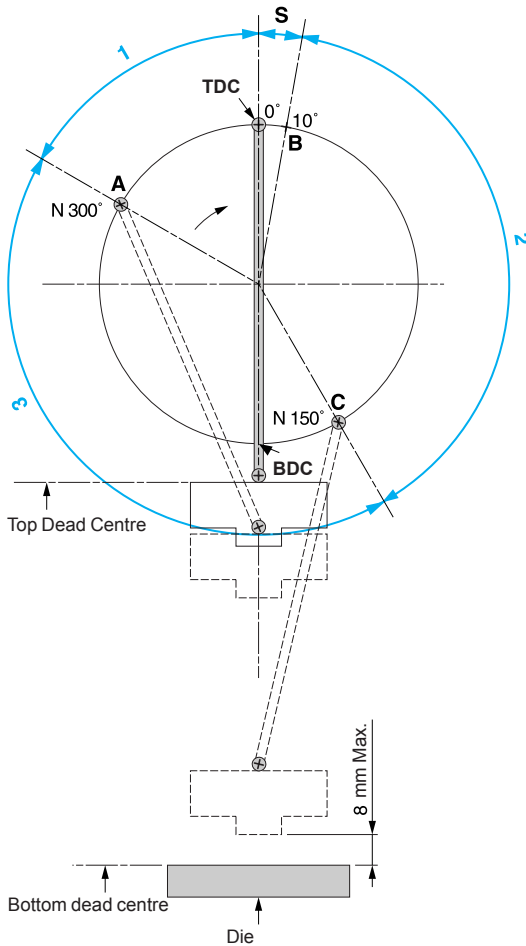

Control cams diagram

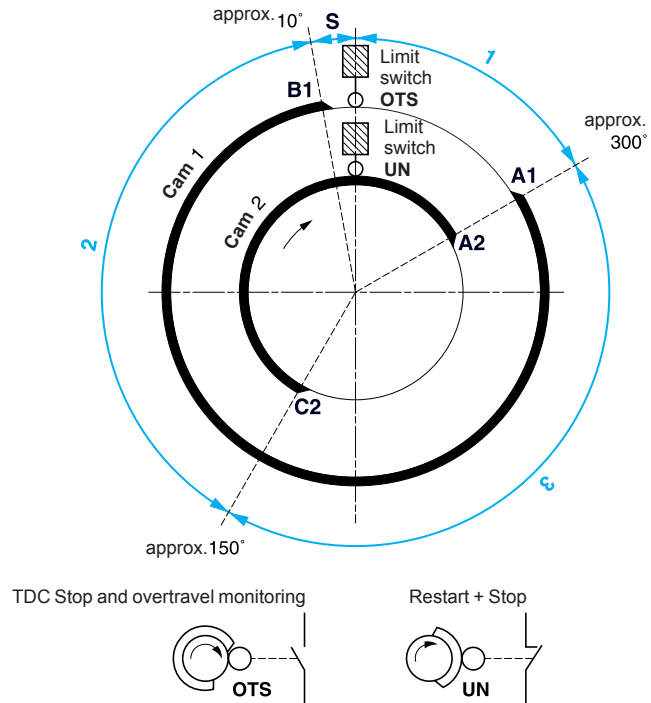

- 1 Permissible overtravel zone.
- 2 Dangerous zone (usually slide downstroke).
- 3 Non-dangerous zone (usually slide upstroke).

- S Permissible overtravel.
- A Press stop trigger point.
- B Point at which permissible overtravel is exceeded (a stop instruction issued after point B will lock up the press).
- C Takeover point, beyond which the press will complete its cycle up to TDC.
- TDC Top dead centre, actual stopping zone of the press.
- BDC Bottom dead centre.

#### Cam operation

Cam 1 is associated with the **OTS**, limit switch (LS), cam 2 with the **UN** limit switch (the limit switches must be located on different cams for safety reasons).

The **OTS** limit switch is deactivated at TDC, at which point the **UN** limit switch is activated.

Point A1 of **cam 1** is located approximately 300° after TDC and, when reached, the press stops and comes to a standstill: **A1 is the press stop trigger point**. Point B1, located approximately 10° after TDC, constitutes the end of cam 1: **If B1 is exceeded during stopping**, the overtravel is abnormally long, **the press locks up** and the next cycle is inhibited.

Point A2 of cam 2 functions like point A1 on cam 1 (contact state of the **UN** limit switch reversed in relation to the state of the **OTS** limit switch).

Point C2, located approximately 150° after TDC, corresponds to the 8 mm tool closing dimension. Stop instructions issued after C2 is reached are not executed until point A2 is reached.

### References

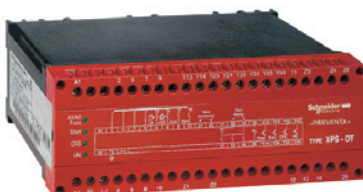

XPSOT

Description	Display	Supply	Reference	Weight kg/ lb
Safety modules for safety stop with automatic overtravel monitoring and control	4 LEDs	115 V ~	XPSOT3444	1.100/ 2.425
		230 V ~	XPSOT3744	1.100/ 2.425

#### Compatibility of offers

##### Modicon TM3 expansion modules

- > Modicon M221 logic controllers
- > Modicon M221 Book logic controllers
- > Modicon M241 logic controllers
- > Modicon M251 logic controllers
- > SoMachine Basic software
- > SoMachine software
- > Modicon TM2 expansion modules

3



Digital I/O modules



Analog I/O modules



Expert I/O modules



Functional Safety modules



Bus expansion modules

#### Presentation

The Modicon TM3 expansion module offer provides an opportunity to enhance the capabilities of Modicon M221, M241 and M251 logic controllers:

- Digital I/O modules which can be used to create configurations with up to 488 digital I/O (according to the controller). These modules are available with the same connections as the controllers.
- Analog I/O modules which can be used to create configurations with up to 114 analog I/O (according to the controller) and are designed to receive, amongst other things, position, temperature or speed sensor signals. They are also capable of controlling variable speed drives or any device equipped with a current or voltage input.
- Expert modules for control of TeSys motor starters which simplify wiring up the control section due to connection with RJ45 cables.
- Functional Safety modules which simplify wiring and can be configured in the SoMachine and/or SoMachine Basic softwares.

In addition, the TM3 expansion system is flexible due to the possibility of remotely locating some of the TM3 modules in the enclosure or another cabinet (up to 5 meters (16.404 ft.) away, using a bus expansion system.

The Modicon TM3 expansion system is common to the whole range of Modicon M221, M241 and M251 logic controllers, meaning that the model of controller can be revised without changing expansion module.

#### Modicon TM3 range

- Digital I/O modules**
- modules with 8 to 32 inputs/outputs:
    - 24 V or 120 V  $\pm$  50/60 Hz inputs
    - relay or transistor outputs

- Analog I/O modules**
- modules with 2 to 8 inputs/outputs:
    - current/voltage or temperature inputs
    - current/voltage outputs

- Expert module**
- module for control of one to four TeSys motor starters

- Functional Safety modules**
- modules designed using **Preventa** technology for integral machine safety:
    - control of emergency stops
    - control of switches
    - control of light curtains
    - control of pressure-sensitive mats or edges

- Bus expansion system**
- transmitter module
  - receiver module
  - bus expansion cable

#### Specific features

Modicon TM3 expansion modules have been designed with a simple interlocking assembly mechanism. A bus expansion connector is used to distribute data and the power supply when assembling the Modicon TM3 expansion modules with logic controllers.

#### Connections

A wide choice of connections is available depending on the model of Modicon TM3 module:

- removable screw terminal blocks (1)
- removable spring terminal blocks (1)
- HE 10 connector, to be used with HE 10 cables/bare wires or HE 10/HE 10 and Telefast sub-bases (2)

The connectors (screw terminal blocks, spring terminal blocks, HE 10 connector, RJ 45) are located on the front of the TM3 expansion modules and are therefore accessible.

(1) The terminal blocks are supplied with Modicon TM3 expansion modules.

(2) Telefast Modicon ABE7 pre-wired system to be ordered separately, visit our web site: [www.schneider-electric.com](http://www.schneider-electric.com)

# Monitor and Processing

## Modicon TM3 expansion modules

### Bus expansion system

#### Presentation

##### Modicon TM3 bus expansion system

A PLC configuration consists of a controller with its embedded input and output channels, used in conjunction with local or remote expansion modules which are used to increase the number of channels and/or functions.

- Expansion modules are connected directly by simple interlocking with the controller (local I/O) or remotely (remote I/O) with a TM3 bus expansion cable, up to 5 meters (16.404 ft.) away.
- The bus expansion connector, located on the side of the controllers and on each side of the Modicon TM3 expansion modules, transmits and synchronizes data.

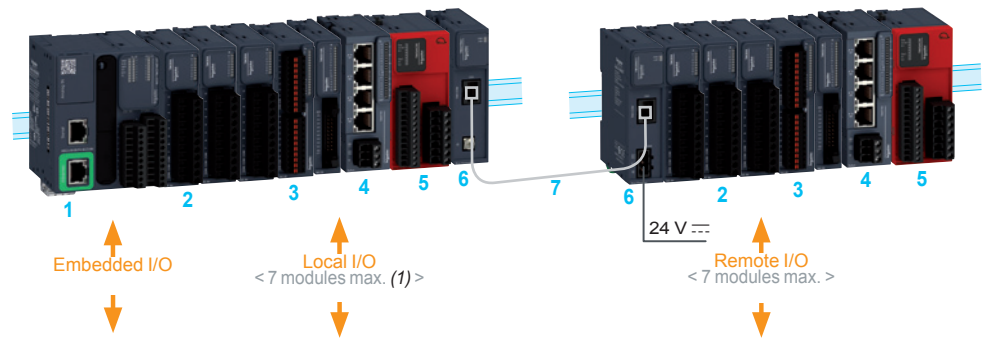

- 1 Logic controller (M221, M221 Book, M241, M251)
- 2 Modicon TM3 digital I/O modules.
- 3 Modicon TM3 analog I/O modules.
- 4 Modicon TM3 expert module: control of TeSys motor starters.
- 5 Modicon TM3 functional safety modules.
- 6 Modicon TM3 bus expansion modules (transmitter and receiver).
- 7 TM3 bus expansion cable.

##### ■ Local I/O

Maximum configuration: 7 Modicon TM3 expansion modules associated with an M2●● logic controller. **(With limited number of relay or transistor outputs.**

##### ■ Remote I/O

Maximum configuration: 14 Modicon TM3 expansion modules (7 local modules + 7 remote modules) with the use of Modicon TM3 bus expansion system (transmitter and receiver modules).

The transmitter and receiver bus expansion modules can be used to:

- increase from 7 to 14 the number of I/O expansion modules that can be connected to an M2●● logic controller
- locate Modicon TM3 expansion modules remotely, up to 5 meters (16.404 ft.) away

The transmitter module and receiver module are physically linked by a **VDIP184546●●●** bus expansion cable, or any other shielded cable Cat 5E, F/UT.

##### Mounting

- Modicon TM3 expansion modules are mounted on a  $\perp$  symmetrical rail. They have a locking clip on the top of their casing.
- For plate or panel mounting, use the **TMAM2** kit.

(1) Depending on type of TM3 module used.



# Monitor and Processing

## Modicon TM3 functional safety modules

(Powered by **Preventa** technology)

**Safety application**



**Compatibility**

**Control of Emergency stop and switches**

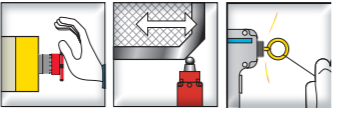

**Control of Emergency stop and switches**

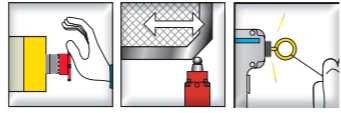

- Modicon M221 and Modicon M221 Book logic controllers
- Modicon M241 logic controllers
- Modicon M251 logic controllers



<b>Maximum achievable safety level</b>	PL d/Category 3 conforming to EN/ISO 13849-1 SILCL2 conforming to EN/IEC 61508-1	PL e/Category 4 conforming to EN/ISO 13849-1 SILCL3 conforming to EN/IEC 61508-1
<b>Standards (product)</b>	EN/IEC 60947-1 EN/IEC 60947-5-1	EN/IEC 60947-1 EN/IEC 60947-5-1
<b>Standards (machine assembly)</b>	Emergency stop circuits	EN/IEC 60204-1 EN/ISO 13850
	Switches in protective devices	EN/ISO 14119
	Type 4 light curtains equipped with solid-state safety outputs with test function	–
	4-wire pressure-sensitive mats or edges	–
<b>Product certifications</b>	UL, CSA, TÜV, EAC, RCM	UL, CSA, TÜV, EAC, RCM

<b>Safety circuits</b>	Number	3 NO	3 NO
	Type	Instantaneous opening relay	Instantaneous opening relay
<b>Module fuse protection</b>		Internal, electronic	Internal, electronic
<b>LEDs</b>		6 LEDs	6 LEDs
<b>Power supply</b>		24 V ...	24 V ...
<b>Synchronization time between inputs</b>		Unlimited	Unlimited
<b>Input channel voltage</b>		24 V ...	24 V ...

<b>Safety module reference</b>	Channels and power supply connected: with removable screw terminals	<b>TM3SAC5R</b>	<b>TM3SAF5R</b>
	with removable spring terminal blocks	<b>TM3SAC5RG</b>	<b>TM3SAF5RG</b>

**Control of Emergency stop, switches, solid-state output safety light curtains and sensors with PNP+PNP outputs**

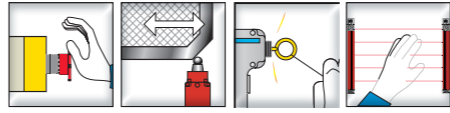

**Control of Emergency stop, switches, pressure-sensitive mats and edges, solid-state output safety light curtains and sensors with PNP+PNP or PNP+NPN outputs**

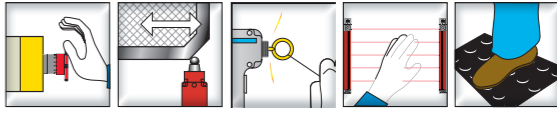

- Modicon M221 and Modicon M221 Book logic controllers
- Modicon M241 logic controllers
- Modicon M251 logic controllers



<b>Maximum achievable safety level</b>	PL d/Category 3 conforming to EN/ISO 13849-1 SILCL2 conforming to EN/IEC 61508-1	PL e/Category 4 conforming to EN/ISO 13849-1 SILCL3 conforming to EN/IEC 61508-1
<b>Standards (product)</b>	EN/IEC 60947-1 EN/IEC 60947-5-1	EN/IEC 60947-1 EN/IEC 60947-5-1
<b>Standards (machine assembly)</b>	Emergency stop circuits	EN/IEC 60204-1 EN/ISO 13850
	Switches in protective devices	EN/ISO 14119
	Type 4 light curtains equipped with solid-state safety outputs with test function	–
	4-wire pressure-sensitive mats or edges	–
<b>Product certifications</b>	UL, CSA, TÜV, EAC, RCM	UL, CSA, TÜV, EAC, RCM

<b>Safety circuits</b>	Number	3 NO	3 NO
	Type	Instantaneous opening relay	Instantaneous opening relay
<b>Module fuse protection</b>		Internal, electronic	Internal, electronic
<b>LEDs</b>		6 LEDs	6 LEDs
<b>Power supply</b>		24 V ...	24 V ...
<b>Synchronization time between inputs</b>		Unlimited	Unlimited or 2 s, 4 s (depending on wiring), can be configured in the software
<b>Input channel voltage</b>		24 V ...	24 V ...

<b>Safety module reference</b>	Channels and power supply connected: with removable screw terminals	<b>TM3SAFL5R</b>	<b>TM3SAK6R</b>
	with removable spring terminal blocks	<b>TM3SAFL5RG</b>	<b>TM3SAK6RG</b>

# Monitor and Processing

## Modicon TM3 functional safety modules

(Powered by **Preventa** technology)



3

### Presentation

Modicon TM3 functional safety modules are designed using Preventa technology. They can be used to incorporate machine safety into the overall machine control.

#### Data acquisition: control of safety products

- Emergency stop button: complementary protection measures
- Monitoring devices used in protective systems to control access to hazardous areas
- Light curtains and safety mats to detect intrusion into hazardous areas

#### Monitoring and processing

- Modicon TM3 functional safety modules control the input signals from monitoring devices and act as an interface with contactors and variable speed drives, causing the machine to stop.
- Modicon TM3 functional safety modules complement the embedded I/O on M221, M221 Book, M241 and M251 logic controllers.

Modicon TM3 functional safety modules	Safety system/Performance level reached
---------------------------------------	---

<b>For control of emergency stops</b>	Category 4 architecture / PL e, SIL3 
---------------------------------------	--

<b>For control of switches</b>	Category 4 architecture / PL e, SIL3 
--------------------------------	--

<b>For control of type 4 light curtains</b>	Category 4 architecture / PL e, SIL3 
---	--

<b>For control of pressure-sensitive mats or edges</b>	Category 4 architecture / PL e, SIL3 
--	--

- The safety outputs available on the 4 modules are relay type, guided by microprocessor technology.
- Diagnostic utilities use LEDs, found on the module front face. They provide information on the monitoring circuit status.
- The diagnostic information is shared via the TM3 bus.
- The Start button monitoring function is configurable depending on the wiring.

### Connections

Equipped, depending on the model, with removable screw or spring-type terminals for connecting the safety channels.

### Configuration

Modicon TM3 functional safety modules connect to M221, M221 Book, M241 and M251 logic controllers according to the general rules for the TM3 system: 7 modules max. and 14 modules max. with the use of Modicon TM3 bus expansion system (transmitter and receiver).

### Mounting

- Modicon TM3 functional safety modules are mounted on a symmetrical rail.
- For plate or panel mounting, use the **TMAM2** kit.

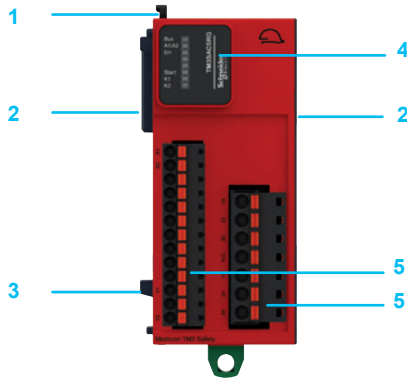

TM3SAC5R



TM3SAC5RG



TM3SAF5R



TM3SAF5RG



TM3SAFL5R



TM3SAFL5RG



TM3SAK6R



TM3SAK6RG

### Description

#### Modicon TM3 functional safety modules

- 1 Adjacent module locking latch.
- 2 TM3 bus connectors (one on each side). These are designed to provide continuity of the link between connected modules.
- 3 symmetrical rail locking clip.
- 4 Display block (6 LEDs - green, red) for the module channels and diagnostics.
- 5 Removable spring or screw-type terminal blocks (depending on the model) for connecting the safety channels and the power supply.

### References

Designation	Maximum achievable safety level	Term. block for input conn. (1)	Reference	Weight kg lb
<b>24 V <math>\overline{\text{---}}</math> power supply</b>				
Functional Safety modules for control of <input type="checkbox"/> emergency stops <input type="checkbox"/> switches	PL d/Category 3 conforming to EN/ISO 13849-1 SILCL2 conforming to EN/IEC 61508-1	screw	<b>TM3SAC5R</b>	0.190 0.420
		spring	<b>TM3SAC5RG</b>	0.190 0.420
Functional Safety modules for control of <input type="checkbox"/> emergency stops <input type="checkbox"/> switches	PL e/Category 4 conforming to EN/ISO 13849-1 SILCL3 conforming to EN/IEC 61508-1	screw	<b>TM3SAF5R</b>	0.190 0.420
		spring	<b>TM3SAF5RG</b>	0.190 0.420
Functional Safety modules for control of <input type="checkbox"/> emergency stops <input type="checkbox"/> switches <input type="checkbox"/> safety light curtains with solid-state outputs	PL d/Category 3 conforming to EN/ISO 13849-1 SILCL2 conforming to EN/IEC 61508-1	screw	<b>TM3SAFL5R</b>	0.190 0.420
		spring	<b>TM3SAFL5RG</b>	0.190 0.420
Functional Safety modules for control of <input type="checkbox"/> emergency stops <input type="checkbox"/> switches <input type="checkbox"/> safety light curtains with solid-state outputs <input type="checkbox"/> pressure-sensitive mats or edges	PL e/Category 4 conforming to EN/ISO 13849-1 SILCL3 conforming to EN/IEC 61508-1	screw	<b>TM3SAK6R</b>	0.190 0.420
		spring	<b>TM3SAK6RG</b>	0.190 0.420

#### Separate parts

Designation	Description	Reference	Weight kg lb
<b>Mounting kit</b> Sold in lots of 10	For mounting Functional Safety modules on a plate or panel	<b>TMAM2</b>	0.065 0.143

(1) Removable terminal blocks equipped with screw terminals or spring terminals, supplied with the controller.

3

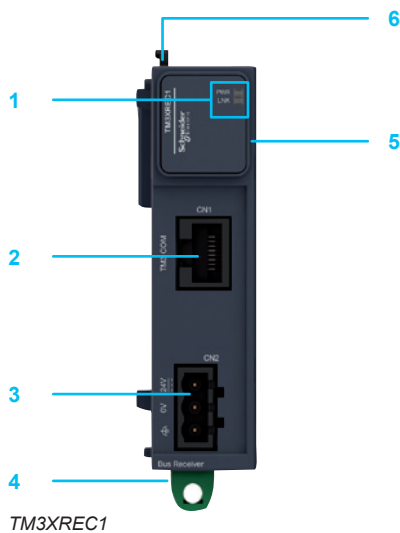
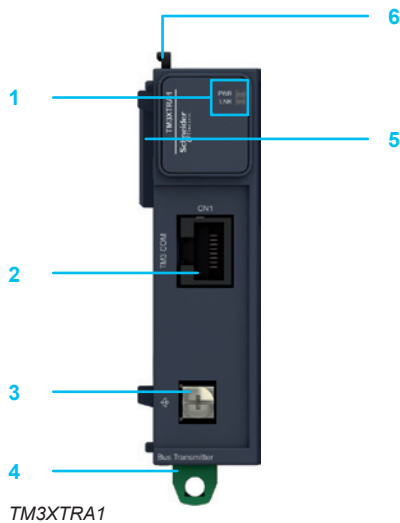

### Presentation

Modicon TM3 transmitter and receiver modules can be used to:

- increase from 7 to 14 the number of TM3 I/O expansion modules that can be connected to an M2●● logic controller (1)
- locate Modicon TM3 expansion modules remotely, up to 5 m (16.404 ft.) away

The transmitter and receiver modules are physically linked by a **VDIP184546●●●** bus expansion cable, or any other shielded cable Cat 5E, F/UT.

### Mounting

- TM3 bus expansion modules are mounted on a  $\perp$  symmetrical rail.
- For plate or panel mounting, use the **TMAM2** kit.

### Description

#### TM3XTRA1 transmitter module

- 1 Block with 2 LEDs displaying the communication status and power supply status.
- 2 RJ 45 connector for connecting the **VDIP184546●●●** bus expansion cable, or any other shielded cable Cat 5E, F/UT.
- 3 Screw terminal for the functional ground (FG) connection.
- 4  $\perp$  symmetrical rail locking clip.
- 5 TM3 bus connector providing continuity of the link with the connected module.
- 6 Adjacent module locking latch.

#### TM3XREC1 receiver module

- 1 Block with 2 LEDs displaying the communication status and power supply status.
- 2 RJ 45 connector for connecting the **VDIP184546●●●** bus expansion cable, or any other shielded cable Cat 5E, F/UT.
- 3 Screw terminal block for connecting the power supply.
- 4  $\perp$  symmetrical rail locking clip.
- 5 TM3 bus connector providing continuity of the link with the connected module.
- 6 Adjacent module locking latch.

(1) It is not possible to use the bus expansion system Modicon TM3 if one or more Modicon TM2 expansion modules are used in the configuration.

# Monitor and Processing

## Modicon TM3 bus expansion system

### Transmitter module and receiver module



TM3XTRA1



TM3XREC1

#### References

##### Modicon TM3 bus expansion system

Designation	Characteristics	Reference	Weight kg lb
<b>Transmitter module</b>	Data transmission module Power supply: using the TM3 bus	<b>TM3XTRA1</b>	0.065 0.143
<b>Receiver module</b>	Data reception module Power supply: 24 V $\overline{\text{DC}}$ (with external power supply)	<b>TM3XREC1</b> (1)	0.075 0.165

##### Cordsets

Designation	Used for	Length	Reference	Weight kg lb
<b>Shielded category 5E TM3 bus expansion cables</b>	TM3 bus expansion by linking transmitter and receiver modules Equipped with an RJ 45 connector at each end	0.5 m 1.64 ft	<b>VDIP184546005</b>	–
		1 m 3.28 ft	<b>VDIP184546010</b>	–
		2 m 6.56 ft	<b>VDIP184546020</b>	–
		3 m 9.84 ft	<b>VDIP184546030</b>	–
		5 m 16.40 ft	<b>VDIP184546050</b>	–
<b>Functional ground cable</b>	Functional ground for the TM3XTRA1 transmitter module	0.12 m 0.39 ft	Cable supplied with the TM3XTRA1 transmitter module	–

##### Spare parts

Designation	Description	Unit reference	Weight kg lb
<b>Mounting kit</b> Sold in lots of 10	For mounting bus expansion modules on a plate or panel	<b>TMAM2</b>	0.065 0.143
<b>Set of terminal blocks for connecting the power supply</b>	8 removable terminal blocks with screw terminals	<b>TMAT2PSET</b>	0.127 0.280

(1) The TM3XREC1 module is supplied with a removable screw terminal block for connecting the power supply.

Applications

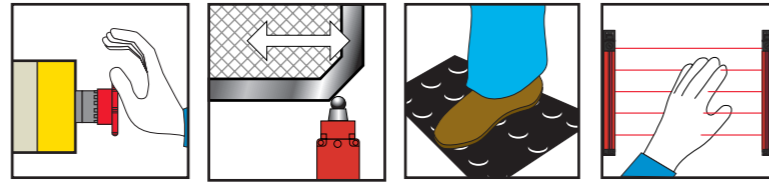

Modules

Controllers for monitoring 2 independent safety functions simultaneously. User selection of 2 functions from a choice of 15, programmable from front face of controller.



Functions

- Emergency stop monitoring
- Switch monitoring
- Enabling switch monitoring
- Sensing mat or edges monitoring
- Light curtain monitoring, relay output type
- etc.

Maximum achievable safety level

PL e/Category 4 conforming EN ISO 13849-1, SILCL 3 conforming to EN/IEC 61508 and EN/IEC 62061

Conformity to standards

EN/IEC 60204-1, EN/IEC 60947-1, EN/IEC 60947-5-1

Product certifications

UL, CSA, TÜV

Number of circuits

Safety  
Additional

6 NO (3 NO per function)  
3 solid-state outputs for signalling to PLC

Display

12 LEDs

Supply voltage

24 V ---

Communication

CANopen bus  
Profibus bus  
Modbus bus

–  
–  
–

Module type

**XPS MP**

Pages

3/104

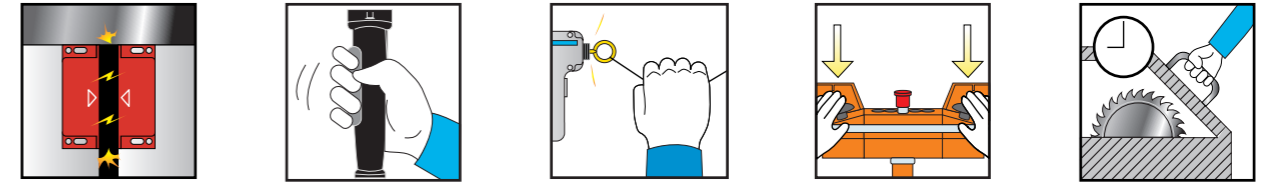

Configurable controllers using software, for several independent safety functions: selection of safety functions using configuration software running on Windows (16 or 32 inputs and 8 independent safety outputs)



- Emergency stop monitoring
- Limit switch monitoring
- Two-hand control monitoring
- Safety light curtain monitoring, with or without "muting" function
- Enabling switch monitoring, coded magnetic switch monitoring
- Safety mat monitoring
- Hydraulic press solenoid valve monitoring
- Eccentric press safety stop at top dead centre monitoring. Zero speed detection
- Hydraulic press monitoring
- Eccentric press monitoring
- Foot switch monitoring
- Chain shaft breakage monitoring
- Safe tool
- Position selector

PL e/Category 4 conforming EN ISO 13849-1, SILCL 3 conforming to EN/IEC 61508 and EN/IEC 62061

EN/IEC 60204-1, EN 1760-1/ISO 13856-1, EN/IEC 61496-1, EN 574/ISO 13851, EN/IEC 60947-1, EN/IEC 60947-5-1

UL, CSA, TÜV

4 NO (2 NO per function) + 6 solid-state

1 "muting" signalling output

LED display on front face

24 V ---

Via SUB-D 9-pin male connector, only on XPS MC16ZC and XPS MC32ZC

Via SUB-D 9-pin female connector, only on XPS MC16ZP and XPS MC32ZP

Via RJ45 connector, on all controllers XPS MC●●Z●

**XPS MC**

3/106

**Presentation**

**Operating principle**

Preventa safety controller modules XPSMP are designed for a Performance Level of up to PL e/Category 4 conforming to standard EN/ISO 13849-1.

They enable two independent safety functions (selected from a choice of 15 pre-defined configurations) to be performed using the same product. Configuration selection is easily made using 3 buttons on the front face of the module.

These 15 pre-programmed safety functions provide a solution for the majority of safety applications, for example: monitoring Emergency stops, limit switches, safety mats and sensing edges, enabling switches, coded magnetic switches, type 4 safety light curtains conforming to EN 61496-1.

Safety controllers XPSMP incorporate 6 safety outputs (3 per function) and 3 solid-state signalling outputs for signalling to the process PLC.

To aid diagnostics, the modules have LEDs on the front face which provide information on the monitoring circuit status. They also indicate and assist selection of the 2 required configurations.

**Maximum achievable safety level**

- PL e/Category 4 conforming EN ISO 13849-1,
- SILCL 3 conforming to EN/IEC 61508 and EN/IEC 62061

**Product certifications**

- UL
- CSA
- TÜV

	Configuration	Synchronisation time	Type of start (1)		Start test	Notes
			Automatic or unmonitored	Monitored		
Functions disabled	0	–	–	–	–	Factory setting
Emergency stop monitoring, 1-channel wiring (category 2)	1	–	X	–	–	–
	2	–	–	X	–	–
Emergency stop monitoring, 2-channel wiring, or guard monitoring (category 4)	3	Unlimited	X	–	X	–
	4	Unlimited	–	X	X	–
	5	1.5 s	X	–	X	–
	6	1.5 s	–	X	X	–
	7	Unlimited	X	–	–	–
	8	Unlimited	–	X	–	–
Guard monitoring for injection press or blowing machine (category 4)	9	1.5 s	–	X	X	Uses both safety outputs (2)
Enabling grip switch monitoring (3 position switch) (category 4)	10	–	X	–	X	The start button acts as start-up preparation
Sensing mat and edges monitoring (category 3)	11	–	X	–	–	Mats with circuit making contacts
	12	–	–	X	–	
Relay output safety light curtain monitoring (category 4)	13	0.5 s	–	X	X	–
Coded magnetic switch monitoring (category 4)	14	1.5 s	X	–	–	Magnetic switches with 2 contacts, 1 NO and 1 NC
	15	1.5 s	–	X	–	

(1) Automatic start: there is no contact or it is shunted.

Unmonitored start: The output is activated on closing of the start contact.

Monitored start: the start input is monitored so that there is no start-up in the event of the start contact being shunted or the start circuit being closed for more than 10 seconds.

Start-up is triggered following activation of the start button (push-release function) on opening of the contact.

(2) Tool zone guard with 3<sup>rd</sup> switch.

Additional rear guard (optional) with automatic start. The opening of the guard cuts all outputs.



XPSMP11123



XPSMP11123P

References						
Description	Type of terminal block connection	Number of safety circuits	Additional outputs	Supply	Reference	Weight kg/lb
Modules for 2 independent safety functions	Integrated in module	3 NO per function (6 NO total)	3 solid-state	24 V $\overline{\text{DC}}$	XPSMP11123	0.320 0.71
	Removable from module	3 NO per function (6 NO total)	3 solid-state	24 V $\overline{\text{DC}}$	XPSMP11123P	0.320 0.71



### Schemes

> Wiring diagram and Functional Diagram are available on the “e-Shop” via the partnumber. Click on a partnumber, the hyperlink opens the “e-Shop”

Embedded hyperlinks  
in catalogues



direct access to  
information on the  
internet

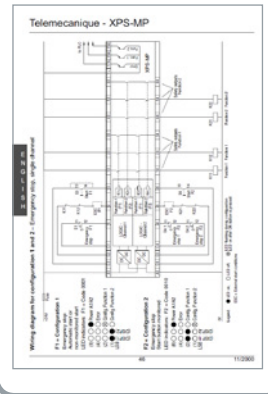

>> Click on “Documents & Download”  
>> Click on “Instruction sheet”



# Monitor and Processing

## Preventa configurable safety controllers

### Type XPSMC

3



XPSMC16ZC



XPSMC32ZC

### Presentation

Configurable safety controllers **XPSMC●●Z●** are designed to provide a solution for safety applications requiring conformity to Performance Level PL e/Category 4 EN/ISO 13849-1 and SIL 3 EN/IEC 61508.

The range of configurable safety controllers comprises 6 products, each with different technical characteristics.

Configurable controllers	Safety inputs	Safety outputs (1)	Communication via		
			CANopen bus	Profibus bus	Modbus serial link
XPSMC16Z	16	6 + 2 x 2	–	–	Yes, slave
XPSMC16ZC	16	6 + 2 x 2	Yes, slave	–	Yes, slave
XPSMC16ZP	16	6 + 2 x 2	–	Yes, slave	Yes, slave
XPSMC32Z	32	6 + 2 x 2	–	–	Yes, slave
XPSMC32ZC	32	6 + 2 x 2	Yes, slave	–	Yes, slave
XPSMC32ZP	32	6 + 2 x 2	–	Yes, slave	Yes, slave

### Line control

The safety inputs are supplied by the various control outputs (2), in such a manner so as to monitor for short-circuits between the inputs, short-circuits between each input and earth or the presence of residual voltages.

The controller, assisted by the control outputs, continuously tests all the connected inputs. As soon as an error is detected on an input, all the outputs associated with this input are disconnected. Safety outputs associated with other inputs remain active.

### Configuration

Safety controllers **XPSMC●●Z●** are configurable and addressable using software **XPSMCWIN** running on a PC. Connection accessories required: see page 3/109.

### Connections

For connection of safety inputs and outputs, safety controllers **XPSMC●●Z●** can be fitted with a choice of: screw connectors type **XPSMCTS●●**, or spring clip connectors type **XPSMCTC●●**.

These connectors are to be ordered separately, see page 3/109.

### Safety functions

Configuration of the safety functions is carried out using software **XPSMCWIN** which is available on the Safety Suite V2 CD-ROM.

**30 certified safety functions** are available with this software and they are easily assignable to the safety outputs. The safety functions have multiple combination possibilities and various starting conditions.

The safety functions are:

- certified in accordance with EN/ISO 13849-1 and IEC 61508,
- configurable in controller XPSMC using software **XPSMCWIN** which is available on the Safety Suite V2 software pack.

All 8 safety outputs are suitable for use in safety related parts of control systems conforming to Performance Level PL e/Category 4 in accordance to EN/ISO 13849-1.

### Main safety functions

- Emergency stop monitoring, with or without time delay, 1 or 2-channel wiring
- Two-hand control (type III- A and C conforming to EN 574/ISO 13851)
- Guard monitoring with 1 or 2 limit switches
- Guard monitoring for injection presses and blowing machines
- Magnetic switch monitoring
- Sensing mat monitoring
- Light curtain (type 4 conforming to EN/IEC 61496, relay or solid-state output) monitoring
- Zero speed detection
- Dynamic monitoring of hydraulic valves on linear presses
- Monitoring safety stop at top dead centre on eccentric press
- Safety time delays
- "Muting" function of light curtains
- Enabling switch monitoring, 2 or 3 contact
- Hydraulic press
- Eccentric press
- Foot switch monitoring
- Chain shaft breakage monitoring
- Position selector

### Application schemes and functional diagrams

See instruction sheet on [www.schneider-electric.com](http://www.schneider-electric.com)

(1) 8 independent safety outputs = 6 solid-state safety outputs + 2 x 2 relay outputs (4 relay outputs with mechanically linked contacts).

(2) 8 control outputs are available but they are not safety outputs.

### Communication

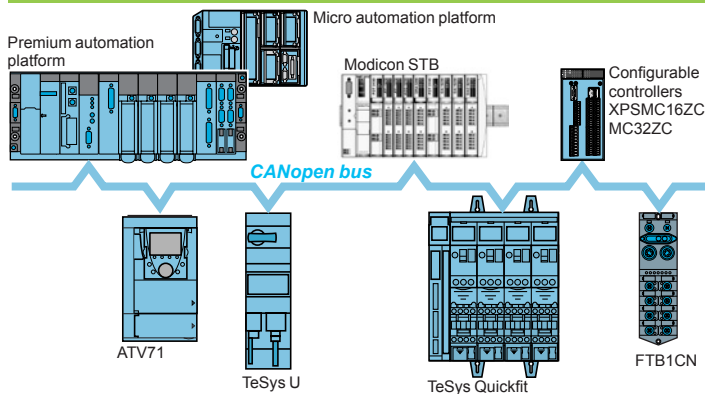

#### CANopen fieldbus

Configurable safety controllers **XPSMC●●ZC** incorporate a SUB-D 9-pin male connector for direct connection on CANopen bus.

CANopen bus is an open bus that ensures deterministic and reliable access to the real-time data of automation equipment. The bus uses a shielded dual twisted pair on which a maximum of 127 devices can be connected by chaining.

The baud rate varies between 10 Kbps and 1Mbps depending on the length of the bus (5000 m/16404.15 ft to 20 m/65.62 ft).

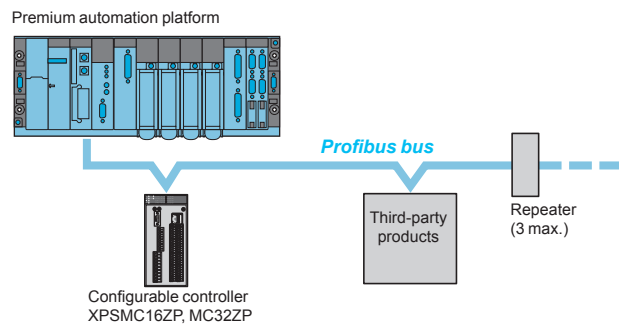

#### Profibus bus

Configurable safety controllers **XPSMC●●ZP** incorporate a SUB-D 9-pin male connector for connection on Profibus bus.

Configurable safety controllers **XPSMC●●ZP** are slaves on the Profibus bus.

Profibus bus is a fieldbus that meets industrial communication requirements. The topology of the Profibus bus is of the linear type with a centralised master/slave type access procedure. The physical link is a single shielded twisted pair.

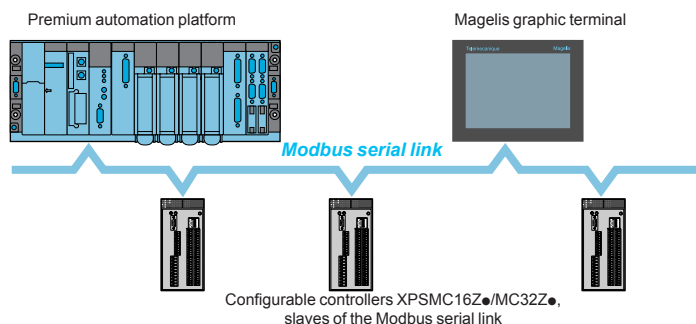

#### Modbus serial link

Configurable safety controllers **XPSMC●●Z●** incorporate a Modbus communication interface (RJ45 connector) for configuration and diagnostics.

This interface enables connection of the controllers to:

- a PC (configuration),
- a PLC (diagnostics), or
- an operator dialogue terminal (diagnostics).

The Modbus serial link comprises a master station (Premium automation platform) and slave stations (configurable controllers **XPSMC16/32Z●**).

Two exchange mechanisms are possible:

- **Question/response**: the questions from the master are addressed to a given slave. The response is expected by return from the interrogated slave.
- **Distribution**: the master distributes a message to all the stations of the Modbus serial link. The latter execute the order without transmitting a reply.

### Description

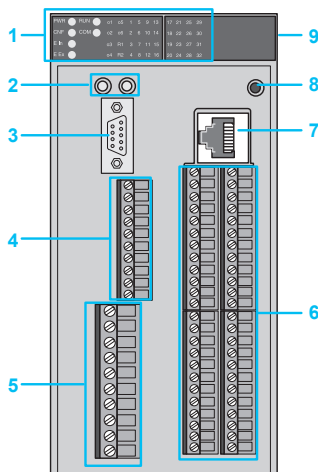

#### Configurable safety controller **XPSMC●●Z●**, with screw connectors

##### Front face

- 1 LED display and system diagnostics.
- 2 Two LEDs for CANopen or Profibus (1) connection status.
- 3 SUB-D 9-pin male connector for connection on CANopen bus (**XPSMC16ZC/MC32ZC**) or SUB-D 9-pin female connector for connection on Profibus bus (**XPSMC16ZP/MC32ZP**).
- 4 Solid-state safety output and "muting" indicator light terminals.
- 5 Power supply (24 V  $\overline{---}$ ) and relay safety output terminals.
- 6 Control output terminals for power supply to safety inputs and safety input terminals.
- 7 RJ45 connector for connection on Modbus serial link.
- 8 RESET button (resetting of controller).

##### Rear face:

- 9 Fixing plate for mounting on rail.

(1) Depending on controller model.

# Monitor and Processing

## Preventa configurable safety controllers

### Type XPSMCType XPSMC



XPSMC16Z



XPSMC32Z



XPSMC16ZC



XPSMC32ZC



XPSMC16ZP



XPSMC32ZP

### References

#### Configurable safety controllers (connector not included)

Number of inputs	Number of outputs		Communication (Link and bus)	Reference	Weight kg/lb
	Relay	Solid-state			
16	4 (2 x 2)	6	Modbus	XPSMC16Z	0.820/1.808
			Modbus, CANopen	XPSMC16ZC	0.820/1.808
			Modbus, Profibus	XPSMC16ZP	0.820/1.808
32	4 (2 x 2)	6	Modbus	XPSMC32Z	0.840/1.852
			Modbus, CANopen	XPSMC32ZC	0.840/1.852
			Modbus, Profibus	XPSMC32ZP	0.840/1.852

#### Plug-in connectors for configurable safety controllers (1)

Description	For use with	Reference	Weight kg/lb
Screw connectors	XPSMC16Z, MC16ZC, MC16ZP	XPSMCTS16	0.080/0.176
	XPSMC32Z, MC32ZC, MC32ZP	XPSMCTS32	0.110/0.243
Spring clip connectors	XPSMC16Z, MC16ZC, MC16ZP	XPSMCTC16	0.080/0.176
	XPSMC32Z, MC32ZC, MC32ZP	XPSMCTC32	0.110/0.243

#### Configuration software

■ Reference XPSMCWIN is the full version of configuration software XPSMCWIN version 2.4 and must be installed if no previous version of this software has been installed.

Description	Operating system	Languages	Reference	Weight kg/lb
Configuration software for controllers XPSMC●●Z● CD-ROM + user manual	Windows 7	FR, EN, DE, IT, ES, PT	XPSMCWIN	0.520/1.146
XPSMCWIN software update CD-ROM + user manual	Windows 7	Software update available on <a href="http://www.schneider-electric.com">www.schneider-electric.com</a>		

#### Starter packs

The Starter packs contain the necessary components to start using the safety controller containing:

- Safety controller (pack reference designates type of safety controller)
- XPSMCWIN configuration software
- Configurations cable
- Connectors

Description	Controller included in the pack	Reference	Weight kg/lb
Starter packs	XPSMC16Z	XPSMC16ZPACK	–
	XPSMC16ZC	XPSMC16ZCPACK	–
	XPSMC16ZP	XPSMC16ZPPACK	–
	XPSMC32Z	XPSMC32ZPACK	–
	XPSMC32ZC	XPSMC32ZCPACK	–
	XPSMC32ZP	XPSMC32ZPPACK	–

(1) To be ordered separately to the controllers.

## References

### Connecting cables (1)

Function	Length m/ft	Reference	Weight kg/ lb
Diagnostics using Magelis operator dialogue terminal type XBT GT	3/ 9.84	VW3A8306R30	1.130/ 2.491
Configuration software	USB / RJ45 cable: used to connect the controller to a PC Equipped with a USB connector (PC end) and an RJ45 connector (controller end)	TCSMCNAM3M002P	0.160 / 0.353



TCSMCNAM3M002P

Function	Medium	Length m/ft	Reference	Weight kg/ lb
----------	--------	----------------	-----------	---------------------

Modbus serial link access	Premium automation platform TSX SCY 21601	–	XPSMCSCY	–
CANopen bus access	1 CANopen connection cables (fitted with: 1 SUB-D 9-pin female connector at each end)	0.3/ 0.98	TSXCANCADD03	–
		1/ 3.28	TSXCANCADD1	–
		3/ 9.84	TSXCANCADD3	–
		5/ 16.40	TSXCANCADD5	–
		2 CANopen tap-off box	–	TSXCANTDM4
Standard CANopen cables	3	50/ 164.04	TSXCANCA50	–
		100/ 328.08	TSXCANCA100	–
		300/ 984.24	TSXCANCA300	–
		100/ 328.08	TSXPBSCA100	–
Profibus bus access		400/ 1312.33	TSXPBSCA400	–

### Power supply (1)

Regulated switch mode power supply, single-phase	Output voltage: 24...28.8 V ~ Nominal current: 10 A Nominal power: 240 W	ABL8RPS24100	1.000 / 2.205
--	--	--------------	------------------



ABL8RPS24100

(1) To be ordered separately to the controllers.

# Monitor and Processing

## Preventa modular safety controller type XPSMCM

### General overview

Maximize your business and machine performance with MachineStruxure

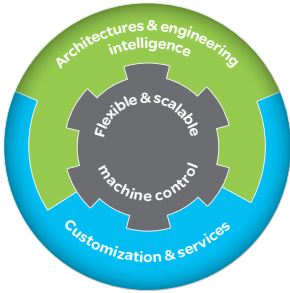

Machine builders like you are constantly looking for new ways to design and build more innovative machines in less time and at lower cost. MachineStruxure™ can help.

The NEXT generation of MachineStruxure is a complete machine automation solution that provides flexible and scalable machine control, ready-to-use architectures, efficient engineering solutions, and comprehensive customization and engineering support services. It can help you meet your challenges for improved efficiency and greater productivity, as well as allow you to deliver higher added value to your customers throughout the entire machine life cycle.

### Safety Chain Solutions

Save time by using the ready to use, and easy to adapt **certified Safety Chain Solutions**: the design of the machine, the re-use of the provided documentation with wiring diagram and documented calculations, for ease with the certification process.

3



Perimeter Guarding



Position Monitoring



Speed Monitoring



Enabling movement



Guard Monitoring



Emergency Stop

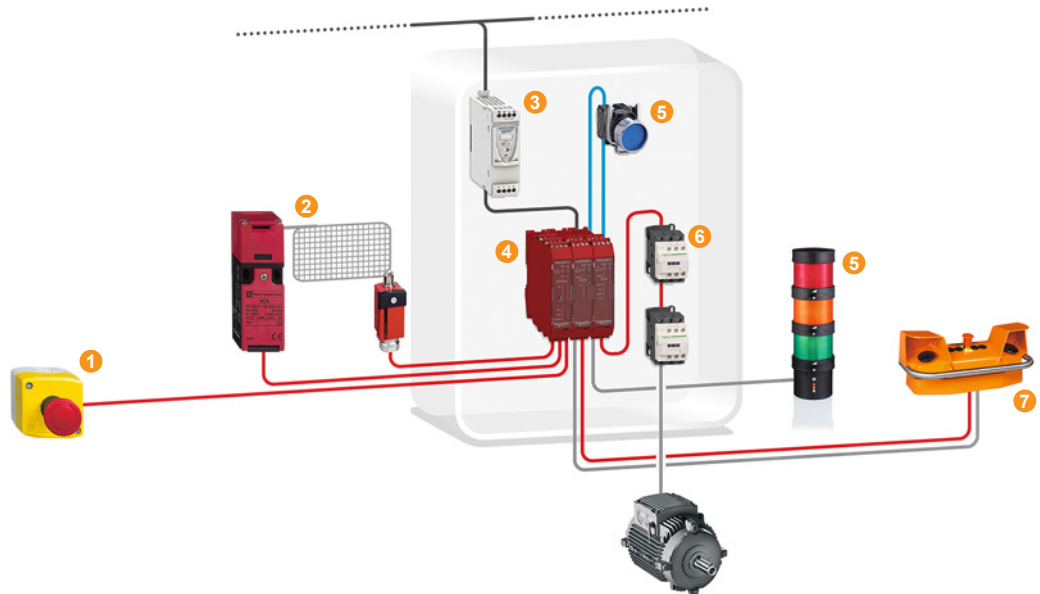

### Solution Breakdown

- 1 Harmony XALK emergency stop
- 2 OsiSense safety limit switches
- 3 Phaseo power supply 24 V ~
- 4 Preventa XPSMCM modular safety controller
- 5 Harmony signaling and control devices
- 6 TeSys D contactor
- 7 Harmony XY2SB two-hand control station

# Monitor and Processing

## Preventa modular safety controller type XPSMCM

### General overview

#### Improve efficiency

#### Flexible and scalable performance

Schneider Electric offer is covering all the safety functionality and scalability you need for your machine to improve efficiency:

- > Single function offer designed for standalone machines
- > Multi functional offer designed for standalone machines
- > Multi functional offer designed for machine lines with safe distributed architectures

Performance

#### Multi-function distributed



Preventa XPSMCM modular safety controller



Modicon TM5 Embedded safety PLC

#### Multi-function



Embedded safety for Altivar drives and Lexium 32 motion controllers



Preventa XPSMC safety controller

#### Single function



Traditional Preventa XPS safety module



Embedded Modicon TM3 safety functional module

Standalone

Embedded Safety Network

#### Increase profitability

#### Everything you need is embedded



Up to Cat. 4, PL e, SIL3

- > Find the exact match to your specifications
- > Optimize your configuration
- > Save space in a cabinet with less components
- > Expand from small to large configuration by a wide range of expansion and communication modules
- > Build up to 6 island architectures via safe communication up to 50 m between each island

Screw removable connector

Mini USB 2.0 configuration port

Communication via the expansion bus connector

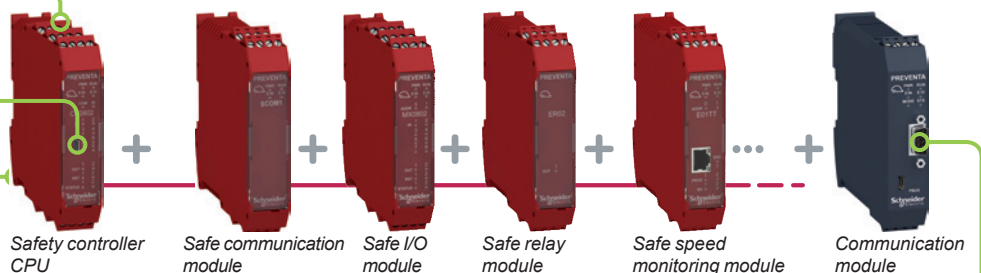

+ Network and Machine bus: Ethernet IP, Universal Serial Bus (USB), Modbus TCP

3

# Monitor and Processing

## Preventa modular safety controller

### type XPSMCM

#### General overview

Reduce your time to market

Intuitive automation with SoSafe Configurable

Easy configuration using intuitive software SoSafe Configurable

#### Configuration

- 1 Define hardware module configuration
- 2 Create project configuration by drag and drop of function blocks and assignment of inputs and outputs

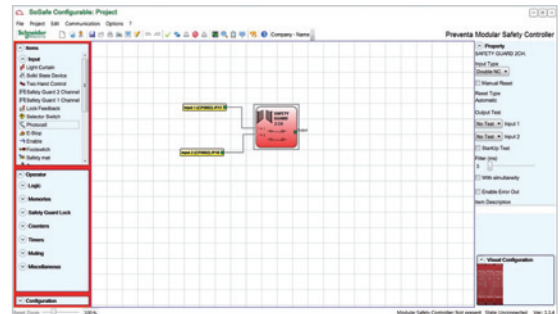

#### Online visualization & testing

- > Validate software configuration
- > View configuration behavior by online visualization in graphic or text views

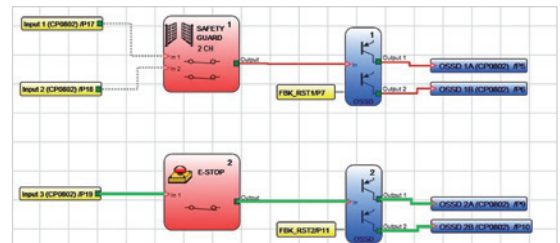

#### Commissioning

- > Use project documentation to support the wiring and safety calculation to complete the commissioning

**Preventa Modular Safety Controller**

Report generated by SoSafe Configurable version 1.3.4

Project Name: Project  
 Date: 01.10.2014 08:59:25  
 Subsystem: CRC: 0700

Module Safety Controller: Configuration  
 Module CP0002 (Configured Firmware version: FW = 2.0)  
 Module CP10 Side 0 (Minimum Required Firmware version: 0.1)  
 Module CP10 Side 0 (Minimum Required Firmware version: 0.0)  
 Updating from Memory used: Disabled: True

Module Safety Controller: Safety Information  
 PTFE (according to IEC 61508): 1.47E-009 (1/a)  
 MTTFE (according to IEC 61508-1): 175 years  
 Sdavg (according to IEC 61508-1): 99.10 %

The PTFE value above takes into account the failure rate of all the components with exclusion of external relays. For each Relay, output a new value must be added to the previous PTFE depending on the switching frequency and the load on the Relay output. However, the SC obtained for Relay output changes according to the customer configuration. See each Relay report for further details.

Attention!  
 This definition of PTFE and of the other related parameters as set forth in IEC 61508-1 only refers to the conditions implemented in the Module Safety Controller system by the SDC configuration software, assuming configuration has been performed correctly. The actual PTFE of the entire application and the relative parameters must consider data for all the devices connected to the Module Safety Controller system within the scope of the application. This task and any other aspect of system configuration are the exclusive responsibility of the user/installer.

The final MTTFE value, taking in account data for all the devices connected to the system, must always be estimated to 100 years if zero.

Resources used  
 CPUPT: 124 (1/24)  
 Function Block: 2  
 Total number blocks: 06 (0/66)  
 CPU-Relay: 20K (2/4)  
 Relay: 0K (0/2)

Electrical diagram  
 Safety Guard 2 Channel  
 Function Block 1  
 Filter mem: 0  
 Double NO  
 Reset Type: Automatic  
 StartUp Test: False  
 Connections:  
 In1: CP0002 CP0002/Terminal17  
 In2: CP0002 CPUPT/Terminal10

E-Stop  
 Function Block 2  
 Filter mem: 0  
 Single  
 Reset Type: Automatic  
 StartUp Test: False  
 Connections:  
 In1: CP0002 CPUPT/Terminal10

CP0002: CP00  
 Reset Type: Automatic  
 Response time: 15.000 ms  
 Dependence on inputs:  
 Function Block 1  
 Connections:  
 CP0002 CP0002/Terminal9  
 CP0002 CP0002/Terminal8  
 CP0002 PFA: Terminal17

CP0002: CP00  
 Reset Type: Automatic  
 Response time: 15.000 ms  
 Dependence on inputs:  
 Function Block 2  
 Connections:  
 CP0002 CP0002/Terminal9  
 CP0002 CP0002/Terminal10  
 CP0002 PFA: Terminal11

Signature \_\_\_\_\_

Simplify integration & maintenance

Connected everywhere

- > Variety of communication bus for diagnostics for automation systems (I/O status, alarm and alert information)
- > Live diagnostics with PC via USB connection
- > Removable memory card transferring configuration data to new controller without using a PC

Customization and services

Our experts help you every step of the way, from perfecting machine design to on-site services of the finished machine. Global support, 24/7 hotline services, and replacement parts centers around the world enable you to deliver superior customer support and satisfaction.



## Monitor and Processing

Preventa modular safety controller

type XPSMCM

General overview

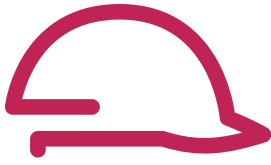

Schneider Electric – the provider of the complete safety chain powered by *Preventa technology*, helps you simply to reach the right level of safety for your machine!



3



**Approved**

> Safety chain solutions to achieve the safety level required



Make the most of your energy<sup>SM</sup>



# Monitor and Processing

## Preventa modular safety controller type XPSMCM

### System components

3

#### General presentation

The Preventa modular safety controller type XPSMCM is a modular configurable safety controller able to monitor multiple safety functions on and around a machine to minimise the risk of people accessing the dangerous moving parts of the machine.

This modular safety controller is designed for monitoring safety functions such as:

- > Emergency Stop
- > Guard Monitoring
- > Perimeter Guarding
- > Position Monitoring
- > Speed Monitoring
- > Enabling Movement

with input devices such as emergency stop pushbuttons, safety guard and limit switches, safety foot switches, safety light curtains and laser scanners, safety mats, safety encoders and proximity sensors, two-hand control stations and enabling switches.

#### XPSMCM system applications

The XPSMCM system offers numerous advantages compared to traditional safety modules, such as:

- > The hardware architecture of expansion modules and layout can be designed according to the machine specification and thus reduces the number of components and the footprint and wiring
- > Simplify input and output wiring by software configuration combining multiple functions together
- > Allowing machine scalability from 8 inputs and 2 outputs and up to 128 inputs and 16 outputs with the expansion modules connected directly to the controller or distributed among 6 islands
- > Connected everywhere with wide range of communication expansion modules
- > Provided with intuitive software for logical configuration, online visualization and testing, and commissioning
- > Simplification of machine maintenance through removable memory card, which can be used to transfer the configuration to a new controller without software

#### XPSMCM system components

The XPSMCM system is composed of:

- > A safety controller CPU, which can be used as standalone or together with expansion modules
- > Safe expansion modules: digital input modules, solid state and relay output modules, or mixed input/output modules
- > Safe speed monitoring modules for proximity sensors and safety encoders: Sin/Cos
- > Safe communication expansion modules for safe island creation
- > Non-safe communication modules: interfaces to network (Modbus TCP, Ethernet IP)
- > A configuration software: SoSafe Configurable
- > A memory card, available for saving configuration data for ease of maintenance and controller setup
- > Expansion bus connectors, for connecting safe modules to the safety controller CPU

#### Configuration software

The modular safety controller XPSMCM is supported by a completely intuitive software: **SoSafe Configurable**.

The software follows a simple drag and drop function block approach to configuration and is completed with a library of configurable safety functions and logical functions as well as easy to use tools for:

- > online configuration monitoring
- > configuration validator
- > hardware device scanner
- > printable schematics and documentation

SoSafe Configurable supports a quick and easy setup of the machine.

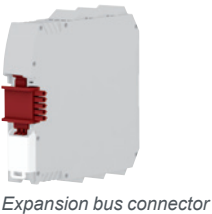

# Monitor and Processing

## Preventa modular safety controller type XPSMCM

### Certification – Directive and standards

#### General presentation

##### XPSMCM system certification

The XPSMCM system is certified by TÜV SÜD meeting the industrial safety standards of Category 4, PL e according to EN/ISO 13849-1 and SILCL 3 according to IEC/EN 61508 and IEC/EN 60261.

##### Directive and standards

**Preventa modular safety controller type XPSMCM complies with the following directives and standards.**

Directives and standards	Subject
2006/42/EC	Machinery Directive
2004/108/EC	Electromagnetic Compatibility (EMC)
2006/95/EC	Low Voltage Directive (LVD)
IEC/EN 61131-2	Programmable Controllers– Part 2: Equipment requirements and tests
EN/ISO 13849-1	Safety of machinery: Safety-related parts of control systems – Part 1: General principles for design
EN/ISO 13849-2	Safety of machinery: Safety-related parts of control systems – Part 2: Validation
EN 61496-1 (Type 4)	Safety of machinery: Electro-Sensitive Protection Equipment, Part 1: General requirements and tests
IEC/EN 62061	Safety of machinery – Functional safety of safety-related electrical, electronic and programmable electronic control systems
EN 61508-1	Functional safety of electrical, electronic and programmable electronic safety-related systems – Part 1: General requirements
EN 61508-2	Functional safety of electrical, electronic and programmable electronic safety-related systems – Part 2: Requirements for electrical, electronic and programmable electronic safety – related systems
EN 61508-3	Functional safety of electrical, electronic and programmable electronic safety-related systems – Part 3: Software requirements
IEC 61784-3	Industrial communication networks – Profiles – Part 3: Functional safety field buses – General rules and profile definitions
CE for Europe, cULus mark for USA and Canada	



# Monitor and Processing

## Preventa modular safety controller

### type XPSMCM

#### System components

3

#### Flexibility and scalability

The modular safety controller type XPSMCM provides flexibility and scalability starting with the main unit: the safety controller **XPSMCMCP0802**.

- > It embeds 8 safety digital inputs, 2 OSSD pairs and 2 status outputs. It is an appropriate solution for machines with a small number of safety functions requiring the configuration flexibility of a safety controller.
- > The safety controller **XPSMCMCP0802** can be used:
  - as standalone
  - and also with 14 expansion modules: the system is expandable up to 128 inputs and 16 outputs, ideal for machines requiring multiple safety function monitoring
- > Distributed architecture: it is possible to connect 6 islands up to 50 meters apart (164.04 ft.), using the safe expansion bus.

#### Expansion of the XPSMCM system

- > Minimum size of hardware: a safety controller **XPSMCMCP0802** is used as standalone.



> 8 safety digital inputs + 2 OSSD pairs + 2 status outputs

- > Maximum size of hardware: a safety controller **XPSMCMCP0802** connected to 14 expansion modules via the expansion bus connectors.

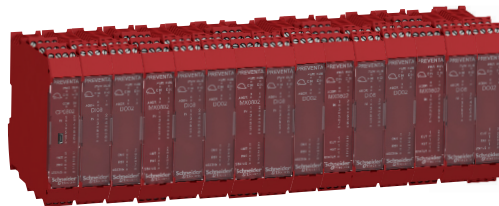

> 128 inputs and 16 OSSD pairs + 16 status outputs

#### Key figures of the XPSMCM system

Each of the XPSMCM system components are compact designed: a single module dimensions are 22.5 x 99 x 114.5 mm (0.89 x 3.9 x 4.51 in.), size of a typical safety relay.

The safe components are red colored and equipped with:

- 1 Removable screw-type terminal blocks for connecting the safety channels and/or the power supply
- 2 Slot for a memory card (only on safety controller)
- 3 L-shaped symmetrical rail locking clip
- 4 Slot for expansion bus connectors
- 5 LEDs displaying the status (I/O, communication, power supply, reset, ...)
- 6 Protective cover
- 7 Mini USB 2.0 connector for configuration (only on safety controller)

The non-safe components are black colored and equipped with:

- 8 Removable screw-type terminal blocks for connecting the power supply
- 9 L-shaped symmetrical rail locking clip
- 10 LEDs displaying the status (I/O, communication, power supply, reset, ...)
- 11 Specific connector for connecting to the machine bus or network (depending on model) (see page 3/118)
- 12 Mini USB 2.0 connector for configuration

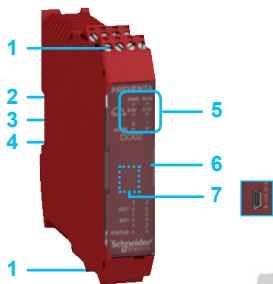

Safe components

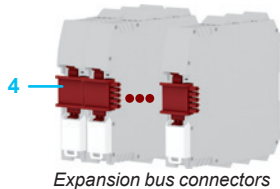

Expansion bus connectors



Non safe components: non-safe communication modules

# Monitor and Processing

## Preventa modular safety controller type XPSMCM

### System components

#### Flexibility and scalability

##### Safe communication with decentralized I/O's

The safety controller CPU has the possibility to create up to 6 decentralized safety related islands with a distance of 50 meters (164.04 ft.) between each island on a single Safety controller CPU.

- > The safety controller CPU, the expansion modules and the safe communication expansion modules communicate safely through the use of the expansion bus performed with the expansion bus connectors which are physically located on the back of each safe module.
- > The safe communication expansion modules are used in order to create safe decentralized islands (cabinets) ; they are connected in a line or tree configuration.
- > The islands can be expanded to 50 meters (164.04 ft.) between islands and use RS 485 cabling.
- > The order of the safe expansion modules connected with the expansion bus connectors is not important, the configuration automatically recognizes the architecture based on the module addressing.

#### Ethernet

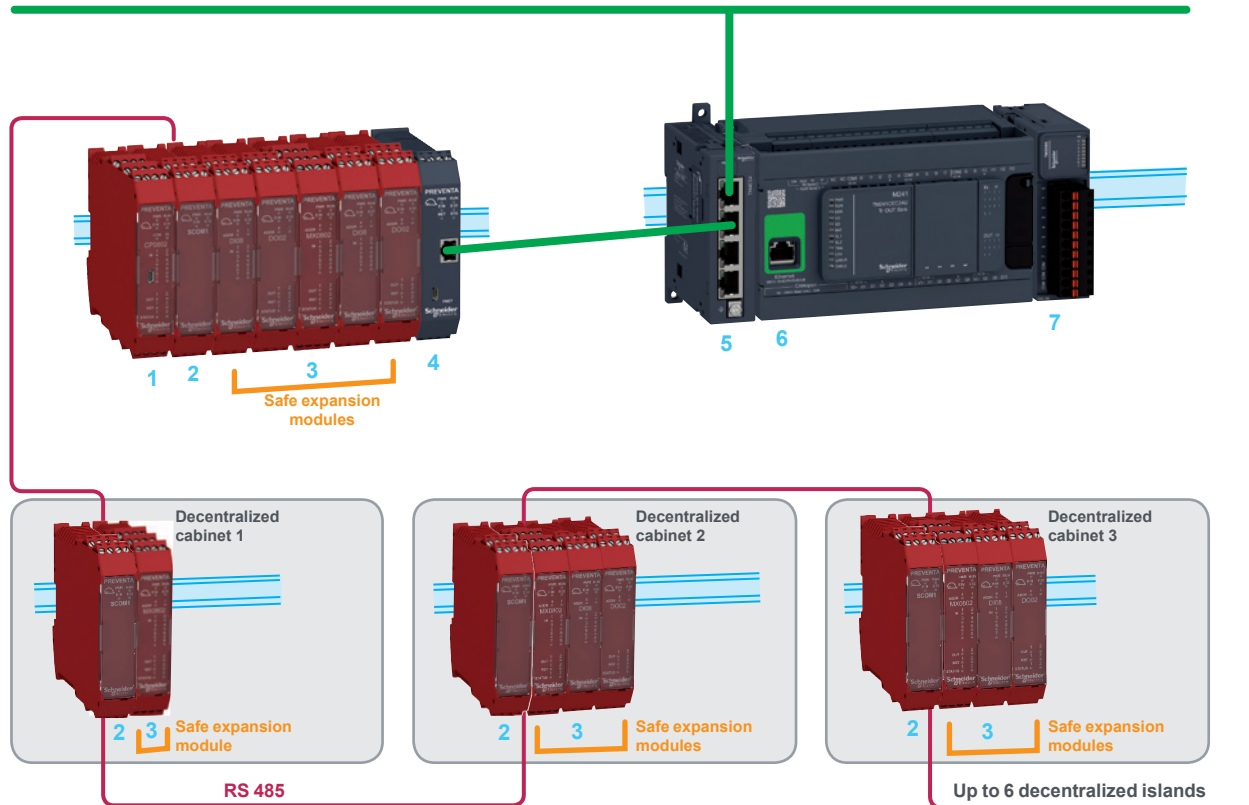

#### Safety related communication

— RS 485 serial interface shielded cable (up to 50 m / 164.04 ft.) between two decentralized islands)

- 1 Safety controller CPU
- 2 Safe communication expansion modules (line configuration)
- 3 Safe expansion modules: mixed I/O modules, Safe relay output modules, Safe speed monitoring modules for proximity sensors and safety encoders

#### Non-safety related communication

- 4 Non-safe communication modules: interfaces to network (Ethernet IP, ModbusTCP), for non-safety related communication
- 5 Modicon TM4 communication module (Ethernet switch module)
- 6 Modicon M241 logic controller
- 7 Modicon TM3 expansion I/O module

# Monitor and Processing

## Preventa modular safety controller type XPSMCM

### Safety controller, expansion modules



mini USB 2.0 connector for configuration

Safety controller CPU

3

#### XPSMCM system components

##### Safety controller

The safety controller XPSMCMCP0802 is designed to monitor a safety configuration.

Its configuration is created using the software SoSafe Configurable.

The safety controller CPU is also usable as a standalone device or able to be connected to any of the expansion units of the XPSMCM system such as I/O expansion modules, relay output modules, communication expansion modules, speed monitoring modules and non-safe fieldbus communication modules.

##### The safety controller features:

- > A configuration memory card (optional)
- > A LOG file containing the last 5 configuration modifications in chronological order, with date of modification
- > 24 terminals in 22.5 mm (0,89 in.)
- > Connection with other expansion modules via the expansion bus connectors (sold separately)
- > mini USB 2.0 connector for configuration

Safety controller reference	Description
XPSMCMCP0802	<ul style="list-style-type: none"> <li>&gt; 8 safety digital inputs</li> <li>&gt; 2 OSSD pairs with 400 mA output current</li> <li>&gt; 4 test outputs for line control monitoring of input circuits</li> <li>&gt; 2 inputs for Start/Restart interlock and external device monitoring (EDM)</li> <li>&gt; 2 configurable status outputs</li> </ul>

##### Expansion modules

6 types of expansion modules are available, designed for safety inputs or outputs.

The safety inputs/outputs are configurable individually or in pairs, with several possibilities:

- > Monitoring using line control monitoring via dedicated test outputs
- > Configurable filters and delays for each single input
- > Configurable output activation and de-activation delays
- > Independent control of pairs of outputs
- > Configurable diagnostic output signals
- > Simple diagnostics via front led signalling, configuration software, communication expansion modules

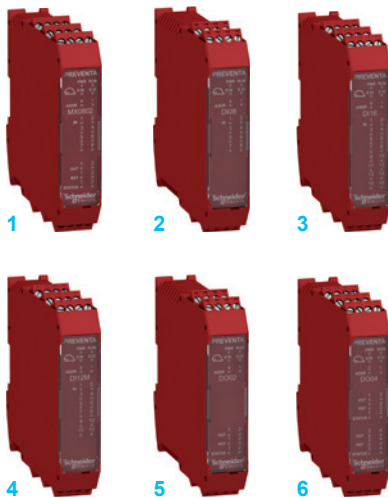

Safe expansion modules

Expansion module reference (item)	Description
XPSMCMX0802 (1)	<ul style="list-style-type: none"> <li>&gt; 8 digital inputs</li> <li>&gt; 2 OSSD pairs with 400mA output current</li> <li>&gt; 4 test outputs for line control monitoring of input circuits</li> <li>&gt; 2 configurable status outputs</li> <li>&gt; 2 inputs for Start/Restart interlock and external device monitoring (EDM)</li> </ul>
XPSMCMDI0800 (2)	<ul style="list-style-type: none"> <li>&gt; 8 digital inputs</li> <li>&gt; 4 test outputs for line control monitoring of input circuits</li> </ul>
XPSMCMDI1600 (3)	<ul style="list-style-type: none"> <li>&gt; 16 digital inputs</li> <li>&gt; 4 test outputs for line control monitoring of input circuits</li> </ul>
XPSMCMDI1200MT (4)	<ul style="list-style-type: none"> <li>&gt; 12 digital inputs</li> <li>&gt; 8 test outputs for line control monitoring: can monitor up to four 4-wire safety mats</li> </ul>
XPSMCMDO0002 (5)	<ul style="list-style-type: none"> <li>&gt; 2 OSSD pairs with 400mA output current</li> <li>&gt; 2 inputs for Start/Restart interlock and external device monitoring (EDM)</li> <li>&gt; 2 configurable status outputs</li> </ul>
XPSMCMDO0004 (6)	<ul style="list-style-type: none"> <li>&gt; 4 OSSD pairs with 400mA output current</li> <li>&gt; 4 inputs for Start/Restart interlock and external device monitoring (EDM)</li> <li>&gt; 4 configurable status outputs</li> </ul>

- > The Safe expansion modules are connected to the safety controller CPU via the expansion bus connectors.

# Monitor and Processing

## Preventa modular safety controller type XPSMCM

Safe relay output modules, Safe speed monitoring modules

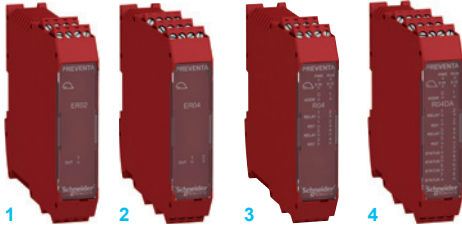

Safe relay output modules

### XPSMCM system components

#### Safe relay output modules

4 types of safe relay output modules are available.

Safe relay output module reference (item)	Description
XPSMCMER0002 (1)	<ul style="list-style-type: none"> <li>&gt; 2 forcibly guided contact safety relay output (2 NO + 1 NC) modules for 1 output without expansion bus connection</li> <li>&gt; 1 input for Start/Restart interlock and external device monitoring (EDM)</li> </ul>
XPSMCMER0004 (2)	<ul style="list-style-type: none"> <li>&gt; 4 forcibly guided contact safety relay output (2 NO + 1 NC) modules for 2 independent outputs without expansion bus connection</li> <li>&gt; 2 inputs for Start/Restart interlock and external device monitoring (EDM)</li> </ul>
<ul style="list-style-type: none"> <li>&gt; The safe relay output modules <b>XPSMCMER000●</b> do not require the expansion bus connectors as they are directly wired to the selected OSSDs.</li> </ul>	
XPSMCMRO0004 (3)	<ul style="list-style-type: none"> <li>&gt; 4 forcibly guided contact safety relay output modules with expansion bus connection</li> <li>&gt; Expansion module with 4 independent safety relay outputs and the corresponding 4 inputs for the external feedback contacts (EDM)</li> <li>&gt; The relay can be configured according to Category 1, 2 and 4 architectures</li> </ul>
XPSMCMRO0004DA (4)	<ul style="list-style-type: none"> <li>&gt; 4 forcibly guided contact safety relay output modules with expansion bus connection</li> <li>&gt; Expansion module with 4 independent safety relay outputs and the corresponding 4 inputs for the external feedback contacts (EDM)</li> <li>&gt; The relay can be configured according to Category 1, 2 and 4 architectures</li> <li>&gt; 8 configurable status outputs</li> </ul>
<ul style="list-style-type: none"> <li>&gt; The safe relay output modules <b>XPSMCMRO000●</b> are connected to the safety controller CPU via the expansion bus connectors.</li> </ul>	

#### Safe speed monitoring modules

The safe speed monitoring modules are designed to monitor zero speed control, max speed (limited speed), speed range and direction.

- > Up to four logically selectable limited speed thresholds (freely configurable via SoSafe Configurable software) for each logical input (axis)
- > The safe speed monitoring modules (excluding XPSMCMEN0200) are equipped with RJ 45 connectors (1 or 2 depending on the model) for encoders and terminal blocks for proximity switches
- > Max input frequency: 500 kHz for encoder monitoring and 5 kHz for proximity sensors
- > The modules can be configured with incremental encoders and PNP/NPN proximity switches as described below:

Safe speed monitoring module reference (item)	Description	Connector type
XPSMCMEN0100SC (1)	> 1 input for Sin/Cos encoder + 1 or 2 proximity switches	1x RJ 45 (ENC1) and terminal blocks for proximity sensor wiring
XPSMCMEN0200SC (2)	> 1 or 2 inputs for Sin/Cos encoders + 1 or 2 proximity switches	2x RJ 45 (ENC1/ENC2) and terminal blocks for proximity sensor wiring
XPSMCMEN0200 (3)	> 2 inputs for proximity switches	Terminal blocks for proximity sensor wiring

- > The safe speed monitoring modules are connected to the safety controller CPU via the expansion bus connectors.



Safe speed monitoring modules



# Monitor and Processing

## Preventa modular safety controller type XPSMCM

Safe communication expansion modules,  
Non-safe communication modules



Safe communication expansion modules

3

### XPSMCM system components

#### Safe communication expansion modules

The safe communication expansion modules enable the connection of XPSMCMCP0802 modular safety controller with the expansion modules placed at distances,  $\leq 50$  m ( $\leq 164$  ft.).

Using RS 485 shielded cable two XPSMCMCO0000S modules placed at the desired distance can be linked together thus joining the expansion modules to the Modular Safety Controller.

- > Each XPSMCMCO0000S2 safe communication expansion module has 2 independent connection channels; typically used in between 2 XPSMCMCO0000S1 modules.
- > The XPSMCMCO0000S1 safe communication expansion module has only one channel connection for transmitting/receiving data and must be connected as the first or last module.
- > Up to 6 islands can be created using the safe communication modules with a total length of 250 meters (820.2 ft.) and a maximum of 50 meters (164 ft.) between two safe communication modules. The system response time does not change with the use of the safety communication modules.

Safe communication expansion module reference (item)	Description
XPSMCMCO0000S1 (1)	> 1 connection interface: single channel transmitter/receiver (1)
XPSMCMCO0000S2 (2)	> 2 connections interface: dual channel transmitter/receiver

(1) End of the network or Start of the network if connected to a single RS 485 cable

#### Non-safe fieldbus communication modules

The non-safe communication modules are designed for diagnostics connection and data communication purposes to machine field bus or network systems.

non-safe communication module reference (item)	Machine bus/network interface	Connector type
XPSMCMCO0000EI (1)	> Ethernet IP	1x RJ 45 (in/out)
XPSMCMCO0000EM (2)	> Modbus TCP	1x RJ 45 (in/out)
XPSMCMCO0000UB (3)	> Universal Serial Bus	Mini USB

- > The non-safe communication modules are connected to the safety controller via the Expansion bus connector. Each of them have a mini USB 2.0 connector for configuration
- > Only one non-safe communication module type can be connected on a safety controller.



Non-safe communication modules



Memory card

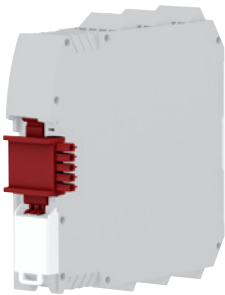

Expansion bus connector



SoSafe Configurable software

### XPSMCM system components

#### Accessories

##### ■ Memory card

**XPSMCMEM0000** is a removable memory card that can be used to save XPSMCM configuration data for subsequent transfer to a new device without using a PC.

- > The configuration in the XPSMCMEM0000 overwrites any other configuration present on the safety controller CPU XPSMCMCP0802, replacing this with that contained in the card.
- > This configuration replacement function can be disabled on the safety controller CPU via SoSafe Configurable software.
- > Overwrite operations are recorded in chronological order in the safety controller CPU XPSMCMCP0802 LOG file.

##### ■ Expansion bus connector

**XPSMCMCN0000SG** is an expansion bus connector:

- > It provides a safe communication between safe expansion components and the safety controller CPU.
- > Only the XPSMCMCP0802 safety controller CPU requires the purchase of the expansion bus connector. Each expansion module is provided with one expansion bus connector.

##### ■ Configuration cable

**TCSXCNAMUM3P** is a configuration cable to be used for software configuration between a PC, the safety controller CPU, and to the fieldbus communication modules.

- > Length 3 m (9.84 ft.)
- > It is equipped with USB connectors: USB A and USB mini B

##### ■ Safe communication cable

- > RS 485 serial interface shielded cable are used between the safe communications expansion modules to create up to 6 decentralized safety related islands
- > Available lengths: 10 to 50 m (32.81 to 164.04 ft.)

##### ■ Encoder splitter cable

- > The encoder splitter cable enables the connection of an embedded encoder within the PacDrive M motion system to the speed monitoring module of the modular safety controller
- > Available lengths: 1 to 5 m (3.3 to 16.4 ft.)

#### Software

The SoSafe Configurable software, installed on a PC, is used to create complex logical conditions using logical operators and safety functions, such as muting, timer, counters, memories, etc. via a simple and intuitive graphic configuration interface. Configuration data are transferred to the safety controller CPU XPSMCMCP0802 via a USB link.



# Monitor and Processing

## Preventa modular safety controller

### type XPSMCM

#### System components



XPSMCMCP0802



XPSMCMMX0802



XPSMCMMDI0800



XPSMCMMDI1600



XPSMCMMDI1200MT



XPSMCMDO0002



XPSMCMDO0004



XPSMCMER0002



XPSMCMER0004



XPSMCMRO0004



XPSMCMRO0004DA



XPSMCMEN0100SC



XPSMCMEN0200SC



XPSMCMEN0200

#### Safety controller

Description	Inputs (number & type)	Outputs (number & type)	Connector type	Reference	Weight kg/lb
<b>Safety controller CPU</b>	8 digital inputs + 2 for Start/Restart interlock	2 OSSD pairs + 4 test outputs + 2 status outputs	Screw	<b>XPSMCMCP0802</b>	0.250 0.55

#### Safe expansion modules

##### Safe expansion I/O modules

Description	Inputs (number & type)	Outputs (number & type)	Connector type	Reference	Weight kg/lb
<b>Safe mixed I/O expansion modules</b>	8 digital inputs + 2 for Start/Restart interlock	2 OSSD pairs + 4 test outputs + 2 status outputs	Screw	<b>XPSMCMMX0802</b>	0.250 0.55
<b>Safe input expansion modules</b>	8 digital inputs	4 test outputs	Screw	<b>XPSMCMMDI0800</b>	0.230 0.51
	16 digital inputs	4 test outputs	Screw	<b>XPSMCMMDI1600</b>	0.250 0.55
	12 digital inputs	8 test outputs for 4 wires safety Mats	Screw	<b>XPSMCMMDI1200MT</b>	0.250 0.55
<b>Safe output expansion modules</b>	2 for Start/Restart interlock	2 OSSD pairs + 2 status outputs	Screw	<b>XPSMCMDO0002</b>	0.230 0.51
	4 for Start/Restart interlock	4 OSSD pairs + 4 status outputs	Screw	<b>XPSMCMDO0004</b>	0.250 0.55

##### Safe relay output modules

<b>Safe relay output modules (without expansion bus connection)</b>	1 for Start/Restart interlock	2 relays for 1 output (2 NO + 1 NC)	Screw	<b>XPSMCMER0002</b>	0.250 0.55
	2 for Start/Restart interlock	4 relays for 2 independant outputs (4 NO + 2 NC)	Screw	<b>XPSMCMER0004</b>	0.300 0.66
<b>Safe relay output modules (wiring with the expansion bus connector)</b>	4 for Start/Restart interlock	4 relays	Screw	<b>XPSMCMRO0004</b>	0.300 0.66
	4 for Start/Restart interlock	4 relays with 8 status outputs	Screw	<b>XPSMCMRO0004DA</b>	0.330 0.73

##### Safe speed monitoring modules

Description	Inputs (number & type)	Connector type	Reference	Weight kg/lb
<b>Safe speed monitoring modules</b>	<ul style="list-style-type: none"> <li>■ 1 Sin/Cos encoder and 2 proximity sensor inputs</li> <li>■ 1x RJ 45 (ENC1)</li> <li>■ Proximity sensor connection via terminal blocks</li> </ul>	Screw	<b>XPSMCMEN0100SC</b>	0.280 0.62
	<ul style="list-style-type: none"> <li>□ Up to 2 Sin/Cos encoders and 2 proximity sensor inputs</li> <li>□ 2x RJ 45 (ENC1/ENC2)</li> <li>□ Proximity sensor connection via terminal blocks</li> </ul>	Screw	<b>XPSMCMEN0200SC</b>	0.300 0.66
	<ul style="list-style-type: none"> <li>□ 2 inputs for proximity switches</li> <li>□ Proximity sensor connection via terminal blocks</li> </ul>	Screw	<b>XPSMCMEN0200</b>	0.230 0.51

# Monitor and Processing

## Preventa modular safety controller

### type XPSMCM

#### System components



XPSMCMCO0000S1 XPSMCMCO0000S2



XPSMCMCO0000EI XPSMCMCO0000EM XPSMCMCO0000UB



XPSMCMCN0000SG



XPSMCMME0000

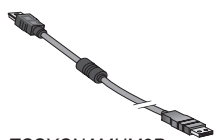

TCSXCNAMUM3P



TSXSCMCN000



TSXESPPM000



TSXESPP300

### Safe expansion modules

#### Safe communication expansion modules

Description	Characteristics	Connector type	Reference	Weight kg/lb
Safe RS 485 bus expansion module for remote extension	1 connection interface: single channel transmitter/receiver network connection	Screw	XPSMCMCO0000S1	0.300 0.66
	2 connections interface: dual channel transmitter/receiver network connection	Screw	XPSMCMCO0000S2	0.300 0.66

#### Non-safe communication modules

Description	Field bus / network type Connector type	Connector type	Reference	Weight kg/lb
Non-safe communication modules	<input checked="" type="checkbox"/> Ethernet IP <input type="checkbox"/> 1x RJ 45 (in/out)	Screw	XPSMCMCO0000EI	0.300 0.66
	<input checked="" type="checkbox"/> Modbus TCP <input type="checkbox"/> 1x RJ 45 (in/out)	Screw	XPSMCMCO0000EM	0.300 0.66
	<input checked="" type="checkbox"/> Universal Serial Bus <input type="checkbox"/> 1x Mini USB	Screw	XPSMCMCO0000UB	0.300 0.66

### Accessories

Description	Application	Reference	Weight kg/lb
Expansion bus connector (1)	For connecting the various expansion modules to the safety controller CPU	XPSMCMCN0000SG	0.001 0.002
Memory card	For saving configuration data for subsequent transfer to a new device without using a PC	XPSMCMME0000	0.004 0.009

Description	Use	Length	Reference	Weight kg/lb
Configuration cable	For software configuration, between a PC, the safety controller CPU, and to the fieldbus communication modules Equipped with 2x USB connectors: USB A and USB mini B	3 m / 9.84 ft	TCSXCNAMUM3P	0.065 0.143
		10 m / 32.81 ft	TSXSCMCN010	0.920 2.03
RS 485 shielded cables	Between two safe communication expansion modules	25 m / 82.02 ft	TSXSCMCN025	2.300 5.07
		50 m / 164.04 ft	TSXSCMCN050	4.600 10.14
		1 m / 3.3 ft	TSXESPPM001	0.110 0.24
Encoder splitter cables	Between SIN/COS safe speed monitoring module and PacDrive M drives and the associated servo motors	3 m / 9.84 ft	TSXESPPM003	0.310 0.68
		5 m / 16.40 ft	TSXESPPM005	0.510 1.12
		1 m / 3.3 ft	TSXESPP3001	0.150 0.33
	3 m / 9.84 ft	TSXESPP3003	0.450 0.99	
	5 m / 16.40 ft	TSXESPP3005	0.750 1.65	

(1) This reference needs to be ordered for the XPSMCMCP0802 reference only when it is connected to expansion modules.

# Monitor and Processing

## Preventa modular safety controller type XPSMCM

Configuration software: SoSafe Configurable

3

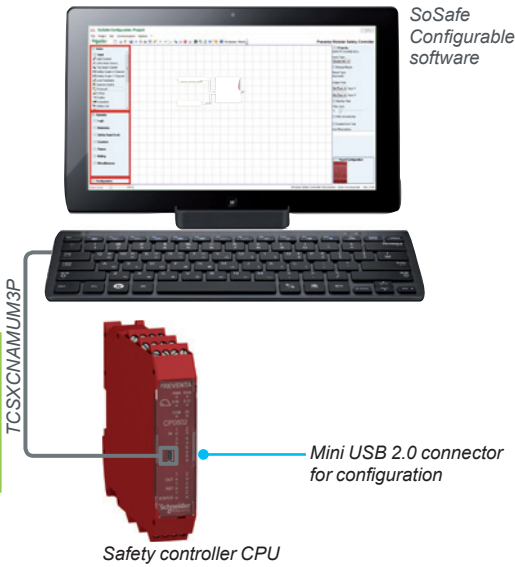

### Configuration software: SoSafe Configurable

SoSafe Configurable is used to create complex logical conditions using logical operators and safety functions, such as muting, timer, counters, memories, etc. via a simple and intuitive graphic configuration interface. Configuration data are transferred to the safety controller XPSMCMCP0802 via a USB link.

- > XPSMCMCP0802 safety controller has a mini USB 2.0 connection to connect to a PC where the **SoSafe Configurable** software is installed.
- > An application held on XPSMCMCP0802 safety controller can be saved on the memory card (optional) for fast transfer of the configuration data to other modules.

#### Password

The SoSafe Configurable software is protected with 2 levels of alphanumerical password (max 8 characters.)

- > The level 1 password is an operation and maintenance password. It allows only to view the LOG file, the composition of the system and use the real time MONITOR.
- > The level 2 password enables all features of the software to be accessible. Allowing to load, modify, save, and download (from the PC to XPSMCMCP0802 safety controller) a project configuration.

#### LOG file (Level 1 password).

A log file with the creation date and CRC checksum (4-digit hexadecimal identification) of a project are stored in the safety controller CPU.

- > A logbook can record up to 5 consecutive events, after which these are overwritten, starting from the least recent event.
- > The log file can be visualized using the icon in the standard tool bar.

### Main features

#### SoSafe Configurable software main features are:

- > "Drag & Drop" configuration of all safety functions and logic
- > Functional validation of design
- > 2-level password management for the prevention of unauthorised access and therefore of incidental modifications or tampering with system configuration
- > Configuration of parameters of function blocks, for example:
  - single – or double – channel NO or NC inputs
  - test outputs for monitoring of electro-mechanical input devices and photocells and related electrical connections
  - automatic, manual and monitored manual restart
  - synchronisation control of two channels
  - contact anti-rebound filters and timers
  - start-up test.
- > Single or bi-directional 2 or 4 sensor muting function blocks
- > Online monitoring of I/O status
- > Project documentation and schematics

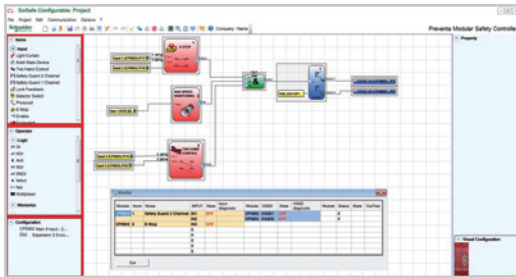

Text visualization

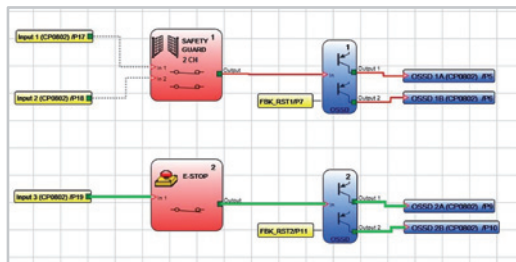

Graphic visualization

The I/O MONITOR allows the real-time monitoring of all the I/O of a Preventa XPSMCM system and the diagnostic information about a working system.

### System requirements

SoSafe Configurable software runs on PC with:

- > RAM: 256 MB
- > Hard disk: free space > 300 MB
- > USB connector: 1.1 or 2.0
- > Microsoft Windows® XP SP3 (service Pack 3) / Vista 32-bit, Microsoft Windows® 7 32 and 64-bit, Microsoft Windows® 8.1 32 and 64-bit
- > Microsoft Framework 3.5 (or higher).

Safety level parameters		
Parameter	Value	Standard
PFH <sub>d</sub>	$\geq 10^{-8}$ PFH <sub>d</sub> < $10^{-7}$	IEC 61508
SIL	3	
SILCL	3	IEC 62061
Type	4	EN 61496-1
PL	e	ISO 13849-1
DC <sub>avg</sub>	High	
MTTF <sub>d</sub> (years)	100 years	
Category	4	
Operation life time	20 years	

Configuration software for XPSMCM system			
Description	Characteristics	Reference	Weight kg / lb
SoSafe Configurable	<ul style="list-style-type: none"> <li><input type="checkbox"/> Version 1.0</li> <li><input type="checkbox"/> Availability: downloadable from Schneider website</li> <li><input type="checkbox"/> User manual included</li> <li><input type="checkbox"/> Available languages: English, French, Italian, German, Spanish, Chinese and Japanese</li> <li><input type="checkbox"/> Microsoft Windows® XP SP3 / Vista, Microsoft Windows® 7, Microsoft Windows® 8.1</li> <li><input type="checkbox"/> Minimum PC requirement: 256 MB RAM, 300 MB mini. free space on Hard drive</li> <li><input type="checkbox"/> mini USB connector 1.1 or 2.0</li> </ul>	XPSMCMW0000V10	—



XPSMCMW0000V10

# Monitor and Processing

## Preventa modular safety controller

### type XPSMCM

#### SoSafe Configurable software: operator function blocks

3

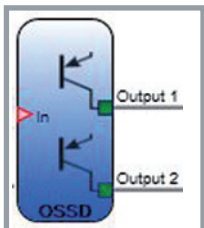
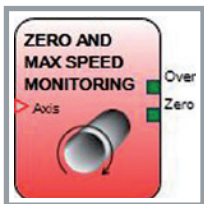
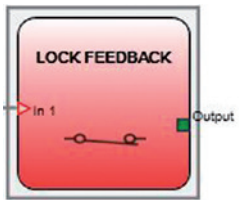
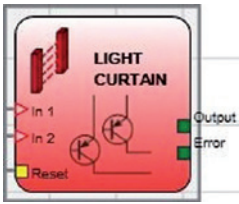
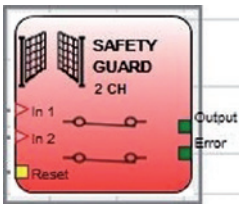
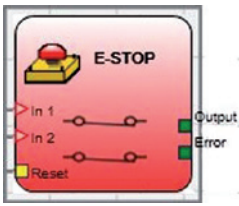

### Function blocks

#### Input objects

<b>E-STOP</b>	Verifies an emergency stop device inputs status. If the emergency stop button has been pressed (contacts open) the output is 0. If not the output is 1.
<b>SAFETY GUARD</b>	Verifies a mobile guard or safety gate device input status. If the mobile guard or safety gate is open, the output is 0. Otherwise the output is 1.
<b>ENABLE (enable key)</b>	Verifies a manual key device Input status. If the key is not turned the output is 0. Otherwise the output is 1.
<b>LIGHT CURTAIN (optoelectronic safety light curtain / laser scanner)</b>	Verifies an optoelectronic safety light curtain (or laser scanner) inputs state. If the area protected by the light curtain is occupied, (light curtain outputs 0) the output is 0. Otherwise, with the area clear and outputs to 1 the output of this function block is 1.
<b>FOOTSWITCH (safety pedal)</b>	Verifies the status of the inputs of a safety pedal device. If the pedal is not pressed the output is 0. Otherwise the output is 1.
<b>PHOTOCELL (safety photocell)</b>	Verifies the status of the inputs of an optoelectronic safety photocell. If the beam of the photocell is occupied (photocell output 0) the output is 0. Otherwise with the beam clear and an output of 1 the output is 1.
<b>SELECTOR SWITCH</b>	Verifies the status of the inputs from a mode selector (up to 4 inputs). If only one input is 1 the corresponding output is also 1. In all other cases, and thus when all inputs are 0 or more than one input is 1 all the outputs are 0.
<b>TWO HAND CONTROL</b>	Verifies the status of the inputs of a two hand control switch. If both the buttons are pressed within 500 msec the output is 1. Otherwise the output is 0.
<b>SAFETY MAT (safety mat or safety edge)</b>	Verifies the status of the inputs of a safety mat or safety edge. If a person stands on the mat the output is 0. Otherwise, with the mat clear, the output is 1. Test outputs must be used. Cannot be used with 2-wire mats and termination resistance mats.
<b>ENABLE SWITCH</b>	Verifies the input Inx status of an Enabling Switch. In the event that the switch is not pressed (position 1) or completely pressed (position 3), the OUTPUT will be 0. If it is pressed in the middle (position 2), the output will be 1.
<b>TESTABLE SAFETY DEVICE</b>	The function can be used with every generic input either one or two channels and either NO or NC contacts.
<b>SENSOR</b>	Verifies the status of the input of a sensor (non-safety sensor). If the beam of the sensor is occupied (sensor output 0) the output is 0. Otherwise, with the beam clear and an output of 1 then the output is 1.
<b>LOCK FEEDBACK</b>	Verifies the feedback from the Guardlock solenoid generating a 1 when the guardlock is locked and 0 when open.
<b>SWITCH</b>	Verifies the input status of a pushbutton or switch (non-safety switch). If the pushbutton is pressed the output is 1. Otherwise, the output is 0.
<b>SOLID STATE DEVICE</b>	Verifies INx input status. If the the inputs are High the output is 1 else 0.
<b>FIELD BUS INPUT</b>	Verifies the fieldbus input value signals (up to 8 bits) from the machine control unit via the field-bus module. The signal is connected directly into the configuration.
<b>LL0</b>	0 input value
<b>LL1</b>	1 input value

#### Speed Monitoring

<b>Zero Speed Monitoring</b>	Verifies the speed of a device generating an output 1 when the speed is 0. If the speed is different from 0 generates an output 0 .
<b>Zero and Max Speed Monitoring</b>	Verifies the speed of a device generating an output Zero = 1 when the speed is 0. If the speed is different from 0 generates an output Zero = 0. Moreover, this block verifies the speed of a device generating an output Over = 0 when the speed is over a defined threshold.
<b>Maximum Speed Monitoring</b>	Verifies the speed of a device generating an output 0 when the speed is over a defined threshold.
<b>Speed Range Monitoring</b>	Verifies the speed of a device generating an output 1 when the speed is inside a defined range.

#### Output objects

<b>OSSD (safety outputs)</b>	The OSSD semiconductor PNP safety static output pair. The 2 output cannot operate independently. Each OSSD pair can work in both AUTO/Manual restart mode and can perform the EDM of external relays or contactors using the dedicated RESTART_FBK input.
<b>STATUS (signal output)</b>	The Status outputs are non-safety diagnostic outputs which can be used to provide the status of part of the logic within the configuration.
<b>Relay</b>	The Relay output is used with the XPSMCMR0004 modules and is configurable to Category 1, 2 and 4.
<b>FIELD BUS PROBE OUTPUT</b>	The fieldbus probe is used to provide the status of part of the logic within the configuration to a PLC or HMI device.

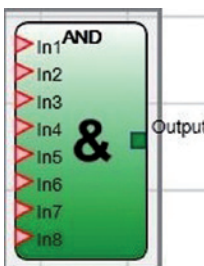
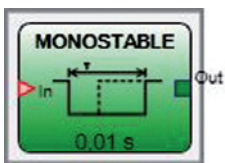
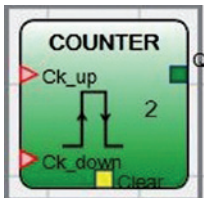
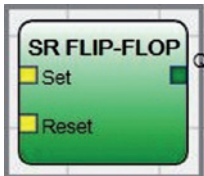
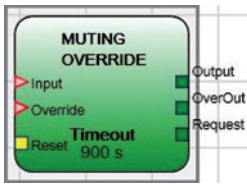
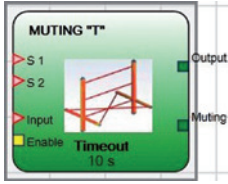

### Function blocks

#### Muting operators

<b>MUTING "L" with 2 Muting sensors, only for one-way openings</b>	Monitors the 2 muting sensors along with the light curtain for L Muting setup.
<b>MUTING "T" with 2 Muting sensors for two-way openings</b>	Monitors the 2 muting sensors along with the light curtain for T Muting setup.
<b>MUTING "Sequential" with 4 Muting sensors for two-way openings</b>	Monitors the 4 muting sensors along with the light curtain for sequential Muting setup.
<b>MUTING "Concurrent" with 4 Muting sensors for two-way openings</b>	Monitors the 4 muting sensors along with the light curtain for concurrent Muting setup.
<b>MUTING OVERRIDE</b>	<p>OVERRIDE command forces the output high allowing to remove the material obstructing the gate.</p> <p>Two different operations are available:</p> <ol style="list-style-type: none"> <li>1 Manual action with hold to run</li> <li>2 Automatic with pulse command</li> </ol>

#### General/Miscellaneous

<b>Serial Output</b>	Transfers the state of up to a maximum of 8 inputs into a serial line data output.
<b>Network</b>	Allows to distribute in a local network Stop and Reset commands between XPSMCMCP0802 controllers.
<b>Interpage IN and Interpage OUT</b>	Memory bit which are reused from inputs to multiple outputs.

#### Memory operators

<b>D FLIP FLOP</b>	Saves the previously set status on output Q on the clock rising edge.
<b>SR FLIP FLOP</b>	Provides an output Q at 1 with Set, 0 with Reset.
<b>USER RESTART MANUAL</b>	Used to create a common reset for multiple input functions on rising edge of the reset input.
<b>USER RESTART MONITORED</b>	Used to create a common reset for multiple input functions on rising edge and falling edge of the reset input.

#### Counter operator

<b>COUNTER</b>	The counter generates a pulse as soon as the set count is reached.
----------------	--

#### Timer operators

<b>PULSE GENERATOR</b>	Generates a clock signal output with the desired period if the input In is 1.
<b>MONOSTABLE</b>	Generates a level 1 output activated by the rising edge of the input and remains in this condition for the set time.
<b>PASSING MAKE CONTACT</b>	The output follows the signal on the input. However, if this is 1 for longer than the set time, the output changes to 0.
<b>DELAY</b>	Applies a delay to a signal by setting the output to 1 after the set time, against a change in the level of the input signal.

#### Logical operators

<b>AND</b>	Returns 1 as output if all the inputs are 1
<b>NAND</b>	Returns 0 as output if all the inputs are 1.
<b>NOT</b>	Inverts the logical status of the input.
<b>OR</b>	Returns 1 as output if at least one of the inputs is 1.
<b>NOR</b>	Returns 0 as output if at least one of the inputs is 1.
<b>XOR</b>	Returns 0 as output if all the inputs are in the same logical status.
<b>XNOR</b>	Returns 1 as output if all the inputs are in the same logical status.
<b>MULTIPLEXER</b>	Forwards the signal of the inputs to the output according to the Sel selection.

# Stop the machine

## Mini-VARIO and VARIO switch disconnectors

Applications

Mini-Vario and Vario rotary switch disconnectors from 12 to 175 A are suitable for on-load making and breaking of resistive or mixed resistive and inductive circuits where frequent operation is required. They can also be used for direct switching of motors in utilisation categories AC-3 and DC-3. Vario switch disconnectors are suitable for isolator applications with fully visible breaking (since the handle cannot indicate the "open" position unless all the contacts are actually open and separated by the appropriate isolation distance) and it is possible to padlock the handles in the open position.



Application	Standard applications			
Presentation	Bare switches		Enclosed switches	
Assembly	Pre-assembled	For customer assembly	Pre-assembled	For customer assembly
Thermal current	12 and 20 A		10...32 A	10 and 16 A
Operational current AC-23 at 400 V	8.1 and 11 A		8.1...29 A	8.1...11 A
Number of poles	3	3...5	3	3...5
Number of auxiliary contacts	-	1 or 2	-	1 or 2
Reversible terminal blocks	Yes			
Mounting	On door	At back of enclosure	On door or at back of enclosure	-
Operator	Direct	Offset with door interlock mechanism	Direct or offset with door interlock mechanism	Direct
Switch type	VCDN12 VCDN20	VCCDN12 VCCDN20	VN12 VN20	VCFN12GE to VCFN40GE VN12, VN20 + VCFX GE1
More information	Please refer to our web site, <a href="http://www.schneider-electric.com">www.schneider-electric.com</a>			

Mini-Vario and Vario rotary switch disconnectors from 12 to 175 A are suitable for on-load making and breaking of resistive or mixed resistive and inductive circuits where frequent operation is required. They can also be used for direct switching of motors in utilisation categories AC-3 and DC-3. Vario switch disconnectors are suitable for isolator applications with fully visible breaking (since the handle cannot indicate the "open" position unless all the contacts are actually open and separated by the appropriate isolation distance) and it is possible to padlock the handles in the open position.

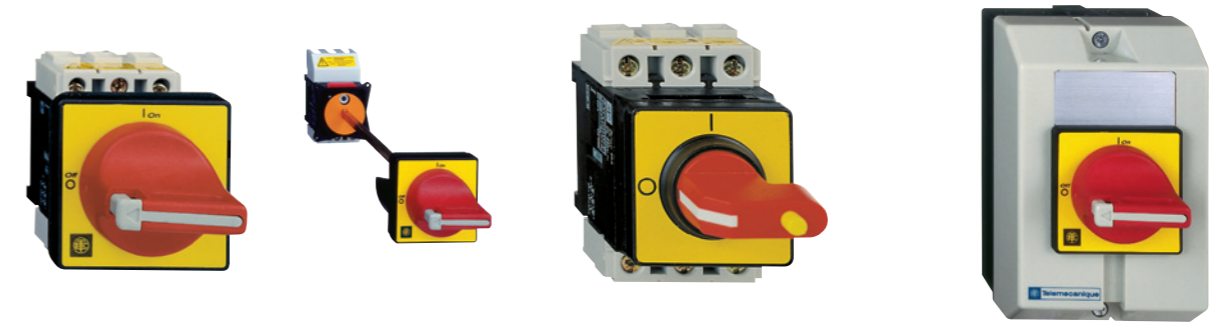

High performance applications					
Bare switches			Enclosed switches		
Pre-assembled		For customer assembly	Pre-assembled		For customer assembly
12...175 A			10...140 A		10...63 A
8.1...83 A			8.1...41 A		
3		3...6 (up to 80 A) 3 (for 125 and 175 A ratings)	3		3...6
-		1 or 2	-		2
Yes					
On door	At back of enclosure		In enclosure or modular distribution boards	On door, at back of enclosure, in enclosure or modular distribution boards	
Direct	Indirect with door interlock mechanism		Direct	Direct or indirect with door interlock mechanism	
V02 to V6	VCC02 to VCC6	VVE0 to VVE4	V02 to V6	VCF02GE to VCF6GE	V02 to V4 + VCFX GE1 to VCFX GDXE
Please refer to our web site, <a href="http://www.schneider-electric.com">www.schneider-electric.com</a>					

# Stop the machine

## Mini-VARIO switch disconnectors for standard applications

### Complete units

- 3-pole rotary switch disconnectors, 12 to 20 A
- Padlockable operating handle (padlocks not supplied).
- Degree of protection IP 65.
- Marking on operator  $\circ \downarrow$ .



VCDN20



VCCDN20

3

#### Main and Emergency stop switch disconnectors

##### For door mounting

Operator	Front plate	Fixing	Ith	Reference	Weight
Handle	mm	mm	A		kg
Red, padlockable with up to 3 padlocks (Ø 4 to Ø 8)	Yellow 60 x 60	Ø 22.5	12	VCDN12	0.177
			20	VCDN20	0.177

#### Main and Emergency stop switch disconnectors

##### For mounting at back of an enclosure (1)

Operator	Front plate	Fixing	Ith	Reference	Weight
Handle	mm	mm	A		kg
Red, padlockable with up to 3 padlocks (Ø 4 to Ø 8)	Yellow 60 x 60	Ø 22.5	12	VCCDN12	0.334
			20	VCCDN20	0.334

(1) Switches supplied with a shaft extension VZN17 and a door interlock plate KZ 32.



# Stop the machine

## Mini-VARIO switch disconnectors for standard applications

For customer assembly



VN20



VZN11



VZN14



VZN05

Switch bodies			
Description	Rating A	Reference	Weight kg
3-pole switch disconnectors	12	VN12	0.110
	20	VN20	0.110

Add-on modules			
Description	Rating A	Reference	Weight kg
Main pole modules	12	VZN12	0.020
	20	VZN20	0.020
Neutral pole module with early make and late break contacts	12 and 20	VZN11	0.020
Earthing module	12 and 20	VZN14	0.016
Auxiliary contact block modules	1 N/O late make contact	VZN05	0.020
	1 N/C early break contact	VZN06	0.020
Input terminal protection shrouds	For add-on pole modules or auxiliary contact block modules (single-pole shroud)	VZN26	0.004
	For switch bodies (3-pole shroud)	VZN08	0.007

3

### Maximum number of add-on modules that can be fitted on a switch body

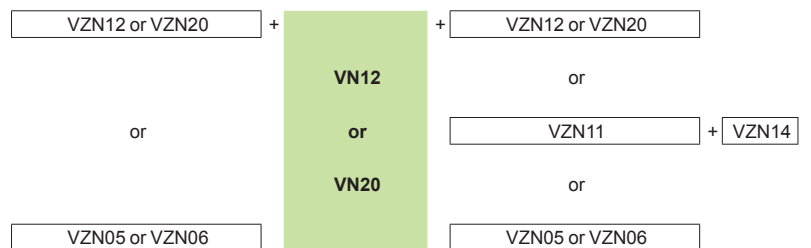

# Stop the machine

## VARIO switch disconnectors for high performance applications

### Complete units



VCF0



VCF5



VCCF0

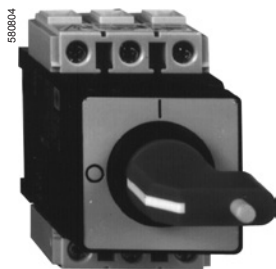

VVE1

- 3-pole rotary switch disconnectors, 12 to 175 A
- Marking on operator  $\circ \downarrow$ .
- Padlockable operating handle (padlocks not supplied). Degree of protection IP 65.

#### Main and Emergency stop switch disconnectors

##### For door mounting

Handle	Front plate mm	Fixing	Rating A	Reference	Weight kg
Red, padlockable with up to 3 padlocks ( $\varnothing$ 4 to $\varnothing$ 8)	Yellow 60 x 60	$\varnothing$ 22.5	12	VCD02	0.215
			20	VCD01	0.215
			25	VCD0	0.215
			32	VCD1	0.215
			40	VCD2	0.215
		4 screws	12	VCF02	0.250
			20	VCF01	0.250
			25	VCF0	0.250
			32	VCF1	0.250
			40	VCF2	0.250
			63	VCF3	0.560
Red, long, padlockable with up to 3 padlocks ( $\varnothing$ 4 to $\varnothing$ 8)	Yellow 90 x 90	4 screws	125	VCF5	1.200
			175	VCF6	1.200

##### For mounting at back of an enclosure (1)

Handle	Front plate mm	Fixing	Rating A	Reference	Weight kg
Red, padlockable with up to 3 padlocks ( $\varnothing$ 4 to $\varnothing$ 8)	Yellow 60 x 60	$\varnothing$ 22.5	12	VCCD02	0.392
			20	VCCD01	0.392
			25	VCCD0	0.392
			32	VCCD1	0.392
			40	VCCD2	0.392
		4 screws	12	VCCF02	0.527
			20	VCCF01	0.527
			25	VCCF0	0.527
			32	VCCF1	0.527
			40	VCCF2	0.527
			63	VCCF3	0.440
Red, long, padlockable with up to 3 padlocks ( $\varnothing$ 4 to $\varnothing$ 8)	Yellow 90 x 90	4 screws	125	VCCF5	1.320
			175	VCCF6	1.320

##### For mounting in an enclosure or for modular distribution boards

Handle	Front plate mm	Fixing	Rating A	Reference	Weight kg
Red, padlockable with 1 padlock ( $\varnothing$ 4 to $\varnothing$ 6)	Yellow 45 x 45		25	VVE0	0.250
			32	VVE1	0.250
			40	VVE2	0.250
			63	VVE3	0.530
			80	VVE4	0.530

(1) Switches supplied with a shaft extension VZN17 and a door interlock plate KZ32 or KZ74 (see page 3/136).

# Stop the machine

VARIO switch disconnectors  
for high performance applications  
Complete units



V0



V5



VZ0



VZ11



VZ15



VZ20

### Switch bodies

Description	Rating A	Reference	Weight kg
3-pole switch disconnectors (1)	12	V02	0.200
	20	V01	0.200
	25	V0	0.200
	32	V1	0.200
	40	V2	0.200
	63	V3	0.500
	80	V4	0.500
	125	V5	0.900
	175	V6	0.900

### Add-on modules

Description	Rating A	Reference	Weight kg
Main pole modules	12	VZ02	0.050
	20	VZ01	0.050
	25	VZ0	0.050
	32	VZ1	0.050
	40	VZ2	0.050
	63	VZ3	0.100
	80	VZ4	0.100
Neutral pole modules with early make and late break contacts (1)	12 to 40	VZ11	0.050
	63 to 80	VZ12	0.100
	125 and 175	VZ13	0.250
Earthing modules	12 to 40	VZ14	0.050
	63 and 80	VZ15	0.100
	125 and 175	VZ16	0.250

### Auxiliary contact block modules

Auxiliary contact block	N/O + N/C (2)	VZ7	0.050
modules with 2 auxil. contacts	N/O + N/O	VZ20	0.050

### Maximum no. of add-on modules that can be fitted on a switch body

1 add-on module on each side of the switch body

VZ7 or VZ20	+	V0●	+	VZ7 or VZ20		VZ7	+		+	VZ7
or				or		or				or
VZ11 or VZ12	+	V0	+	VZ11 or VZ12		VZ20	+	V5	+	VZ20
or				or		or		or		or
VZ14 or VZ15	+	to	+	VZ14 or VZ15		VZ13	+	or	+	VZ13
or				or		or		V6		or
VZ0●/VZ0 to VZ4	+	V4	+	VZ0●/VZ0 to VZ4		VZ16	+		+	VZ16

2 add-on modules on each side of the switch body

VZ0●	+	VZ0●	+	V0●	+	VZ0●	+	VZ7	or	VZ20	or	VZ11	or	VZ14
VZ0	+	VZ0	+	V0	+	VZ0	+	VZ7	or	VZ20	or	VZ11	or	VZ14
VZ1	+	VZ1	+	V1	+	VZ1	+	VZ7	or	VZ20	or	VZ11	or	VZ14
VZ2	+	VZ2	+	V2	+	VZ2	+	VZ7	or	VZ20	or	VZ11	or	VZ14
VZ3	+	VZ3	+	V3	+	VZ3	+	VZ7	or	VZ20	or	VZ12	or	VZ15
VZ4	+	VZ4	+	V4	+	VZ4	+	VZ7	or	VZ20	or	VZ12	or	VZ15

Note : The add-on modules mounted next to the switch body are main poles. Maximum of 3 main pole modules per switch body.

(1) Protection shrouds are available if required: see page 3/136.

(2) Late make N/O, early break N/C contacts

3

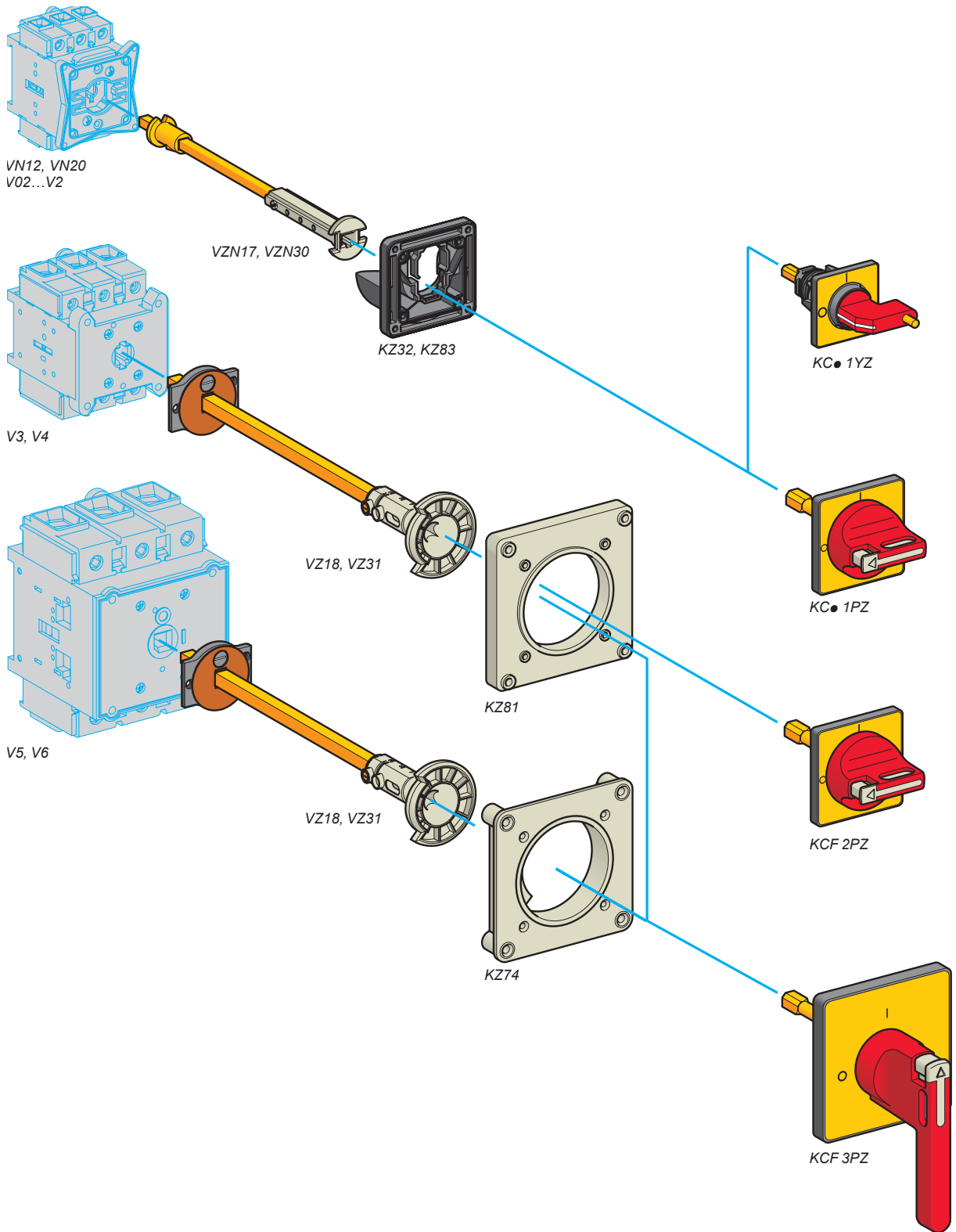

# Stop the machine

## Mini-VARIO and VARIO switch disconnectors

### Operators, handles and front plates

(for customer assembly)

- Padlockable operating handle (padlocks not supplied).
- Degree of protection IP 65.
- Marking on operator .

#### Handles and front plates for main and Emergency stop switch disconnectors

For switch body	Operator		Reference	Weight	
	Handle	Front plate			
		Dimensions	Fixing		
		mm		kg	
VN12, VN20 V02...V2	Red, padlockable with up to 1 padlock (Ø 4 to Ø 6)	Yellow 45 x 45	Ø 22.5 4 screws	KCC1YZ KCE1YZ	0.050 0.040
		Yellow 60 x 60	Ø 22.5 4 screws	KCD1PZ KCF1PZ	0.082 0.075
V3 and V4	Red, padlockable with up to 3 padlocks (Ø 4 to Ø 8)	Yellow 60 x 60	4 screws	KCF2PZ	0.070
V5 and V6	Red, long, padlockable with up to 3 padlocks (Ø 4 to Ø 8)	Yellow 90 x 90	4 screws	KCF3PZ (1)	0.160

(1) For door mounting of 63 and 80 A switch disconnectors, adapter plate KZ106 must be ordered separately (see page 3/136).

# Stop the machine

## Mini-VARIO and VARIO switch disconnectors

### Accessories

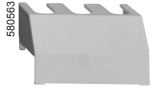

VZ8



VZ26



VZ18



KZ32

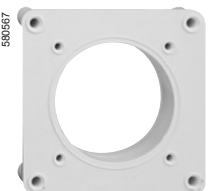

KZ81

#### Input terminal protection shrouds

Description	For use on	Reference	Weight kg
For switch bodies (3-pole shroud)	V02...V2	<b>VZ8</b>	0.015
	V3 and V4	<b>VZ9</b>	0.020
	V5 and V6	<b>VZ10</b>	0.060
For add-on pole modules (single-pole shroud)	VZ02...VZ2, VZ11, VZ14	<b>VZ26</b>	0.005
	VZ3, VZ4, VZ12, VZ15	<b>VZ27</b>	0.007
	VZ13, VZ16	<b>VZ28</b>	0.020
For contact blocks with 2 auxiliary contacts	–	<b>VZ29</b>	0.005

#### Components for door interlocking

For rear fixing switch disconnectors mounted at the back of an enclosure, in addition to a direct operator

Description	For use on	Distance enc.back/door mm	Sold in lots of	Unit reference	Weight kg
Shaft extensions	VN12, VN20 V02...V2	300...330	1	<b>VZN17</b> (1)	0.100
		400...430	1	<b>VZN30</b> (1)	0.130
	V02...V2	300...330	1	<b>VZ17</b>	0.075
		400...430	1	<b>VZ30</b>	0.125
	V3 and V4	300...320	1	<b>VZ18</b>	0.170
		400...420	1	<b>VZ31</b>	0.215
V5 and V6	330...350	1	<b>VZ18</b>	0.170	
	430...450	1	<b>VZ31</b>	0.215	
Door interlock plates	VN12, VN20 V02...V2	–	5	<b>KZ32</b>	0.177
		V3...V6	–	5	<b>KZ74</b>

Description	For use on	Front plate dimensions mm	Sold in lots of	Unit reference	Weight kg
Plates for door mounting of handles with 4 screw fixing	VN12, VN20 V02...V2	45 x 45 or 60 x 60	5	<b>KZ83</b>	0.205
		V3...V6	60 x 60 or 90 x 90	5	<b>KZ81</b>
Adapter plate for switch disconnectors	V3 and V4	90 x 90	5	<b>KZ106</b>	0.075

(1) Can be used with V02 to V2 switches.

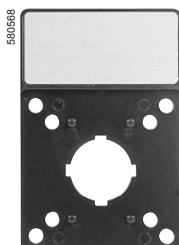

KZ15

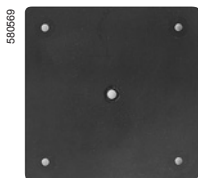

KZ67



Z01

#### Accessories for operators

Description	For use on	Front plate dimensions mm	Sold in lots of	Unit reference	Weight kg
Legend holder with silver coloured blank legend plate	Front plate	45 x 45	5	KZ13	0,060
		60 x 60	5	KZ15	0,065
		90 x 90	5	KZ103	0,070
Legend holders without legend plate	Front plate	45 x 45	20	KZ14	0,060
		60 x 60	10	KZ16	0,065
		90 x 90	5	KZ101	0,070
Silver coloured blank legend plates for engraving by customer	KZ14	–	20	KZ76	0,020
	KZ16	–	10	KZ77	0,010
	KZ101	–	5	KZ100	0,005
Seals	VN12, VN20	45 x 45	5	KZ65	0,037
		60 x 60	5	KZ66	0,033
		60 x 60	5	KZ62	0,033
		90 x 90	5	KZ67	0,064
Tightening tool	For operators with Ø 22.5 fixing	–	5	Z01	0,050

# Stop the machine

## VARIO enclosed switch disconnectors (pre-assembled)

### Enclosed switch disconnectors for high performance applications

- Marking on operator  $\circ \downarrow$ .
- 3-pole rotary switch disconnectors from 10 to 140 A
- Padlockable operating handle (padlock not included).
- IP 65 degree of protection enclosures, sealable and lockable.
- Cover lockable in position "I" (ON) up to 63 A rating.



VCF 0GE



VCF 3GE



VCFN12GE

#### 3-pole main and Emergency stop switch disconnectors

Operator Handle	Front plate Dimensions	lthe		Power AC-23 at 400 V	Incorporated switch body	Possible attachments (1)	Reference	Weight
		mm	A					
Red, padlockable with up to 3 padlocks (Ø 4 to Ø 8 shank)	Yellow 60 x 60	10	4	V02	2	VCF02GE	0.500	
		16	5.5	V01	2	VCF01GE	0.500	
		20	7.5	V0	2	VCF0GE	0.500	
		25	11	V1	2	VCF1GE	0.500	
		32	15	V2	2	VCF2GE	0.500	
		50	22	V3	3	VCF3GE	0.930	
		63	30	V4	3	VCF4GE	0.930	
Red, long padlockable with up to 3 padlocks (Ø 4 to Ø 8 shanks)	Yellow 90 x 90	100	37	V5	1	VCF5GE	2.190	
		140	45	V6	1	VCF6GE	2.190	

### Enclosed switch disconnectors for standard applications

- 3-pole rotary switch disconnectors from 10 to 32 A
- Degree of protection IP 55.

#### 3-pole main and Emergency stop switch disconnectors

Operator Handle	Front plate Dimensions	lthe		Power AC-23 at 400 V	Incorporated switch body	Possible attachments (1)	Reference	Weight
		mm	A					
Red, padlockable with 1 padlock (Ø 8 shank) or up to 3 padlocks (Ø 6 shank)	Yellow 60 x 60	10	4	VN12	2	VCFN12GE (1)	0.422	
		16	5.5	VN20	2	VCFN20GE (1)	0.422	
		20	7.5	V0	0	VCFN25GE	0.512	
		25	11	V1	0	VCFN32GE	0.512	
		32	15	V2	0	VCFN40GE	0.512	

(1) For enclosures VCF and VCFN, see page 3/140



# Stop the machine

## VARIO enclosed switch disconnectors (assembled by the user)

590574



VCFX GE2

### Empty enclosures

**IP 65 enclosure with red padlockable handle operator and yellow front plate**  
(for mounting a main or Emergency stop switch disconnector)

For switch body type	Ithe	Possible attachments (1)	Reference	Weight
A				kg
VN12, VN20 V02...V2	10...32	2	VCFXGE1	0.340
V02...V2	10...32	4	VCFXGE4	0.660
V3 and V4	50...63	3	VCFXGE2	0.660
		4	VCFXGDxE	0.660

### Switch bodies for standard applications

Description	Rating	Reference	Weight
A			kg
3-pole switch disconnectors	10	VN12	0.110
	16	VN20	0.110

### Switch bodies for high performance applications (2)

Description	Rating	Reference	Weight
A			kg
3-pole switch disconnectors	10	V02	0.200
	16	V01	0.200
	20	V0	0.200
	25	V1	0.200
	32	V2	0.200
	50	V3	0.200
	63	V4	0.200

(1) See page 3/140.

# Stop the machine

## VARIO enclosed switch disconnectors

### Add-on modules



VZ 0



VZ 11



VZ 15



VZ 20

#### Add-on modules for enclosure VCF

Description	Rating	Reference	Weight kg
	A		
Main pole modules (mounted in enclosure)	10	VZ02	0.050
	16	VZ01	0.050
	20	VZ0	0.050
	25	VZ1	0.050
	32	VZ2	0.050
	50	VZ3	0.100
Neutral pole modules with early make and late break contacts	10 to 32	VZ11	0.050
	50 and 63	VZ12	0.100
	100 and 140	VZ13	0.250
Earthing modules	10 to 32	VZ14	0.050
	50 and 63	VZ15	0.100
	100 and 140	VZ16	0.250
Auxiliary contact block modules with 2 auxiliary contacts	N/O + N/C (1)	VZ7	0.050
	N/O + N/O	VZ20	0.050

#### Maximum number of add-on modules that can be fitted on a switch body

##### 1 add-on module on each side of the switch body

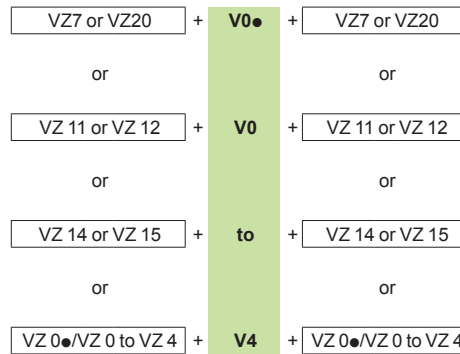

##### 2 add-on modules on each side of the switch body

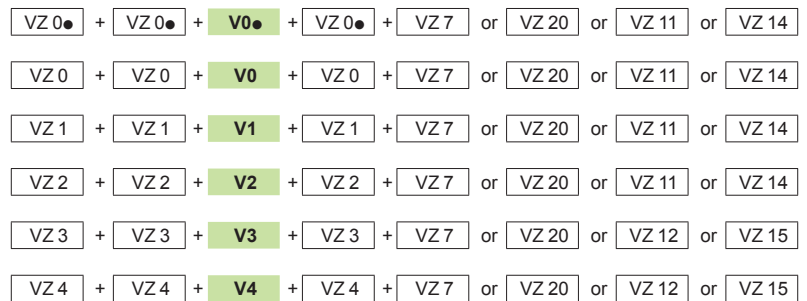

**Note :** The add-on modules mounted next to the switch body are main pole modules. Maximum of 3 main pole modules per switch body.

(1) Late make N/O, early break N/C contacts

3

# Stop the machine

## Mini-VARIO enclosed switch disconnectors

### Add-on modules



VZN11



VZN14



VZN05

#### Add-on modules for enclosures VCFN12GE and 20 GE

Description	Rating	Reference	Weight
A			
kg			
Main pole modules	10	VZN12	0.020
	16	VZN20	0.020
Neutral pole module with early make and late break contacts	10 and 16	VZN11	0.020
Earthing module	10 and 16	VZN14	0.016
Auxiliary contact block modules	1 late make N/O contact	VZN05	0.020
	1 early break N/C contact	VZN06	0.020

#### Maximum number of add-on modules that can be fitted on a switch body

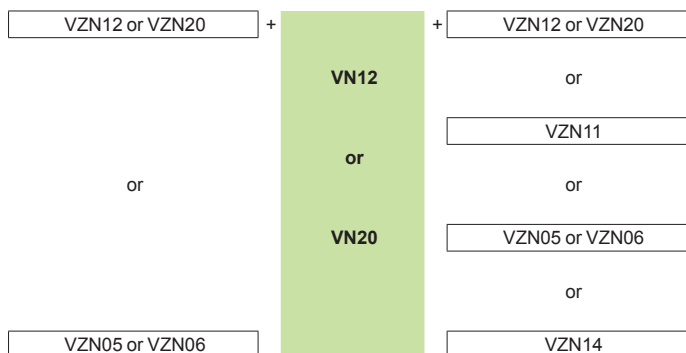

3

# Stop the machine

## TeSys contactors

### TeSys D low consumption contactors

Applications

Automation systems



<b>Rated operational current</b>	le max AC-3 (Ue ≤ 440 V)	9 A	12 A	18 A
	le AC-1 (θ ≤ 60 °C)	20/25 A	20/25 A	25/32 A
<b>Rated operational voltage</b>		690 V		
<b>Number of poles</b>		3 or 4	3 or 4	3 or 4
<b>Rated operational power in AC-3</b>	220/240 V	2.2 kW	3 kW	4 kW
	380/400 V	4 kW	5.5 kW	7.5 kW
	415/440 V	4 kW	5.5 kW	9 kW
	500 V	5.5 kW	7.5 kW	10 kW
	660/690 V	5.5 kW	7.5 kW	10 kW
<b>Coil consumption</b>		2.4 W (100 mA - 24 V)		
<b>Operating ranges</b>		0.7...1.25 Uc		
<b>Operating time at 20 °C and at Uc</b>	Closing	70 ms		
	Opening	25 ms		
<b>Auxiliary contact block modules</b>		1 N/C and 1 N/O instantaneous contacts incorporated in the contactors, with add-on blocks common to the whole range, comprising up to 2 N/C or 2 N/O instantaneous standard contacts		
<b>Interference suppression</b>		Built-in suppression as standard, by bi-directional peak limiting diode		
<b>Contactor type</b>	3-pole	LC1 D09	LC1 D12	LC1 D18
	4-pole	LC1 DT20/D098	LC1 DT25/D128	LC1 DT32/D188
<b>Reversing contactor type</b>	3-pole	LC2 D09	LC2 D12	LC2 D18
	4-pole	LC2 DT20	LC2 DT25	LC2 DT32
<b>More information</b>		Please refer to our web site, <a href="http://www.schneider-electric.com">www.schneider-electric.com</a>		



(1) With low consumption kit LA4 DBL.  
 (2) With 2 low consumption kits LA4 DBL.

25 A	32 A	38 A	40 A	50 A	65 A
690 V			690 V		
3 or 4	3	3	3	3	3
5.5 kW	7.5 kW	9 kW	11 kW	15 kW	18.5 kW
11 kW	15 kW	18.5 kW	18.5 kW	22 kW	30 kW
11 kW	15 kW	18.5 kW	22 kW	25/30 kW	37 kW
15 kW	18.5 kW	18.5 kW	22 kW	30 kW	37 kW
15 kW	18.5 kW	18.5 kW	30 kW	33 kW	37 kW
2.4 W (100 mA - 24 V)			0.6 W (25 mA - 24 V) for relay LA4 DFB + the power consumed by the contactor coil		
0.7...1.25 Uc			-	-	-
70 ms	-	-	-	-	-
25 ms	-	-	-	-	-
1 N/C and 1 N/O instantaneous contacts incorporated in the contactors, with add-on blocks common to the whole range, comprising up to 2 N/C or 2 N/O instantaneous standard contacts					
Built-in suppression as standard, by bi-directional peak limiting diode					
LC1 D25	LC1 D32	LC1 D38	LC1 D40A <sup>(1)</sup>	LC1 D50A <sup>(1)</sup>	LC1 D65A <sup>(1)</sup>
LC1 DT40/D258			-	-	-
LC2 D25	LC2 D32	LC2 D38	LC2 D40A <sup>(2)</sup>	LC2 D50A <sup>(2)</sup>	LC2 D65A <sup>(2)</sup>
LC2 DT40					
Please refer to our web site, <a href="http://www.schneider-electric.com">www.schneider-electric.com</a>					

# Stop the machine

## TeSys contactors

From 6 to 16 A

Applications	Simple automation systems						
							
<b>Rated operational current</b>	le max AC-3 (Ue ≤ 440 V) le AC-1 (θ ≤ 40 °C)		6 A 12 A	6 A -	9 A 20 A	12 A -	16 A -
<b>Rated operational voltage</b>	690 V						
<b>Number of poles</b>	2 or 3		3		3 or 4		
<b>Rated operational power in category AC-3</b>	220/240 V	1.1 kW	1.5 kW	2.2 kW	3 kW	3 kW	
	380/400 V	2.2 kW	2.2 kW	4 kW	5.5 kW	7.5 kW	
	415/440 V	2.2 kW	2.2/3 kW	4 kW	5.5 kW	7.5 kW	
	500 V	-	3 kW	4 kW	4 kW	5.5 kW	
	660/690 V	-	3 kW	4 kW	4 kW	4 kW	
	1000 V	-	-	-	-	-	-
<b>Add-on auxiliary contact blocks</b>	Front	Up to 2 N/C or N/O	Up to 4 N/C or N/O				
	Side	-	-				
	Front time delay	-	1 N/C				
	Front dust and damp protected	-	-				
<b>Associated manual-auto thermal overload relays</b>	Class 10 A	-	0.11...16 A				
	Class 20 A	-	-				
<b>Suppressor modules</b>	Varistor or diode		Varistor, diode + Zener diode or RC circuit				
<b>Contactor type references</b>	~	LC1 SK	LC1 or LC7 K06	LC1 or LC7 K09	LC1 or LC7 K12	LC1 K16	
	⋮	LP1 SK	LP1 K06	LP1 K09	LP1 K12	-	
<b>Reversing contactor with mechanical interlock type references</b>	~	-	LC2 or LC8 K06	LC2 or LC8 K09	LC2 or LC8 K12	LC2 K16	
	⋮	-	LP2 K06	LP2 K09	LP2 K12	-	
<b>More information</b>	Please refer to our web site, <a href="http://www.schneider-electric.com">www.schneider-electric.com</a>						

3

3

# Stop the machine

TeSys protection components  
Thermal-magnetic motor circuit-breakers

Applications

Protection of motors against short-circuits and overloads

Protection of motors with high current peak on starting



Tripping threshold on short-circuit

13 In

20 In

Standard motor power ratings in AC-3, 415 V

Up to 15 kW

Up to 30 kW

7.5...110 kW

Up to 11 kW

Operational current at 415 V

0.1...32 A

9...65 A

12...220 A

0.25...23 A

Breaking capacity at 415 V (Icu) to IEC 60947-2

10...100 kA

35...100 kA

50...100 kA

35 and 36 kA

70 kA

15...100 kA

Door interlock mechanism

Without

With

With

With

With

Circuit-breaker type

**GV2 ME**

**GV2 P**

**GV3 P**

**GV7 RE**

**GV7 RS**

**GV2 RT**

More information

Please refer to our web site, [www.schneider-electric.com](http://www.schneider-electric.com)

Please refer to our web site, [www.schneider-electric.com](http://www.schneider-electric.com)

# Stop the machine

Variable speed drives for asynchronous and synchronous motors

<b>Application</b>		<b>Variable speed drives without sensor (velocity control)</b> For material handling (conveyors), transfer machines, packaging machines, hoisting, special machines (textile, transfer), wood-working or metal processing machines, etc.
		
<b>Power range for 50...60 Hz (kW/HP) line supply</b>		<b>0.18...15/0.25...20</b>
	Single-phase 100...120 V (kW)	–
	Single-phase 200...240 V (kW)	0.18...2.2/0.25...3
	Three-phase 200...230 V (kW)	–
	Three-phase 200...240 V (kW)	–
	Three-phase 380...480 V (kW)	–
	Three-phase 380...500 V (kW)	0.37...15/0.5...20
	Three-phase 500...600 V (kW)	–
	Three-phase 525...600 V (kW)	–
	Three-phase 500...690 V (kW)	–
<b>Degree of protection</b>		IP 20
<b>Type of cooling</b>		Heatsink
<b>Drive system</b>	Output frequency	0.1...599 Hz
	Type of control	Voltage/frequency ratios: U/f and 5-point U/f Sensorless flux vector control ratio Kn <sup>2</sup> quadratic ratio (pump/fan) Energy saving ratio
		Ratio for synchronous motor without sensor
	Transient overtorque	170...200% of the nominal motor torque
<b>Functions (number)</b>		150
<b>Safety functions</b>	Integrated	1: STO (Safe Torque Off)
	Available as an option	3 : SLS (Safe Limited Speed), SDI (Safe Direction Information), SS1 (Safe Stop 1)
<b>Number of preset speeds</b>		–
Number of I/O	Analog inputs	3
	Logic inputs	6
	Analog outputs	1 : configurable as voltage (0-10 V) or current (0-20 mA)
	Logic outputs	1
	Relay outputs	2
<b>Communication</b>	Integrated	Modbus, CANopen
	Available as an option	DeviceNet, PROFIBUS DP V1, EtherNet/IP, Modbus TCP, EtherCat
	Bluetooth link®	Integrated
<b>Options</b>		Filters, braking resistors, line chokes
<b>Dialogue tools</b>		IP 54 or IP 55 drive navigator IP 54 or IP 55 remote graphic display terminal
<b>Configuration</b>	Setup software	SoMove
	Configuration tools	Simple Loader, Multi-Loader
<b>Standards and certifications</b>		IEC 61800-5-1, EN/IEC 61800-5-2, IEC 61800-3 (environments 1 and 2, category C2), UL508C, EN/ISO 13849-1/- 2 category 3 (PL e), IEC 61508 SIL 3, IEC 60 721-3-3 classes 3C3 and 3S2 CE, UL, CSA, C-Tick, NOM, GOST
<b>References</b>		<b>ATV 32</b>
Consult our catalog		"Altivar 32 variable speed drives" (DIA2ED2100401EN)

<b>Variable speed drive</b>		<b>Variable speed drive</b> For pumps and fans (building : Heating, Ventilation and Air Conditioning)	<b>Variable speed drive</b> For hoisting, material handling, packaging, textile machines, wood-working machines, process machines
			
<b>0.37...800/0.5...900</b>		<b>0.37...630/0.5...700</b>	
	–	–	
	0.37...5.5/0.5...7.5	0.37...5.5/0.5...7.5	
	–	–	
	0.75...90/1...125	0.37...75/0.5...100	
	0.75...630/1...900	0.75...500/1...700	
	–	–	
	2.2...7.5/3...10	1.5...7.5/2...10	
	–	–	
	2.2...800/3...800	1.5...630/2...700	
<b>IP 20</b>		<b>IP 20</b>	
Heatsink or water-cooled system		Heatsink, base plate or water-cooled circuit	
0.1...500 Hz for the entire range 0.1...599 Hz up to 37 kW/50 HP at 200...240 V ~ and 380...480 V ~		0.1...500 Hz across the entire range 0.1...599 Hz up to 37 kW at 200...240 V ~ and 380...480 V ~	
Sensorless flux vector control Voltage/frequency ratio (2 or 5 points) Energy saving ratio		Flux vector control with or without sensor Voltage/frequency ratio (2 or 5 points). ENA System	
Vector control without speed feedback 120% of the nominal motor torque for 60 seconds		Vector control with or without speed feedback 220% of nominal motor torque for 2 seconds, 170% for 60 seconds	
> 100		> 150	
"Power removal" (PWR) safety function		"Power removal" (PWR) safety function	
–		–	
8		16	
2...4		2...4	
6...20		6...20	
1...3		1...3	
0...8		0...8	
2...4		2...4	
Modbus, CANopen		Modbus, CANopen	
Modbus TCP Daisy Chain, Modbus/Uni-Telway, EtherNet/IP, DeviceNet, PROFIBUS DP V0 and V1, INTERBUS, CC-LINK, LONWORKS, METASYS N2, APOGEE FLN, BACnet		Modbus TCP Daisy Chain, Modbus/Uni-Telway, EtherNet/IP, DeviceNet, PROFIBUS DP V0 and V1, INTERBUS, CC-Link	
–		–	
TVIMC integrated controller card, I/O extension cards, "Controller Inside" programmable card, multi-pump cards, encoder interface cards		ATVIMC integrated controller card, interface cards for incremental, resolver, SinCos, SinCos Hiperface®, EnDat® or SSI encoders, I/O extension cards, "Controller Inside" programmable card	
IP 54 or IP 65 remote graphic display terminal		IP 54 or IP 65 remote graphic display terminal	
SoMove		SoMove	
Simple Loader, Multi-Loader		Simple Loader, Multi-Loader	
IEC 61800-5-1, IEC 61800-3 (environments 1 and 2, categories C1 to C3), IEC 61000-4-2/4-3/4-4/4-5/4-6/4-11		IEC 61800-5-1, IEC 61800-3 (environments 1 and 2, categories C1 to C3), IEC 61000-4-2/4-3/4-4/4-5/4-6/4-11	
CE, UL, CSA, DNV, C-Tick, NOM, GOST		CE, UL, CSA, DNV, C-Tick, NOM, GOST	
<b>ATV 61</b>		<b>ATV 71</b>	
"Altivar 61 variable speed drives" (DIA2ED2140406EN)		"Altivar 71 variable speed drives" (DIA2ED2140407EN)	





**Applications**

**Illuminated beacons and tower lights**



<b>Features</b>	Direct fixing or on support tube
<b>Conformity to standards</b>	EN/IEC 60947-5-1, UL 508, CSA C22-2 n°14, CCC, Gost
<b>Protective treatment</b>	Standard version, "TC"
<b>Ambient temperature</b> For operation	See page 3/154
For storage	- 40...+ 70 °C
<b>Electric shock protection</b> conforming to IEC 61140	Class I: mounted on support tube Class II: mounted directly
<b>Degree of protection</b> conforming to IEC 60529, UL 508 and CSA C22-2 n° 14	IP 65 (mounted on fixing base XVBZ0●) IP 66 (mounted directly on base unit)
<b>Rated insulation voltage</b>	Ui = 250 V conforming to EN/IEC 60947-1
<b>Rated impulse withstand voltage</b> conforming to EN/IEC 60947-1	Uimp = 4 kV
<b>Type references</b>	<b>XVBL, XVBC</b>
<b>Pages</b>	3/154

**Rotating beacons for long distance signalling applications**

**Sirens and electronic alarms for long distance signalling applications**



<b>Super Bright LED</b>	Power - 106 db, 2 tones - 105 db, 43 tones
<b>Ø 84 to 120 mm</b> : EN/IEC 61000-6-2 and EN/IEC 61000-6-4, <b>Ø 130 mm</b> : EN/IEC 60947-1 and EN/IEC 60947-5-1, UL 508, CSA C22-2-14	<b>XVS10 and XVS14</b> : EN/IEC 60947-1 and EN/IEC 60947-5-1, <b>XVS14BMW</b> : EN/IEC 61000-6-2 and EN/IEC 61000-6-3
Standard version, "TC"	Standard version, "TC"
<b>Ø 84 to 120 mm</b> : - 10...+ 50 °C, <b>Ø 130 mm</b> : - 30...+ 50 °C ( )	<b>XVS10</b> : - 30...+ 50 °C <b>XVS14</b> : - 10...+ 50 °C
- 35...+ 70 °C	- 35...+ 70 °C
Class II	Class II
<b>Ø 84</b> : IP 23 (IP 65 with accessory), <b>Ø 106</b> : IP 23 (IP 55 with accessory), <b>Ø 120</b> : IP 23, <b>Ø 130</b> : IP 66 and/or IP 67	IP 53
-	-
<b>Ø 84 to 120 mm</b> : Uimp = 0.8 kV, <b>Ø 130 mm</b> : Uimp = 4 kV	⎓ 12-24 and ⎓ 12/24 V: Uimp = 0.8 kV, ⎓ 120/230 and ⎓ 120/240 V: Uimp = 4 kV
<b>XVR</b>	<b>XVS10, XVS14</b>
3/163	3/165

## Related product to safety

Modular tower lights

Harmony® type XVBL Ø 70 mm

Illuminated beacons for incandescent bulbs or LEDs  
(BA 15d base fitting)



PF11045B

XVBL3●

3



PF11045B

XVBL4B●

### Illuminated beacons with steady light signalling

Description	Light source, to be ordered separately (1)	Colour	Reference	Weight kg
<b>Complete unit comprising:</b> - 1 illuminated unit - 1 base unit for direct fixing (IP 66) or tube fixing (IP 65)	Incandescent bulb 7 W max. 250 V max.	Green	<b>XVBL33</b>	0.260
		Red	<b>XVBL34</b>	0.260
		Orange	<b>XVBL35</b>	0.260
		Blue	<b>XVBL36</b>	0.260
		Clear	<b>XVBL37</b>	0.260
		Yellow	<b>XVBL38</b>	0.260

### Illuminated beacons with integral flashing light signalling

Description	Light source, to be ordered separately (1)	Colour	Reference	Weight kg	
<b>Complete unit comprising:</b> - 1 illuminated unit - 1 base unit for direct fixing (IP 66) or tube fixing (IP 65)	Incandescent bulb 7 W max. ~ 24 V --- 24...48 V	Green	<b>XVBL4B3</b>	0.280	
		Red	<b>XVBL4B4</b>	0.280	
		Orange	<b>XVBL4B5</b>	0.280	
		Blue	<b>XVBL4B6</b>	0.280	
		Clear	<b>XVBL4B7</b>	0.280	
		Yellow	<b>XVBL4B8</b>	0.280	
		Incandescent bulb 7 W max. ~ 48...230 V	Green	<b>XVBL4M3</b>	0.280
			Red	<b>XVBL4M4</b>	0.280
Orange	<b>XVBL4M5</b>		0.280		
Blue	<b>XVBL4M6</b>		0.280		
Clear	<b>XVBL4M7</b>		0.280		
Yellow	<b>XVBL4M8</b>		0.280		

(1) Incandescent bulbs and LEDs, see page 3/161.

# Related product to safety

Modular tower lights

Harmony® type XVBL Ø 70 mm

Illuminated beacons with LED light source

1014075E



XVBL0B●

PF110455



XVBL1B●

## Illuminated beacons with steady light signalling

Description	Light source	Colour	Reference	Weight kg	
<b>Complete unit comprising:</b> - 1 illuminated unit - 1 base unit for direct fixing (IP 66) or tube fixing (IP 65)	LED, included ≈ 24 V	Green	<b>XVBL0B3</b>	0.270	
		Red	<b>XVBL0B4</b>	0.270	
		Orange	<b>XVBL0B5</b>	0.270	
		Blue	<b>XVBL0B6</b>	0.270	
		Clear	<b>XVBL0B7</b>	0.270	
		Yellow	<b>XVBL0B8</b>	0.270	
		LED, included ~ 120 V	Green	<b>XVBL0G3</b>	0.270
			Red	<b>XVBL0G4</b>	0.270
Orange	<b>XVBL0G5</b>		0.270		
Blue	<b>XVBL0G6</b>		0.270		
Clear	<b>XVBL0G7</b>		0.270		
Yellow	<b>XVBL0G8</b>		0.270		
LED, included ~ 230 V	Green		<b>XVBL0M3</b>	0.270	
	Red		<b>XVBL0M4</b>	0.270	
	Orange	<b>XVBL0M5</b>	0.270		
	Blue	<b>XVBL0M6</b>	0.270		
	Clear	<b>XVBL0M7</b>	0.270		
	Yellow	<b>XVBL0M8</b>	0.270		

Protected  
LED

## Illuminated beacons with integral flashing light signalling

Description	Light source	Colour	Reference	Weight kg	
<b>Complete unit comprising:</b> - 1 illuminated unit - 1 base unit for direct fixing (IP 66) or tube fixing (IP 65)	LED, included ≈ 24 V	Green	<b>XVBL1B3</b>	0.280	
		Red	<b>XVBL1B4</b>	0.280	
		Orange	<b>XVBL1B5</b>	0.280	
		Blue	<b>XVBL1B6</b>	0.280	
		Clear	<b>XVBL1B7</b>	0.280	
		Yellow	<b>XVBL1B8</b>	0.280	
		LED, included ~ 120 V	Green	<b>XVBL1G3</b>	0.280
			Red	<b>XVBL1G4</b>	0.280
Orange	<b>XVBL1G5</b>		0.280		
Blue	<b>XVBL1G6</b>		0.280		
Clear	<b>XVBL1G7</b>		0.280		
Yellow	<b>XVBL1G8</b>		0.280		
LED, included ~ 230 V	Green		<b>XVBL1M3</b>	0.280	
	Red		<b>XVBL1M4</b>	0.280	
	Orange	<b>XVBL1M5</b>	0.280		
	Blue	<b>XVBL1M6</b>	0.280		
	Clear	<b>XVBL1M7</b>	0.280		
	Yellow	<b>XVBL1M8</b>	0.280		

Protected  
LED

## Related product to safety

Modular tower lights

Harmony® type XVBL Ø 70 mm

Illuminated beacons with flash discharge tube



XVBL6B●

3



XVBL8B●

### Illuminated beacons with 5 Joule flash discharge tube

Description	Light source	Colour	Reference	Weight kg	
<b>Complete unit comprising:</b> - 1 illuminated unit - 1 base unit for direct fixing (IP 66) or tube fixing (IP 65)	Integral flash discharge tube ~ 24 V	Green	<b>XVBL6B3</b>	0.440	
		Red	<b>XVBL6B4</b>	0.440	
		Orange	<b>XVBL6B5</b>	0.440	
		Blue	<b>XVBL6B6</b>	0.440	
		Clear	<b>XVBL6B7</b>	0.440	
		Yellow	<b>XVBL6B8</b>	0.440	
		Integral flash discharge tube ~ 120 V	Green	<b>XVBL6G3</b>	0.425
			Red	<b>XVBL6G4</b>	0.425
Orange	<b>XVBL6G5</b>		0.425		
Blue	<b>XVBL6G6</b>		0.425		
Clear	<b>XVBL6G7</b>		0.425		
Yellow	<b>XVBL6G8</b>		0.425		
Integral flash discharge tube ~ 230 V	Green	<b>XVBL6M3</b>	0.435		
	Red	<b>XVBL6M4</b>	0.435		
	Orange	<b>XVBL6M5</b>	0.435		
	Blue	<b>XVBL6M6</b>	0.435		
	Clear	<b>XVBL6M7</b>	0.435		
	Yellow	<b>XVBL6M8</b>	0.435		

### Illuminated beacons with 10 Joule flash discharge tube

Description	Light source	Colour	Reference	Weight kg
<b>Complete unit comprising:</b> - 1 illuminated unit - 1 base unit for direct fixing (IP 66) or tube fixing (IP 65)	Integral flash discharge tube ~ 24 V	Green	<b>XVBL8B3</b>	0.450
		Red	<b>XVBL8B4</b>	0.450
		Orange	<b>XVBL8B5</b>	0.450
		Blue	<b>XVBL8B6</b>	0.450
		Clear	<b>XVBL8B7</b>	0.450
		Yellow	<b>XVBL8B8</b>	0.450
Integral flash discharge tube ~ 120 V	Green	<b>XVBL8G3</b>	0.460	
	Red	<b>XVBL8G4</b>	0.460	
	Orange	<b>XVBL8G5</b>	0.460	
	Blue	<b>XVBL8G6</b>	0.460	
	Clear	<b>XVBL8G7</b>	0.460	
	Yellow	<b>XVBL8G8</b>	0.460	
Integral flash discharge tube ~ 230 V	Green	<b>XVBL8M3</b>	0.460	
	Red	<b>XVBL8M4</b>	0.460	
	Orange	<b>XVBL8M5</b>	0.460	
	Blue	<b>XVBL8M6</b>	0.460	
	Clear	<b>XVBL8M7</b>	0.460	
	Yellow	<b>XVBL8M8</b>	0.460	

For use with base unit XVBC●●: see page 3/160

## Related product to safety

Modular tower lights

Harmony® type XVBC Ø 70 mm

Tower lights for customer assembly (up to 5 units)

Illuminated units for incandescent bulbs or LEDs (BA 15d base fitting)



XVBC3●



XVBC4●●

### Illuminated units with steady light signalling

Description	Light source, to be ordered separately (1)	Colour	Reference	Weight kg
Illuminated units	Incandescent bulb 7 W max. 250 V max. or LED	Green	<b>XVBC33</b>	0.140
		Red	<b>XVBC34</b>	0.140
		Orange	<b>XVBC35</b>	0.140
		Blue	<b>XVBC36</b>	0.140
		Clear	<b>XVBC37</b>	0.140
		Yellow	<b>XVBC38</b>	0.140

### Illuminated units with integral flashing light signalling

Description	Light source, to be ordered separately (1)	Colour	Reference	Weight kg	
Illuminated units	Incandescent bulb 7 W max. ~ 24 V ~ 24...48 V or LED	Green	<b>XVBC4B3</b>	0.160	
		Red	<b>XVBC4B4</b>	0.160	
		Orange	<b>XVBC4B5</b>	0.160	
		Blue	<b>XVBC4B6</b>	0.160	
		Clear	<b>XVBC4B7</b>	0.160	
		Yellow	<b>XVBC4B8</b>	0.160	
		Incandescent bulb 7 W max. ~ 48...230 V or LED	Green	<b>XVBC4M3</b>	0.160
			Red	<b>XVBC4M4</b>	0.160
	Orange		<b>XVBC4M5</b>	0.160	
	Blue		<b>XVBC4M6</b>	0.160	
	Clear		<b>XVBC4M7</b>	0.160	
	Yellow		<b>XVBC4M8</b>	0.160	

(1) Incandescent bulbs and LEDs, see page 3/161.

# Related product to safety

Modular tower lights

Harmony® type XVBC Ø 70 mm

Tower lights for customer assembly (up to 5 units)

Illuminated units with integral LED

For use with base unit XVBC●●: see page 3/160

821003



XVBC2●●

3

821004



XVBC5●●

## Illuminated units with steady light signalling

Description	Voltage	Colour	Reference	Weight kg	
Illuminated units with integral LED	≈ 24 V	Green	XVBC2B3 (1)	0.150	
		Red	XVBC2B4 (1)	0.150	
		Orange	XVBC2B5 (1)	0.150	
		Blue	XVBC2B6 (1)	0.150	
		Clear	XVBC2B7 (1)	0.150	
		Yellow	XVBC2B8 (1)	0.150	
		~ 120 V	Green	XVBC2G3	0.150
			Red	XVBC2G4	0.150
Orange	XVBC2G5		0.150		
Blue	XVBC2G6		0.150		
Clear	XVBC2G7		0.150		
Yellow	XVBC2G8		0.150		
~ 230 V	Green		XVBC2M3	0.150	
	Red		XVBC2M4	0.150	
	Orange	XVBC2M5	0.150		
	Blue	XVBC2M6	0.150		
	Clear	XVBC2M7	0.150		
	Yellow	XVBC2M8	0.150		

Protected LED

## Illuminated units with integral flashing light signalling

Description	Voltage	Colour	Reference	Weight kg	
Illuminated units with integral LED	≈ 24 V	Green	XVBC5B3	0.170	
		Red	XVBC5B4	0.170	
		Orange	XVBC5B5	0.170	
		Blue	XVBC5B6	0.170	
		Clear	XVBC5B7	0.170	
		Yellow	XVBC5B8	0.170	
		~ 120 V	Green	XVBC5G3	0.170
			Red	XVBC5G4	0.170
Orange	XVBC5G5		0.170		
Blue	XVBC5G6		0.170		
Clear	XVBC5G7		0.170		
Yellow	XVBC5G8		0.170		
~ 230 V	Green		XVBC5M3	0.170	
	Red		XVBC5M4	0.170	
	Orange	XVBC5M5	0.170		
	Blue	XVBC5M6	0.170		
	Clear	XVBC5M7	0.170		
	Yellow	XVBC5M8	0.170		

Protected LED

(1) To order an illuminated unit with integral LED pre-fitted with light diffuser XVBZ18, add the letter "D" to the end of the reference. Example: XVBC2B3D.

## Related product to safety

Modular tower lights

Harmony® type XVBC Ø 70 mm

Tower lights for customer assembly (up to 5 units)

Illuminated units with integral flash discharge tube

For use with base unit XVBC●●: see page 3/160

821006



XVBC6●●

821006



XVBC8●●

### Illuminated units with 5 Joule flash discharge tube (1)

Description	Light source	Colour	Reference	Weight kg	
Illuminated units	Integral flash discharge tube ~ 24 V	Green	<b>XVBC6B3</b>	0.295	
		Red	<b>XVBC6B4</b>	0.295	
		Orange	<b>XVBC6B5</b>	0.295	
		Blue	<b>XVBC6B6</b>	0.295	
		Clear	<b>XVBC6B7</b>	0.295	
		Yellow	<b>XVBC6B8</b>	0.295	
		Integral flash discharge tube ~ 120 V	Green	<b>XVBC6G3</b>	0.280
			Red	<b>XVBC6G4</b>	0.280
	Orange		<b>XVBC6G5</b>	0.280	
	Blue		<b>XVBC6G6</b>	0.280	
	Clear		<b>XVBC6G7</b>	0.280	
	Yellow		<b>XVBC6G8</b>	0.280	
	Integral flash discharge tube ~ 230 V	Green	<b>XVBC6M3</b>	0.290	
		Red	<b>XVBC6M4</b>	0.290	
		Orange	<b>XVBC6M5</b>	0.290	
		Blue	<b>XVBC6M6</b>	0.290	
		Clear	<b>XVBC6M7</b>	0.290	
		Yellow	<b>XVBC6M8</b>	0.290	

### Illuminated units with 10 Joule flash discharge tube (1)

Description	Light source	Colour	Reference	Weight kg	
Illuminated units	Integral flash discharge tube ~ 24 V	Green	<b>XVBC8B3</b>	0.305	
		Red	<b>XVBC8B4</b>	0.305	
		Orange	<b>XVBC8B5</b>	0.305	
		Blue	<b>XVBC8B6</b>	0.305	
		Clear	<b>XVBC8B7</b>	0.305	
		Yellow	<b>XVBC8B8</b>	0.305	
		Integral flash discharge tube ~ 48 V	Orange	<b>XVBC8E5</b>	0.315
	Integral flash discharge tube ~ 120 V	Green	<b>XVBC8G3</b>	0.315	
		Red	<b>XVBC8G4</b>	0.315	
		Orange	<b>XVBC8G5</b>	0.315	
		Blue	<b>XVBC8G6</b>	0.315	
		Clear	<b>XVBC8G7</b>	0.315	
		Yellow	<b>XVBC8G8</b>	0.315	
	Integral flash discharge tube ~ 230 V	Green	<b>XVBC8M3</b>	0.315	
		Red	<b>XVBC8M4</b>	0.315	
		Orange	<b>XVBC8M5</b>	0.315	
		Blue	<b>XVBC8M6</b>	0.315	
		Clear	<b>XVBC8M7</b>	0.315	
		Yellow	<b>XVBC8M8</b>	0.315	

(1) **Warning:** illuminated units with a flash discharge tube are not suitable for steady light signalling due to the heat generated.

# Related product to safety

Modular tower lights

Harmony® type XVBC Ø 70 mm

Tower lights for customer assembly (up to 5 units)

Audible units, base units, cover, accessories

821007



XVBC9B

Audible units				
Description	Characteristics	Reference	Weight	kg
<b>Buzzer, 90 dB at 1 m</b> Adjustable with microswitch: - from 70 to 90 dB - continuous or intermittent tone	≈ 12...48 V	<b>XVBC9B</b>	0.170	
	≈ 120...230 V	<b>XVBC9M</b>	0.180	

3

1013965E



XVBC07

Base units - for direct (IP 66) or tube fixing				
Description	For use with	Type	Reference	Weight kg
<b>Base unit + cover</b> with bottom or side cable entry	Modular tower lights without flash discharge tube unit	Standard	<b>XVBC21</b>	0.190
<b>Base unit only</b> with bottom or side cable entry	Modular tower lights with flash discharge tube unit	Standard	<b>XVBC07</b>	0.160
<b>Base unit + cover</b> with side cable entry	All types of modular tower lights	AS-Interface (1)	<b>XVBC21A</b>	-
<b>Base unit + cover</b> with bottom entry, pre-cabled (length 1 m) and fitted with M12 end connector	All types of modular tower lights	AS-Interface (1)	<b>XVBC21B</b>	-

1078308E



XVBC081

Accessories specific to tower lights XVBC				
Description	Application	Unit reference	Weight	kg
<b>Cover only</b>	For use with XVBC2, XVBC3, XVBC4, XVBC5 and XVBC9	<b>XVBC081</b>	0.030	
<b>Set of 6 coloured markers</b>	For identification of the position of units in the event of dismantling the modular tower light	<b>XVBC22</b>	0.001	
<b>Set of 5 legend holders</b>	For identification of stacked units on base unit	<b>XVBC23</b>	0.002	
<b>Sheet of 85 legends</b>	For use with base unit legend holder XVBC23	<b>XVBCY1</b>	0.005	
<b>Sheet of 52 legends</b>	For identification of stacked units, used on locking ring	<b>XVBCY2</b>	0.005	
<b>Adaptor for side entry through base unit</b>	With 13P cable gland	<b>XVBC14</b>	0.015	
<b>SIS labelling software</b> (in English, French, German, Italian and Spanish)	For creating legends	<b>XBY2U</b>	0.100	
<b>Light diffuser, clear plastic</b> (Sold in boxes)	Only for use with LED illuminated units (all colours) One box allows to equip 5 illuminated units.	<b>XVBZ18</b>	0.080	

DF54420



XVBZ18

(1) For further information on AS-Interface connections, refer to our "Industrial communication in machines and installations" catalogue.



# Related product to safety

Modular tower lights

Harmony® type XVBØ 70 mm

Illuminated beacons, tower lights for customer assembly (up to 5 units)

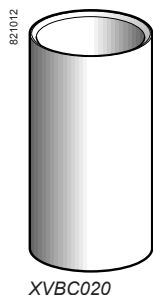

## Accessories common to beacons XVBL and tower lights XVBC

Description	Height under base unit (mm)	Colour	Reference	Weight kg
Fixing bases comprising Ø 25 mm aluminium support tube glued into a black plastic fixing plate (IP 65)	80	Black aluminium	XVBZ02	0.110
	380	Aluminium	XVBZ02A	0.110
		Black aluminium	XVBZ03	0.200
	780	Aluminium	XVBZ03A	0.200
		Black aluminium	XVBZ04	0.325
	Aluminium	XVBZ04A	0.325	

Description	For use with	Material	Reference	Weight kg
Support tube concealment cover	Support tubes XVBZ02, XVBZ02A	ABS	XVBC020	0.080
	Support tubes XVBZ03, XVBZ03A	ABS	XVBC030	0.305
	Support tubes XVBZ04, XVBZ04A	ABS	XVBC040	0.610

Description	For use with	Material	Reference	Weight kg
Ø 25 mm aluminium support tube	Fixing plate XVBZ01 (to be glued into the plastic fixing plate)	Plastic	XVBZ14	0.690

Fixing plate for use on horizontal support	Ø 25 mm aluminium support tube	Plastic	XVBZ01	0.050
--	--------------------------------	---------	--------	-------

Fixing plate for use on vertical support	Base unit (direct mounting), fixing plate XVBZ01 or fixing bases XVBZ0●	Zamak	XVBC12	0.380
--	---	-------	--------	-------

Description	Characteristics	Sold in lots of	Unit reference	Weight kg	
Incandescent bulbs (1) BA 15d base fitting	12 V	7 W	10	DL1BEJ	0.090
	24 V	6.5 W	10	DL1BEB	0.090
	48 V	6 W	10	DL1BEE	0.090
	120 V	7 W	10	DL1BEG	0.090
	230 V	7 W	10	DL1BEM	0.090

LEDs (1)	Characteristics	Sold in lots of	Unit reference	Weight kg		
BA 15d base fitting	~ 24 V	White	1	DL1BDB1	0.015	
		Green	1	DL1BDB3	0.015	
		Red	1	DL1BDB4	0.015	
		Orange	1	DL1BDB5	0.015	
		Blue	1	DL1BDB6	0.015	
		Yellow	1	DL1BDB8	0.015	
		~ 120 V	White	1	DL1BDG1	0.015
			Green	1	DL1BDG3	0.015
	Red		1	DL1BDG4	0.015	
	Orange		1	DL1BDG5	0.015	
	Blue		1	DL1BDG6	0.015	
	Yellow		1	DL1BDG8	0.015	
	~ 230 V		White	1	DL1BDM1	0.015
			Green	1	DL1BDM3	0.015
		Red	1	DL1BDM4	0.015	
		Orange	1	DL1BDM5	0.015	
Blue		1	DL1BDM6	0.015		
Yellow		1	DL1BDM8	0.015		

Flashing LEDs (1)	Characteristics	Sold in lots of	Unit reference	Weight kg		
BA 15d base fitting	~ 24 V	White	1	DL1BKB1	0.015	
		Green	1	DL1BKB3	0.015	
		Red	1	DL1BKB4	0.015	
		Orange	1	DL1BKB5	0.015	
		Blue	1	DL1BKB6	0.015	
		Yellow	1	DL1BKB8	0.015	
		~ 120 V	White	1	DL1BKG1	0.015
			Green	1	DL1BKG3	0.015
	Red		1	DL1BKG4	0.015	
	Orange		1	DL1BKG5	0.015	
	Blue		1	DL1BKG6	0.015	
	Yellow		1	DL1BKG8	0.015	
	~ 230 V		White	1	DL1BKM1	0.015
			Green	1	DL1BKM3	0.015
		Red	1	DL1BKM4	0.015	
		Orange	1	DL1BKM5	0.015	
		Blue	1	DL1BKM6	0.015	
		Yellow	1	DL1BKM8	0.015	

(1) **Warning:** illuminated units with incandescent bulbs must not be combined with LED illuminated units, due to the risk of overheating. Also, when different units (e.g. steady, flashing...) are combined, the maximum temperature is limited to that of the weaker unit.

# Related product to safety

## Rotating beacons Harmony® type XVR (equipped with Super Bright LED)



3

### Presentation

The rotating beacons in the Harmony® XVR range are optical signalling units designed for long distance signalling applications. They are used mainly in the iron and steel industry, on industrial handling vehicles or for safety applications.

The range involves complete products offering simplicity of use and speed of installation: they are supplied pre-cabled, and equipped with their light source. The use of "Super-bright" LED's guarantees a good illuminating power and a long service life (reduced time for maintenance) owing to their high resistance to mechanical shock and vibration. These light sources are also energy saving with low power consumption. A reflecting prism can be used for increasing light diffusion.

4 sizes are available:

- Ø 84 mm (XVR08). Colours : red, orange, green and blue,
- Ø 106 mm (XVR10). Colours : red, orange, green and blue,
- Ø 120 mm (XVR12). Colours : red, orange, green and blue,
- Ø 130 mm (XVR13). Colours : red, orange.

For more efficiency, Ø 120 mm rotating beacons may be delivered with a complementary audible unit: a buzzer present at the base of the product, with a continuous or intermittent tone and an adjustable sound level of 50 dB to 90 dB at 1 m.

### Environment

XVR rotating beacons can offer a high degree of protection:

- owing to the adjunction of an accessory : a rubber base guarantees a degree of protection type IP 55 or IP 65 for small models,
- according to the selected model: Ø 130 mm rotating beacons guarantee a degree of protection type IP 66 (resistant to vibration) or IP 67 (see opposite page).

These products meet the requirements of the following standards:

- EN/IEC 61000-6-2 and EN/IEC 61000-6-4 for Ø 84 mm (XVR08), 106 mm (XVR10), 120 mm (XVR12) and 130 mm with direct current (XVR13B●● and XVR13J●●),
- EN/IEC 60947-1 and EN/IEC 60947-5-1 for the other Ø 130 mm rotating beacons (XVR13●●L) with voltage 24V A.C./D.C., 120 V A.C. or 230 V A.C.

These products are CE, UL and CSA certified.

### Connection

The connection is through flying leads, length 400 mm (500 mm for XVR08) and section 0.83 mm<sup>2</sup> (1,25 mm<sup>2</sup> for XVR13).

# Related product to safety

## Rotating beacons Harmony® type XVR (equipped with Super Bright LED)



Complete, pre-cabled rotating beacons								
Diameter mm	Sound option	IP degree of protection	Voltage V	Colour	Reference	Weight kg		
Ø 84	Without buzzer	IP 23 (IP 65 With accessories)	~ 12	Red	XVR08J04	0.300		
				Orange	XVR08J05	0.300		
				Green	XVR08J03	0.300		
			~ 24	Blue	XVR08J06	0.300		
				Red	XVR08B04	0.300		
				Orange	XVR08B05	0.300		
	Ø 106	Without buzzer	IP 23 (IP 55 With accessories)	~ 12	Red	XVR10J04	0.500	
					Orange	XVR10J05	0.500	
					Green	XVR10J03	0.500	
				~ 24	Blue	XVR10J06	0.500	
					Red	XVR10B04	0.500	
					Orange	XVR10B05	0.500	
Ø 120	Without buzzer	IP 23	~ 12	Red	XVR12J04	0.500		
				Orange	XVR12J05	0.500		
				Green	XVR12J03	0.500		
			~ 24	Blue	XVR12J06	0.500		
				Red	XVR12B04	0.500		
				Orange	XVR12B05	0.500		
	Ø 120	With buzzer Continuous or intermittent tone Sound level at 1 m: 50 to 90 dB	IP 23	~ 12	Red	XVR12J04S	0.500	
					Orange	XVR12J05S	0.500	
					Green	XVR12J03S	0.500	
				~ 24	Blue	XVR12J06S	0.500	
					Red	XVR12B04S	0.500	
					Orange	XVR12B05S	0.500	
Ø 130	Without buzzer	IP 66 Resistant to vibration	~ 12	Red	XVR13J04	0.800		
				Orange	XVR13J05	0.800		
			~ 24	Red	XVR13B04	0.800		
		Orange		XVR13B05	0.800			
		Ø 130	Without buzzer	IP 66 and IP 67	~ 24	Red	XVR13B04L	0.820
						Orange	XVR13B05L	0.820
	~ 120				Red	XVR13G04L	0.990	
				Orange	XVR13G05L	0.990		
				~ 230	Red	XVR13M04L	0.990	
	Orange				XVR13M05L	0.990		

Accessories for rotating beacons					
Description	To be used for / with	Diameter mm	Height mm	Reference	Weight kg
Reflecting prism	Increasing light diffusion	84	–	XVRZR1	0.010
		106	–	XVRZR2	0.015
		120/130	–	XVRZR3	0.020
Rubber base	Reaching IP 65	84	–	XVRZ081	0.040
	Reaching IP 55	106	–	XVRZ082	0.050
Metal angle bracket	Horizontal support	84, 106, 120	–	XVCZ23	0.380
		130	–	XVR012L	1.300
Metal fixing plate	Horizontal support	106, 120	300	XVCZ13	0.700



XVS10M

3

#### Presentation

The sirens and electronic alarms in the Harmony® XVS range are audible signalling units used for long distance indication of the operating status or sequences of a machine or installation. They are mainly used on conveyor belts, on automated industrial trucks and on the doors of electrical control panels.

The range involves several types of ready to use products:

- sirens with 2 tones, with very compact size, type XVS10,
- multisound sirens (43 tones), pre-cabled, 8 channels, type XVS14.

The sound, with continuous or intermittent tone:

- guarantees a sound level of 106 dB at 1 m for XVS10,
- can be adjusted from 0 to 105 dB at 1 m for XVS14.

#### Environment

The XVS sirens and electronic alarms offer the following degree of protection: IP 53 for sirens type XVS10 and XVS14.

These products meet the requirements of the following standards:

- EN/IEC 61000-6-2 and EN/IEC 61000-6-3 for voltages 120 V and 230 V A.C. (XVS14BMW),
- EN/IEC 60947-1 and EN/IEC 60947-5-1 for voltages 12 V and 24 V A.C. (XVS10, XVS14GMW and MMW).

They are CE, UL and CSA certified.

#### Connection

Products are to be connected:

- through cable-glands for using 6.5 mm to 8.5 mm cables (XVS10)
- through power wire c.s.a.: 0.52 mm<sup>2</sup> and signal wire c.s.a.: 0.33 mm<sup>2</sup>, with flying leads, length 500 mm (XVS14),

For more technical information, please refer to our website [www.schneider-electric.com](http://www.schneider-electric.com).

## Related product to safety

Sound units Harmony® type XVS

Sirens and electronic alarms



XVS10●M



XVS14●MW

### References

Description	Voltage V	Colour	Reference	Weight kg
Sirens 106 dB, 2 tones	~ 12-24	White	XVS10BMW	0.800
	~ 120	White	XVS10GMW	1.000
	~ 230	White	XVS10MMW	1.000
Multisound sirens 0 to 105 dB, 43 tones 8 channels Pre-wired	~ 12/24	White	XVS14BMW	1.000
	~ 120	White	XVS14GMW	1.200
	~ 240	White	XVS14MMW	1.200

3

<b>9</b>	
9001KA1	3/29
9001KA2	3/29
9001KA3	3/29
9001KA4	3/29
9001KA5	3/29
9001KA6	3/29
9001KA41	3/29
9001KA42	3/29
9001KA43	3/29
9001KA51	3/29
9001KA52	3/29
9001KA53	3/29
9001KN8330	3/29
9001KN9330	3/29
9001KR16	3/29
9001KR16H2	3/29
9001KR16H13	3/29
9001SKR16	3/29
9001SKR16H2	3/29
9001SKR16H13	3/29
<b>A</b>	
ABL8RPS24100	3/109
APE1C2150	3/15 3/24
APE1C2250	3/15 3/24
APE1PRE21	3/15 3/24
<b>D</b>	
DE9EC21	3/65
DE9RA2125	3/65
DL1BDB1	3/161
DL1BDB3	3/161
DL1BDB4	3/161
DL1BDB5	3/161
DL1BDB6	3/161
DL1BDB8	3/161
DL1BDG1	3/161
DL1BDG3	3/161
DL1BDG4	3/161
DL1BDG5	3/161
DL1BDG6	3/161
DL1BDG8	3/161
DL1BDM1	3/161
DL1BDM3	3/161
DL1BDM4	3/161
DL1BDM5	3/161
DL1BDM6	3/161
DL1BDM8	3/161
DL1BEB	3/161
DL1BEE	3/161
DL1BEG	3/161
DL1BEJ	3/161
DL1BEM	3/161
DL1BKB1	3/161
DL1BKB3	3/161
DL1BKB4	3/161
DL1BKB5	3/161
DL1BKB6	3/161
DL1BKB8	3/161
DL1BKG1	3/161
DL1BKG3	3/161
DL1BKG4	3/161
DL1BKG5	3/161

DL1BKG6	3/161
DL1BKG8	3/161
DL1BKM1	3/161
DL1BKM3	3/161
DL1BKM4	3/161
DL1BKM5	3/161
DL1BKM6	3/161
DL1BKM8	3/161
<b>K</b>	
KCC1YZ	3/135
KCD1PZ	3/135
KCE1YZ	3/135
KCF1PZ	3/135
KCF2PZ	3/135
KCF3PZ	3/135
KZ13	3/137
KZ14	3/137
KZ15	3/137
KZ16	3/137
KZ32	3/136
KZ62	3/137
KZ65	3/137
KZ66	3/137
KZ67	3/137
KZ74	3/136
KZ76	3/137
KZ77	3/137
KZ81	3/136
KZ83	3/136
KZ100	3/137
KZ101	3/137
KZ103	3/137
KZ106	3/136
<b>T</b>	
TCSMCNAM3M002P	3/59 3/109
TCSXCNAMUM3P	3/123
TM3SAC5R	3/99
TM3SAC5RG	3/99
TM3SAF5R	3/99
TM3SAF5RG	3/99
TM3SAFL5R	3/99
TM3SAFL5RG	3/99
TM3SAK6R	3/99
TM3SAK6RG	3/99
TM3XREC1	3/101
TM3XTRA1	3/101
TMAM2	3/99 3/101
TMAT2PSET	3/101
TSXCANCA50	3/109
TSXCANCA100	3/109
TSXCANCA300	3/109
TSXCANCADD1	3/109
TSXCANCADD03	3/109
TSXCANCADD3	3/109
TSXCANCADD5	3/109
TSXCANTDM4	3/109
TSXESPP3001	3/123
TSXESPP3003	3/123
TSXESPP3005	3/123
TSXESPPM001	3/123
TSXESPPM003	3/123
TSXESPPM005	3/123
TSXPBSCA100	3/109

TSXPBSCA400	3/109
TSXSCMCN010	3/123
TSXSCMCN025	3/123
TSXSCMCN050	3/123
<b>V</b>	
V0	3/133 3/139
V01	3/133 3/139
V1	3/133 3/139
V02	3/133 3/139
V2	3/133 3/139
V3	3/133 3/139
V4	3/133 3/139
V5	3/133
V6	3/133
VCCD0	3/132
VCCD01	3/132
VCCD1	3/132
VCCD02	3/132
VCCD2	3/132
VCCDN12	3/130
VCCDN20	3/130
VCCF0	3/132
VCCF01	3/132
VCCF1	3/132
VCCF02	3/132
VCCF2	3/132
VCCF3	3/132
VCCF4	3/132
VCCF5	3/132
VCCF6	3/132
VCD0	3/132
VCD01	3/132
VCD1	3/132
VCD02	3/132
VCD2	3/132
VCDN12	3/130
VCDN20	3/130
VCF0	3/132
VCF0GE	3/138
VCF01	3/132
VCF1	3/132
VCF02	3/132
VCF2	3/132
VCF02GE	3/138
VCF2GE	3/138
VCF3	3/132
VCF3GE	3/138
VCF4	3/132
VCF4GE	3/138
VCF5	3/132
VCF5GE	3/138
VCF6	3/132
VCF6GE	3/138
VCFN12GE	3/138
VCFN20GE	3/138
VCFN25GE	3/138
VCFN32GE	3/138
VCFN40GE	3/138

VCFXGDXE	3/139
VCFXGE1	3/139
VCFXGE2	3/139
VCFXGE4	3/139
VDIP184546005	3/101
VDIP184546010	3/101
VDIP184546020	3/101
VDIP184546030	3/101
VDIP184546050	3/101
VN12	3/131 3/139
VN20	3/131 3/139
VVE0	3/132
VVE1	3/132
VVE2	3/132
VVE3	3/132
VVE4	3/132
VW3A8306R30	3/109
VZ0	3/133 3/140
VZ01	3/133 3/140
VZ1	3/133 3/140
VZ02	3/133 3/140
VZ2	3/133 3/140
VZ3	3/133 3/140
VZ4	3/133 3/140
VZ7	3/133 3/140
VZ8	3/136
VZ9	3/136
VZ10	3/136
VZ11	3/133 3/140
VZ12	3/133 3/140
VZ13	3/133 3/140
VZ14	3/133 3/140
VZ15	3/133 3/140
VZ16	3/133 3/140
VZ17	3/136
VZ18	3/136
VZ20	3/133
VZ26	3/136
VZ27	3/136
VZ28	3/136
VZ29	3/136
VZ30	3/136
VZ31	3/136
VZN05	3/131 3/141
VZN06	3/131 3/141
VZN08	3/131
VZN11	3/131 3/141
VZN12	3/131 3/141
VZN14	3/131 3/141
VZN17	3/136

VZN20	3/131 3/141
VZN26	3/131
VZN30	3/136
<b>X</b>	
XALD01	3/38
XALD01H7	3/38
XALD02	3/38
XALD02H7	3/38
XALD03	3/38
XALD03H7	3/38
XALD04	3/38
XALD04H7	3/38
XALD05	3/38
XALD05H7	3/38
XALD101	3/34
XALD101H29	3/34
XALD102	3/34
XALD102E	3/34
XALD103	3/34
XALD104	3/34
XALD111	3/34
XALD111H29	3/34
XALD112	3/34
XALD112E	3/34
XALD114	3/34
XALD114E	3/34
XALD115	3/34
XALD116	3/34
XALD117	3/34
XALD118	3/34
XALD132	3/36
XALD133H7	3/36
XALD134	3/36
XALD142	3/36
XALD144	3/36
XALD144E	3/36
XALD164	3/34
XALD164H29H7	3/34
XALD211	3/36
XALD211H29	3/36
XALD213	3/36
XALD213E	3/36
XALD214	3/36
XALD215	3/36
XALD222	3/37
XALD222E	3/37
XALD223	3/37
XALD224	3/36
XALD225	3/36
XALD241	3/36
XALD311	3/37
XALD311H29H7	3/37
XALD321	3/37
XALD321H29H7	3/37
XALD324	3/37
XALD324E	3/37
XALD325	3/37
XALD326	3/37
XALD328	3/37
XALD334	3/37
XALD339	3/37
XALD361B	3/36
XALD361M	3/36
XALD363B	3/36
XALD363G	3/36

XALD363M	3/36	XB7NS8442	3/27	XPSATR39530P	3/76	XPSMCMMSW0000V10	3/125	XVBC5G5	3/158
XALK01	3/38	XB7NS8444	3/27	XPSAV11113	3/75	XPSMCSCY	3/109	XVBC5G6	3/158
XALK01H29	3/38	XB7NS8445	3/27	XPSAV11113P	3/75	XPSMCTC16	3/108	XVBC5G7	3/158
XALK01H44	3/38	XB7NS9444	3/27	XPSAV11113T050	3/75	XPSMCTC32	3/108	XVBC5G8	3/158
XALK01HFR	3/38	XB7NS9445	3/27	XPSAV11113Z002	3/75	XPSMCTS16	3/108	XVBC5M3	3/158
XALK01T	3/38	XB7NT842	3/27	XPSAXE5120C	3/74	XPSMCTS32	3/108	XVBC5M4	3/158
XALK01TH26	3/38	XB7NT844	3/27	XPSAXE5120P	3/74	XPSMCWIN	3/108	XVBC5M5	3/158
XALK01TH29	3/38	XB7NT845	3/27	XPSBAE3920C	3/82	XPSMP11123	3/105	XVBC5M6	3/158
XALK01THFR	3/38	XBTGH2460	3/31	XPSBAE3920P	3/82	XPSMP11123P	3/105	XVBC5M7	3/158
XALK02	3/38	XBTZGHL3	3/31	XPSBAE5120C	3/82	XPSOT3444	3/93	XVBC5M8	3/158
XALK03	3/38	XBTZGHL5	3/31	XPSBAE5120P	3/82	XPSOT3744	3/93	XVBC6B3	3/159
XALK04	3/38	XBTZGHL10	3/31	XPSBCE3110C	3/82	XPSPVK1184	3/91	XVBC6B4	3/159
XALK05	3/38	XBTZGHL20	3/31	XPSBCE3110P	3/82	XPSPVK3484	3/91	XVBC6B5	3/159
XALK178	3/35	XBTZGJBOX	3/31	XPSBCE3410C	3/82	XPSPVK3784	3/91	XVBC6B6	3/159
XALK178E	3/35	XBY 2U	3/160	XPSBCE3410P	3/82	XPSPVT1180	3/90	XVBC6B7	3/159
XALK178F	3/35	XBY2U	3/11	XPSBCE3710C	3/82	XPSTSA3442P	3/86	XVBC6B8	3/159
XALK178FH26	3/35		3/13	XPSBCE3710P	3/82	XPSTSA3742P	3/86	XVBC6G3	3/159
XALK178FH29	3/35		3/14	XPSBF1132	3/82	XPSTSA5142P	3/86	XVBC6G4	3/159
XALK178FH44	3/35		3/20	XPSBF1132P	3/82	XPSTSW3442P	3/86	XVBC6G5	3/159
XALK178FH49	3/35		3/22	XPSCM1144	3/83	XPSTSW3742P	3/86	XVBC6G6	3/159
XALK178G	3/35		3/23	XPSCM1144P	3/83	XPSTSW5142P	3/86	XVBC6G7	3/159
XALK178GTH26	3/35	XCOM2514	3/64	XPSCM1144P	3/83	XPSVC1132	3/81	XVBC6G8	3/159
XALK178GTH29	3/35	XPSABV1133C	3/75	XPSDMB1132	3/87	XPSVC1132P	3/81	XVBC6M3	3/159
XALK178GTH44	3/35	XPSABV1133P	3/75	XPSDMB1132P	3/87	XPSVNE1142HSP	3/88	XVBC6M4	3/159
XALK178H26	3/35	XPSABV11330C	3/75	XPSDME1132	3/87	XPSVNE1142P	3/88	XVBC6M5	3/159
XALK178H29	3/35	XPSABV11330P	3/75	XPSDME1132P	3/87	XPSVNE3442HSP	3/88	XVBC6M6	3/159
XALK178H44	3/35	XPSAC1321	3/74	XPSDME1132TS220	3/87	XPSVNE3442P	3/88	XVBC6M7	3/159
XALK178H49	3/35	XPSAC1321P	3/74	XPSECEM5131C	3/85	XPSVNE3742HSP	3/88	XVBC6M8	3/159
XALK188	3/35	XPSAC3421	3/74	XPSECEM5131P	3/85	XVBC2B3	3/158	XVBC07	3/160
XALK188E	3/35	XPSAC3421P	3/74	XPSECEP3910C	3/85	XVBC2B4	3/158	XVBC8B3	3/159
XALK188F	3/35	XPSAC3721	3/74	XPSECEP3910P	3/85	XVBC2B5	3/158	XVBC8B4	3/159
XALK188G	3/35	XPSAC3721P	3/74	XPSECEP5131C	3/85	XVBC2B6	3/158	XVBC8B5	3/159
XALK188GTH26	3/35	XPSAC5121	3/74	XPSEDA5142	3/89	XVBC2B7	3/158	XVBC8B6	3/159
XALK198	3/35	XPSAC5121P	3/74	XPSEDA5142	3/89	XVBC2B8	3/158	XVBC8B7	3/159
XALZ09	3/39	XPSAF5130	3/77	XPSEDA5142	3/89	XVBC2G3	3/158	XVBC8E5	3/159
	3/55	XPSAF5130P	3/77	XPSEDA5142	3/89	XVBC2G4	3/158	XVBC8G3	3/159
XARS8D18H	3/58	XPSAF5130P	3/78	XPSEDA5142	3/89	XVBC2G5	3/158	XVBC8G4	3/159
XARS8D18W	3/58	XPSAF5130P	3/78	XPSEDA5142	3/89	XVBC2G6	3/158	XVBC8G5	3/159
XARS8L12H	3/58	XPSAK311144	3/80	XPSEDA5142	3/89	XVBC2G7	3/158	XVBC8G6	3/159
XARS8L12W	3/58	XPSAK311144P	3/80	XPSEDA5142	3/89	XVBC2G8	3/158	XVBC8G7	3/159
XARS12D18H	3/58	XPSAK331144P	3/80	XPSEDA5142	3/89	XVBC2M3	3/158	XVBC8G8	3/159
XARS12D18W	3/58	XPSAK351144	3/80	XPSEDA5142	3/89	XVBC2M4	3/158	XVBC8M3	3/159
XARSK8D18H	3/59	XPSAK351144P	3/80	XPSEDA5142	3/89	XVBC2M5	3/158	XVBC8M4	3/159
XARSK8D18W	3/59	XPSAK361144	3/80	XPSEDA5142	3/89	XVBC2M6	3/158	XVBC8M5	3/159
XARSK8L12H	3/59	XPSAK361144P	3/80	XPSEDA5142	3/89	XVBC2M7	3/158	XVBC8M6	3/159
XARSK8L12W	3/59	XPSAK371144	3/80	XPSEDA5142	3/89	XVBC2M8	3/158	XVBC8M7	3/159
XARSK12D18H	3/59	XPSAK371144P	3/80	XPSEDA5142	3/89	XVBC4B3	3/157	XVBC8M8	3/159
XARSK12D18W	3/59	XPSAR3p1144	3/79	XPSEDA5142	3/89	XVBC4B4	3/157	XVBC9B	3/160
XB4BS8442	3/9	XPSAR311144	3/79	XPSEDA5142	3/89	XVBC4B5	3/157	XVBC9M	3/160
XB4BS8444	3/9	XPSAR311144P	3/79	XPSEDA5142	3/89	XVBC4B6	3/157	XVBC12	3/161
XB4BS8445	3/9	XPSAR351144	3/79	XPSEDA5142	3/89	XVBC4B7	3/157	XVBC14	3/160
XB4BS9445	3/9	XPSAR351144P	3/79	XPSEDA5142	3/89	XVBC4B8	3/157	XVBC020	3/161
XB4BS84441	3/9	XPSAR371144	3/79	XPSEDA5142	3/89	XVBC4M3	3/157	XVBC21	3/160
XB4BT842	3/9	XPSAR371144P	3/79	XPSEDA5142	3/89	XVBC4M4	3/157	XVBC21A	3/160
XB4BT845	3/9	XPSATE3410	3/75	XPSEDA5142	3/89	XVBC4M5	3/157	XVBC21B	3/160
XB5AS8442	3/18	XPSATE3410P	3/75	XPSEDA5142	3/89	XVBC4M6	3/157	XVBC22	3/160
XB5AS8444	3/18	XPSATE3710	3/75	XPSEDA5142	3/89	XVBC4M7	3/157	XVBC23	3/160
XB5AS8445	3/18	XPSATE3710P	3/75	XPSEDA5142	3/89	XVBC4M8	3/157	XVBC030	3/161
XB5AS9442	3/18	XPSATE5110	3/75	XPSEDA5142	3/89	XVBC5B3	3/158	XVBC33	3/157
XB5AS9445	3/18	XPSATE5110P	3/75	XPSEDA5142	3/89	XVBC5B4	3/158	XVBC34	3/157
XB5AT842	3/18	XPSATR1153C	3/76	XPSEDA5142	3/89	XVBC5B5	3/158	XVBC35	3/157
XB5AT845	3/18	XPSATR1153P	3/76	XPSEDA5142	3/89	XVBC5B6	3/158	XVBC36	3/157
XB6AS8349B	3/6	XPSATR3953C	3/76	XPSEDA5142	3/89	XVBC5B7	3/158	XVBC37	3/157
XB6AS9349B	3/6	XPSATR3953P	3/76	XPSEDA5142	3/89	XVBC5B8	3/158	XVBC38	3/157
XB6ETI522P	3/5	XPSATR11530C	3/76	XPSEDA5142	3/89	XVBC5G3	3/158	XVBC040	3/161
XB6ETI523P	3/5	XPSATR11530P	3/76	XPSEDA5142	3/89	XVBC5G4	3/158	XVBC081	3/160
XB6ETN521P	3/5	XPSATR39530C	3/76	XPSEDA5142	3/89				

# Preventa solutions for efficient machine safety

## Product reference index

XVBCY1	3/160	XVBL6M8	3/156	XVR12J06S	3/163	ZARC03	3/59	ZB4BZ1045	3/13
XVBCY2	3/160	XVBL8B3	3/156	XVR012L	3/163	ZARC04	3/59	ZB4BZ1053	3/14
XVBL0B3	3/155	XVBL8B4	3/156	XVR13B04	3/163	ZARC05	3/59	ZB4BZ1054	3/15
XVBL0B4	3/155	XVBL8B5	3/156	XVR13B04L	3/163	ZARC06	3/59	ZB4BZ1055	3/13
XVBL0B5	3/155	XVBL8B6	3/156	XVR13B05	3/163	ZARC07	3/59	ZB4BZ1414	3/15
XVBL0B6	3/155	XVBL8B7	3/156	XVR13B05L	3/163	ZARC08	3/59	ZB5AA0	3/40
XVBL0B7	3/155	XVBL8B8	3/156	XVR13G04L	3/163	ZARC09	3/59	ZB5AA1	3/40
XVBL0B8	3/155	XVBL8G3	3/156	XVR13G05L	3/163	ZARC12	3/59	ZB5AA2	3/40
XVBL0G3	3/155	XVBL8G4	3/156	XVR13J04	3/163	ZARC18	3/59	ZB5AA3	3/40
XVBL0G4	3/155	XVBL8G5	3/156	XVR13J05	3/163	ZART8D	3/58	ZB5AA4	3/40
XVBL0G5	3/155	XVBL8G6	3/156	XVR13M04L	3/163	ZART8L	3/58	ZB5AA5	3/40
XVBL0G6	3/155	XVBL8G7	3/156	XVR13M05L	3/163	ZART12D	3/58	ZB5AA6	3/40
XVBL0G7	3/155	XVBL8G8	3/156	XVRZ081	3/163	ZB2BE101	3/11 3/20	ZB5AA8	3/40
XVBL0G8	3/155	XVBL8M3	3/156	XVRZ082	3/163	ZB2BE102	3/11 3/20	ZB5AA9	3/40
XVBL0M3	3/155	XVBL8M4	3/156	XVRZR1	3/163	ZB2BP012	3/55	ZB5AA14	3/40
XVBL0M4	3/155	XVBL8M5	3/156	XVRZR2	3/163	ZB2BP013	3/55	ZB5AA16	3/40
XVBL0M5	3/155	XVBL8M6	3/156	XVRZR3	3/163	ZB2BP014	3/55	ZB5AA18	3/40
XVBL0M6	3/155	XVBL8M7	3/156	XVS10BMW	3/165	ZB2BP015	3/55	ZB5AA24	3/40
XVBL0M7	3/155	XVBL8M8	3/156	XVS10GMW	3/165	ZB2BP016	3/55	ZB5AA26	3/40
XVBL0M8	3/155	XVBL33	3/154	XVS10MMW	3/165	ZB4BR216	3/65	ZB5AA34	3/40
XVBL1B3	3/155	XVBL34	3/154	XVS14BMW	3/165	ZB4BS834	3/9	ZB5AA36	3/40
XVBL1B4	3/155	XVBL35	3/154	XVS14GMW	3/165	ZB4BS844	3/9 3/65	ZB5AA38	3/40
XVBL1B5	3/155	XVBL36	3/154	XVS14MMW	3/165	ZB4BS845S	3/65	ZB5AA44	3/40
XVBL1B6	3/155	XVBL37	3/154	XY2AU1	3/61	ZB4BS864	3/9	ZB5AA46	3/40
XVBL1B7	3/155	XVBL38	3/154	XY2AU2	3/61	ZB4BS934	3/9	ZB5AA48	3/40
XVBL1B8	3/155	XVBZ01	3/161	XY2AZ1	3/61	ZB4BS944	3/9	ZB5AA54	3/40
XVBL1G3	3/155	XVBZ02	3/161	XY2AZ2	3/61	ZB4BS964	3/9	ZB5AA56	3/40
XVBL1G4	3/155	XVBZ02A	3/161	XY2AZ3	3/61	ZB4BT84	3/9	ZB5AA58	3/40
XVBL1G5	3/155	XVBZ03	3/161	XY2SB71	3/64	ZB4BT844	3/9	ZB5AA64	3/40
XVBL1G6	3/155	XVBZ03A	3/161	XY2SB72	3/64	ZB4BVG35	3/13	ZB5AA66	3/40
XVBL1G7	3/155	XVBZ04	3/161	XY2SB75	3/64	ZB4BVG45	3/13	ZB5AA68	3/40
XVBL1G8	3/155	XVBZ04A	3/161	XY2SB76	3/64	ZB4BW643	3/9	ZB5AA131	3/41
XVBL1M3	3/155	XVBZ14	3/161	XY2SB90	3/65	ZB4BX84	3/9	ZB5AA133	3/41
XVBL1M4	3/155	XVBZ18	3/160	XY2SB93	3/65	ZB4BZ009	3/11 3/13 3/15	ZB5AA136	3/41
XVBL1M5	3/155	XVCZ13	3/163	XY2SB96	3/65	ZB4BZ62	3/17 3/26	ZB5AA141	3/41
XVBL1M6	3/155	XVCZ23	3/163	XY2SB98	3/65	ZB4BZ64	3/17 3/26	ZB5AA142	3/41
XVBL1M7	3/155	XVR08B03	3/163	XY2SB99	3/65	ZB4BZ65	3/17 3/26	ZB5AA145	3/41
XVBL1M8	3/155	XVR08B04	3/163	XY2SB511	3/65	ZB4BZ66	3/17 3/26	ZB5AA232	3/41
XVBL4B3	3/154	XVR08B05	3/163	XY2SB531	3/65	ZB4BZ101	3/11	ZB5AA233	3/41
XVBL4B4	3/154	XVR08B06	3/163	XY2SB714	3/64	ZB4BZ102	3/11	ZB5AA234	3/41
XVBL4B5	3/154	XVR08J03	3/163	XY2SB724	3/64	ZB4BZ103	3/11	ZB5AA235	3/41
XVBL4B6	3/154	XVR08J04	3/163	<b>Z</b>		ZB4BZ104	3/11 3/65	ZB5AA245	3/41
XVBL4B7	3/154	XVR08J05	3/163	Z01	3/137	ZB4BZ105	3/11 3/65	ZB5AA331	3/41
XVBL4B8	3/154	XVR08J06	3/163	ZALVB1	3/39	ZB4BZ106	3/11 3/20	ZB5AA333	3/41
XVBL4M3	3/154	XVR10B03	3/163	ZALVB3	3/39	ZB4BZ107	3/11 3/20	ZB5AA334	3/41
XVBL4M4	3/154	XVR10B04	3/163	ZALVB4	3/39	ZB4BZ141	3/11	ZB5AA335	3/41
XVBL4M5	3/154	XVR10B05	3/163	ZALVB5	3/39	ZB4BZ1013	3/14	ZB5AA432	3/41
XVBL4M6	3/154	XVR10B06	3/163	ZALVB6	3/39	ZB4BZ1014	3/15	ZB5AA433	3/41
XVBL4M7	3/154	XVR10J03	3/163	ZALVG1	3/39	ZB4BZ1015	3/13	ZB5AA434	3/41
XVBL4M8	3/154	XVR10J04	3/163	ZALVG3	3/39	ZB4BZ1023	3/14	ZB5AA435	3/41
XVBL6B3	3/156	XVR10J05	3/163	ZALVG4	3/39	ZB4BZ1024	3/15	ZB5AC2	3/41
XVBL6B4	3/156	XVR10J06	3/163	ZALVG5	3/39	ZB4BZ1025	3/13	ZB5AC3	3/41
XVBL6B5	3/156	XVR12B03	3/163	ZALVG6	3/39	ZB4BZ1033	3/14	ZB5AC4	3/41
XVBL6B6	3/156	XVR12B03S	3/163	ZALVM1	3/39	ZB4BZ1034	3/15	ZB5AC5	3/41
XVBL6B7	3/156	XVR12B04	3/163	ZALVM3	3/39	ZB4BZ1035	3/13	ZB5AC6	3/41
XVBL6B8	3/156	XVR12B04S	3/163	ZALVM4	3/39	ZB4BZ1043	3/14	ZB5AC24	3/41
XVBL6G3	3/156	XVR12B05	3/163	ZALVM5	3/39	ZB4BZ1044	3/15	ZB5AC34	3/41
XVBL6G4	3/156	XVR12B05S	3/163	ZALVM6	3/39			ZB5AC44	3/41
XVBL6G5	3/156	XVR12B06	3/163	ZALY2	3/51				
XVBL6G6	3/156	XVR12B06S	3/163	ZALY4	3/51				
XVBL6G7	3/156	XVR12J03	3/163	ZARB12H	3/58				
XVBL6G8	3/156	XVR12J03S	3/163	ZARB12W	3/58				
XVBL6M3	3/156	XVR12J04	3/163	ZARB18H	3/58				
XVBL6M4	3/156	XVR12J04S	3/163	ZARB18W	3/58				
XVBL6M5	3/156	XVR12J05	3/163	ZARC01	3/59				
XVBL6M6	3/156	XVR12J05S	3/163	ZARC02	3/59				
XVBL6M7	3/156	XVR12J06	3/163						



ZB5AC54	3/41	ZB5AG6	3/45	ZB5AP4S	3/40	ZB5AZ101	3/20	ZB6Y016	3/7
ZB5AC64	3/41	ZB5AG6D	3/46	ZB5AP5S	3/40	ZB5AZ102	3/20	ZB6Y018	3/7
ZB5AD2	3/43	ZB5AG06D	3/46	ZB5AP6S	3/40	ZB5AZ103	3/20	ZB6Y019	3/7
ZB5AD3	3/43	ZB5AG7	3/45	ZB5AS12	3/42	ZB5AZ104	3/20	ZB6Y56	3/5
ZB5AD4	3/43	ZB5AG07D	3/46	ZB5AS42	3/42	ZB5AZ105	3/20	ZB6Y905	3/7
ZB5AD5	3/43	ZB5AG7D	3/46	ZB5AS52	3/42	ZB5AZ141	3/20	ZB6Y906	3/7
ZB5AD7	3/43	ZB5AG8	3/45	ZB5AS55	3/42	ZB5AZ901	3/39	ZB6Y7001	3/6
ZB5AD8	3/43	ZB5AG08	3/45	ZB5AS72	3/42	ZB5AZ905	3/39	ZB6Y7130	3/6
ZB5AD28	3/46	ZB5AG8D	3/46	ZB5AS834	3/18		3/55	ZB6Y7230	3/6
ZB5AD29	3/45	ZB5AG08D	3/46		3/42	ZB5AZ1013	3/23	ZB6Y7330	3/6
ZB5AD39	3/45	ZB5AG9	3/45	ZB5AS842Y	3/19	ZB5AZ1014	3/24	ZB6Y7430	3/6
ZB5AD48	3/46	ZB5AG09	3/45	ZB5AS844	3/18	ZB5AZ1015	3/22	ZB6Y7630	3/6
ZB5AD49	3/45	ZB5AG9D	3/46		3/42	ZB5AZ1023	3/23	ZB6Z1B	3/7
ZB5AD59	3/45	ZB5AG09D	3/46	ZB5AS934	3/18	ZB5AZ1024	3/24	ZB6Z2B	3/7
ZB5AD79	3/45	ZB5AJ2	3/44		3/42	ZB5AZ1025	3/22	ZB6Z3B	3/7
ZB5AD89	3/45	ZB5AJ3	3/44	ZB5AS942Y	3/19	ZB5AZ1033	3/23	ZB6Z4B	3/7
ZB5AD201	3/43	ZB5AJ4	3/44	ZB5AS944	3/18	ZB5AZ1034	3/24	ZB6Z5B	3/7
ZB5AD203	3/43	ZB5AJ5	3/44		3/42	ZB5AZ1035	3/22	ZBA1	3/54
ZB5AD204	3/44	ZB5AJ7	3/44	ZB5AS944D	3/18	ZB5AZ1043	3/23	ZBA2	3/54
ZB5AD205	3/44	ZB5AJ8	3/44		3/42	ZB5AZ1044	3/24	ZBA3	3/54
ZB5AD206	3/44	ZB5AK1213	3/48	ZB5AS964	3/18	ZB5AZ1045	3/22	ZBA4	3/54
ZB5AD301	3/43	ZB5AK1233	3/48		3/42	ZB5AZ1053	3/23	ZBA5	3/54
ZB5AD303	3/43	ZB5AK1243	3/48	ZB5AT2	3/42	ZB5AZ1054	3/24	ZBA6	3/54
ZB5AD304	3/44	ZB5AK1253	3/48	ZB5AT24	3/42	ZB5AZ1055	3/22	ZBA9	3/54
ZB5AD305	3/44	ZB5AK1263	3/48	ZB5AT82Y	3/19	ZB5AZ1414	3/24	ZBA131	3/54
ZB5AD306	3/44	ZB5AK1313	3/48	ZB5AT84	3/18	ZB5CA1	3/40	ZBA133	3/54
ZB5AD401	3/43	ZB5AK1333	3/48		3/42	ZB5CA2	3/40	ZBA136	3/54
ZB5AD403	3/43	ZB5AK1343	3/48	ZB5AT844	3/18	ZB5CA3	3/40	ZBA137	3/54
ZB5AD404	3/44	ZB5AK1353	3/48		3/42	ZB5CA4	3/40	ZBA138	3/54
ZB5AD405	3/44	ZB5AK1363	3/48	ZB5AT8643M	3/18	ZB5CA5	3/40	ZBA141	3/54
ZB5AD406	3/44	ZB5AK1413	3/48	ZB5AV013	3/47	ZB5CA6	3/40	ZBA142	3/54
ZB5AD501	3/43	ZB5AK1433	3/48	ZB5AV013E	3/47	ZB5CA331	3/41	ZBA145	3/54
ZB5AD503	3/43	ZB5AK1443	3/48	ZB5AV013S	3/47	ZB5CA432	3/41	ZBA232	3/54
ZB5AD504	3/44	ZB5AK1453	3/48	ZB5AV033	3/47	ZB5CA2912	3/41	ZBA233	3/54
ZB5AD505	3/44	ZB5AK1463	3/48	ZB5AV033E	3/47	ZB5CA2934	3/41	ZBA234	3/54
ZB5AD506	3/44	ZB5AK1513	3/48	ZB5AV033S	3/47	ZB5CA6939	3/41	ZBA235	3/54
ZB5AD701	3/43	ZB5AK1533	3/48	ZB5AV043	3/47	ZB5CL1	3/40	ZBA245	3/54
ZB5AD703	3/43	ZB5AK1543	3/48	ZB5AV043E	3/47	ZB5CL2	3/40	ZBA331	3/54
ZB5AD704	3/44	ZB5AK1553	3/48	ZB5AV043S	3/47	ZB5CL3	3/40	ZBA333	3/54
ZB5AD705	3/44	ZB5AK1563	3/48	ZB5AV053	3/47	ZB5CL4	3/40	ZBA334	3/54
ZB5AD706	3/44	ZB5AK1573	3/48	ZB5AV053E	3/47	ZB5CL5	3/40	ZBA335	3/54
ZB5AD801	3/43	ZB5AK1733	3/48	ZB5AV053S	3/47	ZB5CL6	3/40	ZBA336	3/54
ZB5AD803	3/43	ZB5AK1743	3/48	ZB5AV063	3/47	ZB5CV003	3/47	ZBA337	3/54
ZB5AD804	3/44	ZB5AK1753	3/48	ZB5AV063E	3/47	ZB5CV013	3/47	ZBA338	3/54
ZB5AD805	3/44	ZB5AK1763	3/48	ZB5AV063S	3/47	ZB5CV033	3/47	ZBA341	3/54
ZB5AD806	3/44	ZB5AK1813	3/48	ZB5AW113	3/47	ZB5CV043	3/47	ZBA342	3/54
ZB5AD2801	3/46	ZB5AK1833	3/48	ZB5AW143	3/47	ZB5CV053	3/47	ZBA343	3/54
ZB5AD2804	3/46	ZB5AK1843	3/48	ZB5AW153	3/47	ZB5CV063	3/47	ZBA344	3/54
ZB5AD2806	3/46	ZB5AK1853	3/48	ZB5AW163	3/47	ZB5CW313	3/47	ZBA346	3/54
ZB5AG0	3/45	ZB5AK1863	3/48	ZB5AW313	3/47	ZB5CW333	3/47	ZBA432	3/54
ZB5AG0D	3/46	ZB5AL1	3/40	ZB5AW313S	3/47	ZB5CW343	3/47	ZBA433	3/54
ZB5AG1	3/45	ZB5AL2	3/40	ZB5AW333	3/47	ZB5CW353	3/47	ZBA434	3/54
ZB5AG1D	3/46	ZB5AL3	3/40	ZB5AW333S	3/47	ZB5CW363	3/47	ZBA435	3/54
ZB5AG2	3/45	ZB5AL4	3/40	ZB5AW343	3/47	ZB5S23	3/39	ZBA639	3/54
ZB5AG02	3/45	ZB5AL5	3/40	ZB5AW343S	3/47		3/55	ZBA2934	3/54
ZB5AG2D	3/46	ZB5AL6	3/40	ZB5AW353	3/47	ZB5S25	3/55	ZBA2935	3/54
ZB5AG02D	3/46	ZB5AL232	3/41	ZB5AW353S	3/47	ZB6AS834	3/6	ZBCV0113	3/55
ZB5AG3	3/45	ZB5AL233	3/41	ZB5AW363	3/47	ZB6AS934	3/6	ZBCV0133	3/55
ZB5AG3D	3/46	ZB5AL234	3/41	ZB5AW363S	3/47	ZB6Y002	3/7	ZBCV0143	3/55
ZB5AG03D	3/46	ZB5AL235	3/41	ZB5AW713	3/48	ZB6Y003	3/7	ZBCV0153	3/55
ZB5AG4	3/45	ZB5AL432	3/41	ZB5AW733	3/48	ZB6Y004	3/7	ZBCV0163	3/55
ZB5AG4D	3/46	ZB5AL433	3/41	ZB5AW743	3/18	ZB6Y005	3/7	ZBCW9113	3/55
ZB5AG04D	3/46	ZB5AL434	3/41		3/48	ZB6Y006	3/7	ZBCW9133	3/55
ZB5AG5	3/45	ZB5AL435	3/41	ZB5AW753	3/48	ZB6Y006A	3/7	ZBCW9143	3/55
ZB5AG05	3/45	ZB5AP1S	3/40	ZB5AW763	3/48	ZB6Y009	3/7	ZBCW9153	3/55
ZB5AG5D	3/46	ZB5AP2S	3/40	ZB5AX84	3/18	ZB6Y010	3/7	ZBCW9163	3/55
ZB5AG05D	3/46	ZB5AP3S	3/40	ZB5AZ009	3/20	ZB6Y011	3/7	ZBCW9313	3/55
					3/22				
					3/24				
					3/39				

# Preventa solutions for efficient machine safety

## Product reference index

ZBCW9333	3/55	ZBE5043	3/14 3/23	ZBVB14	3/15 3/24	ZBVJ15	3/13 3/22	ZBY1105	3/53
ZBCW9343	3/55	ZBE5053	3/14 3/23	ZBVB15	3/13 3/22	ZBVJ35	3/13 3/22	ZBY1106	3/53
ZBCW9353	3/55	ZBE10163	3/14 3/23	ZBVB34	3/15 3/24	ZBVJ45	3/13 3/22	ZBY1107	3/53
ZBCW9363	3/55	ZBE10263	3/14 3/23	ZBVB35	3/13 3/22	ZBVJ55	3/13 3/22	ZBY1108	3/53
ZBCY2H101	3/49	ZBG421E	3/55	ZBVB44	3/15 3/24	ZBVJ65	3/13 3/22	ZBY1115	3/53
ZBCY4H101	3/49	ZBG455	3/55	ZBVB45	3/13 3/22	ZBVM1	3/12 3/21 3/39	ZBY1116	3/53
ZBCY1101	3/53	ZBG458A	3/55	ZBVB54	3/15 3/24	ZBVM3	3/12 3/21 3/39	ZBY1146	3/53
ZBCZ34	3/49	ZBG520E	3/55	ZBVB55	3/13 3/22	ZBVM4	3/12 3/21 3/39	ZBY1147	3/53
ZBE101	3/11 3/20 3/39	ZBG3131A	3/55	ZBVB64	3/15 3/24	ZBVM5	3/12 3/21 3/39	ZBY1148	3/53
ZBE102	3/11 3/20 3/39	ZBL1	3/54	ZBVB65	3/13 3/22	ZBVM6	3/12 3/21 3/39	ZBY1149	3/53
ZBE201	3/11 3/20	ZBL2	3/54	ZBVBG1	3/12 3/21	ZBVM14	3/15 3/24	ZBY1203	3/53
ZBE202	3/11 3/20	ZBL3	3/54	ZBVBG3	3/12 3/21	ZBVM15	3/13 3/22	ZBY1204	3/53
ZBE203	3/11 3/20	ZBL4	3/54	ZBVBG4	3/12 3/21	ZBVM34	3/15 3/24	ZBY1207	3/53
ZBE204	3/11 3/20	ZBL5	3/54	ZBVBG5	3/12 3/21	ZBVM35	3/13 3/22	ZBY1208	3/53
ZBE205	3/11 3/20	ZBL6	3/54	ZBVBG6	3/12 3/21	ZBVM44	3/15 3/24	ZBY1214	3/53
ZBE501	3/11 3/20	ZBL9	3/54	ZBVG1	3/12 3/21 3/39	ZBVM54	3/15 3/24	ZBY1303	3/53
ZBE502	3/11 3/20	ZBV5B	3/12 3/21	ZBVG3	3/12 3/21 3/39	ZBVM55	3/13 3/22	ZBY1304	3/53
ZBE503	3/11 3/20	ZBV18B1	3/12 3/21	ZBVG4	3/12 3/21 3/39	ZBVM64	3/15 3/24	ZBY1311	3/53
ZBE504	3/11 3/20	ZBV18B3	3/12 3/21	ZBVG5	3/12 3/21 3/39	ZBVM65	3/13 3/22	ZBY1312	3/53
ZBE505	3/11 3/20	ZBV18B4	3/12 3/21	ZBVG6	3/12 3/21 3/39	ZBW9113	3/55	ZBY1316	3/53
ZBE1013	3/14 3/23	ZBV18B5	3/12 3/21	ZBVG14	3/15 3/24	ZBW9133	3/55	ZBY1912	3/53
ZBE1014	3/15 3/24	ZBV18B6	3/12 3/21	ZBVG15	3/13 3/22	ZBW9143	3/55	ZBY2101	3/49
ZBE1015	3/13 3/22	ZBV18B8	3/12 3/21	ZBVG34	3/15 3/24	ZBW9153	3/55	ZBY2103	3/49
ZBE1016	3/11 3/20	ZBV18G1	3/12 3/21	ZBVG35	3/13 3/22	ZBW9163	3/55	ZBY2104	3/49
ZBE1016P	3/11 3/20	ZBV18G3	3/12 3/21	ZBVG44	3/15 3/24	ZBW9313	3/55	ZBY2105	3/49
ZBE1016P3	3/14 3/23	ZBV18G4	3/12 3/21	ZBVG45	3/13 3/22	ZBW9333	3/55	ZBY2106	3/49
ZBE1023	3/14 3/23	ZBV18G5	3/12 3/21	ZBVG54	3/15 3/24	ZBW9343	3/55	ZBY2106	3/49
ZBE1024	3/15 3/24	ZBV18G6	3/12 3/21	ZBVG55	3/13 3/22	ZBW9353	3/55	ZBY2107	3/49
ZBE1025	3/13 3/22	ZBV18M1	3/12 3/21	ZBVG64	3/15 3/24	ZBW9363	3/55	ZBY2107	3/49
ZBE1026	3/11 3/20	ZBV18M3	3/12 3/21	ZBVG65	3/13 3/22	ZBY001	3/11 3/13 3/14 3/20 3/22 3/23	ZBY2108	3/49
ZBE1026P	3/11 3/20	ZBV18M4	3/12 3/21	ZBVJ1	3/12 3/21	ZBY2H101	3/49	ZBY2108	3/49
ZBE1026P3	3/14 3/23	ZBV18M5	3/12 3/21	ZBVJ3	3/12 3/21	ZBY4H101	3/49	ZBY2109	3/49
ZBE2013	3/14 3/23	ZBV18M6	3/12 3/21	ZBVJ4	3/12 3/21	ZBY0101	3/51	ZBY2110	3/49
ZBE2023	3/14 3/23	ZBV0103S	3/55	ZBVJ5	3/12 3/21	ZBY0102	3/51	ZBY2110	3/49
ZBE2033	3/14 3/23	ZBV0113	3/55	ZBVJ6	3/12 3/21	ZBY0104	3/49	ZBY2111	3/49
ZBE2043	3/14 3/23	ZBV0133	3/55			ZBY00104	3/51	ZBY2111	3/49
ZBE2053	3/14 3/23	ZBV0143	3/55			ZBY0123	3/49	ZBY2112	3/49
ZBE5013	3/14 3/23	ZBV0153	3/55			ZBY0123	3/51	ZBY2112	3/49
ZBE5023	3/14 3/23	ZBV0163	3/55			ZBY00123	3/51	ZBY2113	3/49
ZBE5033	3/14 3/23	ZBVB1	3/12 3/21 3/39			ZBY0140	3/51	ZBY2113	3/49
		ZBVB3	3/12 3/21 3/39			ZBY0140	3/51	ZBY2114	3/49
		ZBVB4	3/12 3/21 3/39			ZBY1101	3/53	ZBY2114	3/49
		ZBVB5	3/12 3/21 3/39			ZBY1103	3/53	ZBY2115	3/49
		ZBVB6	3/12 3/21 3/39			ZBY1104	3/53	ZBY2115	3/49

3

ZBY02133	3/51	ZBY2227	3/50	ZBY02326	3/52	ZBY9121	3/10	ZBZ58	3/10
ZBY2134	3/49	ZBY02227	3/52	ZBY2327	3/50		3/17		3/19
ZBY02134	3/51	ZBY2228	3/50	ZBY02327	3/52		3/19		3/55
ZBY2135	3/49	ZBY02228	3/52	ZBY2328	3/50		3/26	ZBZ1600	3/17
ZBY02135	3/51	ZBY2229	3/50	ZBY02328	3/52		3/27		3/26
ZBY2146	3/49	ZBY02229	3/52	ZBY2330	3/50	ZBY9130	3/53		3/54
ZBY02146	3/51	ZBY2230	3/50	ZBY02330	3/52	ZBY9130T	3/17	ZBZ1602	3/17
ZBY2147	3/49	ZBY02230	3/52	ZBY2334	3/50		3/26		3/54
ZBY02147	3/51	ZBY2231	3/50	ZBY02334	3/52	ZBY9140	3/53	ZBZ1604	3/17
ZBY2148	3/49	ZBY02231	3/52	ZBY2364	3/50	ZBY9140T	3/17		3/26
ZBY02148	3/51	ZBY2232	3/50	ZBY02364	3/52		3/26		3/54
ZBY2164	3/49	ZBY02232	3/52	ZBY2366	3/50	ZBY9160	3/16	ZBZ1606	3/17
ZBY02164	3/51	ZBY2233	3/50	ZBY02366	3/52		3/25		3/26
ZBY2165	3/49	ZBY02233	3/52	ZBY2367	3/50		3/53		3/54
ZBY02165	3/51	ZBY2234	3/50	ZBY02367	3/52	ZBY9160T	3/17	ZBZ2102	3/17
ZBY2166	3/49	ZBY02234	3/52	ZBY2385	3/50		3/26		3/26
ZBY02166	3/51	ZBY2235	3/50	ZBY02385	3/52	ZBY9220	3/10	ZBZ3605	3/17
ZBY2167	3/49	ZBY02235	3/52	ZBY2387	3/50		3/17		3/26
ZBY02167	3/51	ZBY2265	3/50	ZBY02387	3/52		3/19	ZBZG156	3/12
ZBY2178	3/49	ZBY02265	3/52	ZBY2931	3/49		3/26		3/21
ZBY02178	3/51	ZBY2266	3/50	ZBY02931	3/51		3/27	ZBZVG	3/12
ZBY2179	3/49	ZBY02266	3/52	ZBY4100	3/51	ZBY9230	3/53		3/21
ZBY02179	3/51	ZBY2267	3/50	ZBY4101	3/49	ZBY9230T	3/17	ZBZVM	3/12
ZBY2184	3/49	ZBY02267	3/52	ZBY4140	3/49		3/26		3/21
ZBY02184	3/51	ZBY2284	3/50	ZBY8101	3/16	ZBY9260	3/16	ZENL1111	3/39
ZBY2185	3/49	ZBY02284	3/52		3/25		3/25	ZENL1121	3/39
ZBY02185	3/51	ZBY2295	3/50	ZBY8130	3/16	ZBY9260T	3/17		
ZBY2186	3/49	ZBY02295	3/52		3/25		3/26		
ZBY02186	3/51	ZBY2297	3/50		3/27	ZBY9320	3/10		
ZBY2195	3/49	ZBY02297	3/52	ZBY8140	3/16		3/17		
ZBY02195	3/51	ZBY2298	3/50		3/25		3/19		
ZBY2196	3/49	ZBY02298	3/52		3/27		3/26		
ZBY02196	3/51	ZBY2299	3/50	ZBY8160	3/16	ZBY9330	3/53		
ZBY2197	3/49	ZBY02299	3/52		3/25	ZBY9330T	3/17		
ZBY02197	3/51	ZBY2303	3/50		3/53		3/26		
ZBY2198	3/49	ZBY02303	3/52	ZBY8230	3/16	ZBY9360	3/16		
ZBY02198	3/51	ZBY2304	3/49		3/25		3/25		
ZBY2199	3/49	ZBY02304	3/51		3/27		3/53		
ZBY02199	3/51	ZBY2305	3/50	ZBY8260	3/16	ZBY9360T	3/17		
ZBY2203	3/50	ZBY02305	3/52		3/25		3/26		
ZBY02203	3/52	ZBY2306	3/50	ZBY8330	3/16	ZBY9420	3/10		
ZBY2204	3/50	ZBY02306	3/52		3/25		3/17		
ZBY02204	3/52	ZBY2307	3/50		3/27		3/19		
ZBY2205	3/50	ZBY02307	3/52		3/53		3/26		
ZBY02205	3/52	ZBY2308	3/50	ZBY8360	3/16		3/27		
ZBY2206	3/50	ZBY02308	3/52		3/25	ZBY9430	3/53		
ZBY02206	3/52	ZBY2309	3/50		3/53	ZBY9460	3/16		
ZBY2207	3/50	ZBY02309	3/52	ZBY8430	3/16		3/25		
ZBY02207	3/52	ZBY2310	3/50		3/25		3/53		
ZBY2208	3/50	ZBY02310	3/52		3/27	ZBY9620	3/10		
ZBY02208	3/52	ZBY2311	3/50	ZBY8460	3/16		3/17		
ZBY2209	3/50	ZBY02311	3/52		3/25		3/19		
ZBY02209	3/52	ZBY2312	3/50	ZBY8630	3/16		3/26		
ZBY2210	3/50	ZBY02312	3/52		3/25	ZBY9630	3/53		
ZBY02210	3/52	ZBY2313	3/50		3/27	ZBY9660	3/16		
ZBY2211	3/50	ZBY02313	3/52		3/53		3/25		
ZBY02211	3/52	ZBY2314	3/50	ZBY8660	3/16		3/53		
ZBY2212	3/50	ZBY02314	3/52		3/25	ZBY22420001	3/50		
ZBY02212	3/52	ZBY2316	3/50	ZBY9101	3/16	ZBY022420001	3/52		
ZBY2213	3/50	ZBY02316	3/52		3/25	ZBZ001	3/11		
ZBY02213	3/52	ZBY2321	3/50		3/53		3/14		
ZBY2214	3/50	ZBY02321	3/52	ZBY9101T	3/17		3/20		
ZBY02214	3/52	ZBY2322	3/50		3/26		3/23		
ZBY2223	3/50	ZBY02322	3/52	ZBY9120	3/10	ZBZ28	3/10		
ZBY02223	3/52	ZBY2323	3/50		3/17		3/19		
ZBY2226	3/50	ZBY02323	3/52		3/19		3/55		
ZBY02226	3/52	ZBY2326	3/50		3/26	ZBZ32	3/49		
					3/27	ZBZ34	3/49		
					3/53				



**More information on**  
<http://www.schneider-electric.com/machinesafety>

#### **Schneider Electric Industries SAS**

Head Office  
35, rue Joseph Monier  
F-92500 Rueil-Malmaison  
France

The information provided in this documentation contains general descriptions and/or technical characteristics of the performance of the products contained herein. This documentation is not intended as a substitute for and is not to be used for determining suitability or reliability of these products for specific user applications. It is the duty of any such user or integrator to perform the appropriate and complete risk analysis, evaluation and testing of the products with respect to the relevant specific application or use thereof. Neither Schneider Electric nor any of its affiliates or subsidiaries shall be responsible or liable for misuse of the information contained herein.

Design: Schneider Electric  
Photos: Schneider Electric

MKTED2140201EN