

Cam-Lok™ J series connectors are specifically designed to meet the needs of demanding portable applications. J series plugs and receptacles are the proven industry standard single-pole connectors for reliability and service with added safety.

### Applications:

- Specifically designed for industrial power distribution applications requiring quick, tool-free connections
- Ideal for portable power, power distribution, motors, generators and entertainment applications; J series replaces traditional hard wiring while cutting downtime and maintenance
- J series connectors are insulated, shatter/crack-resistant and watertight, plus heat, weather, ozone, oil and abrasion-resistant

### Certifications and compliances:

- Listed to UL1691
- Listed to CSA C22.2 No. 1691-12
- CSA certified to C22.2 No. 182.3 LR13963

### Environmental rating:

- NEMA 3R or NEMA 4

### Standard materials:

- Accepts cable sizes #8 AWG - 800 MCM
- Insulator – elastomeric; rubber
- Contact – brass; copper



### Electrical ratings:

- 600 VAC
- 690 amperes continuous

### Temperature ratings:

- -40°C to 105°C

## Features:

**1** Non-metallic retaining screw provides safe, strong and reliable contact retention

**2** Easy assembly with standard tools

**3** Retaining screw snaps into place to prevent loss

**4** E-Z align drive pin increases torque and longitudinal strength 300%

**5** Accommodates a wide range of cable sizes: #2 – 4/0

**6** Non-vulcanized E1016 and E-Z1016 plugs feature a high strength, molded-in-place locking ring to capture and secure the insulator to the contact

**7** Double set screw termination for added strength (crimp also available)

**8** Fully insulated for direct mounting to steel panels

**9** Threaded stud and double set screw receptacles available (other terminations and stud lengths available)

**10** Snapback covers provide NEMA 3R environmental seal

**11** High impact-resistant thermoplastic protects receptacles from damage

**12** Custom cover logos available

**13** Wide range of colors available

## plugs

Cable size #8 - #4 AWG

600 VAC/VDC, up to 150A continuous

### J series E1015, elastomeric, non-vulcanized, single set screw connection

#### Features:

- Double cam principle provides a positive, vibration-proof connection
- Self-compensating for wear
- No moving contact surfaces, eliminating arcing or burning
- Superior electromechanical connections
- Locked contacts will withstand a pulling force of 1,000 lbs.
- 1/3 of a turn assures a high pressure contact approaching 600 lbs. per sq. in., providing minimum resistance
- Contacts carefully machined from a high conductivity brass to provide a smooth sliding fit and easy locking action
- Watertight elastomeric insulators molded from colorfast material, color-coded for easy phase identification
- Recessed contacts protected by insulating jacket that extends beyond contact ends for safety
- Integrated strain relief system features a retaining wire that prevents cable jacket pull-away and bare conductor exposure
- Accepts a wide range of cable sizes

#### Certifications and compliances:

- Listed to UL1691
- Listed to CSA C22.2 No. 1691-12
- CSA certified to C22.2 No. 182.3 LR13963

#### Environmental rating:

- NEMA 3R

#### Material characteristics:

- Insulator – TPE
- Temperature rating – operating ambient: -40°C to 105°C

#### Ordering information:



E1015-8313



E1015-8333

#### Set screw non-vulcanized plugs

##### Male

Cable size	Color	Cat. # Complete	Cat. # Contact only	Cat. # Insulator only
#8 - #4	Black	E1015-8306	A100864-1	A100869-7
	Red	E1015-8308		A100869-9
	Green	E1015-8310		A100869-11
	White	E1015-8311		A100869-12
	Blue	E1015-8313		A100869-14
	Brown	E1015-8314		A100869-15
	Orange	E1015-8309		A100869-10
	Yellow	E1015-8307		A100869-8

##### Female

Cable size	Color	Cat. # Complete	Cat. # Contact only	Cat. # Insulator only
#8 - #4	Black	E1015-8331	A100865-1	A100868-7
	Red	E1015-8333		A100868-9
	Green	E1015-8335		A100868-11
	White	E1015-8336		A100868-12
	Blue	E1015-8338		A100868-14
	Brown	E1015-8339		A100868-15
	Orange	E1015-8334		A100868-10
	Yellow	E1015-8332		A100868-8

To order single packaged products, add suffix 'K' to the complete catalog number.

#### Dimensions:

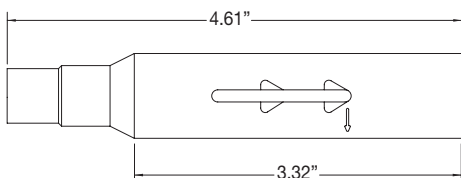

Male non-vulcanized plug

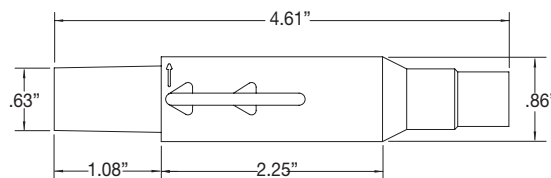

Female non-vulcanized plug

# Cam-Lok J series E1015 plugs

NEMA 4

10P

Cable size #8 - #4 AWG

600 VAC/VDC, up to 150A continuous

## J series E1015, rubber, vulcanized, crimp connection

### Features:

- Vulcanizing permanently affixes plug insulator to cable for maximum protection against bare conductors, water, all kinds of weather, corrosion and other contaminants (requires vulcanizing kit/ presses)
- Vulcanizing also reduces cable breakage by distributing flexing over a wide area for an effective strain relief system
- Double cam principle provides a positive, vibration-proof connection
- Self-compensating for wear
- No moving contact surfaces, eliminating arcing or burning
- Superior electromechanical connections
- Locked contacts will withstand a pulling force of 1,000 lbs.
- 1/3 of a turn assures a high pressure contact approaching 600 lbs. per sq. in., providing minimum resistance
- Contacts carefully machined from a high conductivity brass to provide a smooth sliding fit and easy locking action
- Watertight neoprene insulators molded from colorfast material, color-coded for easy phase identification
- Recessed contacts protected by insulating jacket that extends beyond contact ends for safety

### Certifications and compliances:

- Listed to UL1691
- Listed to CSA C22.2 No. 1691-12
- CSA certified to C22.2 No. 182.3 LR13963

### Environmental rating:

- NEMA 4

### Material characteristics:

- Insulator – rubber
- Temperature rating – operating ambient: -40°C to 105°C

### Ordering information:

### Crimp vulcanized plugs

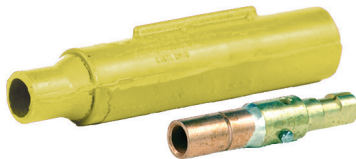

E1015-2



E1015-55

Male				
Cable size	Color	Cat. # Complete	Cat. # Contact only	Cat. # Insulator only
#8 - #4	Black	E1015-1	A100087-1	A100092-1
	Red	E1015-3		A100092-3
	Green	E1015-5		A100092-5
	White	E1015-6		A100092-6
	Blue	E1015-19		A100092-7
	Brown	E1015-22		A100092-8
	Orange	E1015-4		A100092-4
	Yellow	E1015-2		A100092-2

Female				
Cable size	Color	Cat. # Complete	Cat. # Contact only	Cat. # Insulator only
#8 - #4	Black	E1015-50	A100088-1	A100093-1
	Red	E1015-52		A100093-3
	Green	E1015-54		A100093-5
	White	E1015-55		A100093-6
	Blue	E1015-47		A100093-14
	Brown	E1015-44		A100093-15
	Orange	E1015-53		A100093-4
	Yellow	E1015-51		A100093-2

To order single packaged products, add suffix 'K' to the complete catalog number.

### Dimensions:

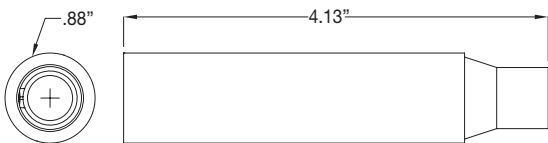

Male vulcanized plug

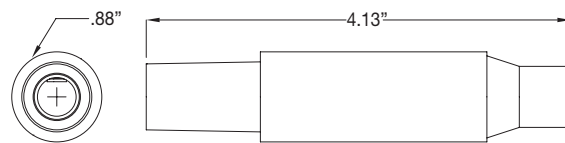

Female vulcanized plug

# Cam-Lok J series E1015 receptacles and terminals

NEMA 3R

10P

Cable size #8 - #4 AWG

600 VAC/VDC, up to 150A continuous

## J series E1015, elastomeric or rubber

### Features:

- Double cam principle provides a positive, vibration-proof connection
- Self-compensating for wear
- No moving contact surfaces, eliminating arcing or burning
- Superior electromechanical connections
- Locked contacts will withstand a pulling force of 1,000 lbs.
- 1/3 of a turn assures a high pressure contact approaching 600 lbs. per sq. in., providing minimum resistance
- Contacts carefully machined from a high conductivity brass to provide a smooth sliding fit and easy locking action
- Body molded from colorfast material, color-coded for easy phase identification
- Receptacles are watertight elastomeric; terminals are rubber
- Recessed contacts protected by insulating jacket that extends beyond contact ends for safety
- Receptacles are safety insulated for direct mounting to steel panels

### Certifications and compliances:

- Listed to UL1691
- Listed to CSA C22.2 No. 1691-12
- CSA certified to C22.2 No. 182.3 LR13963

### Environmental rating:

- NEMA 3R

### Material characteristics:

- Receptacles – TPE
- Terminals – rubber
- Temperature rating – operating ambient: -40°C to 105°C

### Ordering information:

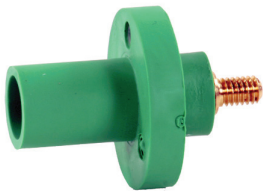

E1015-1604

### Threaded studs

Cable size	Color	Cat. # Male terminals	Cat. # Female terminals
#8 - #4	Black	E1015-1600	E1015-1625
	Red	E1015-1602	E1015-1627
	Green	E1015-1604	E1015-1629
	White	E1015-1605	E1015-1630
	Blue	E1015-1606	E1015-1631
	Brown	E1015-1607	E1015-1632
	Orange	E1015-1603	E1015-1628
	Yellow	E1015-1601	E1015-1626

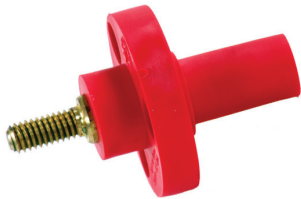

E1015-1625

### Female terminals

Cable size	Color	Cat. # Angle style	Cat. # Offset style
#8 - #4	Black	E1015-575	E1015-625
	Red	E1015-577	E1015-627
	Green	E1015-579	E1015-629
	White	E1015-580	E1015-630
	Blue	E1015-581	E1015-631
	Brown	E1015-589	E1015-632
	Orange	E1015-578	E1015-628
	Yellow	E1015-576	E1015-626

To order single packaged products, add suffix 'K' to the complete catalog number.

### Dimensions:

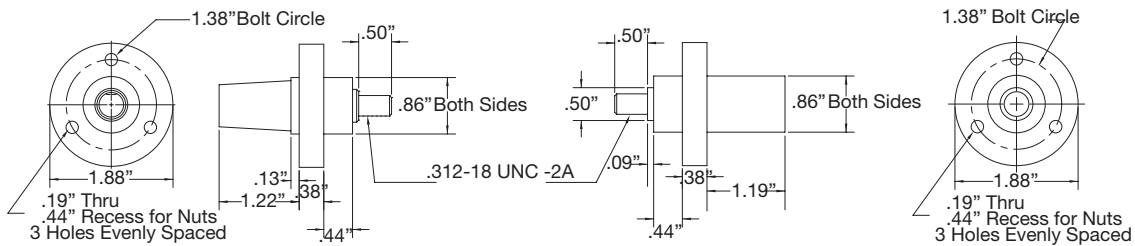

Female and male receptacles

# Cam-Lok J series E1015 accessories

NEMA 3R

10P

Cable size #8 - #4 AWG  
600 VAC/VDC, up to 150A continuous

## J series E1015, rubber

### Features:

- Double cam principle provides a positive, vibration-proof connection
- Self-compensating for wear
- No moving contact surfaces, eliminating arcing or burning
- Superior electromechanical connections
- Locked contacts will withstand a pulling force of 1,000 lbs.
- 1/3 of a turn assures a high pressure contact approaching 600 lbs. per sq. in., providing minimum resistance
- Contacts carefully machined from a high conductivity brass to provide a smooth sliding fit, even before to locking
- Watertight neoprene insulators molded from colorfast material, color-coded for easy phase identification
- Recessed contacts protected by insulating jacket that extends beyond contact ends for safety

### Certifications and compliances:

- Listed to UL1691
- Listed to CSA C22.2 No. 1691-12
- CSA certified to C22.2 No. 182.3 LR13963

### Environmental rating:

- NEMA 3R

### Material characteristics:

- Body – rubber
- Temperature rating – operating ambient: -40°C to 105°C

### Ordering information:



E1015-2314



A100792-1

## Three-way 'T' connectors and adapters

Color	Three-way 'T' connectors		Adapters		
	Cat. # Paralleling 'T' M-M-F	Cat. # Tapping 'T' M-F-F	Cat. # Double female	Cat. # Double male	Cat. # Male / female
Black	E1015-2324	E1015-2312	E1015-2352	E1015-2362	E1015-2336
Red	E1015-2326	E1015-2314	E1015-2354	E1015-2364	E1015-2338
Green	E1015-2328	E1015-2316	E1015-2356	E1015-2366	E1015-2340
White	E1015-2329	E1015-2317	E1015-2357	E1015-2367	E1015-2341
Blue	E1015-2348	E1015-2350	E1015-2358	E1015-2368	E1015-2361
Brown	E1015-2342	E1015-2370	E1015-2359	E1015-2369	E1015-2371
Orange	E1015-2327	E1015-2315	E1015-2355	E1015-2365	E1015-2339
Yellow	E1015-2325	E1015-2313	E1015-2353	E1015-2363	E1015-2337

## Protective caps

Color	Cat. # Male	Cat. # Female
Black	A100793-1	A100792-1
Red	A100793-3	A100792-3
Green	A100793-5	A100792-5
White	A100793-6	A100792-6
Blue	A100793-7	A100792-13
Brown	A100793-8	A100792-7
Orange	A100793-4	A100792-4
Yellow	A100793-2	A100792-2

To order single packaged products, add suffix 'K' to the complete catalog number.

## Dimensions:

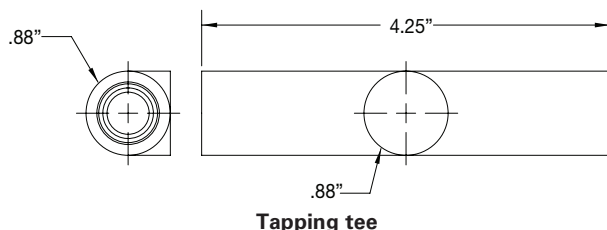



## plugs

Cable size #6 - #2 AWG

600 VAC/VDC, up to 190A continuous

### J series E-Z1016, elastomeric, non-vulcanized, double set screw connection

#### Features:

- E-Z assembly and disassembly – no tools needed
- Double cam principle provides a positive, vibration-proof connection
- Self-compensating for wear
- No moving contact surfaces, eliminating arcing or burning
- Superior electromechanical connections
- Locked contacts will withstand a pulling force of 1,000 lbs.
- 1/3 of a turn assures a high pressure contact approaching 600 lbs. per sq. in., providing minimum resistance
- Contacts carefully machined from a high conductivity brass to provide a smooth sliding fit and easy locking action
- Watertight elastomeric insulators molded from colorfast material, color-coded for easy phase identification
- Recessed contacts protected by insulating jacket that extends beyond contact ends for safety
- Integrated strain relief system features a retaining wire that prevents cable jacket pull-away and bare conductor exposure
- Plugs feature a high strength, molded-in-place locking ring to capture and secure the insulator to the contact
- Accepts a wide range of cable sizes

#### Certifications and compliances:

- Listed to UL1691
- Listed to CSA C22.2 No. 1691-12
- CSA certified to C22.2 No. 182.3 LR13963

#### Environmental rating:

- NEMA 3R

#### Material characteristics:

- Insulator – TPE
- Temperature rating – operating ambient: -40°C to 105°C

#### Ordering information:

#### Double set screw non-vulcanized plugs



E-Z1016-8822

#### Male

Cable size	Color	Cat. # Complete	Cat. # Contact only	Cat. # Insulator only
#6 - #2	Black	E-Z1016-8818	A200630-13	E-Z200074-88
	Red	E-Z1016-8820		E-Z200074-89
	Green	E-Z1016-8822		E-Z200074-90
	White	E-Z1016-8824		E-Z200074-91
	Blue	E-Z1016-8826		E-Z200074-92
	Brown	E-Z1016-8828		E-Z200074-93
	Orange	E-Z1016-8830		E-Z200074-94
	Yellow	E-Z1016-8832		E-Z200074-95



E-Z1016-8821

#### Female

Cable size	Color	Cat. # Complete	Cat. # Contact only	Cat. # Insulator only
#6 - #2	Black	E-Z1016-8819	A200640-13	E-Z200075-80
	Red	E-Z1016-8821		E-Z200075-81
	Green	E-Z1016-8823		E-Z200075-82
	White	E-Z1016-8825		E-Z200075-83
	Blue	E-Z1016-8827		E-Z200075-84
	Brown	E-Z1016-8829		E-Z200075-85
	Orange	E-Z1016-8831		E-Z200075-86
	Yellow	E-Z1016-8833		E-Z200075-87

To order single packaged products, add suffix 'K' to the complete catalog number.

#### Dimensions:

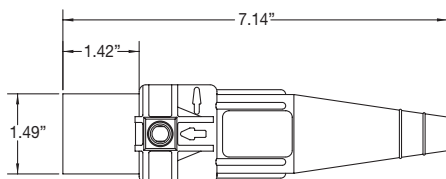

Male connector

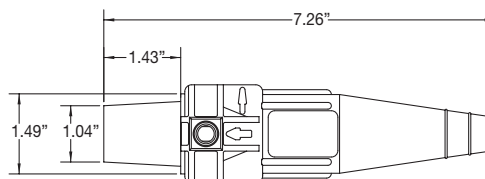

Female connector

# Cam-Lok J series E-Z1016 plugs

NEMA 3R

10P

Cable size #2 AWG - 2/0

600 VAC/VDC, up to 300A continuous

## J series E-Z1016, elastomeric, non-vulcanized, double set screw connection

### Features:

- E-Z assembly and disassembly – no tools needed
- Double cam principle provides a positive, vibration-proof connection
- Self-compensating for wear
- No moving contact surfaces, eliminating arcing or burning
- Superior electromechanical connections
- Locked contacts will withstand a pulling force of 1,000 lbs.
- 1/3 of a turn assures a high pressure contact approaching 600 lbs. per sq. in., providing minimum resistance
- Contacts carefully machined from a high conductivity brass to provide a smooth sliding fit and easy locking action
- Watertight elastomeric insulators molded from colorfast material, color-coded for easy phase identification
- Recessed contacts protected by insulating jacket that extends beyond contact ends for safety
- Integrated strain relief system features a retaining wire that prevents cable jacket pull-away and bare conductor exposure
- Plugs feature a high strength, molded-in-place locking ring to capture and secure the insulator to the contact
- Accepts a wide range of cable sizes

### Certifications and compliances:

- Listed to UL1691
- Listed to CSA C22.2 No. 1691-12
- CSA certified to C22.2 No. 182.3 LR13963

### Environmental rating:

- NEMA 3R

### Material characteristics:

- Insulator – TPE
- Temperature rating – operating ambient: -40°C to 105°C

### Ordering information:



E-Z1016-8354



E-Z1016-8380

### Double set screw non-vulcanized plugs

Male				
Cable size	Color	Cat. # Complete	Cat. # Contact only	Cat. # Insulator only
#2 - 2/0	Black	E-Z1016-8350	A200630-1	E-Z200074-19
	Red	E-Z1016-8352		E-Z200074-21
	Green	E-Z1016-8354		E-Z200074-23
	White	E-Z1016-8355		E-Z200074-24
	Blue	E-Z1016-8356		E-Z200074-38
	Brown	E-Z1016-8357		E-Z200074-47
	Orange	E-Z1016-8353		E-Z200074-22
	Yellow	E-Z1016-8351		E-Z200074-20

Female				
Cable size	Color	Cat. # Complete	Cat. # Contact only	Cat. # Insulator only
#2 - 2/0	Black	E-Z1016-8375	A200640-3	E-Z200075-19
	Red	E-Z1016-8377		E-Z200075-21
	Green	E-Z1016-8379		E-Z200075-23
	White	E-Z1016-8380		E-Z200075-24
	Blue	E-Z1016-8381		E-Z200075-44
	Brown	E-Z1016-8382		E-Z200075-52
	Orange	E-Z1016-8378		E-Z200075-22
	Yellow	E-Z1016-8376		E-Z200075-20

To order single packaged products, add suffix 'K' to the complete catalog number.

### Dimensions:

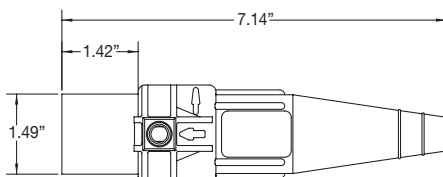

Male connector

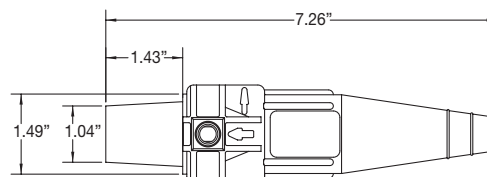

Female connector



## plugs

Cable size 2/0 - 4/0

600 VAC/VDC, up to 400A continuous

### J series E-Z1016, elastomeric, non-vulcanized, double set screw connection

#### Features:

- E-Z assembly and disassembly – no tools needed
- Double cam principle provides a positive, vibration-proof connection
- Self-compensating for wear
- No moving contact surfaces, eliminating arcing or burning
- Superior electromechanical connections
- Locked contacts will withstand a pulling force of 1,000 lbs.
- 1/3 of a turn assures a high pressure contact approaching 600 lbs. per sq. in., providing minimum resistance
- Contacts carefully machined from a high conductivity brass to provide a smooth sliding fit and easy locking action
- Watertight elastomeric insulators molded from colorfast material, color-coded for easy phase identification
- Recessed contacts protected by insulating jacket that extends beyond contact ends for safety
- Integrated strain relief system features a retaining wire that prevents cable jacket pull-away and bare conductor exposure
- Plugs feature a high strength, molded-in-place locking ring to capture and secure the insulator to the contact
- Accepts a wide range of cable sizes

#### Certifications and compliances:

- Listed to UL1691
- Listed to CSA C22.2 No. 1691-12
- CSA certified to C22.2 No. 182.3 LR13963

#### Environmental rating:

- NEMA 3R

#### Material characteristics:

- Insulator – TPE
- Temperature rating – operating ambient: -40°C to 105°C

#### Ordering information:

### Double set screw non-vulcanized plugs



E-Z1016-8368



E-Z1016-8389

#### Male

Cable size	Color	Cat. # Complete	Cat. # Contact only	Cat. # Insulator only
2/0 - 4/0	Black	E-Z1016-8362	A200639-1	E-Z200074-60
	Red	E-Z1016-8364		E-Z200074-62
	Green	E-Z1016-8366		E-Z200074-64
	White	E-Z1016-8367		E-Z200074-65
	Blue	E-Z1016-8368		E-Z200074-66
	Brown	E-Z1016-8369		E-Z200074-67
	Orange	E-Z1016-8365		E-Z200074-63
	Yellow	E-Z1016-8363		E-Z200074-61

#### Female

Cable size	Color	Cat. # Complete	Cat. # Contact only	Cat. # Insulator only
2/0 - 4/0	Black	E-Z1016-8387	A200641-1	E-Z200075-60
	Red	E-Z1016-8389		E-Z200075-62
	Green	E-Z1016-8391		E-Z200075-64
	White	E-Z1016-8392		E-Z200075-65
	Blue	E-Z1016-8393		E-Z200075-66
	Brown	E-Z1016-8394		E-Z200075-67
	Orange	E-Z1016-8390		E-Z200075-63
	Yellow	E-Z1016-8388		E-Z200075-61

To order single packaged products, add suffix 'K' to the complete catalog number.

#### Dimensions:

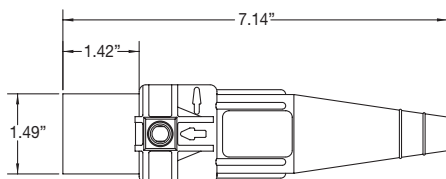

Male connector

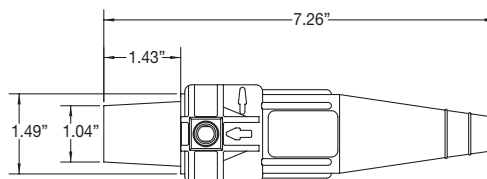

Female connector

# Cam-Lok J series E-Z1016 plugs

NEMA 3R

10P

Cable size #2 - #1 AWG

600 VAC/VDC, up to 190A continuous

## J series E-Z1016, elastomeric, non-vulcanized, crimp connection

### Features:

- E-Z assembly and disassembly – no tools needed
- Double cam principle provides a positive, vibration-proof connection
- Self-compensating for wear
- No moving contact surfaces, eliminating arcing or burning
- Superior electromechanical connections
- Locked contacts will withstand a pulling force of 1,000 lbs.
- 1/3 of a turn assures a high pressure contact approaching 600 lbs. per sq. in., providing minimum resistance
- Contacts carefully machined from a high conductivity brass to provide a smooth sliding fit and easy locking action
- Watertight elastomeric insulators molded from colorfast material, color-coded for easy phase identification
- Recessed contacts protected by insulating jacket that extends beyond contact ends for safety
- Integrated strain relief system features a retaining wire that prevents cable jacket pull-away and bare conductor exposure
- Plugs feature a high strength, molded-in-place locking ring to capture and secure the insulator to the contact

### Certifications and compliances:

- Listed to UL1691
- Listed to CSA C22.2 No. 1691-12
- CSA certified to C22.2 No. 182.3 LR13963

### Environmental rating:

- NEMA 3R

### Material characteristics:

- Insulator – TPE
- Temperature rating – operating ambient: -40°C to 105°C

### Ordering information:



E-Z1016-8006

### Crimp non-vulcanized plugs

Male				
Cable size	Color	Cat. # Complete	Cat. # Contact only	Cat. # Insulator only
#2 - #1	Black	E-Z1016-8006	A200036-18	E-Z200074-19
	Red	E-Z1016-8008		E-Z200074-21
	Green	E-Z1016-8010		E-Z200074-23
	White	E-Z1016-8011		E-Z200074-24
	Blue	E-Z1016-7700		E-Z200074-38
	Brown	E-Z1016-7701		E-Z200074-47
	Orange	E-Z1016-8009		E-Z200074-22
	Yellow	E-Z1016-8007		E-Z200074-20



E-Z1016-8058

Female				
Cable size	Color	Cat. # Complete	Cat. # Contact only	Cat. # Insulator only
#2 - #1	Black	E-Z1016-8056	A200037-23	E-Z200075-19
	Red	E-Z1016-8058		E-Z200075-21
	Green	E-Z1016-8060		E-Z200075-23
	White	E-Z1016-8061		E-Z200075-24
	Blue	E-Z1016-7716		E-Z200075-44
	Brown	E-Z1016-7717		E-Z200075-52
	Orange	E-Z1016-8059		E-Z200075-22
	Yellow	E-Z1016-8057		E-Z200075-20

To order single packaged products, add suffix 'K' to the complete catalog number.

### Dimensions:

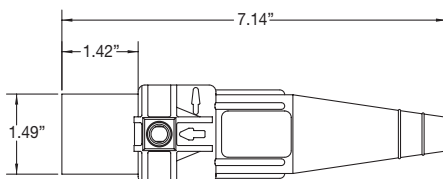

Male connector

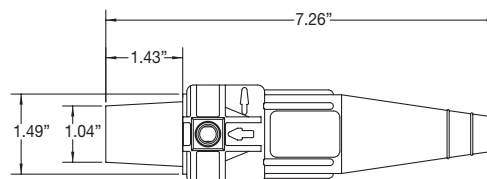

Female connector

## plugs

Cable size 1/0 - 2/0

600 VAC/VDC, up to 300A continuous

### J series E-Z1016, elastomeric, non-vulcanized, crimp connection

#### Features:

- E-Z assembly and disassembly – no tools needed
- Double cam principle provides a positive, vibration-proof connection
- Self-compensating for wear
- No moving contact surfaces, eliminating arcing or burning
- Superior electromechanical connections
- Locked contacts will withstand a pulling force of 1,000 lbs.
- 1/3 of a turn assures a high pressure contact approach 600 lbs. per sq. in., providing minimum resistance
- Contacts carefully machined from a high conductivity brass to provide a smooth sliding fit and easy locking action
- Watertight elastomeric insulators molded from colorfast material, color-coded for easy phase identification
- Recessed contacts protected by insulating jacket that extends beyond contact ends for safety
- Integrated strain relief system features a retaining wire that prevents cable jacket pull-away and bare conductor exposure
- Plugs feature a high strength, molded-in-place locking ring to capture and secure the insulator to the contact

#### Certifications and compliances:

- Listed to UL1691
- Listed to CSA C22.2 No. 1691-12
- CSA certified to C22.2 No. 182.3 LR13963

#### Environmental rating:

- NEMA 3R

#### Material characteristics:

- Insulator – TPE
- Temperature rating – operating ambient: -40°C to 105°C

#### Ordering information:

### Crimp non-vulcanized plugs



E-Z1016-8021



E-Z1016-8073

#### Male

Cable size	Color	Cat. # Complete	Cat. # Contact only	Cat. # Insulator only
1/0 - 2/0	Black	E-Z1016-8018	A200038-11	E-Z200074-60
	Red	E-Z1016-8020		E-Z200074-62
	Green	E-Z1016-8022		E-Z200074-64
	White	E-Z1016-8023		E-Z200074-65
	Blue	E-Z1016-7704		E-Z200074-66
	Brown	E-Z1016-7705		E-Z200074-67
	Orange	E-Z1016-8021		E-Z200074-63
	Yellow	E-Z1016-8019		E-Z200074-61

#### Female

Cable size	Color	Cat. # Complete	Cat. # Contact only	Cat. # Insulator only
1/0 - 2/0	Black	E-Z1016-8068	A200035-17	E-Z200075-60
	Red	E-Z1016-8070		E-Z200075-62
	Green	E-Z1016-8072		E-Z200075-64
	White	E-Z1016-8073		E-Z200075-65
	Blue	E-Z1016-7720		E-Z200075-66
	Brown	E-Z1016-7721		E-Z200075-67
	Orange	E-Z1016-8071		E-Z200075-63
	Yellow	E-Z1016-8069		E-Z200075-61

To order single packaged products, add suffix 'K' to the complete catalog number.

#### Dimensions:

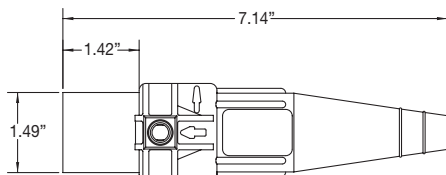

Male connector

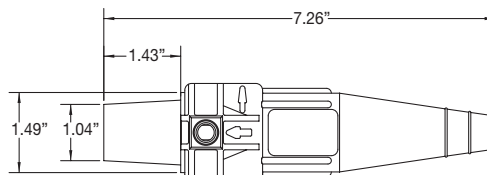

Female connector

## plugs

Cable size 3/0 - 4/0

600 VAC/VDC, up to 400A continuous

### J series E-Z1016, elastomeric, non-vulcanized, crimp connection

#### Features:

- E-Z assembly and disassembly – no tools needed
- Double cam principle provides a positive, vibration-proof connection
- Self-compensating for wear
- No moving contact surfaces, eliminating arcing or burning
- Superior electromechanical connections
- Locked contacts will withstand a pulling force of 1,000 lbs.
- 1/3 of a turn assures a high pressure contact approaching 600 lbs. per sq. in., providing minimum resistance
- Contacts carefully machined from a high conductivity brass to provide a smooth sliding fit and easy locking action
- Watertight elastomeric insulators molded from colorfast material, color-coded for easy phase identification
- Recessed contacts protected by insulating jacket that extends beyond contact ends for safety
- Integrated strain relief system features a retaining wire that prevents cable jacket pull-away and bare conductor exposure
- Plugs feature a high strength, molded-in-place locking ring to capture and secure the insulator to the contact

#### Certifications and compliances:

- Listed to UL1691
- Listed to CSA C22.2 No. 1691-12
- CSA certified to C22.2 No. 182.3 LR13963

#### Environmental rating:

- NEMA 3R

#### Material characteristics:

- Insulator – TPE
- Temperature rating – operating ambient: -40°C to 105°C

#### Ordering information:

#### Crimp non-vulcanized plugs



E-Z1016-8031



E-Z1016-7724

Male				
Cable size	Color	Cat. # Complete	Cat. # Contact only	Cat. # Insulator only
3/0 - 4/0	Black	E-Z1016-8030	A200038-6	E-Z200074-60
	Red	E-Z1016-8032		E-Z200074-62
	Green	E-Z1016-8034		E-Z200074-64
	White	E-Z1016-8035		E-Z200074-65
	Blue	E-Z1016-7708		E-Z200074-66
	Brown	E-Z1016-7709		E-Z200074-67
	Orange	E-Z1016-8033		E-Z200074-63
	Yellow	E-Z1016-8031		E-Z200074-61

Female				
Cable size	Color	Cat. # Complete	Cat. # Contact only	Cat. # Insulator only
3/0 - 4/0	Black	E-Z1016-8080	A200035-14	E-Z200075-60
	Red	E-Z1016-8082		E-Z200075-62
	Green	E-Z1016-8084		E-Z200075-64
	White	E-Z1016-8085		E-Z200075-65
	Blue	E-Z1016-7724		E-Z200075-66
	Brown	E-Z1016-7725		E-Z200075-67
	Orange	E-Z1016-8083		E-Z200075-63
	Yellow	E-Z1016-8081		E-Z200075-61

To order single packaged products, add suffix 'K' to the complete catalog number.

#### Dimensions:

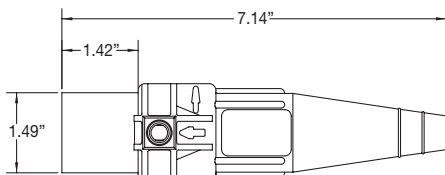

Male connector

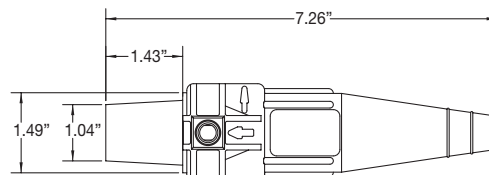

Female connector

## plugs

Cable size #2 AWG - 2/0

600 VAC/VDC, up to 300A continuous

### J series E1016, elastomeric, non-vulcanized, double set screw connection

#### Features:

- Double cam principle provides a positive, vibration-proof connection
- Self-compensating for wear
- No moving contact surfaces, eliminating arcing or burning
- Superior electromechanical connections
- Locked contacts will withstand a pulling force of 1,000 lbs.
- 1/3 of a turn assures a high pressure contact approaching 600 lbs. per sq. in., providing minimum resistance
- Contacts carefully machined from a high conductivity brass to provide a smooth sliding fit and easy locking action
- Watertight elastomeric insulators molded from colorfast material, color-coded for easy phase identification
- Recessed contacts protected by insulating jacket that extends beyond contact ends for safety
- Integrated strain relief system features a retaining wire that prevents cable jacket pull-away and bare conductor exposure
- Plugs feature a high strength, molded-in-place locking ring to capture and secure the insulator to the contact
- Accepts a wide range of cable sizes

#### Certifications and compliances:

- Listed to UL1691
- Listed to CSA C22.2 No. 1691-12
- CSA certified to C22.2 No. 182.3 LR13963

#### Environmental rating:

- NEMA 3R

#### Material characteristics:

- Insulator – TPE
- Temperature rating – operating ambient: -40°C to 105°C

#### Ordering information:

### Double set screw non-vulcanized plugs



E1016-8354

#### Male

Cable size	Color	Cat. # Complete	Cat. # Contact only	Cat. # Insulator only
#2 - 2/0	Black	E1016-8350	A200630-1	A200074-19
	Red	E1016-8352		A200074-21
	Green	E1016-8354		A200074-23
	White	E1016-8355		A200074-24
	Blue	E1016-8356		A200074-38
	Brown	E1016-8357		A200074-47
	Orange	E1016-8353		A200074-22
	Yellow	E1016-8351		A200074-20



E1016-8380

#### Female

Cable size	Color	Cat. # Complete	Cat. # Contact only	Cat. # Insulator only
#2 - 2/0	Black	E1016-8375	A200640-3	A200075-19
	Red	E1016-8377		A200075-21
	Green	E1016-8379		A200075-23
	White	E1016-8380		A200075-24
	Blue	E1016-8381		A200075-44
	Brown	E1016-8382		A200075-52
	Orange	E1016-8378		A200075-22
	Yellow	E1016-8376		A200075-20

To order single packaged products, add suffix 'K' to the complete catalog number.

#### Dimensions:

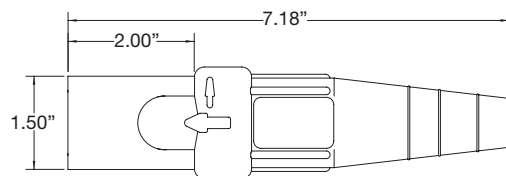

Male non-vulcanized plug

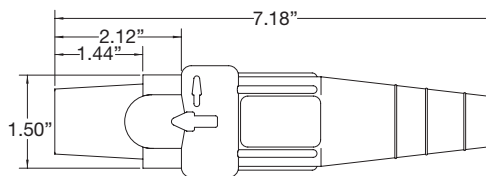

Female non-vulcanized plug

# Cam-Lok J series E1016 plugs

NEMA 3R

10P

Cable size 2/0 - 4/0

600 VAC/VDC, up to 400A continuous

## J series E1016, elastomeric, non-vulcanized, double set screw connection

### Features:

- Double cam principle provides a positive, vibration-proof connection
- Self-compensating for wear
- No moving contact surfaces, eliminating arcing or burning
- Superior electromechanical connections
- 400A continuous duty rating when used with 90°C 4/0 cable
- Locked contacts will withstand a pulling force of 1,000 lbs.
- 1/3 of a turn assures a high pressure contact approaching 600 lbs. per sq. in., providing minimum resistance
- Contacts carefully machined from a high conductivity brass to provide a smooth sliding fit and easy locking action
- Watertight elastomeric insulators molded from colorfast material, color-coded for easy phase identification
- Recessed contacts protected by insulating jacket that extends beyond contact ends for safety
- Integrated strain relief system features a retaining wire that prevents cable jacket pull-away and bare conductor exposure
- Plugs feature a high strength, molded-in-place locking ring to capture and secure the insulator to the contact
- Accepts a wide range of cable sizes

### Certifications and compliances:

- Listed to UL1691
- Listed to CSA C22.2 No. 1691-12
- CSA certified to C22.2 No. 182.3 LR13963

### Environmental rating:

- NEMA 3R

### Material characteristics:

- Insulator – TPE
- Temperature rating – operating ambient: -40°C to 105°C

### Ordering information:

## Double set screw non-vulcanized plugs



E1016-8367



E1016-8393

#### Male

Cable size	Color	Cat. # Complete	Cat. # Contact only	Cat. # Insulator only
2/0 - 4/0	Black	E1016-8362	A200639-1	A200074-60
	Red	E1016-8364		A200074-62
	Green	E1016-8366		A200074-64
	White	E1016-8367		A200074-65
	Blue	E1016-8368		A200074-66
	Brown	E1016-8369		A200074-67
	Orange	E1016-8365		A200074-63
	Yellow	E1016-8363		A200074-61

#### Female

Cable size	Color	Cat. # Complete	Cat. # Contact only	Cat. # Insulator only
2/0 - 4/0	Black	E1016-8387	A200641-1	A200075-60
	Red	E1016-8389		A200075-62
	Green	E1016-8391		A200075-64
	White	E1016-8392		A200075-65
	Blue	E1016-8393		A200075-66
	Brown	E1016-8394		A200075-67
	Orange	E1016-8390		A200075-63
	Yellow	E1016-8388		A200075-61

To order single packaged products, add suffix 'K' to the complete catalog number.

### Dimensions:

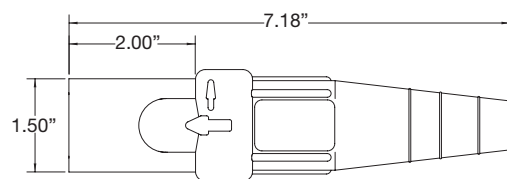

Male non-vulcanized plug

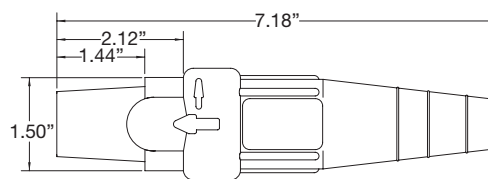

Female non-vulcanized plug



## plugs

Cable size #2 - #1 AWG

600 VAC/VDC, up to 190A continuous

### J series E1016, elastomeric, non-vulcanized, crimp connection

#### Features:

- Double cam principle provides a positive, vibration-proof connection
- Self-compensating for wear
- No moving contact surfaces, eliminating arcing or burning
- Superior electromechanical connections
- Locked contacts will withstand a pulling force of 1,000 lbs.
- 1/3 of a turn assures a high pressure contact approaching 600 lbs. per sq. in., providing minimum resistance
- Contacts carefully machined from a high conductivity brass to provide a smooth sliding fit and easy locking action
- Watertight elastomeric insulators molded from colorfast material, color-coded for easy phase identification
- Recessed contacts protected by insulating jacket that extends beyond contact ends for safety
- Integrated strain relief system features a retaining wire that prevents cable jacket pull-away and bare conductor exposure
- Plugs feature a high strength, molded-in-place locking ring to capture and secure the insulator to the contact

#### Certifications and compliances:

- Listed to UL1691
- Listed to CSA C22.2 No. 1691-12
- CSA certified to C22.2 No. 182.3 LR13963

#### Environmental rating:

- NEMA 3R

#### Material characteristics:

- Insulator – TPE
- Temperature rating – operating ambient: -40°C to 105°C

#### Ordering information:



E1016-8006



E1016-8058

#### Crimp non-vulcanized plugs

Male				
Cable size	Color	Cat. # Complete	Cat. # Contact only	Cat. # Insulator only
#2 - #1	Black	E1016-8006	A200036-18	A200074-19
	Red	E1016-8008		A200074-21
	Green	E1016-8010		A200074-23
	White	E1016-8011		A200074-24
	Blue	E1016-7700		A200074-38
	Brown	E1016-7701		A200074-47
	Orange	E1016-8009		A200074-22
	Yellow	E1016-8007		A200074-20

Female				
Cable size	Color	Cat. # Complete	Cat. # Contact only	Cat. # Insulator only
#2 - #1	Black	E1016-8056	A200037-23	A200075-19
	Red	E1016-8058		A200075-21
	Green	E1016-8060		A200075-23
	White	E1016-8061		A200075-24
	Blue	E1016-7716		A200075-44
	Brown	E1016-7717		A200075-52
	Orange	E1016-8059		A200075-22
	Yellow	E1016-8057		A200075-20

To order single packaged products, add suffix 'K' to the complete catalog number.

#### Dimensions:

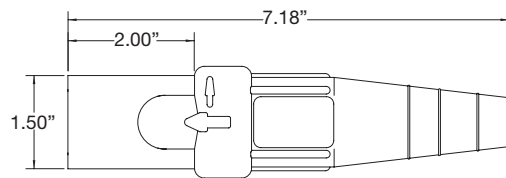

Male non-vulcanized plug

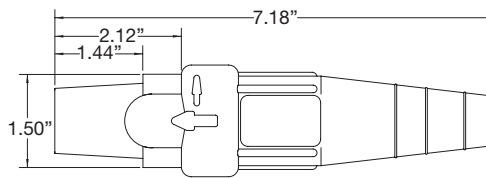

Female non-vulcanized plug

# Cam-Lok J series E1016 plugs

NEMA 3R

10P

Cable size 1/0 - 2/0

600 VAC/VDC, up to 235A continuous

## J series E1016, elastomeric, non-vulcanized, crimp connection

### Features:

- Double cam principle provides a positive, vibration-proof connection
- Self-compensating for wear
- No moving contact surfaces, eliminating arcing or burning
- Superior electromechanical connections
- Locked contacts will withstand a pulling force of 1,000 lbs.
- 1/3 of a turn assures a high pressure contact approaching 600 lbs. per sq. in., providing minimum resistance
- Contacts carefully machined from a high conductivity brass to provide a smooth sliding fit and easy locking action
- Watertight elastomeric insulators molded from colorfast material, color-coded for easy phase identification
- Recessed contacts protected by insulating jacket that extends beyond contact ends for safety
- Integrated strain relief system features a retaining wire that prevents cable jacket pull-away and bare conductor exposure
- Plugs feature a high strength, molded-in-place locking ring to capture and secure the insulator to the contact

### Certifications and compliances:

- Listed to UL1691
- Listed to CSA C22.2 No. 1691-12
- CSA certified to C22.2 No. 182.3 LR13963

### Environmental rating:

- NEMA 3R

### Material characteristics:

- Insulator – TPE
- Temperature rating – operating ambient: -40°C to 105°C

### Ordering information:

### Crimp non-vulcanized plugs



E1016-8020



E1016-8069

Male				
Cable size	Color	Cat. # Complete	Cat. # Contact only	Cat. # Insulator only
1/0 - 2/0	Black	E1016-8018	A200038-11B	A200074-13
	Red	E1016-8020		A200074-15
	Green	E1016-8022		A200074-17
	White	E1016-8023		A200074-18
	Blue	E1016-7704		A200074-37
	Brown	E1016-7705		A200074-46
	Orange	E1016-8021		A200074-16
	Yellow	E1016-8019		A200074-14

Female				
Cable size	Color	Cat. # Complete	Cat. # Contact only	Cat. # Insulator only
1/0 - 2/0	Black	E1016-8068	A200035-17B	A200075-13
	Red	E1016-8070		A200075-15
	Green	E1016-8072		A200075-17
	White	E1016-8073		A200075-18
	Blue	E1016-7720		A200075-37
	Brown	E1016-7721		A200075-51
	Orange	E1016-8071		A200075-16
	Yellow	E1016-8069		A200075-14

To order single packaged products, add suffix 'K' to the complete catalog number.

### Dimensions:

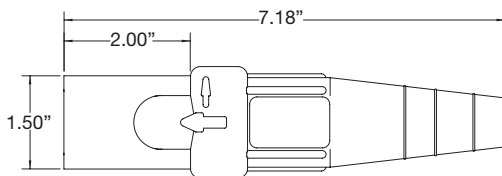

Male non-vulcanized plug

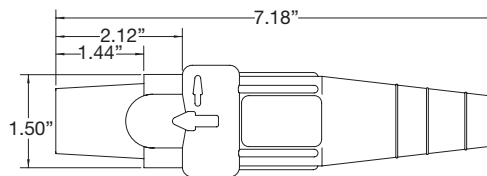

Female non-vulcanized plug

## plugs

Cable size 3/0 - 4/0

600 VAC/VDC, up to 315A continuous

### J series E1016, elastomeric, non-vulcanized, crimp connection

#### Features:

- Double cam principle provides a positive, vibration-proof connection
- Self-compensating for wear
- No moving contact surfaces, eliminating arcing or burning
- Superior electromechanical connections
- Locked contacts will withstand a pulling force of 1,000 lbs.
- 1/3 of a turn assures a high pressure contact approaching 600 lbs. per sq. in., providing minimum resistance
- Contacts carefully machined from a high conductivity brass to provide a smooth sliding fit and easy locking action
- Watertight elastomeric insulators molded from colorfast material, color-coded for easy phase identification
- Recessed contacts protected by insulating jacket that extends beyond contact ends for safety
- Integrated strain relief system features a retaining wire that prevents cable jacket pull-away and bare conductor exposure
- Plugs feature a high strength, molded-in-place locking ring to capture and secure the insulator to the contact

#### Certifications and compliances:

- Listed to UL1691
- Listed to CSA C22.2 No. 1691-12
- CSA certified to C22.2 No. 182.3 LR13963

#### Environmental rating:

- NEMA 3R

#### Material characteristics:

- Insulator – TPE
- Temperature rating – operating ambient: -40°C to 105°C

#### Ordering information:

#### Crimp non-vulcanized plugs

Male				
Cable size	Color	Cat. # Complete	Cat. # Contact only	Cat. # Insulator only
3/0 - 4/0	Black	E1016-8030	A200038-6B	A200074-13
	Red	E1016-8032		A200074-15
	Green	E1016-8034		A200074-17
	White	E1016-8035		A200074-18
	Blue	E1016-7708		A200074-37
	Brown	E1016-7709		A200074-46
	Orange	E1016-8033		A200074-16
	Yellow	E1016-8031		A200074-14

Female				
Cable size	Color	Cat. # Complete	Cat. # Contact only	Cat. # Insulator only
3/0 - 4/0	Black	E1016-8080	A200035-14B	A200075-13
	Red	E1016-8082		A200075-15
	Green	E1016-8084		A200075-17
	White	E1016-8085		A200075-18
	Blue	E1016-7724		A200075-37
	Brown	E1016-7725		A200075-51
	Orange	E1016-8083		A200075-16
	Yellow	E1016-8081		A200075-14

To order single packaged products, add suffix 'K' to the complete catalog number.

#### Dimensions:

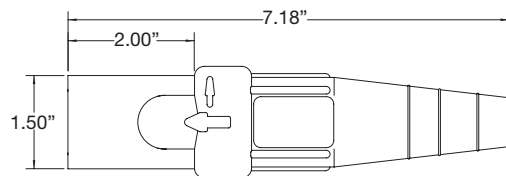

Male non-vulcanized plug

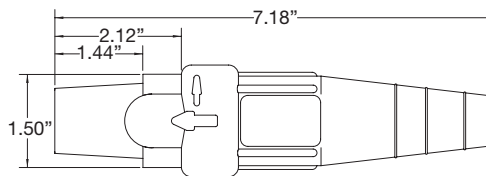

Female non-vulcanized plug

# Cam-Lok J series E1016 plugs

NEMA 4

10P

Cable size #2 - #1 AWG

600 VAC/VDC, up to 190A continuous

## J series E1016, rubber, vulcanized, crimp connection

### Features:

- Vulcanizing permanently affixes plug insulator to cable for maximum protection against water, all kinds of weather, corrosion and other contaminants (requires vulcanizing kit/presses)
- Vulcanizing also reduces cable breakage by distributing flexing over a wide area for an effective strain relief system
- Double cam principle provides a positive, vibration-proof connection
- Self-compensating for wear
- No moving contact surfaces, eliminating arcing or burning
- Superior electromechanical connections
- Locked contacts will withstand a pulling force of 1,000 lbs.
- 1/3 of a turn assures a high pressure contact approaching 600 lbs. per sq. in., providing minimum resistance
- Contacts carefully machined from a high conductivity brass to provide a smooth sliding fit and easy locking action
- Watertight neoprene insulators molded from colorfast material, color-coded for easy phase identification
- Recessed contacts protected by insulating jacket that extends beyond contact ends for safety

### Certifications and compliances:

- Listed to UL1691
- Listed to CSA C22.2 No. 1691-12
- CSA certified to C22.2 No. 182.3 LR13963

### Environmental rating:

- NEMA 4

### Material characteristics:

- Insulator – rubber
- Temperature rating – operating ambient: -40°C to 105°C

### Ordering information:

### Crimp vulcanized plugs



E1016-7



E1016-58

Male				
Cable size	Color	Cat. # Complete	Cat. # Contact only	Cat. # Insulator only
#2 - #1	Black	E1016-7	A200036-2	A200706-7
	Red	E1016-9		A200706-9
	Green	E1016-11		A200706-11
	White	E1016-12		A200706-12
	Blue	E1016-46		A200706-97
	Brown	E1016-118		A200706-101
	Orange	E1016-10		A200706-10
	Yellow	E1016-8		A200706-8

Female				
Cable size	Color	Cat. # Complete	Cat. # Contact only	Cat. # Insulator only
#2 - #1	Black	E1016-56	A200037-2	A200705-7
	Red	E1016-58		A200705-9
	Green	E1016-60		A200705-11
	White	E1016-61		A200705-12
	Blue	E1016-95		A200705-64
	Brown	E1016-119		A200705-101
	Orange	E1016-59		A200705-10
	Yellow	E1016-57		A200705-8

To order single packaged products, add suffix 'K' to the complete catalog number.

### Dimensions:

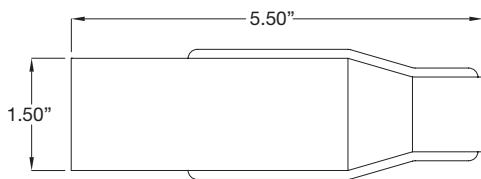

Male vulcanized plug

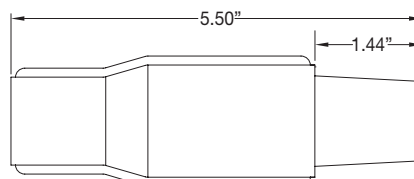

Female vulcanized plug

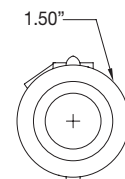

## plugs

Cable size 1/0 - 2/0

600 VAC/VDC, up to 235A continuous

### J series E1016, rubber, vulcanized, crimp connection

#### Features:

- Vulcanizing permanently affixes plug insulator to cable for maximum protection against water, all kinds of weather, corrosion and other contaminants (requires vulcanizing kit/presses)
- Vulcanizing also reduces cable breakage by distributing flexing over a wide area for an effective strain relief system
- Double cam principle provides a positive, vibration-proof connection
- Self-compensating for wear
- No moving contact surfaces, eliminating arcing or burning
- Superior electromechanical connections
- Locked contacts will withstand a pulling force of 1,000 lbs.
- 1/3 of a turn assures a high pressure contact approaching 600 lbs. per sq. in., providing minimum resistance
- Contacts carefully machined from a high conductivity brass to provide a smooth sliding fit and easy locking action
- Watertight neoprene insulators molded from colorfast material, color-coded for easy phase identification
- Recessed contacts protected by insulating jacket that extends beyond contact ends for safety

#### Certifications and compliances:

- Listed to UL1691
- Listed to CSA C22.2 No. 1691-12
- CSA certified to C22.2 No. 182.3 LR13963

#### Environmental rating:

- NEMA 4

#### Material characteristics:

- Insulator – rubber
- Temperature rating – operating ambient: -40°C to 105°C

#### Ordering information:

### Crimp vulcanized plugs

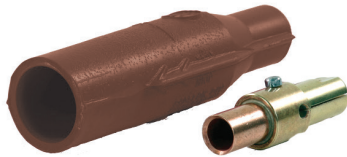

E1016-120



E1016-66

#### Male

Cable size	Color	Cat. # Complete	Cat. # Contact only	Cat. # Insulator only
1/0 - 2/0	Black	E1016-13	A200036-3	A200706-7
	Red	E1016-15		A200706-9
	Green	E1016-17		A200706-11
	White	E1016-18		A200706-12
	Blue	E1016-43		A200706-97
	Brown	E1016-120		A200706-101
	Orange	E1016-16		A200706-10
	Yellow	E1016-14		A200706-8

#### Female

Cable size	Color	Cat. # Complete	Cat. # Contact only	Cat. # Insulator only
1/0 - 2/0	Black	E1016-62	A200037-3	A200705-7
	Red	E1016-64		A200705-9
	Green	E1016-66		A200705-11
	White	E1016-67		A200705-12
	Blue	E1016-92		A200705-64
	Brown	E1016-121		A200705-101
	Orange	E1016-65		A200705-10
	Yellow	E1016-63		A200705-8

To order single packaged products, add suffix 'K' to the complete catalog number.

#### Dimensions:

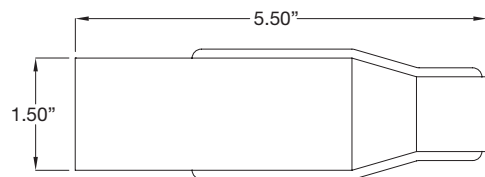

Male vulcanized plug

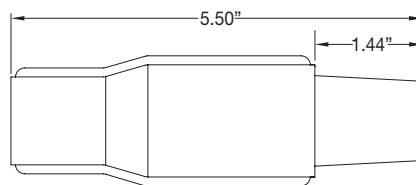

Female vulcanized plug

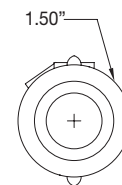

# Cam-Lok J series E1016 plugs

NEMA 4

10P

Cable size 3/0 - 4/0

600 VAC/VDC, up to 315A continuous

## J series E1016, rubber, vulcanized, crimp connection

### Features:

- Vulcanizing permanently affixes plug insulator to cable for maximum protection against water, all kinds of weather, corrosion and other contaminants (requires vulcanizing kit/presses)
- Vulcanizing also reduces cable breakage by distributing flexing over a wide area for an effective strain relief system
- Double cam principle provides a positive, vibration-proof connection
- Self-compensating for wear
- No moving contact surfaces, eliminating arcing or burning
- Superior electromechanical connections
- Locked contacts will withstand a pulling force of 1,000 lbs.
- 1/3 of a turn assures a high pressure contact approaching 600 lbs. per sq. in., providing minimum resistance
- Contacts carefully machined from a high conductivity brass to provide a smooth sliding fit and easy locking action
- Watertight neoprene insulators molded from colorfast material, color-coded for easy phase identification
- Recessed contacts protected by insulating jacket that extends beyond contact ends for safety

### Certifications and compliances:

- Listed to UL1691
- Listed to CSA C22.2 No. 1691-12
- CSA certified to C22.2 No. 182.3 LR13963

### Environmental rating:

- NEMA 4

### Material characteristics:

- Insulator – rubber
- Temperature rating – operating ambient: -40°C to 105°C

### Ordering information:

### Crimp vulcanized plugs



E1016-45



E1016-85

Male				
Cable size	Color	Cat. # Complete	Cat. # Contact only	Cat. # Insulator only
3/0 - 4/0	Black	E1016-31	A200038-2	A200706-13
	Red	E1016-33		A200706-15
	Green	E1016-35		A200706-17
	White	E1016-36		A200706-18
	Blue	E1016-45		A200706-64
	Brown	E1016-465		A200706-19
	Orange	E1016-34		A200706-16
	Yellow	E1016-32		A200706-14

Female				
Cable size	Color	Cat. # Complete	Cat. # Contact only	Cat. # Insulator only
3/0 - 4/0	Black	E1016-80	A200035-2	A200705-13
	Red	E1016-82		A200705-15
	Green	E1016-84		A200705-17
	White	E1016-85		A200705-18
	Blue	E1016-94		A200705-65
	Brown	E1016-98		A200705-19
	Orange	E1016-83		A200705-16
	Yellow	E1016-81		A200705-14

To order single packaged products, add suffix 'K' to the complete catalog number.

### Dimensions:

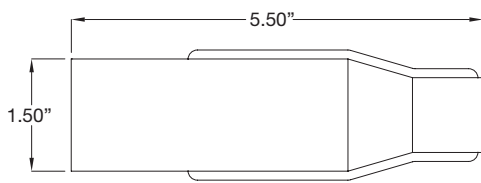

Male vulcanized plug

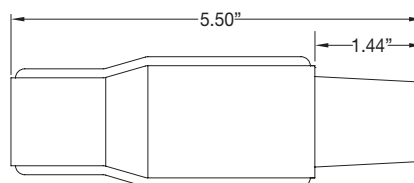

Female vulcanized plug

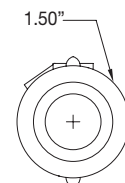



# Cam-Lok J series E1016 receptacles

NEMA 3R

10P

Cable size #6 AWG - 250 MCM  
600 VAC/VDC, up to 400A continuous

## J series E1016, elastomeric, threaded stud

### Features:

- Double cam principle provides a positive, vibration-proof connection
- Self-compensating for wear
- No moving contact surfaces, eliminating arcing or burning
- Superior electromechanical connections
- Locked contacts will withstand a pulling force of 1,000 lbs.
- 1/3 of a turn assures a high pressure contact approaching 600 lbs. per sq. in., providing minimum resistance
- Contacts carefully machined from a high conductivity brass to provide a smooth sliding fit and easy locking action
- Watertight elastomeric body molded from colorfast material, color-coded for easy phase identification
- Recessed contacts protected by insulating jacket that extends beyond contact ends for safety
- Receptacles are safety insulated for direct mounting to steel panels

### Certifications and compliances:

- Listed to UL1691
- Listed to CSA C22.2 No. 1691-12
- CSA certified to C22.2 No. 182.3 LR13963

### Environmental rating:

- NEMA 3R

### Material characteristics:

- Body – TPE
- Temperature rating – operating ambient: -40°C to 105°C

### Ordering information:

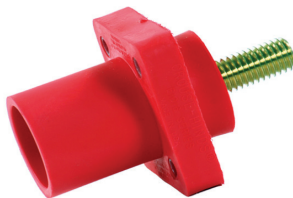

E1016-1602S



E1016-1600

### Insulated receptacles – 1 1/8" threaded stud

Color	Cat. # Male	Cat. # Female
Black	E1016-1600S	E1016-1631S
Red	E1016-1602S	E1016-1633S
Green	E1016-1604S	E1016-1635S
White	E1016-1605S	E1016-1636S
Blue	E1016-1612S	E1016-1643S
Brown	E1016-1619S	E1016-1687S
Orange	E1016-1603S	E1016-1634S
Yellow	E1016-1601S	E1016-1632S

Stud size: 1/2" - 13; maximum torque: 40 ft.-lbs.

### Insulated receptacles – 3/4" threaded stud

Color	Cat. # Male	Cat. # Female
Black	E1016-1600	E1016-1631
Red	E1016-1602	E1016-1633
Green	E1016-1604	E1016-1635
White	E1016-1605	E1016-1636
Blue	E1016-1612	E1016-1643
Brown	E1016-1619	E1016-1687
Orange	E1016-1603	E1016-1634
Yellow	E1016-1601	E1016-1632

Stud size: 1/2" - 13; maximum torque: 40 ft.-lbs.

To order single packaged products, add suffix 'K' to the complete catalog number.

To order tapped through holes, add suffix 'T' to the complete catalog number.

### Dimensions:

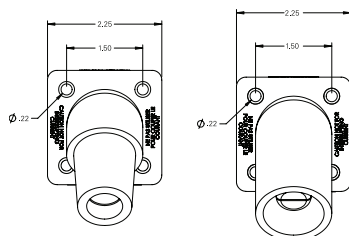

10P

# Cam-Lok J series E1016 receptacles

NEMA 3R

10P

Cable size #2 AWG - 4/0

600 VAC/VDC, up to 400A continuous

## J series E1016, elastomeric, bus bar

### Features:

- Double cam principle provides a positive, vibration-proof connection
- Self-compensating for wear
- No moving contact surfaces, eliminating arcing or burning
- Superior electromechanical connections
- Locked contacts will withstand a pulling force of 1,000 lbs.
- 1/3 of a turn assures a high pressure contact approaching 600 lbs. per sq. in., providing minimum resistance
- Contacts carefully machined from a high conductivity brass to provide a smooth sliding fit and easy locking action
- Watertight elastomeric body molded from colorfast material, color-coded for easy phase identification
- Recessed contacts protected by insulating jacket that extends beyond contact ends for safety
- Receptacles are safety insulated for direct mounting to steel panels

### Certifications and compliances:

- Listed to UL1691
- Listed to CSA C22.2 No. 1691-12
- CSA certified to C22.2 No. 182.3 LR13963

### Environmental rating:

- NEMA 3R

### Material characteristics:

- Body – TPE
- Temperature rating – operating ambient: -40°C to 105°C

### Ordering information:



E1016-1700B

### Insulated receptacles – single hole bus bar

Color	Cat. # Male	Cat. # Female
Black	E1016-1700B	E1016-1725B
Red	E1016-1702B	E1016-1727B
Green	E1016-1704B	E1016-1729B
White	E1016-1705B	E1016-1730B
Blue	E1016-1706B	E1016-1731B
Brown	E1016-1707B	E1016-1732B
Orange	E1016-1703B	E1016-1728B
Yellow	E1016-1701B	E1016-1726B

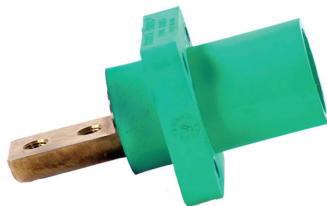

E1016-1704BB

### Insulated receptacles – double hole bus bar

Color	Cat. # Male	Cat. # Female
Black	E1016-1700BB	E1016-1725BB
Red	E1016-1702BB	E1016-1727BB
Green	E1016-1704BB	E1016-1729BB
White	E1016-1705BB	E1016-1730BB
Blue	E1016-1706BB	E1016-1731BB
Brown	E1016-1707BB	E1016-1732BB
Orange	E1016-1703BB	E1016-1728BB
Yellow	E1016-1701BB	E1016-1726BB

To order single packaged products, add suffix 'K' to the complete catalog number.

### Dimensions:

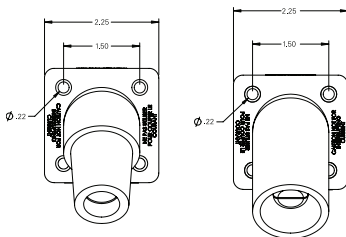

# Cam-Lok J series E1016 receptacles

NEMA 3R

10P

Cable size 1/0 - 4/0

600 VAC/VDC, up to 400A continuous; 480 VAC/VDC, up to 315A continuous

## J series E1016, elastomeric, double set screw/interlock switch

### Features:

- Double cam principle provides a positive, vibration-proof connection
- Self-compensating for wear
- No moving contact surfaces, eliminating arcing or burning
- Superior electromechanical connections
- Locked contacts will withstand a pulling force of 1,000 lbs.
- 1/3 of a turn assures a high pressure contact approaching 600 lbs. per sq. in., providing minimum resistance
- Contacts carefully machined from a high conductivity brass to provide a smooth sliding fit and easy locking action
- Watertight elastomeric body molded from colorfast material, color-coded for easy phase identification
- Recessed contacts protected by insulating jacket that extends beyond contact ends for safety
- Receptacles are safety insulated for direct mounting to steel panels

### Certifications and compliances:

- Listed to UL1691
- Listed to CSA C22.2 No. 1691-12
- CSA certified to C22.2 No. 182.3 LR13963

### Environmental rating:

- NEMA 3R

### Material characteristics:

- Body – TPE
- Temperature rating – operating ambient: -40°C to 105°C

### Ordering information:

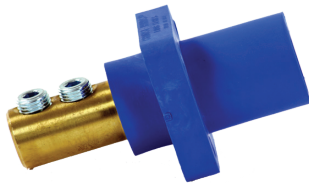

E1016-1706

### Insulated receptacles – double set screw

	Color	Cat. # Male	Cat. # Female
<b>Tightening torque</b>	Black	E1016-1700	E1016-1725
	Red	E1016-1702	E1016-1727
<b>Cable size</b>	Green	E1016-1704	E1016-1729
	White	E1016-1705	E1016-1730
1/0 - 2/0	Blue	E1016-1706	E1016-1731
3/0 - 4/0	Brown	E1016-1707	E1016-1732
600V, 400A	Orange	E1016-1703	E1016-1728
	Yellow	E1016-1701	E1016-1726

For E1016 double set screw receptacle dimensions, see next page.

To order tapped through holes, add suffix 'T' to the complete catalog number.

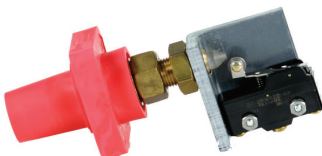

E1016-2269

### Insulated receptacles with interlock switch

	Color	Cat. # Female
480V, 315A	Black	E1016-2267
	Red	E1016-2269
	Green	E1016-2271
	White	E1016-2272
	Blue	E1016-2294
	Brown	E1016-2295
	Orange	E1016-2270
	Yellow	E1016-2268

To order single packaged products, add suffix 'K' to the complete catalog number.

### Dimensions:

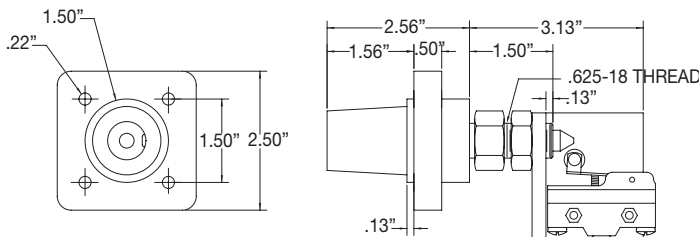

Female receptacle assembly with interlock switch

10P

# Cam-Lok J series E1016 receptacles

NEMA 3R

10P

Cable size #2 AWG - 4/0 (threaded stud); 1/0 - 4/0 (double set screw)  
600 VAC/VDC, up to 400A continuous

## J series E1016, elastomeric, non-vulcanized, 45° angled

### Features:

- Double cam principle provides a positive, vibration-proof connection
- Self-compensating for wear
- No moving contact surfaces, eliminating arcing or burning
- Superior electromechanical connections
- Locked contacts will withstand a pulling force of 1,000 lbs.
- 1/3 of a turn assures a high pressure contact approaching 600 lbs. per sq. in., providing minimum resistance
- Contacts carefully machined from a high conductivity brass to provide a smooth sliding fit and easy locking action
- Watertight elastomeric body molded from colorfast material, color-coded for easy phase identification
- Recessed contacts protected by insulating jacket that extends beyond contact ends for safety
- Receptacles are safety insulated for direct mounting to steel panels

### Certifications and compliances:

- Listed to UL1691
- Listed to CSA C22.2 No. 1691-12
- CSA certified to C22.2 No. 182.3 LR13963

### Environmental rating:

- NEMA 3R

### Material characteristics:

- Body – TPE
- Temperature rating – operating ambient: -40°C to 105°C

### Ordering information:



### Insulated receptacles – 1/8" threaded stud

Color	Cat. # Male	Cat. # Female
Black	E1016-1600S45	E1016-1631S45
Red	E1016-1602S45	E1016-1633S45
Green	E1016-1604S45	E1016-1635S45
White	E1016-1605S45	E1016-1636S45
Blue	E1016-1612S45	E1016-1643S45
Brown	E1016-1619S45	E1016-1687S45
Orange	E1016-1603S45	E1016-1634S45
Yellow	E1016-1601S45	E1016-1632S45

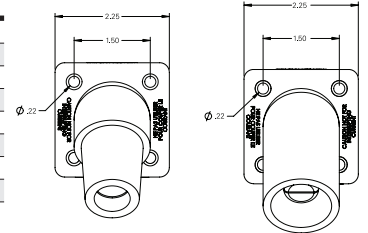

Custom length threaded studs are available – contact factory.



### Insulated receptacles – double set screw, 1/8" threaded stud

Color	Cat. # Male	Cat. # Female
Black	E1016-1700S45	E1016-1725S45
Red	E1016-1702S45	E1016-1727S45
Green	E1016-1704S45	E1016-1729S45
White	E1016-1705S45	E1016-1730S45
Blue	E1016-1706S45	E1016-1731S45
Brown	E1016-1707S45	E1016-1732S45
Orange	E1016-1703S45	E1016-1728S45
Yellow	E1016-1701S45	E1016-1726S45

### Dimensions:

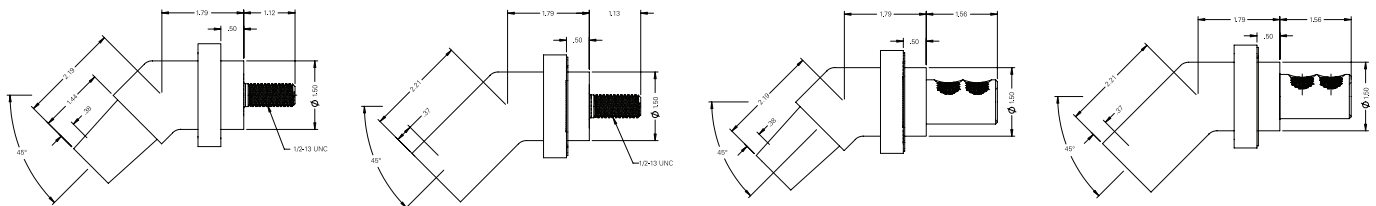

## J series E1015/E1016, NEMA 3R, receptacle covers

### Features:

- Molded from colorfast material, color-coded for easy phase identification
- Mounts directly to new or existing receptacles
- Provides NEMA 3R protection
- High impact-resistant thermoplastic covers and bodies
- Stainless steel hardware
- Complete color offering



Standard

Optional

### Certifications and compliances:

- Listed to UL1691

### Environmental rating:

- NEMA 3R

### Material characteristics:

- Body – thermoplastic
- Temperature rating – operating ambient: -40°C to 105°C

### Ordering information:

Color	Cat. # E1015 series	Cat. # E1016 series
Black	E1015SC-32	E1016SC-32
Red	E1015SC-36	E1016SC-36
Green	E1015SC-35	E1016SC-35
White	E1015SC-38	E1016SC-38
Blue	E1015SC-34	E1016SC-34
Yellow	E1015SC-37	E1016SC-37
Orange	E1015SC-39	E1016SC-39
Brown	E1015SC-31	E1016SC-31
Gray	E1015SC-33	E1016SC-33



### Dimensions:

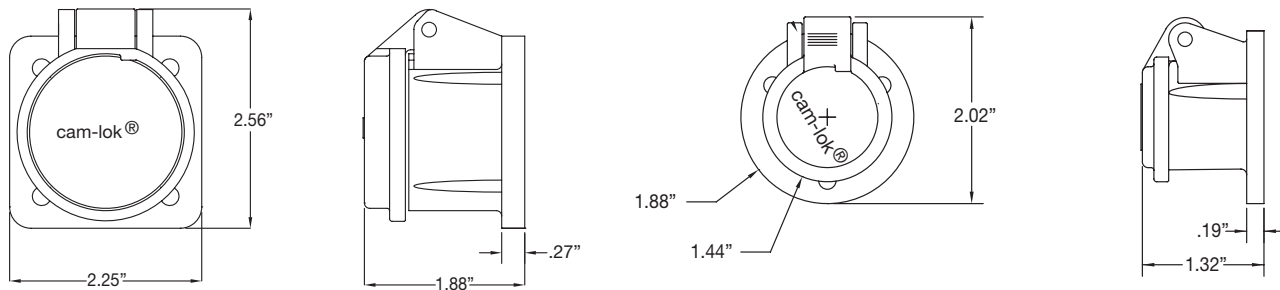

Snapback enclosure assembly

## J series E1016, NEMA 1, metal snapback covers

### Features:

- Mounts directly to new or existing receptacles
- Provides NEMA 1 protection
- Steel with epoxy powder coat (standard) or zinc plated (optional)
- Stainless steel hardware
- Complete color offering

### Certifications and compliances:

#### Environmental rating:

- NEMA 1

### Material characteristics:

- Body – steel
- Temperature rating – operating ambient: -40°C to 105°C

### Ordering information:

Color	Cat. #
Black	E1016MC-BK
Red	E1016MC-RD
Green	E1016MC-GR
White	E1016MC-WT
Blue	E1016MC-BL
Yellow	E1016MC-YL
Orange	E1016MC-OR
Brown	E1016MC-BR
Gray	E1016MC-GY
Zinc	E1016MC-ZN

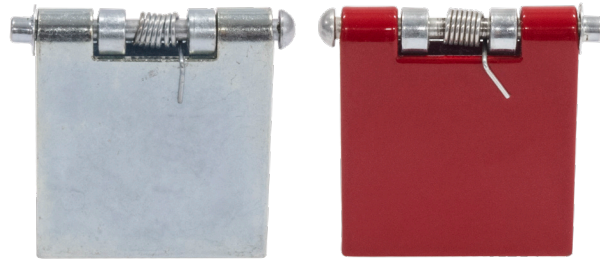

E1016MC-ZN

E1016MC-RD

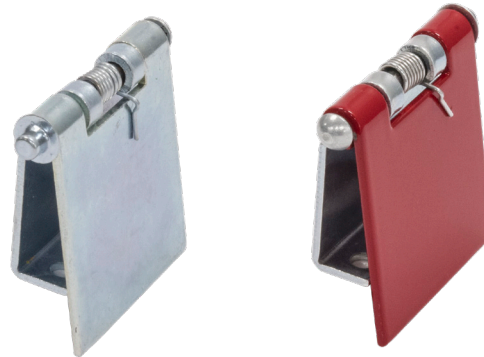

### Dimensions:

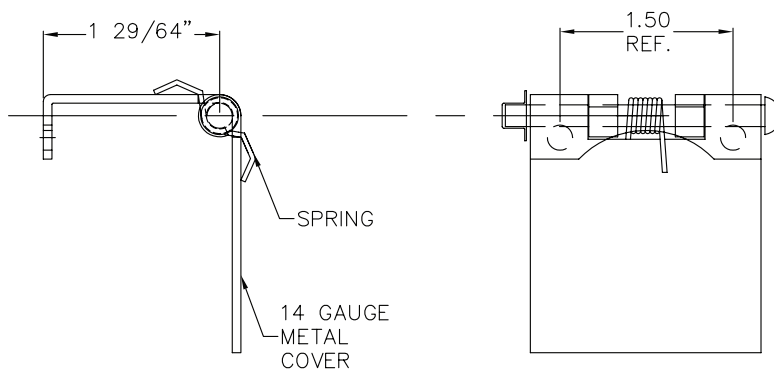



## Dimensions:

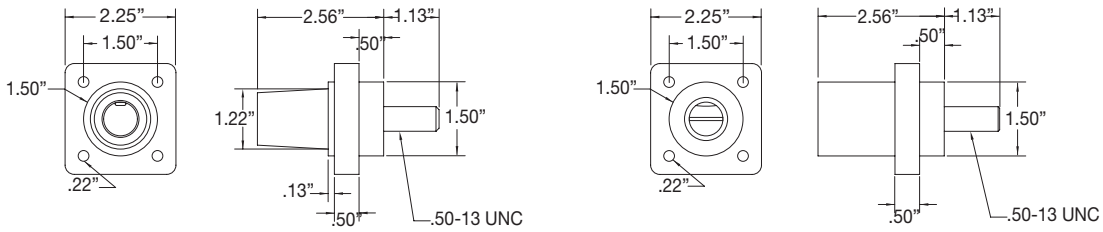

**Female and male E1016 threaded stud receptacles, 1/8" stud**

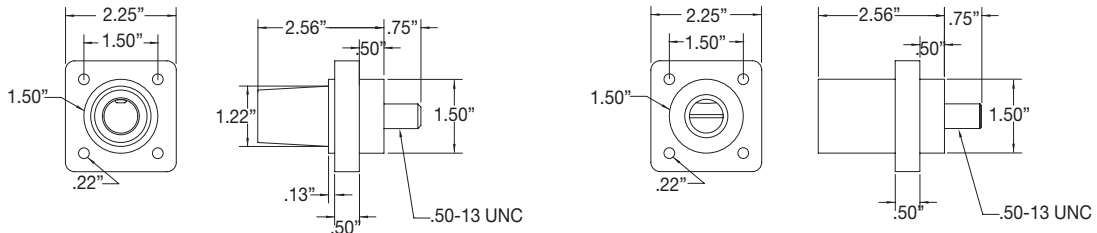

**Female and male E1016 threaded stud receptacles, 3/4" stud**

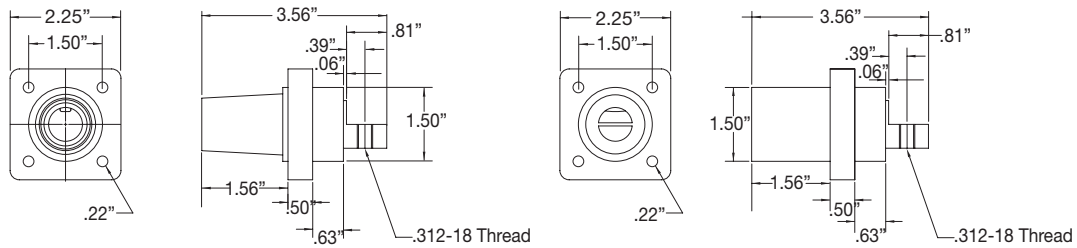

**Female and male E1016 single hole bus bar receptacles**

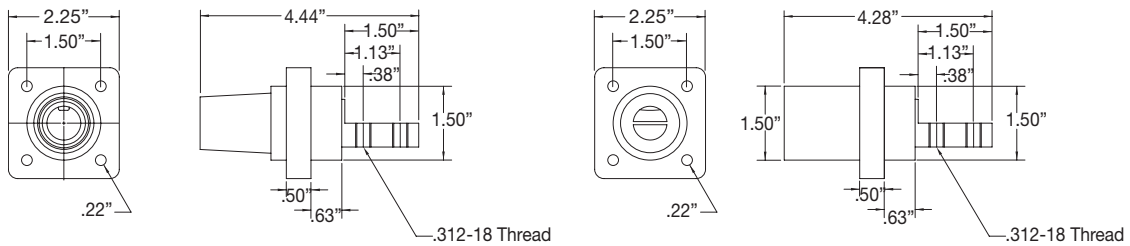

**Female and male E1016 double hole bus bar receptacles**

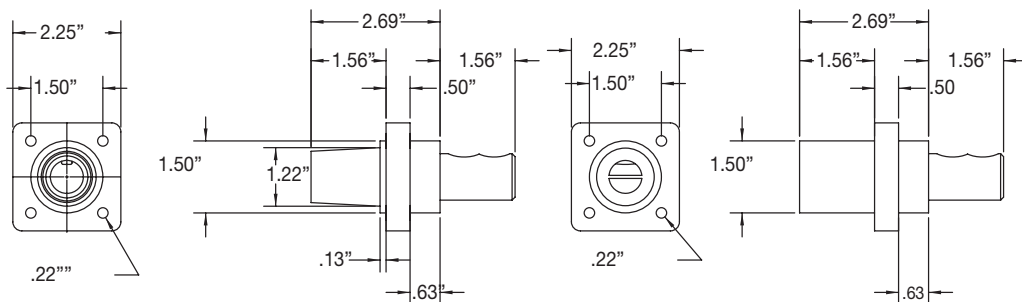

**Female and male E1016 double set screw receptacles**

# Cam-Lok J series E1016 accessories

NEMA 3R

10P

600 VAC/VDC, up to 400A continuous

## J series E1016, elastomeric

### Features:

- Double cam principle provides a positive, vibration-proof connection
- Self-compensating for wear
- No moving contact surfaces, eliminating arcing or burning
- Superior electromechanical connections
- Locked contacts will withstand a pulling force of 1,000 lbs.
- 1/3 of a turn assures a high pressure contact approaching 600 lbs. per sq. in., providing minimum resistance
- Contacts carefully machined from a high conductivity brass to provide a smooth sliding fit and easy locking action
- Watertight elastomeric body molded from colorfast material, color-coded for easy phase identification
- Recessed contacts protected by insulating jacket that extends beyond contact ends for safety

### Certifications and compliances:

- Listed to UL1691
- Listed to CSA C22.2 No. 1691-12
- CSA certified to C22.2 No. 182.3 LR13963

### Environmental rating:

- NEMA 3R

### Material characteristics:

- Body – TPE
- Temperature rating – operating ambient: -40°C to 105°C

### Ordering information:



E1016-2324



A100601-17

### Three-way lay down 'T' connectors

Color	Cat. # Paralleling 'T' M-M-F	Cat. # Tapping 'T' M-F-F	Cat. # Tapping 'T' M-F-M	Cat. # Tapping 'T' M-M-M	Cat. # Tapping 'T' F-F-F	Cat. # Tapping 'T' F-F-M
Black	E1016-2324	E1016-2312	E1016-2318	E1016-2300	E1016-2306	E1016-2330
Red	E1016-2326	E1016-2314	E1016-2320	E1016-2302	E1016-2308	E1016-2332
Green	E1016-2328	E1016-2316	E1016-2322	E1016-2304	E1016-2310	E1016-2334
White	E1016-2329	E1016-2317	E1016-2323	E1016-2305	E1016-2311	E1016-2335
Blue	E1016-2348	E1016-2350	E1016-2359	E1016-2351	E1016-2349	E1016-2360
Brown	E1016-2371	E1016-2395	E1016-2372	E1016-2373	E1016-2374	E1016-2375
Orange	E1016-2327	E1016-2315	E1016-2321	E1016-2303	E1016-2309	E1016-2333
Yellow	E1016-2325	E1016-2313	E1016-2319	E1016-2301	E1016-2307	E1016-2331

### Protective caps with lanyards (Not UL Listed)

Color	Cat. # Male	Cat. # Female
Black	A100601-17	A100602-17
Red	A100601-19	A100602-19
Green	A100601-21	A100602-21
White	A100601-22	A100602-22
Blue	A100601-24	A100602-24
Brown	A100601-23	A100602-23
Orange	A100601-20	A100602-20
Yellow	A100601-18	A100602-18
Aluminum	100444	SPACER

To order single packaged products, add suffix 'K' to the complete catalog number.

### Dimensions:

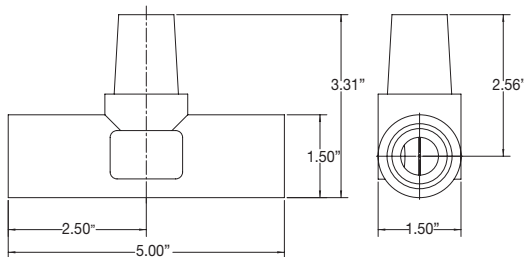

Three-way lay down 'T' connectors

# Cam-Lok J series E1016 accessories

600 VAC/VDC, up to 400A continuous

NEMA 3R

10P

## J series E1016, elastomeric

### Features:

- Double cam principle provides a positive, vibration-proof connection
- Self-compensating for wear
- No moving contact surfaces, eliminating arcing or burning
- Superior electromechanical connections
- Locked contacts will withstand a pulling force of 1,000 lbs.
- 1/3 of a turn assures a high pressure contact approaching 600 lbs. per sq. in., providing minimum resistance
- Contacts carefully machined from a high conductivity brass to provide a smooth sliding fit and easy locking action
- Watertight elastomeric body molded from colorfast material, color-coded for easy phase identification
- Recessed contacts protected by insulating jacket that extends beyond contact ends for safety

### Certifications and compliances:

- Listed to UL1691
- Listed to CSA C22.2 No. 1691-12
- CSA certified to C22.2 No. 182.3 LR13963

### Environmental rating:

- NEMA 3R

### Material characteristics:

- Body – TPE
- Temperature rating – operating ambient: -40°C to 105°C

### Ordering information:



E1016-9502

### Three-fer tapping tees

Color	Cat. # 90° M-F-F-F	Cat. # 45° M-F-F-F	Cat. # 45° F-M-M-M
Black	E1016-9500	E1016-9510	E1016-9580
Red	E1016-9502	E1016-9512	E1016-9600
Green	E1016-9504	E1016-9514	E1016-9620
White	E1016-9505	E1016-9515	E1016-9630
Blue	E1016-9506	E1016-9516	E1016-9640
Brown	E1016-9507	E1016-9517	E1016-9650
Orange	E1016-9503	E1016-9513	E1016-9610
Yellow	E1016-9501	E1016-9511	E1016-9590

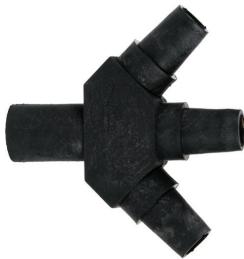

E1016-9510

### Adapters

Color	Cat. # Double female	Cat. # Double male
Black	E1016-2352	E1016-2382
Red	E1016-2354	E1016-2384
Green	E1016-2356	E1016-2386
White	E1016-2357	E1016-2387
Blue	E1016-2358	E1016-2388
Brown	E1016-2397	E1016-2389
Orange	E1016-2355	E1016-2385
Yellow	E1016-2353	E1016-2383

To order single packaged products, add suffix 'K' to the complete catalog number.

### Dimensions:

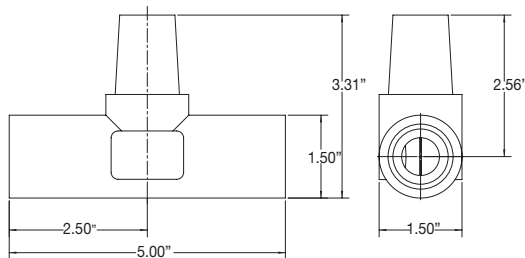

Three-way lay down 'T' connectors

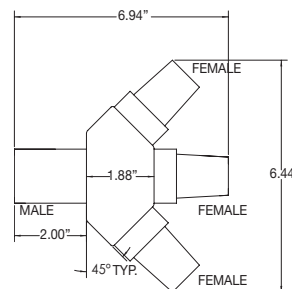

Three-fer tapping tee  
45° M-F-F-F

# Cam-Lok J series E1016 terminals

NEMA 3R

10P

Cable size #2 AWG - 4/0

600 VAC/VDC, up to 400A continuous

## J series E1016, elastomeric or rubber

### Features:

- Double cam principle provides a positive, vibration-proof connection
- Self-compensating for wear
- No moving contact surfaces, eliminating arcing or burning
- Superior electromechanical connections
- Locked contacts will withstand a pulling force of 1,000 lbs.
- 1/3 of a turn assures a high pressure contact approaching 600 lbs. per sq. in., providing minimum resistance
- Contacts carefully machined from a high conductivity brass to provide a smooth sliding fit and easy locking action
- Body molded from colorfast material, color-coded for easy phase identification; safety terminals are watertight elastomeric, and terminals are rubber

### Certifications and compliances:

- Listed to UL1691
- Listed to CSA C22.2 No. 1691-12
- CSA certified to C22.2 No. 182.3 LR13963

### Environmental rating:

- NEMA 3R

### Material characteristics:

- Body – TPE or rubber
- Temperature rating – operating ambient: -40°C to 105°C

### Ordering information:



E1016-627

### Female terminal connectors

Cable size	Color	Cat. # Angle style	Cat. # Offset style
#2 - 4/0	Black	E1016-575	E1016-625
	Red	E1016-577	E1016-627
	Green	E1016-579	E1016-629
	White	E1016-580	E1016-630
	Blue	E1016-587	E1016-638
	Brown	E1016-590	E1016-639
	Orange	E1016-578	E1016-628
	Yellow	E1016-576	E1016-626

Hole size: 1/2"



E1016-817

### Female safety terminals

Cable size	Color	Cat. # Round	Cat. # Rectangular
#2 - 4/0	Black	E1016-813	E1016-801
	Red	E1016-815	E1016-803
	Green	E1016-817	E1016-805
	White	E1016-818	E1016-806
	Blue	E1016-819	E1016-807
	Brown	E1016-820	E1016-808
	Orange	E1016-816	E1016-804
	Yellow	E1016-814	E1016-802

Tap hole: 1/8" - 13

To order single packaged products, add suffix 'K' to the complete catalog number.

### Dimensions:

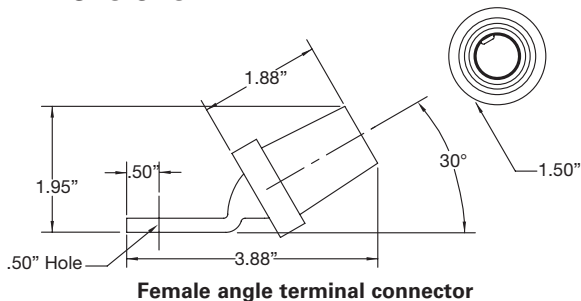

# Cam-Lok J series E1017 plugs

NEMA 3R

10P

Cable size 350-500 MCM

600 VAC/VDC, up to 545A continuous

## J series E1017, rubber, non-vulcanized, double set screw connection

### Features:

- Double cam principle provides a positive, vibration-proof connection
- Self-compensating for wear
- No moving contact surfaces, eliminating arcing or burning
- Superior electromechanical connections
- Locked contacts will withstand a pulling force of 1,000 lbs.
- 1/3 of a turn assures a high pressure contact approaching 600 lbs. per sq. in., providing minimum resistance
- Contacts carefully machined from a high conductivity brass to provide a smooth sliding fit and easy locking action
- Watertight rubber insulators molded from colorfast material, color-coded for easy phase identification
- Recessed contacts protected by insulating jacket that extends beyond contact ends for safety
- Integrated strain relief system features a retaining wire that prevents cable jacket pull-away and bare conductor exposure
- Plugs feature a high strength, molded-in-place locking ring to capture and secure the insulator to the contact
- Accepts a wide range of cable sizes

### Certifications and compliances:

- Listed to UL1691
- Listed to CSA C22.2 No. 1691-12
- CSA certified to C22.2 No. 182.3 LR13963

### Environmental rating:

- NEMA 3R

### Material characteristics:

- Insulator – rubber
- Temperature rating – operating ambient: -40°C to 105°C

### Ordering information:



E1017-356



E1017-377

### Double set screw non-vulcanized plugs

#### Male

Cable size	Color	Cat. # Complete	Cat. # Contact only	Cat. # Insulator only
350-500 MCM	Black	E1017-350	A200612-1	A200056-1
	Red	E1017-352		A200056-3
	Green	E1017-354		A200056-5
	White	E1017-355		A200056-6
	Blue	E1017-356		A200056-37
	Brown	E1017-357		A200056-42
	Orange	E1017-353		A200056-4
	Yellow	E1017-351		A200056-2

#### Female

Cable size	Color	Cat. # Complete	Cat. # Contact only	Cat. # Insulator only
350-500 MCM	Black	E1017-375	A200614-2	A200040-1
	Red	E1017-377		A200040-3
	Green	E1017-379		A200040-5
	White	E1017-380		A200040-6
	Blue	E1017-381		A200040-39
	Brown	E1017-382		A200040-37
	Orange	E1017-378		A200040-4
	Yellow	E1017-376		A200040-2

To order single packaged products, add suffix 'K' to the complete catalog number.

### Dimensions:

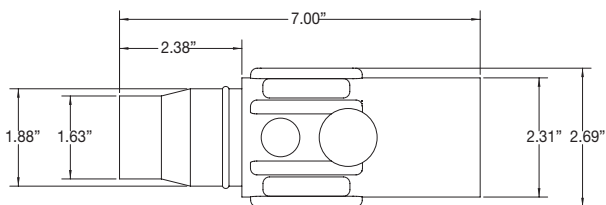

Male connector

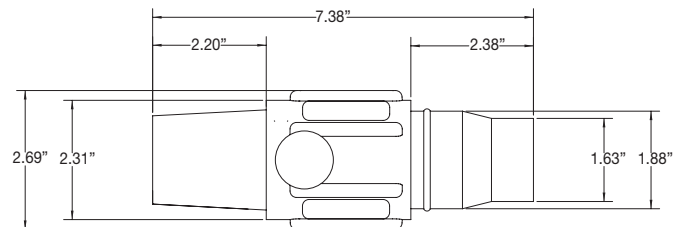

Female connector

10P

# Cam-Lok J series E1017 plugs

NEMA 4

10P

Cable size 250 MCM

600 VAC/VDC, up to 340A continuous

## J series E1017, rubber, vulcanized, crimp connection

### Features:

- Double cam principle provides a positive, vibration-proof connection
- Self-compensating for wear
- No moving contact surfaces, eliminating arcing or burning
- Superior electromechanical connections
- Locked contacts will withstand a pulling force of 1,000 lbs.
- 1/3 of a turn assures a high pressure contact approaching 600 lbs. per sq. in., providing minimum resistance
- Contacts carefully machined from a high conductivity brass to provide a smooth sliding fit and easy locking action
- Watertight rubber insulators molded from colorfast material, color-coded for easy phase identification
- Recessed contacts protected by insulating jacket that extends beyond contact ends for safety
- Integrated strain relief system features a retaining wire that prevents cable jacket pull-away and bare conductor exposure
- Plugs feature a high strength, molded-in-place locking ring to capture and secure the insulator to the contact

### Certifications and compliances:

- Listed to UL1691
- Listed to CSA C22.2 No. 1691-12
- CSA certified to C22.2 No. 182.3 LR13963

### Environmental rating:

- NEMA 4

### Material characteristics:

- Insulator – rubber
- Temperature rating – operating ambient: -40°C to 105°C

### Ordering information:



E1017-108



E1017-113

### Crimp vulcanized plugs (Not UL Listed)

Male				
Cable size	Color	Cat. # Complete	Cat. # Contact only	Cat. # Insulator only
250 MCM	Black	E1017-94	A200028-13	A200056-1
	Red	E1017-92		A200056-3
	Green	E1017-93		A200056-5
	White	E1017-95		A200056-6
	Blue	E1017-96		A200056-37
	Brown	E1017-108		A200056-42
	Orange	E1017-109		A200056-4
	Yellow	E1017-110		A200056-2

Female				
Cable size	Color	Cat. # Complete	Cat. # Contact only	Cat. # Insulator only
250 MCM	Black	E1017-90	A200027-72	A200040-1
	Red	E1017-88		A200040-3
	Green	E1017-89		A200040-5
	White	E1017-91		A200040-6
	Blue	E1017-98		A200040-39
	Brown	E1017-111		A200040-37
	Orange	E1017-112		A200040-4
	Yellow	E1017-113		A200040-2

To order single packaged products, add suffix 'K' to the complete catalog number.

### Dimensions:

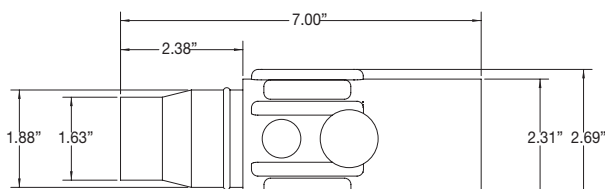

Male connector

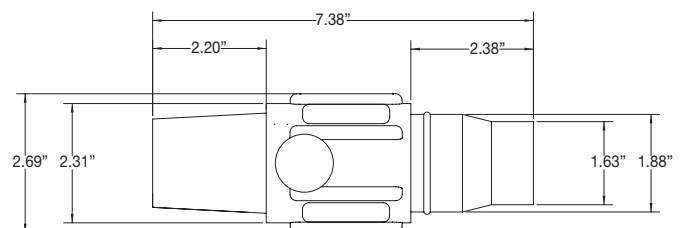

Female connector



## plugs

Cable size 350 MCM

600 VAC/VDC, up to 445A continuous

### J series E1017, rubber, vulcanized, crimp connection

#### Features:

- Double cam principle provides a positive, vibration-proof connection
- Self-compensating for wear
- No moving contact surfaces, eliminating arcing or burning
- Superior electromechanical connections
- Locked contacts will withstand a pulling force of 1,000 lbs.
- 1/3 of a turn assures a high pressure contact approaching 600 lbs. per sq. in., providing minimum resistance
- Contacts carefully machined from a high conductivity brass to provide a smooth sliding fit and easy locking action
- Watertight rubber insulators molded from colorfast material, color-coded for easy phase identification
- Recessed contacts protected by insulating jacket that extends beyond contact ends for safety
- Integrated strain relief system features a retaining wire that prevents cable jacket pull-away and bare conductor exposure
- Plugs feature a high strength, molded-in-place locking ring to capture and secure the insulator to the contact

#### Certifications and compliances:

- Listed to UL1691
- Listed to CSA C22.2 No. 1691-12
- CSA certified to C22.2 No. 182.3 LR13963

#### Environmental rating:

- NEMA 4

#### Material characteristics:

- Insulator – rubber
- Temperature rating – operating ambient: -40°C to 105°C

#### Ordering information:



E1017-26



E1017-79

#### Crimp vulcanized plugs

Male				
Cable size	Color	Cat. # Complete	Cat. # Contact only	Cat. # Insulator only
350 MCM	Black	E1017-1	A200028-1	A200056-1
	Red	E1017-3		A200056-3
	Green	E1017-5		A200056-5
	White	E1017-6		A200056-6
	Blue	E1017-26		A200056-37
	Brown	E1017-31		A200056-42
	Orange	E1017-4		A200056-4
	Yellow	E1017-2		A200056-2

Female				
Cable size	Color	Cat. # Complete	Cat. # Contact only	Cat. # Insulator only
350 MCM	Black	E1017-50	A200027-5	A200040-1
	Red	E1017-52		A200040-3
	Green	E1017-54		A200040-5
	White	E1017-55		A200040-6
	Blue	E1017-74		A200040-39
	Brown	E1017-79		A200040-37
	Orange	E1017-53		A200040-4
	Yellow	E1017-51		A200040-2

To order single packaged products, add suffix 'K' to the complete catalog number.

#### Dimensions:

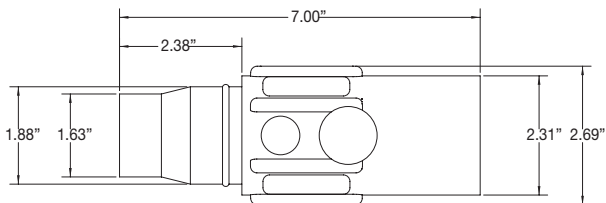

Male connector

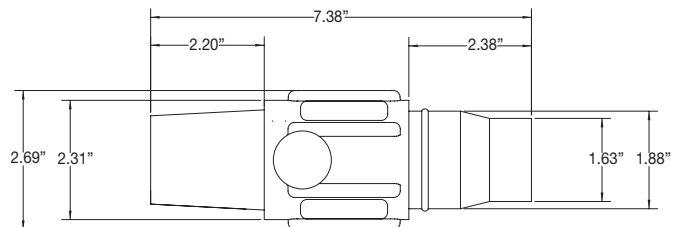

Female connector

# Cam-Lok J series E1017 plugs

NEMA 4

10P

Cable size 500 MCM

600 VAC/VDC, up to 545A continuous

## J series E1017, rubber, vulcanized, crimp connection

### Features:

- Double cam principle provides a positive, vibration-proof connection
- Self-compensating for wear
- No moving contact surfaces, eliminating arcing or burning
- Superior electromechanical connections
- Locked contacts will withstand a pulling force of 1,000 lbs.
- 1/3 of a turn assures a high pressure contact approaching 600 lbs. per sq. in., providing minimum resistance
- Contacts carefully machined from a high conductivity brass to provide a smooth sliding fit and easy locking action
- Watertight rubber insulators molded from colorfast material, color-coded for easy phase identification
- Recessed contacts protected by insulating jacket that extends beyond contact ends for safety
- Integrated strain relief system features a retaining wire that prevents cable jacket pull-away and bare conductor exposure
- Plugs feature a high strength, molded-in-place locking ring to capture and secure the insulator to the contact

### Certifications and compliances:

- Listed to UL1691
- Listed to CSA C22.2 No. 1691-12
- CSA certified to C22.2 No. 182.3 LR13963

### Environmental rating:

- NEMA 4

### Material characteristics:

- Insulator – rubber
- Temperature rating – operating ambient: -40°C to 105°C

### Ordering information:



E1017-9



E1017-61

### Crimp vulcanized plugs

Male				
Cable size	Color	Cat. # Complete	Cat. # Contact only	Cat. # Insulator only
500 MCM	Black	E1017-7	A200028-2	A200056-1
	Red	E1017-9		A200056-3
	Green	E1017-11		A200056-5
	White	E1017-12		A200056-6
	Blue	E1017-27		A200056-37
	Brown	E1017-32		A200056-42
	Orange	E1017-10		A200056-4
	Yellow	E1017-8		A200056-2

Female				
Cable size	Color	Cat. # Complete	Cat. # Contact only	Cat. # Insulator only
500 MCM	Black	E1017-56	A200027-6	A200040-1
	Red	E1017-58		A200040-3
	Green	E1017-60		A200040-5
	White	E1017-61		A200040-6
	Blue	E1017-75		A200040-39
	Brown	E1017-80		A200040-37
	Orange	E1017-59		A200040-4
	Yellow	E1017-57		A200040-2

To order single packaged products, add suffix 'K' to the complete catalog number.

### Dimensions:

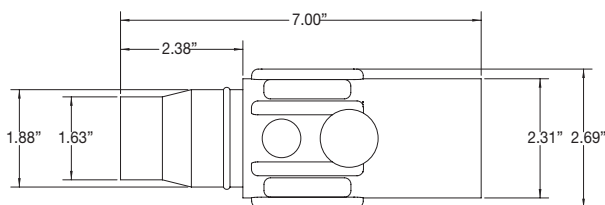

Male connector

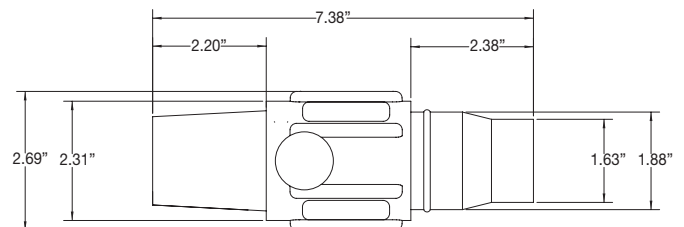

Female connector

# Cam-Lok J series E1017 plugs

NEMA 4

10P

Cable size 750 MCM

600 VAC/VDC, up to 690A continuous

## J series E1017, rubber, vulcanized, crimp connection

### Features:

- Double cam principle provides a positive, vibration-proof connection
- Self-compensating for wear
- No moving contact surfaces, eliminating arcing or burning
- Superior electromechanical connections
- Locked contacts will withstand a pulling force of 1,000 lbs.
- 1/3 of a turn assures a high pressure contact approaching 600 lbs. per sq. in., providing minimum resistance
- Contacts carefully machined from a high conductivity brass to provide a smooth sliding fit and easy locking action
- Watertight rubber insulators molded from colorfast material, color-coded for easy phase identification
- Recessed contacts protected by insulating jacket that extends beyond contact ends for safety
- Integrated strain relief system features a retaining wire that prevents cable jacket pull-away and bare conductor exposure
- Plugs feature a high strength, molded-in-place locking ring to capture and secure the insulator to the contact

### Certifications and compliances:

- Listed to UL1691
- Listed to CSA C22.2 No. 1691-12
- CSA certified to C22.2 No. 182.3 LR13963

### Environmental rating:

- NEMA 4

### Material characteristics:

- Insulator – rubber
- Temperature rating – operating ambient: -40°C to 105°C

### Ordering information:



E1017-18



E1017-76

### Crimp vulcanized plugs

#### Male

Cable size	Color	Cat. # Complete	Cat. # Contact only	Cat. # Insulator only
750 MCM	Black	E1017-13	A200028-3	A200056-7
	Red	E1017-15		A200056-9
	Green	E1017-17		A200056-11
	White	E1017-18		A200056-12
	Blue	E1017-28		A200056-41
	Brown	E1017-33		A200056-43
	Orange	E1017-16		A200056-10
	Yellow	E1017-14		A200056-8

#### Female

Cable size	Color	Cat. # Complete	Cat. # Contact only	Cat. # Insulator only
750 MCM	Black	E1017-62	A200027-7	A200040-7
	Red	E1017-64		A200040-9
	Green	E1017-66		A200040-11
	White	E1017-67		A200040-12
	Blue	E1017-76		A200040-40
	Brown	E1017-81		A200040-38
	Orange	E1017-65		A200040-10
	Yellow	E1017-63		A200040-8

To order single packaged products, add suffix 'K' to the complete catalog number.

### Dimensions:

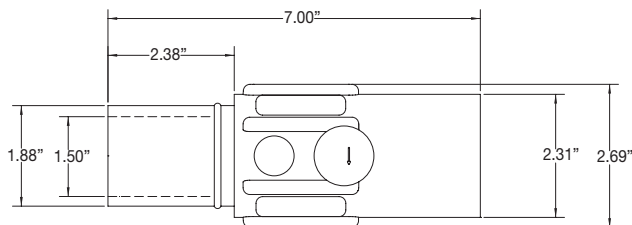

Male connector

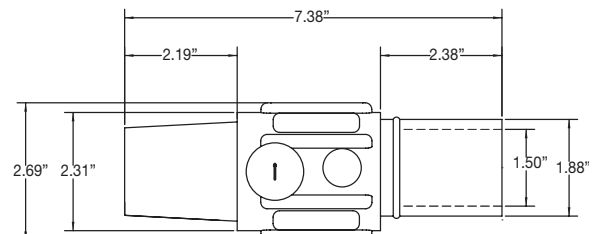

Female connector

10P

# Cam-Lok J series E1017 plugs

NEMA 4

10P

Cable size 800 MCM

600 VAC/VDC, up to 690A continuous

## J series E1017, rubber, vulcanized, crimp connection

### Features:

- Double cam principle provides a positive, vibration-proof connection
- Self-compensating for wear
- No moving contact surfaces, eliminating arcing or burning
- Superior electromechanical connections
- Locked contacts will withstand a pulling force of 1,000 lbs.
- 1/3 of a turn assures a high pressure contact approaching 600 lbs. per sq. in., providing minimum resistance
- Contacts carefully machined from a high conductivity brass to provide a smooth sliding fit and easy locking action
- Watertight rubber insulators molded from colorfast material, color-coded for easy phase identification
- Recessed contacts protected by insulating jacket that extends beyond contact ends for safety
- Integrated strain relief system features a retaining wire that prevents cable jacket pull-away and bare conductor exposure
- Plugs feature a high strength, molded-in-place locking ring to capture and secure the insulator to the contact

### Certifications and compliances:

- Listed to UL1691
- Listed to CSA C22.2 No. 1691-12
- CSA certified to C22.2 No. 182.3 LR13963

### Environmental rating:

- NEMA 4

### Material characteristics:

- Insulator – rubber
- Temperature rating – operating ambient: -40°C to 105°C

### Ordering information:



E1017-24



E1017-71

### Crimp vulcanized plugs (Not UL Listed)

Male				
Cable size	Color	Cat. # Complete	Cat. # Contact only	Cat. # Insulator only
800 MCM	Black	E1017-19	A200028-4	A200056-7
	Red	E1017-21		A200056-9
	Green	E1017-23		A200056-11
	White	E1017-24		A200056-12
	Blue	E1017-29		A200056-41
	Brown	E1017-34		A200056-43
	Orange	E1017-22		A200056-10
	Yellow	E1017-20		A200056-8

Female				
Cable size	Color	Cat. # Complete	Cat. # Contact only	Cat. # Insulator only
800 MCM	Black	E1017-68	A200027-8	A200040-7
	Red	E1017-70		A200040-9
	Green	E1017-72		A200040-11
	White	E1017-73		A200040-12
	Blue	E1017-77		A200040-40
	Brown	E1017-82		A200040-38
	Orange	E1017-71		A200040-10
	Yellow	E1017-69		A200040-8

To order single packaged products, add suffix 'K' to the complete catalog number.

### Dimensions:

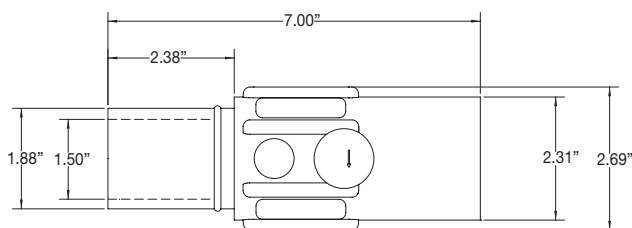

Male connector

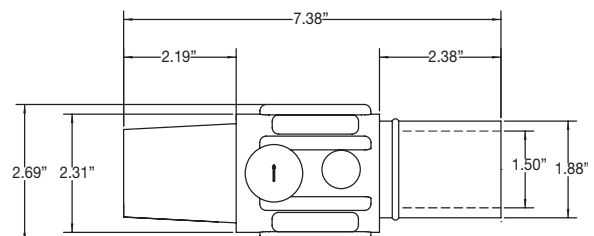

Female connector

# Cam-Lok J series E1017 receptacles

NEMA 3R

10P

Cable size 350-750 MCM

600 VAC/VDC, up to 690A continuous

## J series E1017, rubber, threaded stud

### Features:

- Double cam principle provides a positive, vibration-proof connection
- Self-compensating for wear
- No moving contact surfaces, eliminating arcing or burning of contacts
- Superior electromechanical connections
- Locked contacts will withstand a pulling force of 1,000 lbs.
- 1/3 of a turn assures a high pressure contact approaching 600 lbs. per sq. in., providing minimum resistance
- Contacts carefully machined from a high conductivity brass to provide a smooth sliding fit and easy locking action
- Watertight rubber body molded from colorfast material, color-coded for easy phase identification
- Recessed contacts protected by insulating jacket that extends beyond contact ends for safety
- Receptacles are safety insulated for direct mounting to steel panels
- Accepts a wide range of cable sizes

### Certifications and compliances:

- Listed to UL1691
- Listed to CSA C22.2 No. 1691-12
- CSA certified to C22.2 No. 182.3 LR13963

### Environmental rating:

- NEMA 3R

### Material characteristics:

- Insulator – rubber
- Temperature rating – operating ambient: -40°C to 105°C

### Ordering information:



E1017-1604



E1017-1637

### Threaded receptacles

#### Male

Cable size	Color	Cat. # 90° angle	Cat. # 30° angle
350-750 MCM	Black	E1017-1600	E1017-1601
	Red	E1017-1604	E1017-1605
	Green	E1017-1608	E1017-1609
	White	E1017-1610	E1017-1611
	Blue	E1017-1612	E1017-1613
	Brown	E1017-1614	E1017-1615
	Orange	E1017-1606	E1017-1607
	Yellow	E1017-1602	E1017-1603

#### Female

Cable size	Color	Cat. # 90° angle	Cat. # 30° angle
350-750 MCM	Black	E1017-1625	E1017-1626
	Red	E1017-1629	E1017-1630
	Green	E1017-1633	E1017-1634
	White	E1017-1635	E1017-1636
	Blue	E1017-1637	E1017-1638
	Brown	E1017-1641	E1017-1642
	Orange	E1017-1631	E1017-1632
	Yellow	E1017-1627	E1017-1628

Stud size: 1/2" - 13; maximum torque: 40 ft.-lbs.

To order single packaged products, add suffix 'K' to the complete catalog number.

### Dimensions:

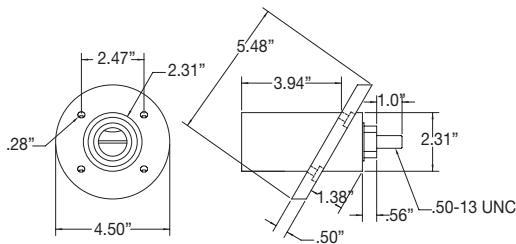

Male receptacle 30° angle

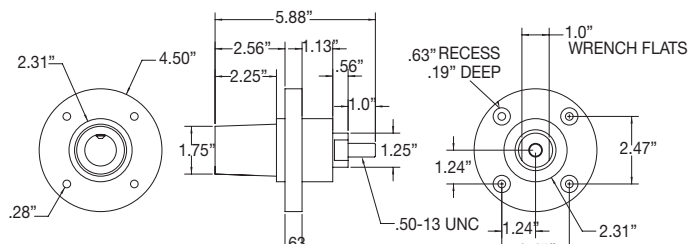

Female receptacle 90° angle

10P

# Cam-Lok J series E1017 receptacles and terminals

NEMA 3R

10P

Cable size 350-750 MCM  
600 VAC/VDC, up to 690A continuous

## J series E1017, rubber

### Features:

- Double cam principle provides a positive, vibration-proof connection
- Self-compensating for wear
- No moving contact surfaces, eliminating arcing or burning
- Superior electromechanical connections
- Locked contacts will withstand a pulling force of 1,000 lbs.
- 1/3 of a turn assures a high pressure contact approaching 600 lbs. per sq. in., providing minimum resistance
- Contacts carefully machined from a high conductivity brass to provide a smooth sliding fit and easy locking action
- Watertight rubber body molded from colorfast material, color-coded for easy phase identification
- Recessed contacts protected by insulating jacket that extends beyond contact ends for safety
- Accepts a wide range of cable sizes

### Certifications and compliances:

- Listed to UL1691
- Listed to CSA C22.2 No. 1691-12
- CSA certified to C22.2 No. 182.3 LR13963

### Environmental rating:

- NEMA 3R

### Material characteristics:

- Insulator – rubber
- Temperature rating – operating ambient: -40°C to 105°C

### Ordering information:



E1017-515

### Female receptacles with interlock switch (Not UL Listed), 480V max.

Cable size	Color	Cat. # 90° angle	Cat. # 30° angle
350-750 MCM	Black	E1017-509	E1017-501
	Red	E1017-511	E1017-503
	Green	E1017-513	E1017-505
	White	E1017-514	E1017-506
	Blue	E1017-515	E1017-507
	Brown	E1017-516	E1017-508
	Orange	E1017-512	E1017-504
	Yellow	E1017-510	E1017-502



E1017-575

### Female terminals

Color	Cat. # Angle style	Cat. # Offset style
Black	E1017-575	E1017-625
Red	E1017-577	E1017-627
Green	E1017-579	E1017-629
White	E1017-580	E1017-630
Blue	E1017-581	E1017-631
Brown	E1017-582	E1017-632
Orange	E1017-578	E1017-628
Yellow	E1017-576	E1017-626

To order single packaged products, add suffix 'K' to the complete catalog number.



## J series E1017, rubber

### Features:

- Resilient rubber body provides superior protection against elements
- Molded from colorfast material, color-coded for easy phase identification
- Attaches directly to new or existing plugs and receptacles
- Provides NEMA 3R protection
- Complete color offering
- Lanyard provided to prevent loss

### Material characteristics:

- Body – rubber
- Temperature rating – operating ambient: -40°C to 105°C

### Certifications and compliances:

- Listed to UL1691
- Listed to CSA C22.2 No. 1691-12
- CSA certified to C22.2 No. 182.3 LR13963

### Environmental rating:

- NEMA 3R

### Ordering information:



A100603-2

### Protective caps (Not UL Listed)

Color	Cat. # Male	Cat. # Female
Black	A100603-2	A100604-2
Red	A100603-6	A100604-6
Green	A100603-10	A100604-10
White	A100603-12	A100604-12
Blue	A100603-16	A100604-16
Brown	A100603-14	A100604-14
Orange	A100603-8	A100604-8
Yellow	A100603-4	A100604-4

To order single packaged products, add suffix 'K' to the complete catalog number.

### Dimensions:



A100604-2

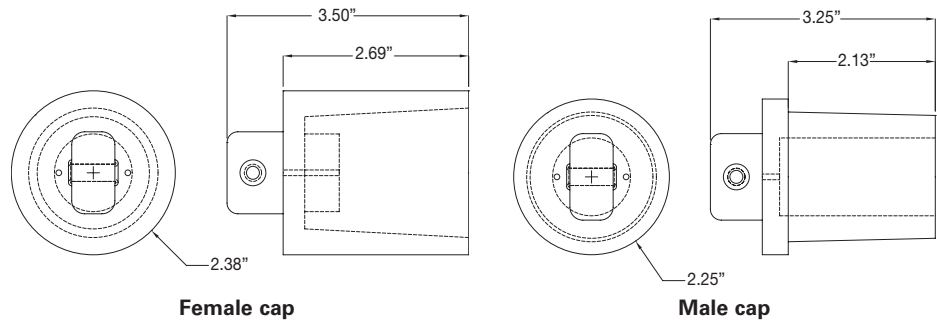

# Cam-Lok standard series

## E-Z1018 plugs

NEMA 3R

10P

Cable size #2 AWG - 2/0

600 VAC/VDC, up to 300A continuous

### Standard series E-Z1018, elastomeric, non-vulcanized, double set screw connection

#### Features:

- E-Z assembly and disassembly
- Double cam principle provides a positive, vibration-proof connection
- Self-compensating for wear
- No moving contact surfaces, eliminating arcing or burning
- Superior electromechanical connections
- Locked contacts will withstand a pulling force of 1,000 lbs.
- 1/3 of a turn assures a high pressure contact approaching 600 lbs. per sq. in., providing minimum resistance
- Contacts carefully machined from a high conductivity brass to provide a smooth sliding fit and easy locking action
- Watertight elastomeric insulators molded from colorfast material, color-coded for easy phase identification
- Accepts a wide range of cable sizes

#### Certifications and compliances:

- Listed to UL1691
- Listed to CSA C22.2 No. 1691-12
- CSA certified to C22.2 No. 182.3 LR13963

#### Environmental rating:

- NEMA 3R

#### Material characteristics:

- Insulator – TPE
- Temperature rating – operating ambient: -40°C to 105°C

#### Ordering information:



E-Z1018-8354



E-Z1018-8381

### Double set screw non-vulcanized plugs

Male				
Cable size	Color	Cat. # Complete	Cat. # Contact only	Cat. # Insulator only
#2 - 2/0	Black	E-Z1018-8350	A200630-1	E-Z200071-19
	Red	E-Z1018-8352		E-Z200071-21
	Green	E-Z1018-8354		E-Z200071-23
	White	E-Z1018-8355		E-Z200071-24
	Blue	E-Z1018-8356		E-Z200071-37
	Brown	E-Z1018-8357		E-Z200071-39
	Orange	E-Z1018-8353		E-Z200071-22
	Yellow	E-Z1018-8351		E-Z200071-20

Female				
Cable size	Color	Cat. # Complete	Cat. # Contact only	Cat. # Insulator only
#2 - 2/0	Black	E-Z1018-8375	A200640-4	E-Z200072-19
	Red	E-Z1018-8377		E-Z200072-21
	Green	E-Z1018-8379		E-Z200072-23
	White	E-Z1018-8380		E-Z200072-24
	Blue	E-Z1018-8381		E-Z200072-37
	Brown	E-Z1018-8382		E-Z200072-39
	Orange	E-Z1018-8378		E-Z200072-22
	Yellow	E-Z1018-8376		E-Z200072-20

To order single packaged products, add suffix 'K' to the complete catalog number.

#### Dimensions:

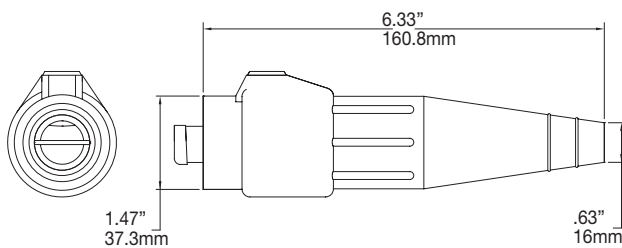

Male connector

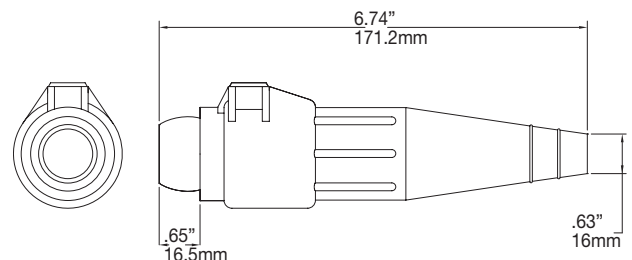

Female connector

# Cam-Lok standard series E-Z1018 plugs

NEMA 3R

10P

Cable size 2/0 - 4/0

600 VAC/VDC, up to 400A continuous

## Standard series E-Z1018, elastomeric, non-vulcanized, double set screw connection

### Features:

- E-Z assembly and disassembly
- Double cam principle provides a positive, vibration-proof connection
- Self-compensating for wear
- No moving contact surfaces, eliminating arcing or burning
- Superior electromechanical connections
- Locked contacts will withstand a pulling force of 1,000 lbs.
- 1/3 of a turn assures a high pressure contact approaching 600 lbs. per sq. in., providing minimum resistance
- Contacts carefully machined from a high conductivity brass to provide a smooth sliding fit and easy locking action
- Watertight elastomeric insulators molded from colorfast material, color-coded for easy phase identification
- Accepts a wide range of cable sizes

### Certifications and compliances:

- Listed to UL1691
- Listed to CSA C22.2 No. 1691-12
- CSA certified to C22.2 No. 182.3 LR13963

### Environmental rating:

- NEMA 3R

### Material characteristics:

- Insulator – TPE
- Temperature rating – operating ambient: -40°C to 105°C

### Ordering information:



E-Z1018-8364



E-Z1018-8390

### Double set screw non-vulcanized plugs

Male				
Cable size	Color	Cat. # Complete	Cat. # Contact only	Cat. # Insulator only
2/0 - 4/0	Black	E-Z1018-8362	A200639-1	E-Z200071-13
	Red	E-Z1018-8364		E-Z200071-15
	Green	E-Z1018-8366		E-Z200071-17
	White	E-Z1018-8367		E-Z200071-18
	Blue	E-Z1018-8368		E-Z200071-38
	Brown	E-Z1018-8369		E-Z200071-41
	Orange	E-Z1018-8365		E-Z200071-16
	Yellow	E-Z1018-8363		E-Z200071-14

Female				
Cable size	Color	Cat. # Complete	Cat. # Contact only	Cat. # Insulator only
2/0 - 4/0	Black	E-Z1018-8387	A200641-2	E-Z200072-13
	Red	E-Z1018-8389		E-Z200072-15
	Green	E-Z1018-8391		E-Z200072-17
	White	E-Z1018-8392		E-Z200072-18
	Blue	E-Z1018-8393		E-Z200072-38
	Brown	E-Z1018-8394		E-Z200072-41
	Orange	E-Z1018-8390		E-Z200072-16
	Yellow	E-Z1018-8388		E-Z200072-14

To order single packaged products, add suffix 'K' to the complete catalog number.

### Dimensions:

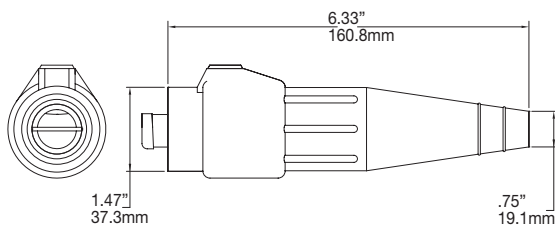

Male connector

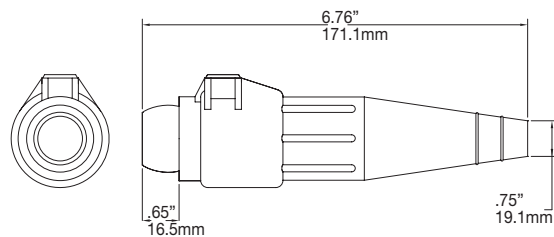

Female connector

10P

# Cam-Lok standard series E1018 receptacles and accessories

NEMA 3R

10P

Cable size 1/0 - 4/0

600 VAC/VDC, up to 400A continuous

## Standard series E1018, elastomeric, double set screw

### Features:

- Double cam principle provides a positive, vibration-proof connection
- Self-compensating for wear
- No moving contact surfaces, eliminating arcing or burning
- Superior electromechanical connections
- Locked contacts will withstand a pulling force of 1,000 lbs.
- 1/3 of a turn assures a high pressure contact approaching 600 lbs. per sq. in., providing minimum resistance
- Contacts carefully machined from a high conductivity brass to provide a smooth sliding fit and easy locking action
- Watertight elastomeric body molded from colorfast material, color-coded for easy phase identification
- Recessed contacts protected by insulating jacket that extends beyond contact ends for safety
- Receptacles are safety insulated for direct mounting to steel panels

### Certifications and compliances:

- Listed to UL1691
- Listed to CSA C22.2 No. 1691-12
- CSA certified to C22.2 No. 182.3 LR13963

### Environmental rating:

- NEMA 3R

### Material characteristics:

- Insulator – TPE
- Temperature rating – operating ambient: -40°C to 105°C

### Ordering information:



E1018-1700

### Insulated receptacles – double set screw

Tightening torque	Color	Cat. # Male	Cat. # Female
	Cable size	Black	E1018-1700
Red		E1018-1702	E1018-1727
Torque (in.-lbs.)	Green	E1018-1704	E1018-1729
	White	E1018-1705	E1018-1730
1/0 - 2/0	Blue	E1018-1706	E1018-1731
3/0 - 4/0	Brown	E1018-1707	E1018-1732
	Orange	E1018-1703	E1018-1728
	Yellow	E1018-1701	E1018-1726



E1018-1725

### Three-fer tapping tees

Color	Cat. # 45° M-F-F-F
Black	E1018-9510
Red	E1018-9512
Green	E1018-9514
White	E1018-9515
Blue	E1018-9516
Brown	E1018-9517
Orange	E1018-9513
Yellow	E1018-9511

To order single packaged products, add suffix 'K' to the complete catalog number.

### Dimensions:

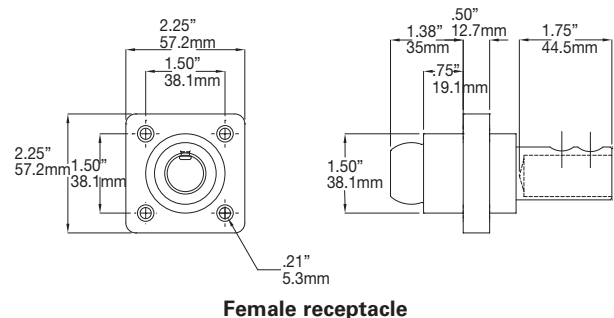
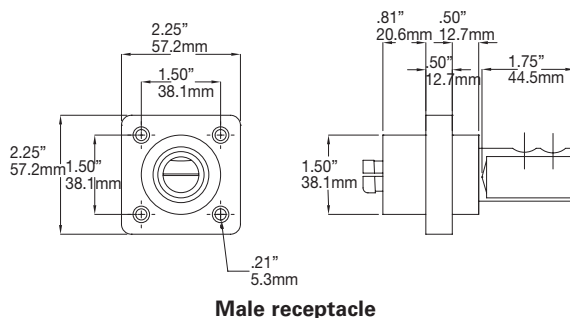

# Cam-Lok standard series E1018 receptacles

NEMA 3R

10P

Cable size #2 AWG - 4/0

600 VAC/VDC, up to 400A continuous

## Standard series E1018, elastomeric, threaded stud

### Features:

- Double cam principle provides a positive, vibration-proof connection
- Self-compensating for wear
- No moving contact surfaces, eliminating arcing or burning
- Superior electromechanical connections
- Locked contacts will withstand a pulling force of 1,000 lbs.
- 1/3 of a turn assures a high pressure contact approaching 600 lbs. per sq. in., providing minimum resistance
- Contacts carefully machined from a high conductivity brass to provide a smooth sliding fit and easy locking action
- Watertight elastomeric body molded from colorfast material, color-coded for easy phase identification
- Recessed contacts protected by insulating jacket that extends beyond contact ends for safety
- Receptacles are safety insulated for direct mounting to steel panels

### Certifications and compliances:

- Listed to UL1691
- Listed to CSA C22.2 No. 1691-12
- CSA certified to C22.2 No. 182.3 LR13963

### Environmental rating:

- NEMA 3R

### Material characteristics:

- Insulator – TPE
- Temperature rating – operating ambient: -40°C to 105°C

### Ordering information:



E1018-1600

### Insulated receptacles – 1 1/8" (28.6mm) threaded stud

Color	Cat. # Male	Cat. # Female
Black	E1018-1600S	E1018-1631S
Red	E1018-1602S	E1018-1633S
Green	E1018-1604S	E1018-1635S
White	E1018-1605S	E1018-1636S
Blue	E1018-1606S	E1018-1637S
Brown	E1018-1607S	E1018-1638S
Orange	E1018-1603S	E1018-1634S
Yellow	E1018-1601S	E1018-1632S

Stud size: 1/8" - 13; maximum torque: 40 ft.-lbs.



E1018-1631

### Insulated receptacles – 3/4" (19.1mm) threaded stud

Color	Cat. # Male	Cat. # Female
Black	E1018-1600	E1018-1631
Red	E1018-1602	E1018-1633
Green	E1018-1604	E1018-1635
White	E1018-1605	E1018-1636
Blue	E1018-1606	E1018-1637
Brown	E1018-1607	E1018-1638
Orange	E1018-1603	E1018-1634
Yellow	E1018-1601	E1018-1632

Stud size: 1/8" - 13; maximum torque: 40 ft.-lbs.

To order single packaged products, add suffix 'K' to the complete catalog number.

### Dimensions:

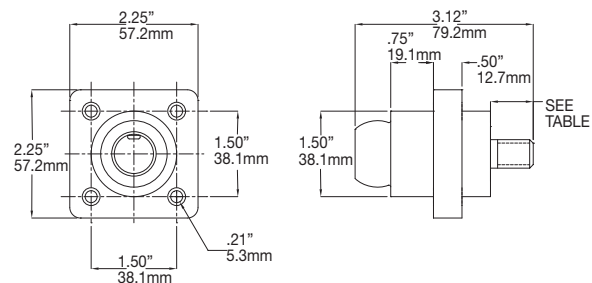
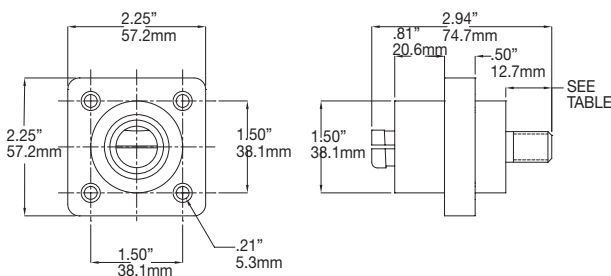

10P

# Cam-Lok standard series E1018 terminals

NEMA 3R

10P

600 VAC/VDC, up to 400A continuous

## Standard series E1018, rubber

### Features:

- Double cam principle provides a positive, vibration-proof connection
- Self-compensating for wear
- No moving contact surfaces, eliminating arcing or burning
- Superior electromechanical connections
- Locked contacts will withstand a pulling force of 1,000 lbs.
- 1/3 of a turn assures a high pressure contact approaching 600 lbs. per sq. in., providing minimum resistance
- Contacts carefully machined from a high conductivity brass to provide a smooth sliding fit and easy locking action
- Watertight body molded from colorfast material, color-coded for easy phase identification
- Recessed contacts protected by insulating jacket that extends beyond contact ends for safety

### Certifications and compliances:

- Listed to UL1691
- Listed to CSA C22.2 No. 1691-12
- CSA certified to C22.2 No. 182.3 LR13963

### Environmental rating:

- NEMA 3R

### Material characteristics:

- Body – rubber
- Temperature rating – operating ambient: -40°C to 105°C

### Ordering information:



E1018-575



E1018-625

### Female terminal connectors

Color	Cat. # Angle style	Cat. # Offset style
Black	E1018-575	E1018-625
Red	E1018-577	E1018-627
Green	E1018-579	E1018-629
White	E1018-580	E1018-630
Blue	E1018-587	E1018-638
Brown	E1018-590	E1018-639
Orange	E1018-578	E1018-628
Yellow	E1018-576	E1018-626

Stud hole:  $\frac{21}{32}$ " (16.7mm)

To order single packaged products, add suffix 'K' to the complete catalog number.

### Dimensions:

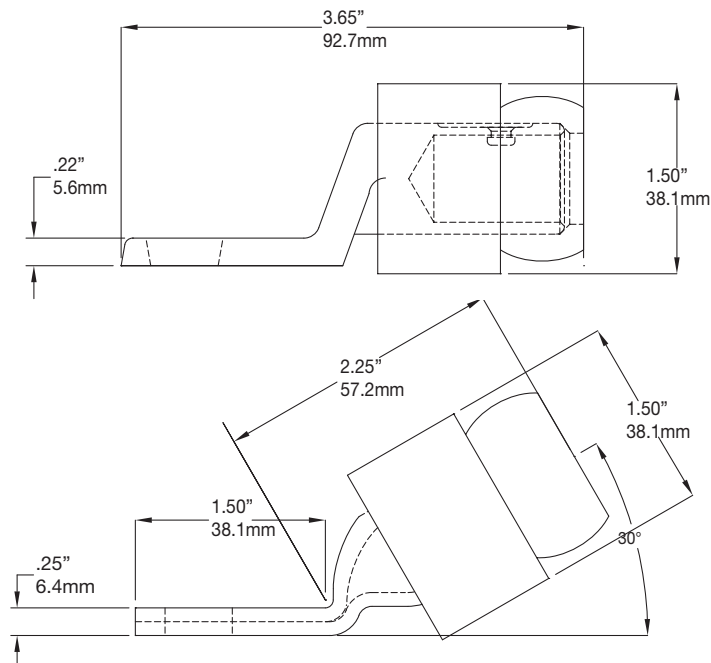



# Cam-Lok standard series E1018 accessories

NEMA 3R

10P

Cable size #2 AWG - 4/0

600 VAC/VDC, up to 400A continuous

## Standard series E1018, elastomeric

### Features:

- Double cam principle provides a positive, vibration-proof connection
- Self-compensating for wear
- No moving contact surfaces, eliminating arcing or burning
- Superior electromechanical connections
- Locked contacts will withstand a pulling force of 1,000 lbs.
- 1/3 of a turn assures a high pressure contact approaching 600 lbs. per sq. in., providing minimum resistance
- Contacts carefully machined from a high conductivity brass to provide a smooth sliding fit and easy locking action
- Watertight elastomeric body molded from colorfast material, color-coded for easy phase identification
- Recessed contacts protected by insulating jacket that extends beyond contact ends for safety

### Certifications and compliances:

- Listed to UL1691
- Listed to CSA C22.2 No. 1691-12
- CSA certified to C22.2 No. 182.3 LR13963

### Environmental rating:

- NEMA 3R

### Material characteristics:

- Body – TPE
- Temperature rating – operating ambient: -40°C to 105°C

### Ordering information:



E1018-2324



A100435-1

### Three-way lay down 'T' connectors

Color	Cat. # Paralleling 'T' M-M-F	Cat. # Tapping 'T' M-F-F
Black	E1018-2324	E1018-2312
Red	E1018-2326	E1018-2314
Green	E1018-2328	E1018-2316
White	E1018-2329	E1018-2317
Blue	E1018-2348	E1018-2350
Brown	E1018-2396	E1018-2395
Orange	E1018-2327	E1018-2315
Yellow	E1018-2325	E1018-2313

### Protective caps

Color	Cat. # Male	Cat. # Female
Black	A100435-1	A100433-1
Red	A100435-5	A100433-5
Green	A100435-9	A100433-9
White	A100435-11	A100433-11
Blue	A100435-15	A100433-15
Brown	A100435-13	A100433-13
Orange	A100435-7	A100433-7
Yellow	A100435-3	A100433-3

To order single packaged products, add suffix 'K' to the complete catalog number.

### Dimensions:

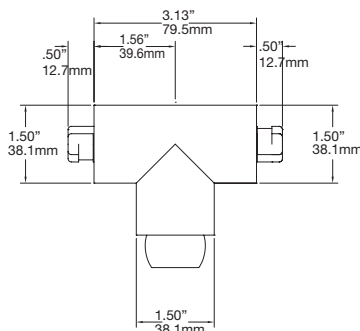

10P

## Portable vulcanizing kits and presses

### Ordering information:

### Complete vulcanizing kits

Cable size	Cable O.D.	Cat. # E1015 series	Cat. # E1016 series
#8	0.440	A300120-1	-
#6	0.510	A300120-2	-
#4	0.570	A300120-3	-
#2	0.660	-	A300100-3
#1	0.740	-	A300100-4
1/0	0.770	-	A300100-5
2/0	0.820	-	A300100-6
3/0	0.870	-	A300100-7
4/0	0.930	-	A300100-8

Kit contains: vulcanizing press, male and female COM-A-LONG, cable cutter, crimp press and neoprene tape.

### Vulcanizing presses only

Cable size	Cable O.D.	Cat. # E1015 series	Cat. # E1016 series	Cat. # E1017 series
#8	0.440	A300121-1	-	-
#6	0.510	A300100-2	-	-
#4	0.570	A300100-3	-	-
#2	0.660	-	A300103-3	-
#1	0.740	-	A300103-4	-
1/0	0.770	-	A300103-5	-
2/0	0.820	-	A300103-6	-
3/0	0.870	-	A300103-7	-
4/0	0.930	-	A300103-8	-
350 MCM	1.150	-	-	A300106-1
500 MCM	1.310	-	-	A300106-2
750 MCM	1.580	-	-	A300106-3

### Plug molding bushings

Cable size	Cable O.D.	Cat. # E1015 series	Cat. # E1016 series	Cat. # E1017 series
#8	0.440	201015-3	-	-
#6	0.510	201015-15	-	-
#4	0.570	201015-18	-	-
#2	0.660	-	200895-20	-
#1	0.740	-	200895-21	-
1/0	0.770	-	200895-22	-
2/0	0.820	-	200895-23	-
3/0	0.870	-	200895-24	-
4/0	0.930	-	200895-17	-
350 MCM	1.150	-	-	200006-3
500 MCM	1.310	-	-	200006-6
750 MCM	1.580	-	-	200006-8

Ordering information:

Molding press parts and vulcanizing accessories

Cat. #	Description	Cat. #	Description
	All mold kits and presses	<b>100827-3</b>	Mold press pilot light – red, complete with wired socket
<b>A400001</b>	E1016/E0400 assembly tool	<b>200704-2</b>	Cartridge heater – 350-750 MCM molds
<b>319735-1</b>	Neoprene vulcanizing tape, 1.5" x 30' roll	<b>200704-3</b>	Cartridge heater – #2-4/0 molds
<b>100566-1</b>	Mold press thermostat	<b>A100072</b>	Cable cutter – #2-4/0 cable
<b>A100632</b>	Tool for removing contacts from insulators	<b>A200020-3</b>	COM-A-LONG for pulling male contact in E1012, E1016, E1018 and E0400 series
<b>100826-3</b>	Mold press power on/off switch	<b>A200020-4</b>	COM-A-LONG for pulling female contact in E1012, E1016, E1018 and E0400 series
<b>A200020-1</b>	COM-A-LONG for pulling male contact in E1015 series	<b>A200020-5</b>	COM-A-LONG for pulling male contact in E1017 series
<b>A200020-2</b>	COM-A-LONG for pulling female contact in E1015 series	<b>A200020-6</b>	COM-A-LONG for pulling female contact in E1017 series
		<b>A101208</b>	2 oz. tube silicon grease for lubricating synthetic rubber insulators

E1015 and E1016 series crimping nests and presses

Cable size	Cat. # Crimping nests	Cat. # Crimping presses
#8	<b>100514-1</b>	<b>A200914-1</b>
#4 - #6	<b>100514-2</b>	<b>A200914-2</b>
#1 - #2	<b>100514-3</b>	<b>A200914-3</b>
1/0 - 2/0	<b>100514-4</b>	<b>A200914-4</b>
3/0	<b>100514-5</b>	<b>A200914-5</b>
4/0	<b>100514-6</b>	<b>A200914-6</b>

Gauge block for calibrating crimper: #100891.

Other accessories

Connector series	Cat. # Set screw	Cat. # Copper shim	Quantity	Cat. # Pressure pad	Cat. # Retaining wire
E1010 all	<b>100012-25</b>	<b>A100400-1</b>	25	N/A	<b>100573-1</b>
E1012-61 and E1012-62	<b>100012-7</b>	<b>A100400-3</b>	20	<b>100575</b>	<b>100573-1</b>
E1012 single set screw	<b>100012-18</b>	<b>A100400-3</b>	20	N/A	<b>100573-1</b>
E1016 single set screw	<b>100012-18</b>	<b>A100400-3</b>	20	N/A	<b>100573-1</b>
E1017 double set screw	<b>100012-5</b>	<b>A100400-9</b>	10	N/A	<b>100573-2</b>
E1018 single set screw	<b>100012-18</b>	<b>A100400-3</b>	20	N/A	<b>100573-1</b>
E1012 double set screw	<b>100012-18</b>	<b>A100400-4</b>	20	<b>101214</b>	<b>100573-1</b>
E1016 double set screw	<b>100012-18</b>	<b>A100400-4</b>	20	<b>101214</b>	<b>100573-1</b>