

# **TDS-DINLINE™**

## **SURGE SUPPRESSOR**

### **INSTALLATION INSTRUCTIONS**

Includes TDS-AR Alarm Relay  
and TDS-SC Surge Counter

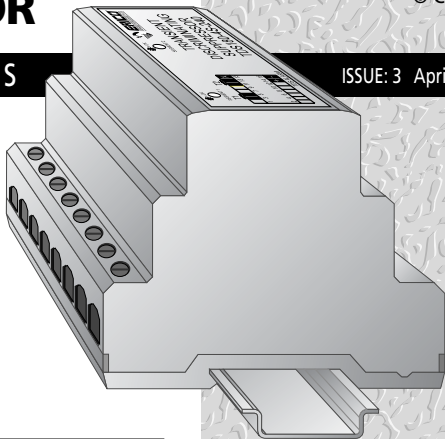

Handbook No:  
HB-HBCR-109

© Copyright

ISSUE: 3 April 2003

# **ERICO®**

[www.erico.com](http://www.erico.com)

INSIDE FRONT COVER

(Blank)

**CONTENTS**

	<u>Page</u>		<u>Page</u>
1. Warnings	4	11. Isolation and Fusing	15
2. Introduction	5	12. Status Indication	17
3. Quick Installation Guide	5	13. Maintenance & Testing	18
4. Protection Concepts	6	14. Alarm Relay (TDS-AR)	19
5. Mounting	7	15. Surge Counter (TDS-SC)	26
6. Voltage Ratings	8	16. Typical Domestic Installation	29
7. Protection Modes	8	17. Extended Warranty	30
8. Conductor Sizes	10	18. Six Point Plan	31
9. Conductor Length	11		
10. RCD, ELCB	14		

## I. WARNINGS

- Prior to installation ensure that the unit is of the correct voltage and frequency, and is the type recommended for the local power distribution, and for the equipment being protected.
- Hazardous voltages may exist internally to the modules. The units should be installed (and replaced) only by qualified personnel in accordance with all relevant Electricity Safety Standards.
- Do not power three phase connected units without the upstream neutral connected. Failure to do so may damage the units and/or the load.
- Where the unit has an earth terminal, this must be connected to a low impedance earth (<10  $\Omega$ ) for correct operation.
- If connecting to the TDS Opto-coupler alarm outputs do not reverse the +/- connections or exceed the maximum permissible ratings as damage may occur.
- Use only the TDS-AR Alarm Relay with TDS-DINLINE.
- Use only TDS-SC Surge Counter with TDS DINLINE.
- Units must be installed in an enclosure or panel, ensure this does not cause the units environmental ratings to be exceeded.
- Do not “Megger” or “Flash Test” circuits with TDS-DINLINE units installed.
- All instructions must be followed to ensure correct and safe operation.
- Diagrams are illustrative only, and should not be relied on in isolation.

## 2. INTRODUCTION

This Installation Manual details the preferred procedure for the installation of TDS-DINLINE™ SURGE SUPPRESSORS and options.

The TDS-DINLINE SURGE SUPPRESSORS are available in a variety of surge ratings, which are packaged in the 2M, 4M and 8M “DIN 43 880” compliant enclosures. They are designed to suit many distribution systems including TN-C, TN-S, TN-C-S (MEN) and TT. They can be selected for use with distribution systems with nominal RMS voltages of 110/120, 220/230/240V or 277V at frequencies of 50/60 Hz.

Recommended installation and connection of the ALARM RELAY (TDS-AR) is detailed in

Section 14. Installation and connection of the Surge Counter (TDS-SC) is detailed in section 15.

## 3. QUICK INSTALLATION GUIDE

Install in the following manner:

1. Ensure that power is removed from the area and circuits to be connected.
2. Install the DIN mounting rail, if not fitted.
3. Snap lock the Surge Suppressor to the rail.
4. Connect wiring to the indicated terminals.
5. Ensure compliance with supplied instructions.
6. Apply power and observe correct operation of Status Indicators, and alarm facilities if utilised.

## 4. PROTECTION CONCEPTS

To optimise effectiveness of installed protection a concept of “Unprotected” and “Protected” wiring should be followed. Wiring from the transient source to the Surge Suppressor should be considered “Unprotected” and kept remote from all other wiring (approximately 300mm) where possible. Wiring on the equipment side of the Surge Suppressor should be considered “Protected”.

The separation of “Protected” from “Unprotected” wiring is recommended in order to minimise the risk of transients conducted on “Unprotected” wiring cross coupling on to “Protected” circuits, thus compromising the level of protection available from the Surge Suppressor.

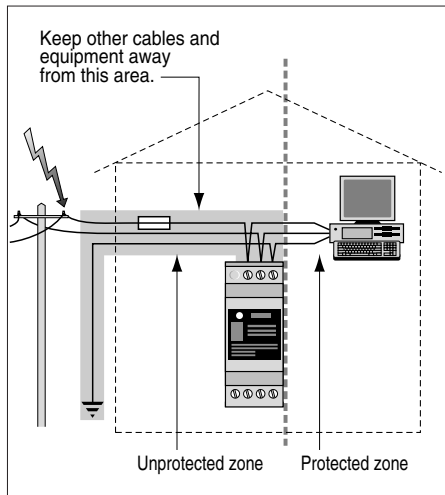

## 5. MOUNTING

Surge Suppressors are designed to clip to 35mm top hat DIN rails (to Standard EN50022). Unless otherwise mechanically restrained, use horizontal DIN rails with the

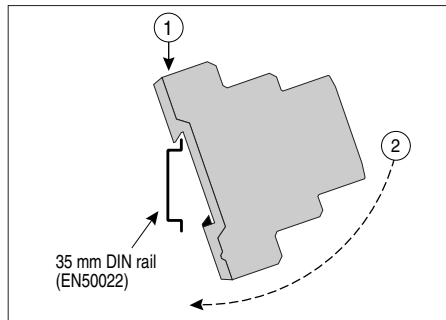

Surge Suppressor fixing clip to the bottom, ie label text the correct way up.

Units must be installed in an enclosure or panel to provide the appropriate degree of electrical and environmental protection.

Only use enclosures that:

- Do not cause the internal temperature to exceed 55 deg C.
- Provide adequate electrical and safety protection.
- Prevent the ingress of moisture and water.
- Allow Surge Suppressor Status Indication to be inspected.

## 6. VOLTAGE RATINGS

Ensure that the correct voltage rating unit is installed. Exceeding the nominal voltage rating under transient conditions may affect product life. Do not exceed the Maximum Permissible Abnormal Over Voltage rating.

Model	Nominal Voltage	Maximum Permissible Abnormal Over Voltage
TDS XXX-120	110-120 Vac	240Vac
TDS XXX-208	208 Vac	260 Vac
TDS XXX-240	220-240 Vac	415 Vac
TDS XXX-277	220-277 Vac	480 Vac

## 7. PROTECTION MODES

Protection Modes refers to how the internal protection is arranged and applied to the circuit to be protected.

TDS-DINLINE Surge Suppressors are Single Mode units which provide protection between two conductors connected to the terminals marked T1 and T2. These units can be connected to provide protection from Phase-Neutral\* or Phase-Earth\* or Neutral-Earth. To allow the status indication and alarm circuitry to operate, a neutral connection is required for Phase-Earth\* configured units, and a Phase\* connection is required for Neutral-Earth configured units.

\* Note. Some users may be used to the terminology “Active” or “Line”, in place of “Phase”. For consistency “Phase” is used throughout this documentation.



## SINGLE MODE UNITS

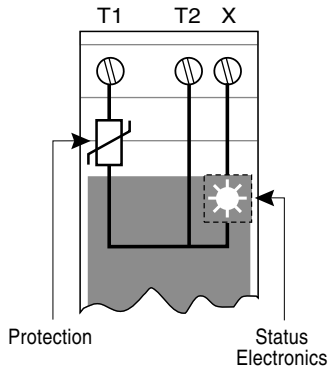

## CONNECTION OPTIONS

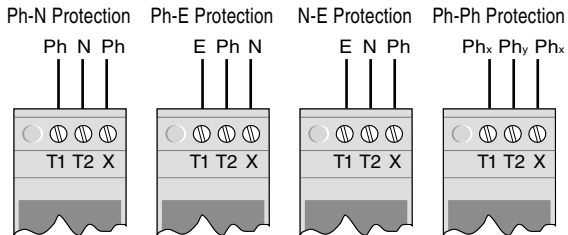

## PROTECTION MODE

Terminals	Ph-N	Ph-E	N-E	Ph <sub>x</sub> - Ph <sub>y</sub>
T1	Ph	E	E	Ph <sub>x</sub>
T2	N	Ph	N	Ph <sub>y</sub>
X	Ph	N	Ph	Ph <sub>x</sub>

Phase to Phase protection can also be provided by Surge Suppressors, provided that the nominal and maximum voltage ratings are not exceeded.

## 8. CONDUCTOR SIZES

Each Surge Suppressor terminal is designed to accept wire sizes from  $1.5\text{mm}^2$  to  $6\text{mm}^2$ , solid or stranded conductor. Insulation should be stripped back 8mm before terminating into the tunnel terminal.

Where two conductors require termination in the same tunnel terminal, conductors should be limited to a maximum size of  $4\text{mm}^2$ .

Do not use excessive force when tightening the terminal.

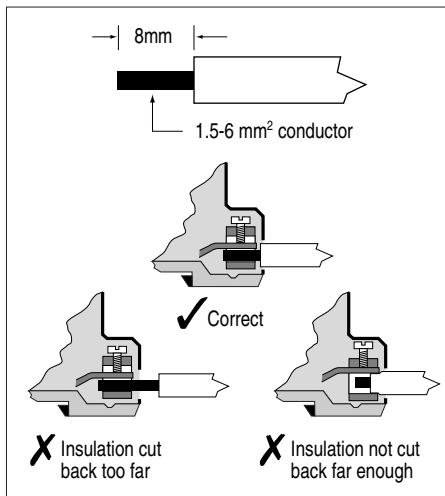

## 9 CONDUCTOR LENGTH

To optimise transient performance, attempt to connect units in the “Preferred” fashion as depicted on pages 11 and 12. Some units have double terminals to facilitate this. Take care not to run parallel “protected” and “unprotected” wiring.

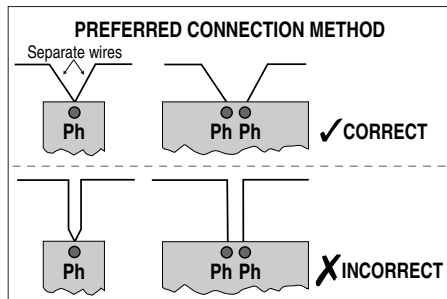

Where this is not possible due to layout or conductor sizing, use the “Non-preferred” “T” connection method as depicted on page 13. With this connection method, the “T” lead length should be kept as short as practicable (less than 100mm) and wires should be bundled together. The “T” conductor should be equal in size to the main conductor, up to a maximum of 6mm<sup>2</sup>.

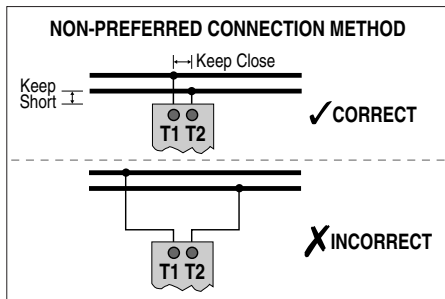

**PREFERRED CONNECTION METHOD EXAMPLE FOR Ph-E PROTECTION**

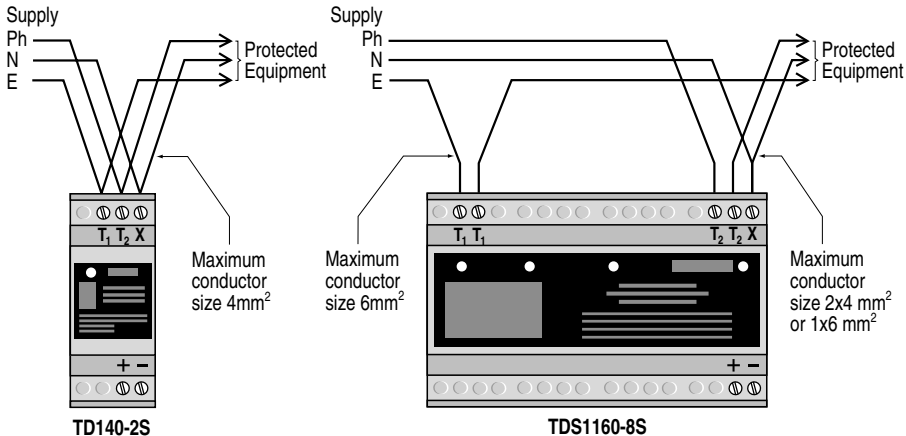

**NON-PREFERRED "T" CONNECTION METHOD EXAMPLE FOR Ph-E PROTECTION**

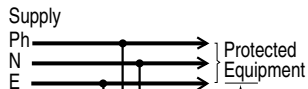

Bundle together

*Keep as short as practical*



**TDS 140-2S**

Maximum conductor size 6mm<sup>2</sup>

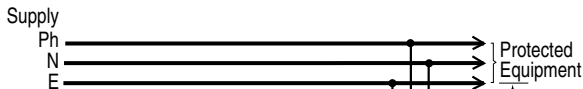

Bundle together

*Keep as short as practical*

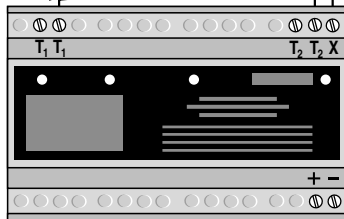

**TDS1160-8S**

Maximum conductor size 6mm<sup>2</sup>



## II. ISOLATION AND FUSING

Overcurrent and short circuit protection must be provided to protect the Surge Suppressor and associated wiring if a fault develops. The overcurrent protection should be installed in such a manner to also provide a means of isolating the TDS-DINLINE module from the mains supply. This is an important safety consideration and is required in the event that any future maintenance or testing is needed.

For Surge Suppressors installed in the “preferred” connection method (page 12), upstream overcurrent protection should be installed based on the maximum current carrying capacity of the conductors. Australian regulations AS3000-1991, Table B2 specifies the following upstream protection for the protection of single phase circuits.

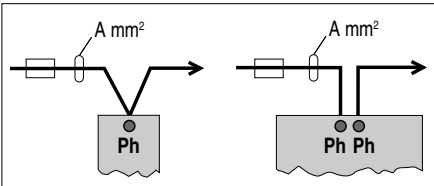

Conductor Size	Required Fuse	
	CB or Fuse	Rewirable Fuse
A mm <sup>2</sup>		
1.5 mm <sup>2</sup>	16A	12A
2.5 mm <sup>2</sup>	20A	16A
4.0 mm <sup>2</sup>	25A	20A
6.0 mm <sup>2</sup>	32A	25A

Fuse selection based on maximum current carrying capacity of conductor. Smaller rated fuse may be selected if required.  
CB = Circuit Breaker.

For Surge Suppressors installed in the “non-preferred” connection method (page 13), depending upon the size and fusing in the main circuit, the “T” connection may require independent fusing to be installed.

Circuits with upstream protection rated at greater than 100A must have a 100A HRC fuse or circuit breaker installed in the T connection as detailed by the following diagram.

### Warning:

Isolation/fusing installed in the “T” connection may disconnect the Surge Suppressor from the circuit/equipment to be protected. The remote alarm contacts of the ALARM RELAY (TDS-AR) should be used to detect this occurrence. Operation of the isolation/fuse will remove the protection from the circuit.

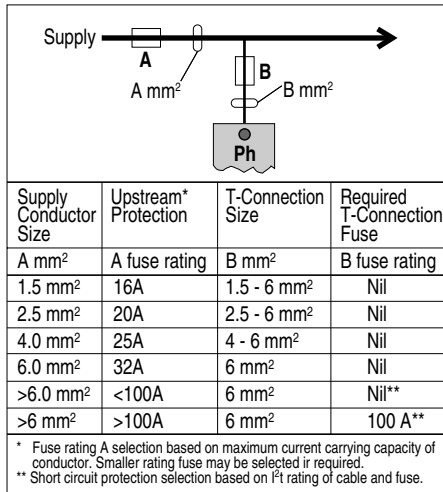



The selection of the 100A HRC fuse is not based on the load carrying capacity of the main circuit but the “T” connection I<sup>2</sup>t rating. The “T” connection under normal conditions does not carry the load current. Only under surge or fault conditions does this connection carry large currents. Under Australian Standard AS3008.1-1989 it is permissible to rate the protection for these types of circuits by the I<sup>2</sup>t ratings of the cable. For installation of Surge Suppressor in countries not covered by these regulations it is recommended that this practice be followed, unless it conflicts with the compliance of the local regulations.

## 12. STATUS INDICATION

A characteristic of **all** transient and surge protection devices is that they degrade in proportion to the magnitude and number of

incident surges to which they have been subjected. Status indication should be periodically monitored to determine if replacement is required.

### 2S units

These units are identified by the single Status Indicator provided on the front panel. When power is applied **and** full surge capacity is available the Status Indicator will be illuminated. Should the indicator fail to illuminate the Surge Suppressor should be replaced, as optimum protection is no longer provided. Note: The Status Indicator will not operate (regardless of surge capacity) if power is not available.

### 4S units

These units are identified by two Status Indicators which are provided on the front panel. These Status Indicators monitor

separate protection segments. Each Status Indicator is illuminated when power is available **and** when full surge capacity is available by that segment. The Surge Suppressor should be replaced if **either** Status Indicator fails to illuminate. Note: The Status Indicators will not operate (regardless of surge capacity) if power is not available.

### 8S units

These units are identified by four Status Indicators which operate similar to above. The Surge Suppressor should be replaced if **any two or more** Status Indicators fail to illuminate.

## 13. MAINTENANCE & TESTING

**Before removing any unit from service ensure that power to the device is isolated. Replacement of any Surge Suppressor should only be undertaken in accordance with all relevant Electricity and Safety Standards by suitably qualified personnel.**

TDS-DINLINE units should be inspected periodically, and also following any periods of lightning or transient activity. Check the status indicators and replace if recommended in Section 12 -STATUS INDICATION.

For high transient exposure sites or those of a critical operational nature, it is recommended that the alarm outputs be monitored to provide an additional warning of reduced capacity (refer Section 14 - ALARM RELAY-TDS-AR).

TDS-DINLINE Surge Suppressor units are designed for optimum performance under severe transient activity. To provide this performance, electronic components in the unit are encased in a patented proprietary, shock and thermal absorbent compound.

**Units cannot be serviced, they must be replaced.**

Do not attempt to open or tamper with the units in any way as this may compromise performance and will void warranty.

Do not “Megger” or perform other types of electrical tests that apply voltages greater than the nominal operating voltage of the Surge Suppressor. The Suppressor will attempt to limit these voltages thereby affecting the test result. Where these tests must be performed, remove the Surge Suppressor from circuit first.

#### 14. ALARM RELAY (TDS-AR)

The Surge Suppressor status monitoring circuit which provides the visual status display also provides a low voltage opto-coupler alarm output circuit. This should only be connected to the TDS ALARM RELAY. The TDS-AR voltage free alarm contacts may then provide output to external alarm systems or remote monitoring circuits.

The TDS ALARM RELAY provides fully isolated potential free change-over alarm output contacts. One TDS-AR can be used per Suppressor opto-coupler alarm or Multiple Suppressor opto-coupler alarms can be connected in series to the one TDS-AR to provide a common output.

1 x TDS-AR supports:

- 20 x TDS140-2S
- or 10 x TDS 180-4S
- or 5 x TDS 1160-8S
- or relative combinations.

It is recommended that the TDS-AR unit be powered from the same power circuit that feeds to the Surge Suppressor being monitored, however it can be powered from other circuits. This allows for example, one TDS-AR unit to be connected to separate Surge Suppressors that are protecting a three phase circuit.

To satisfy Australian wiring regulations the phase supply to the TDS-AR needs to be protected by an overcurrent fuse/circuit breaker. The overcurrent protection should be selected according to the wiring size

connecting to the TDS-AR Phase and Neutral terminals. For reference a table of values is given on page 24.

Note. Depending upon the usage of the TDS-AR output contacts, failure of power to the TDS-AR may be interpreted as a failure of one or more Surge Suppressors. Visual inspection of all units Status displays would determine this.

	✓	!	X
STATUS	Protection Operational	Protection Alarm	Fault Mode
DISPLAY	<p>Normal</p> <p>Fault</p>	<p>Normal</p> <p>Fault</p>	<p>Normal</p> <p>Fault</p>
EXPLANATION	<p>Normal operation</p> <p>Normal (green) indicator ON Red indicator OFF Relay is energised Power is supplied</p>	<p>Surge Suppressor in alarm mode or power to Suppressor has been removed</p> <p>Normal (green) indicator OFF Red indicator ON Relay is de-energised Power is supplied</p>	<p>Power to TDS-AR removed Protection status unknown</p> <p>Normal (green) indicator OFF Red indicator OFF Relay is de-energised Power is OFF</p>

**SINGLE ALARM CONNECTION EXAMPLE**

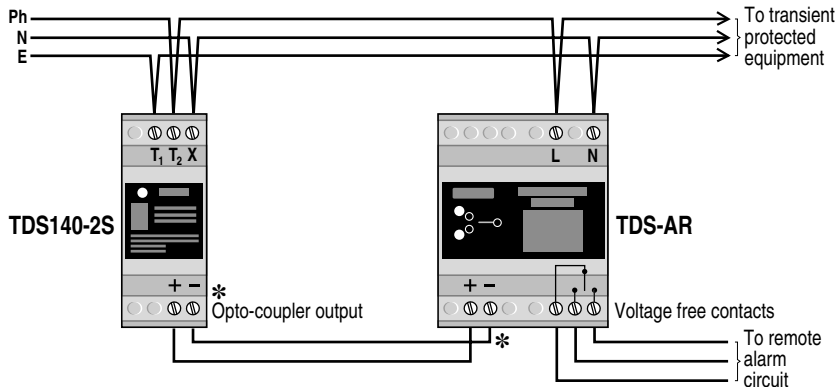

**\* WARNING - Connections are polarity sensitive. Do not reverse.**

**MULTIPLE ALARM CONNECTION EXAMPLE**

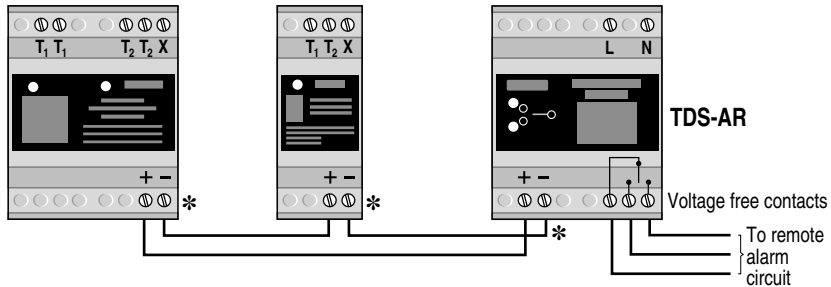

**TDS180-4S**

**TDS140-2S**

**\*WARNING - Connections are polarity sensitive. Do not reverse.**

## TDS-AR SPECIFICATIONS:

### Output Contact Ratings

Nominal switching capacity	<b>2A 30VDC</b>
Maximum switching power	<b>60W 125VA</b>
Maximum switching voltage	<b>220VDC, 250VAC</b>
Maximum switching current	<b>2A</b>
Input to output isolation	<b>4kV</b>

Note: TDS-AR operates on supply voltages of 100-480V Vrms.

### TDS-AR OVERCURRENT PROTECTION

The power supply to the TDS-AR circuit must be provided with upstream overcurrent protection. The fuse rating should be based on

the wiring size used to connect to the TDS-AR Ph & N terminals.

Australian regulations AS3000-1991, Table B2 specifies the following upstream protection for single phase circuits, unenclosed in air.

Cable Size	HRC Fuse or CB	Rewirable Fuse
1.5mm <sup>2</sup>	16A	12A
2.5mm <sup>2</sup>	20A	16A
4mm <sup>2</sup>	25A	20A
6mm <sup>2</sup>	32A	25A

Where overcurrent protection of the appropriate rating or smaller is already fitted in the upstream circuit, overcurrent protection at the TDS-AR will not be required.



## ALARM TESTING

Testing of the Alarm Relay which is connected to a fully functional Surge Suppressor unit can be accomplished by removing power to the Surge Suppressor only. The Alarm Relay Status indication and output contacts should alter from the Normal to Fault condition.

Testing of the Alarm Relay unit alone may be accomplished by disconnecting the + / - connections to the unit. When power is applied the "Fault" Status Indicator should be illuminated. By connecting the + / - terminals together, the "Normal" Status Indicator should be illuminated. The output contacts should alter to the appropriate state.

## USE OF OTHER INTERFACES

Only ERICO TDS-AR units are recommended for the interfacing of equipment to the TDS-DINLINE opto-coupler alarm output circuit.

The direct connection of other equipment to the opto-coupler alarm output circuit may not provide sufficient isolation or exceed the opto-coupler specifications. This may damage the Surge Suppressor and/or the connected equipment. Warranty may be voided under such circumstances.

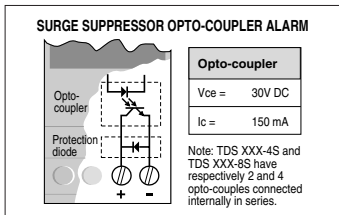

## 15. TDS-SC SURGE COUNTER

The Surge Counter is designed to interface to the TDS DINLINE units via the supplied CT, to record the number of surges and impulses diverted. This is achieved by measuring the transient current diverted by the TDS protection device. It is important that the CT be installed into the circuit where it is measuring the surge current only, and not where mains load current is passed through the core. Method 1 and Method 2 (page 28) detail the correct connection. Page 27 shows an incorrect connection as the equipment load current is passed through the CT core. The magnetic field from the load carrying conductor may cause the CT core to saturate. The surge Counter may fail to record any transients and additionally dangerously high voltages may be present on the TDS-SC & CT terminals.

### WARNINGS

- Do not install CT into load current carrying circuits.
- CT must be installed into surge current path only.
- Only install the CT and Surge Counter after all power and transient sources are removed and isolated from the equipment the Surge Counter is to monitor.
- Do not open circuit or disconnect connections on the secondary of the CT when monitored circuit is powered or connected to possible transient source. Hazardous voltages may exist in the secondary circuit and in the CT/TDS-SC if these instructions are not followed.

- Only this CT should be used with the TDS-SC Surge Counter, other suppliers devices may not operate correctly or pose a safety hazard.
- These instructions should only be carried out by qualified personnel in accordance with relevant national electrical and safety codes. Hazardous voltage may exist in the monitored system.

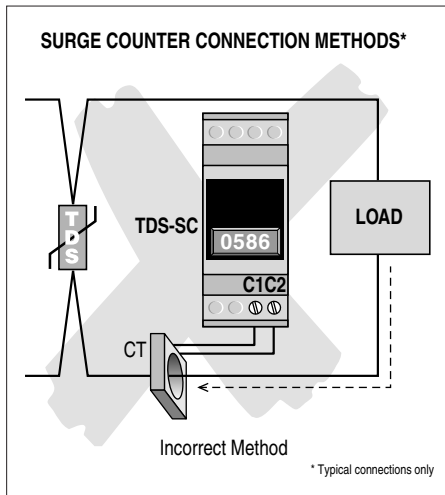

**SURGE COUNTER CONNECTION METHODS\***

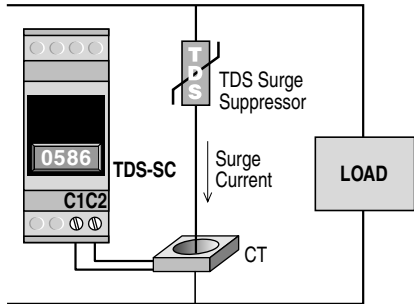

Correct Method 1

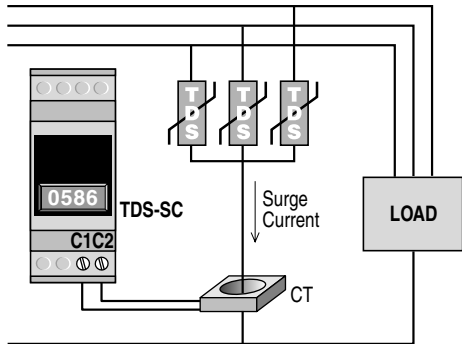

Correct Method 2

\* Typical connections only

**14. TYPICAL DOMESTIC INSTALLATION (from 80A fused supply)**

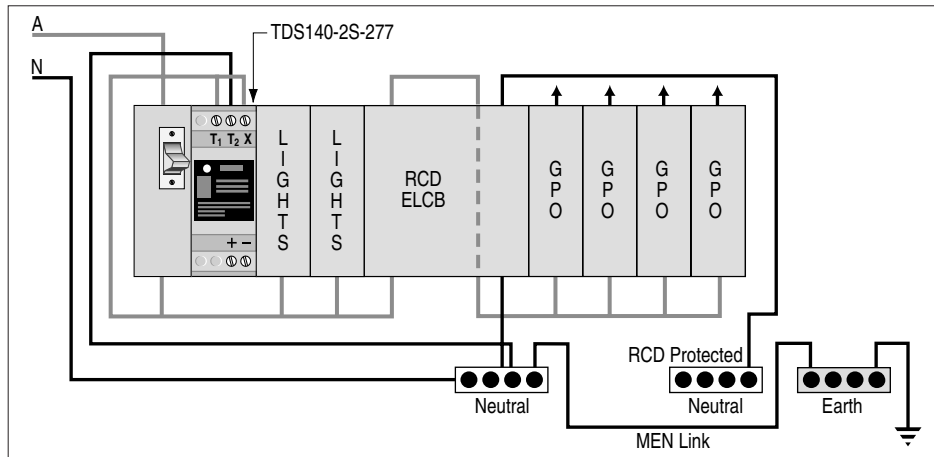

## 17. EXTENDED WARRANTY

This product has a limited warranty to be free from defects in materials and workmanship for a period of five (5) years from the date of dispatch from the Manufacturer. The Purchaser acknowledges that lightning is a natural event with statistical variation in behaviour and energy levels which may exceed product ratings, and 100 % protection is not offered and cannot be provided for. Therefore the Manufacturer's liability is limited to the repair or replacement of the product (at the Manufacturer's sole option) which in its judgement has not been abused, misused, interfered with by any person not authorised by the Manufacturer, or exposed to energy or transient levels exceeding the Manufacturer's specifications for the product. The product must be installed and earthed (where applicable) in strict accordance with the Manufacturer's specifications and all relevant national Electricity and Safety Standards. The Manufacturer and the

Purchaser mutually acknowledge that the product, by its nature, may be subject to degradation as a consequence of the number and severity of surges and transients that it experiences in normal use, and that this warranty excludes such gradual or sudden degradation. This warranty does not indemnify the Purchaser of the product for any consequential claim for damages or loss of operations or service or profits. Customers should contact their nearest manufacturer's agent to obtain a Product Repair Authorisation Number prior to making any claim under this warranty. This is only a summary of the warranty given by the Manufacturer. The full text of the warranty is set out in the Manufacturer's Conditions of Quotation and Sale. The above limited warranty is additional to rights which arise in respect of the sale of industrial and technical products and services to knowledgeable buyers under the Australian Trade Practices Act 1974 as amended.

## 18. SIX POINT PLAN

TDS-DINLINE SURGE SUPPRESSORS form an important part of the much larger ERICO lightning, surge and transient protection philosophy (ERICO Lightning Technologies "Six Point Plan"). The level of protection and the degree of attention dedicated to each of the six points will require careful consideration for each site. The degree of protection required is determined by the individual site location/exposure with the aid of risk management principals.

For further advice on your protection needs please contact your local representative.

### ERICO LIGHTNING TECHNOLOGIES' SIX POINT PROTECTION PLAN



**1**  
Capture the lightning strike



**4**  
Eliminate earth loops and differentials



**2**  
Conduct the strike to ground safely



**5**  
Protect equipment from surges on power lines



**3**  
Dissipate the energy through a low impedance earth system



**6**  
Protect equipment from transients on telecommunication and signal lines

### TDS-DINLINE CONNECTION OPTIONS

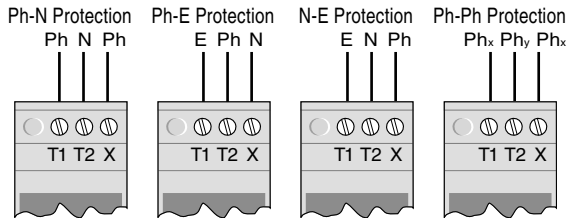

#### PROTECTION MODE

Terminals	Ph-N	Ph-E	N-E	Ph <sub>x</sub> - Ph <sub>y</sub>
T1	Ph	E	E	Ph <sub>x</sub>
T2	N	Ph	N	Ph <sub>y</sub>
X	Ph	N	Ph	Ph <sub>x</sub>