

Magelis™ Human/Machine Interfaces

Catalog
2013



Vijeo
Designer



Intelligent
DataService

Schneider
Electric™

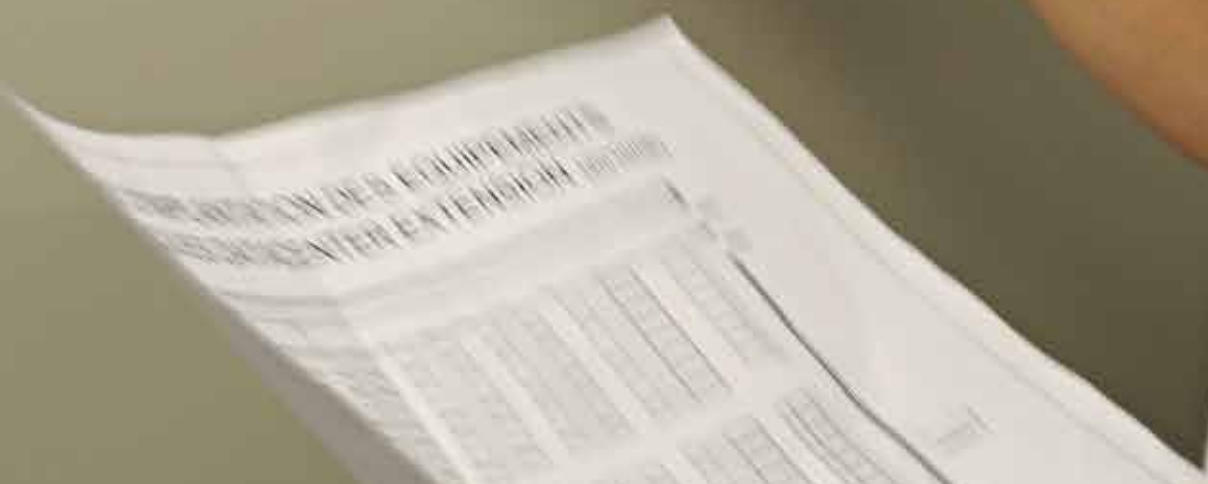

- Product data website 0/4

- 1 - Operator dialog terminals**
- Architectures, connections to automation systems 1/2
- Magelis™ Small Panels 1/4
- Magelis Advanced Panels 1/28
- USB accessories for HMI terminals 1/75

- 2 - HMI Controllers**
- Magelis SCU Small HMI Controllers 2/8
- Magelis HMI Controllers 2/12
- Magelis XBT GT/GK Advanced Panels with control function 2/24
- SoMachine software suite 2/30

- 3 - Industrial PCs**
- PC Panels: Magelis Smart iPC and Compact iPC 3/2
- Magelis Panel PC and BOX PC 3/10
- Magelis iDisplay flat screens 3/44

- 4 - HMI configuration software**
- Vijeo™ Designer™ Lite configuration software 4/4
- Vijeo Designer configuration software 4/8

- 5 - Appendices**
- Technical appendices 5/2
- Product reference index 5/4



Go online to www.schneider-electric.com for technical information about products listed in this catalog, including:

To learn more about the Magelis™ Human/Machine Interface product offer, follow these steps...

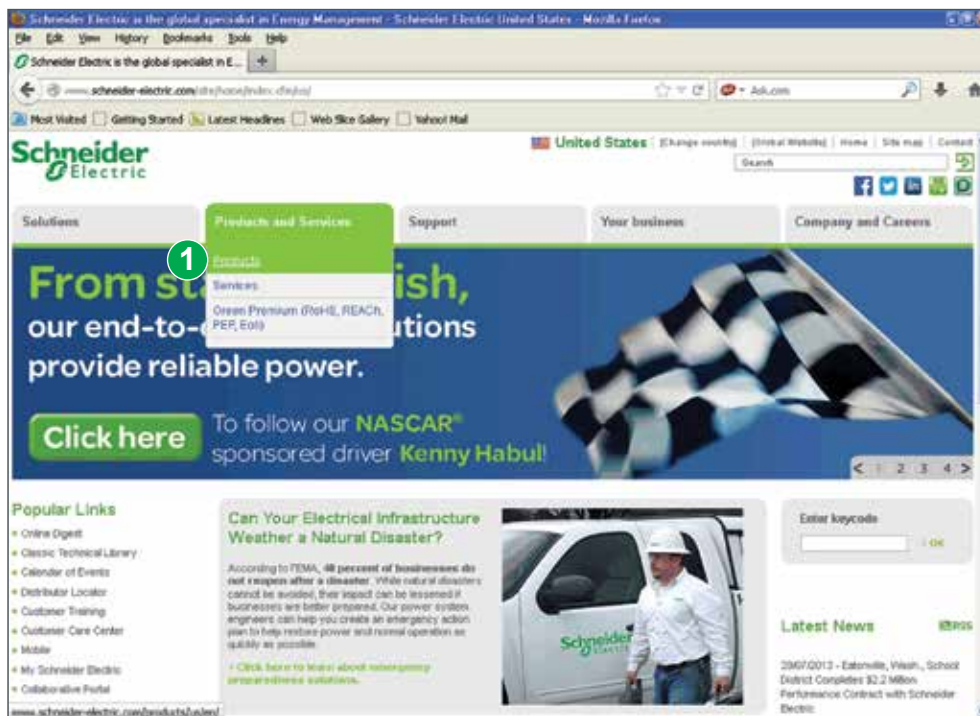

1 Go to: www.schneider-electric.com and select **“Products”** on the **“Products and Services”** tab.

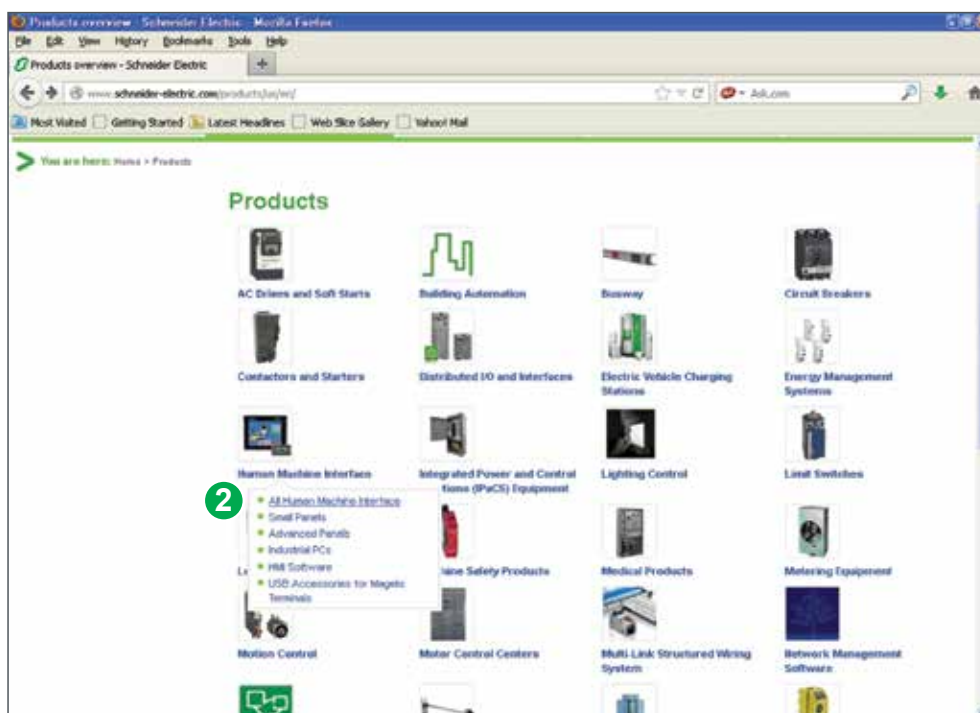

2 On the **“Products”** page, find the **“Human Machine Interface”** icon and select **“All Human Machine Interface”**.

> Specifications > Dimensions > References
 > Curves > Links to user guides and CAD files

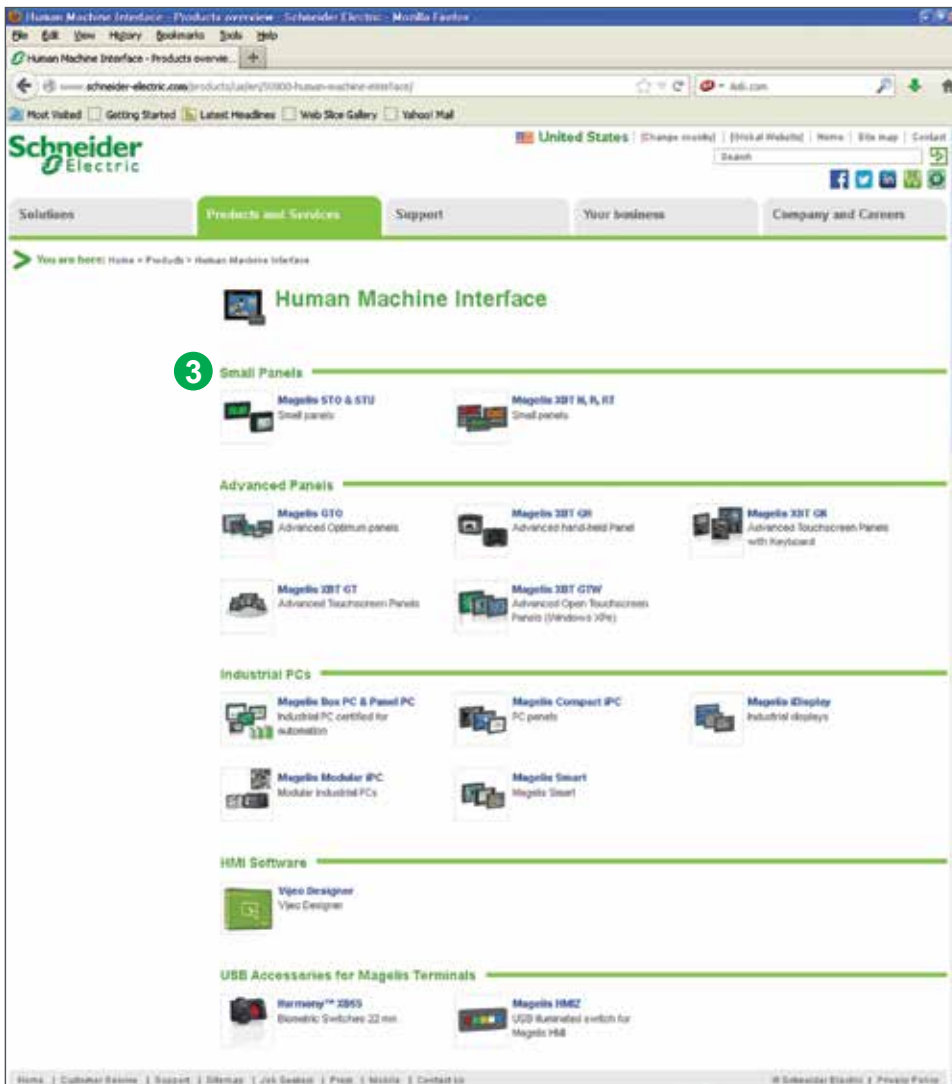

3 On the “Human Machine Interface” page, select the HMI Solution that’s right for you. Choose from **Small Panels**, **Advanced Panels**, **Industrial PCs**, **HMI Software** and **USB Accessories for Magelis Terminals**.

4 Each Magelis product offer has its own product page, complete with “Product Information” tabs, including: **“Product Selector”**, **“Documents & Downloads”**, **“Additional Links”** and **“Support”**.

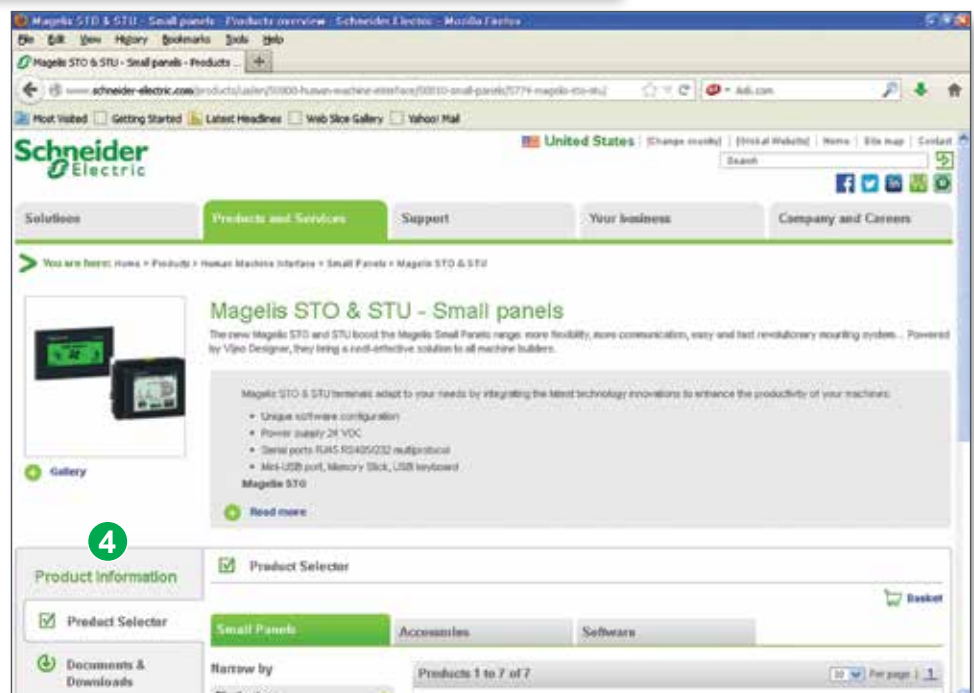



*Magis color touch screen terminals HMI GTO●●●0
in 5 sizes from 3.5" to 12.1" (standard version)*



*Magis color touch screen terminals HMI GTO●●●5
in 3 sizes from 5.7" to 12.1" ("Stainless Steel" version)*

1.1 - Architectures and connections to automation systems

■ Overview 1/2

1.2 - Magelis™ Small Panels

Selection guide 1/4

- Magelis STO and STU Small Panels
 - Introduction 1/6
 - Magelis STO 3.4" Small Panels with touch screen 1/8
 - Magelis STU 3.5" and 5.7" Small Panels with touch screen 1/9
- Magelis XBT N, XBT R, and XBT RT Small Panels
 - Introduction 1/12
 - Magelis XBT N Small Panels 1/15
 - Magelis XBT R Small Panels 1/16
 - Magelis XBT RT Small Panels 1/17
 - Equivalent product table for Magelis XBT P and XBT R 1/20
- Separate components for Magelis STO / STU and XBT N / XBT R / XBT RT... 1/23

1.3 - Magelis Advanced Panels

Selection guide for Optimum Advanced Panels 1/28

Selection guide for Standard Advanced Panels 1/30

- Optimum Advanced Panels
 - Introduction 1/34
 - Magelis GTO: 3.5", 5.7", 7" wide, 7.5", 10.4", 12.1" 1/38
- Standard Advanced Panels
 - Introduction 1/44
 - Magelis XBT GT Advanced Panels: 5.7", 7.5", 10.4", 12.1", 15" 1/48
 - Magelis XBT GK Advanced Panels: 5.7", 10.4" 1/52
 - Magelis XBT GTW Advanced Panels: 10.4", 12", 15" 1/54
 - Magelis XBT GH Advanced Panels: 5.7" 1/56
- Separate components 1/61
- Connection system 1/70
- Equivalent product tables 1/74

1.4 - USB accessories for HMI terminals

- Overview 1/75
- Harmony™ XVGU USB Tower Lights 1/76
- Harmony XB5S Biometric USB Switches 1/80
- Magelis HMIZ Illuminated USB Switches 1/82

Introduction

Magelis™ operator dialog terminals communicate with automation system equipment:

- Via serial link
- By means of integration into an Ethernet TCP/IP architecture

Communication via serial link

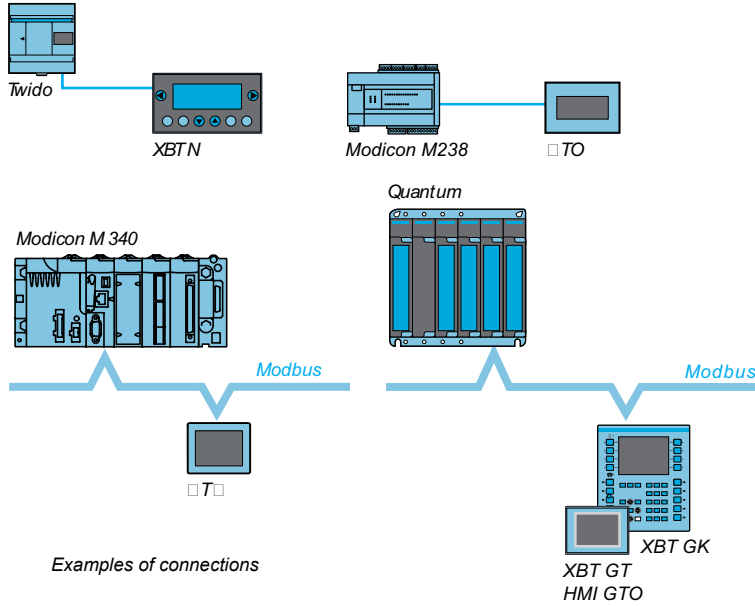

All Magelis terminals feature an integrated RS 232 C or RS 422/485 asynchronous serial link.

Use of the Uni-TE or Modbus protocol makes it easy to set up communication with Schneider Electric PLCs.

Third-party protocols enable connection to PLCs offered by major manufacturers on the market:

- DF1, DH485 for Allen-Bradley PLCs
- SysmacWay for Omron PLCs
- MPI/PPI for Siemens Simatic S7 PLCs
- Mitsubishi Melsec FX PLC

Introduction (continued)

Integration into an architecture with Ethernet TCP/IP network

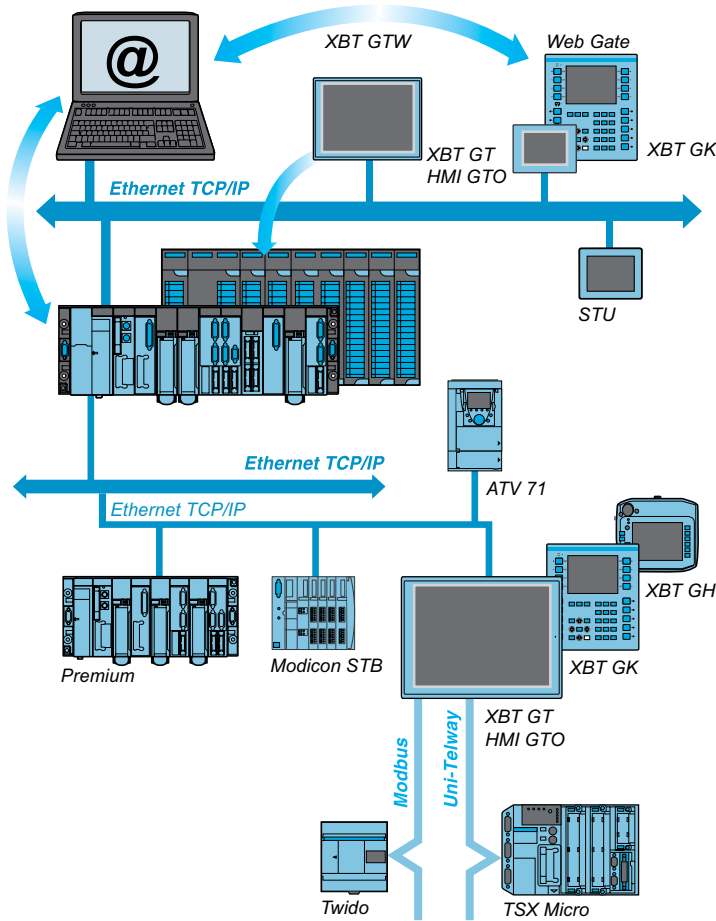

Automation platforms provide transparent routing of Uni-TE or Modbus messages from a TCP/IP network to a Uni-TE or Modbus network and vice versa.

The various services offered for the terminals are:

- **Modbus TCP/IP messaging** (for XBT GK, XBT GH, XBT GTW, XBT GT and HMI GTO, access with Ethernet TCP/IP Modbus protocol)
- **Browse function** with XBT GTW or standard PC
- **Web Gate function:** Diagnostics to remotely control the application
- **FTP server:** Transfer of data files with the terminal
- **Data Sharing function:** Data exchange on Ethernet between 8 terminals (maximum)
- **E-mail function**

Applications

Display of graphic pages

Type of terminal

Small Panels with touch screen



Display	Type
	Capacity

Monochrome STN LCD (200 x 80 pixels), backlight - Green, orange and red, or - White, pink and red	Color QVGA TFT LCD (320 x 240 pixels)	
3.4" (monochrome)	3.5" (color)	5.7" (color)

Data entry

Via touch screen

Memory capacity	Application
	Expansion

16 MB Flash
–

Functions	Maximum number of pages
	Variables per page
	Reintroduction of variables
	Recipes
	Curves
	Alarm logs
	Real-time clock
	Alarm relay
	Buzzer

Limited by internal FLASH EPROM memory capacity
Unlimited
Alphanumeric, bitmap, bargraph, gauge, curves, buttons, LEDs
32 groups of 64 recipes
Yes, with log
Yes
Access to the PLC real-time clock
–
Yes

Communication	Asynchronous serial link
	Downloadable protocols
	Printer link
	USB ports
	Networks

RS 232C/RS 485 (1) RS 232C using Zelio protocol (2)	RS 232C/RS 485
Uni-TE, Modbus and for PLC brands: Allen-Bradley, Omron, Mitsubishi, Siemens	
USB for serial or parallel printer	
1 host type A and 1 device type mini-B	
1 Ethernet TCP/IP port (10BASE-T/100BASE-TX) (3)	1 Ethernet TCP/IP port (10BASE-T/100BASE-TX)

Development software
Operating system

Vijeo Designer (on Windows XP Professional and Windows 7 Business 32-bit and 64-bit)
Magelis



References

HMI STO 5●● **HMI STU 655** **HMI STU 855**

Page

1/10

(1) Only HMI STO 511/512.
(2) Only HMI STO 501.
(3) Only HMI STO 531/532.

Display of text messages and/or semi-graphic pages		Display of text messages and/or semi-graphic pages Control and configuration of data	
Small Panels with keypad		Small Panels with keypad	
Small Panels with keypad		Small Panels with touch screen and keypad	
			
Green backlit monochrome LCD, height 5.5 mm or Green, orange or red backlit monochrome LCD, height 4.34 to 17.36 mm		Green, orange or red backlit monochrome LCD, height 4.34 to 17.36 mm	
2 lines of 20 characters or 1 to 4 lines of 5 to 20 characters (monochrome)		1 to 4 lines of 5 to 20 characters (monochrome)	
Via keypad with 8 keys (4 customizable)		Via keypad with ■ 12 function keys or numeric entry (depending on context) ■ 8 service keys	
512 KB Flash		512 KB Flash EPROM	
128/200 application pages 256 alarm pages 40 to 50		128/200 application pages 256 alarm pages 40 to 50, bargraph, buttons, LEDs	
Alphanumeric		Alphanumeric, bargraph, buttons, LEDs	
Yes		Yes	
Yes (5)		Yes	
Access to the PLC real-time clock		Access to the PLC real-time clock	
-		Yes (4)	
RS 232C/RS 485			
Uni-TE, Modbus and for PLC brands: Allen-Bradley, Omron, Mitsubishi, Siemens			
RS 232C serial link (5)			
-			
-			
Vijeo Designer Lite (on Windows 2000 Professional, Windows XP Professional and Windows Vista Business 32-bit)			
Magelis			

XBT N ●●●●	XBT R ●●●	XBT RT ●●●
1/18	1/19	1/23

(4) Only XBT RT511.
(5) Depending on model.



Magelis STO 3.4" Small Panel



Magelis STU 3.5" Small Panel



Magelis STU 5.7" Small Panel



Exploded view of Magelis STU Small Panel: Simple installation using 22 mm diameter hole

Introduction

The Magelis Small Panel product offer includes the following touch screen terminals:

- Magelis STO, with 3.4" monochrome screen, available with 2 different types of backlighting:
 - Green, orange, red
 - White, pink, red
- Magelis STU, with 3.5" and 5.7" TFT color screens.

Operation

The features of Magelis STO and STU terminals draw on key technological innovations:

- All Magelis STO and STU models are equipped with:
 - 2 USB V2.0 ports for data transfer
- Magelis STU and STO 531/532 models feature:
 - 1 RJ45 port, enabling integration of an Ethernet TCP/IP network and the use of the services associated with this (in particular, the Web Gate function)
- The Magelis STO 501 model features:
 - 1 RS 232C serial link port (9-way removable screw terminal block), enabling direct communication with the Zelio Logic SR2/SR3 range of controllers (see page 1/7)

No panel cut-out required to install Magelis STU models

No panel cut-out is required to install a Magelis STU Small Panel. All you need to do is drill a hole measuring 22 mm in diameter - just as if you were installing a push button.

The front module (comprising the screen) is connected to the rear module (comprising the terminals and connectors). The two modules are mounted together via a hole measuring 22 mm in diameter.



Display of a video sequence

Configuration

Magelis STO/STU terminals can be configured using Vijeo Designer software in a Windows XP Professional or Windows 7 Business (32-bit and 64-bit) environment.

Vijeo Designer software boasts an advanced user interface with many configurable windows, enabling operator dialog projects to be developed quickly and easily.

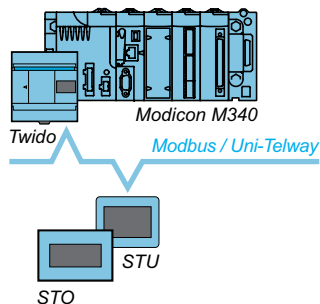

Example of serial link architecture

Communication

Magelis STO/STU terminals communicate with PLCs via an integrated serial link, using the following communication protocols:

- **Schneider Electric** (Uni-TE, Modbus)
- **Third-party**: Mitsubishi Electric, Omron, Allen-Bradley and Siemens

The Magelis STO 501 terminal is dedicated exclusively to communication with Zelio Logic SR2/SR3 range controllers. It communicates with these controllers via a direct connection cable SR2 CBL 09 (see page 1/25), using Zelio protocol, which is included in Vijeo Designer V6.1.

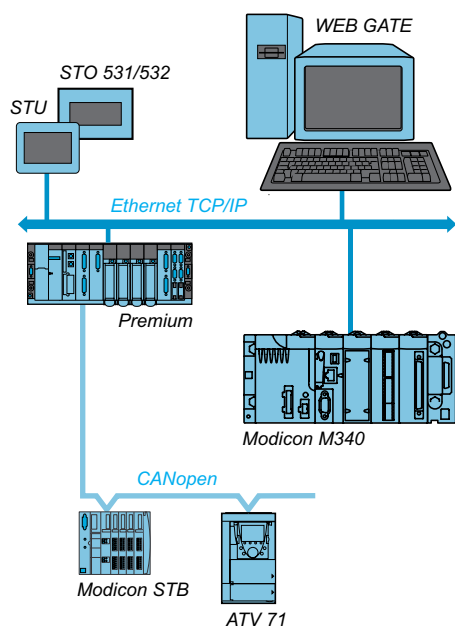

Example of Ethernet TCP/IP network architecture

Magelis STU and STO 531/532 terminals are connected on Ethernet TCP/IP networks via Modbus TCP or a third-party protocol.

1

Description

Magelis™ STO 3.4" Small Panels

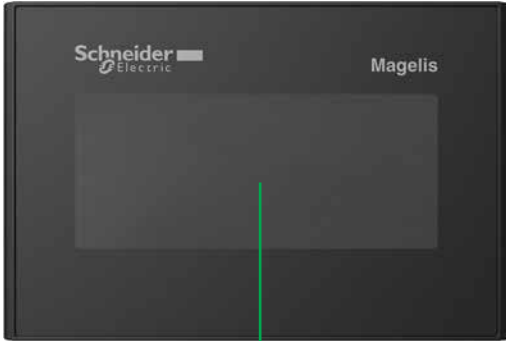

Front panel

The front panels of Magelis™ STO Small Panels include:

- 1 Touch screen for displaying synoptic views (3.4" backlit monochrome) with:
 - Green, orange or red backlighting for STO 511, STO 531 and STO 501 terminals
 - White orange or red backlighting for STO 512 and STO 532 terminals

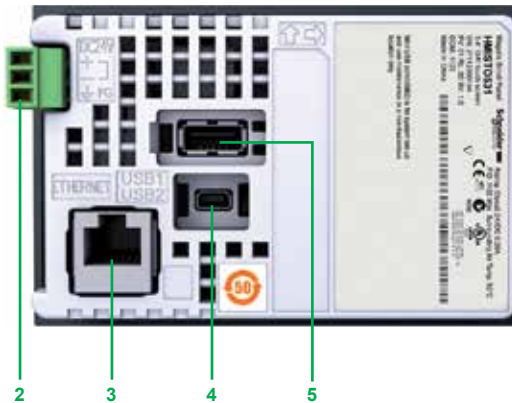

Magelis™ STO 511/512/531/532 Small Panels

Rear panel

Magelis STO Small Panels have the following on the rear panel:

- 2 Removable screw terminal block for 24 V $\bar{\text{DC}}$ power supply
- 3 Connector for connecting to PLCs or controllers, depending on the terminal model:
 - Magelis STO 511/ 512: An RJ45 (COM1) connector for RS 232C or RS 485 serial link
 - Magelis STO 531/532: An RJ45 (ETHERNET) connector for Ethernet 10BASE-T/100BASE-TX link
 - Magelis STO 501: A 9-way removable screw terminal block (COM1) for RS 232C serial link using Zelio™ protocol
- 4 USB type A host connector for:
 - Connection of a peripheral device
 - Connection of a USB memory stick
 - Application transfer
- 5 USB mini-B device connector for application transfer

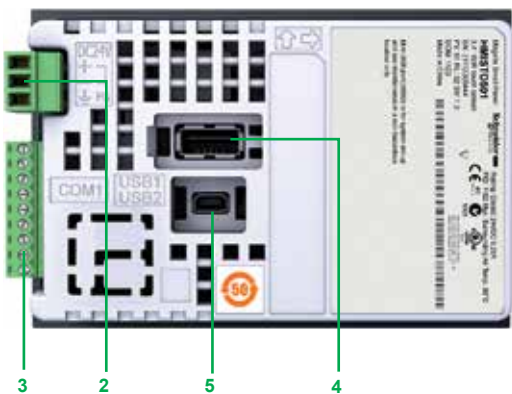

Magelis STO 501 Small Panel

Description

Magelis™ STU 3.5" and STU5.7" Small Panels

Front module

The front panels of Magelis™ STU Small Panels include, depending on the model:

- 1 Magelis STU 655: Touch screen for displaying synoptic views (3.5" color TFT)
- 2 Magelis STU 855: Touch screen for displaying synoptic views (5.7" color TFT)

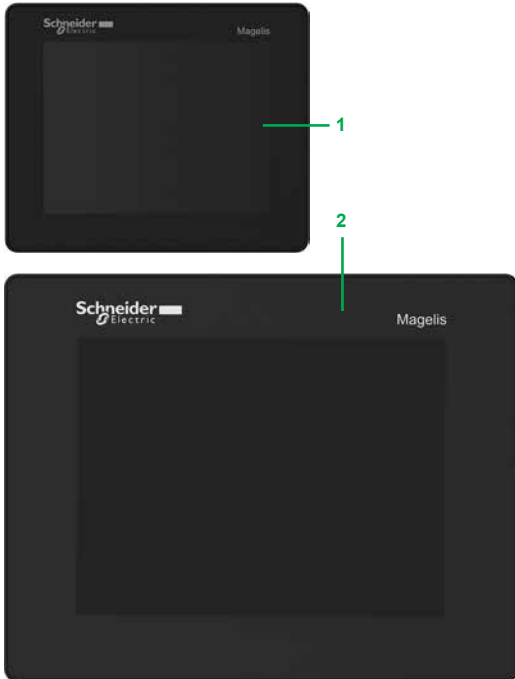

Rear of product

Magelis STU 655 and Magelis STU 855 Small Panels have the following on the rear:

- 3 Removable screw terminal block for 24 V $\bar{\text{DC}}$ power supply
- 4 RJ45 connector for RS 232C or RS 485 serial link connection to PLCs (COM1)
- 5 USB type A host connector for:
 - Connection of a peripheral device
 - Connection of a USB memory stick
 - Application transfer
- 6 USB mini-B device connector for application transfer (on the left-hand side)
- 7 RJ45 connector for the Ethernet TCP/IP 10BASE-T/100BASE-TX link

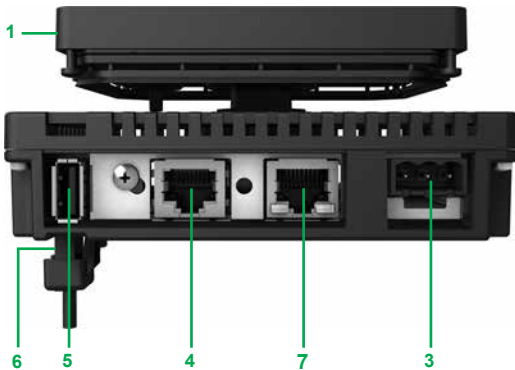

Mounting system

The Magelis STU Small Panel is made up of a front module (comprising the screen) and a rear module (comprising the CPU plus terminals and connectors). The two modules are mounted together via a hole measuring 22 mm in diameter. The mounting system contains the following elements:

- 8 Mounting nut
- 9 Seal
- 10 Anti-rotation tee (can be used as an option)
- 11 Release mechanism: simply press to separate the two modules once they have been mounted together

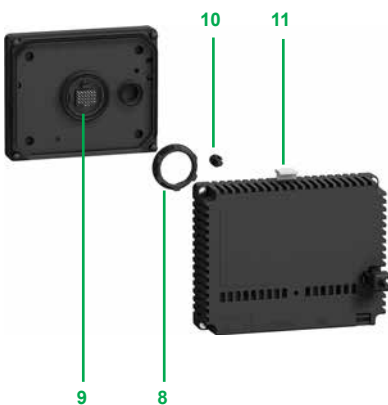

1



HMI STO 511

Magelis STO monochrome touch screen terminals

3.4" screen						
Type of screen	Number of ports	Application memory capacity	Compact Flash memory	Embedded Ethernet	Reference	Weight kg
STN Green, orange, red	1 COM1 (1) 2 USB	16 MB	No	–	HMI STO 511	1.000
	1 ETHERNET (2) 2 USB	16 MB	No	1	HMI STO 531	1.000
STN White, pink, red	1 COM1 (1) 2 USB	16 MB	No	–	HMI STO 512	1.000
	1 ETHERNET (2) 2 USB	16 MB	No	1	HMI STO 532	1.000
STN Green, orange, red	1 COM1 (1) 2 USB	16 MB	No	–	HMI STO 501	1.000



HMI STU 655

Magelis STU color touch screen terminals

Type of screen	Number of ports	Application memory capacity	Compact Flash memory	Embedded Ethernet	Reference	Weight kg
3.5" screen						
TFT	1 COM1 (1) 1 ETHERNET (2) 2 USB	16 MB	No	1	HMI STU 655	1.000



HMI STU 855

5.7" screen

TFT	1 COM1 (1) 1 ETHERNET (2) 2 USB	16 MB	No	1	HMI STU 855	–
-----	---------------------------------------	-------	----	---	-------------	---

Software

Configuration software

Description	Operating system	Reference	Weight kg
Vijeo Designer	Windows XP Professional Windows 7 Business (32-bit and 64-bit)	See page 4/13	–

(1) RS 232C or RS 485 serial link.

(2) Ethernet 10BASE-T/100BASE-TX link.

(3) RS 232C serial link using Zelio protocol, for direct connection to Zelio Logic SR2/SR3 controllers.

Separate components (1)				
Description	Description/function	Compatible with	Reference	Weight kg
Accessories kit	Contains: <ul style="list-style-type: none"> ■ Anti-rotation tee ■ USB A type clip ■ USB mini-B type clip ■ Adaptor panel for mounting on an enclosure of 1 mm in thickness 	HMI STU 655 HMI STU 855	HMI ZSU KIT	–
Protective sheets	5 peel-off sheets for protecting the screen	HMI STO 5●●	HMI ZS60	–
		HMI STU 655	HMI ZS61	–
		HMI STU 855	HMI ZS62	–
USB clip	Holds the USB A type connection in place	HMI STO 5●●	HMI ZSC LP1	–
	Holds the USB mini-B type connection in place	HMI STO 5●●	HMI ZSC LP3	–
Replacement parts (2)				
Description	Description/function	Compatible with	Reference	Weight kg
Nuts	Set of 10 nuts, 22 mm (front module of the HMI STU is mounted to the enclosure using a 22 mm nut (see page 1/6)	HMI STU 655 HMI STU 855	ZB5 AZ9 01	–
Bezel key	Enables the mounting nut to be tightened	HMI STU 655 HMI STU 855	ZB5 AZ9 05	–
Seal	Dust and damp proofs the connection between the front and rear modules of the HMI STO 5●●	HMI STO 5●●	HMI ZS50	–

(1) Non-exhaustive list: other separate components are listed beginning on page 1/24.

(2) Non-exhaustive list: other replacement parts are listed on page 1/24.

Operator dialog terminals

Magelis XBT N, XBT R Small Panels with keypad,
Magelis XBT RT Small Panels with touch screen
and keypad

1

Introduction



XBT R411

XBT N400

XBT RT511

Magelis XBT N and Magelis XBT R/RT terminals are used to display messages and variables. In addition, Magelis terminals XBT RT can display small graphic elements.

The various keys can be used to:

- Modify variables
- Control a device
- Navigate within the operator dialog application

On XBT RT terminals, the touch screen can also be used to modify variables, control devices and navigate within the dialog application.

Alarm messages can be printed out from models that have a printer port.

Operation



"Entry" customization



"Control" customization

All Magelis terminals have the same user interface:

- A configurable touch screen, on XBT RT only ("touch-sensitive" mode)
- 2 service keys (◀, ▶) configurable for contextual link or control, on XBT N/R and XBT RT ("entry"/"control" modes)
- 2 service keys (ESC, ENTER), non-configurable
- These keys are complemented by:
 - On XBT N terminals: 4 customizable service keys which can be configured as function keys ("control" mode) or service keys ("entry" mode)
 - On XBT R terminals: 4 service keys, non-configurable, and 12 function or numeric entry keys (depending on context)
 - On XBT RT terminals in "control" or "entry" mode: 4 customizable and configurable function keys 4 service keys (non-configurable)

Configuration

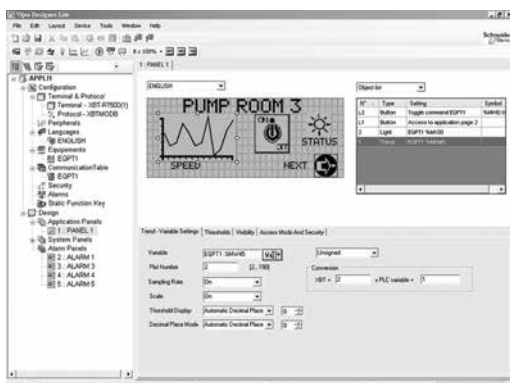

Vijeo Designer Lite

Magelis terminals can be configured using Vijeo Designer Lite software in a Windows 2000 Professional, XP Professional or Vista Business (32-bit) environment.

Vijeo Designer Lite software uses the concept of pages: each page can be viewed in its entirety. A 2, 4 or 10-line window, depending on the terminal model to be configured, is used to view the screen of this virtual terminal.

The symbol databases of TwidoSoft, PL7 and Concept applications can be imported into the Vijeo Designer Lite operator dialog application.

See page 4/4.

Communication

XBT N terminal

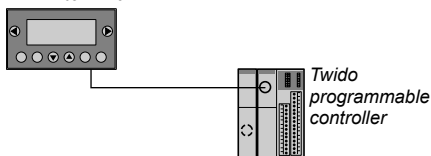

Connection example with Twido programmable controller

XBT N and XBT R/RT terminals communicate with PLCs via an integrated serial link in either point-to-point or multidrop mode, depending on the model.

The communication protocols used are those of Schneider Electric PLCs (Uni-TE, Modbus) and those of the main manufacturers on the market.

XBT N terminal

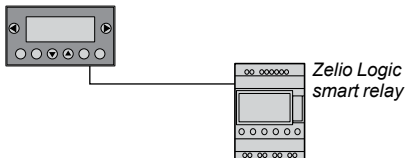

Connection example with Zelio Logic smart relay

XBT N401, XBT R411 and XBT RT 511 terminals communicate with Zelio Logic smart relays via a direct connection cable and using the Zelio protocol, which is included in Vijeo Designer Lite V1.3.

Operator dialog terminals

Magelis XBT N, XBT R Small Panels with keypad,
Magelis XBT RT Small Panels with touch screen
and keypad

Functions

On their front panel, XBT N/R/RT terminals have function keys and service keys (depending on how the keys have been configured for “control” and “entry” modes). XBT RT terminals feature a touch screen which can be configured in “touch-sensitive” operating mode.

“F” function keys

The function keys are defined for the whole application.

The number of function keys depends on the model:

- F1, F2, F3, F4 on XBT N
- F1 to F12 on XBT R
- F1 to F10 or F1 to F4 according to configuration on XBT RT

They can have the following functions:

- Accessing a page
- Impulse command
- “Toggle” command

In addition, with the XBT R terminal, if the **MOD** key is pressed, the 12 function keys become numeric entry keys **1 to 0**, **+/-** and **..**

“R” function keys for XBT RT (“entry” mode)

The R1, R2, R3 and R4 function keys on the XBT RT are defined for the pages displayed. They can be used for:

- Accessing a page
- Memorizing memory bits
- Toggling memory bits (ON/OFF)
- Resetting memory bits to 1/0

An icon can be displayed on the screen, above the **Ri** keys. This icon is defined using the Vijeo Designer Lite software.

Matrix touch screen (5 x 11 cells) for XBT RT

The touch screen can be configured to be active on XBT RT (“touch-sensitive” mode). This is used for:

- Accessing a page
- Memorizing/toggling memory bits
- Modifying a numeric field via a virtual numeric keypad

Service keys

Service keys **◀**, **ESC**, **DEL**, **▼**, **▲**, **MOD**, **ENTER** and **▶** are used to modify the parameters of the automation system.

They perform the following actions:

- ESC** Cancel an entry, suspend or stop a current action, go up one level in a menu
- DEL** Delete the character selected in entry mode
- MOD** Select the variable field in which to enter data. Enable entry in the next field, on each press, from left to right and top to bottom.
- ENTER** Confirm a selection or entry, acknowledge an alarm

The “arrow” keys are used to:

- ◀ ▶**
 - Change the page within a menu
 - Display the current alarms
 - Change a digit in a variable field in which data is being entered
 - Activate the function associated with a functional link
- ▼ ▲**
 - Move up and down within a page (XBT N40●)
 - Select the value of a digit
 - Select a value from a list of choices
 - Increment or decrement the value of a variable field

Description of XBT N terminals with keypad

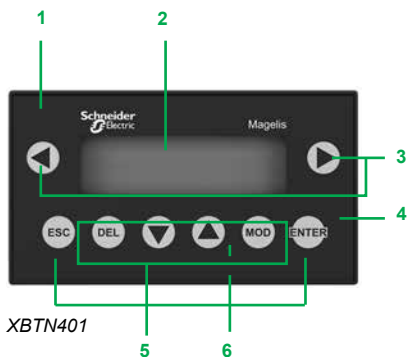
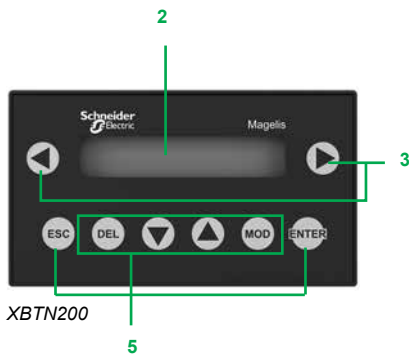

XBT N terminals include:

On the front panel

- 1 Communication monitoring lamp (model XBTN401)
- 2 Backlit ultra-bright LCD display: 122 x 32 pixels (matrix) or 2 lines of 20 characters (alphanumeric)
- 3 Two non-customizable command or contextual link keys
- 4 "Alarm" LED (model XBTN401)
- 5 Six service keys, four of which (framed) can be configured as function keys and customized using labels
- 6 Two system LEDs in entry mode or four LEDs that can be controlled by the PLC in control mode (model XBTN401)

Supplied separately

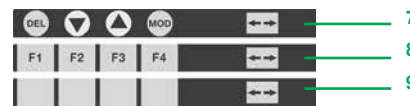

- A sheet of labels including:
 - 7 "Entry" label
 - 8 "Control" label (F1, F2, F3 and F4)
 - 9 Four customizable blank labels
- Two spring clips for mounting the terminal on the panel

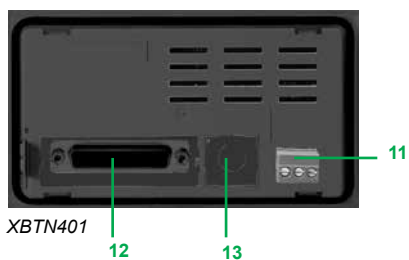
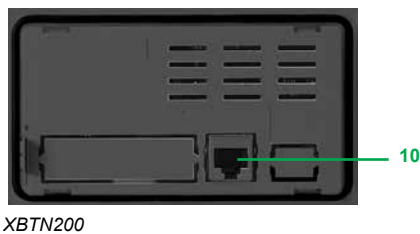

On the rear panel

XBTN200/N400 terminals

- 10 RJ45 connector for point-to-point serial link and connection for 5 V $\overline{\text{DC}}$ power supply (supplied by PLC)

XBTN401/N410/NU400 terminals

- 11 Removable screw terminal block for 24 V $\overline{\text{DC}}$ external power supply
- 12 25-way female SUB-D connector for multidrop serial link
- 13 8-way female mini-DIN connector for serial printer link (model XBTN401)

Description of XBT R terminals with keypad

1

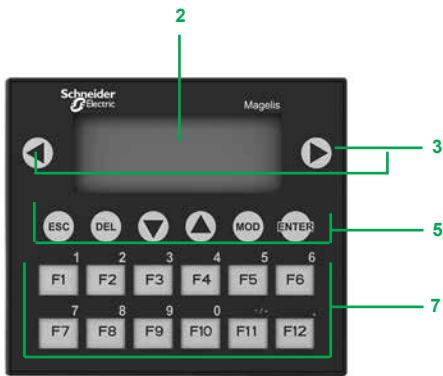

XBT R400

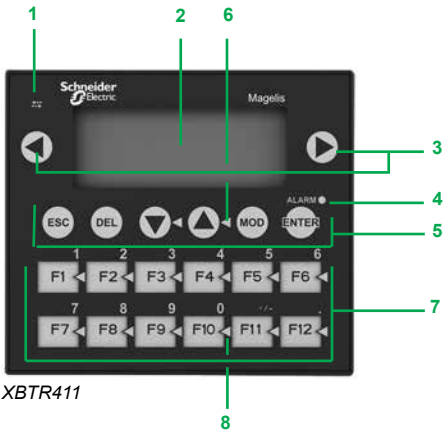

XBT R411

XBT R terminals include:

On the front panel:

- 1 Communication monitoring LED (model XBTR411)
- 2 Backlit ultra-bright LCD display: 122 x 32 pixels (matrix)
- 3 Two non-customizable command or contextual link keys
- 4 "Alarm" lamp (model XBTR411)
- 5 Six service keys
- 6 Two system LEDs (model XBTR411)
- 7 Twelve function or numeric entry keys (depending on context), customizable using labels
- 8 Twelve lamps (for model XBTR411), that can be controlled by the PLC

Supplied separately:

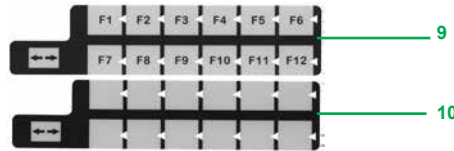

- A sheet of labels including:
 - 9 "Control" label (F1 to F12)
 - 10 Two customizable blank labels
- Four spring clips for mounting the terminal on the panel

On the rear panel

XBT R400 terminals

- 11 RJ45 connector for point-to-point serial link and connection for 5 V c power supply (supplied by PLC)

XBT R410/R411 terminals

- 12 Removable screw terminal block for 24 V $\bar{\text{c}}$ external power supply
- 13 25-way female SUB-D connector for multidrop serial link
- 14 8-way female mini-DIN connector for serial printer link (model XBTR411)

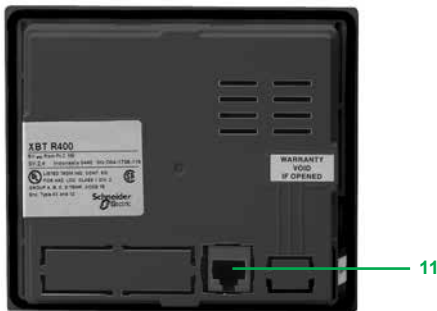

XBT R400



XBT R411

Description of XBT RT terminals with touch screen and keypad

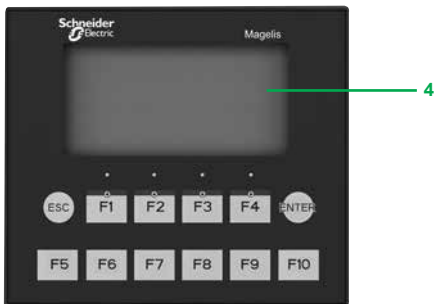
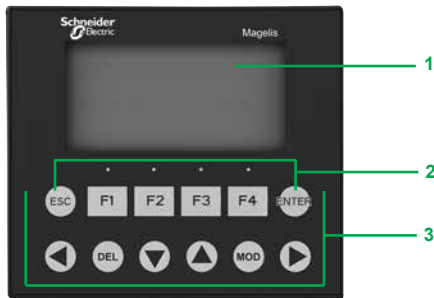

XBTRT500

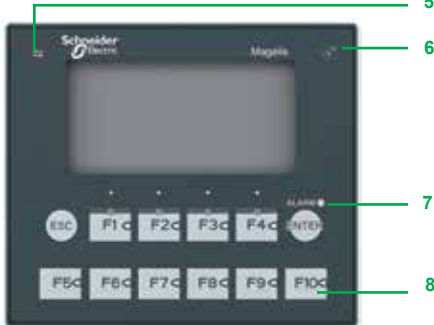

XBTRT511



XBTRT500



XBTRT511

XBT RT terminals include:

On the front panel:

XBT RT terminals

- 1 Ultra-bright backlit LCD display: 198 x 80 pixels (matrix)
- 2 Two service keys
- 3 Function or service keys which can be configured and customized using labels
- 4 Matrix touch screen (11 x 5 cells)

XBT RT511 terminal

- 5 Communication monitoring LED
- 6 "Touch panel or keys being pressed" LED
- 7 "Alarm" LED
- 8 Six or ten lamps, depending on the configuration, that can be controlled by the PLC

Supplied separately:

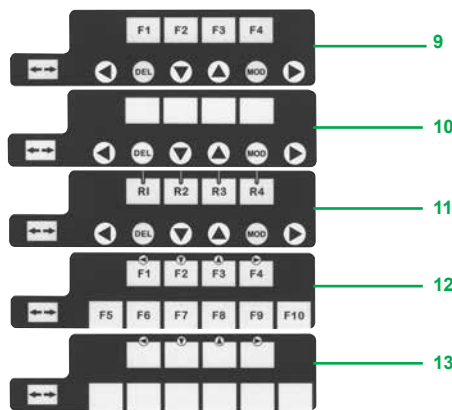

■ 2 sheets of labels including:

- 9 Configurable "control" label (F1 to F4)
- 10 Customizable blank "control" label
- 11 "Entry" label (R1 to R4)
- 12 "Touch-sensitive" label (F1 to F10)
- 13 Two customizable blank "touch-sensitive" labels

On the rear panel

XBT RT500 terminal

- 14 RJ45 connector for point-to-point serial link and connection for 5 V c power supply (supplied by PLC)

XBT RT511 terminal

- 15 Removable screw terminal block for 24 V c external power supply
- 16 RJ45 connector for multidrop serial link
- 17 8-way female mini-DIN connector for serial printer link

1



XBT N200



XBT N400/N410/NU400



XBT N401

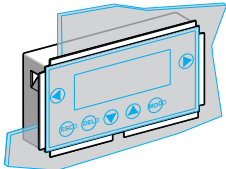

XBTZN01

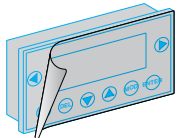

XBTZN02

Magelis XBT N Small Panels with keypad

Downloadable exchange protocol	Compatible PLCs	Supply voltage	Type of screen	Reference	Weight kg
Terminal with 2 lines of 20 characters (with alphanumeric screen)					
Uni-TE, Modbus	Twido, Nano, TSX Micro, Premium, Modicon M340	5 V $\overline{\text{---}}$ via PLC terminal port	Green backlit LCD	XBT N200	0.360
Terminals with 4 lines of 20 characters (with matrix screen)					
Uni-TE, Modbus	Twido (1), Nano, TSX Micro, Premium, Modicon M340	5 V $\overline{\text{---}}$ via PLC terminal port	Green backlit LCD (122 x 32 pixels)	XBT N400	0.360
	Twido (1), Nano, TSX Micro, Premium, TSX series 7, Momentum, Quantum Other Modbus slave devices, Modicon M340	24 V $\overline{\text{---}}$ external supply	Green backlit LCD (122 x 32 pixels)	XBT N410	0.380
Uni-TE, Modbus	Twido (1), Nano, TSX Micro, Premium, TSX series 7, Momentum, Quantum Other Modbus slave devices, Modicon M340	24 V $\overline{\text{---}}$ external supply	Green, orange and red backlit LCD (2) (122 x 32 pixels)	XBT N401	0.380
Zelio	Zelio Logic				
Modbus	TeSys model U motor starters (3) Altivar drives	24 V $\overline{\text{---}}$ external supply	Green backlit LCD (122 x 32 pixels)	XBT NU400	0.380

Software

Description	Operating system	Reference
Configuration software Vijeo Designer Lite	Windows 2000 Professional, XP Professional and Vista Business (32-bit)	See page 4/7

Accessories (4)

Description	Details	For use with	Reference	Weight kg
Accessory for flush mounting	Kit for applications requiring a higher degree of protection or customization of the control desk, using flat inner insulation (not included)	All XBT N	XBT ZN01	–
Protective sheets	10 peel-off sheets	All XBT N	XBT ZN02	–
Sheets of re-usable labels	10 sheets of 6 labels	XBT N200/400 XBT N401 XBT NU400	XBL YN00 XBL YN01	–
Mechanical adaptors for substitution of XBT H	From XBT H0●2●1/H0●1010 to XBT N410 From XBT H811050 to XBT N410	–	XBT ZNCO	–

Connection cables and accessories (5)

Description	Compatibility	Types of connector	Physical link	Protocol	Length	Reference	Weight kg
Adaptor cable	XBT N200 XBT N400 (6)	RJ45-RJ45	RS 232C RS 485	Modbus, Uni-TE	0.1 m	XBT ZN999	–

(1) Connection via integrated port or optional serial port on the Twido programmable controller.

(2) Also available with 4 signalling LEDs.

(3) Factory preloaded application for monitoring, diagnostics and adjustment of 1 to 8 TeSys model U motor starters.

(4) For other accessories, see page 1/24.

(5) For other connection cables and accessories, see pages 1/24 to 1/27.

(6) Adaptor **XBT ZN999** is designed for use with **XBT N200/N400** terminals (new version) and cable **XBT Z978** (replaced by **XBT Z9780**), or with **XBT N200/N400** terminals (old version) and the new **XBT Z9780** cable.

Note: The new version of the XBT N terminal can be distinguished from the old version by its exterior, as it features the Schneider Electric logo on the front panel (on the left above the screen).



XBT R400/R410



XBT R411

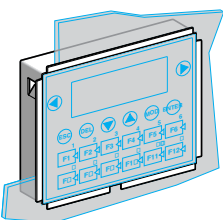

XBTZR01

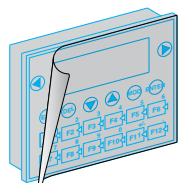

XBTZR02

Magelis XBT R Small Panels with keypad

Downloadable exchange protocol	Compatible PLCs	Supply voltage	Type of screen	Reference	Weight kg
Terminals with 4 lines of 20 characters (with matrix screen)					
Uni-TE, Modbus	Twido, Nano, TSX Micro, Premium, Modicon M340	5 V $\overline{\text{---}}$ via PLC terminal port	Green backlit LCD (122 x 32 pixels)	XBT R400	0.550
	Twido (1), Nano, TSX Micro, Premium, TSX series 7, Momentum, Quantum Other Modbus slave devices, Modicon M340	24 V $\overline{\text{---}}$ external supply	Green backlit LCD (122 x 32 pixels)	XBT R410	0.550
Uni-TE, Modbus	Twido (1), Nano, TSX Micro, Premium, TSX series 7, Momentum, Quantum Other Modbus slave devices, Modicon M340	24 V $\overline{\text{---}}$ external supply	Green, orange and red backlit LCD (2) (122 x 32 pixels)	XBT R411	0.550
Zelio	Zelio Logic				

Software

Description	Operating system	Reference	
Configuration software Vijeo Designer Lite	Windows 2000 Professional, XP Professional and Vista Business (32-bit)	See page 4/7	–

Accessories (3)

Description	Details	For use with	Reference	Weight kg
Accessory for flush mounting	Kit for applications requiring a higher degree of protection or customization of the control desk, using flat inner insulation (not included)	All XBT R	XBT ZR01	–
Protective sheets	10 peel-off sheets	All XBT R	XBT ZR02	–
Sheets of re-usable labels	10 sheets of 6 labels	XBT R400/R410	XBL YR00	–
		XBT R411	XBL YR01	–
Mechanical adaptor for substitution of XBT P	From XBT P01●010/P02●010 to XBT R410	–	XBT ZRCO	–
	From XBT P02●110 to XBT R411			–

(1) Connection via integrated port or optional serial port on the Twido PLC.

(2) Also available with 16 signalling LEDs.

(3) For other accessories, see pages 1/24 to 1/27.

1

Equivalent product table - XBT P to XBT R terminals

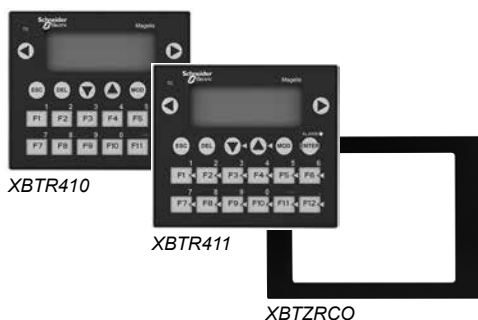

Old range XBT P	XBT R range	Mechanical adaptor (1)
XBT P011010	XBT R410	XBT ZRCO
XBT P012010	XBT R410	XBT ZRCO
XBT P021010	XBT R410	XBT ZRCO
XBT P021110	XBT R411	XBT ZRCO
XBT P022010	XBT R410	XBT ZRCO
XBT P022110	XBT R411	XBT ZRCO

(1) Mechanical adaptor for mounting XBT R terminal in place of the substituted XBT P terminal.

Equivalent product table - Cables for connection to Schneider Electric products

Summary		
Old range XBT P	XBT R range	
Type of link	Type of link	Cable
Serial port, 25-way SUB-D RS 232C/RS 485/RS 422	Serial port, 25-way SUB-D RS 232C/RS 485	Existing cable (see below)
Printer port, 9-way SUB-D (model XBT P02110)	Printer port, 8-way mini-DIN (model XBT R411)	XBT Z926 (new cable)

Equivalent product table - Cables

Old range XBT P				XBT R range			
Type of terminal	Type of link	Length	Reference	Type of terminal	Type of link	Length	Reference
Twido, Modicon TSX Micro, Modicon Premium , 8-way mini-DIN terminal port, Uni-TE (V1/V2), Modbus protocol							
XBT P	RS 485 serial port, 25-way SUB-D	2.5 m	XBT Z968	XBT R	RS 485 serial port, 25-way SUB-D	2.5 m	XBT Z968
		5 m	XBT Z9681			5 m	XBT Z9681
		2.5 m, angled	XBT Z9680			2.5 m, angled	XBT Z9680
Modicon Premium with TSX SCY 2160 , 25-way female SUB-D connector, Uni-TE (V1/V2) protocol							
XBT P	RS 485 serial port, 25-way SUB-D	2.5 m	XBT Z918	XBT R	RS 485 serial port, 25-way SUB-D	2.5 m	XBT Z918
Modicon Quantum , 9-way male SUB-D connector, Modbus protocol							
XBT P	RS 232C serial port, 25-way SUB-D	2.5 m	XBT Z9710	XBT R	RS 232C serial port, 25-way SUB-D	2.5 m	XBT Z9710
Advantys STB , HE13 connector (network interface module, NIM), Modbus protocol							
XBT P	RS 232C serial port, 25-way SUB-D	2.5 m	XBT Z988	XBT R	RS 232C serial port, 25-way SUB-D	2.5 m	XBT Z988
Modicon Momentum M1 , RJ45 connector (port 1), Modbus protocol							
XBT P	RS 232C serial port, 25-way SUB-D	2.5 m	XBT Z9711	XBT R	RS 232C serial port, 25-way SUB-D	2.5 m	XBT Z9711
TeSys U starters, ATV 31/61/71 drives, ATS 48 starters , RJ45 connector, Modbus protocol							
XBT P	RS 485 serial port, 25-way SUB-D	2.5 m	XBT Z938	XBT R	RS 485 serial port, 25-way SUB-D	2.5 m	XBT Z938
LT6 P multifunction protection relay , 9-way female SUB-D connector, Modbus protocol							
XBT P	RS 232C serial port, 25-way SUB-D	2.5 m	XBT Z938	XBT R	RS 232C serial port, 25-way SUB-D	2.5 m	XBT Z938

Equivalent product table - Cables for application transfer to PC and printer cable

Old range XBT P				XBT R range			
Type of terminal	Type of link	Length	Reference	Type of terminal	Type of link	Length	Reference
Cables for application transfer to PC							
XBT P	25-way SUB-D/ 9-way SUB-D	2.5 m	XBT Z915	XBT R	25-way SUB-D/ 9-way SUB-D	2.5 m	XBT Z915
	25-way SUB-D/USB	2.5 m	XBT Z915 + adaptor SR2 CBL 06		25-way SUB-D/ USB	2.5 m	XBT Z915 + adaptor SR2 CBL 06
Serial printer cable							
XBT P	Printer port, 9-way SUB-D	2.5 m	XBT Z936	XBT R	Printer port, mini-DIN 8	2.5 m	XBT Z926

Compatibility table - Downloadable third-party protocols

PLC brand	Compatibility		Protocol name
	XBT P	XBT R	
Allen-Bradley	■	■	DF1/DH485
GE Fanuc	■	–	SNPX
Omron	■	■ (on RS 232)	Sysmacway
Siemens	■	■	PPI
	■	–	AS511, 3964R, MPI

Equivalent product table - Cables for connection to third-party PLCs

Omron CQM1 & CVM1, Sysmac PLCs

Old range XBT P					XBT R range				
Type of terminal	Type of connector	Serial port	Length	Reference	Type of terminal	Type of connector	Serial port	Length	Reference
Sysmacway protocol									
XBT P	25-way SUB-D/ 9-way SUB-D	RS 232	2.5 m	XBT Z9740	XBT R	25-way SUB-D/ 9-way SUB-D	RS 232C	2.5 m	XBT Z9740

Rockwell Automation, Allen-Bradley PLCs

Old range XBT P					XBT R range				
Type of terminal	Type of connector	Serial port	Length	Reference	Type of terminal	Type of connector	Serial port	Length	Reference
DF1 protocol									
XBT P	25-way SUB-D/ 9-way SUB-D	RS 232C	2.5 m	XBT Z9730	XBT R	25-way SUB-D/ 9-way SUB-D	RS 232C	2.5 m	XBT Z9730
AP SLC5					AP SLC5				
XBT P	25-way SUB-D/ 25-way SUB-D	RS 232C	2.5 m	XBT Z9720	XBT R	25-way SUB-D/ 25-way SUB	RS 232C	2.5 m	XBT Z9720
AP PLC5					AP PLC5				
XBT P	25-way SUB-D/ Micro-logix 1000	RS 232C	2.5 m	XBT Z9731	XBT R	25-way SUB-D/ Micro-logix 1000	RS 232C	2.5 m	XBT Z9731
AP					AP Micro-logix				
Micro-logix									
DH 485 point-to-point protocol									
XBT P	25-way SUB-D/ Micro-logix 1000	RS 232C	2.5 m	XBT Z9732	XBT R	25-way SUB-D/ Micro-logix 1000	RS 232C	2.5 m	XBT Z9732
AP					AP Micro-logix				
Micro-logix									
DH 485 multidrop protocol									
XBT P	25-way SUB-D/ 9-way SUB-D	RS 232C	2.5 m	XBT Z9730	XBT R	25-way SUB-D/ Micro-logix 1000	RS 232C	2.5 m	XBT Z9732
SLC500					AP SLC5 with				
with AIC					AIC gateway				
gateway									

Siemens, Simatic PLCs

Old range XBT P					XBT R range				
Type of terminal	Type of connector	Serial port	Length	Reference	Type of terminal	Type of connector	Serial port	Length	Reference
PPI (S7) protocol									
XBT P	25-way SUB-D/ 9-way SUB-D	RS 485	2.5 m	XBT Z9721	XBT R	25-way SUB-D/ 9-way SUB-D	RS 485	2.5 m	XBT Z9721

Equivalent product table - Connection to Uni-Telway serial link

Old range XBT P					XBT R range				
Type of terminal	Type of connector	Serial port	Length	Reference	Type of terminal	Type of connector	Serial port	Length	Reference
On subscriber socket TSX SCA 62									
XBT P	25-way SUB-D/ 15-way SUB-D	RS 485	1.8 m	XBT Z908	XBT R	25-way SUB-D/ 15-way SUB	RS 485	1.8 m	XBT Z908
On connection box TSX P ACC 01									
XBT P	25-way SUB-D/ 8-way mini-DIN	RS 485	2.5 m	XBT Z968	XBT R	25-way SUB-D/ 8-way mini-DIN	RS 485	2.5 m	XBT Z968
			5 m	XBT Z9681				5 m	XBT Z9681

Equivalent product table - Connection to Modbus serial link

Old range XBT P					XBT R range				
Type of terminal	Type of connector	Serial port	Length	Reference	Type of terminal	Type of connector	Serial port	Length	Reference
On subscriber socket TSX SCA 64									
XBT P	25-way SUB-D/ 15-way SUB-D	RS 485/ RS422	1.8 m	XBT Z908	XBT R	25-way SUB-D/ 15-way SUB-D	RS 485/ RS 422	1.8 m	XBT Z908
On 8-port splitter box LU9 GC3									
XBT P	25-way SUB-D/RJ45	RS 485	2.5 m	XBT Z938	XBT R	25-way SUB-D/RJ45	RS 485	2.5 m	XBT Z938

1



XBT RT500



XBT RT511

Magelis XBT RT Small Panels with touch screen and keypad

Downloadable exchange protocol	Compatible PLCs	Supply voltage	Type of screen	Reference	Weight kg
Terminal with 10 lines of 30 characters (with matrix screen)					
Uni-TE, Modbus	Twido, Nano, TSX Micro, Premium, Modicon M340	5 V $\overline{\text{---}}$ via PLC terminal port	Green backlit LCD (198 x 80 pixels)	XBT RT500	0.550
Uni-TE, Modbus	Twido, Nano, TSX Micro, Premium, TSX Series 7, Momentum, Quantum, other Modbus slave devices, Modicon M340	24 V $\overline{\text{---}}$ external supply	Green, orange or red backlit LCD (198 x 80 pixels) + 13 signalling LEDs + buzzer	XBT RT511	–
Zelio	Zelio Logic				

Software

Description	Operating system	Reference
Configuration software Vijeo Designer Lite	Windows 2000 Professional, XP Professional and Vista Business (32-bit)	See page 4/7

Operator dialog terminals

Separate components for Magelis XBT N, XBT R, XBT RT and Magelis STO and STU Small Panels

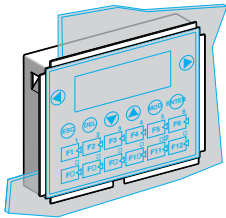

XBTZR01

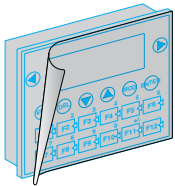

XBTZR02

Accessories (1)

Description	Details	For use with	Reference	Weight kg
Accessory for flush mounting	Kit for applications requiring a higher degree of protection or customization of the control desk, using flat inner insulation (not included)	All XBT RT	XBT ZR01	–
Protective sheets	10 peel-off sheets	All XBT RT	XBT ZR02	–
Sheets of re-usable labels	10 sheets of 6 labels	XBT RT500	XBL YRT00	–
		XBT RT511	XBL YRT01	–
Mechanical adaptor for substitution XBT P/PM		–	XBT ZRCO	–

Description	Compatibility	Type of connector	Physical link	Protocol	Length m	Reference	Weight kg
Downloading adaptor (2)	XBT RT500	RJ45-RJ45	RS 485	Modbus	0.2	XBT ZRT 999	–

(1) For other accessories, see page 1/24.

For other connection cables and accessories, see pages 1/24 to 1/27.

(2) Also included in kit XBT Z 945.

Operator dialog terminals

Separate components for Magelis XBT N, XBT R, XBT RT and Magelis STO and STU Small Panels

1

Accessories					
Type	Compatibility	Sold in lots of	Unit reference	Weight	kg
External 5 V adaptor (1)	XBT N200/N400 XBT R400 XBT RT500	1	XBT ZRT PW	–	
XBT RT download adaptor (2)	XBT RT500/511	1	XBT ZRT999	–	
Spring clips (replacement parts)	XBT N/R/RT/GT HMI STO	12	XBT Z3002	0.200	
Power supply connector (replacement parts)	XBT N/R/RT	10	XBT Z3004	0.200	
	HMI STO	5	HMI ZS PWO	–	
	HMI STU	5	XBT ZG PWS1	–	

Connection to PCs and printers					
Used	Compatibility	Length	Peripheral side connector	Reference	Weight kg
Cables for PC connection, RS 232C serial port	XBT N401/N410/NU400 XBT R410/R411	2.5 m	9-way male SUB-D	XBT Z915	0.200
	XBT N200/N400/R400 XBT RT500/RT511	2.5 m	9-way male SUB-D and mini-DIN (PS/2)	XBT Z945	0.200
USB cable for PC connection (3)	XBT N/R/RT	–	USB type A male	TSX CUSB 485	–
	HMI STO/STU	2.5 m	USB type A male	XBT ZG935	–
	HMI STO/STU	1.8 m	USB type mini-B male	BMX XCA USB H018	0.230
XBT adaptor for USB cable	XBT N/R/RT	2 m	Set of 2 cables (RJ45/RJ45 RJ45/25-way SUB-D)	XBT Z925	–
Serial printer cables	XBT N/R/RT	2.5 m	25-way female SUB-D	XBT Z926	0.220
	HMI STO/STU	1.8 m	9-way male SUB-D	HMI ZURS	–
USB host extension cable	HMI STO/STU	2 m	USB type A male, dust and damp proof	XBT ZG USB	0.220
USB device extension cable	HMI STO/STU	2 m	USB type mini-B male, dust and damp proof	HMI ZS USBB	–

(1) Use a 5 V power supply: **ABL 8MEM 05040**(2) **XBT Z945** cable included.(3) Adaptor to be used with **XBT Z925** cable.

Operator dialog terminals

Separate components for Magelis XBT N, XBT R, XBT RT and Magelis STO and STU Small Panels

Cables for connecting Magelis terminals

Type of PLC to be connected	Type of connector	Physical link	Protocol	Length	Reference	Weight kg
Direct connection of XBT N/R/RT (XBT N200/N400/R400/RT500/RT511) and HMI STO/STU terminals to Schneider Electric PLCs						
Twido, Modicon Nano, Modicon TSX Micro, Modicon Premium	Mini-DIN	RS 485	Modbus/Uni-TE	2.5 m	XBT Z9780	–
				10 m	XBT Z9782 (1)	–
Modicon M340	RJ45	RS485	Modbus	2.5 m	XBT Z9980	–
				10 m	XBT Z9982 (1)	–

Direct connection of XBT N/R (XBT N410/N401/R410/R411) terminals to Schneider Electric PLCs						
Twido, Modicon Nano, Modicon TSX Micro, Modicon Premium	Terminal port, 8-way female mini-DIN	RS 485	Uni-TE (V1/V2) and Modbus	2.5 m	XBT Z968	0.180
				5 m	XBT Z9681	0.340
				2.5 m (2)	XBT Z9680	0.170
Modicon Premium with TSX SCY 2160●	25-way female SUB-D	RS 485	Uni-TE (V1/V2)	2.5 m	XBT Z918	0.230
Modicon Quantum	9-way male SUB-D	RS 232	Modbus	2.5 m	XBT Z9710	0.210
Modicon STB	HE13 (NIM)	RS 232	Modbus	2.5 m	XBT Z988	0.170
Modicon Momentum M1 (Port 1)	RJ45	RS 232	Modbus	2.5 m	XBT Z9711	0.210
Modicon M340	RJ45	RS 485	Modbus	2.5 m	XBT Z938	0.210

Direct connection of XBT N/R/RT (XBT N401/R411/RT511) terminals to Schneider Electric PLCs via the 2nd mini-DIN serial port and Vijeo Designer Lite 1.3 minimum						
Zelio Logic	Programming port (specifically for Zelio Logic)	–	Zelio	3 m	SR2 CBL 08	–

Direct connection of the HMI STO 501 terminal to Zelio Logic SR2/SR3 controllers						
Zelio Logic SR2/SR3 (3)	Programming port (specifically for Zelio Logic)	RS 232C	Zelio	2.5 m	SR2 CBL 09	–

(1) For XBT N200/N400/R400/RT500, use a cable with adaptor **XBT ZRT PW** and a 5 V \square power supply.

(2) Angled SUB-D connector.

(3) Cable included with 9-way removable screw terminal block.

Operator dialog terminals

Separate components for Magelis XBT N, XBT R, XBT RT and Magelis STO and STU Small Panels

Cables for connecting Magelis terminals (continued)**Direct connection of XBT RT500/RT511 and Magelis STO/STU terminals to Modicon STB I/O (1)**

Modicon STB	HE13 (NIM)	RS 232	Modbus	2.5 m	XBT Z9715	–
-------------	------------	--------	--------	-------	-----------	---

Direct connection of XBT (XBT NU400/N410/N401/R410/R411) terminals to Schneider Electric motor starters and drives

TeSys U, T ATV 312/32/61/71 variable speed drives ATS 48 starter Lexium 32, Preventa XPSMC	RJ45	RS 485	Modbus	2.5 m	XBT Z938	0.210
--	------	--------	--------	-------	----------	-------

Direct connection of XBT (XBT N200/N400/R400/RT500/RT511) and Magelis STO/STU terminals to Schneider Electric motor starters and drives (2)

TeSys U, T ATV 312/32/61/71 variable speed drives ATS 48 starter Lexium 32, Preventa XPSMC	RJ45	RS 485	Modbus	2.5 m	XBT Z9980	–
--	------	--------	--------	-------	-----------	---

Direct connection of XBT (XBT N410/N401/R410/R411) terminals to third-party PLCs

Allen-Bradley	SLC5	9-way male SUB-D	RS 232	DF1	2.5 m	XBT Z9730	0.210
	PLC5	25-way female SUB-D	RS 232	DF1	2.5 m	XBT Z9720	0.210
	Micro-logix	Micro-logix 1000	RS 232	DF1	2.5 m	XBT Z9731	0.210
DH485				2.5 m	XBT Z9732	–	
Mitsubishi	FX	8-way female mini-DIN	RS 232/ RS 422 converter	Melsec FX	2.5 m	XBT Z980	–
Omron	CPM1, CPM2, CJ1, CS1	9-way male SUB-D	RS 232	Sysmacway	2.5 m	XBT Z9740	0.210
Siemens	S7 (PG)	9-way male SUB-D	RS 485	PPI	2.5 m	XBT Z9721	0.210

Direct connection of the XBT RT500/RT511 and Magelis STO/STU terminal to third-party PLCs (1)

Allen-Bradley	SLC5	9-way male SUB-D	RS 232	DF1	2.5 m	XBT Z9734	–
	Micro-logix	Micro-logix 1000	RS 232	DF1	2.5 m	XBT Z9733	–
Mitsubishi	FX	8-way female mini-DIN	RS 232/ RS 422 converter	Melsec FX	2.5 m	XBT Z980 + (3)	–
Omron	CPM1, CPM2, CJ1, CS1	9-way male SUB-D	RS 232	Sysmacway	2.5 m	XBT Z9743	–
Siemens	S7 (PG)	9-way male SUB-D	RS 485	PPI	2.5 m	XBT ZG9721	0.210

(1) For XBT RT500, use a cable with adaptor XBT ZRT PW and a 5 V \pm power supply.(2) For Magelis XBT N200/N400/R400/RT500, use a cable with adaptor XBT ZRT PW and a 5 V \pm power supply.

(3) Adaptor XBT ZG939 to be used with cables with " + (3) " after the reference.

Operator dialog terminals

Separate components for Magelis XBT N, XBT R, XBT RT and Magelis STO and STU Small Panels

Cables for connecting Magelis terminals (continued)**Bus and network connections for XBT N410/N401/R410/R411 terminals**

Type of bus/network	Tap-off units	Type of connector	Length	Reference	Weight kg
Uni-Telway serial link	Subscriber socket TSX SCA 62	15-way female SUB-D	1.8 m	XBT Z908	0.240
			2.5 m		
	Connection box TSX P ACC 01	8-way female mini-DIN	5 m	XBT Z9681	0.340
			10 m	XBT Z9686	
			20 m	XBT Z9687	
25 m	XBT Z9688				
Modbus serial link	Subscriber socket TSX SCA 64	15-way female SUB-D	1.8 m	XBT Z908	0.240
	8-port Modbus splitter box LU9 GC3, Modbus tap-off, TWD XCA ISO, TWD XCA T3RJ	RJ45	2.5 m	XBT Z938	0.210

Bus and network connections for XBT RT511 and Magelis STO/STU terminals

Type of bus/network	Tap-off units	Type of connector	Length	Reference	Weight kg
Uni-Telway serial link	Connection box TSX P ACC 01	8-way female mini-DIN	2.5 m	XBT Z9780	0.180
Modbus serial link	8-port Modbus splitter box LU9 GC3, Modbus tap-off, TWD XCA ISO, TWD XCA T3RJ	RJ45	2.5 m	XBT Z9980	–

1

Applications	Display of text messages, graphic objects and synoptic views Control and configuration of data
Type of terminal	Optimum Advanced Panels, touch screen
Degree of protection (according to IEC 60529)	IP65 (IP67 with addition of a cover)

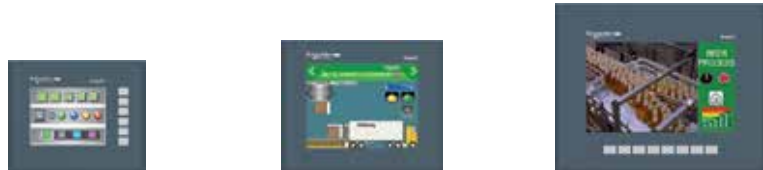

Display	Type	Color TFT LCD, backlit 320 x 240 pixels (QVGA)	Color TFT LCD, backlit 800 x 480 pixels (WVGA)
	Capacity	3.5"	5.7" 7.0 Wide
Data entry	Static function keys	Via touch screen 6 function keys (static or dynamic)	Via touch screen 8 function keys (static or dynamic)
	Dynamic function keys	–	–
	Service keys	–	–
	Alphanumeric keys	–	–
Memory capacity	Applications	64/96 MB Flash EPROM (1)	96 MB Flash EPROM
	Expansion	–	By 4 GB SD card (except HMI GTO2300)
Functions	Maximum number of pages	Limited by internal Flash EPROM memory capacity	Limited by capacity of internal Flash EPROM memory or of SD card
	Variables per page	Unlimited (8000 variables max.)	
	Reintroduction of variables	Alphanumeric, bitmap, bargraph, gauge, tank, tank level indicator, curves, polygon, button, LED	
	Recipes	32 groups of 64 recipes comprising 1024 ingredients max.	
	Curves	Yes, with log	
	Alarm logs	Yes	
	Real-time clock	Built-in	
	Discrete I/O	–	
	Multimedia I/O	–	
Communication	Downloadable protocols	Uni-TE (2), Modbus, Modbus TCP/IP (1) and for PLC brands: Mitsubishi, Omron, Allen-Bradley and Siemens	
	Asynchronous serial link	RS 232C (COM1) and RS 485 (COM2) except HMI GTO1310: RS 232C/485 (COM1)	
	USB ports	1 type A host connector + 1 mini-B connector	
	Buses and networks	Ethernet TCP/IP (10BASE-T/100BASE-TX) (3), Modbus Plus and Fipway via USB gateway	
	Printer link	RS 232C (COM1) serial link (4) and USB port for parallel printer	
Development software	Vijeo Designer (on Windows XP and Windows 7)		
Operating system	Magelis (333 MHz RISC CPU)		
Type of terminal	HMI GTO1300 HMI GTO1310	HMI GTO2300 HMI GTO2310	HMI GTO3510
Page	1/43		

(1) Depending on model.
 (2) Uni-TE version V2 for Twido controller and TSX Micro/Premium platform.
 (3) Except HMI GTO1300 and GTO2300 (Modbus Plus and Fipway via USB gateway only).
 (4) Except HMI GTO1310 (USB port for parallel printer only).



**Display of text messages, graphic objects and synoptic views
Control and configuration of data**

Optimum Advanced Panels, touch screen **Optimum Advanced Panels, touch screen, "Stainless Steel" version**

IP65 (IP67 with addition of a cover) **IP66K (Front panel with stainless steel frame) for food & beverage environment**



Color TFT LCD, backlit 640 x 480 pixels (VGA)	Color TFT LCD, backlit 640 x 480 pixels (VGA)	Color TFT LCD, backlit 800 x 600 pixels (SVGA)	Color TFT LCD, backlit 320 x 240 pixels (QVGA)	Color TFT LCD, backlit 640 x 480 pixels (VGA)	Color TFT LCD, backlit 800 x 600 pixels (SVGA)
7.5"	10.4"	12.1"	5.7"	10.4"	12.1"

Via touch screen
-
-
-
-

96 MB Flash EPROM
By 4 GB SD card

Limited by capacity of internal Flash EPROM memory or of SD card

Unlimited (8000 variables max.)

Alphanumeric, bitmap, bargraph, gauge, tank, tank level indicator, curves, polygon, button, LED
32 groups of 64 recipes comprising 1024 ingredients max.

Yes, with log

Yes

Built-in

-

-

Uni-TE (2), Modbus, Modbus TCP/IP (1) and for PLC brands: Mitsubishi, Omron, Allen-Bradley and Siemens

RS 232C (COM1) and RS 485 (COM2)

1 type A host connector + 1 mini-B connector

Ethernet TCP/IP (10BASE-T/100BASE-TX), Modbus Plus and Fipway via USB gateway

RS 232C (COM1) serial link and USB port for parallel printer

Vijeo Designer (on Windows XP and Windows 7)

Magelis (333 MHz RISC CPU)

HMI GTO4310	HMI GTO5310	HMI GTO6310	HMI GTO2315	HMI GTO5315	HMI GTO6315
--------------------	--------------------	--------------------	--------------------	--------------------	--------------------

1

Applications		Display of text messages, graphic objects and synoptic views Control and configuration of data	
Type of terminal		Touch screen Standard Advanced Panels	
Display			
Type		Backlit monochrome or color STN LCD or backlit color TFT LCD (320 x 240 pixels) or (640 x 480 pixels) (3)	Backlit color STN LCD or color TFT LCD (640 x 480 pixels)
Capacity		5.7" (monochrome or color)	7.5" (color)
Data entry		Via touch screen	
Static function keys		-	
Dynamic function keys		-	
Service keys		-	
Alphanumeric keys		-	
Memory capacity		16 MB Flash EPROM (3) 32 MB Flash EPROM	
Applications		By means of 128 MB, 256 MB, 512 MB, 1 GB or 2 GB CF card (except XBT GT2110)	
Expansion			
Functions		Limited by capacity of internal Flash EPROM memory or CF card memory	
Maximum number of pages		Unlimited (8000 variables max.)	
Variables per page		Alphanumeric, bitmap, bargraph, gauge, tank, tank level indicator, curves, polygon, button, LED	
Reintroduction of variables		32 groups of 64 recipes comprising 1024 ingredients max.	
Recipes		Yes, with log	
Curves		Yes	
Alarm logs		Built-in	
Real-time clock		-	1 input (reset) and 3 outputs (alarm, buzzer, run)
Discrete I/O		(3)	1 audio input (microphone), 1 composite video input (digital or analog video camera), 1 audio output (loudspeaker) (1)
Multimedia I/O			
Communication		Uni-TE (2), Modbus, Modbus TCP/IP (1) and for PLC brands: Mitsubishi, Omron, Allen-Bradley and Siemens	
Downloadable protocols		RS 232C/RS 422/485 (COM1) and RS 485 (COM2)	
Asynchronous serial link		1 (3)	1
USB ports		Modbus Plus and Fipway with USB gateway, PROFIBUS DP and Device Net with optional card	
Bus and networks		Ethernet TCP/IP (10BASE-T/100BASE-TX) (1)	
Printer link		RS 232C (COM1) serial link, USB port for parallel printer	
Development software		Vijeo Designer (on Windows XP Professional and Windows 7 Professional 32/64-bit)	
Operating system		Magelis (133 MHz RISC CPU) (3)	Magelis (266 MHz RIS CPU)
Type of terminal		XBT GT21/22/23/24/29	XBT GT42/43
Page		1/58	

(1) Depending on model.
 (2) Uni-TE version V2 for Twido controller and TSX Micro/Premium platform.
 (3) For XBT GT 2430, 32 MB Flash EPROM, 1 sound output, 2 USB ports, 266 MHz RISC CPU.
 (4) For XBT GT 5430.

**Display of text messages, graphic objects and synoptic views
Control and configuration of data**

Touch screen Standard Advanced Panels



Backlit color STN LCD or color TFT LCD (640 x 480 pixels or 800 x 600 pixels) (4)	Backlit color TFT LCD (800 x 600 pixels)	Backlit color TFT LCD (1024 x 768 pixels)
10.4" (color)	12.1" (color)	15" (color)

Via touch screen
 –
 –
 –
 –

32 MB Flash EPROM
 By means of 128 MB, 256 MB, 512 MB, 1 GB or 2 GB CF card

Limited by capacity of internal Flash EPROM memory or CF card memory

Unlimited (8000 variables max.)
 Alphanumeric, bitmap, bargraph, gauge, tank, tank level indicator, curves, polygon, button, LED

32 groups of 64 recipes comprising 1024 ingredients max.

Yes, with log
 Yes

Built-in
 1 input (reset) and 3 outputs (alarm, buzzer, run)

1 audio input (microphone), 1 composite video input (digital or analog video camera), 1 audio output (loudspeaker) (1)

Uni-TE (2), Modbus, Modbus TCP/IP (1) and for PLC brands: Mitsubishi, Omron, Allen-Bradley and Siemens

RS 232C/RS 422/485 (COM1) and RS 485 (COM2)
 2

Modbus Plus with USB gateway
 Ethernet TCP/IP (10BASE-T/100BASE-TX)
 RS 232C (COM1) serial link, USB port for parallel printer

Vijeo Designer (on Windows XP Professional and Windows 7 Professional 32/64-bit)
 Magelis
 (266 MHz RIS CPU)

XBT GT52/53/54 XBT GT63 XBT GT73

1/58

1

Applications		Display of text messages, graphic objects and synoptic views Control and configuration of data		
Type of terminal		Standard Advanced Panels with keypad		
				
Display	Type	Color TFT LCD (320 x 240 pixels) or monochrome STN	Color TFT LCD (640 x 480 pixels)	
	Capacity	5.7" (monochrome or color)	10.4" (color)	
Data entry	Via keypad and/or touch screen (configurable) and/or by industrial pointer			
	Static function keys	10	12	
	Dynamic function keys	14	18	
	Service keys	8		
	Alphanumeric keys	12		
Memory capacity	Application	16 MB Flash EPROM	32 MB Flash EPROM	
	Expansion	By means of 128 MB, 256 MB, 512 MB, 1 GB or 2 GB CF card		
Functions	Maximum number of pages	Limited by capacity of internal Flash EPROM memory or CF card memory		
	Variables per page	Unlimited (8000 variables max.)		
	Reintroduction of variables	Alphanumeric, bitmap, bargraph, gauge, tank, tank level indicator, curves, polygon, button, LED		
	Recipes	32 groups of 64 recipes comprising 1024 ingredients max.		
	Curves	Yes, with log		
	Alarm logs	Yes		
	Real-time clock	Built-in		
	Discrete I/O	–	1 input - 3 outputs	
	Multimedia I/O	–	–	
	Communication	Downloadable protocols	Uni-TE (2), Modbus, Modbus TCP/IP (1) and for PLC brands: Mitsubishi, Omron, Allen-Bradley and Siemens	
Asynchronous serial link		RS 232C/RS 422/485 (COM1) RS 485 (COM2)		
USB ports		1	2	
Bus and networks		Modbus Plus, Fipway with USB gateway, PROFIBUS DP and Device Net with optional card Ethernet TCP/IP (10BASE-T/100BASE-TX)		
Printer link		RS 232C (COM1) serial link, USB port for parallel printer		
Development software		Vijeo Designer (on Windows XP Professional and Windows 7 Professional 32/64-bit)		
Operating system		Magelis (CPU 266 MHz RISC)		
Type of terminal		XBT GK 21/23	XBT GK 53	
Page		1/59		

(1) Depending on model.

(2) Uni-TE version V2 for Twido controller and TSX Micro/Premium platform.



**Display of text messages, graphic objects and synoptic views
Control and configuration of data**

Portable Standard Advanced Panels Open touch screen Standard Advanced Panels

Color TFT LCD (640 x 480 pixels)	Color TFT LCD (800 x 600 pixels)	Color TFT LCD (800 x 600 pixels)	Color TFT LCD (1024 x 768 pixels)
5.7" (color)	10.4" (color)	12" (color)	15" (color)
Via touch screen	Via touch screen		
11	–		
–	–		
–	–		
–	–		
32 MB Flash EPROM	2 GB CF system card included with terminal, expandable to 4 GB		
By means of 128 MB, 256 MB, 512 MB, 1 GB or 2 GB CF card (3)			
Limited by capacity of internal Flash EPROM memory or CF card memory			
Unlimited (8000 variables max.)			
Alphanumeric, bitmap, bargraph, gauge, tank, tank level indicator, curves, polygon, button, LED			
32 groups of 64 recipes comprising 1024 ingredients max.			
Yes, with log			
Yes			
Built-in			
–			
1 audio output			
Uni-TE (2), Modbus, Modbus TCP/IP and for PLC brands: Mitsubishi, Omron, Rockwell Automation and Siemens	Uni-TE (2), Modbus, Modbus TCP/IP (1) and for PLC brands: Mitsubishi, Omron, Allen-Bradley and Siemens		
RS 232C/RS 422-485 (COM1)	RS 232C (COM1)	RS 232C (COM1)	RS 232C (COM1)
1	2+1 frontal	4+1 frontal	2+1 frontal
–	Modbus Plus with USB gateway		
1 Ethernet port (10BASE-T/100BASE-TX)	2 Ethernet ports (4) (10BASE-T/100BASE-TX/1 GB)		
–	RS 232C (COM1) serial link, USB port for parallel printer		
Vijeo Designer (on Windows XP Professional and Windows 7 Professional 32/64-bit)			
Magelis (266 MHz RISC CPU)	Windows XP Embedded		
XBT GH 2460/ XBT GH 2460B (5)	HMI GTW 5354	XBT GTW 652	HMI GTW 7354 HMI GTW 73545 (6)
1/59	1/60		

(1) Depending on model.
 (2) Uni-TE version V2 for Twido controller and TSX Micro/Premium platform.
 (3) Except for HMI GTW●●●● with 4 GB SD memory card.
 (4) Except on XBT GTW652 with 1 Ethernet TCP/IP port (10BASE-T/100BASE-TX) and 1 Ethernet TCP/IP port (10BASE-T/100BASE-TX/1 GB).
 (5) Version without Emergency stop button.
 (6) Version with stainless steel front panel.



Magelis color touch screen terminals HMI GTO●●●0
in 5 sizes from 3.5" to 12.1" (standard version)



Magelis color touch screen terminals HMI GTO●●●5
in 3 sizes from 5.7" to 12.1" ("Stainless Steel" version)

Overview

The Optimum Advanced Panels (Magelis GTO) touch screen panel product offer includes:

- Range of 8 color touch screen terminals (TFT technology), available in a choice of 5 sizes
 - 3.5"
 - 5.7"
 - 7": 7 Wide and 7.5" (front identical in size)
 - 10.4"
 - 12.1"
- Range of 3 color TFT touch screens available in 3 sizes:
 - 5.7"
 - 10.4"
 - 12.1"

with front featuring a stainless steel frame, dedicated to applications in harsh environments (food & beverage and pharmaceutical).

Operation

Magelis GTO Advanced Panels feature optimized information and communication technologies, which, depending on the model, include:

- High level of communication (embedded Ethernet, multilink, Web server and FTP, e-mail)
- External storage of data (SD memory card and USB memory stick) for storing production data and backing up applications
- Management of peripherals: printers, bar code readers, etc.

These terminals offer an excellent level of technical performance designed principally for use by OEM customers.

Environment

The Magelis GTO optimized range has been designed in accordance with numerous standards, certifications and requirements:

- Standards: EN 61131-2, 61000-6-2 and UL508.
- Certifications:
 - CE, C-tick, GOST-R, KCC
 - Atex and UL Hazardous location (pending)
 - Marine certifications (pending).
- Operating temperature: up to 55°C
- Degree of protection (according to IEC 60529):
 - IP65 for standard version products
 - IP67 for standard version products fitted with a cover for harsh environments (see accessories page 1/61)
 - IP66K for "Stainless Steel" version products
- Resistance to high-pressure cleaning (conforming to DIN 40050-9): up to 10 bar for "Stainless Steel" version products.



Display of a video sequence

Configuration

Like all the other Magelis Advanced Panels, Magelis GTO Optimum Advanced Panels can be configured using Vijeo Designer software in a Windows XP and Windows 7 environment.

Vijeo Designer software boasts an advanced user interface with many configurable windows, enabling projects to be developed quickly and easily.

The Magelis GTO range is compatible with Vijeo Designer version V6.1 or later.

See page 4/8.

Communication

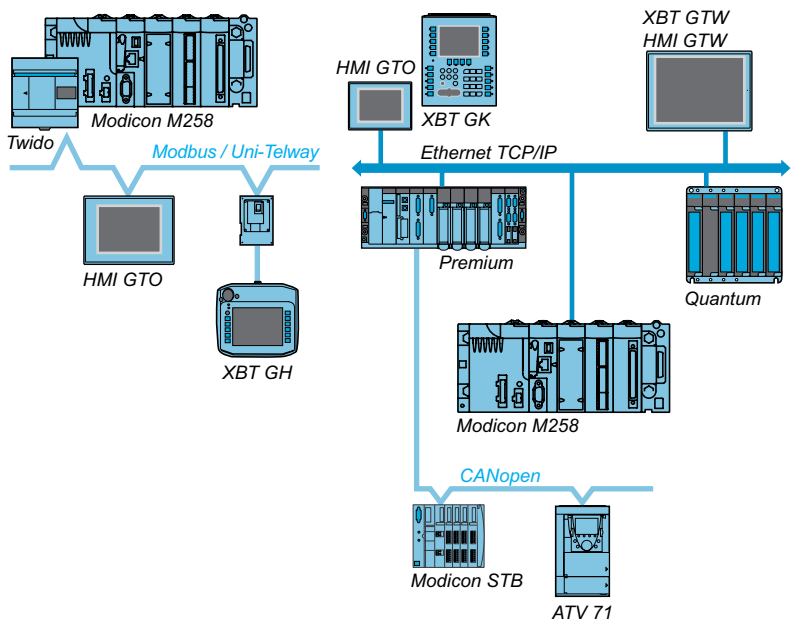

Optimum Advanced Panels communicate with PLCs via one or two integrated serial links, using communication protocols:

- Schneider Electric (Uni-TE, Modbus)
- Third-party: Mitsubishi Electric, Omron, Allen-Bradley and Siemens

Depending on the model, they can be connected to Ethernet TCP/IP networks using:

- Modbus TCP protocol
- Ethernet TCP/IP protocol, or a...
- Third-party protocol

Functions

Optimum Advanced Panels offer the following functions:

- Display of animated synoptic views with 8 types of animation (pressing the touch panel, color changes, filling, movement, rotation, size, visibility and value display)
- Control, modification of numeric and alphanumeric values
- Display of current date and time
- Real-time and trending curves with log
- Alarm display, alarm log and management of alarm groups
- Multiwindow management
- Operator-initiated page calls
- Multilingual application management (10 languages at the same time)
- Recipe management
- Data processing via Java script
- Storage of the application and logs on external application memory card in SD format or USB stick
- Management of serial printers, barcode readers

Architectures and communication

The Magelis GTO Optimum product range is perfectly integrated in the MachineStruxure™ (1) automation solutions offer, which helps machine manufacturers (OEMs) to quickly design lower-cost, energy-efficient machines. MachineStruxure™ solutions are based on high performance control platforms and a single software package: SoMachine. SoMachine allows the development, commissioning and programming of machines. SoMachine version 3.1 allows programming of terminals in the Magelis GTO range using Vijeo Designer software.

Optimum Advanced Panels have been designed for PlantStruxure™ (2) and MachineStruxure™ (1) architectures as well as for Transparent Ready equipment (combination of Web and Ethernet TCP/IP technologies). All panels with an Ethernet port, feature: a built-in FTP server for data file transfer, as well as a Web Gate function for remote access to the application of the panel, from a PC with an Internet browser.

Vijeo Designer also allows Magelis Advanced Panels to browse HTML pages and send e-mails.

MachineStruxure™



SoMachine software
platform



Vijeo Designer
configuration software

PlantStruxure™

(1) For more information on the "MachineStruxure™" concept, please consult our catalog "Automation solutions for industrial machines".

(2) For more information on the "PlantStruxure™" concept, please consult our website www.schneider-electric.com/Solutions/Process and Machines Management.

Panel operating modes

The following illustrations show the equipment that can be connected to Optimum Advanced Panels according to their two operating modes.

Edit mode

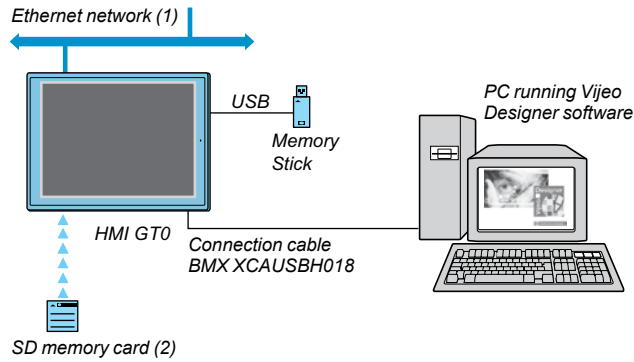

Operating mode

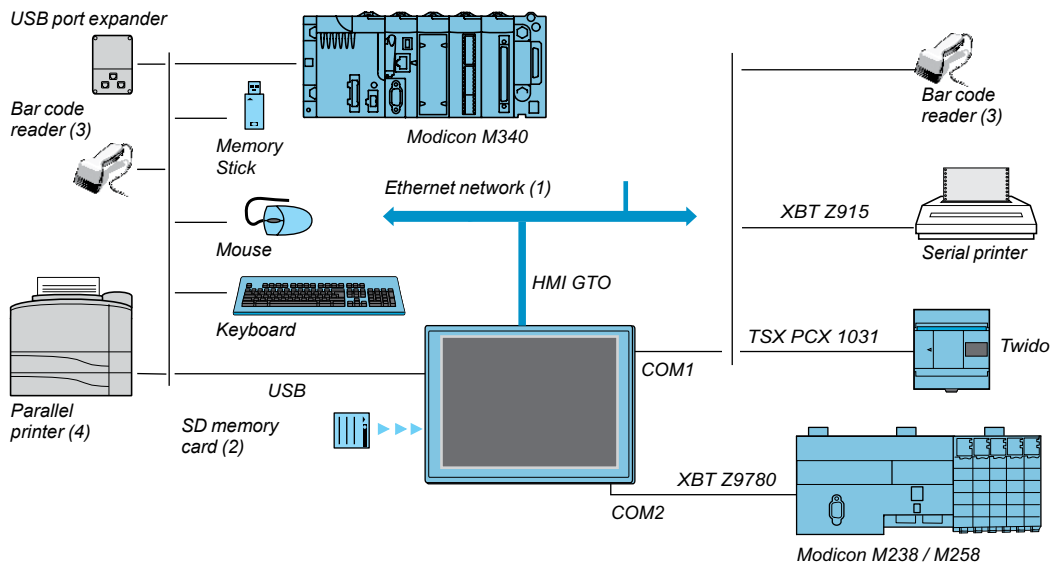

- (1) With HMI GTO●●1●.
- (2) Memory card, except HMI GTO1300/1310/2300.
- (3) Validated with DataLogic Gryphon bar code reader.
- (4) Validated with Hewlett Packard printer via USB/PIO converter.

1

Common front



Description

Magelis HMI GTO1300 / 1310 Advanced Panels

HMI GTO1300 and HMI GTO1310 panels have the following features on the front:

- 1 Touch screen for displaying synoptic views (3.5" color TFT)
- 2 Multicolor indicator (green, orange and red) showing the panel's operating mode
- 3 Six function keys (F1, F2, F3, F4, F5 and F6)

Rear HMI GTO1300

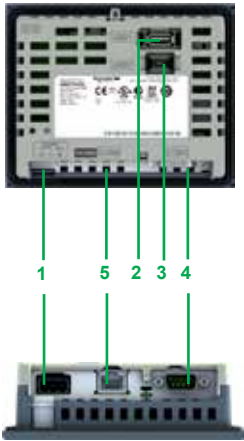

The HMI GTO1300 panel has the following features on the rear and underside:

- 1 Removable screw terminal block for 24 V $\overline{\text{DC}}$ power supply
- 2 Type A USB host connector for connecting peripherals, transferring applications and Modicon M340 terminal port communication
- 3 Mini-B USB connector for application transfer
- 4 9-way male SUB-D connector for RS 232C serial link to PLCs (COM1)
- 5 RJ45 connector for RS 485 serial link to PLCs (COM2)

Underside HMI GTO1300

Rear HMI GTO1310

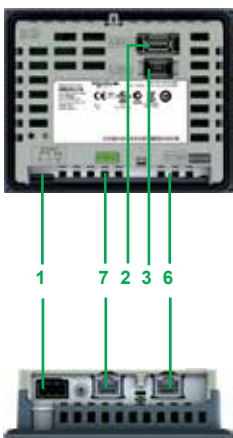

The HMI GTO1310 panel has the following features on the rear and underside:

- 1 Removable screw terminal block for 24 V $\overline{\text{DC}}$ power supply
- 2 Type A USB host connector for connecting peripherals, transferring applications and Modicon M340 terminal port communication
- 3 Mini-B USB connector for application transfer
- 6 RJ45 connector for RS 232C or RS 485 serial link to PLCs (COM1)
- 7 RJ45 connector for Ethernet TCP/IP link, 10BASE-T/100BASE-TX

Underside HMI GTO1310

Front



2 1

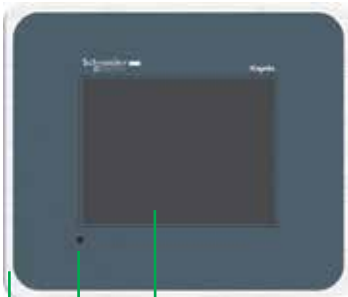

3 2 1

Rear HMI GTO2315

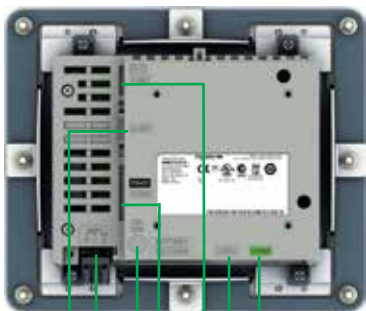

4 1 7 5 6 2 3 8

Underside HMI GTO2315

Description

Magelis Advanced Panels HMI GTO2300 / 2310 (standard version) and HMI GTO2315 (Stainless Steel version)

HMI GTO2300 and HMI GTO2310 panels have the following features on the front:

- 1 Touch screen for displaying synoptic views (5.7" color TFT)
- 2 Multicolor indicator (green, orange and red) showing the panel's operating mode

The HMI GTO2315 panel has the following features on the front:

- 1 Touch screen for displaying synoptic views (5.7" color TFT)
- 2 Multicolor indicator (green, orange and red) showing the panel's operating mode
- 3 Stainless steel frame, for food & beverage environments. Only this product provides IP66K degree of protection.

All 3 of these panels have the following features on the rear and underside:

- 1 Removable screw terminal block for 24 V $\bar{\text{---}}$ power supply
- 2 Type A USB host connector for connecting peripherals, transferring applications and Modicon M340 terminal port communication
- 3 Mini-B USB connector for application transfer
- 4 9-way male SUB-D connector for RS 232C serial link to PLCs (COM1)
- 5 RJ45 connector for RS 485 serial link (COM2)

On HMI GTO2310 and HMI GTO2315 only:

- 6 Slot for SD memory card, with hinged cover
- 7 LED indicating presence of the SD memory card
- 8 RJ45 connector for Ethernet TCP/IP link, 10BASE-T/100BASE-TX

1

Front



Rear

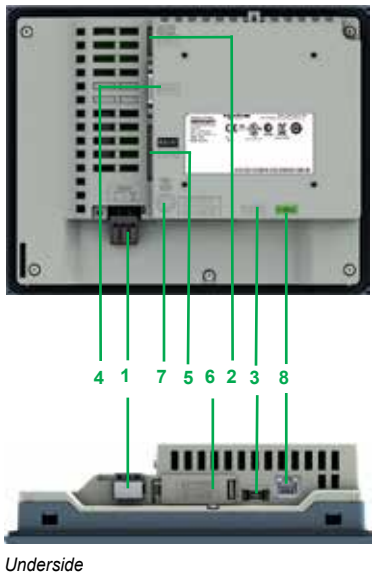

Description

Magelis Advanced Panels HMI GTO3510 / 4310

The HMI GTO3510 panel has the following features on the front:

- 1 Touch screen for displaying synoptic views (7.0" Wide color TFT)
- 2 Multicolor indicator (green, orange and red) showing the panel's operating mode
- 3 Eight function keys (F1, F2, F3, F4, F5, F6, F7 and F8)

The HMI GTO4310 panel has the following features on the front:

- 1 Touch screen for displaying synoptic views (7.5" color TFT)
- 2 Multicolor indicator (green, orange and red) showing the panel's operating mode

Both terminals have the following features on the rear and underside:

- 1 Removable screw terminal block for 24 V $\bar{\text{---}}$ power supply
- 2 Type A USB host connector for connecting peripherals, transferring applications and Modicon M340 terminal port communication
- 3 Mini-B USB connector for application transfer
- 4 9-way male SUB-D connector for RS 232C serial link to PLCs (COM1)
- 5 RJ45 connector for RS 485 serial link (COM2)
- 6 Slot for SD memory card, with hinged cover
- 7 LED indicating presence of the SD memory card
- 8 RJ45 connector for Ethernet TCP/IP link, 10BASE-T/100BASE-TX with an activity LED

Operator dialog terminals

Optimum Advanced Panels

Magelis GTO with 10.4" touch screen,

Standard and Stainless Steel version

Front

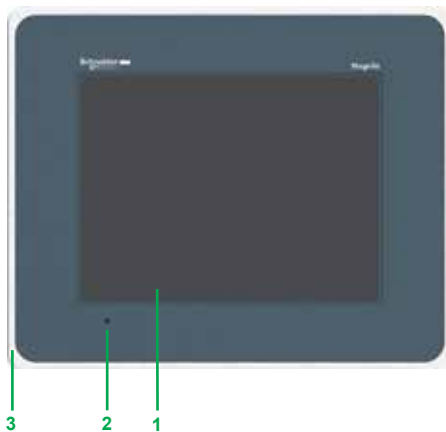
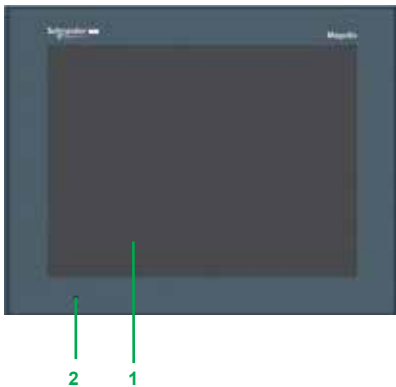

Description

Magelis Advanced Panels HMI GTO5310 (standard version) and HMI GTO5315 (Stainless Steel version)

The HMI GTO5310 panel has the following features on the front:

- 1 Touch screen for displaying synoptic views (10.4" color TFT)
- 2 Multicolor indicator (green, orange and red) showing the panel's operating mode

The HMI GTO5315 panel has the following features on the front:

- 1 Touch screen for displaying synoptic views (10.4" color TFT)
- 2 Multicolor indicator (green, orange and red) showing the panel's operating mode
- 3 Stainless steel frame, for food & beverage environments. Only this product provides IP66K degree of protection.

Rear

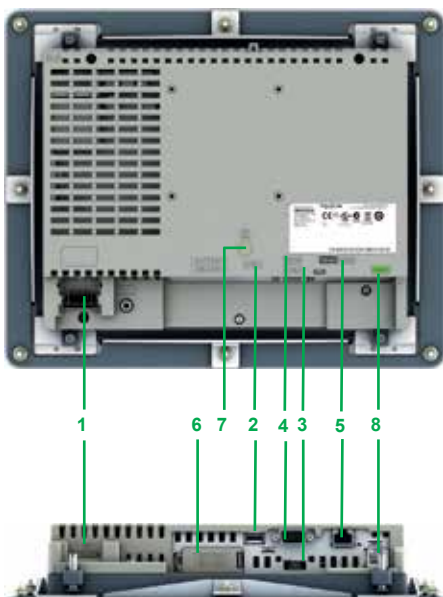

Underside

Both terminals have the following features on the rear and underside:

- 1 Removable screw terminal block for the 24 V $\bar{\text{---}}$ power supply
- 2 Type A USB host connector for connecting peripherals, transferring applications and Modicon M340 terminal port communication
- 3 Mini-B USB connector for application transfer
- 4 9-way male SUB-D connector for RS 232C serial link to PLCs (COM1)
- 5 RJ45 connector for RS 485 serial link (COM2)
- 6 Slot for SD memory card, with hinged cover
- 7 LED indicating presence of the SD memory card
- 8 RJ45 connector for Ethernet TCP/IP link, 10BASE-T/100BASE-TX with an activity LED

1

Front

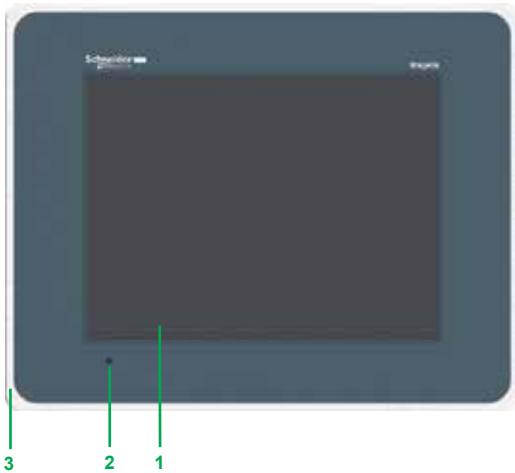

Rear

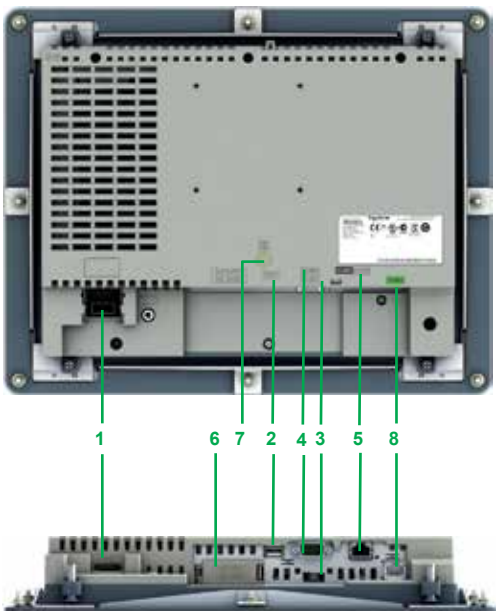

Underside

Description

Magelis Advanced Panels HMI GTO6310 (standard version) and HMI GTO6315 (Stainless Steel version)

The HMI GTO6310 panel has the following features on the front:

- 1 Touch screen for displaying synoptic views (12.1" color TFT)
- 2 Multicolor indicator (green, orange and red) showing the panel's operating mode

The HMI GTO6315 panel has the following features on the front:

- 1 Touch screen for displaying synoptic views (12.1" color TFT)
- 2 Multicolor indicator (green, orange and red) showing the panel's operating mode
- 3 Stainless steel frame, for food & beverage environments. Only this product provides IP66K degree of protection.

Both terminals have the following features on the rear and underside:

- 1 Removable screw terminal block for the 24 V $\bar{\text{---}}$ power supply
- 2 Type A USB host connector for connecting peripherals, transferring applications and Modicon M340 terminal port communication
- 3 Mini-B USB connector for application transfer
- 4 9-way male SUB-D connector for RS 232C serial link to PLCs (COM1)
- 5 RJ45 connector for RS 485 serial link (COM2)
- 6 Slot for SD memory card, with hinged cover
- 7 LED indicating presence of the SD memory card
- 8 RJ45 connector for Ethernet TCP/IP link, 10BASE-T/100BASE-TX with an activity LED



HMI GTO1300



HMI GTO2300



HMI GTO3510



HMI GTO4310



HMI GTO6310



HMI GTO2315



HMI GTO5315

Optimum 24 V DC panels with color touch screen, Standard version ⁽¹⁾

Data entry method	Number of ports	Application memory capacity	Memory expansion by SD card	Serial link	Embedded Ethernet	Reference	Weight kg
3.5" QVGA TFT LCD screen, 320 x 240 pixels							
Via touch screen + 6 function keys	2 USB	64 MB	No	1 COM 1 1 COM 2	–	HMI GTO1300	0.400
	2 USB	96 MB	No	1 COM 1	1	HMI GTO1310	0.400

5.7" QVGA TFT LCD screen, 320 x 240 pixels

Via touch screen	2 USB	64 MB	No	1 COM 1 1 COM 2	–	HMI GTO2300	0.800
	2 USB	96 MB	Yes (2)	1 COM 1 1 COM 2	1	HMI GTO2310	0.800

7.0" WVGA (Wide) TFT LCD screen, 800 x 480 pixels

Via touch screen + 8 function keys	2 USB	96 MB	Yes (2)	1 COM 1 1 COM 2	1	HMI GTO3510	1.200
------------------------------------	-------	-------	---------	--------------------	---	-------------	-------

7.5" VGA TFT LCD screen, 640 x 480 pixels

Via touch screen	2 USB	96 MB	Yes (2)	1 COM 1 1 COM 2	1	HMI GTO4310	1.200
------------------	-------	-------	---------	--------------------	---	-------------	-------

10.4" VGA TFT LCD screen, 640 x 480 pixels

Via touch screen	2 USB	96 MB	Yes (2)	1 COM 1 1 COM 2	1	HMI GTO5310	2.000
------------------	-------	-------	---------	--------------------	---	-------------	-------

12.1" SVGA TFT LCD screen, 800 x 600 pixels

Via touch screen	2 USB	96 MB	Yes (2)	1 COM 1 1 COM 2	1	HMI GTO6310	2.500
------------------	-------	-------	---------	--------------------	---	-------------	-------

Optimum 24 V DC terminals with color touch screen, Stainless Steel version ^{(1) (3)}

Data entry method	Number of ports	Application memory capacity	Memory expansion by SD card	Serial link	Embedded Ethernet	Reference	Weight kg
5.7" QVGA screen, 320 x 240 pixels, with stainless steel frame (IP66K)							
Via touch screen	2 USB	96 MB	Yes (2)	1 COM 1 1 COM 2	1	HMI GTO2315	1.200

10.4" VGA screen, 640 x 480 pixels, with stainless steel frame (IP66K)

Via touch screen	2 USB	96 MB	Yes (2)	1 COM 1 1 COM 2	1	HMI GTO5315	2.500
------------------	-------	-------	---------	--------------------	---	-------------	-------

12.1" SVGA screen, 800 x 600 pixels, with stainless steel frame (IP66K)

Via touch screen	2 USB	96 MB	Yes (2)	1 COM 1 1 COM 2	1	HMI GTO6315	3.000
------------------	-------	-------	---------	--------------------	---	-------------	-------

(1) Terminals supplied with mounting kit (screw clips), locking device for USB connectors and instruction sheet. Setup documentation for Magelis GTO terminals is included in electronic format with Vijeo Designer configuration software (see page 4/13).

(2) Memory expansion possible with 4 GB SD card HMI ZSD4G, see accessories page 1/61.

(3) The Stainless Steel version includes a front with stainless steel frame. Only this version provides IP66K degree of protection.

Introduction

Touch screen terminals with monochrome or color screen in 6 sizes from 3.8" to 15"

The Magelis Standard Advanced Panels touch screen terminals product offer consists of:

- Range of 20 touch screen terminals (XBT GT) available with a wide choice of screen sizes (3.8", 5.7", 7.5", 10.4", 12.1" and 15") in various versions (monochrome, color, STN or TFT)
- XBT GT 5.7" terminal (XBT GT 2930) equipped with a screen featuring an anti-reflection coating and a backlit display that is twice as intense for applications in brightly-lit environments, in particular those which are exposed to sunlight
- Range of 3 keypad/touch screen terminals (XBT GK), sizes 5.7" and 10.4" (monochrome, color)
- Range of touch screen/open terminals (GTW), sizes 10.4", 12" and 15", with Windows XP Embedded operating system for open access to new automation functions
- Portable touch screen terminal (XBT GH) with 5.7" color screen and safety devices (Emergency stop, enabling grip switch, etc.)

Operation

These terminals are available in one of two function levels:

- Optimum level (without memory expansion and without fieldbus connection): XBT GT 3.8" and XBT GT 5.7" (Blue mode)
- Multifunction level for the rest of the range: XBT GT/GK/GH/GTW (5.7", 7.5", 10.4", 12.1" and 15")

Multifunction Magelis Standard Advanced Panels terminals feature new information and communication technologies which, depending on the model, include:

- High level of communication (embedded Ethernet, multilink, Web server and FTP)
- External storage of data (Compact Flash memory card and USB memory stick) for storing production data and backing up applications
- Multimedia data with integrated image and sound management (digital or analog camera)
- Management of peripherals: Printers, bar code readers, loudspeakers, etc.



Display of a video sequence

Configuration

Magelis Standard Advanced Panels can be configured using Vijeo Designer software in a Windows XP Professional and Windows 7 Professional 32/64-bit environment.

Vijeo Designer software boasts an advanced user interface with many configurable windows, enabling projects to be developed quickly and easily. This version can process composite video signals from a camera or camcorder. See page 4/8.

Communication

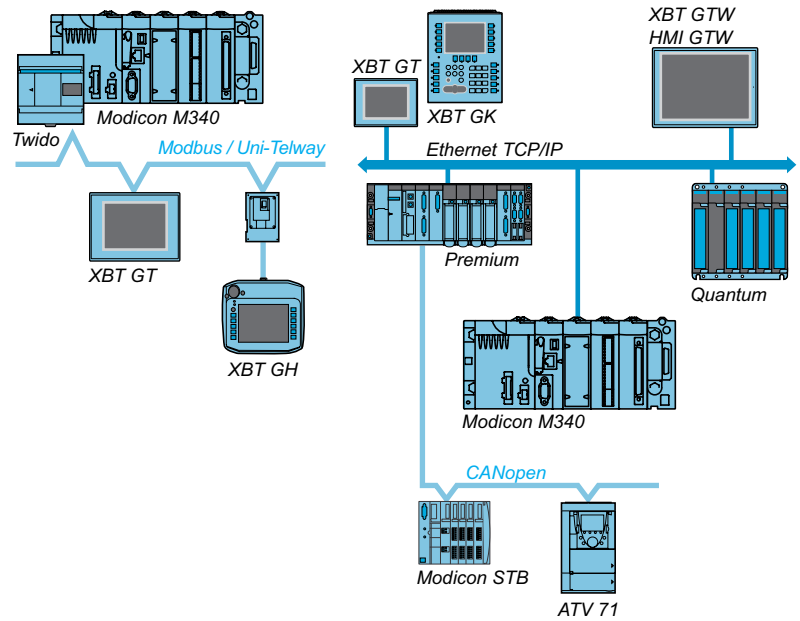

Magelis Standard Advanced Panels communicate with PLCs via one or two integrated serial links, using communication protocols:

- Schneider Electric (Uni-TE, Modbus)
- Third-party: Mitsubishi Electric, Omron, Allen-Bradley and Siemens

Magelis multifunction terminals can be connected, depending on the model, to Ethernet TCP/IP networks using Modbus TCP or third party protocols, and to fieldbuses (FIPWAY, Modbus Plus, Device Net, PROFIBUS DP).

Functions

Magelis Standard Advanced Panels offer the following functions:

- Display of animated mimics with 8 types of animation (pressing the touch panel, color changes, filling, movement, rotation, size, visibility and value display)
- Control and modification of numeric or alphanumeric variables
- Display of current date and time
- Real-time and trending curves with log
- Alarm display, alarm log and management of alarm groups
- Multiwindow management
- Page calls initiated by the operator
- Multilingual application management (10 languages at the same time)
- Recipe management
- Data processing via Java script
- Storage of the application and logs on external Compact Flash application memory card (multifunction range) or USB key
- Serial printer and bar code reader management (multifunction range)
- Sound messages management (multifunction range)
- Composite video signal management from camera or camcorder on XBT GT and digital video signal (Webcam) management on Magelis GTW

Magelis Standard Advanced Panels have been designed for Transparent Ready architectures and equipment (combination of Web and Ethernet TCP/IP technologies). All terminals with an Ethernet port feature a built-in FTP server for data file transfer, and a Web Gate function for remote access to the application of the terminal from a PC with an Internet browser.

The latest version of Vijeo Designer thus allows Magelis Standard Advanced Panels to browse HTML pages and send e-mails.

The flexibility of Windows XP Embedded on touch screen/open Standard Advanced Panels Magelis GTW terminals simultaneously allows:

- Running of a Vijeo Designer application
- Use of Internet Explorer or Office Readers (.pdf, .doc, .xls, and .ppt documents)

Panel operating modes

The following illustrations show the equipment that can be connected to Magelis Standard Advanced Panels according to their two operating modes.

Edit mode

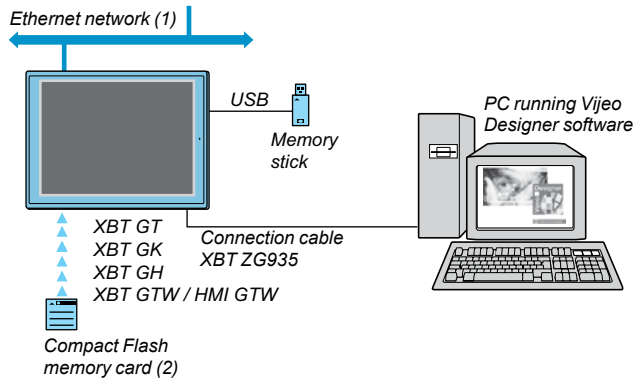

Operating mode

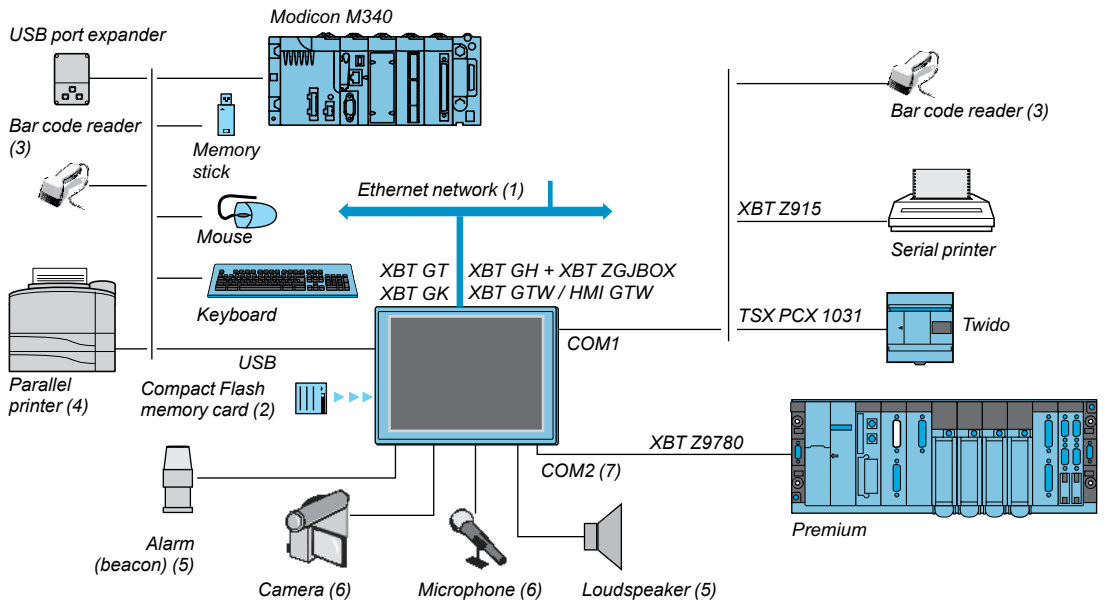

- (1) With XBT GT●●30/XBT GT●●40/XBT GK●●30/XBT GTW●●●/HMI GTW●●●● and XBT GH246●●.
- (2) Memory card, except XBT GT11/13/2110.
- (3) Validated with DataLogic Gryphon bar code reader.
- (4) Validated with Hewlett Packard printer via USB/PIO converter.
- (5) With XBT GT/GK/GTW 7.5" screen min. and HMI GTW.
- (6) With multimedia XBT GT 7.5" to 15": XBT GT●340.
- (7) With XBT GT and XBT GK 5.7" screen min.

Improve environmental resistance with Conformal Coating

The Conformal Coating Service Offer consists of varnishing the electronic cards to prolong the service life of the terminals and enable them to be used in corrosive environments. The varnishing increases resistance to condensation, dusty atmospheres and chemical corrosion (sulphurous and halogenous atmospheres).

For further information on this service offer, please consult our Customer Care Center.

Description

Standard Advanced Panels Magelis Multifunction XBT GT2●20 & XBT GT2●30

The front panel includes:

- 1 Touch screen for displaying synoptic views (5.7" monochrome or color)
- 2 Multicolor indicator (green, orange and red) showing the terminal's operating mode

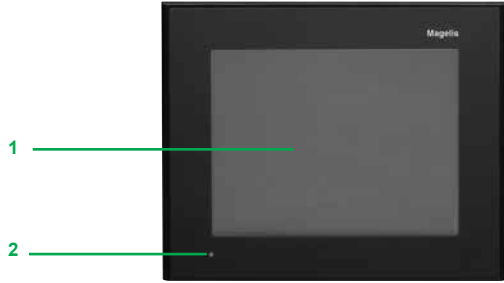

The rear panel includes:

- 1 Removable screw terminal block for 24 V $\bar{\bar{}}$ power supply
- 2 USB type A host connector for connecting peripherals, transferring applications and Modicon M340 terminal port communication
- 3 9-way male SUB-D connector for RS 232C or RS 422/485 serial link to PLCs (COM1)
- 4 Expansion unit interface for fieldbus communication card (Device Net, PROFIBUS DP) (1)
- 5 Switch for polarization of the COM2 serial link, used on Modbus
- 6 RJ45 connector for RS 485 serial link (COM2)
- 7 Compact Flash memory card slot, with cover

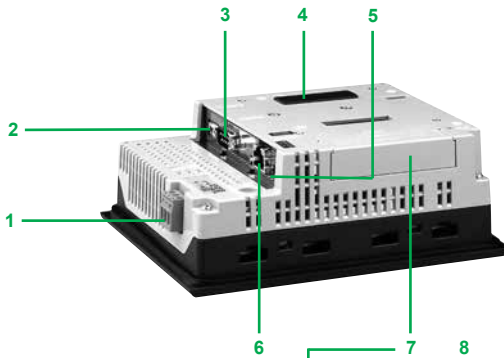

On XBT GT2130, GT2330 and GT 2930 only:

- 8 RJ45 connector for Ethernet TCP/IP link, 10BASE-T/100BASE-TX

On XBT GT2430 only:

- 8 RJ45 connector for Ethernet TCP/IP link, 10BASE-T/100BASE-TX
- 9 Mini-jack connector for audio output

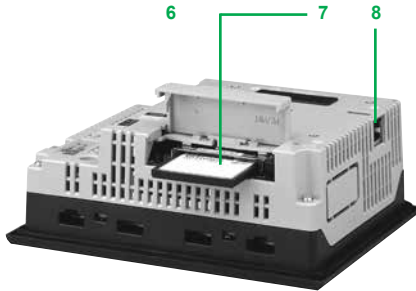

(1) See page 1/69 for details of the required connection accessories.

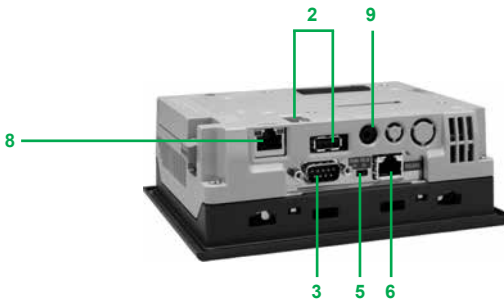

Description

Standard Advanced Panels Magelis Multifunction XBT GT4230 & 4300



The front panel includes:

- 1 Touch screen for displaying synoptic views (7.5" color STN or 7.5" color TFT, depending on model)
- 2 Multicolor indicator (green, orange and red) showing the terminal's operating mode

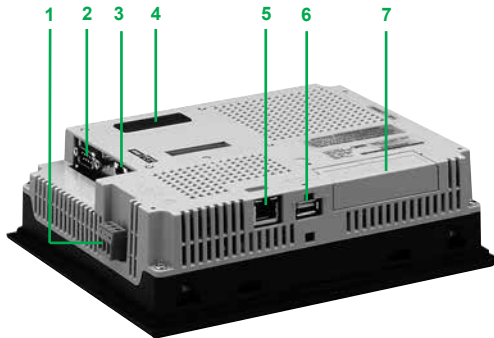

The rear panel includes:

- 1 Removable screw terminal block for 24 V $\overline{\text{---}}$ power supply
- 2 9-way male SUB-D connector for RS 232C or RS 422/485 serial link to PLCs (COM1)
- 3 RJ45 connector for RS 485 (COM2) with switch for polarization of the link used on Modbus
- 4 Expansion unit interface for fieldbus communication card (Device Net, PROFIBUS DP) (1)
- 5 RJ45 connector for Ethernet TCP/IP link, 10BASE-T/100BASE-TX, with an activity LED
- 6 USB type A host connector for connecting peripherals, transferring applications and Modicon M340 terminal port communication
- 7 Slot for Compact Flash memory card, with hinged cover
- 8 Removable I/O connector, 12 spring terminals for loudspeaker connection, one input (reset) and 3 outputs (alarm, buzzer, run)



On XBT GT4340 only:

- 9 Mini-jack connector for connecting a microphone
- 10 RCA connector for connecting a digital or analog video camera (NTSC/PAL)

(1) See page 1/69 for details of the required connection accessories.

Description

Standard Advanced Panels Magelis Multifunction XBT GT5300 and XBT GT5430

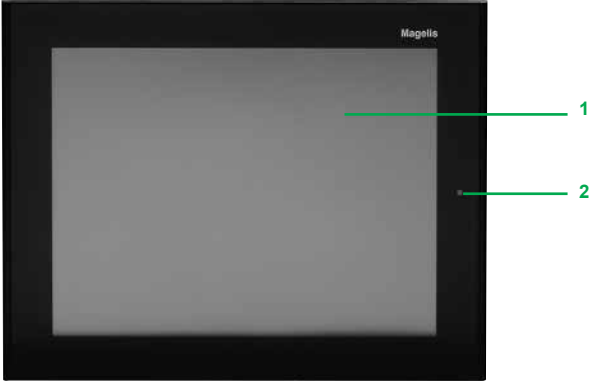

The front panel includes:

- 1 Touch screen for displaying synoptic views (10.4" color STN or 10.4" color TFT, depending on model)
- 2 Multicolor indicator (green, orange and red) showing the terminal's operating mode

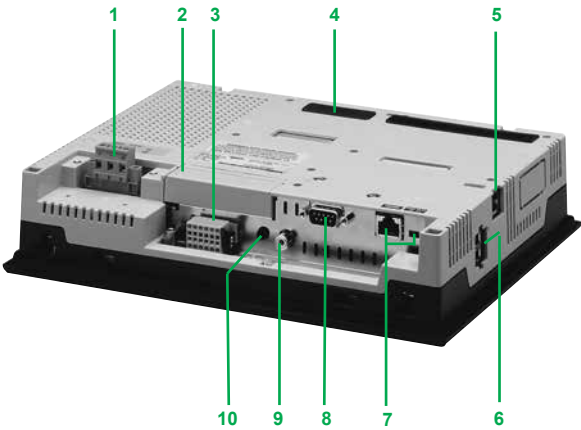

The rear panel includes:

- 1 Removable screw terminal block for 24 V $\bar{\text{---}}$ power supply
- 2 Slot for Compact Flash memory card, with hinged cover
- 3 Removable I/O connector (1), 12 spring terminals for loudspeaker connection, one input (reset) and 3 outputs (alarm, buzzer, run)
- 4 Expansion unit interface for fieldbus communication card (Device Net, PROFIBUS DP) (2)
- 5 RJ45 connector for Ethernet TCP/IP link, 10BASE-T/100BASE-TX, with an activity LED
- 6 Two USB type A host connectors for connecting peripherals, transferring applications and Modicon M340 terminal port communication
- 7 RJ45 connector for RS 485 (COM2) with switch for polarization of the link used on Modbus
- 8 9-way male SUB-D connector for RS 232C or RS 422/485 serial link to PLCs (COM1)

On XBT GT5340 only:

- 9 Mini-jack connector for connecting a microphone
- 10 RCA connector for connecting a digital or analog video camera (NTSC/PAL)

(1) On model XBT GT5230, this removable terminal block is located on the rear panel of the terminal.

(2) See page 1/69 for details of the required connection accessories.

Description

Standard Advanced Panels Magelis Multifunction XBT GT6300 & XBT GT7340

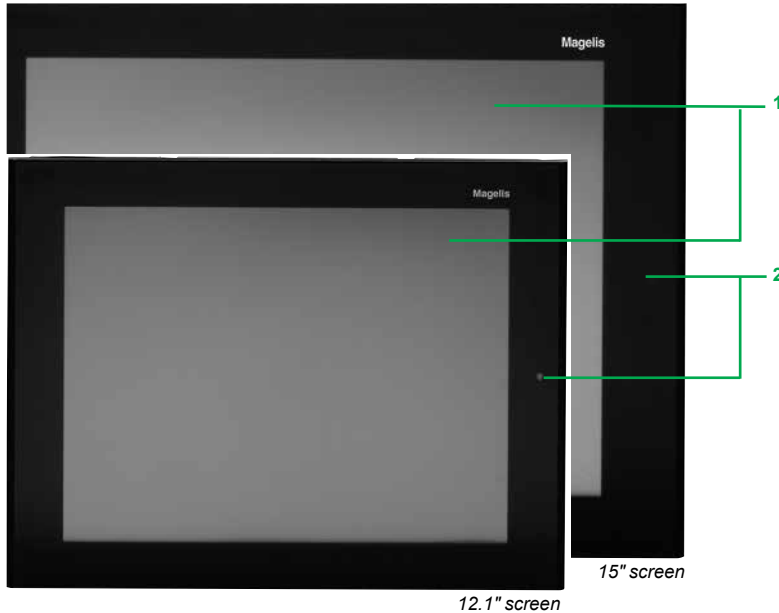

The front panel includes:

- 1 Touch screen for displaying synoptic views (12.1" or 15" color TFT, depending on model)
- 2 Multicolor indicator (green, orange and red) showing the terminal's operating mode

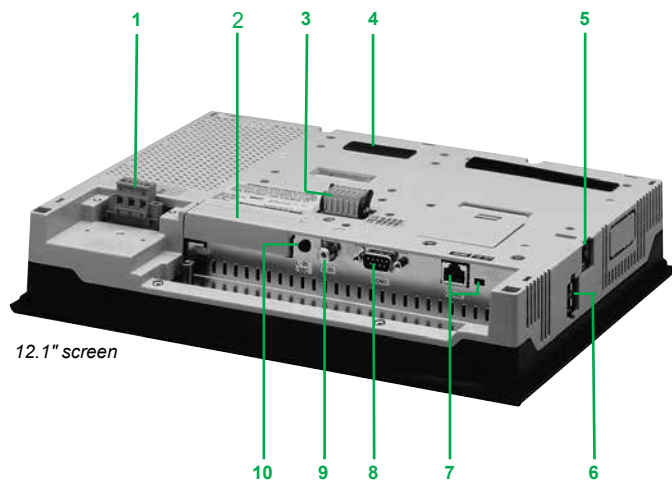

The rear panel includes:

- 1 Removable screw terminal block for 24 V $\bar{\bar{c}}$ power supply
- 2 Slot for Compact Flash memory card, with hinged cover
- 3 Removable I/O connector, 12 spring terminals for loudspeaker connection, one input (reset) and 3 outputs (alarm, buzzer, run)
- 4 Expansion unit interface for fieldbus communication card (Device Net, PROFIBUS DP) (1)
- 5 RJ45 connector for Ethernet TCP/IP link, 10BASE-T/100BASE-TX, with an activity LED
- 6 Two USB type A host connectors for connecting peripherals, transferring applications and Modicon M340 terminal port communication
- 7 RJ45 connector for RS 485 (COM2) with switch for polarization of the link used on Modbus
- 8 9-way male SUB-D connector for RS 232C or RS 422/485 serial link to PLCs (COM1)

On XBT GT6340 and XBT GT7340 only:

- 9 Mini-jack connector for connecting a microphone
- 10 RCA connector for connecting a digital or analog video camera (NTSC/PAL)

(1) See page 1/69 for details of the required connection accessories.

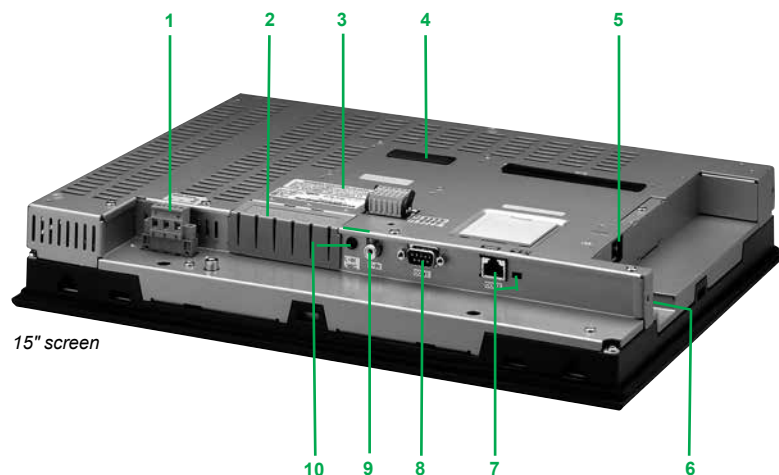

Description

Standard Advanced Panels Magelis Multifunction XBT GK2120 & XBT GK2330

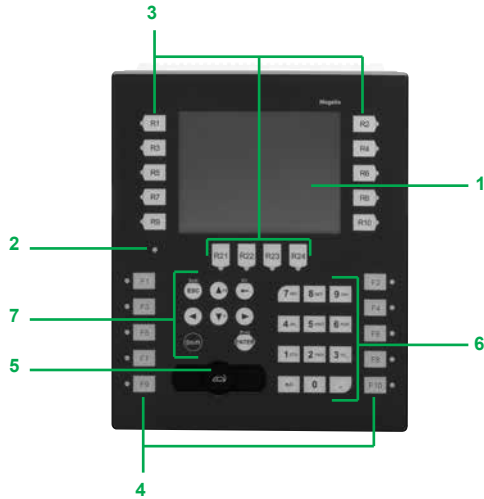

The front panel includes:

- 1 Touch screen for displaying synoptic views (5.7" monochrome or color), configurable using Vijeo Designer
- 2 Multicolor indicator (green, orange and red) showing the terminal's operating mode
- 3 14 dynamic keys (Ri) with 3-color LED (green, orange, red)
- 4 10 static keys (Fi) with 3-color LED (green, orange, red) and customizable labels
- 5 Industrial pointer "⌂", configurable using Vijeo Designer
- 6 12 alphanumeric keys (0 to 9, +/-, .), which can be pressed several times in succession to access characters (A to Z)
- 7 8 service keys:

- Delete character to left of cursor
- Move cursor to right or left in an entry field
- Confirm a selection or entry
- Access the second of the dual key functions
- Increment or decrement a numeric field value or activate the next or previous object
- Exit entry mode

"Plus" commands:

- Display the configuration menu of the terminal
- Copy the current screen
- Delete entire field

The rear panel includes:

- 1 Removable screw terminal block for 24 V $\bar{\text{---}}$ power supply
- 2 USB type A host connector for connecting peripherals, transferring applications and Modicon M340 terminal port communication
- 3 9-way male SUB-D connector for RS 232C or RS 422/485 serial link to PLCs (COM1)
- 4 Expansion unit interface for fieldbus communication card (Device Net, PROFIBUS DP) (1)
- 5 Switch for polarization of the COM2 serial link, used on Modbus
- 6 RJ45 connector for RS 485 serial link (COM2)
- 7 Slot for Compact Flash memory card, with cover

On GK2330 only:

- 8 RJ45 connector for Ethernet TCP/IP link, 10BASE-T/100BASE-TX

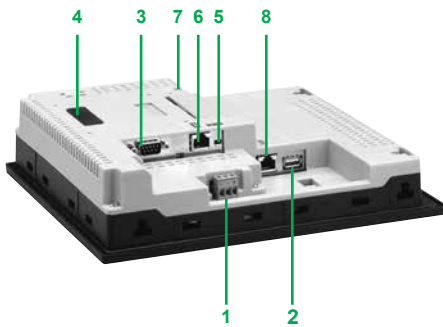

(1) See page 1/69 for details of the required connection accessories.





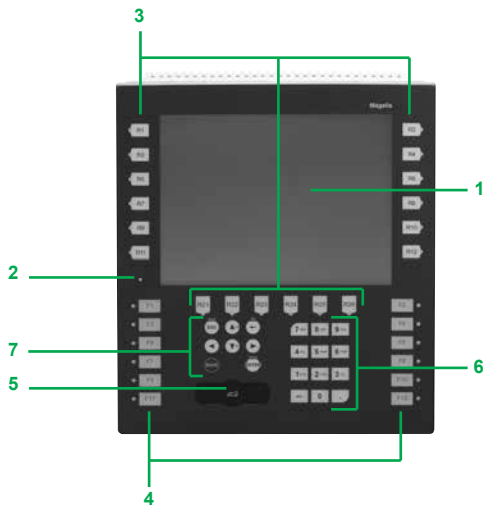

Description

Standard Advanced Panels Magelis Multifunction XBT GK5330





The front panel includes:

- 1 Touch screen for displaying synoptic views (10.4" color TFT), configurable using Vijeo Designer
- 2 Multicolor indicator (green, orange and red) showing the terminal's operating mode
- 3 18 dynamic keys (Ri) with 3-color LED (green, orange, red)
- 4 12 static keys (Fi) with 3-color LED (green, orange, red) and customizable labels
- 5 Industrial pointer "  ", configurable using Vijeo Designer
- 6 12 alphanumeric keys (0 to 9, +/-, .), which can be pressed several times in succession to access characters (A to Z)
- 7 8 service keys:

-  Delete character to left of cursor
-  Move cursor to right or left in an entry field
-  Confirm a selection or entry
-  Access the second of the dual key functions
-  Increment or decrement a numeric field value or activate the next or previous object
-  Exit entry mode

"Plus" commands:

-  Display the configuration menu of the terminal
-  Copy the current screen
-  Delete entire field

The rear panel includes:

- 1 Removable screw terminal block for 24 V $\bar{\text{---}}$ power supply
- 2 Slot for Compact Flash memory card, with hinged cover
- 3 Removable I/O connector, 12 spring terminals for loudspeaker connection, one input (reset) and 3 outputs (alarm, buzzer, run)
- 4 Expansion unit interface for fieldbus communication card (Device Net, PROFIBUS DP) (1)
- 5 RJ45 connector for Ethernet TCP/IP link, 10BASE-T/100BASE-TX with an activity LED
- 6 Two USB type A host connectors for connecting peripherals, transferring applications and Modicon M340 terminal port communication
- 7 RJ45 connector for RS 485 (COM2) with switch for polarization of the link used on Modbus
- 8 9-way male SUB-D connector for RS 232C or RS 422/485 serial link to PLCs (COM1)

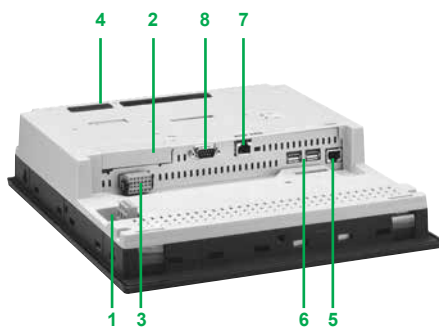

(1) See page 1/69 for details of the required connection accessories.

1

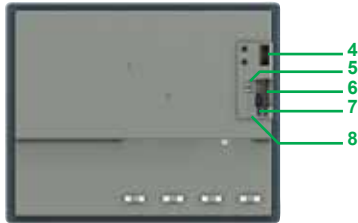
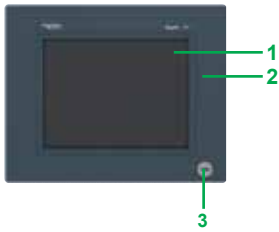

Rear panel

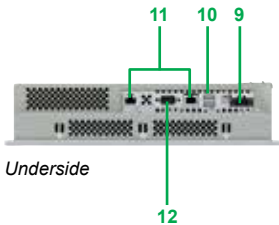

Underside

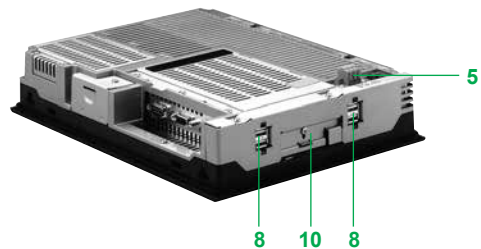
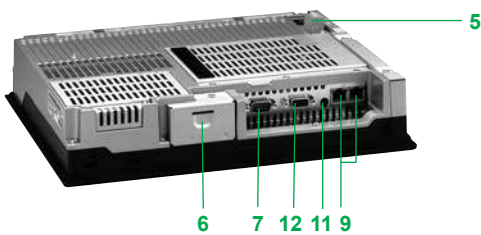
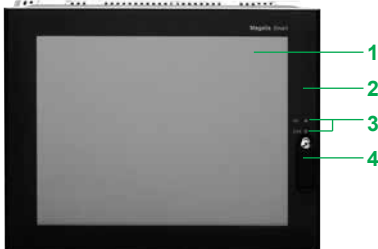

Description

Standard Advanced Panel Magelis Multifunction 10.4" HMI GTW 5354

Front panel screen

The touch screen front panel of terminal **HMI GTW 5354** includes:

- 1 10.4" SVGA active matrix color TFT LCD screen (maximum display area 800 x 600 points) with high-definition analog touch panel
- 2 Aluminum alloy front panel with IP65 membrane
- 3 USB 2.0 port (1 A max.) with screw-on protective cover

Rear panel

The rear panel of terminal **HMI GTW 5354** includes:

- 4 Battery
- 5 Push buttons: 1 for the power supply and 1 for resetting
- 6 Slot for the Compact Flash memory card (SLC technology) ≥ 2 GB specifically for the operating system
- 7 SD card reader for user data - SD card optional (1)
- 8 4 status and power supply LEDs

Underside

All the connection elements can be accessed from the rear of the terminal, with the following elements located on the lower face:

- 9 Removable screw terminal block for connecting 24 V $\overline{\text{DC}}$ power supply
2 slots for Compact Flash card, one containing the operating system and integrated software and the other free
- 10 2 USB 2.0 ports
- 11 2 RJ45 connectors for Ethernet link, 10/100 BASE-TX/1 GB
- 12 9-way male SUB-D connector marked COM1 for RS 232 serial link

Standard Advanced Panel Magelis Multifunction 12" XBT GTW 652

Front panel screen

The touch screen front panel of terminal **XBT GTW 652** includes:

- 1 12" SVGA active matrix color TFT LCD screen (maximum display area 800 x 600 points) with high-definition analog touch panel
- 2 Aluminum alloy front panel with IP65 membrane (mounted on a hardened steel frame)
- 3 2 LEDs marked:
 - ON (green), terminal switched on
 - DISK (green), accessing IDE bus (accessing Compact Flash memory, etc.)
- 4 USB port (dust and damp proof)

Underside and side panels

All expansion slots and connection elements can be accessed from the rear of the terminal, with the following elements located on the lower face:

- 5 Removable screw terminal block for connecting 24 V $\overline{\text{DC}}$ power supply
- 6 Slot for the Compact Flash memory card containing the operating system and integrated software
- 7 25-way female SUB-D connector marked RAS for product monitoring and diagnostics
- 8 4 USB 2.0 ports
- 9 2 RJ45 connectors for Ethernet 10/100 Mbps and Ethernet 10/100 Base-TX/1 GB link
- 10 Slot for additional PCMCIA type II cards
- 11 Mini-jack connector for loudspeaker
- 12 9-way male SUB-D connector marked COM1 for RS 232 serial link

(1) To be ordered separately (see page 3/30).



15" front panels, stainless steel and aluminum



Rear panel

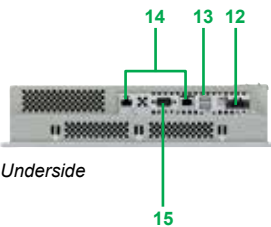

Underside

Description

Standard Advanced Panels Magelis Multifunction 15" HMI GTW 7354 and 73545 Front panel screen

The touch screen front panel of terminal **HMI GTW 7354/73545** includes:

- 1 15" XGA active matrix color TFT LCD screen (maximum display area 1024 x 768 points) with high-definition analog touch panel
 - 2 USB 2.0 port (1 A max.) with screw-on protective cover (only available for aluminum version). Captive protective cover option also available (1)
 - 3 Aluminum alloy front panel with IP65 membrane
- or
- 4 Stainless steel 304 "Scotch brite®" brushed finish front panel enabling an IP65 degree of protection of the front panel when mounted on a panel or an enclosure door. Mounted on 1.6 to 10 mm thick support using screw fasteners supplied (2). Cleaning simplified due to absence of USB port on front panel (conforms to food and beverage processing machines standard EN 1672-2). Version fitted with specific seals (standard FDA 21 CFR 177.206)

Rear panel

The rear panel of terminal **HMI GTW 7354** and **HMI GTW 73545** terminals include:

- 5 Battery
- 6 Push buttons: 1 for the power supply and 1 for resetting
- 7 Slot for the Compact Flash memory card (SLC technology) ≥ 2 GB specifically for the operating system
- 8 SD card reader for user data - SD card optional (1)
- 9 4 status and power supply LEDs

Underside

All the connection elements can be accessed from the rear of the terminal, with the following elements located on the lower face:

- 12 Removable screw terminal block for connecting 24 V $\overline{\text{---}}$ power supply
- 13 2 USB 2.0 ports (1 A max)
- 14 2 RJ45 connectors for Ethernet link, 10/100 BASE-TX/1 GB
- 15 9-way male SUB-D connector marked COM1 for RS 232 serial link

Pre-installed software

Magelis XBT GTW and HMI GTW terminals have the following software installed on the Compact Flash system card, in addition to Windows XP Embedded:

- Vijeo Designer Run-Time, unlimited use, supplied with activation code
- Vijeo Citect Web Client dll
- Internet Explorer
- Acrobat Reader
- Word/Excel/PowerPoint viewer
- Framework.Net

(1) To be ordered separately (see page 3/30).

(2) For installation, see the "Product data sheet" on our website www.schneider-electric.com.

Description

1

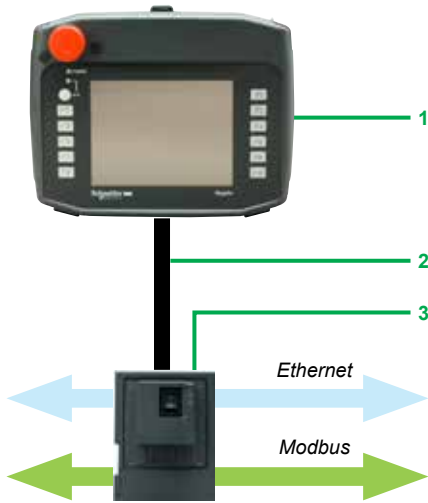

Overview

Magelis XBT GH2460 **1** and XBTGH2460B (without Emergency stop button) are portable graphic display terminals with a 5.7" touch screen. They enable connection on the Ethernet or Modbus network at any point where an XBT ZGJBOX junction box **3** is installed.

The connection between the terminal and junction box is established using an XBT ZGHL●● **2** cable, which is available in various lengths (1).



Standard Advanced Panels Magelis Multifunction XBT GH2460 and XBT GH2460B

The front panel includes:

- 1** Touch screen for displaying synoptic views (5.7" color), configurable using Vijeo Designer
- 2** Multicolor indicator (green, orange and red) showing the terminal's operating mode
- 3** 11 function keys Fi
- 4** Operating key with O.P. LED (green) for touch screen validation
- 5** Emergency stop button with 2 NC safety contacts and 1 NO auxiliary contact for stopping the machine if necessary (model XBT GH2460 only)



The rear panel includes:

- 6** USB type A host connector for peripheral connection and application transfer (with protective cover)
- 7** Slot for a Compact Flash memory card (also protected by the cover)
- 8** Key switch for switching the Magelis XBT GH on/off
- 9** 3-position enabling grip switch for protecting the operator (the OK signal is only sent when the grip switch is in the center position)
- 10** 24-way connector for connecting the 3 m or 10 m flexible interface cable between the Magelis XBT GH and the junction box
- 11** Stylus for the touch screen
- 12** Two holes for inserting re-usable labels in the function keys

(1) To be ordered separately (see page 1/59).



Description (continued)

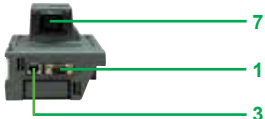

XBT ZGJBOX junction box for XBT GH

It includes:

- 1 9-way SUB-D connector for RS 232C or RS 422/485 serial link to PLCs (COM1)
- 2 ON/OFF switch for the junction box
- 3 RJ45 connector for Ethernet TCP/IP link, 10BASE-T/100BASE-TX
- 4 24-way screw terminal block for connecting 24 V $\bar{\text{---}}$ power supply and output signals from the Magelis XBT GH terminal
- 5 LED indicating the status of the link with the Magelis XBT GH, 3 colors (green, orange and red)
- 6 2 thumbwheels for configuring the station number on the junction box
- 7 32-way connector for connecting the Magelis XBT GH terminal using flexible cable (XBT ZGHL)

Flexible cables XBT ZGHL

For connecting the Magelis XBT GH terminals to their XBT ZGJBOX junction boxes.

4 cable lengths are available:

- 3 m, cable XBT ZGHL3
- 5 m, cable XBT ZGHL5
- 10 m, cable XBT ZGHL10
- 20 m, cable XBT ZGHL20 with the following limitations applying to the junction box: no RS 232C serial link, an isolation box cannot be used and a 24 V $\bar{\text{---}}$ supply voltage tolerance of approximately 10%.

1



XBT GT21●0/2220/2330

Monochrome touch screen terminals (1)							
Type of screen	Number of ports	Application memory capacity	Compact Flash memory	Composite video input	Number of Ethernet ports	Reference	Weight kg
Multifunction, 5.7" QVGA screen							
STN	1 COM1	16 MB	Yes	No	–	XBT GT2120	1.000
Black and white	1 COM2 1 USB				1	XBT GT2130	1.000



XBT GT4230/43●0

Color touch screen terminals (1)							
Type of screen	Number of ports	Application memory capacity	Compact Flash memory	Composite video input	Embedded Ethernet	Reference	Weight kg
Multifunction, 5.7" QVGA screen							
STN	1 COM1 1 COM2 1 USB	16 MB	Yes	No	–	XBT GT2220	1.000
TFT	1 COM1 1 COM2 1 USB	16 MB	Yes	No	1	XBT GT2330	1.000
TFT High Brightness	1 COM1 1 COM2 1 USB	16 MB	Yes	No	1	XBT GT2930	1.000



XBT GT53●0

Multifunction, 5.7" VGA screen							
TFT	1 COM1 1 COM2 2 USB	32 MB	Yes	No	1	XBT GT2430	–



XBT GT63●0

Multifunction, 7.5" VGA screen							
STN	1 COM1 1 COM2 1 USB	32 MB	Yes	No	1	XBT GT4230	1.800
TFT	1 COM1 1 COM2 1 USB	32 MB	Yes	No	1	XBT GT4330	1.800
				Yes	1	XBT GT4340	1.800



XBT GT7340

Multifunction, 10.4" VGA screen							
TFT	1 COM1 1 COM2 2 USB	32 MB	Yes	No	1	XBT GT5330	2.500
				Yes	1	XBT GT5340	2.500
Multifunction, 10.4" SVGA screen							
TFT	1 COM1 1 COM2 2 USB	32 MB	Yes	No	1	XBT GT5430	2.500
Multifunction, 12.1" SVGA screen							
TFT	1 COM1 1 COM2 2 USB	32 MB	Yes	No	1	XBT GT6330	3.000
				Yes	1	XBT GT6340	3.000
Multifunction, 15" XGA screen							
TFT	1 COM1 1 COM2 2 USB	32 MB	Yes	Yes	1	XBT GT7340	5.600

(1) Mounting kit (screw clips), locking device for USB connectors (except XBT GT 11●0) and instruction sheet included with terminals. Setup documentation for XBT GT terminals is included in electronic format with Vijeo Designer configuration software (see page 4/13).



XBT GK2120/2330



XBT GK5330



XBT GH2460



XBT ZGJBOX

XBT ZGHL●●

Keypad/touch screen terminals (1)

Type of screen	Number of ports	Application memory capacity	Compact Flash memory	Video input	Number of Ethernet ports	Reference	Weight kg
Multifunction, 5.7" screen							
STN Black and white	1 COM1 1 COM2 1 USB	32 MB	Yes	No	–	XBT GK2120	–
Multifunction, 5.7" screen							
TFT Color mode	1 COM1 1 COM2 1 USB	32 MB	Yes	No	1	XBT GK2330	–
Multifunction, 10.4" screen							
TFT Color mode	1 COM1 1 COM2 2 USB	32 MB	Yes	No	1	XBT GK5330	–

Portable touch screen terminals

Type of front panel	Number of ports	Application memory capacity	Compact Flash memory	Video input	Number of Ethernet ports	Reference	Weight kg
Multifunction, 5.7" screen							
TFT color mode screen and Emergency stop button	1 COM1 1 USB	32 MB	Yes	No	1	XBT GH2460 (2)	–
TFT color mode screen	1 COM1 1 USB	32 MB	Yes	No	1	XBT GH2460B (2)	–

Connection components

Description	Usage	Length	Reference	Weight kg
Junction box for XBT GH	Specifically for the XBT GH terminal, it enables: <ul style="list-style-type: none"> ■ 24 V $\overline{\text{DC}}$ power supply to XBT GH terminal ■ Connection of various safety inputs/outputs ■ Connection on multiprotocol serial link (9-way SUB-D) or Ethernet TCP/IP (RJ45) Can be mounted on 35 mm U_L rail	–	XBT ZGJBOX (2) (3)	–
Interface cable for XBT GH	For connecting XBT GH terminal to junction box XBT ZGJBOX	3 m	XBT ZGHL3	–
		5 m	XBT ZGHL5	–
		10 m	XBT ZGHL10	–
		20 m	XBT ZGHL20 (4)	–

(1) Mounting kit (spring clips), locking device for USB connectors, customizable label sheets and instruction sheet included with terminals.

(2) The XBT GH terminal is connected to junction box XBT ZGJBOX using the cable XBT ZGHL●●, to be ordered separately (see table below).

(3) A junction box is required at each XBT GH terminal connection point.

(4) With this cable, the following limitations apply to the junction box:

- no RS 232C serial link
- an isolation box cannot be used
- 24 V $\overline{\text{DC}}$ supply voltage tolerance of approximately 10%

1

Open touch screen terminals (1)

Type of screen	Number of ports	Application memory capacity on primary storage device	Secondary storage device	Video input	Number of Ethernet ports	Reference	Weight kg
----------------	-----------------	---	--------------------------	-------------	--------------------------	-----------	--------------

Multifunction, 10.4" screen

TFT	1 COM1 3 USB	2 GB CF card for system and application	SD card ≥ 4 GB	No	2	HMI GTW5354	4.100
-----	-----------------	--	-------------------	----	---	--------------------	-------



HMI GTW5354

Multifunction, 12" screen

TFT	1 COM1 5 USB	2 GB CF card for system and application	CF card ≥ 1 GB	No	2	XBT GTW652	3.800
-----	-----------------	--	-------------------	----	---	-------------------	-------



XBT GTW652

Multifunction, 15" screen

TFT	1 COM1 3 USB	2 GB CF card for system and application	SD card ≥ 4 GB	No	2	HMI GTW7354	6.100
-----	-----------------	--	-------------------	----	---	--------------------	-------



HMI GTW7354

	1 COM1 2 USB	2 GB CF card for system and application	SD card ≥ 4 GB	No	2	HMI GTW73545	6.300
--	-----------------	--	-------------------	----	---	---------------------	-------

(1) Mounting kit (screw clips), locking device for USB connectors and instruction sheet included with terminals. Setup documentation for GTW terminals is included in electronic format with Vijeo Designer configuration software (see page 4/13).



XBT ZGM●●●

Separate components				
Description	Specifications	Compatible with terminals	Reference	Weight kg
Compact Flash memory cards	128 MB, blank	XBT except XBT GT1●●●/GT2110 and XBT GTW	XBT ZGM128	0.050
	256 MB, blank		XBT ZGM256	0.050
	512 MB, blank		MPC YN0 0CFE 00N	0.050
	1 GB, blank	XBT except XBT GT1●●● / GT2110	MPC YN0 0CF1 00N	–
	2 GB, blank		MPC YN0 0CF2 00N	–
	4 GB, blank		MPC YN0 0CF4 00N	–
SD memory card	4 GB, blank	HMI GTO and HMI GTW only	HMI ZSD4G	–
Maintenance kits	Includes fixings and seals for panel mounting	MPC ST1 1N●J 00T (8.4" screen)	MPC YK1 0MNT KIT	–
		MPC ST2 1N●J20● (12" screen)	MPC YK2 0MNT KIT	–
		MPC ST5 2NDJ 10 (15" screen)	MPC YK5 0MNT KIT	–
Protective sheets (5 peel-off sheets)	–	XBT GT1105 / GT1135 / GT1335	XBT ZG60	–
		XBT GT21●0 / GT2220 / GT2●30	XBT ZG62	0.200
		XBT GT4230 / GT43●0	XBT ZG64	0.200
		XBT GT53●0 / XBT GT54●0	XBT ZG65	0.200
		XBT GT5230 / GT63●0	XBT ZG66	0.200
		XBT GK 2●●0 / GH2460	XBT ZG68	–
		XBT GK 5330	XBT ZG69	–
		XBT GT7340 / HMI GTW 7353	MPC YK5 0SPS KIT	0.200
		XBT GTW652	MPC YK2 0SPS KIT	–
		HMI GTO1300 / 1310	HMI ZG60	–
		HMI GTO2300 / 2310 / 2315	HMI ZG62	–
		HMI GTO3510	HMI ZG63	–
		HMI GTO4310	HMI ZG64	–
		HMI GTO5310 / 5315	HMI ZG65	–
		HMI GTO6310 / 6315	HMI ZG66	–
		Plastic protective covers Sold in lots of 5	–	XBT GT2●●●
XBT GT53●●	XBT ZG71			–
Plastic covers for harsh environments (IP67 protection)	–	HMI GTO1300 / HMI GTO1310	HMI ZECOV1	–
		HMI GTO2300 / HMI GTO2310	HMI ZECOV2	–
		HMI GTO3510 / HMI GTO4310	HMI ZECOV4	–
		HMI GTO5310 / HMI GTO5315	HMI ZECOV5	–
		HMI GTO6310 / HMI GTO6315	HMI ZECOV6	–

Separate components (continued)

Description	Specifications	Compatible with terminals	Reference	Weight kg
Spring mounting clips Sold in lots of 12	Number of spring clips depending on terminal	XBT GT	XBT Z3002	–
Wall mounting kit	Mounting components for mounting XBT GH terminal on a wall	XBT GH	XBT ZGWMKT	–
Neck strap	For use with XBT GH hand-held terminal	XBT GH	XBT ZGNSTP	–
Cover for shunt Emergency stop on junction box	Enables deactivation of the junction box terminal without activating the Emergency stop (requires installation of external switching system)	XBT GH	XBT ZGHCAP	–

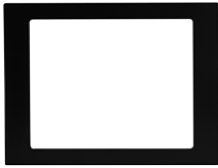

XBT ZGCO●

Description	Description	Length m.	Reference	Weight kg
Mechanical adaptors for substitution of terminals for the Magelis range	From XBT F032●10 to XBT GT2●●0	–	XBT ZGCO1	–
	From XBT G2110 to XBT GT2●●0	–	XBT ZGCO2	–
	From XBT F034●●● to XBT GT53●0	–	XBT ZGCO3	–
	From XBT G5330 to XBT GT5330 From XBT GT5230 to HMI GTO5310	–	XBT ZGCO4	–



XBT ZGUSB

Remote USB port for terminals XBT GT2●●0 to GT7340, XBT GT1●●5, XBT GK●●●, XBT GTW●●●	Enables the USB type A port to be located remotely on the rear of the XBT terminal on a panel or enclosure door (Ø 21 mm mounting device)	1	XBT ZGUSB	–
Remote USB port for terminals XBT GT2●●0 to GT7340, XBT GT1●●5, XBT GK●●●, XBT GTW●●●, HMI GTO	Enables the USB mini-B port to be located remotely on the rear of the XBT or HMI GTO terminal on a panel or enclosure door (Ø 21 mm mounting device)	1	XBT ZGUSBB	–
Remote USB port for HMI GTO panel	Enables the USB mini-B port to be located remotely on the rear of the HMI GTO panel, on a panel or enclosure door (Ø 21 mm mounting device)	1	HMI ZSUSBB	–
Adaptor for Compact Flash cards	Enables a PC with a PCMCIA card slot to take a Compact Flash card	–	XBT ZGADT	0.050

Operator dialog terminals

Magelis Advanced Panels

Replacement parts for terminals

Magelis GT/GTO/GK/GH/GTW

Replacement parts			
Description	For use with terminals	Reference	Weight kg
Seals	XBT GH (for junction box)	XBT ZG5H	–
	XBT GT1105 / GT1135 / GT1335	XBT ZG51	0.030
	XBT GT21●0 / GT2220 / GT2330	XBT ZG52	0.030
	XBT GT4230 / GT43●0	XBT ZG54	0.030
	XBT GT53●0	XBT ZG55	0.030
	XBT GT5230 / GT63●0	XBT ZG56	0.030
	XBT GT7340	XBT ZG57	0.030
	XBT GK2●●0	XBT ZG58	–
	XBT GK5330	XBT ZG59	–
	HMI GTO1300 / 1310	HMI ZG51	–
	HMI GTO2300 / 2310	HMI ZG52	–
	HMI GTO2315	HMI ZG522	–
	HMI GTO3510 / 4310	HMI ZG54	–
	HMI GTO5310	HMI ZG55	–
	HMI GTO5315	HMI ZG552	–
	HMI GTO6310	HMI ZG56	–
	HMI GTO6315	HMI ZG562	–
	Backlighting lamps	XBT GT5230	XBT ZG43
XBT GT53●0		XBT ZG45	0.200
XBT GT53●0 PV ≥ 3 / XBT GT54●0		XBT ZG45B	0.200
XBT GT63●0		XBT ZG46	0.200
XBT GT7340		XBT ZG47	0.200
USB fastenings Sold in lots of 5	XBT GT2●●0 / GT4●●0	XBT ZGCLP1	–
	XBT GT1●●5 / GT5●●0 / GT6●●0 / GT7●●0	XBT ZGCLP2	–
	XBT GK	XBT ZGCLP3	–
	HMI GTO (USB type A)	HMI ZGCLP1	–
	HMI GTO (USB type mini-B)	HMI ZSCLP3	–
Mounting kit	4 clips and screws (max. tightening torque: 0.5 Nm), supplied with all XBT GT terminals	XBT ZG Mount	0.100
	4 clips and screws (max. tightening torque: 0.5 Nm), supplied with all HMIGTO●●●0 terminals	HMI ZGFIX	0.030
	8 nuts and 4 L-shaped brackets, supplied with all HMIGTO●●●5 terminals	HMI ZGFIX2	0.030
Extension connector protection	XBT GT/GK, except XBT GT1●●●	XBT ZGCNC	0.030
Power supply connector Sold in lots of 5	XBT GT1●●● / GT2●●● / GT4●●●	XBT ZGPWS1	0.030
	XBT GK2●●●		
	XBT GT5●●● / 6●●● / 7●●●	XBT ZGPWS2	–
	XBT GK5●●●		
	XBT GTW●●●		
HMI GTO (direct connection)	HMI ZGPWS	0.030	
HMI GTO (right angle connection)	HMI ZGPWS2	0.030	
Auxiliary connector	XBT GT4●●● / 5●●● / 6●●● / 7●●●, XBT GK5●●●	XBT ZGAUX	–
Sheets of customizable labels for XBT GK/GH terminals Sold in lots of 10	XBT GK2●●0	XBL YGK2	0.030
	XBT GK5●●●	XBL YGK5	–
	XBT GH	XBL YGH2	–
Sheets of customizable labels for HMI GTO terminals	HMI GTO1300 / 1310	HMI ZLYGO1	–
	HMI GTO3510	HMI ZLYGO3	–
Stylus Sold in lots of 5	XBT GH	XBT ZGPEN	–
Emergency stop button protection	XBT GH	XBT ZGESGD	–
Hand strap	XBT GH	XBT ZGHSTP	–
Battery	HMI GTO except HMI GTO1300 / 1310 / 2300	HMI ZGBAT	–

Cables for application transfer - Terminal to PC

Type of terminal (terminal end connector)	Connector (PC end)	Type	Length m	Reference (1)	Weight kg
XBT GT2●●0 to GT7340, XBT GT1●●5, XBT GK, XBT GH XBT GTW	USB	TTL	2	XBT ZG935	0.290
HMI GTO	USB	USB	1.80	BMX XCAUSBH018	–

Printer connection cables

Type of printer (2)	Connector (printer end)	Type	Length m	Reference	Weight kg
Serial printer for XBT GT/GK/GTW terminals (except XBT GT1●●●) and HMI GTO panels (except HMI GTO1310)	SUB-D female 25-way	RS 232C (COM1)	2.5	XBT Z915	0.200
Serial printer for XBT GT/GK/GTW terminals and HMI GTO panels	USB	RS 232C (COM1)	1.80	HMI ZURS	–

Adaptors and isolation boxes for XBT terminals and HMI GTO panels

These 3 adaptors are used with the connection cables depending on the application concerned.
For example, the XBT Z968 cable is used with the XBT ZG909 adaptor, to connect a Twido controller (via its terminal port) to an XBT GT2●●0 terminal (via its COM1 port).

Description	Type of connector (automation product end)	Physical link (XBT or HMI GTO terminal end)	Length m	Reference	Weight kg
Adaptor for XBT GT1●●● (COM1 port) XBT GT2●●0 to 7340 XBT GK (COM2 port) HMI GTO	25-way SUB-D connector	RJ 45 connector	0.2	XBT ZG939	–
Adaptors for XBT GT2●●0 to 7340 XBT GK (COM1 port) XBT GTW (COM1 and COM2 ports) HMI GTO (COM1 port)	25-way SUB-D connector	9-way SUB-D connector, RS 485 on XBT terminal only	0.2	XBT ZG909 (3)	–
		9-way SUB-D connector, RS 232C	0.2	XBT ZG919	–



XBT ZGI485

Description	For use with	Link to isolate	Reference	Weight kg
Serial link isolation units for XBT GT2●●0 to 7340 XBT GK HMI GTO	- Connection to serial port of XBT terminal - Isolated link on 9-way SUB-D connector (4) - Box power supply via USB port of terminal. Incorporates a USB port expander.	RS 232C/RS 485 (COM1)	XBT ZGI232	–
		RS 485 (COM2)	XBT ZGI485	–

(1) Cable included (depending on model) with Vijeo Designer software packages (see page 4/13).

(2) Parallel printer (see page 1/37).

(3) This adaptor cannot be used with Magelis GTO terminals.

(4) Male connector with XBT ZGI232, female connector with XBT ZGI485.

Operator dialog terminals

Magelis Advanced Panels

Connection accessories for terminals

Magelis GT/GTO/GK/GH/GTW

Cables for connecting Magelis terminals to other Schneider Electric products

Automation product type	Type of connector (automation product end)	Protocol	Type of terminal	Link	On port	Length m	Reference	Weight kg
Twido, Nano, Modicon TSX Micro, Modicon Premium	Terminal port, 8-way female mini-DIN	Uni-TE (V1/V2), Modbus	XBT GT1●●●	RS 485	COM1	2.5	XBT Z9780	0.180
			XBT GT2●●0 to 7340		COM2	10	XBT Z9782	–
			XBT GT2●●0 to 7340	RS 485	COM1	2.5	XBT Z968 + (2)	0.180
			XBT GK			5	XBT Z9681 + (2)	0.340
			XBT GT2●●0 to 7340	RS 485	COM1	2.5	XBT Z9018	0.170
XBT GK XBT GH (Junction box)								
XBT GTW●●	RS 232	COM1	2.5	TSX PCX 1031	–			
XBT GH (Junction box) HMI GTO								
Modicon M340 Modicon M238 Modicon M258	RJ45	Modbus	XBT GT1●●●	RS 485	COM1	2.5	XBT Z9980	0.230
			HMI GTO		COM2	10	XBT Z9982	–
			XBT GT2●●0 to 7340	RS 485	COM1	1.8	XBT Z938 + (2)	0.230
			XBT GK			2.5	XBT Z9008	–
			XBT GH (Junction box)					
XBT GT (4) XBT GK/GTW HMI GTO	USB	USB type A	1.8 4.5	BMX XCA USB H018 BMX XCA USB H045	0.230 –			
Modicon Premium with TSX SCY 2160●	25-way female SUB-D	Uni-TE (V1/V2)	XBT GT1●●●	RS 485	COM1	2.5	XBT Z918 + (1)	0.230
			XBT GT2●●0 to 7340	RS 485	COM1	2.5	XBT Z918 + (2)	0.230
			XBT GK XBT GH (Junction box)					
Modicon Quantum	9-way male SUB-D	Modbus	XBT GT1●●●	RS 232C	COM1	2.5	XBT Z9710 + (1)	0.210
			XBT GT2●●0 to 7340	RS 232C	COM1	2.5	XBT Z9710 + (3)	0.210
			XBT GK / GTW XBT GH (Junction box) HMI GTO			3.7	990 NAA 263 20	0.290
Modicon STB	HE 13 (NIM, network interface module)	Modbus	XBT GT1●●●	RS 232C	COM1	2.5	XBT Z988 + (1) XBT Z9715	0.220 –
			XBT GT2●●0 to 7340	RS 232C	COM1	2	STB XCA 4002	0.210
			XBT GK / GTW XBT GH (Junction box) HMI GTO			2.5	XBT Z988 + (3)	0.220
Modicon Momentum M1	RJ45 (port 1 on Momentum M1)	Modbus	XBT GT1●●●	RS 232C	COM1	2.5	XBT Z9711 + (1)	0.210
			XBT GT2●●0 to 7340	RS 232C	COM1	2.5	XBT Z9711 + (3)	0.210
			XBT GK XBT GTW XBT GH (Junction box) HMI GTO					
TeSys U, T starters ATV 312/61/71 variable speed drives ATS 48 starters Lexium 05 Preventa XPSMC	RJ45	Modbus	XBT GT1●●●	RS 485	COM1	3	VW3 A8 306 R30	0.060
			XBT GT2●●0 to 7340		COM2	2.5	XBT Z9980	–
			XBT GK		10	XBT Z9982	–	
			HMI GTO					
			XBT GT2●●0 to 7340	RS 485	COM1	2.5	XBT Z9008	–
XBT GK XBT GH (Junction box)								

(1) Adaptor **XBT ZG939** to be used with cables with “ + (1) ” after the reference.(2) Adaptor **XBT ZG909** to be used with cables with “ + (2) ” after the reference.(3) Adaptor **XBT ZG919** to be used with cables with “ + (3) ” after the reference.(4) Except **XBT GT1●●0**.

TSX PCX 1031

Cables and adaptors for connecting Magelis terminals to third-party PLCs

Mitsubishi, Melsec PLCs

Description Driver used	Type of terminal	Type of connector (fitted to cable, excluding adaptor)	Physical link (COM1)	Length m	Reference	Weight kg
Connection cable, A CPU (SIO)	XBT GT2●●0 to 7340 XBT GK XBT GH (Junction box)	9-way SUB-D 25-way SUB-D	RS 422	5	XBT ZG9773	–
Connection cable, Q Link (SIO)	XBT GT2●●0 to 7340 XBT GK / GTW XBT GH (Junction box) HMI GTO	9-way SUB-D 9-way SUB-D	RS 232C	5	XBT ZG9772	–
Connection cable, Q CPU (SIO)	XBT GT2●●0 to 7340 XBT GK / GTW XBT GH (Junction box) HMI GTO	9-way SUB-D mini-DIN	RS 232C	5	XBT ZG9774	–
Connection cable, A Link (SIO)	XBT GT2●●0 to 7340 XBT GK / GTW XBT GH (Junction box) HMI GTO	9-way SUB-D 25-way SUB-D	RS 232C	5	XBT ZG9731	–
Connection cable, FX (CPU)	XBT GT2●●0 to 7340 XBT GK XBT GH (Junction box)	9-way SUB-D mini-DIN	RS 422	5	XBT ZG9775	–
	XBT GT1●●●	25-way SUB-D mini-DIN	RS 422	5	XBT Z980 + (1)	–
	HMI GTO	9-way SUB-D mini-DIN	RS 232/ RS 422	5	HMI Z951	–
Cable for 2-port adaptor, FX (CPU), A CPU (SIO) QnA CPU (SIO)	XBT GT2●●0 to 7340 XBT GK XBT GH (Junction box)	9-way SUB-D Flying leads	RS 422	5	XBT ZG9778 + (4)	–
Adaptor unit FX (CPU), A CPU (SIO) QnA CPU (SIO)	XBT GT2●●0 to 7340 XBT GK XBT GH (Junction box)	2-port unit Screw terminals / 2 x 9-way SUB-D	RS 422	–	XBT ZG979	–



XBT ZG9772



XBT ZG9731

Omron, Sysmac PLCs

Description Driver used	Type of terminal	Type of connector (fitted to cable, excluding adaptor)	Physical link (COM1)	Length m	Reference	Weight kg
Connection cables, Link (SIO)	XBT GT1●●●	25-way SUB-D 9-way SUB-D	RS 232C	2.5	XBT Z9740 + (1) XBT Z9743	0.210 –
	XBT GT2●●0 to 7340 XBT GK/GTW XBT GH (Junction box) HMI GTO	9-way SUB-D 9-way SUB-D 9-way SUB-D 25-way SUB-D	RS 232C	5	XBT ZG9740	–
			RS 232C	5	XBT ZG 9731	–
Connecting cables FINS (SIO)	XBT GT1●●●	25-way SUB-D 9-way SUB-D	RS 232C	2.5	XBT Z9740 + (1) XBT Z9743	0.210 –
	XBT GT2●●0 to 7340 XBT GK/GTW XBT GH (Junction box) HMI GTO	9-way SUB-D 9-way SUB-D	RS 232C	5	XBT ZG9740	–

(1) Adaptor **XBT ZG939** to be used with cables with “ + (1) ” after the reference (see page 1/64).

(4) Adaptor **XBT ZGCOM1** (9-way female/female SUB-D) to be used with cables with “ + (4) ” after the reference (**XBT ZG9778**).

Cables and adaptors for connecting Magelis terminals to third-party PLCs (continued)

Rockwell Automation, Allen-Bradley PLCs

Description Driver used	Type of terminal	Type of connector (fitted to cable, excluding adaptor)	Physical link (COM1)	Length m	Reference	Weight kg
Connection cables <i>DF1 Full Duplex</i>	XBT GT1●●●	25-way SUB-D	RS 232C	2.5	XBT Z9730 + (1)	0.210
		9-way SUB-D			XBT Z9733	–
		25-way SUB-D	RS 232C	2.5	XBT Z9731 + (1)	0.210
		8-way mini-DIN				
	XBT GT2●●0 to 7340 XBT GK/GTW XBT GH (Junction box) HMI GTO	9-way SUB-D 25-way SUB-D	RS 232C	5	XBT ZG9731	–
Connection cables, <i>DH485</i>	XBT GT1●●●	25-way SUB-D	RS 232C	2.5	XBT Z9734	–
		9-way SUB-D				
		25-way SUB-D	RS 485	5	XBT Z9732 + (1)	–
		8-way mini-DIN				
	XBT GT2●●0 to 7340 XBT GK XBT GH (Junction box)	25-way SUB-D 8-way mini-DIN	RS 485	5	XBT Z9732 + (2)	–
	HMI GTO	9-way SUB-D	RS 485	5	XBT Z9732 + (1)	–



XBT ZG9731

Siemens, Simatic PLCs

Description Driver used	Type of terminal	Type of connector (fitted to cable, excluding adaptor)	Physical link	Length m	Reference	Weight kg
Connection cable, <i>PPI, S7 200</i>	XBT GT1●●●	RJ45/9-way SUB-D	RS 485 (COM1)	2.5	XBT ZG9721	–
		XBT GT2●●0 to 7340 XBT GK HMI GTO	RJ45/9-way SUB-D	RS 485 (COM2)		
Connection cables, <i>MPI port, S7 300/400</i>	XBT GT2●●0 to 7340 XBT GK/GTW XBT GH (Junction box) HMI GTO	9-way SUB-D	RS 232C (COM1)	3	XBT ZG9292	–
		9-way SUB-D				
		XBT GT2●●0 to 7340 XBT GK HMI GTO	RJ45/flying leads other end	RS 485 (7) (COM2)	3	VW3 A8 306 D30
		RJ45/9-way SUB-D	RS 485 (7) (COM1 or COM2) (8)	2.5	XBT ZG9721	–

Customizable cables

Description Driver used	Terminal type	Type of connector (fitted to cable, excluding adaptor)	Physical link	Length m	Reference	Weight kg
Universal cable, RS 422	XBT GT2●●0 to 7340 XBT GK XBT GH (Junction box)	9-way SUB-D/flying leads other end	RS 422 (COM1)	2.5	XBT ZG9722	0.210
Universal adaptor, RS 422/485	XBT GT2●●0 to 7340 XBT GK XBT GH (Junction box)	9-way SUB-D/Screw terminal	RS 422 (COM1)	–	XBT ZG949 + (5)	–
		9-way SUB-D/Screw terminal	RS 485 (COM2)	–	XBT ZG949 + (6)	–

(1) Adaptor **XBT ZG939** to be used with cables with " + (1) " after the reference (see page 1/64).

(2) Adaptor **XBT ZG909** to be used with cables with " + (2) " after the reference (see page 1/64).

(5) Cable to be created by user and used in conjunction with 9-way female/female SUB-D adaptor **XBT ZGCOM1**.

(6) Cable to be created by user and used in conjunction with isolation box **XBT ZGI485** and 9-way male/female SUB-D adaptor **XBT ZGCOM2**.

(7) Non-isolated RS 485 serial link, 12 Mbps (187.5 kbps with **XBT GT11●0/2110**).

(8) COM1 for HMI GTO1310, COM2 for the other terminals.

Operator dialog terminals

Magelis Advanced Panels

Connection accessories for terminals

Magelis GT/GTO/GK/GH/GTW

1



TSX SCA 62



TSX P ACC 01



TSX SCA 64



LU9 GC3



VW3 A8 306 TF10



TWDXCAISO

Connection of Magelis terminals via serial links and Ethernet network

Type of bus/network	Tap-off units	Connector (tap-off unit side)	Terminal type	Length m	Reference	Weight kg
Uni-Telway serial link	Subscriber socket TSX SCA 62	15-way female SUB-D	XBT GT1●●● (COM1)	3	VW3 A8 306	0.150
			XBT GT2●●0 to 7340 XBT GK (COM2) HMI GTO			
	Connection box TSX P ACC01	8-way female mini-DIN	XBT GT1●●● (COM1)	1.8	XBT Z908 + (2)	0.240
			XBT GT2●●0 to 7340 XBT GK (COM1) XBT GH (Junction box)			
			XBT GT1●●● (COM1)	2.5	XBT Z9780	0.180
Modbus serial link	Subscriber socket TSX SCA 64	15-way female SUB-D	XBT GT1●●● (COM1)	3	VW3 A8 306	0.150
			XBT GT2●●0 to 7340 XBT GK (COM2) HMI GTO			
	8-port Modbus splitter box LU9 GC3 2-port tap-off junction TWDXCAISO TWDXCAT3RJ	RJ45	XBT GT1●●● (COM1)	1.8	XBT Z908 + (2)	0.240
			XBT GT2●●0 to 7340 XBT GK (COM1) XBT GH (Junction box)			
			XBT GT1●●● (COM1)	2.5	XBT Z9980	–
T-junction box	With integrated cable, RJ45 fitted	XBT GT1●●● (COM1)	2.5	XBT Z9008	–	
		XBT GT2●●0 to 7340 XBT GK (COM1) XBT GH (Junction box)				
Ethernet TCP/IP network	Hubs 499 NEH/NOH Switches 499 NES, 499 NMS, 499 NSS and 499 NOS	RJ45	XBT GT●●30 / ●●40	2	490 NTW 000 02	–
			XBT GK●●30	5	490 NTW 000 05	–
			XBT GTW●●●	12	490 NTW 000 12	–
			XBT GH (Junction box)	40	490 NTW 000 40	–
			HMI GTO	80	490 NTW 000 80	–

(2) Adaptor XBT ZG909 to be used with cables with " + (2) " after the reference (see page 1/64).

Operator dialog terminals

Magelis Advanced Panels

Connection accessories for terminals

Magelis GT/GTO/GK/GH/GTW

Connection of Magelis terminals to fieldbuses

Type of bus/network	Connection components	Type of terminal	Reference	Weight kg
FIPWAY, FIPIO	USB gateway	XBT GT / GK (1) HMI GTO	TSX CUSBFIP	–
Modbus Plus	USB gateway	XBT GT / GK (1) HMI GTO	XBT ZGUMP	–
		XBT GTW	TSX CUSBMBP	–
Profibus DP	Card on expansion bus	XBT GT / GK (1)	XBT ZGPDP	–
Device Net	Card on expansion bus	XBT GT / GK (1)	XBT ZGDVN	–

Modular regulated switch mode power supplies (2)

Input voltage/ Output voltage	Combination with terminals	Nominal power	Nominal current	Reference	Weight kg
100 to 240 / 24 V single-phase wide range line supply 47 to 63 Hz	XBT GT1100 to 6340 XBT GK / GH	30 W	1.2 A	ABL 8MEM24012	0.195
	XBT GT7340 / GTW	60 W	2.5 A	ABL 7RM24025	0.255



ABL 7RM24025

(1) Except XBT GT1●●●.

(2) Dimensions: H x W x D = 90 x 54 x 59 mm (ABL 8MEM24012) and 90 x 72 x 59 mm (ABL 7RM24025). For further information, please consult our website www.schneider-electric.com.

1

XBT GT11●5 terminals, HMI GTO1310 terminals and Schneider Electric products

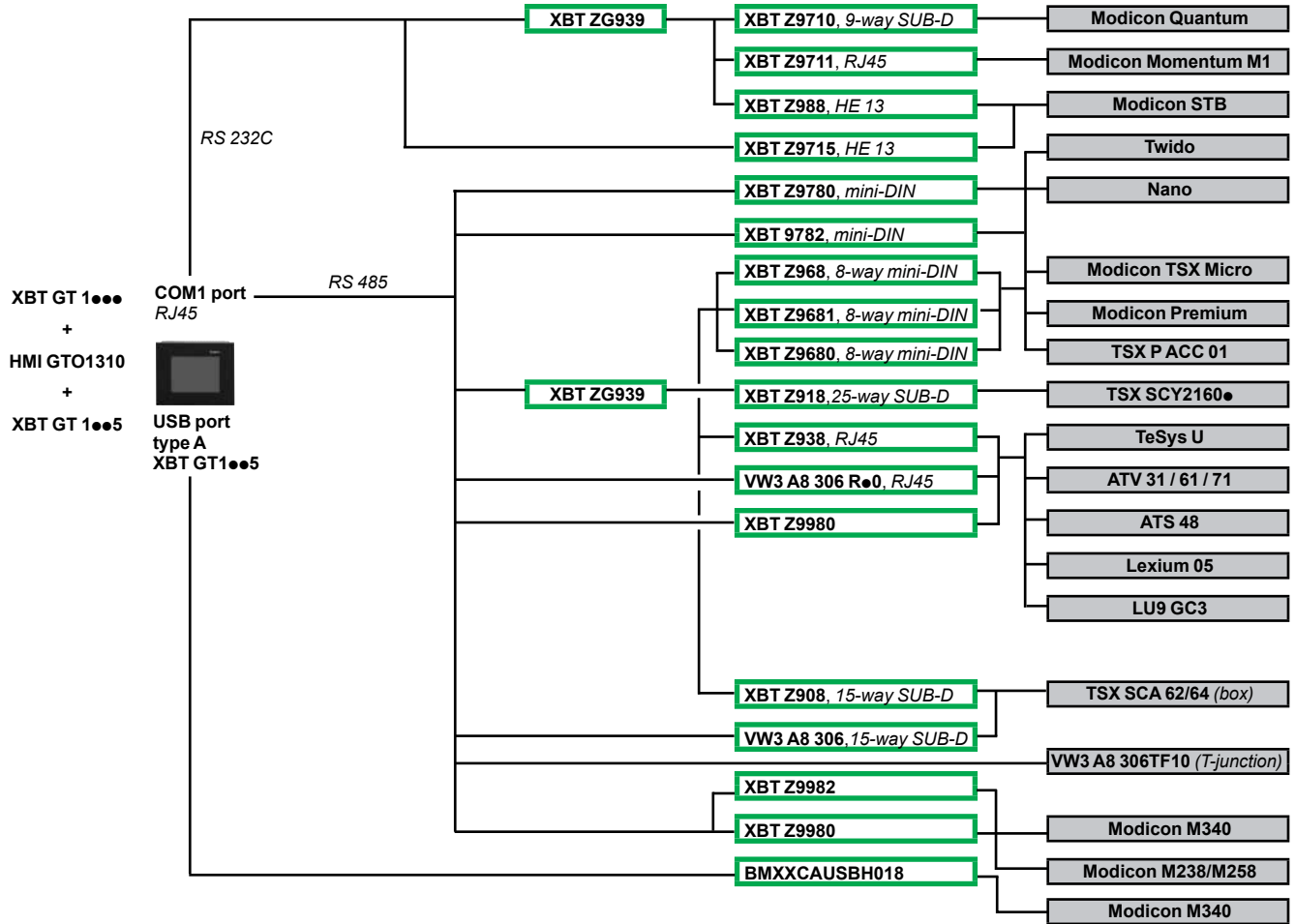

XBT GT2●●0/GT7340/GK●●● terminals, HMI GTO terminals (except HMI GTO1310) and Schneider Electric products

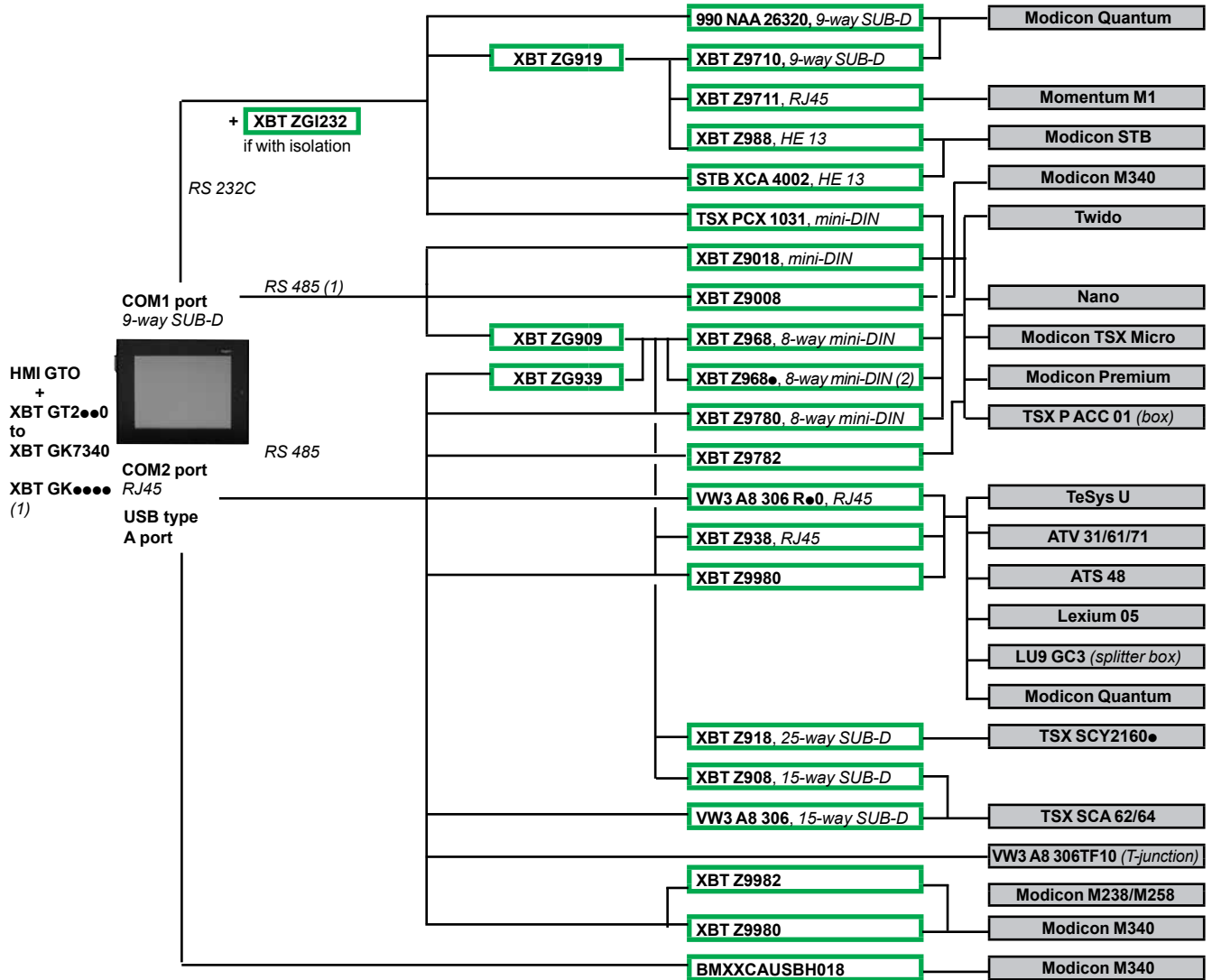

(1) RS485 not available for HMI GTO (COM1).

(2) ● defines the length:

- 0, 2.5 m (elbowed connector)
- 1, 5 m
- 6, 16 m
- 7, 20 m
- 8, 25 m

1

XBT GT11●5 terminals, HMI GTO1310 terminals and third party PLCs

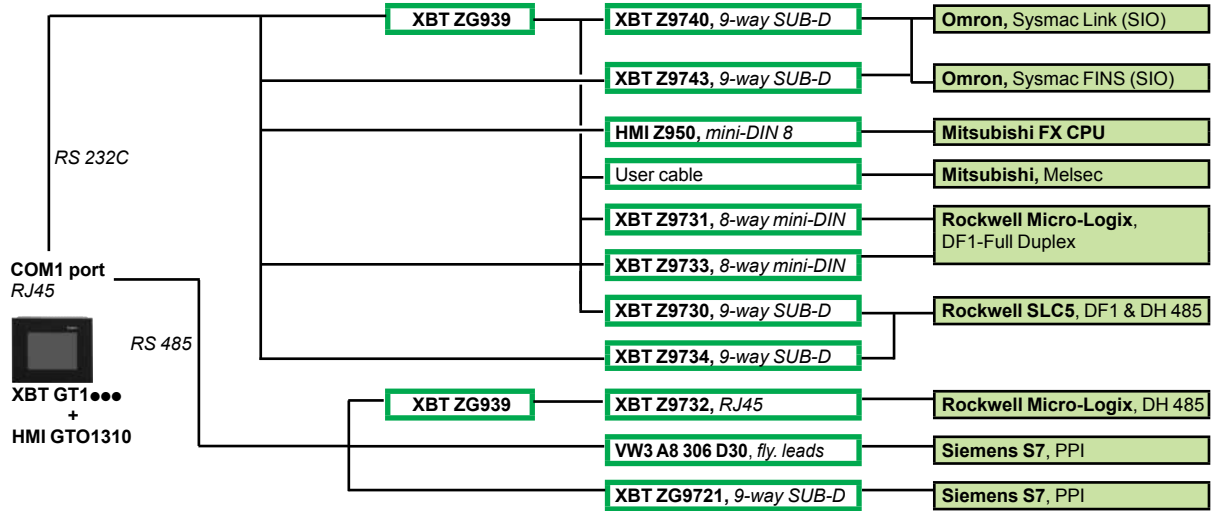

XBT GT2●●0/GT7340/GK●●● terminals, HMI GTO terminals (except HMI GTO1310) and third-party PLCs

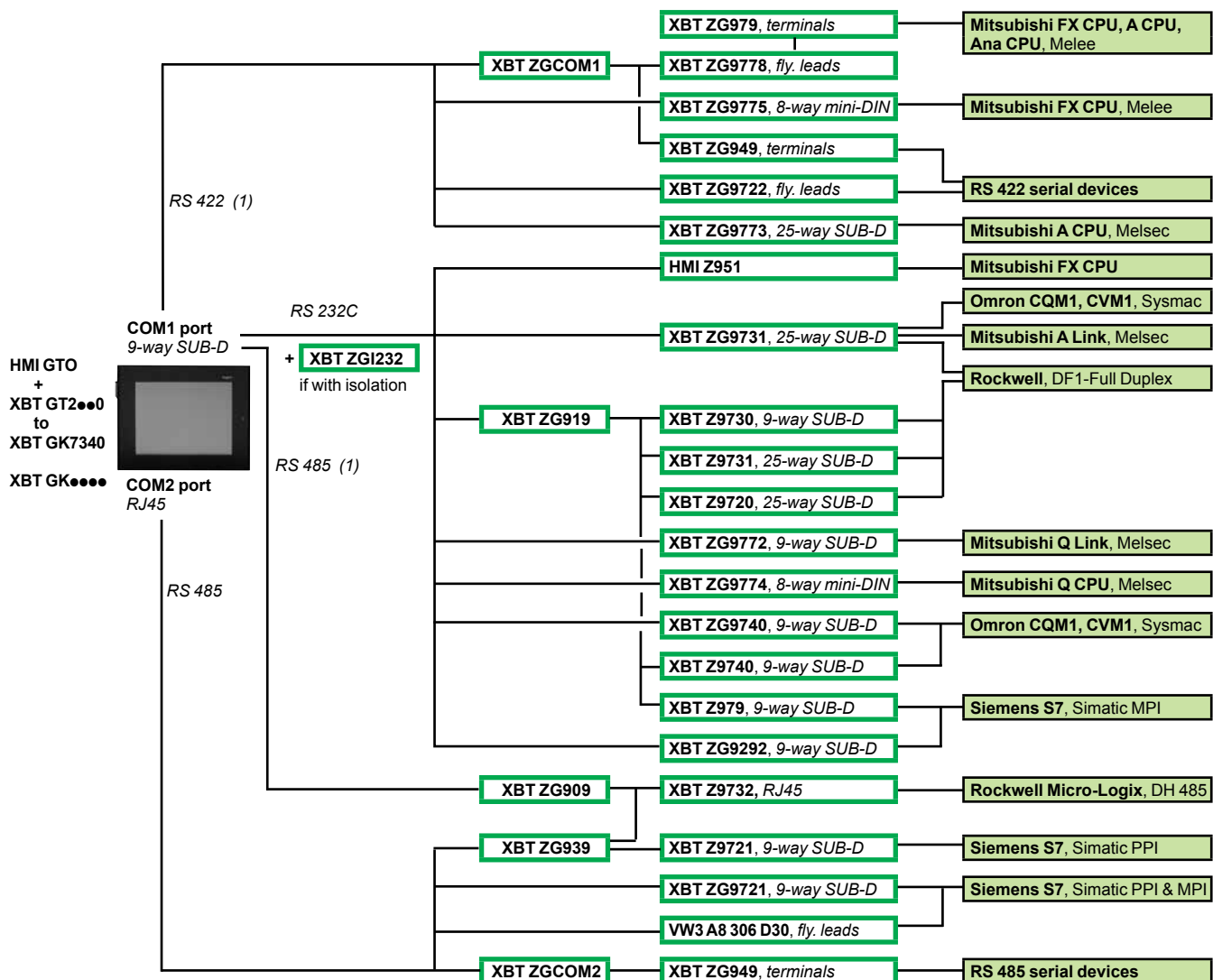

(1) RS 422 and RS 425 not available on HMI GTO (COM1).

Application transfer from XBT GT terminals to PC

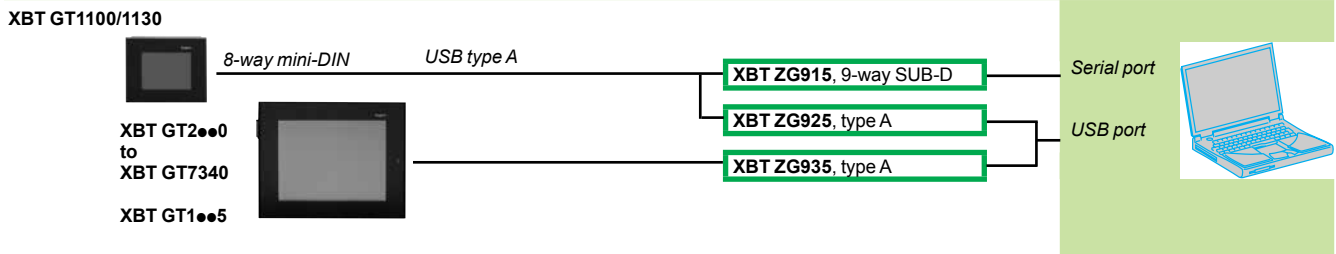

Application transfer from HMI GTO terminals to PC

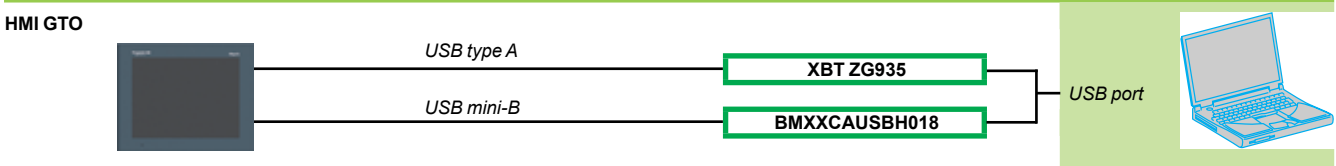

Equivalent product table between XBT GT terminals and HMI GTO terminals		
Old range XBT GT	New range HMI GTO <i>Requires Vijeo Designer ≥ V6.1</i>	Mechanical adaptor
XBT GT1100	HMI GTO1300	–
XBT GT1130	HMI GTO1310	–
XBT GT1105	HMI GTO1300	–
XBT GT1135	HMI GTO1310	–
XBT GT1335	HMI GTO1310	–
XBT GT2110	HMI GTO2300	–
XBT GT2120	HMI GTO2310	–
XBT GT2130	HMI GTO2310	–
XBT GT2220	HMI GTO2310	–
XBT GT2330	HMI GTO2310	–
XBT GT4230	HMI GTO4310	–
XBT GT4330	HMI GTO4310	–
XBT GT5230	HMI GTO5310	XBT ZGC04
XBT GT5330	HMI GTO5310	–
XBT GT6330	HMI GTO6310	–

Comments: when upgrading from the Magelis XBT range to the Magelis GTO Optimum range, the following parameters must be taken into account:

- connection to the Profibus DP and Device Net fieldbuses is not possible,
- a combined RS232/RS422 serial link is not possible with COM1,
- there is no "alarm" output or "loudspeaker" output in the current version of the Optimum range.

Overview

The USB accessories for Magelis™ are designed to expand the selection range of user applications by offering value-added/differentiated HMI solutions. These innovative USB accessories can be easily installed and operated with HMI terminals.

The USB accessories for Magelis terminals include:

- Harmony™ XVGU USB tower lights (see page 1/76)
- Harmony XB5S biometric USB switches (see page 1/80)
- Magelis HMIZ illuminated USB switches (see page 1/82)

The following illustrates the configuration of USB accessories with Magelis HMIs:

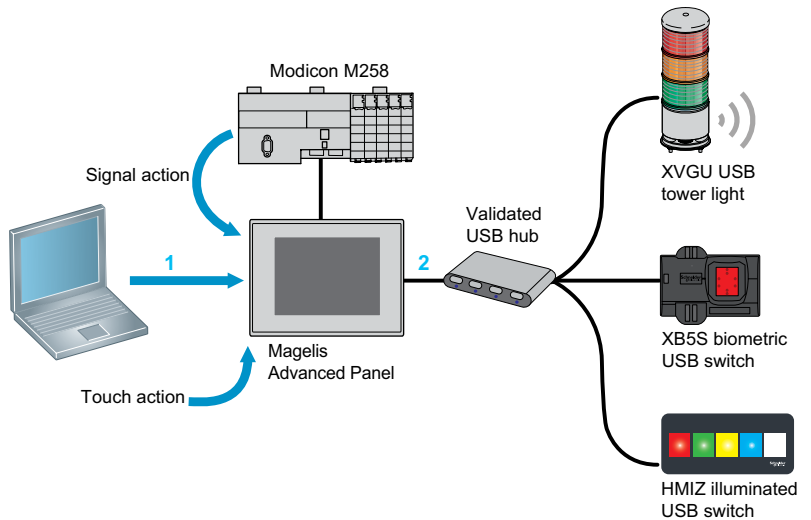

- 1 The HMI application is created on a computer using the Vije Designer HMI configuration software (V6.1 Service pack 2 or higher). The application is then downloaded to the Magelis HMIs via a USB cable for:
 - XVGU tower lights: Setting situation, colors, and buzzer actions
 - XB5S biometric USB switches: Managing the fingerprint database and login of users through fingerprint recognition
 - HMIZ illuminated USB switches: Setting and operating as alarm console (display and acknowledgement) or illuminated function keys
- 2 The USB accessories are connected to Magelis HMI terminals by a USB cable for power supply and data transmission (except for biometric USB switch which has a stand-alone 24V DC power supply). Each Magelis HMI terminal can also support two or more USB accessories (one of each kind) via a USB hub with external power supply.

The following table lists the Magelis HMIs that are compatible with USB accessories.

Magelis HMIs	USB accessories for HMI terminals		
	USB tower lights XVGU3S●●●	Biometric USB switches XB5SB2L2	Illuminated USB switches HMIZRA1
Magelis iPC	No	Yes	Yes
XBTGT (except GT1000 series)	Yes	Yes	Yes
XBTGK	Yes	Yes	Yes
XBTGC	Yes	Yes	Yes
HMIGTW	No	Yes	Yes
HMIGTO	Yes	Yes	Yes
HMIGXO	Yes	Yes	Yes
HMISTU	No	Yes	No
HMISTO	No	No	No
HMISCU (according to version)	Yes	Yes	Yes

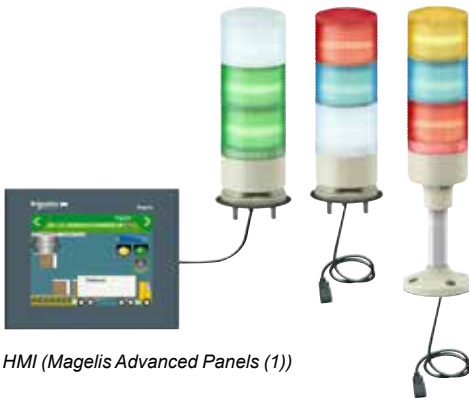

HMI (Magelis Advanced Panels (1))

Introduction

The monolithic USB tower lights of the Harmony™ XVGU product range are designed to support HMI (Magelis™ Advanced Panels (1)). These new tower lights with multi-color LEDs are unique and simple-to-use as the states and patterns are directly set and modified in the HMI application.

The XVGU tower lights provide long distance indication of the operating status or sequences of a machine or installation, both visually (by means of illuminated signaling units with 360° visibility), and audibly (by means of a buzzer).

- The tower light comes with a pre-assembled USB cable for simple wiring and easy integration with the Magelis Advanced Panels (1) (2).

- The tower light settings are selected from the Set screen of the HMI application at the time of integration.

- The multi-color LEDs on all the three levels can be set to many possible color combinations (red, orange, green or blue) for sophisticated signaling.

- The 2-tone buzzer volume and alarm type (4 pre-recorded types) can be set easily.

- The tower lights are easy to order as many customized configurations can be made from a single part number.

- The product range involves 60 mm/2.36 in. products and is therefore ideal for use in many activity sectors (textiles, packaging, baggage handling). It is also ideal for use with metal tools, plastic extrusion machines and assembly lines. This range is only for indoor applications.

XVGU tower lights are supplied:

- with 3 multi-color LEDs and a clear lens,

- with a 2-tone buzzer,

- with pre-assembled USB cable for easy connection (2),

- with USB cable clamp for firm connection,

- fitted with one of the following mounting options:

- direct base mounting (IP 42),

- aluminum tube mounting and mounting plate (IP 42).

(1) Please refer to "USB tower lights compatible with Magelis Advanced Panels" table on page 1/79.

(2) For extension, use either the Schneider Electric USB cable (BMXXCAUSBH018) or a third-party USB Type A/mini B cable of maximum length 4 m/13.12 ft.

Introduction (continued)

The following illustrates the integration of XVGU tower lights with the Magelis™ Advanced Panels (1).

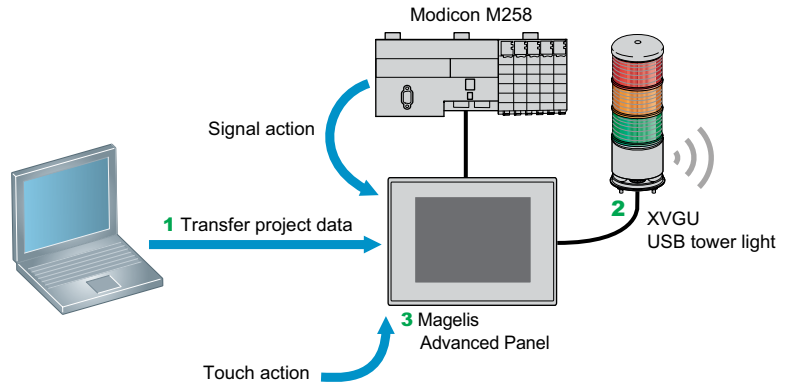

1 The HMI application is created on a computer using the Vijeo designer HMI editor software (V6.1 Service pack 1 or higher). It is then downloaded to the Magelis Advanced Panel (1) via a USB cable for setting situation, color, and buzzer actions.

2 The tower light's pre-assembled USB cable is connected to the Magelis terminal for power supply and signal transmission (2).

3 The LED colors, flashing patterns, and buzzer tones are set and modified in the HMI Set screen.

Illuminated signaling

The light source consists of three multi-color LEDs (red, orange, green or blue) completed with a clear lens to provide an aesthetic look and reliable signaling (clear lenses help to avoid color reflectance in bright environments). When LEDs are not powered, the tower lights appear translucent. The LED colors can be set to many possible combinations of red, orange, green, and blue.

Audible signaling

The tower light is supplied with a 2-tone buzzer audible signaling unit, the volume of which can be adjusted up to 85 dB. This audible unit with 4 pre-recorded alarm types is located in the base of the tower light.

Environment

The XVGU tower lights are CE certified and conform to EN 61000-6-2 and EN 61000-6-4 standards.

Cabling

XVGU tower lights have pre-assembled USB cable with "Type A female" connector to attach to any standard USB mini B cable. A clamp is provided to prevent unintended removal or disconnection of the tower light from the Magelis Advanced Panel.

(1) Please refer to "USB tower lights compatible with Magelis Advanced Panels" table on page 1/79.

(2) For extension, use either the Schneider Electric USB cable (BMXXCAUSBH018) or a third-party USB Type A/mini B cable of maximum length 4 m/13.12 ft.

1

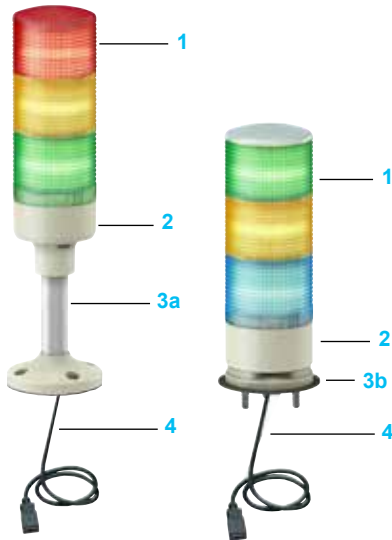

Description

XVGU monolithic tower lights include an assembly of:

- 1 Three layers of multi-color illuminated signaling units (red, orange, green, or blue) which are set in the HMI application. Each XVGU tower light is equipped with multi-color LEDs and a clear lens molded from a single piece of clear plastic. The colors are visible only when the LEDs are supplied with power (5 V DC).
- 2 Base unit integrating the buzzer.
- 3 Mounting base for mounting on a horizontal support:
 - 3a Mounting base, comprising a 100 mm/3.94 in. aluminum support tube mounted on a mounting plate,
 - 3b Mounting base fitted with 3 screws for direct mounting.
- 4 USB cable with "Type A female" connector, the projecting length being 300 mm/11.81 in. for tube mounting and 400 mm/15.75 in. for direct mounting models (1).

Pre-assembled tower lights 5 V, Ø 60 mm/2.36 in.

Description	Light source (included)	Degree of protection	Signaling colors	Reference	Weight
With 100 mm/3.94 in. aluminum tube mounting and mounting plate					
With buzzer	Multi-color LED for various states and patterns	IP 42	Red/Orange/ Green/Blue	XVGU 3SHAV	0.300 kg/ 0.661 lb

With direct base mounting

With buzzer	Multi-color LED for various states and patterns	IP 42	Red/Orange/ Green/Blue	XVGU 3SWV	0.300 kg/ 0.661 lb
--------------------	---	-------	------------------------	------------------	-----------------------

Accessories

Description	Utilization	Length	Reference	Weight
Connection cable from PC to the terminal (USB Type A/mini B)	Cable for transferring screen data from a PC (USB Type A) to a HMI (USB Type mini B)	1.8 m/ 5.91 ft	BMX XCA USB H018	0.065 kg/ 0.143 lb

Note: Signaling colors: Red, Orange, Green, and Blue. The colors with any of these combination is set easily in the HMI application.

(1) For extension, use either the Schneider Electric USB cable (BMXXCAUSBH018) or a third-party USB Type A/mini B cable of maximum length 4 m/13.12 ft.

USB tower lights compatible with Magelis™ Advanced Panels and HMI Controllers

Type of tower light 1	Type of Advanced Panels or HMI Controllers	Description	Reference 2 (1)
XVGU3SWV	Monochrome touch screen	Optimum, 3.8" QVGA screen/Orange or red/STN	XBT GT1105
XVGU3SHAV	Standard Advanced Panels	Optimum, 3.8" QVGA screen/Orange or red/STN	XBT GT1135
		Optimum, 5.7" QVGA screen/Blue mode/STN	XBT GT2110
		Multifunction, 5.7" QVGA screen/Black and White/STN	XBT GT2120
		Multifunction, 5.7" QVGA screen/Blue mode/STN	XBT GT2130
	Color touch screen Standard Advanced Panels	Optimum, 3.8" QVGA screen/TFT	XBT GT1335
		Multifunction, 5.7" QVGA screen/STN	XBT GT2220
		Multifunction, 5.7" QVGA screen/TFT	XBT GT2330
		Multifunction, 5.7" VGA screen/TFT	XBT GT2430
		Multifunction, 5.7" QVGA screen/High brightness TFT	XBT GT2930
		Multifunction, 7.5" VGA screen/STN	XBT GT4230
		Multifunction, 7.5" VGA screen/TFT	XBT GT4330
		Multifunction, 7.5" VGA screen/TFT	XBT GT4340
		Multifunction, 10.4" VGA screen/STN	XBT GT5230
		Multifunction, 10.4" VGA screen/TFT	XBT GT5330
		Multifunction, 10.4" VGA screen/TFT	XBT GT5340
		Multifunction, 10.4" SVGA screen/TFT	XBT GT5430
		Multifunction, 12.1" SVGA screen/TFT	XBT GT6330
		Multifunction, 12.1" SVGA screen/TFT	XBT GT6340
		Multifunction, 15" XGA screen/TFT	XBT GT7340
	Keypad/touch screen Standard Advanced Panels	Multifunction, 5.7" screen/Black and white/STN	XBT GK2120
		Multifunction, 5.7" screen/Color/TFT	XBT GK2330
		Multifunction, 10.4" screen/Color/TFT	XBT GK5330
	Portable touch screen Standard Advanced Panels	Multifunction, 5.7" screen/Color/TFT	XBT GH2460
		Multifunction, 5.7" screen/Color/TFT (without Emergency stop Push button)	XBT GH2460B
	Junction box	Junction Box for XBTGH2 (without Fieldbus)	XBT ZGJBOX
	Optimum Advanced Panels	3.5" QVGA screen/TFT	HMI GTO1300
		3.5" QVGA screen/TFT	HMI GTO1310
		5.7" QVGA screen/TFT	HMI GTO2300
		5.7" QVGA screen/TFT	HMI GTO2310
		5.7" QVGA screen/Stainless steel	HMI GTO2315
		7.0" WVGA screen/TFT	HMI GTO3510
		7.5" VGA screen/TFT	HMI GTO4310
		10.4" VGA screen/TFT	HMI GTO5310
		10.4" VGA screen/Stainless steel	HMI GTO5315
		12.1" SVGA screen/TFT	HMI GTO6310
		12.1" SVGA screen/Stainless steel	HMI GTO6315
	HMI Controllers	3.8" screen/Orange or Red/STN	XBT GC1100U
		3.8" screen/Orange or Red/STN	XBT GC1100T
		5.7" screen/Black and white/STN	XBT GC2120U
		5.7" screen/Black and white/STN	XBT GC2120T
		5.7" screen/Color/TFT	XBT GC2330U
		5.7" screen/Color/TFT	XBT GC2330T



Note: For more information on Magelis Advanced Panels and HMI Controllers, please refer to our website www.schneider-electric.com.

(1) The minimum required Vijeo Designer software version is VJD 6.1 Service pack 1.

1



Stand-alone biometric USB switch (XB5S1/XB5S2)



Stand-alone biometric USB switch (XB5S3/XB5S4)



Biometric USB switch dedicated to Schneider HMI (XB5S5)

Introduction

Harmony™ XB5S biometric USB switches are designed to control and secure access to systems and machines by checking a user's authorization, via fingerprint recognition technology.

The following types of biometric USB switches are available:

- Stand-alone biometric USB switches
 - type XB5S1, with 2 fixed states (maintained)
 - type XB5S2, with pulse control (momentary)
- Stand-alone biometric USB switches
 - type XB5S3, with 2 fixed states (maintained)
 - type XB5S4, with pulse control (momentary)
- Biometric USB switches dedicated to Schneider Electric HMI
 - type XB5S5, connected permanently with HMI

The two types of users of the XB5S are:

- Administrators, who decide and manage the list of users
 - the only people who can record the fingerprints in the device memory
- Users, who are authorized to use the biometric USB switch as a control unit
 - at least 1 of their fingerprints should be recorded in the device memory
 - access is granted when the finger is placed on the sensing screen

The USB switches communicate with the PC/HMI via the USB port to manage the user database. This database can be visualized, saved, and duplicated by PC/HMI with XB5SSoft application (1) (2). The fingerprint records can also be erased in the absence of users.

The Schneider Electric HMI (3) with Vijeo™ Designer™ software (4) enables the switches to authorize different access levels and trace HMI operations of each user.

The switch operates on 24 Vdc and provides protection against:

- Reverse polarity
- Overload and short-circuit (switching capacity ≤ 200 mA)

Mounting

The product is of monolithic design (a single plastic housing) and is mounted by means of a nut (hand-tightened without need for tools) in a standard 22.5 mm/ 0.886 in. diameter hole. It can be installed on a flat, horizontal, or vertical surface.

A protective cover is available as an accessory to protect the active face of the sensing screen. This cover is mounted using a self-adhesive hinge.

A female/female USB extension cable makes it possible for the biometric USB switch to have the female USB port within a 22 mm/0.866 in. diameter hole on the control panel front.

Environment

- Conformity to standards: UL, CSA, GOST, and cC.
- Product certifications:
 - CSA C22-2 n° 14
 - UL 508
 - IEC 61000-6-2 and IEC 61000-6-4
- Degree of protection conforming to standard IEC 60529:
 - IP 65
 - UL Type 12, NEMA 12
- Ambient air temperature:
 - For storage: - 25 to + 70 °C
 - For operation: - 5 to + 50 °C

(1) Compatible with all versions of Harmony XB5SSoft application. The XB5SSoft is a freeware application and can be downloaded from our website www.schneider-electric.com.

(2) The user database cannot be uploaded from biometric USB switch to the PC.

(3) Compatible with Magelis™ iPC, STU, OT, GXO, GT (except GT1000 series), GK, GH, and GTO models.

(4) Compatible with Vijeo Designer HMI editor software V6.1, Service pack 2.

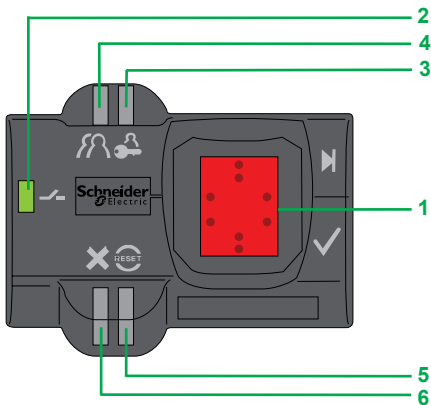

XB5S1B●●●●



XB5S3B●●●●



XB5SFFUSBEXT



ZB5SZ70

Description

- The stand-alone biometric USB switch (XB5S1/XB5S2) consists of a dark gray housing, with the following on its front face:
 - Sensing screen **1** that allows the registration and subsequent recognition of registered fingerprints,
 - Green LED output state indicator **2** that illuminates when the output is activated (solid-state NO contact),
 - Orange LED **3**, indicating an administrator's "Registration" mode,
 - Orange LED **4**, indicating an operator's "Registration" mode,
 - Red "RESET" LED **5** which indicates, in "Delete" mode, that the administrator is deleting all or part of the memory,
 - Red LED **6** which flashes when the reader is presented with an "unrecognized" fingerprint or in the event of incorrect operation.
- The stand-alone biometric USB switch (XB5S3/XB5S4) consists of a dark gray housing with a sensing screen **1** for fingerprints, a green LED **2** for indicating the output state, and a red LED **6** for the unrecognized fingerprint on its front face.
- The biometric USB switch dedicated to Schneider Electric HMI (XB5S5) consists of a dark gray housing with a sensing screen **1** for fingerprints on its front face.

References

Complete units

Description	Connection	Reference	Weight kg/lb
Maintained biometric USB switch 24 Vdc PNP output	By 2 m/6.56 ft cable	XB5 S1B 2L2	0.170/0.375
	By M12 connector	XB5 S1B 2M12	0.183/0.403
Momentary biometric USB switch 24 Vdc PNP output	By 2 m/6.56 ft cable	XB5 S2B 2L2	0.170/0.375
	By M12 connector	XB5 S2B 2M12	0.183/0.403
Maintained USB biometric USB switch 24 Vdc PNP output	By 2 m/6.56 ft cable	XB5 S3B 2L2	0.202/0.445
	By M12 connector	XB5 S3B 2M12	0.215/0.474
Momentary USB biometric USB switch 24 Vdc PNP output	By 2 m/6.56 ft cable	XB5 S4B 2L2	0.202/0.445
	By M12 connector	XB5 S4B 2M12	0.215/0.474
USB biometric USB switch dedicated to Schneider Electric HMI 24 Vdc	By 2 m/6.56 ft cable	XB5 S5B 2L2	0.202/0.445

Accessories

Description	Function	Reference	Weight kg/lb
Female/female USB extension cable with Ø 22 mm/0.866 in. female USB port on one end	For connecting biometric USB switch to the PC via the Ø 22 mm/0.866 in. hole on the control panel front	XB5 SFF USB EXT	0.108/0.238
Protective cover, translucent and self-adhesive	Protection of sensing screen	ZB5 SZ70	0.020/0.044
Mounting nut Ø 22 mm/0.866 in.	Spare part	ZB5 SZ71	0.030/0.066
Legend plate, 27 x 8 mm/ 1.06 x 0.32 in., self-adhesive, blank, black background, for engraving	—	ZBY 010 1T	0.005/0.011

1

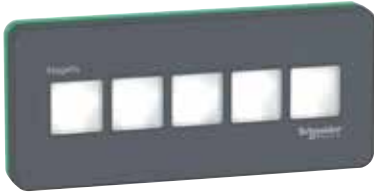

HMIZ illuminated USB switch

Introduction

The illuminated USB switch is uniquely designed for easy visualization and quick acknowledgement of alarm (wide view angle and brightness). This switch with click sensation is also used as a function key in HMI applications where the touch panel involves repetitive and reliable operations in dirty environments. This keeps the touch panel clean and protected by avoiding continuous finger contact.

The illuminated USB switch can be easily wired, powered by the USB cable and integrated with the Magelis HMI. This range is ideal for use in industrial applications like machine tool, packaging, printing, automotive, metal processing, food and beverage, and paper.

With Vijeo Designer HMI configuration software (1), the illuminated USB switch can be set to the following:

- Alarm display and acknowledgement:
 - The 5 multi-color LEDs are configured in the Vijeo Designer (1) to display single or multiple alarm statuses. The users can quickly access these operations of alarm acknowledgement by pressing the integrated function keys.
- Illuminated function keys:
 - The illuminated USB switch can be used as function keys by configuring them in the Vijeo Designer software (1). The 5 multi-color LEDs are linked to the PLC variables to show the status of operation feedback.
 - Vijeo Designer software can configure the function keys to support most of the HMI touch panel operations.

Mounting

The illuminated USB switch is mounted by a nut (hand-tightened without a tool or tightened by a wrench) in a standard 22 mm/0.866 in. diameter hole. It can be installed on flat and vertical surfaces.

Environment

- Conformity to standards: UL, CSA, and GOST.
- Product certifications:
 - CSA C22-2 n° 142
 - UL 508
 - IEC 61000-6-2 and IEC 61000-6-4
- Degree of protection conforming to standard IEC 60529:
 - IP 65
 - NEMA 4X
- Ambient air temperature:
 - For storage: - 20 to + 60 °C
 - For operation: 0 to + 55 °C

Description

The illuminated USB switch consists of a green rear cover 1 and a dark gray front cover 2. There are 5 function keys 3 on its front face with LED backlit. Each function key 4 has one multi-color LED indicator (green, red, orange, blue, yellow and white).

A insert label sheet containing 3 customizable labels is supplied with the illuminated USB switch.

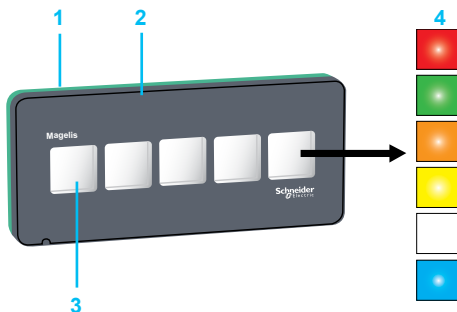

(1) Compatible with Vijeo Designer HMI configuration software V6.1, Service pack 2.

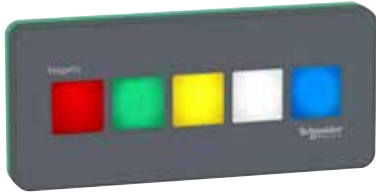

HMIZ RA1



Installation nut



Anti-rotation tee



USB clamp type B

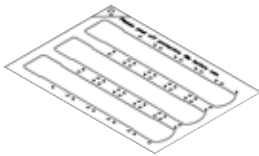

HMIZ LYRA1



HMIZ U50

References

Illuminated USB switches

Description	Connection	Compatible with Terminals	Reference	Weight kg/lb
Illuminated USB switch composed of 5 switches with backlit LED. Allows the selection and adjustment of colors by the user 5 V DC.	By USB cable	Magelis iPC (with Vijeo Designer Run Time) HMIGTO HMIGXO HMIGTW XBTGT (except GT1000 series) XBTGK XBTGC (with SoMachine Platform)	HMIZ RA1 (1)	0.110/0.243

Spare parts

Description	Reference	Weight kg/lb
Accessory kit for HMIZRA1 which includes: <ul style="list-style-type: none"> <input type="checkbox"/> 5 installation nuts <input type="checkbox"/> 5 anti-rotation tees <input type="checkbox"/> 5 USB clamps type B 	HMIZ KIT RA1	—
3 insert label sheets for HMIZRA1 switch (3 customizable labels per sheet)	HMIZ LYRA1	—
5 gaskets for HMIZRA1 switch	HMIZ U50	—

(1) When HMIZRA1 illuminated USB switch is ordered, all the spare parts are included in this package.

2.1 - Magelis™ HMI Controllers

Selection guide 2/2

- Introduction 2/4
- Magelis SCU Small HMI Controllers
 - For control of simple machines. 2/8
 - For control of simple processes 2/9
 - CANopen™ bus master module for SCU Small HMI Controllers 2/10
- Magelis XBT GC HMI Controllers
 - Magelis XBT GC HMI Controller: 3.8", 5.7" 2/12
 - Separate parts 2/14
 - Digital I/O expansion modules 2/15
 - Analog I/O expansion modules 2/16
 - Modicon™ Telefast™ ABE 7 pre-wired system for XBT GC 2/18
 - CANopen bus master module for XBT GC 2/22
- Magelis XBT GT/GK Advanced Panels with control function
 - CANopen™ bus master module for XBT GT/GK 2/24
 - Magelis XBT GT Advanced Panels: 5.7", 7.5", 10.4", 12.1", 15" 2/26
 - Magelis XBT GK Advanced Panels: 5.1", 10.4" 2/27
- Wiring system CANopen bus 2/28

2.2 - Software platform

- SoMachine™ software suite 2/30



Magelis™ Human/Machine Interfaces

HMI Controllers

Magelis SCU Small HMI Controllers, XBT GC HMI Controllers, XBT GT and XBT GK Standard Advanced Panels with control

2

Applications	Display of text messages, graphic objects and mimics Control and configuration of data
Terminal type	IEC 1131-2 control function Small HMI Controllers For control of simple machine For control of simple process



Display	Type	Color TFT LCD														
	Capacity	3.5" (65 k colors) 5.7" (65 k colors) 3.5" (65 k colors) 5.7" (65 k colors)														
Data entry		Via touch screen														
	Static function keys	–														
	Dynamic function keys	–														
	Service keys	–														
	Alphanumeric keys	–														
Memory capacity	Application	128 MB Flash EPROM														
	Expansion	–														
Functions	Maximum number of pages and maximum number of instructions	Limited by internal Flash EPROM memory capacity														
	Variables per page	Unlimited (8000 variables max.)														
	Programmed logic	5 languages according to IEC 1131-2 (LD, ST, FBD, SFC, IL)														
	Counting/positioning	2 x 100 kHz high speed counter inputs/2 x 50 kHz pulse train outputs														
	Control (PID)	Yes														
	Representation of variables	Alphanumeric, bitmap, bargraph, gauge, tank, tank level indicator, curves, polygon, button, light														
	Recipes	32 groups of 64 recipes comprising 1024 ingredients max.														
	Curves	Yes, with log														
	Alarm logs	Yes														
	Real-time clock	Built-in														
I/O	Integrated	<table border="0"> <tr> <td><input type="checkbox"/> 14 x 24 V ∓ digital inputs</td> <td><input type="checkbox"/> 6 x 24 V ∓ digital inputs</td> </tr> <tr> <td><input type="checkbox"/> 2 high speed counter (HSC) inputs</td> <td><input type="checkbox"/> 2 high speed counter (HSC) inputs</td> </tr> <tr> <td><input type="checkbox"/> 8 digital relay outputs</td> <td><input type="checkbox"/> 6 digital relay outputs</td> </tr> <tr> <td><input type="checkbox"/> 2 pulse train source transistor outputs</td> <td><input type="checkbox"/> 2 pulse train source transistor outputs</td> </tr> <tr> <td></td> <td><input type="checkbox"/> 2 x 13-bit analog inputs (Voltage/current)</td> </tr> <tr> <td></td> <td><input type="checkbox"/> 2 x 16-bit analogue temperature inputs (TC/PT100-1000)</td> </tr> <tr> <td></td> <td><input type="checkbox"/> 2 x 12-bit analog outputs (Voltage/current)</td> </tr> </table>	<input type="checkbox"/> 14 x 24 V ∓ digital inputs	<input type="checkbox"/> 6 x 24 V ∓ digital inputs	<input type="checkbox"/> 2 high speed counter (HSC) inputs	<input type="checkbox"/> 2 high speed counter (HSC) inputs	<input type="checkbox"/> 8 digital relay outputs	<input type="checkbox"/> 6 digital relay outputs	<input type="checkbox"/> 2 pulse train source transistor outputs	<input type="checkbox"/> 2 pulse train source transistor outputs		<input type="checkbox"/> 2 x 13-bit analog inputs (Voltage/current)		<input type="checkbox"/> 2 x 16-bit analogue temperature inputs (TC/PT100-1000)		<input type="checkbox"/> 2 x 12-bit analog outputs (Voltage/current)
<input type="checkbox"/> 14 x 24 V ∓ digital inputs	<input type="checkbox"/> 6 x 24 V ∓ digital inputs															
<input type="checkbox"/> 2 high speed counter (HSC) inputs	<input type="checkbox"/> 2 high speed counter (HSC) inputs															
<input type="checkbox"/> 8 digital relay outputs	<input type="checkbox"/> 6 digital relay outputs															
<input type="checkbox"/> 2 pulse train source transistor outputs	<input type="checkbox"/> 2 pulse train source transistor outputs															
	<input type="checkbox"/> 2 x 13-bit analog inputs (Voltage/current)															
	<input type="checkbox"/> 2 x 16-bit analogue temperature inputs (TC/PT100-1000)															
	<input type="checkbox"/> 2 x 12-bit analog outputs (Voltage/current)															
	I/O modular expansion	–														
Communication	Downloadable protocols	Uni-TE, Modbus, Modbus TCP/IP (1) and for PLC brands: Mitsubishi, Omron, Allen-Bradley and Siemens														
	Asynchronous serial link	RS 232C/RS 485 (COM1)														
	USB ports	1 Host type A + 1 Device type mini-B														
	Buses and networks	1 CANopen master														
		Ethernet TCP/IP (10BASE-T/100 BASE-TX)														
	Printer link	USB port for parallel printer														
Design software		SoMachine on Windows XP Professional and Windows 7 Professional 32/64-bit (see page 2/33)														
Operating system		Magelis (333 MHz RISC CPU)														
Terminal type		HMI SCU6A5 HMI SCU8A5 HMI SCU6B5 HMI SCU8B5														
Pages		2/11														

(1) Depending on model.



**Display of text messages, graphic objects and mimics
Control and configuration of data**

IEC 1131-2 control function

HMI Controllers	Touch screen Standard	Advanced Panels + control function	Standard Advanced Panels with keypad + control function
-----------------	-----------------------	------------------------------------	---

				
Backlit monochrome (amber or red mode) STN LCD (320 x 240 pixels)	Backlit monochrome STN LCD (320 x 240 pixels)	Color TFT LCD (320 x 240 pixels)	Backlit monochrome or color STN LCD or color TFT LCD (320 x 240 pixels to 1024 x 708 pixels) (1)	Monochrome STN LCD or color TFT LCD (320 x 240 pixels or 640 x 480 pixels) (1)
3.8" (monochrome)	5.7" (monochrome)	5.7" (65 k colors)	5.7" (monochrome or color) 7.5", 10.4", 12.1" or 15" (color) (1)	5.7" (monochrome or color) or 10.4" (color) (1)
Via touch screen			Via keypad and/or touch screen (configurable) and/or by industrial pointer	
-			10 or 12 (1)	
-			14 or 18 (1)	
-			8	
-			12	
16 MB Flash EPROM			16 MB Flash EPROM or 32 MB Flash EPROM (1)	
-			By 128 MB to 4 GB CF card (1)	
Limited by internal Flash EPROM memory capacity			Limited by internal Flash EPROM memory capacity or CF card memory capacity	
Unlimited (8000 variables max.)				
5 languages according to IEC 1131-2 (LD, ST, FBD, SFC, IL)				
4 x 100 kHz high speed counter inputs/4 x 65 kHz pulse train outputs			-	
Yes				
Alphanumeric, bitmap, bargraph, gauge, tank, tank level indicator, curves, polygon, button, light				
32 groups of 64 recipes comprising 1024 ingredients max.				
Yes, with log				
Yes				
Built-in				
<input type="checkbox"/> 12 x 24 V --- digital inputs <input type="checkbox"/> 6 sink or source transistor outputs (1)	<input type="checkbox"/> 16 x 24 V --- digital inputs <input type="checkbox"/> 16 sink or source transistor outputs (1)		-	
2 Modicon TM2 I/O modules max.	3 Modicon TM2 I/O modules max.		-	
-	Uni-TE, Modbus, Modbus TCP/IP (1) and for PLC brands: Mitsubishi, Omron, Allen-Bradley and Siemens			
-	RS 232C/RS 422/485 (COM1)		RS 232C/RS 422/485 (COM1) and RS 485 (COM2)	
1			1 or 2 (1)	
1 CANopen master with optional module (XBT ZGC CAN)			1 CANopen master with external module (XBT ZG CANM) which is mandatory for the control function	
-	Ethernet TCP/IP (10BASE-T/100BASE-TX)		Ethernet TCP/IP (10BASE-T/100BASE-TX) (1)	
USB port for parallel printer			USB port for parallel printer and RS 232C (COM1) serial link	
SoMachine on Windows XP Professional and Windows 7 Professional 32/64-bit (see page 2/33)				
Magelis (131 MHz RISC CPU)			Magelis (131 MHz RISC or 266 MHz RISC CPU) (1)	Magelis (266 MHz RISC CPU)
XBT GC1100T XBT GC1100U	XBT GC2120T XBT GC2120U	XBT GC2330T XBT GC2330U	XBT GT2●/4●/5●/63/73 + XBT ZGCANM	XBT GK2●/53 + XBT ZGCANM
2/14			1/58 and 2/24	
			1/59 and 2/24	

HMI Controllers

Magelis SCU Small HMI Controllers, XBT GC HMI Controllers, XBT GT and XBT GK Standard Advanced Panels with control

Introduction

Magelis HMI Controllers are part of Schneider Electric's Flexible Machine Control concept, a key element in MachineStruxure™.

The Magelis HMI Controllers offer brings together Human Machine Interface and control functions within in a single product. This reduces the amount of equipment required and the associated costs throughout the life cycle of the machine. This offer includes three ranges:

- The ultra-compact range: Magelis SCU Small HMI Controllers
- The compact range: Magelis XBT GC HMI Controllers
- The modular range: Magelis XBT GT/GK Standard Advanced Panels + XBT ZC CANM CANopen module

Magelis SCU Small HMI Controllers (ultra-compact range)

The Magelis SCU Small HMI Controllers integrate, as standard, all their functions. They benefit, in particular, from the same innovation as the Magelis STU Small panels range: Mounting via a 22 mm diameter hole (push button type) which considerably simplifies installation (see page 2/8).

Of modular design, this range includes:

- 2 complete Magelis SCU products for the control of simple machines, comprising:
 - A 3.5" or 5.7" 65 k color TFT Screen module
 - A Controller module with 16 integrated digital inputs/10 integrated digital outputs
- 2 complete Magelis SCU products for the control of simple processes, comprising:
 - A 3.5" or 5.7" 65 k color TFT Screen module
 - A Controller module with 8 integrated digital inputs/8 integrated digital outputs and 4 integrated analog inputs/2 integrated analog outputs

The Screen modules and Controller modules (for simple machines or processes) are also available separately as replacement parts. Magelis SCU Small HMI Controllers operate with the same Screen modules as Magelis STU Small panels, which simplifies upgrading of an installation (only the rear module needs to be replaced). A wide choice of communication interfaces is also integrated: USB port, serial link, Ethernet and CANopen.

Magelis XBT GC HMI Controllers (compact range)

The compact design of Magelis XBT GC HMI Controllers optimizes setup.

This range includes 6 touch screen terminals, with the following, depending on the model:

- 3.8" monochrome screen, 12 integrated inputs/6 integrated outputs (sink or source)
- 5.7" monochrome or color screen, 16 integrated inputs/16 integrated outputs (sink or source)
- A wide choice of communication interfaces: USB port, serial link, Ethernet and CANopen

In order to adapt easily to different configurations, it is possible to add digital or analog I/O expansion modules at the rear of the Controller.

Magelis XBT GT/GK Standard Advanced Panels + XBT ZC CANM CANopen module (modular range)

This range is made up of the complete Magelis XBT GT or Magelis XBT GK Standard Advanced Panels offers combined with a Control part using the XBT ZG CANM CANopen module. During operation, this module controls the I/O and the peripherals distributed via the CANopen bus.

The combination with Magelis XBT GT or Magelis XBT GK Standard Advanced Panels gives a wide choice of screen sizes and types of data entry, depending on the model:

- 17 XBT GT touch screen terminals:
 - 5.7" monochrome or color screens
 - 7.5", 10.4", 12.1" and 15" color screens
- 3 XBT GK terminals with keypad and/or touch screen:
 - 5.7" monochrome or color screens
 - 10.4" color screens

This combination also offers numerous advanced functions such as video, data management (sharing of data, log), etc.



Magelis SCU Small HMI Controllers



Magelis XBT GC HMI Controllers

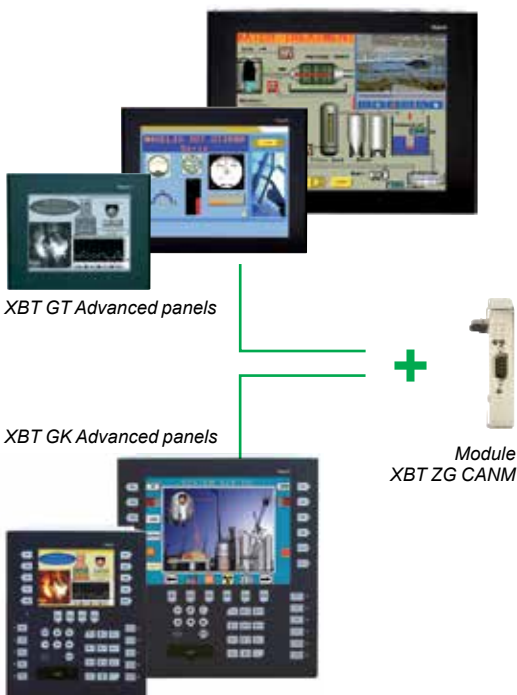

XBT GT Advanced panels

XBT GK Advanced panels

Module XBT ZG CANM

HMI function: Magelis XBT GT/GK Advanced Panels with control: CANopen XBT ZG CANM master module

HMI Controllers

Magelis SCU Small HMI Controllers, XBT GC HMI Controllers, XBT GT and XBT GK Standard Advanced Panels with control



SoMachine



Vijeo Designer
(included in SoMachine)

Operation

With their fast multitasking processors, all the HMI Controllers combine HMI and control functions and share the same screen and communication features and dimensions.

The internal memory can be freely used by both the HMI function and the control function.

Processing is split 75% on the HMI part and 25% on the control part. The processing can be configured for 3 tasks, including 1 master task.

The XBT GC HMI Controllers also share the same I/O modules, the same Telefast pre-wired system and the same peripherals on the CANopen bus as the Modicon M238 logic controller.

Configuration

Magelis SCU Small HMI Controllers, Magelis XBT GC HMI Controllers and Magelis XBT GT/GK Standard Advanced Panels are configured using Schneider Electric's unique machine automation software, SoMachine.

This software, combining both HMI and control functions, is based on Vijeo Designer software running on Windows XP Professional or Windows 7 Professional 32/64-bit. SoMachine software boasts an advanced user interface with many configurable windows, enabling unique projects to be developed quickly and easily.

See page 2/30.

Communication

Examples of communication architectures

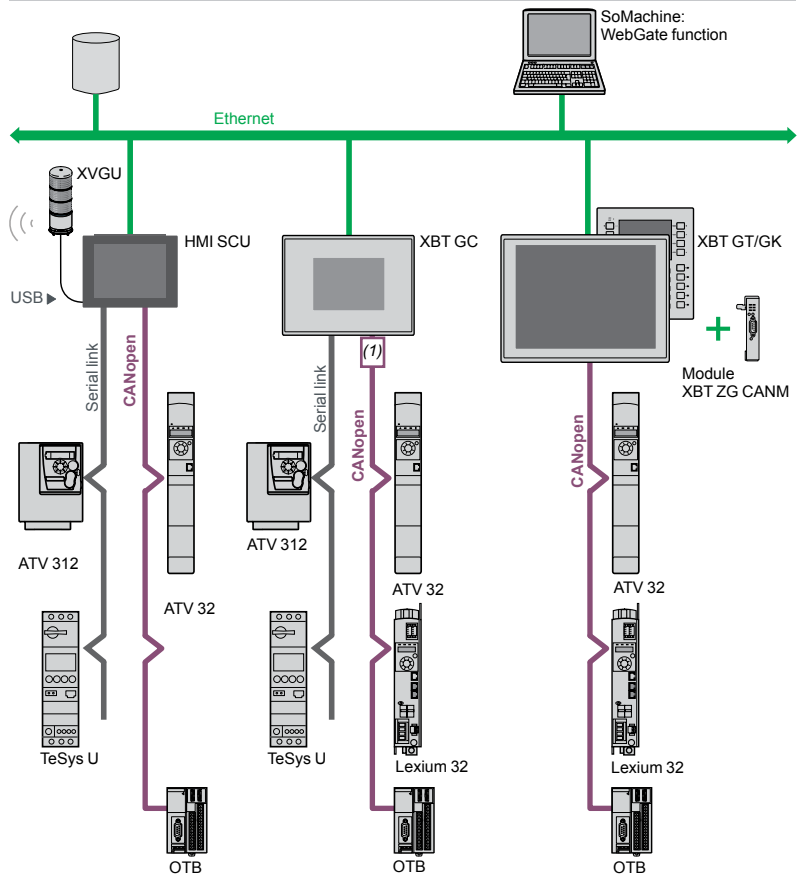

Depending on the model, Magelis SCU Small HMI Controllers, Magelis XBT GC HMI Controllers and Magelis XBT GT/GK Standard Advanced Panels communicate with automation devices via 1 or 2 integrated serial links using the following communication protocols:

- Schneider Electric (Uni-TE, Modbus)
- Third-party: Mitsubishi Electric, Omron, Allen-Bradley and Siemens

Depending on the model, they can be connected to Ethernet TCP/IP networks with the Modbus TCP protocol or a third-party protocol, and can be used as the CANopen master to control all the peripherals which can be connected on this bus.

(1) With XBT ZGC CAN CANopen master module.

HMI Controllers

Magelis SCU Small HMI Controllers, XBT GC HMI Controllers, XBT GT and XBT GK Standard Advanced Panels with control

Functions

Magelis Small HMI Controllers, Magelis HMI Controllers and Magelis Standard Advanced Panels are part of Schneider Electric's Flexible Machine Control concept, a key element in MachineStruxure™.

Magelis SCU Small HMI Controllers, Magelis XBT GC HMI Controllers and Magelis XBT GT/GK Standard Advanced Panels

Magelis SCU Small HMI Controllers, Magelis XBT GC HMI Controllers and Magelis XBT GT/GK Standard Advanced Panels offer the following HMI functions:

- Display of animated mimics with 8 types of animation (pressing the touch panel, color changes, filling, movement, rotation, size, visibility and value display)
- Control, modification of numeric and alphanumeric values
- Display of current time and date
- Real-time curves and trend curves with log
- Alarm display, alarm log and management of alarm groups
- Multiwindow management
- Page calls initiated by the operator
- Multilingual application management (10 languages simultaneously)
- Recipe management
- Data processing via Java script
- Application support and USB key external memory logs
- Management of serial printers, barcode readers

Magelis SCU Small HMI Controllers, Magelis XBT GC HMI Controllers and Magelis XBT GT and XBT GK Standard Advanced Panels (1) have been designed for Transparent Ready architectures and equipment (combination of Web and Ethernet TCP/IP technologies).

With the WebGate function, it is possible to control or carry out maintenance remotely.

Eventually, Magelis SCU and Magelis XBT GT/GK will enable a smartphone or a PC tablet to be remotely connected to the HMI application.

Magelis SCU Small HMI Controllers, Magelis XBT GC HMI Controllers and Magelis XBT GT/XBT GK Standard Advanced Panels offer the following HMI functions:

- Execution of programmed logic sequences with the five IEC 1131-2 languages (LD, ST, FBD, SFC, IL)
- Management of equipment on the CANopen fieldbus

Magelis SCU Small HMI Controllers

In addition to the previously mentioned functions, Magelis SCU Small HMI Controllers enable management of:

- Integrated digital I/O
- Integrated analog I/O: Voltage, current and temperature (thermocouple, PT100, PT1000)
- 2 high speed counter (HSC) inputs, 100 kHz 1 channel or 50 kHz 2 channel
- 2 pulse train fast outputs, PTO/PWM 50 kHz

Magelis XBT GC HMI Controllers

In addition to the previously mentioned functions, Magelis XBT GC HMI Controllers enable management of:

- Integrated digital I/O
- integrated analog I/O
- 4 high speed counter (HSC) inputs, 100 kHz 1 channel or 50 kHz 2 channel
- 4 pulse train fast outputs, PTO/PWM 65 kHz

(1) Depending on model.

HMI Controllers

Magelis SCU Small HMI Controllers, XBT GC HMI Controllers, XBT GT and XBT GK Standard Advanced Panels with control

Operating modes for the terminals

The following illustrations show the equipment that can be connected to Magelis SCU and XBT GC Controllers as well as to Magelis XBT GT/GK Advanced Panels according to their two operating modes.

Edit mode

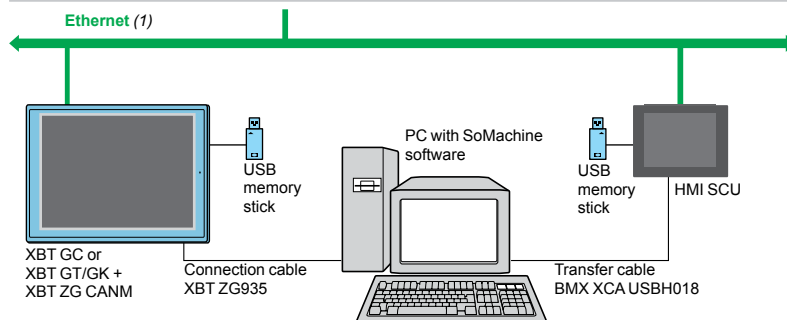

Run mode

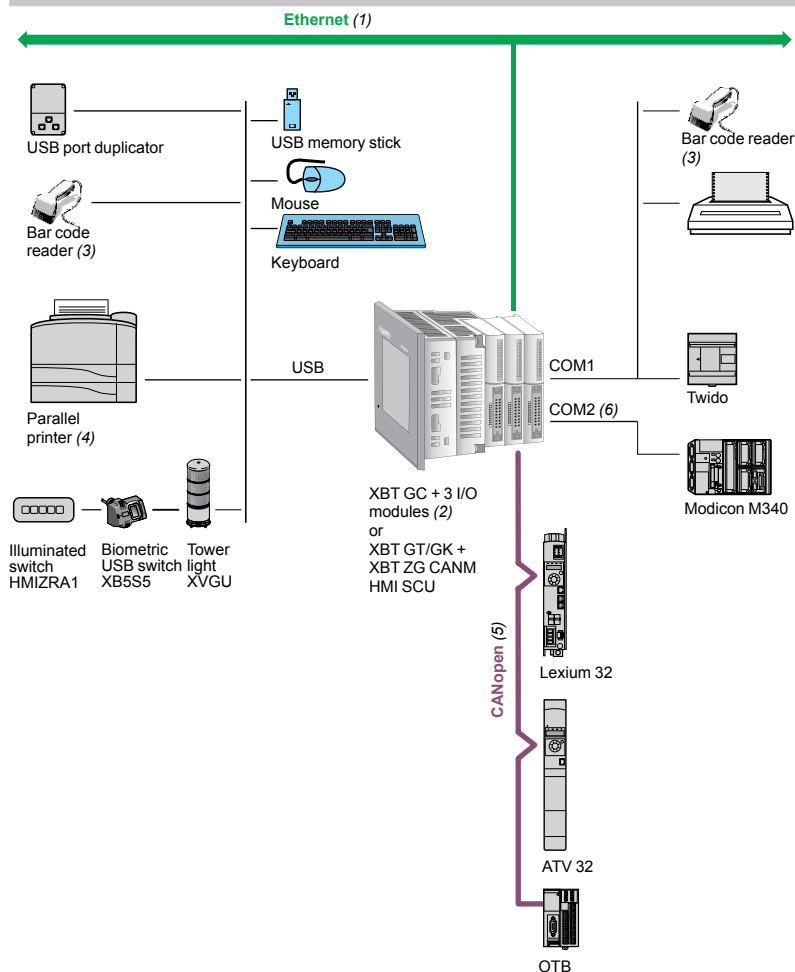

(1) With HMI SCU●●●, XBT GC 2330T/U, XBT GT●●30, XBT GT●●40, XBT GK●●30.

(2) With XBT GC●●●●T/U, maximum of 2/3 I/O modules depending on model.

(3) Should be a Gryphon barcode reader made by DataLogic except for HMI SCU.

(4) Should be a Hewlett Packard printer via a USB/PIO converter.

(5) Requires:

- for XBT GC: XBT ZGC CAN CANopen master module

- for XBT GT/GK: XBT ZG CANM CANopen master module.

(6) With XBT GT/GK.

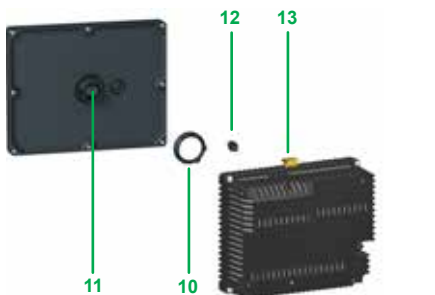
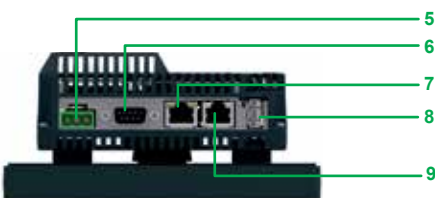
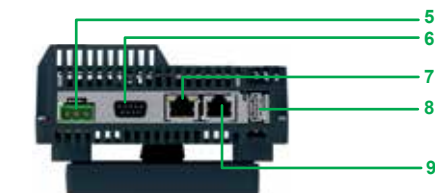
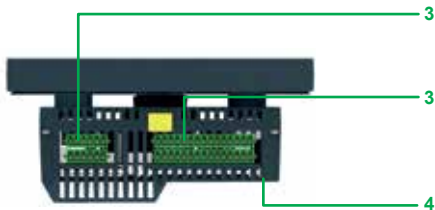
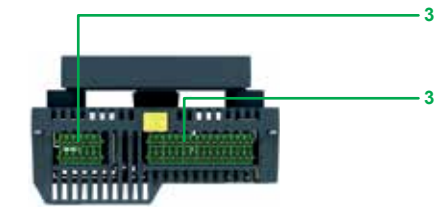

Description

Magelis HMI SCU A5 Small HMI Controllers

Front Panel

Magelis SCU Small HMI controllers for control of simple machines contain the following on the front panel:

- 1 A 3.5" touch screen for displaying mimics (color TFT LCD)
- or
- 2 A 5.7" touch screen for displaying mimics (color TFT LCD)

Upper rear panel

The upper rear panel contains the following:

- 3 Four removable terminal blocks for 16 digital inputs including 2 high speed counter (HSC) inputs (100 kHz 1 channel or 50 kHz 2 channel), 8 digital relay outputs and 2 source transistor outputs (PTO/PWM 50 kHz or 20 kHz pulse train if HSC used)

Lower rear panel

The lower rear panel contains the following:

- 4 A USB mini-B device connector for application transfer (on left-hand side of panel)
- 5 A removable screw terminal block for 24 V $\bar{\text{---}}$ power supply
- 6 A 9-way SUB-D connector for CANopen link, fitted with an LED for signalling power supply and system operation status
- 7 An RJ45 connector for Ethernet TCP/IP, 10BASE-T/100BASE-TX link
- 8 A type A USB master connector for:
 - Connection of a peripheral device
 - Connection of a USB memory stick
 - Application transfer
- 9 An RJ45 male connector for RS 232C or RS 485 serial link connection to PLCs (COM1)

Mounting system

Magelis SCU Small HMI controllers consist of a front module (comprising the screen) and a rear module (comprising the CPU plus terminals and connectors). The two modules are mounted together via a hole measuring 22 mm in diameter.

The mounting system contains the following elements:

- 10 A mounting nut
- 11 A seal
- 12 An anti-rotation tee (can be used as an option)
- 13 A release mechanism: Simply press to separate the two modules once they have been mounted together

This system is included with the complete products (see page 2/11).

Note: The 2 modules can also be mounted separately: Using a remote connection cable enables the rear module and the front module to be separated and the Controller module mounted on DIN rail (see page 2/11).

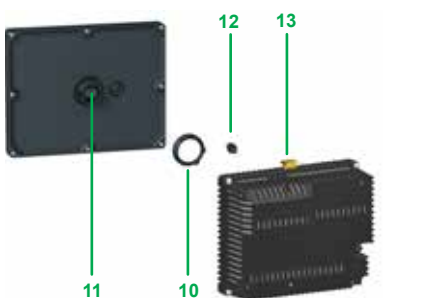
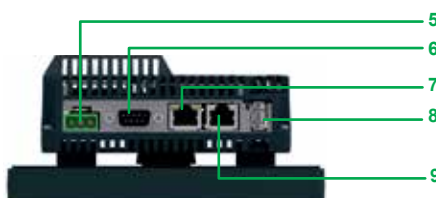
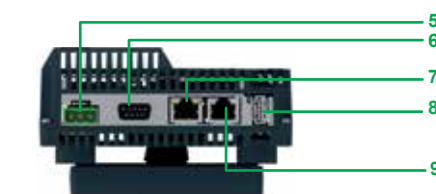
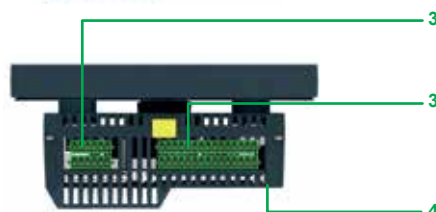
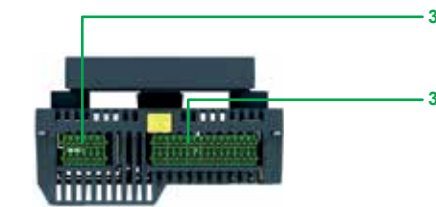

Description (continued)

Magelis HMI SCU B5 Small HMI Controllers

Front panel

Magelis SCU Small HMI controllers for control of simple processes contain the following on the front panel:

- 1 A 3.5" touch screen for displaying mimics (color TFT LCD)
- or
- 2 A 5.7" touch screen for displaying mimics (color TFT LCD)

Upper rear panel

The upper rear panel contains the following:

- 3 Four removable terminal blocks for 8 digital inputs including 2 fast HSC inputs (100 KHz 1 channel or 50 kHz 2 channel), 6 digital relay outputs, 2 transistor source outputs (PTO/PWM 50 kHz or 20 kHz pulse train if HSC used), 2 analog inputs (voltage, current), 2 temperature inputs (Thermocouple, PT100, PT1000) and 2 analog outputs (voltage, current)

Lower rear panel

The lower rear panel contains the following:

- 4 A USB mini-B device connector for application transfer (on left-hand side of panel)
- 5 A removable screw terminal block for 24 V power supply
- 6 A 9-way SUB-D connector for CANopen link, fitted with an LED for signalling power supply and system operation status
- 7 An RJ45 connector for Ethernet TCP/IP, 10BASE-T/100BASE-TX link
- 8 A type A USB master connector for:
 - Connection of a peripheral device
 - Connection of a USB memory stick
 - Application transfer
- 9 An RJ45 male connector for RS 232C or RS 485 serial link connection to PLCs (COM1)

Mounting system

Magelis HMI SCU Small HMI controllers consist of a front module (comprising the screen) and a rear module (comprising the CPU plus terminals and connectors). The two modules are mounted together via a hole measuring 22 mm in diameter.

The mounting system contains the following elements:

- 10 A mounting nut
- 11 A seal
- 12 An anti-rotation tee (can be used as an option)
- 13 A release mechanism: Simply press to separate the two modules once they have been mounted together

This system is included with the complete products (see page 2/11).

Note: The 2 modules can also be mounted separately: Using a remote connection cable enables the rear module and the front module to be separated and the Controller module mounted on DIN rail (see page 2/11).

Presentation

Magelis SCU Small HMI controllers integrate the CANopen bus master function.

SoMachine software is used to configure the CANopen machine bus for the Magelis SCU Small HMI Controllers (see page 2/30).

Example architecture

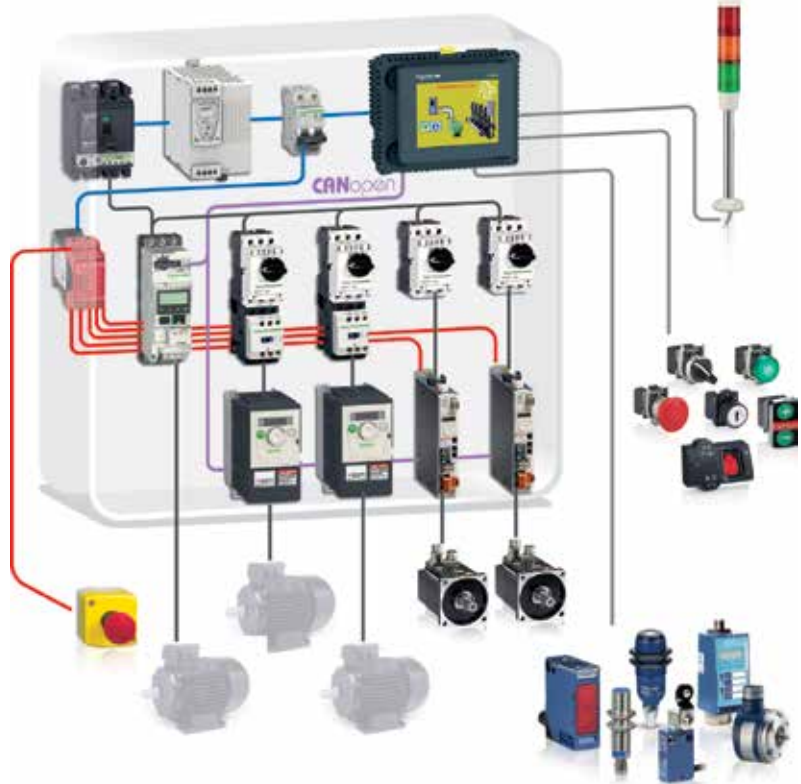

The above configuration shows an example architecture based on the Magelis SCU Small HMI Controllers which provide the CANopen bus master function. SoMachine software is used to configure the CANopen machine bus for the Magelis SCU Small HMI Controllers (see page 2/30). The CANopen bus is made up of a master station, a Magelis SCU Small HMI Controller and slave stations. The master is responsible for the configuration, exchanges and diagnostics to the slaves.

The various services offered are:

- One or more profiles are supplied for Schneider Electric slaves such as ATV 312/61/71 variable speed drives and Lexium 32 servo drives. This makes it possible to configure the slave according to a predefined mode. Profiles provide the user with a defined operating mode so there is no need to check how the mode is configured.
- For third-party slaves:
 - The user can choose from a list which can be modified. This simply involves importing an EDS-type (Electronic Data Sheet) description file
 - The slave can be positioned on the bus: The slave number, speed, monitoring, etc. can be defined
 - The user can select variables from the list of variables managed by the slave.
 - A link between variables and the data exchanged
 - Symbolization of data exchanged

The CANopen bus is used to manage various slaves such as:

- Digital and analog slaves
- Variable speed drives, motor starters

For an example connection of a *Distributed CANopen Optimized architecture*, see page 2/28.



HMI SCU6.5



HMI SCU8.5



XBT ZGUSB



HMIZ SURDP.1

Magelis HMI SCU.A5 Small HMI controllers for control of simple machines (1)

Complete products 24 V $\overline{\text{---}}$ (Screen module + Controller module)

Type of screen	No. of ports	Application memory capacity	Compact Flash memory	Integrated I/O	No. of Ethernet ports	Reference	Weight kg
3.5" QVGA color TFT	2 USB 1 COM1 1 CANopen	128 MB	No	16 digital I/ 10 digital O	1	HMI SCU6A5	0.512
5.7" QVGA color TFT	2 USB 1 COM1 1 CANopen	128 MB	No	16 digital I/ 10 digital O	1	HMI SCU8A5	0.764

Magelis HMI SCU.B5 Small HMI controllers for control of simple processes (1)

Type of screen	No. of ports	Application memory capacity	Compact Flash memory	Integrated I/O	No. of Ethernet ports	Reference	Weight kg
Complete products 24 V $\overline{\text{---}}$ (Screen module + Controller module)							
3.5" QVGA color TFT	2 USB 1 COM1 1 CANopen	128 MB	No	8 digital I/8 digital O 4 analog I/ 2 analog O	1	HMI SCU6B5	0.551
5.7" QVGA color TFT	2 USB 1 COM1 1 CANopen	128 MB	No	8 digital I/8 digital O 4 analog I/ 2 analog O	1	HMI SCU8B5	0.803

Separate parts

Description	Compatibility	Reference	Weight kg
Protective sheets (5 peel-off sheets)	HMI SCU 6●●	XBT ZS61	0.200
	HMI SCU 8●●	XBT ZS62	0.200

Designation	Description	Length	Reference	Weight kg
Remote USB port location for type A terminal	Enables the USB port to be located remotely on the rear of the HMI terminal on a panel or cabinet door (\varnothing 21 mm mounting device)	1 m	XBT ZGUSB	–
Remote USB port location for mini type B terminal		–	HMIZ SUSBB	–
Remote Controller module connection cable	Enables separate mounting of the Controller module and Screen module on DIN rail (for example, inside an enclosure)	3 m	HMIZ SURDP	–
		5 m	HMIZ SURDP5	–
Cable for transferring application to PC	USB type connector	1.80 m	BMX XCA USB H018	–
Accessories kit (compatible with all Magelis SCU Small controllers)	Contains: <ul style="list-style-type: none"> ■ An anti-rotation tee ■ A USB A type clip ■ A USB mini-B type clip ■ An adaptor panel for mounting on an enclosure of 1 mm in thickness 	–	HMIZ SUKIT	–

Replacement parts

Description	For use with	Reference	Weight kg
Direct I/O connector	All Magelis SCU Small controllers	HMIZ SDIO	–
3.5" Screen module	Controller modules HMISAC and HMISBC	HMI S65	0.153
5.7" Screen module	Controller modules HMISAC and HMISBC	HMI S85	0.405
Simple machine Controller module	Screen modules HMIS65 (3.5") and HMIS85 (5.7")	HMI SAC	0.359
Simple process Controller module	Screen modules HMIS65 (3.5") and HMIS85 (5.7")	HMI SBC	0.398
Mounting nuts	Set of 10 \varnothing 22 mm nuts (the front module of the SCU Small Controller is mounted on the enclosure using a \varnothing 22 mm nut, see page 2/8)	ZB5 AZ901	–
Tightening tool	For tightening mounting nut	ZB5 AZ905	–

(1) Mounting system for \varnothing 22 mm hole, power supply and I/O connectors, locking device for USB connector and instruction sheet included with terminals. The setup documentation for Magelis SCU Small controllers is supplied in electronic format with the SoMachine software (see page 2/33).

2

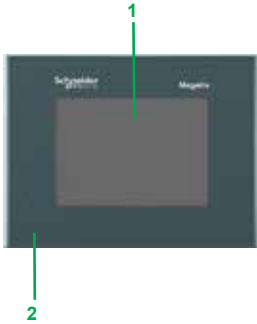

Description

Magelis XBT GC1100T and XBT GC1100U HMI Controllers

The front panel includes:

- 1 Touch screen for displaying mimics (3.8" amber or red mode monochrome)
- 2 Control indicator showing the terminal's operating mode

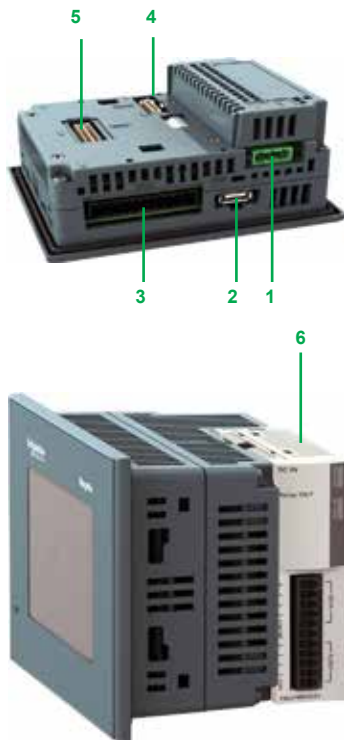

The rear panel includes:

- 1 Removable screw terminal block for 24 V $\overline{\text{---}}$ power supply
 - 2 Type A USB master connector for peripheral connection and application transfer
 - 3 Removable terminal block for 12 digital inputs and 6 digital outputs
 - 4 Interface for connecting M238 logic controller I/O expansion modules
 - 5 Interface for connecting the CANopen bus master module (see page 2/23)
 - 6 Digital (TM2 D●●) or analog (TM2 A●●) I/O expansion module (to be ordered separately, see pages 2/15 and 2/16)
- It is possible to combine a maximum of two I/O expansion modules, depending on the module type (see page 2/17).

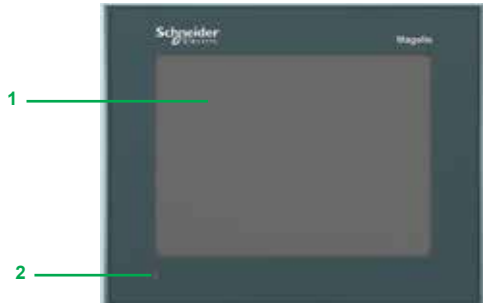

Description

Magelis XBT GC2●20 and XBT GC2●30 HMI Controllers

The front panel includes:

- 1 Touch screen for displaying mimics (5.7" monochrome or color)
- 2 Multicolor indicator (green, orange and red) showing the terminal's operating mode

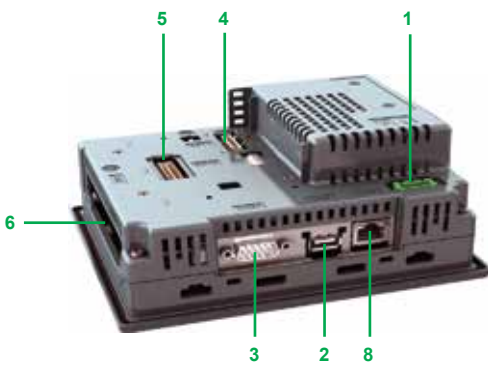

The rear panel includes:

- 1 Removable screw terminal block for 24 V $\bar{\text{---}}$ power supply
- 2 Type A USB master connector for peripheral connection and application transfer
- 3 9-way male SUB-D connector for RS 232C or RS 422/485 serial link to PLCs (COM1)
- 4 Interface for connecting the M238 logic controller I/O expansion module
- 5 Interface for connecting the CANopen bus master module (see page 2/24)
- 6 Removable terminal block for 16 digital inputs and 16 digital outputs
- 7 Digital (TM2 D●●) or analog (TM2 A●●) I/O expansion module (to be ordered separately, see pages 2/15 and 2/16)
It is possible to combine a maximum of two I/O expansion modules, depending on the module type (see page 2/17).

For XBT GC2330 only:

- 8 RJ45 connector for Ethernet TCP/IP 10BASE-T/100BASE-TX link

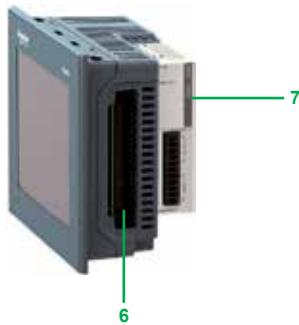



XBT GC1100●



XBT GC2●●●●



XBT ZGUSB

Magelis XBT GC HMI Controllers (1)

Type of screen	No. of ports	Application memory capacity	Compact Flash memory	Integrated I/O	No. of Ethernet ports	Reference	Weight kg
3.8" screen							
STN amber or red	1 USB	16 MB	No	12 I/6 O source	-	XBT GC1100T	0.400
				12 I/6 O sink	-	XBT GC1100U	0.400
5.7" screen							
STN black and white mode	1 COM 1	16 MB	No	16 I/16 O source	-	XBT GC2120T	1.000
	1 USB			16 I/16 O sink	-	XBT GC2120U	1.000
5.7" screen							
TFT color	1 COM 1	16 MB	No	16 I/16 O source	1	XBT GC2330T	1.000
	1 USB			16 I/16 O sink	1	XBT GC2330U	1.000

Separate parts

Designation	Compatibility	Size	Reference	Weight kg
Protective sheets (5 peel-off sheets)	XBT GC 1100	-	XBT ZG60	0.200
	XBT GC2●●0	-	XBT ZG62	0.200

Designation	Description	Length	Reference	Weight kg
Remote USB port location for type A XBT terminal	Enables the USB port to be located remotely on the rear of the XBT terminal on a panel or cabinet door (Ø 21 mm mounting device)	1 m	XBT ZGUSB	-
Remote USB port location for mini type B XBT terminal		-	XBT ZGUSBB	-
XBT GC connection to CANopen master fieldbus	Connection via card on bus extension	-	XBT ZGCCAN	-
Cable for transferring application to PC	USB TTL connector	2 m	XBT ZG 935	-

Replacement parts

Designation	Used for	Reference	Weight kg
Seals	XBT GC1100	XBT ZG51	0.030
	XBT GT21●0	XBT ZG52	0.030
USB fastenings	XBT GC 1100	XBT ZGCLP2	-
	XBT GC 2●●0	XBT ZGCLP4	-
Mounting kit	4 clips and screws (max. tightening torque: 0.5 Nm), included with all XBT GC terminals	XBT ZG Mount	0.100
Spring clip for expansion modules on XBT GC	XBT GC2●●0 terminals	XBT ZGCHOK	0.030
Power supply connector	XBT GC1●●● / GC2●●●	XBT ZGPWS1	0.030
Direct I/O connector	XBT GC1000	XBT ZG DIO1	-
	XBT GC2000	XBT ZG DIO2	-

(1) Terminals supplied with mounting kit (screw clips), locking device for USB connectors, spring clip for expansion modules (except XBT GC 1100) and instruction sheet. The setup documentation for XBT GC terminals is supplied in electronic format with SoMachine software (see page 2/33).

Digital I/O expansion modules

Digital I/O expansion modules are mounted on the rear of XBT GC controller bases. The maximum permitted number of digital and/or analog I/O modules depends on the type of XBT GC terminal and the thickness of the modules (see combination rule on page 2/17).

Digital input modules (1)

Input voltage	No. of channels	No. of common points	Connection	Thickness mm (Type)	Reference	Weight kg
24 V $\overline{\text{DC}}$ sink/source	8	1	By removable screw terminal block (provided)	23.5 (B)	TM2 DDI 8DT	0.085
	16	1	By removable screw terminal block (provided)	23.5 (B)	TM2 DDI 16DT	0.100
			By HE 10 connector	23.5 (B)	TM2 DDI 16DK (2)	0.065
	32	2	By HE 10 connector	29.7 (C)	TM2 DDI 16DK (2)	0.100
120 V \sim	8	1	By removable screw terminal block (provided)	23.5 (B)	TM2 DAI 8DT	0.081



TM2 DDI 8DT



TM2 DDO 8 T/DRA 8RT



TM2 DDO 32 K



TM2 DDM 24DRF

Digital output modules (1)

Input voltage	No. of channels	No. of common points	Connection	Thickness mm (Type)	Reference	Weight kg
Transistors 24 V $\overline{\text{DC}}$	8, sink 0.3 A	1	By removable screw terminal block (provided)	23.5 (B)	TM2 DDO 8UT	0.085
	8, sink 0.5 A	1	By removable screw terminal block (provided)	23.5 (B)	TM2 DDO 8TT	0.085
Transistors 24 V $\overline{\text{DC}}$	16, sink 0.1 A	1	By HE 10 connector	17.6 (A)	TM2 DDO 16UK	0.070
	16, sink 0.4 A	1	By HE 10 connector	17.6 (A)	TM2 DDO 16TK (2)	0.070
	32, sink 0.1 A	2	By HE 10 connector	29.7 (C)	TM2 DDO 32UK	0.105
	32, sink 0.4 A	2	By HE 10 connector type	29.7 (C)	TM2 DDO 32TK (2)	0.105
2 A relays (lth) 230 V \sim / 30 V $\overline{\text{DC}}$	8 (NO contact)	2	By removable screw terminal block (provided)	23.5 (B)	TM2 DRA 8RT	0.110
	16 (NO contact)	2	By removable screw terminal block (provided)	23.5 (B)	TM2 DRA 16RT	0.145

Digital mixed I/O modules (1)

No. of I/O	No./type of inputs	No./type of outputs	No. of common points	Connection	Thickness mm (Type)	Reference	Weight kg
8	4 I, 24 V $\overline{\text{DC}}$ sink/source	4 relay O (NO contact) 2 A (lth)	Inputs: 1 common Outputs: 1 common	By removable screw terminal block (provided)	23.5 (B)	TM2 DMM 8DRT	0.095
24	16 I, 24 V $\overline{\text{DC}}$ sink/source	8 relay O (NO contact) 2 A (lth)	Inputs: 1 common Outputs: 2 common	By spring terminal block	39.1 (D)	TM2 DMM 24DRF	0.140

(1) Please refer to the "Modicon M238 logic controller" catalog.

(2) Module supports use of the Modicon Telefast ABE 7 pre-wired system.



TM2 AMI 2LT



TM2 ARI 8LRJ



TM2 ARI 8LT

Analog I/O expansion modules

Analog I/O expansion modules are mounted on the rear of XBT GC controller bases. The maximum number of digital and/or analog I/O modules depends on the type of XBT GC terminal and the thickness of the modules (see combination rule on page 2/17).

Analog input modules (1)

Channel type	Input range	Output range	Resolution	Connected by	Thickness mm (Type)	Reference	Weight kg
2 inputs	0 to 10 V 4 to 20 mA	–	12-bit	Removable screw terminal block (provided)	23.5 (B)	TM2 AMI 2LT	0.085
	Thermocouple J, K, T	–	12-bit	Removable screw terminal block (provided)	23.5 (B)	TM2 AMI 2LT	0.085
4 inputs	0 to 10 V 0 to 20 mA 2, 3 or 4 wire Pt100/1000 Ni100/1000 temperature probe	–	12-bit	Removable screw terminal block (provided)	23.5 (B)	TM2 AMI 4LT	0.085
8 inputs	0 to 10 V 4 to 20 mA	–	10-bit	Removable screw terminal block (provided)	23.5 (B)	TM2 AMI 8LT	0.085
	2 or 3-wire Pt100/1000 temperature probe	–	12-bit	RJ11 connector	23.5 (B)	TM2 ARI 8LRJ	–
	PTC/NTC	–	10-bit in NTC Detection of 2 thresholds in PTC	Removable screw terminal block (provided)	23.5 (B)	TM2 ARI 8LT	0.085

Analog output modules (1)

1 output	–	0 to 10 V 4 to 20 mA	12-bit	Removable screw terminal block (provided)	23.5 (B)	TM2 AMO 1HT	0.085
2 outputs	–	± 10 V	11-bit + sign	Removable screw terminal block (provided)	23.5 (B)	TM2 AVO 2HT	0.085

Analog I/O modules (1)

2 inputs and 1 output	0 to 10 V 4 to 20 mA	0 to 10 V 4 to 20 mA	12-bit	Removable screw terminal block (provided)	23.5 (B)	TM2 AMM 3HT	0.085
	Thermocouple J, K, T 2 or 3-wire Pt100 temperature probe	0 to 10 V 4 to 20 mA	12-bit	Removable screw terminal block (provided)	23.5 (B)	TM2 ALM 3LT	0.085
4 inputs and 1 output	0 to 10 V 4 to 20 mA	0 to 10 V 4 to 20 mA	12-bit	Removable screw terminal block (provided)	23.5 (B)	TM2 AMM 6HT	0.085

Separate parts

Designation	Description	Reference	Weight kg
Grounding plate	Support equipped with 10 male Faston connectors for connecting the cable shielding (via 6.35 mm Faston connectors, not included) and the functional grounds (FE)	TM2 XMT GB	0.045
Mounting kit Sold in lots of 5	For plate or panel mounting of analog modules	TWD XMT 5	0.065

(1) For specifications, please refer to the "Modicon M238 logical controller" catalog.



XBT GC1●●●

TM2 D●●
TM2 A●●

XBT GC1●●● Combinations of two expansion modules

Combinations of 2 I/O expansion modules with XBT GC1●●●		Type (1)	Type (1)	Total thickness (mm)	
A	A	A	A	35.2	Permitted combinations
A	B	A	B	41.1	
B	B	B	B	47.0	
A	C	A	C	47.3	
B	C	B	C	53.2	
A	D	A	D	56.7	
C	C	C	C	59.4	Prohibited combinations
B	D	B	D	62.6	
C	D	C	D	68.8	
D	D	D	D	78.2	



XBT GC2●●●

TM2 D●●
TM2 A●●

XBT GC2●●● Combinations of two expansion modules

Combinations of 2 I/O expansion modules with XBT GC2●●●		Type (1)	Type (1)	Total thickness (mm)	
A	A	A	A	35.2	Permitted combinations
A	B	A	B	41.1	
B	B	B	B	47.0	
A	C	A	C	47.3	
B	C	B	C	53.2	
A	D	A	D	56.7	
C	C	C	C	59.4	Prohibited combinations
B	D	B	D	62.6	
C	D	C	D	68.8	
D	D	D	D	78.2	

XBT GC2●●● Combinations of three expansion modules

Combinations of 3 I/O expansion modules with XBT GC2●●●		Type (1)	Type (1)	Type (1)	Total thickness (mm)	
A	A	A	A	A	52.8	Permitted combinations with hook (2)
A	A	A	B	B	58.7	
A	B	B	B	B	64.6	
B	B	B	B	B	70.5	
All other combinations					-	Prohibited

(1) For digital (TM2 D●●) and analog (TM2 A●●) I/O expansion module types, see pages 2/15 and 2/16:

- Type A: thickness 17.6 mm
- Type B: thickness 23.5 mm
- Type C: thickness 29.7 mm
- Type D: thickness 39.1 mm

(2) Hook included with product

Introduction

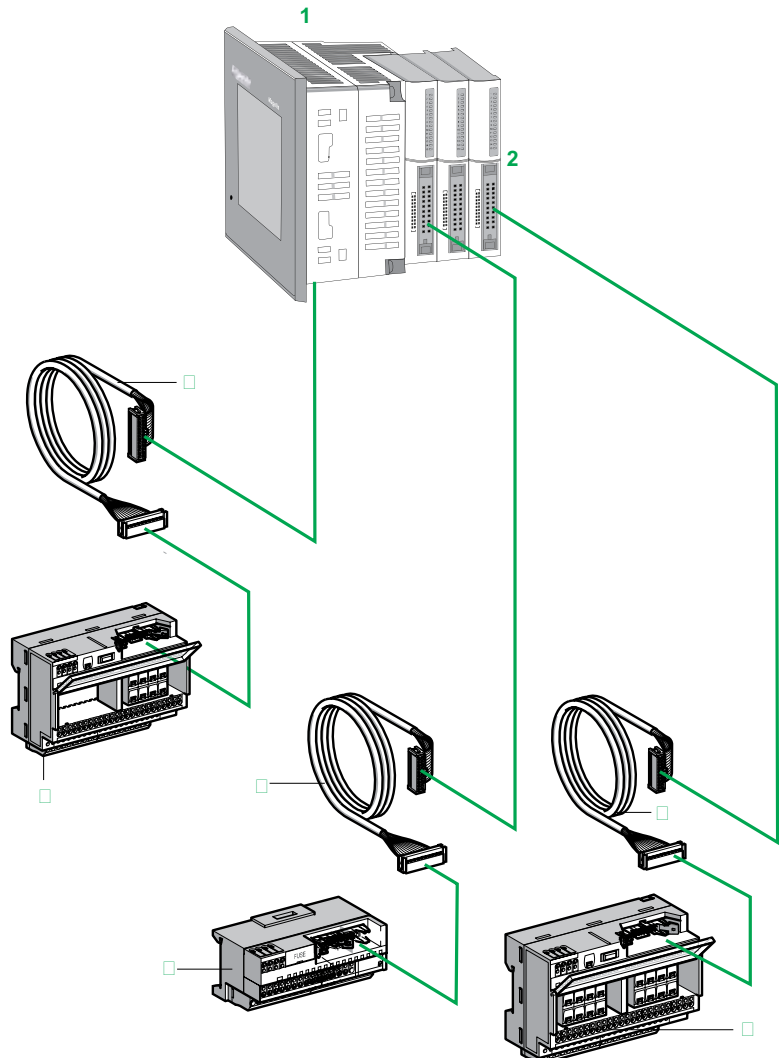

- 1 **XBT GC** equipped with 22 or 38-way direct I/O connectors. The modularity options offered have 18 or 32 I/O.
- 2 Digital I/O expansion modules equipped with 20-way HE10 connectors. The modularity options offered have 16 or 32 I/O.
- 3 2 m AWG 28/0.08 mm² cordsets, depending on the model:
 - For **XBT GC 1100T/U**: **XBT ZG ABE1** preassembled cordset with a 26-way HE 10 connector and a 22-way Direct I/O-XBT GC connector at each end
 - For **XBT GC 2●●T/U**: **XBT ZG ABE2** preassembled cordset with two 20-way HE 10 connectors and a 38-way Direct I/O-XBT GC connector
- 4 **ABF T20E●●0** preassembled cordset with a 20-way HE 10 connector at each end, available in 0.5, 1, 2 and 3 m lengths (AWG 28/0.08 mm²)
- 5 Depending on model:
 - For **XBT GC 1100T**: **ABE 7B20MPN2●** or **ABE 7B20MRM20** 20-channel sub-base for the bases
 - For **XBT GC 2●●T**: **ABE 7E16EPN20** or **ABE 7E16SPN20** 16-channel sub-base
- 6 **ABE 7E16SPN22** or **ABE 7E16SRM20** 16-channel sub-base for digital outputs integrated or on expansion modules
- 7 **ABE 7E16EPN20** or **ABE 7E16SPN20** 16-channel sub-base for digital inputs or outputs integrated or on expansion modules

Combinations involving modular bases and I/O expansion modules						
	XBT GC				Digital I/O expansion modules	
	Integrated digital I/O				Inputs	Outputs (source)
	XBT GC 1100T		XBT GC 2●●●T		TM2 DDI 16DK (16 I) TM2 DDI 32DK (32 I)	TM2 DDO 16TK (16 O) TM2 DDO 32TK (32 O)
Integrated in Twido programmable controllers	12 I	6 O source	16 I	16 O source		
Connection block types	Direct I/O, 22-way		Direct I/O, 38-way		HE 10, 20-way	
Connection to XBT GC programmable HMI Controller	XBT ZG ABE1		XBT ZG ABE2		ABF T20E●●0 (HE 10, 20-way)	
Passive connection sub-bases						
20-channel	ABE 7B20MPN2●		(1)			
16-channel	ABE 7E16EPN20					
	ABE 7E16SPN2●					
Output adaptor sub-bases						
20-channel	ABE 7B20MRM20		(2)			
16-channel	ABE 7E16SRM20					

 Compatible
 Incompatible

Note: Telefast cables and modules are not compatible with XBT GC units with sink outputs (U suffix).

(1) 6 channels used for 8 available

(2) 6 channels used for 8 available with 2 transistor outputs and 4 relay outputs

HMI Controllers

Modicon™ Telefast™ pre-wired system
for Magelis XBT GC HMI Controllers

2



ABE 7B20MPN20



ABE 7E16EPN20



ABE 7E16SRM20

References

For XBT GC 1100T bases

Number of I/O	No./ type of inputs	No./ type of outputs	Compatibility	LED per chnnl	Fuse	Reference	Weight kg
20	12, sink 24 V $\overline{\text{---}}$	6, sink 24 V $\overline{\text{---}}$	XBT GC1100T	No	No	ABE 7B20MPN20	0.430
				Yes	Yes	ABE 7B20MPN22	0.430
	12, sink 24 V $\overline{\text{---}}$	2, source 24 V $\overline{\text{---}}$, 2 A and 4, relay	XBT GC1100T	No	No	ABE 7B20MRM20	0.430

For expansion modules or XBT GC 2●● bases

Number of inputs	Input type	Compatibility	LED per chnnl	Fuse	Reference	Weight kg
16	Sink 24V $\overline{\text{---}}$	TM2 DDI16DK/ DDI32K and XBT GC2●●T	No	No	ABE 7E16EPN20	0.430

Number of outputs	Output type	Compatibility	LED per chnnl	Fuse	Reference	Weight kg
16	Source 24 V $\overline{\text{---}}$	TM2 DDO16TK/ DDO32TK and XBT GC2●●T	No	No	ABE 7E16SPN20	0.450
			Yes	Yes	ABE 7E16SPN22	0.450
	Relay 24 V $\overline{\text{---}}$, 250 V \sim , 3 A		No	No	ABE 7E16SRM20	0.430

Connection cables for XBT GC

Type of signal	Compatibility	Connection type		Gauge Cross-sect.	Length (1)	Reference	Weight kg
		XBT GC side	Telefast side				
Digital I/O	XBT GC 1100T	Direct I/O	HE 10 22-way	AWG 28 0.08 mm ²	2.0 m	XBT ZG ABE1	0.180
		Direct I/O	2 x HE 10 38-way				
	XBT GC 2●●0T	HE 10 20-way	HE 10 20-way	AWG 28 0.08 mm ²	0.5 m	ABF T20E050	0.060
					1 m	ABF T20E100	0.080
					2 m	ABF T20E200	0.140

Accessories

Designation	Number of shunted terminals	Specifications	Order in multiples of	Unit reference	Weight kg
Optional snap-on terminal blocks	20	–	5	ABE 7BV20	0.060
	12+8	–	5	ABE 7BV20TB	0.060
Quick-blow fuses 5 x 20, 250 V, UL	–	0.125 A	10	ABE 7FU012	0.010
		0.315 A	10	ABE 7FU030	0.010
		1 A	10	ABE 7FU100	0.010
		2 A	10	ABE 7FU200	0.010

(1) For cable lengths > 2 m, please contact our Customer Care Center.

References (continued)							
Separate parts							
Designation	Type	Compatibility		Reference	Weight kg		
Connectors Sold in lots of 5	HE 10 female 26-way	TWD LMDA20DTK/ LMDA40DTK		TWD FCN2K26	–		
	HE 10 female 20-way	TM2 DDI16DK/ DDI32DK/ DDO16TK/ DDO32TK		TWD FCN2K20	–		
Screw terminals Sold in lots of 5	10-way	TM2 DDI●DT/DAI8DT/ DDO8●T/DRA●RT		TWD FTB2T10	–		
	11-way	TM2 DMM8DRT/ AMI●●T/ARI8HT		TWD FTB2T11	–		

Designation	Compatibility	Connection type		Gauge/ Cross-sect.	Length	Reference	Weight kg
		Twido side	Other end				
Cables for digital I/O	TM2 DDI16DK/ DDI32DK/ DDO16TK/ DDO32TK	HE 10	Flying leads	AWG 22 0.035 mm ²	3 m	TWD FCW30K	0.405
		20-way			5 m	TWD FCW50K	0.670
Rolled ribbon cable	20 conductors	–	–	AWG 28 0.08 mm ²	20 m	ABF C20R200	1.310



XBT GC + XBT ZGC CAN



XBT ZGC CAN



Introduction

The **XBT ZGC CAN** module provides the CANopen bus master function for Magelis **XBT GC** HMI Controllers.

SoMachine™ software is used to configure the CANopen machine bus for the Magelis XBT GC HMI Controllers (see page 2/30).

The various services provided include:

- For Schneider Electric slaves such as ATV 312/61/71 variable speed drives and Lexium™ 32 servo drives one or more profiles are supplied for configuring the slave according to a predefined mode.

The use of profiles means that the user has a defined operating mode without having to configure it.

- For third-party slaves:

- The user can choose from an editable list by simply importing an EDS (Electronic Data Sheet) description file.
- The slave can be positioned on the bus with definition of the slave number, speed, monitoring, etc.
- The user can select variables from the list of variables managed by the slave.
- Variables can be linked to exchange data.
- Exchange data can be symbolized.

Description

The **XBT ZGC CAN** CANopen master bus module features:

- 1 3 LEDs (PWR, RUN and ERR) providing power supply and module operation status information
- 2 9-way male SUB-D connector for the CANopen bus
- 3 Connector for the **XBT GC** HMI Controller

Reference

Description	Reference	Weight kg
CANopen bus master module for Magelis XBT GC HMI Controller Conformity class M10	XBT ZGC CAN	0.100

Example architecture

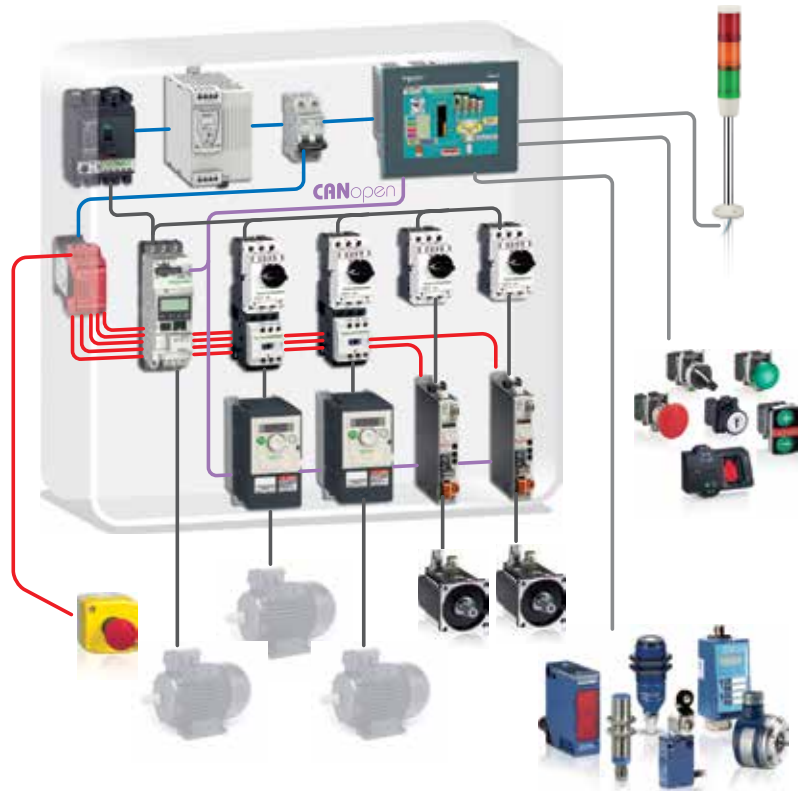

2

The above configuration shows an example architecture based on the Magelis **XBT GC** HMI Controller.

The **XBT ZGC CAN** expansion module provides the CANopen bus master function for the **XBT GC** HMI Controller.

The CANopen bus is made up of a master station, the Magelis **XBT GC** HMI Controller and slave stations. The master is in charge of configuration, exchanges and diagnostics to the slaves.

The CANopen bus is used to manage various slaves such as:

- Digital slaves
- Analog slaves
- Variable speed drives
- Motor starters

For an example connection from a *Distributed CANopen Optimized* architecture, see page 2/28.

2

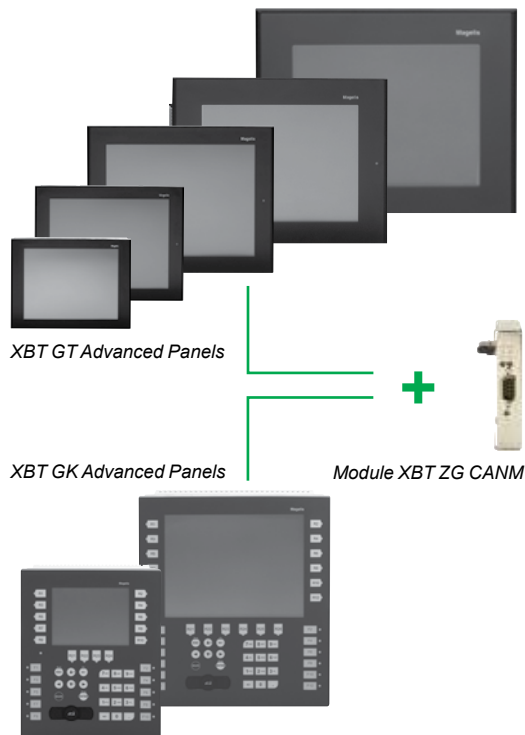

HMI function: Magelis XBT GT/GK Advanced Panels
+
Control function: XBT ZG CANM CANopen master module

Introduction

The **XBT ZG CANM** CANopen master bus module provides the control function for the Magelis **XBT GT** (5.7", 10.4", 12.1" or 15") and **XBT GK** (5.7" or 10.4") Standard Advanced Panels (see page 2/26).

SoMachine software is used to configure the CANopen machine bus for this module (see page 2/30).

The various services on offer include:

- For Schneider Electric slaves such as ATV 312/61/71 variable speed drives and Lexium 32 servo drives one or more profiles are supplied for configuring the slave according to a predefined mode. The use of profiles means that the user has a defined operating mode without having to configure it.
- For third-party slaves:
 - The user can choose from an editable list by simply importing an EDS (Electronic Data Sheet) description file.
 - The slave can be positioned on the bus with definition of the slave number, speed, monitoring, etc.
 - The user can select variables from the list of variables managed by the slave.
 - Variables can be linked to exchange data.
 - Exchange data can be symbolized.

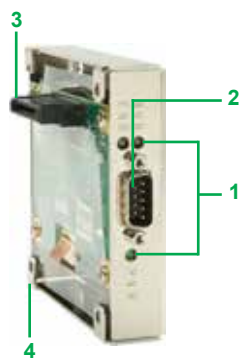

XBT ZG CANM

Description

The **XBT ZG CANM** CANopen master bus module features:

- 1 3 LEDs (PWR, RUN and ERR) providing power supply and module operation status information
- 2 9-way male SUB-D connector for connecting to the CANopen bus
- 3 Connector for connecting to the rear of the Magelis XBT GT/GK Standard Advanced Panels
- 4 Positions for mounting screws

Reference

Description	Reference	Weight kg
CANopen bus master module for Magelis XBT GT/GK Standard Advanced Panels Conformity class M10	XBT ZG CANM	0.100

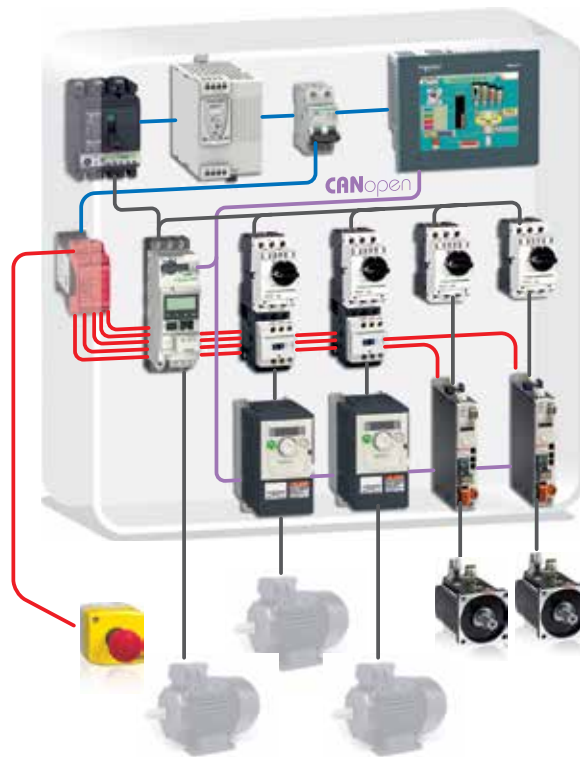
Example architecture

2

The above configuration shows an example architecture based on an **XBT GT/GK** Standard Advanced Panel.

The **XBT ZG CANM** expansion module provides the CANopen bus master function for the Magelis **XBT GT/GK** Standard Advanced Panel.

The CANopen bus is made up of a master station, the Magelis **XBT GT/GK** Standard Advanced Panel and slave stations. The master is in charge of configuration, exchanges and diagnostics to the slaves.

The CANopen bus is used to manage various slaves such as:

- Digital slaves
- Analog slaves
- Variable speed drives
- Motor starters

For an example connection from a *Distributed CANopen Optimized* architecture, see page 2/28.



XBT GT21●0 / 2220 / 2330

XBT GK monochrome touch screen terminals compatible with the XBT ZG CANM CANopen master module (1) (2)

Screen type	No. of ports	Application memory capacity	Compact Flash memory	Composite video input	No. of Ethernet ports	Reference	Weight kg
5.7" optimum QVGA screen							
STN blue mode	1 COM 1 1 COM 2 1 USB	16 MB	No	No	–	XBT GT2110	1.000
5.7" multifunction QVGA screen							
STN Black and white	1 COM 1 1 COM 2 1 USB	16 MB	Yes	No	–	XBT GT2120	1.000
					1	XBT GT2130	1.000



XBT GT4230 / 43●0

XBT GK color touch screen terminals compatible with the XBT ZG CANM CANopen master module (1) (2)

Screen type	No. of ports	Application memory capacity	Compact Flash memory	Composite video input	Embedded Ethernet	Reference	Weight kg
5.7" multifunction QVGA screen							
STN	1 COM 1 1 COM 2 1 USB	16 MB	Yes	No	–	XBT GT2220	1.000
TFT	1 COM 1 1 COM 2 1 USB	16 MB	Yes	No	1	XBT GT2330	1.000
High Brightness TFT	1 COM 1 1 COM 2 1 USB	16 MB	Yes	No	1	XBT GT2930	1.000
5.7" multifunction VGA screen							
TFT	1 COM 1 1 COM 2 2 USB	32 MB	Yes	No	1	XBT GT2430	–
7.5" multifunction VGA screen							
STN	1 COM 1 1 COM 2 1 USB	32 MB	Yes	No	1	XBT GT4230	1.800
TFT	1 COM 1 1 COM 2 1 USB	32 MB	Yes	No Yes	1 1	XBT GT4330 XBT GT4340	1.800 1.800
Multifunction 10.4" VGA screen							
TFT	1 COM 1 1 COM 2 2 USB	32 MB	Yes	No Yes	1 1	XBT GT5330 XBT GT5340	2.500 2.500
Multifunction 10.4" SVGA screen							
TFT	1 COM 1 1 COM 2 2 USB	32 MB	Yes	No	1	XBT GT 5430	2.500
Multifunction 12.1" SVGA screen							
TFT	1 COM 1 1 COM 2 2 USB	32 MB	Yes	No Yes	1 1	XBT GT6330 XBT GT6340	3.000 3.000
Multifunction 15" XGA screen							
TFT	1 COM 1 1 COM 2 2 USB	32 MB	Yes	Yes	1	XBT GT7340	5.600



XBT GT53●0



XBT GT63●0



XBT GT7340

(1) Terminals supplied with mounting kit (screw clips), locking device for USB connectors and instruction sheet. The setup documentation for XBT GT terminals is supplied in electronic format with SoMachine software (see page 2/33).

(2) All data relating to Magelis XBT GT Standard Advanced Panels is available on our site www.schneider-electric.com

XBT GK keypad/touch screen terminals compatible with the XBT ZG CANM CANopen master module (1) (2)

Screen type	No. of ports	Application memory capacity	Compact Flash memory	Video input	No. of Ethernet ports	Reference	Weight kg
5.7" multifunction screen							
STN Black and white	1 COM 1 1 COM 2 1 USB	32 MB	Yes	No	-	XBT GK2120	-
5.7" multifunction screen							
TFT Color mode	1 COM 1 1 COM 2 1 USB	32 MB	Yes	No	1	XBT GK2330	-
10.4" multifunction screen							
TFT Color mode	1 COM 1 1 COM 2 2 USB	32 MB	Yes	No	1	XBT GK5330	-



XBT GK2120 / 2330



XBT GK5330

(1) Terminals supplied with mounting kit (spring clips), locking device for USB connectors, customizable label sheets and instruction sheet.

(2) All data relating Magelis XBT GK Standard Advanced Panels is available on our website www.schneider-electric.com.

Optimized CANopen architecture

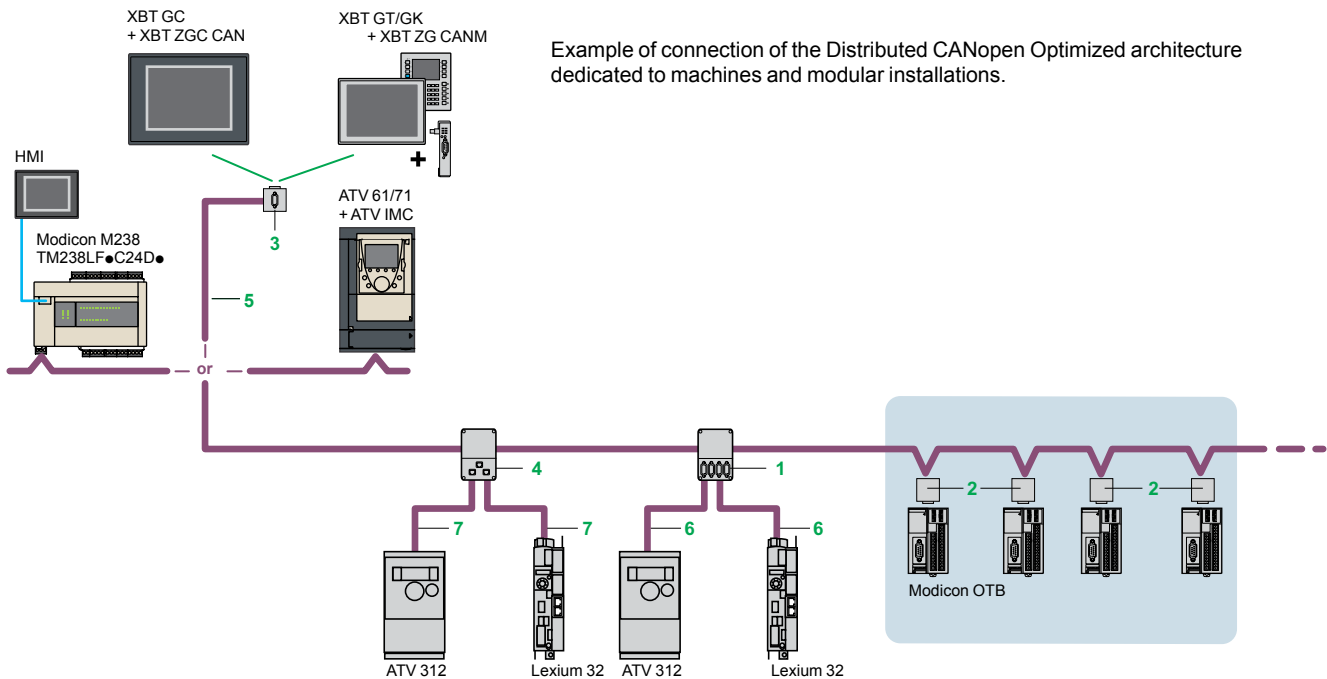

References

Standard tap junctions and connectors

Designation	Description	Item no.	Length	Unit reference	Weight kg
IP 20 CANopen tap junction	4 SUB-D ports. Screw terminal block for connecting the trunk cables Line termination	1	-	TSX CAN TDM4	0.196
IP 20 CANopen connectors (9-way female SUB-D)	Right angle	2	-	TSX CAN KCDF 90T	0.046
	Straight (1)	-	-	TSX CAN KCDF 180T	0.049
	Switch for line termination	3	-	TSX CAN KCDF 90TP	0.051
M12 IP67 connectors	Male	-	-	FTX CN 12M5	0.050
	Female	-	-	FTX CN 12F5	0.050
IP 20 CANopen tap junction for Altivar and Lexium 32	2 RJ45 ports	4	-	VW3 CAN TAP2	0.250
Daisy chain taps	Equipped with: - 2 spring terminal blocks for daisy chain connection of the CANopen bus - 1 preassembled cordset with RJ45 connector for connecting the drive	-	0.6	TCS CTN 026M 16M	-
	Equipped with: - 2 RJ45 connectors for daisy chain connection of the CANopen bus - 1 preassembled cordset with RJ45 connector for connecting the drive	-	0.3	TCS CTN 023F 13M03	-
CANopen line terminators	For RJ45 connector Sold in lots of 2	-	-	TCS CAR013M120	-
	For screw terminal block connector Sold in lots of 2	-	-	TCS CAR01NM120	-

(1) To connect to the Altivar IMC card.



TSX CAN TDM4



VW3 CAN TAP2



TSX CAN KCD F90T



TSX CAN KCD F180T



TSX CAN KCD F90TP



TCS CAR013M120

References (continued)

IP 20 standard cables and preassembled cordsets

Designation	Description	Item no.	Length	Unit reference	Weight kg
CANopen cables (2 x AWG 22 2 x AWG 24)	For standard environment (1), C€ marking: Low smoke zero halogen Flame-retardant (IEC 60332-1)	5	50 m	TSX CAN CA50	4.930
			100 m	TSX CAN CA100	8.800
			300 m	TSX CAN CA300	24.560
	For standard environment (1), UL certification, C€ marking: Flame-retardant (IEC 60332-2)	5	50 m	TSX CAN CB50	3.580
			100 m	TSX CAN CB100	7.840
			300 m	TSX CAN CB300	21.870
	For harsh environment (2) or mobile installation, C€ marking: Low smoke zero halogen. Flame-retardant (IEC 60332-1). Resistance to oils	5	50 m	TSX CAN CD50	3.510
			100 m	TSX CAN CD100	7.770
			300 m	TSX CAN CD300	21.700
CANopen preassembled cordsets One 9-way female SUB-D connector at each end	For standard environment (1), C€ marking: Low smoke zero halogen. Flame-retardant (IEC 60332-1)	-	0.3 m	TSX CAN CADD03	0.091
			1 m	TSX CAN CADD1	0.143
			3 m	TSX CAN CADD3	0.295
			5 m	TSX CAN CADD5	0.440
	For standard environment (1), UL certification, label marking C€: flame retardant (IEC 60332-2)	-	0.3 m	TSX CAN CBDD03	0.086
			1 m	TSX CAN CBDD1	0.131
			3 m	TSX CAN CBDD3	0.268
			5 m	TSX CAN CBDD5	0.400
CANopen preassembled cordsets	Cordsets with one 9-way female SUB-D connector and one RJ45 connector	6	0.5 m	TCS CCN 4F3 M05T	0.100
			1 m	TCS CCN 4F3 M1T	0.100
				VW3 M38 05 R010 (3)	0.100
	Cordsets with two 9-way SUB-D connectors, one male and one female	-	0.5 m	TLA CD CBA 005	0.100
			1.5 m	TLA CD CBA 015	0.120
			3 m	TLA CD CBA 030	0.190
	5 m	TLA CD CBA 0	0.350		



VW3 CAN A71



AMO 2CA 001V000



FTX DP21●●

IP 20 connection accessories

CANopen connector for Altivar 71 (4)	9-way female SUB-D. Switch for line termination. Cables exit at 180°	-	-	VW3 CAN KCDF 180T	0.100
Adaptor for Altivar 71 drive	SUB-D to RJ45 CANopen adaptor	-	-	VW3 CAN A71	0.100
CANopen preassembled cordsets	1 RJ45 connector at each end	7	0.3 m	VW3 CAN CARR03	0.100
			1 m	VW3 CAN CARR1	0.100
CANopen bus adaptor for Lexium 17D	Hardware interface for link conforming to the CANopen standard + 1 connector for connecting a PC terminal	-	-	AMO 2CA 001V000	0.110
Y-connector	CANopen/Modbus	-	-	TCS CTN011M11F	0.100

(1) Standard environment: no particular environmental constraints, operating temperature between + 5°C and + 60°C, and in mounted installations.

(2) Harsh environment: resistance to hydrocarbons, industrial oils, detergents, solder splashes, relative humidity up to 100%, saline atmosphere, significant temperature variations, operating temperature between - 10°C and + 70°C, or in mobile installations.

(3) Cordset equipped with a line terminator.

(4) For ATV 71H●●M3, ATV 71HD11M3X, HD15M3X, ATV 71H075N4 to HD18N4 drives, this connector can be replaced by the TSX CAN KCDF 180T connector.



SoMachine software platform

Introduction

SoMachine is the OEM solution software for developing, configuring and commissioning the entire machine in a single software environment, including logic, motion control, HMI and related network automation functions.

SoMachine allows you to program and commission all the elements in Schneider Electric's Flexible and Scalable Control platform, the comprehensive solution-oriented offer for OEMs, which helps you achieve optimized control solutions for each machine's requirements.

Flexible and Scalable Control platforms include:

Controllers:

- HMI controllers: XBT GC, XBT GT/GK CANopen™,
- Logic controllers: Modicon™ M238™, Modicon M258™,
- Motion Controller: Modicon LMC 058,
- Integrated Controller Card: Altivar™ IMC,
- I/Os range: Modicon TM2, Modicon TM5 and Modicon TM7 offers

HMI:

- Small Panels Magelis STO/STU
- Advanced Panels Magelis GH/GK/GT
- Optimum Advanced Panels Magelis GTO

SoMachine is a professional, efficient, and open software solution integrating Vijeo™ Designer™.

It integrates also the configuring and commissioning tool for motion control devices. It features the IEC 61131-3 languages, integrated field bus configurators, expert diagnostics and debugging, as well as outstanding capabilities for maintenance and visualization.

SoMachine integrates tested, validated, documented and supported expert application libraries dedicated to applications in Pumping, Packaging, Hoisting and Conveying.

SoMachine provides you:

- One software package
- One project file
- One cable connection
- One download operation

Visual graphic user interface

Navigation within SoMachine is intuitive and highly visual. Introduction is optimized in such a way that selecting the development stage of the desired project makes the appropriate tools available. The user interface ensures nothing is overlooked, and suggests the tasks to be performed throughout the project development cycle. The workspace has been streamlined, so that only that which is necessary and relevant to the current task is featured, without any superfluous information.

Learning center

From the home menu, the learning center provides several tools to get started with SoMachine. An animated file explains briefly the SoMachine interface and concept. An e-learning allows to run a self-training about SoMachine. A third section gives access to several documented examples of simple coding with SoMachine. An intuitive and efficient online help is also available, guiding you to get the appropriate answer.

Project management

The implemented project management principle allows to browse quickly through the existing projects getting the relevant information without the need to open them before selection.

The user can create a new project, starting from several means: using Tested Validated and Documented Architectures, using the provided examples, using an existing project or start with an empty project. There is quick access to the most recently-used projects.

There is, as well, a way to start a project from "standard" project taking advantages of a pre-configured program (task, library, etc.)

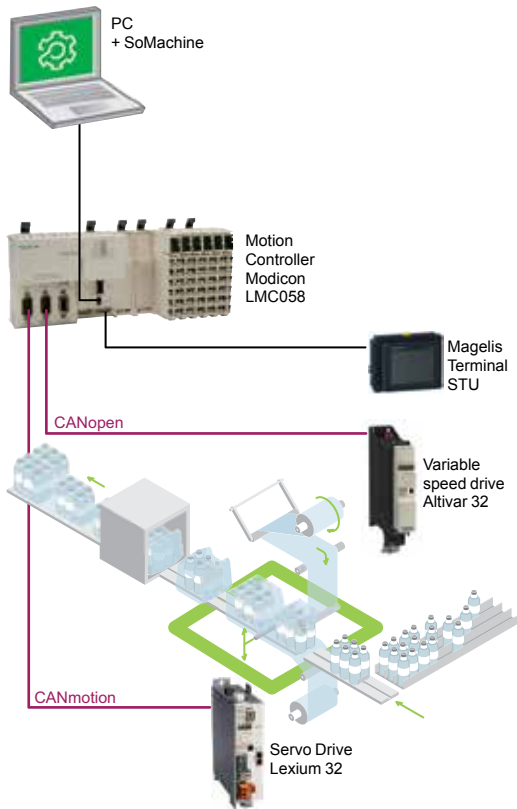

Software solution



Project management

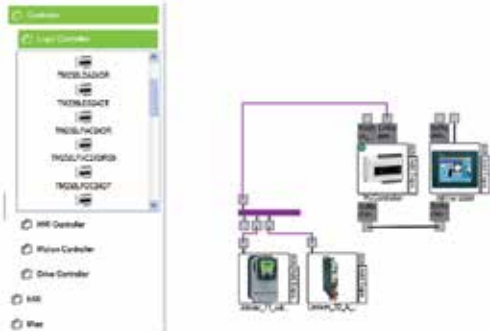

Configuration

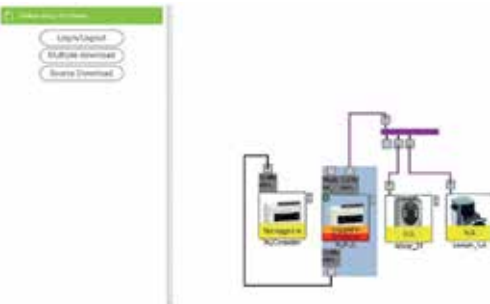

Commissioning

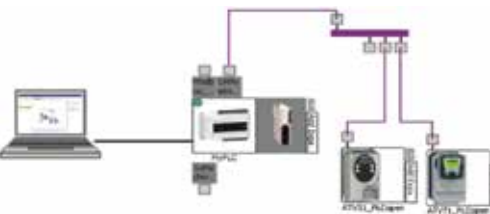

Transparency



Application Function Blocks

Project properties

Using SoMachine™, the user has the option to define additional information for each project, through simple forms. It's also possible to attach documents, a customer picture and a configuration picture.

Configuration

From the graphic user interface, the user can easily build their architecture and configure the devices of the architecture.

Description of the architecture

A graphic editor can be used to assemble the various elements easily by a simple drag & drop. A devices catalog is displayed on the left of the screen. It is split into several sections: controllers, HMI, Miscellaneous and search.

Configuration of the device

Directly from the topologic view of the user interface, a simple click drives the user to the configuration screen of the selected device.

Programming and debug

Programming is an essential step, and the user has to carefully design it to be as efficient as possible. Advanced control and HMI functions cover all the needs of an OEM engineer in terms of creating the control and visualization system. Powerful tools allow debug and functional tests such as simulation, step-by-step execution, break points and trace.

Commissioning

For an easy and fast diagnostic, the commissioning menu allows the user to check the online state of his architecture. Through the topologic view of the configuration, the devices display if you are logged in or not, as well as if they are in run or stop mode.

Documentation

Because a printed file of the project is an important element, it is possible to build and customize the project report:

- select the items to be included in the report,
- organize the sections,
- define the page layout
- and then launch the printing.

Transparency

SoMachine supports Device Type manager (DTM) because it is a field device tool (FDT) container.

With DTM's representing field device in SoMachine, direct communications are possible to every single device via SoMachine, the controller and the field bus (Modbus for all devices and CANopen for the I/O's).

From the SoMachine unique environment, the remote devices can be set-up off-line and tuned on-line.

Dedicated OEM application libraries (AFB libraries)

SoMachine can be extended through its solution extension DVD. It integrates tested, validated, documented and supported expert application libraries dedicated to many OEM applications. Their simple configuration speeds up design, commissioning, installation and troubleshooting.

These libraries cover the following applications:

- Packaging,
- Hoisting,
- Conveying,
- Pumping

Tested Validated Documented Architectures (TVDA)

SoMachine provides a variety of preset projects with ready-to-use architectures you can adapt to individual requirements. Some of them are generic TVDA, they are based on controllers configuration. The solution extension DVD brings specific application solutions oriented TVDA's to SoMachine.

SoMachine specifications

Overview	
IEC 61131-3 programming languages	<ul style="list-style-type: none"> ■ IL (Instruction List) ■ LD (Ladder Diagram) ■ SFC (Sequential Function Chart) ■ ST (Structured Text) ■ FBD (Function Block Diagram) ■ + CFC (Continuous Function Chart)
Controller programming services	<ul style="list-style-type: none"> ■ Multi-tasking: Mast, Fast, Event ■ Functions (Func) and Function Blocks (FBs) ■ Data Unit Type (DUTs) ■ On-line changes ■ Watch windows ■ Graphical monitoring of variables (trace) ■ Breakpoints, step-by-step execution ■ Simulation ■ Visualization for application and machine set-up
HMI-based services	<ul style="list-style-type: none"> ■ Graphics libraries containing more than 4000 2D and 3D objects. ■ Simple drawing objects (points, line, rectangles, ellipses, etc to) ■ Preconfigured objects (button, switch, bar graph, etc to) ■ Recipes (32 groups of 256 recipes with max. 1024 ingredients) ■ Action tables ■ Alarms ■ Printing ■ Java scripts ■ Multimedia file support: wav, png, jpg, emf, bmp ■ Variable trending
Motion services	<ul style="list-style-type: none"> ■ Embedded devices configuration and commissioning ■ CAM profile editor ■ Sample application trace ■ Motion and drive function blocks libraries for inverters, servos and steppers ■ Visualization screens ■ Logical encoder
Global services	<ul style="list-style-type: none"> ■ User access and profile ■ Project documentation printing ■ Project comparison (control) ■ Variable sharing based on publish/subscribe mechanism ■ Library version management ■ Energy efficiency machine monitoring
Integrated fieldbus configurators	<ul style="list-style-type: none"> ■ Control network: <ul style="list-style-type: none"> □ Modbus Serial Line □ Modbus TCP ■ Field bus: <ul style="list-style-type: none"> □ CANopen □ CANmotion ■ Connectivity: <ul style="list-style-type: none"> □ Profibus-DP □ Ethernet IP
Expert and solutions libraries	<ul style="list-style-type: none"> ■ PLCopen function blocks for Motion control <ul style="list-style-type: none"> □ Example: MC_MoveAbsolute, MC_CamIn, ServoDrive ■ Packaging function blocks <ul style="list-style-type: none"> □ Example: Analog film tension control, rotary knife, lateral film position control ■ Conveying function blocks <ul style="list-style-type: none"> □ Example: tracking, turntable, conveyor □ Hoisting functions □ Hoisting function blocks: anti-sway, anti-crab, hoisting position synchronisation □ Application template for industrial crane ■ Pumping application <ul style="list-style-type: none"> □ Pumping function blocks □ Application template for booster ■ Energy Efficiency library

Product offer

SoMachine software is delivered on a DVD, it is a product oriented version that includes all SoMachine features related to generic hardware (M238, M258, LMC058, XBT GC, Altivar IMC), as well as generic TVDA

The solution features are added to SoMachine by installing its solution extension DVD. It includes all SoMachine solutions hardware, plus all the dedicated application libraries and TVDA.

References

- SoMachine is available in 6 languages:
 - English
 - French
 - German
 - Italian
 - Spanish
 - Simplified Chinese.
- System Requirements:
 - Processor: Pentium 4 - 1,8 GHz or higher , Pentium M 1.0 GHz or equivalent
 - RAM Memory: 2 GByte; recommended: 3 GByte
 - Hard Disk: 3.5 GB, recommended: 5 GB
 - OS: Windows XP Professional, Windows 7 Professional 32/64 bytes
 - Drive: DVD reader
 - Display: 1024 × 768 pixel resolution or higher
 - Peripherals: a Mouse or compatible pointing device
 - Peripherals: USB interface
 - Web Access: Web registration requires Internet access
- The documentation is supplied in electronic format: complete on-line help plus complementary documentation in pdf format.

SoMachine software for generic controllers

Supported controllers	TVDA	Reference	
		DVD (1)	License (2)/ number & type
<ul style="list-style-type: none"> ■ M238 ■ M258 ■ LMC058 ■ XBT GC ■ XBT GT/GK with control function ■ Altivar IMC 	<ul style="list-style-type: none"> - Optimized HW XBT GC - Optimized HW M238 - Optimized CANopen M238 - Optimized AS-Interface M238 - Optimized CANopen XBT GC/GT/GK - Optimized CANopen Altivar IMC - Performance HW M258 - Performance CANopen M258 - Performance CANmotion LMC058 	MSD CHN SFN V31 + Trial license (30 days)	MSD CHN LMUA /1 (Single) MSD CHN LMTA /10 (Team) MSD CHN LMFA /100 (Facility)

SoMachine solution extension for Solution controllers (3)

Added controllers	Added TVDA	Added libraries	Reference (4)
			DVDs and License / number & type
<ul style="list-style-type: none"> ■ M238S ■ M258S ■ LMC058S ■ XBT GC with CANopen module type S ■ XBT GT/GK with control function type S ■ Altivar IMC with control function type S 	<ul style="list-style-type: none"> - Optimized CANopen Altivar IMC - Performance CANmotion LMC058 - Hoisting Optimized CANopen M238 - Conveying Performance CANmotion LMC058 	<ul style="list-style-type: none"> Hoisting Conveying Packaging 	MSD CHL LMU V31 S0 / 1 (Single) MSD CHL LMT V31 S0 / 10 (Team) MSD CHL LMF V31 S0 / 100 (Facility)

SoMachine software compatibility and hardware control platforms

Product type	Version
Logic controller Modicon M238	≥ V1.0
HMI controller XBT GC	
Logic controller Modicon M238S	≥ V2.0
Logic controller Modicon M258	
Logic controller Modicon M258S	
Motion controller Modicon LMC058	≥ V3.0
Motion controller Modicon LMC058S	≥ V2.0
HMI controller XBT GT/GK with control function type S, XBT GC with CANopen module type S	
Altivar IMC integrated controller card	≥ V3.1
Altivar IMC integrated controller card with control function type S	≥ V2.0
TM5 CANopen Interface	≥ V3.0
TM7 CANopen Interface block	
Altivar IMC integrated controller card (with patch)	

(1) The DVD is mandatory and delivered with a trial license.
 (2) One of the 3 type of Licenses is mandatory.
 (3) For this offer, please contact Schneider electric.
 (4) Each reference for SoMachine solution software contains: one generic trail DVD, one solution extension V3.1 DVD and one license.

3.1 - Magelis™ PC Panels

Selection guide 3/2

- Maintenance-free PC Panels Magelis
 - Introduction 3/4
 - Magelis Smart iPC 12" 3/8
 - Separate components and equivalent product table 3/8
- PC Panels Magelis
 - Introduction 3/4
 - Magelis Compact iPC 12" 3/9
 - Separate components and equivalent product table 3/9

3.2 - Magelis Panel PC and BOX PC

General selection guide 3/10

- General introduction. 3/12
- Magelis Panel PC, Optimum range

Selection guide 3/14

- Introduction 3/16
- 10.4" touch screens with aluminum front panel bezel 3/17
- 15" touch screens with stainless steel front panel bezel 3/17

- Magelis Panel PC, Universal and Performance ranges

Selection guide 3/18

- Introduction 3/22
- 15" touch screen, Universal range 3/26
- 15" touch screen, Performance range 3/27
- 19" touch screen, Universal range 3/28
- 19" touch screen, Performance range 3/29

- Magelis Panel PC, Optimum / Universal / Performance ranges

- Components 3/30
- Configured Magelis Panel PC industrial PC 3/31
- Equivalent product table. 3/32

- Industrial PCs Magelis BOX PC, Universal and Performance ranges

Selection guide 3/34

- Introduction 3/36
- Magelis BOX PC 3/40
- Components 3/41
- Configured Magelis BOX PC 3/42
- Equivalent product table. 3/43

3.3 - Magelis iDisplay flat screens

Selection guide 3/44

- Mangelis iDisplay flat screens
 - Introduction 3/46
 - iDisplay flat screens: 15", 19" 3/47
 - Components 3/47

Industrial PC
Model

Maintenance-free PC Panels
12" Magelis Smart iPC



Screen	Type	
	Definition	
	Number of colors	
	Brightness	
Touch panel		
CPU	Processor	
	Storage	Storage disks
		Compact Flash card (SLC type)
	RAM (1 memory slot)	
	Expansion slots	PCI bus
		Memory cards
	Ethernet TCP/IP ports	
	I/O ports	On the front panel
		Other

12" color TFT LCD
SVGA 800 x 600
262 144
≥ 250 cd/m ² (adjustable)
Analog resistive, 1 million cycles
Intel Celeron M 1 GHz
–
2 GB minimum, expandable to 4 GB (with OS and installed software)
512 MB SDRAM expandable to 1024 MB
–
1 x free bus slot (taking 1 type II PCMCIA card)
2 RJ45 ports: 1 x 10/100/1000BASE-T and 1 x 10/100BASE-T
1 x USB 2.0 type A
4 x USB 2.0 type A
1 x COM1 (RS 232C, 9-way male SUB-D)
1 x audio (1 line out, mini-jack)
1 x RAS (1)

Standards and certifications

- UL 508, CSA 142, IEC 61131-2,
- ATEX II 3 dust (zone 22) (2)

Integrated software	Operating system	
	Human Machine Interface	
	Supervision	
	Development environment	
	Other	

Windows XP Embedded Standard 2009
Vijeo Designer Run Time 21-day trial version (3)
Vijeo Citect Web Client
.NET Framework
Internet Explorer, Outlook Express Client, Microsoft Office Readers

Supply voltage

- 24 V --- (19.2 to 28.8 V)
- 100 to 240 V ~ (85 to 265 V)
- 40 W max. (---)
- 95 VA max. (~)

Consumption (without peripherals)

Degree of protection (when mounted on enclosure door)

IP65 for front panel when USB port not in use, IP 20 for rest of PC panel

Dimensions	Overall dimensions (W x H x D)	
	Cut-out (W x H)	

313 x 239 x 60 mm
301.5 x 227.5 (+1, -0) mm

Environment	Operating temperature	
	Vibration resistance during operation	

0 to + 50°C
0.075 mm amplitude from 10 to 57.6 Hz, 1 g from 57.6 to 150 Hz, conforming to EN 61131-2

References of Magelis Smart iPC PC Panels	Vijeo Citect Web Client	100 to 240 V ~
		24 V ---

MPC ST2 1NAJ 20T
MPC ST2 1NDJ 20T

References of PC Panels Magelis Compact iPC	With Hard Disk	100 to 240 V ~
	With Flash Disk SDD	100 to 240 V ~

Pages

3/8

(1) Reliability, Availability and Serviceability.
(2) --- version only.

PC Panels

Magelis Compact iPC 12"



12" color TFT LCD

XGA 1024 x 768

262 144

≥ 250 cd/m² (adjustable)

Analog resistive, 1 million cycles

Intel Celeron M 1.5 GHz

- For **MPC KT2 2NAX 20N**: IDE hard disk (HDD) (2.5") ≥ 250 GB
- For **MPC KT2 2MAX 20N**: Flash disk (SSD type SLC) ≥ 15 GB

–

512 MB SDRAM expandable to 1024 MB (1 slot)

1 x free PCI bus slot

1 x free bus slot for Compact Flash card (SLC type)

1 x free bus slot for PCMCIA card (taking a maximum of 1 type II card)

2 RJ45 ports: 1 x 10/100/1000BASE-T and 1 x 10/100BASE-T

1 x USB 2.0 type A

4 x USB 2.0 type A

1 x COM1 (RS 232C, 9-way male SUB-D)

1 x RAS (9-way female SUB-D)

1 x audio (line out, mini jack)

UL 508, IEC 61131-2, cUL

Windows XP Pro SP2

Vijeo Designer Run Time 21-day trial version (3)

–

–

–

100 to 240 V ~ (85 to 265 V), conforming to EN 61131-2

120 VA max.

IP65 for front panel (when USB port on front panel not in use), IP 20 for rest of PC Panel

313 x 239 x 103 mm

301.5 x 227.5 (+1, -0) mm

0 to + 50°C

0.075 mm amplitude from 10 to 57.6 Hz, 1 g from 57.6 to 150 Hz, conforming to EN 61131-2

MPC KT2 2NAX 20N

MPC KT2 2MAX 20N

3/9

(3) Unlimited usage available by activation of license **VJDSNRTMPC** (sold separately, see page 3/9).



See more technical information online at www.schneider-electric.com

Magelis™ Human/Machine Interfaces

Industrial PCs

Magelis Smart iPC and Magelis Compact iPC PC Panels



3

Introduction

UL 508 certified as automation products, Magelis Smart iPC and Magelis Compact iPC PC Panels are the natural extension to operator terminals. They have the same cut-out dimensions for mounting, but offer an open operating system.

Magelis Smart iPC and Magelis Compact iPC meet the needs of machine manufacturers, system integrators and users by integrating as closely as possible the features of industrial terminals:

- Extremely easy installation and setup
- Compact size
- Openness to Web technologies
- Maintenance-free operation of Magelis Smart iPC due to no rotating parts (no fan or hard disk)

Magelis Smart iPC and Magelis Compact iPC PC Panels offer the openness of the PCs to Windows XP:

- Windows XP Embedded on Compact Flash card for Magelis Smart iPC
 - Windows XP Pro on Hard disk for Magelis Compact iPC
- They are compatible with standard Windows applications, such as Internet Explorer, Outlook Express, Office readers and third-party software.

They are also supplied with a 21-day trial version of Vijeo Designer Run Time. Continued use of Vijeo Designer requires a license which is sold separately (see page 3/7).

Magelis Smart iPC and Compact iPC are "all in one" PC Panels with an IP65 front panel and a high-definition analog touch panel.

They have two built-in Ethernet TCP/IP ports:

- 1 x 10/100/1000BASE-T
- 1 x 10/100BASE-T

With these two ports they are suitable for use with Transparent Ready architectures and equipment (combination of Web and Ethernet TCP/IP technologies). And, they allow the viewing of Web pages either locally or remotely, with the same level of ease.

Magelis Smart iPC

Magelis Smart iPC has a 12" SVGA LCD TFT color screen and an Intel Celeron M 1 GHz processor. Windows XP Embedded Standard 2009 is installed on its Compact Flash card together with the following software components:

- Internet Explorer browser and Outlook Express e-mail client
- JVM (Java Virtual Machine)
- Windows Terminal Services Client for client/server architectures
- Office readers for access to device documentation (.pdf, .doc, .xls and .ppt documents)
- Vijeo Citect Web Client
- Vijeo Designer (demo version)
- .NET Framework

With these components Magelis Smart iPC can be used for the system diagnostics, viewing and set-up of Schneider Electric Transparent Ready products, as well as for access to FactoryCast services (see "Transparent Ready, embedded Web servers"). It also provides access to Vijeo Citect SCADA servers (with a Web Client license).

Magelis Smart iPC 12" is available for 24 V DC or 100 to 240 V AC supplies.

Magelis Compact iPC

Magelis Compact iPC has a 12" XGA LCD TFT color screen and an Intel Celeron M 1.5 GHz processor. Windows XP Pro is installed, enabling the running of third-party software. It is equipped with:

- 512 MB expandable RAM
- PCI expansion slot
- Replaceable 250 GB hard disk or a 15 GB Flash Disk (SLC technology SSD)
- Slot for a type II PCMCIA card

Magelis Compact iPC 12" is available for a 100 to 240 V AC supply.

Magelis Smart iPC and Magelis Compact iPC architecture examples

Connections to Vijeo Citect architectures

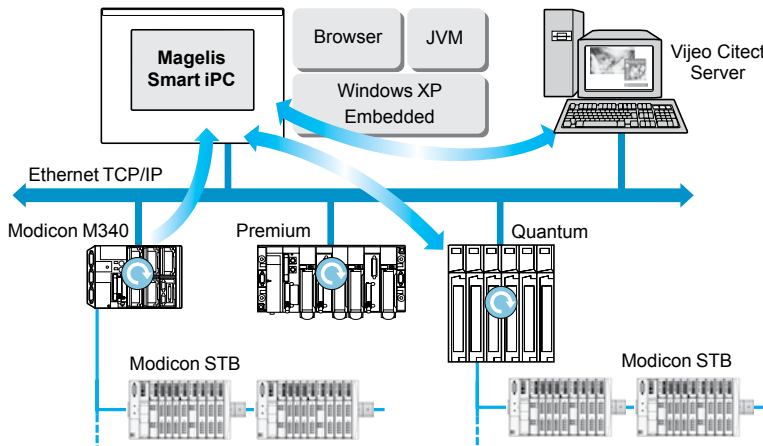

With a built-in dual Ethernet port, Magelis Smart iPC and Compact iPCs can be integrated into "full Ethernet" architectures, such as Transparent Ready (transparent communication on the Ethernet TCP/IP network). Communication services and Web services enable data to be shared and distributed between levels of the Transparent Ready architecture.

Magelis Smart and Compact iPCs enable the setup of Client stations in relation to Web servers embedded in the automation systems, and field devices (distributed I/O, variable speed drives, identification systems)... plus any other IT application.

Magelis Smart iPC

With the pre-installed Vijeo Citect Web Client software and by using Internet Explorer, Magelis Smart iPC 12" products are "Web Client" on a Vijeo Citect server, provided that the Web Client license is activated on the Vijeo Citect server.

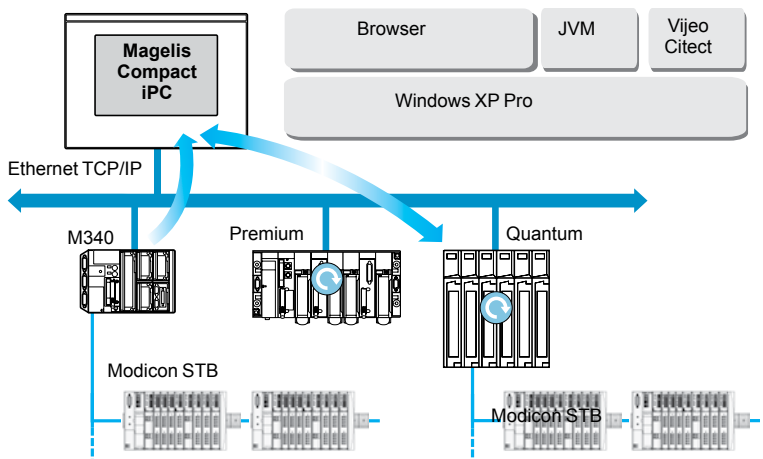

Magelis Compact iPC

A Vijeo Citect client/server license can be installed on Magelis Compact iPC 12" products, preferably on the Flash Disk version, in order to avoid the risk of a non-operational storage device. For a long life of the Flash Disk, it is strongly recommended that:

- at least 50% of available disk space is kept available for sharing of written data, and
- a reasonable storage frequency is maintained

Human Machine Interface applications

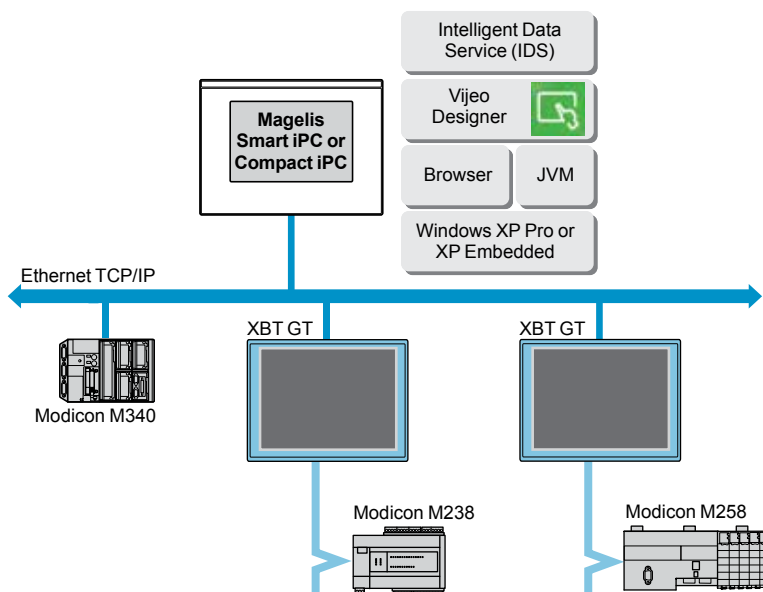

Magelis Smart iPC and Compact iPC are supplied with a 21-day trial version of Vijeo Designer Run Time. Continued use of Vijeo Designer requires a license which is sold separately (see page 3/9).

Vijeo Designer can be used to create control applications for Magelis terminals and industrial PCs. It can be installed on any storage device without reducing service life, with the writing operations to disk being limited to archiving.

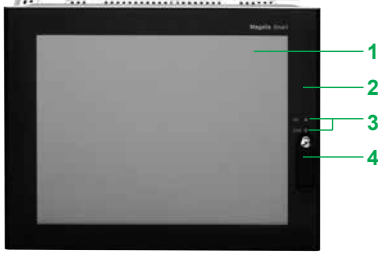

Magelis Smart iPC 12" PC Panels

Touch screen front panel

The touch screen front panel of the 12" industrial PCs **MPC ST2 1N●J 20T** includes:

- 1 12" SVGA active matrix color LCD TFT screen (maximum display area 800 x 600) with high-definition analog touch panel
- 2 Aluminum alloy front panel with IP65 membrane (mounted on a hardened steel frame)
- 3 Two LEDs marked:
 - ON (green), PC switched on
 - DISK (green), accessing IDE bus (accessing Compact Flash memory, etc.)
- 4 Dust and damp proof USB 2.0 port

Underside and left-hand side

The underside and left-hand side of the industrial PCs **MPC ST2 1N●J 20T** includes:

- 1 Removable screw terminal for connecting the AC power supply
- 2 Access to the Compact Flash memory card containing the operating system and installed software
- 3 One 9-way male SUB-D connector marked COM1 for the RS 232 serial link
- 4 4 USB 2.0 ports
- 5 2 RJ45 ports for the Ethernet link:
 - 1 x 10/100/1000 Mbps
 - 1 x 10/100 Mbps
- 6 Slot for 1 additional PCMCIA type II card
- 7 Mini-jack port for a loudspeaker
- 8 RAS (Reliability, Availability and Serviceability) port

All expansion slots and connection elements are therefore accessible from the rear of the PC.

Note: AC versions have an On/Off switch.

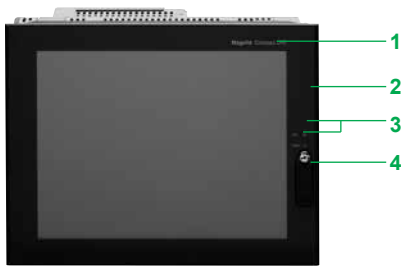

Magelis Compact iPC 12" PC panels

Touch screen front panel

The touch screen front panel of the 12" industrial PCs **MPC KT2 2●AX 20N** includes:

- 1 12" XGA active matrix color LCD TFT screen (maximum display area 1024 x 768) with high-definition analog touch panel
- 2 Aluminum alloy front panel with IP 65 membrane (mounted on a hardened steel frame)
- 3 Two LEDs marked:
 - ON (green), PC switched on
 - DISK (green), accessing IDE bus (accessing hard disk memory, etc.)
- 4 Cover plate which provides IP 65 protection when in position and gives access when removed to:
 - USB 2.0 port
 - "Pencil point" RESET button for restarting the processor

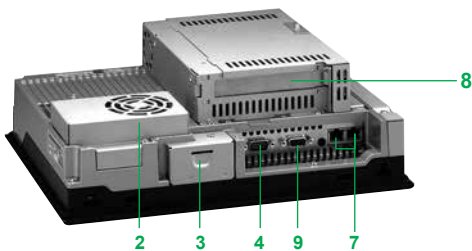

Underside and side panels

All expansion slots and connection elements are accessible from the rear of the PC:

- 1 Connector for plugging in the 100 to 240 V ~ power cable
- 2 One vent equipped with an anti-dust filter and a fan
- 3 Slot for additional Compact Flash memory card
- 4 One 9-way male SUB-D port marked COM1 for serial links
- 5 4 USB 2.0 ports
- 6 Slot for 1 additional PCMCIA card
- 7 2 RJ45 ports for the Ethernet link:
 - 1 x 10/100/1000 Mbps
 - 1 x 10/100 Mbps
- 8 Slot for PCI bus expansion card
- 9 RAS port

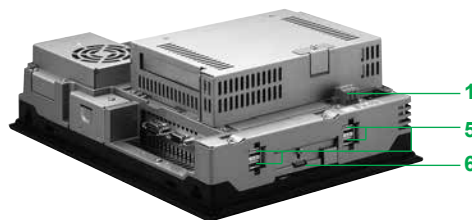

Note: AC versions have an On/Off switch.



Magelis™ Human/Machine Interfaces

Industrial PCs

Magelis Smart iPC

PC Panels



MPC ST2 1NAJ 20T

Magelis Smart iPC PC Panel - 12" screen (1)					
With 2 GB Compact Flash card					
Supply voltage	Processor RAM	Free expansion slots	Vijeo Citect	Reference	Weight kg
24 V $\overline{\text{---}}$	Celeron M 1 GHz 512 MB expandable to 1024 MB	1 PCMCIA	Web client	MPC ST2 1NDJ 20T	3.800
100 to 240 V \sim	Celeron M 1 GHz 512 MB expandable to 1024 MB	1 PCMCIA	Web client	MPC ST2 1NAJ 20T	3.800

Separate components for 12" Magelis Smart iPC				
Description	Specifications	Compatible with (2)	Reference	Weight kg
License Vijeo Designer Run Time	Unlimited	All 12" Smart iPC models	VJD SNR TMPC	–
RAM expansion kit	512 MB	All 12" Smart iPC models	MPC YK0 5RAM 512	–
	1024 MB	All 12" Smart iPC models	MPC YK2 2RA1 024	–
Compact Flash memory cards	2 GB, blank	All 12" Smart iPC models	MPC YN0 0CF2 00N	0.050
	4 GB, blank	All 12" Smart iPC models	MPC YN0 0CF4 00N	0.050
PCMCIA adaptor for Compact Flash card	Enables a 12" Smart iPC panel to receive the second Compact Flash card needed for Vijeo Designer in the PCMCIA slot	All 12" Smart iPC models. All memory cards Compact Flash	XBT ZGADT	0.050
Maintenance kit	Includes panel mounting fixings and seals	All 12" Smart iPC models	MPC YK2 0MNT KIT	–
Screen protection	Protective film	All 12" Smart iPC models	MPC YK2 0SPS KIT	–
Replacement power supply connector	AC connector	All 12" Smart iPC models.	MPC YN0 0PWA CTE	–

Magelis Smart iPC equivalent product table		
Type	Old range	New range
~ 12" Smart iPC	MPC ST2 1NAJ 10R	MPC ST2 1NAJ 20T + VJD SNR TMPC

(1) Magelis Smart iPCs are supplied with a trial version of Vijeo Designer Run Time. Unlimited usage available by activation of license VJD SNR TMPC (see above).

(2) And software package variants when available.

Magelis Compact iPC PC Panel - 12" screen (1)

With 250 GB minimum Hard Disk

Supply voltage	Processor RAM	Free expansion slots	Vijeo Citect	Reference	Weight kg
100 to 240 V ~	Celeron M 1.5 GHz 512 MB expandable to 1024 MB	1 PCI 1 Compact Flash 1 PCMCIA (type II)	–	MPC KT2 2NAX 20N (1)	4.500

With Flash Disk 15 GB minimum

Supply voltage	Processor RAM	Free expansion slots	Vijeo Citect	Reference	Weight kg
100 to 240 V ~	Celeron M 1.5 GHz 512 MB expandable to 1024 MB	1 PCI 1 Compact Flash 1 PCMCIA (type II)	–	MPC KT2 2MAX 20N (1)	4.500



MPC KT2 1●AX 20N

Separate components for 12" Magelis Compact iPC

Description	Specifications	Compatible with (2)	Reference	Weight kg
Vijeo Designer Run Time license	Unlimited	All Compact iPC 12" models	VJD SNR TMPC	–
RAM expansion kit	512 MB	All Compact iPC 12" models	MPC YK0 5RAM 512	–
	1024 MB	All Compact iPC 12" models	MPC YK2 2RA1 024	–
Hard disk	≥ 250 GB	12" Compact iPC PC panel MPC KT2 2●AX 20N	MPC YNK2 SHD 20N	–
Flash Disk SSD	≥ 15 GB	12" Compact iPC PC panel MPC KT2 2●AX 20N	MPC YNK2 MSD 20N	–
Maintenance kits	Includes panel mounting fixings and seals	All Compact iPC 12" models	MPC YK2 0MNT KIT	–
Screen protection	Protective film	All Compact iPC 12" models	MPC YK2 0SPS KIT	–
Replacement power supply connector	AC connector	All Compact iPC 12" models	MPC YN0 0PWA CTE	–

Magelis Compact iPC equivalent product table

Type	Old range	New range
12" Compact iPC	MPC KT2 2NAX 00R	MPC KT2 2NAX 20N + VJD SNR TMPC

(1) Magelis Compact iPC are supplied with a trial version of Vijeo Designer Run Time. Unlimited usage available by activation of license **VJD SNR TMPC** (see above).

(2) And software package variants when available.

Type of Magelis iPC		Magelis Panel PC		
Industrial environments		Optimum range	Universal range	
		Maintenance-free	Maintenance-free	Standard
				
Fanless		★★★★★	★★★★★	★★★★★
Diskless		★★★★★	★★★★★	–
Sizes of color touch screen and front panel bezel material		<input type="checkbox"/> 10.4" Aluminum bezel <input type="checkbox"/> 15" Aluminum or Stainless steel bezel		
CPU (1)		Processor: Intel® ATOM™ Z510 (1.1 GHz) / Intel® ATOM™ N270 (1.6 GHz) PCI slot: 0 / 0 or 2 Storage: Compact Flash card (SLC technology) and integrated SD card reader / Compact Flash card (SLC technology) or Flash disk (SSD) with 5 year warranty (2) / Hard disk RAM: 1 GB / 1 or 2 GB		
Operating system		Windows® Embedded Standard 2009	Windows® Embedded Standard 2009 or Windows® XP Professional SP3	Windows® XP Professional SP3
Supply voltage		Aluminum bezel versions: 24 V $\overline{\text{---}}$ Stainless steel bezel versions: – / 24 V $\overline{\text{---}}$ or 100 to 240 V \sim		
Standards and certifications		<input type="checkbox"/> CE <input type="checkbox"/> cULus <input type="checkbox"/> cULus Haz Loc <input type="checkbox"/> ATEX II 3 Gas and Dust Zone 2/22 (Optimum range 15" Stainless steel bezel version only) and <input type="checkbox"/> ATEX II 3 Dust Zone 22 (Universal range 15" Stainless steel bezel version only) <input type="checkbox"/> EN 1672-2 Food and beverage processing machines and FDA 21CFR 177.206 specific seals (Stainless steel bezel versions only)		
Marine certification		Bridge Class (only 24 V $\overline{\text{---}}$ Magelis Panel PC with 15" or 19" touch screen and Aluminum bezel)		
Software		Vijeo Designer Run Time Demo (21-day trial version). Unlimited license, to be ordered separately (VJDSNRTMPC). Vijeo Citect, depending on the model		
References		Aluminum bezel versions: HMI PWC●●●●● / HMI PVC7 D0E01 Stainless steel bezel versions: HMI PUC●●●●● / HMI PUF●●●●● / HMI PTH7 D2P01		
Pages		3/14	3/18	
Made-to-order configuration		See configured Magelis Panel PC on page 3/31		

(1) For other options available (interface for backup battery, 3rd serial port, etc.) in made-to-order configuration, see pages 3/31 (Magelis Panel PC) and 3/42 (Magelis BOX PC).

(2) For general conditions of manufacturer's 5 year warranty: please consult our Customer Care Center.

(3) See page 3/44.



Magelis Panel PC		Magelis BOX PC		Performance range	
Performance range		Universal range		Performance range	
Harsh	Standard	Maintenance-free	Standard	Harsh	Standard



-		★★★★★		-	
★★★★★		★★★★★		★★★★★	
<input type="checkbox"/> 15" Aluminum or Stainless steel bezel <input type="checkbox"/> 19" Aluminum bezel		Compatible with all screens in the Magelis iDisplay range (3)			
Intel® Core™ 2 Duo P8400 (2.26 GHz) + Intel® GM45 chipset		Intel® ATOM™ N270 (1.6 GHz)		Intel® Core™ 2 Duo P8400 (2.26 GHz) + Intel® GM45 chipset	
0 or 2		1 or 2		2 or 5	
Flash disk (SSD) with 5 year warranty (2)	Hard disk	Compact Flash card (SLC technology) or Flash disk (SSD) with 5 year warranty (2)	Hard disk	Flash disk (SSD) with 5 year warranty (2)	Hard disk
2 or 4 GB		1 or 2 GB		2 or 4 GB	
Windows® 7 Ultimate 64-bit		Windows® Embedded Standard 2009 or Windows® XP Professional SP3	Windows® XP Professional SP3	Windows® 7 Ultimate 64-bit	
24 V $\overline{\text{---}}$ or 100 to 240 V \sim		24 V $\overline{\text{---}}$			
100 to 240 V \sim		-			
<input type="checkbox"/> CE <input type="checkbox"/> cULus <input type="checkbox"/> cULus Haz Loc <input type="checkbox"/> ATEX II 3 Dust Zone 22 (Stainless steel bezel versions only) <input type="checkbox"/> EN 1672-2 Food and beverage processing machines and FDA 21CFR 177.206 specific seals (Stainless steel bezel versions only)		<input type="checkbox"/> CE <input type="checkbox"/> cULus <input type="checkbox"/> cULus Haz Loc <input type="checkbox"/> ATEX II 3 Dust Zone 22			
-		Bridge Class	-		

Vijeo Designer Run Time Demo (21-day trial version). Unlimited license, to be ordered separately (VJDSNRTMPC)
 Vijeo Citect, depending on the model

HMI PPF●●●●●	HMI PPH●●●●●	HMI BUCN●●●●● HMI BUFN●●●●●	HMI BUHN●●●●●	HMI BPDF●●●●●	HMI BPHD●●●●●
-	HMI PRH7 A2701	-	-	-	-
3/18		3/34			
See configured Magelis Panel PC on page 3/31		See configured Magelis BOX PC on page 3/42			





Schneider Electric Magelis iPC

Introduction

The Magelis iPC product offer includes products that are rugged and certified for automation applications. The 15" screen Magelis Panel PC versions with a stainless steel front panel bezel and ATEX certification are particularly recommended for certain specific sectors (food and beverage, chemical, pharmaceutical, gas and petroleum).

This product offer includes:

- Magelis Panel PCs: "All in One" products incorporating an industrial PC and a 10", 15" (1) or 19" color touch screen, available in the following ranges:
 - Optimum: 10" or 15" touch screen (1)
 - Universal: 15" (1) or 19" touch screen
 - Performance: 15" (1) or 19" touch screen
- Magelis BOX PCs: Industrial PCs available in the following ranges:
 - Universal (1 or 2 PCI slots)
 - Performance (2 or 5 PCI slots)

Magelis BOX PCs can be combined with Magelis iDisplay screens (see page 3/44).

The Magelis iPC product offer is suitable for numerous applications and different types of automation environments:

- Maintenance-free environment: Fanless Magelis iPC (unaffected by dust, no filters to clean, etc.) and without any rotating parts such as a hard disk. Data storage on Compact Flash card or on Flash disk offers good resistance to vibration and long life.
- Harsh environment: Diskless Magelis iPC
- Standard environment: Magelis iPC with hard disk offering a high storage capacity

Rugged and certified for automation applications

With their rugged design and construction, Magelis iPC industrial PCs are specifically designed for use in automation applications.

They benefit from the following certifications (2):

- cULus (UL 508, CSA 22.2 no. 142), Industrial Control Equipment
- cULus Haz Loc Class I Div 2 (ANSI/ISA 12.12.01, UL 1604, CSA 22.2 n° 213)
- ATEX II 3 Gas and Dust zone 2/22 in explosive atmospheres (3)
- Germanischer Lloyd (Bridge Class) for marine applications (3)
- C-Tick, GOSTCE

The 15" screen Magelis Panel PCs with stainless steel front panel bezel conform to the food and beverage processing machines standard EN 1672-2. They are fitted with specific seals and conform to the standard FDA 21CFR 177.206.

To simplify maintenance, Magelis iPCs integrate functions for monitoring the internal temperature of both the fans and the hard disk. Magelis iPC Universal and Performance range PCs have options for high availability applications:

- RAID PCI card with 2 redundant hard disks
- Backup battery (requires the battery-backed power supply interface module)

Their resistance to temperature, vibration and shock enables Magelis iPCs to operate continuously in extremely difficult environments.

The durability of these products and the service options available make them well suited for automation applications.

The "book" format and 24 V $\overline{\text{DC}}$ power supply of Magelis BOX PCs means they can be easily installed in control system enclosures.

Advanced design with the Optimum range

The advanced design of Magelis Optimum Panel PC products provides a rugged, maintenance-free product, certified for automation applications, at an attractive price. This product range can be easily integrated into IT systems.

Magelis Optimum Panel PCs feature LCD TFT LED touch screens with 16 million colors and IP65 front panel protection when mounted on a panel or an enclosure door and:

- 10.4" (SVGA 800 x 600) or 15" (XGA 1024 x 768) touch screen (1)
- Fanless Intel® Atom™ Z510 processor (1.1 GHz)
- Integrated SD card reader
- 3 USB ports including 1 on the front panel, 2 gigabit Ethernet ports, 1 communication port
- Windows® Embedded Standard 2009
- 24 V $\overline{\text{DC}}$ power supply

(1) The 15" screens are available with an aluminum or stainless steel front panel bezel.

(2) A regularly updated list of all standards and certifications issued by independent bodies can be found on our website: www.schneider-electric.com.

(3) Depending on the model.



Magelis Panel PC Optimum range with 10.4" or 15" touch screen



Magelis Panel PC Universal and Performance ranges with 15" or 19" touch screen



Magelis BOX PC Universal and Performance ranges 1, 2 or 5 PCI slots

Introduction (continued)

Modular, flexible design with Universal and Performance product ranges

The modular design of Magelis iPCs allows Schneider Electric to provide a line of referenced products with the Universal and Performance ranges. In addition, the flexibility offered by the modular design allows Magelis Panel PCs (see page 3/31) and Magelis BOX PCs (see page 3/42) to be made-to-order.

Configuration of the Universal and Performance product ranges:

- Universal range based on the fanless Intel® Atom™ N270 processor (1.6 GHz)
- Performance range based on the fanless Intel® Core™ 2 Duo P8400 processor (2.26 GHz)
- Compact Flash card (SLC technology) ≥ 4 GB, Flash disk ≥ 60 GB, with 5 year warranty (1) or hard disk ≥ 250 GB, all interchangeable
- 5 USB ports including 1 on the front panel and 2 gigabit Ethernet ports
- Up to 2 DVI ports and 3 communication ports
- DVD-RW drive depending on the model
- Different Microsoft operating systems (see page 3/13)
- Power supply: 24 V $\bar{\text{---}}$ (all models) and 100 to 240 V \sim (Panel PC only)

Magelis Universal and Performance Panel PCs feature LCD TFT LED touch screens with 16 million colors and IP65 front panel protection when mounted on a panel or an enclosure door and:

- 15" (XGA 1024 x 760) (2) or 19" (SXGA 1280 x 1024) touch screen
- Option of having 2 PCI/PCIe slots

Magelis Universal and Performance BOX PC product ranges have 1, 2 or 5 PCI/PCIe slots.

Vijeo Designer and Vijeo Citect bundled software offer

Magelis iPCs are all supplied with the Vijeo Designer Run Time Demo software (21-day trial version). Vijeo Designer (version ≥ 6.1) includes the Pac Drive driver which enables Magelis iPCs to interact directly with motion controllers.

Magelis iPC and Vijeo Citect bundle offers include the DVD with the software and documentation, the USB key with registered user rights and a 1-year support contract. Updates and upgrades are available by providing the key number and are subject to the usual conditions.

As Vijeo Citect applications require a large number of write operations to disk, these bundle offers are based on Magelis iPCs with Flash disk (SSD) to ensure long life and good performance. Vijeo Citect Web Client access is also available with Magelis iPCs that have a Compact Flash disk.

Magelis iPCs enable processing of Vijeo Designer data as they support its "Intelligent Data Service" option (to be installed on Compact Flash disk, minimum 4 GB, and Windows® Embedded Standard 2009 or later).

Magelis iPCs enable maintenance operations in automation environments as they support the "Build Time" configuration versions in Unity and SoMachine programming software. Magelis Performance iPCs (with minimum 2 GB of RAM) are recommended for these configurations.

Integration in IT structures

The 2 built-in Ethernet ports allow the IT and automation data flows to be separated, reinforcing the overall safety of the system. Magelis iPCs run on Microsoft operating systems, allowing:

- Connection of PC peripherals
- Huge data storage capacity
- Ease of connection to computers and databases
- Simultaneous operation of several programs:
 - Vijeo Designer Human/Machine Interface and data traceability with Intelligent Data Service
 - Vijeo Citect SCADA supervisor
 - Office software including web browsers
 - Other software installed by the user

Depending on the model, these operating systems may be:

- Windows® Embedded Standard 2009, write-protected in normal operating mode so as to avoid any unintended operation
- Windows® XP Professional SP3
- Windows® 7 Ultimate 64-bit supporting more than 3 GB of RAM (recommended for SCADA supervisor applications which need significant memory capacity)
- Windows® Embedded 7 and Windows® 7 Ultimate 32-bit which are also available in made-to-order configurations (see pages 3/31 and 3/42).

(1) For general conditions of manufacturer's 5 year warranty: please consult our Customer Care Center.

(2) The 15" screens are available with an aluminum or stainless steel front panel bezel.

Industrial PCs

Magelis iPCs certified for automation

Magelis Panel PC – Optimum range

10.4" or 15" touch screen

Type		Optimum range - 10.4" touch screen
Industrial environments		Maintenance-free (with Aluminum front panel bezel)
Fanless		★★★★★
Diskless		★★★★★
Screen	Type	10.4" LCD TFT LED touch screen
	Definition	SVGA 800 x 600, 16 million colors
	Degree of protection	IP65 front panel protection when mounted on panel or enclosure door
	Front panel bezel material	Aluminum
CPU	Processor	Intel® ATOM™ Z510 (1.1 GHz)
	Storage	Operating system: Compact Flash card ≥ 2 GB (SLC technology) User: integrated SD card reader
	RAM (1)	1 GB
	Integrated ports	2 x Ethernet 10/100/1000 Mbps
		1 x USB 2.0 (1 A) on the front panel + 2 x USB 2.0 (1 A) on the underside 1 x RS232C
Operating system		Windows® Embedded Standard 2009
Supply voltage	Voltage	24 V ~ (± 25%)
	Current	Nominal current 1.9 A. Typical inrush current 3 A, 50 A < 300 µs
Overall dimensions (W x H x D)/Cut-out (W x H)		323 x 260 x 72 mm/Cut-out: 303 x 243 mm
Temperature	During operation	0 to 50°C, conforming to IEC 61132-2, UL 508
Vibration resistance during operation	Continuous	1.75 mm amplitude from 2 to 9 Hz, 0.5 g from 9 to 200 Hz (2)
	Non-continuous	3.5 mm amplitude from 2 to 9 Hz, 1 g from 9 to 200 Hz (2)
	Merchant navy IACS E10	–
Shock resistance	during operation	15 g/11 ms conforming to IEC 60068-2-27 test Ea
Standards and certifications		CE, cULus (UL 508, CSA 22.2 n°142), cULus Haz Loc Class I Div 2 (ANSI/ISA 12.12.01, UL 1604, CSA 22.2 n°213), C-Tick, GOST
Marine certification	Germanischer Lloyd (Bridge Class)	–
ATEX certification		–
Software		Acrobat Reader, Word/Excel/Power Point Viewer, Framework.Net 3.5, Web browser Vijeo Designer Run Time Demo 21-day trial version (3) Vijeo Citect Web Client
References of Aluminum bezel versions	With Vijeo Designer Run Time Demo, 21-day version (3)	HMI PWC5 D0E01
References of Stainless steel bezel versions	With Vijeo Designer Run Time Demo, 21-day version (3)	–
Pages		3/17
Made-to-order configuration		See configured Magelis Panel PC on page 3/31



(1) Memory capacity not user-expandable; increased capacity available in made-to-order configuration (see page 3/31).

(2) Conforming to IEC 60068-2-6 Fc.

(3) Unlimited license, to be ordered separately (VJDSNRTMPC).

Optimum range - 15" touch screen

Maintenance-free (with Aluminum or Stainless steel front panel bezel)



★★★★★
★★★★★

15" LCD TFT LED touch screen
XGA 1024 x 768, 16 million colors
IP65 front panel protection when mounted on panel or enclosure door
Aluminum or Stainless steel

Intel® ATOM™ Z510 (1.1 GHz)
Operating system: Compact Flash card ≥ 2 GB (SLC technology)
User: integrated SD card reader
1 GB
2 x Ethernet 10/100/1000 Mbps
1 x USB 2.0 (1 A) on the front panel + 2 x USB 2.0 (1 A) at the bottom
1 x RS232C

Windows® Embedded Standard 2009

24 V \pm 25 %
Nominal current 1.9 A. Typical inrush current 3 A, 50 A < 300 μ s

402 x 301 x 72 mm/Cut-out: 383.5 x 282.5 mm

0 to 50°C, conforming to IEC 61132-2, UL 508

1.75 mm amplitude from 2 to 9 Hz, 0.5 g from 9 to 200 Hz (2)
3.5 mm amplitude from 2 to 9 Hz, 1 g from 9 to 200 Hz (2)
1 mm from 3 to 13.2 Hz, 0.7 g from 13.2 to 100 Hz, 90 minutes endurance
15 g/11 ms conforming to IEC 60068-2-27 test Ea

CE, cULus (UL 508, CSA 22.2 n°142), cULus Haz Loc Class I Div 2 (ANSI/ISA 12.12.01, UL 1604, CSA 22.2 n°213), C-Tick, GOST
 EN 1672-2 Food and beverage processing machines and FDA 21CFR 177.206 specific seals (Stainless steel bezel versions only)
With power supply filter HMI YLFI MAR11 (Aluminum bezel versions only)

ATEX II 3 Gas and Dust zone 22 (Stainless steel bezel versions only)

Acrobat Reader, Word/Excel/Power Point Viewer, Framework.Net 3.5, Web browser
Vijeo Designer Run Time Demo 21-day trial version (3)
Vijeo Citect Web Client

HMI PWC7 D0E01

HMI PVC7 D0E01

3/17

See configured Magelis Panel PC on page 3/31



10.4" and 15" Magelis PC Panel

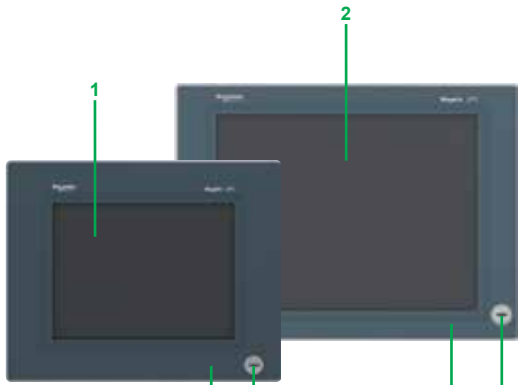

10.4" and 15" front panels Aluminum



15" Stainless steel front panel

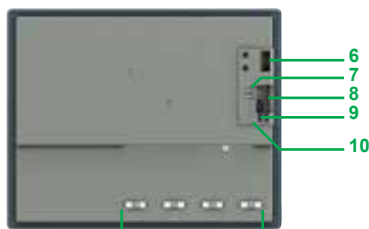

Rear panel

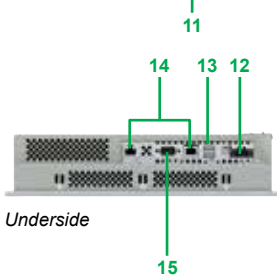

Underside

Introduction

The Magelis Panel PC Optimum range features products that are rugged and certified for automation applications. These products, well-designed and at an attractive price, also feature compact dimensions, particularly in terms of depth. They can be easily integrated into IT systems.

This Magelis Panel PC Optimum range is specifically designed for use in maintenance-free environments. Versions are available with a stainless steel front panel bezel.

Overview of the Optimum range

Magelis Panel PC Optimum range

The Magelis Panel PC Optimum range is equipped with a fanless Intel® ATOM™ Z510 processor (1.1 GHz) and DDR2 RAM (1).

Available with 10.4" or 15" LCD TFT LED touch screen with 16 million colors, this range is specifically designed for maintenance-free environments (fanless, with a solid-state storage disk):

- HMI PWC5 D0E01 and HMI PWC7 D0E01:
 - IP65 front panel protection when mounted on a panel or enclosure door
 - Compact Flash card (operating system)/integrated SD card reader (user data)/Windows® Embedded Standard 2009/24 V --- power supply, etc.

Made-to-order Magelis Panel PC Optimum range

On Magelis Optimum Panel PC bases, it is possible to customize the CPU by selecting the capacity of the RAM and the Compact Flash card. For this HMI PCCW offer see (page 3/31).

Description

10.4" (aluminum bezel) and 15" (aluminum or stainless steel bezel) Magelis Optimum Panel PC

Front panels

- 1 10.4" LCD TFT LED touch screen (SVGA 800 x 600) with 16 million colors for HMI PCW5 D0E01:
 - Brightness: 450 cd/m² (adjustable)
 - Type of touch panel: Analog resistive film, resolution 4096 x 4096
 - Typical viewing angle: 120° (vertically)/160° (horizontally)
 - 2 15" LCD TFT LED touch screen (XGA 1024 x 768) with 16 million colors for HMI PCW7 D0E01:
 - Brightness: 350 cd/m² (adjustable)
 - Type of touch panel: Analog resistive film, resolution 4096 x 4096
 - Typical viewing angle: 100° (vertically)/160° (horizontally)
 - 3 Aluminum alloy front panel providing IP65 front panel protection when mounted on a panel or enclosure door; mounted on 1.6 to 10 mm thick support using screw fasteners supplied (2)
- or
- 4 Stainless steel 304 "Scotch Brite®" brushed finish front panel enabling an IP65 degree of protection of the front panel when mounted on a panel or an enclosure door. Mounting on 1.6 to 10 mm thick support using stainless steel screw fasteners supplied (2). Cleaning simplified due to absence of USB port on front panel (conforms to food and beverage processing machines standard EN 1672-2). Version fitted with specific seals (standard FDA 21 CFR 177.206)
 - 5 USB 2.0 port (1 A max.) with screw-on protective cover (only available for Aluminum version); captive protective cover option also available (3)

Common rear panel

- 6 Battery
- 7 2 push buttons: 1 for the power supply and 1 for resetting
- 8 Compact Flash card (SLC technology) ≥ 2 GB specifically for the operating system
- 9 SD card reader for user data - SD card optional (3)
- 10 4 status and power supply LEDs
- 11 Cable clamps

Common underside

- 12 24 V ---/1.9 A power supply connector
- 13 2 USB 2.0 ports (1 A max.)
- 14 2 Ethernet 10/100/1000 Mbps ports
- 15 RS232C port

(1) Not user-expandable; increased capacity available in made-to-order configuration (see page 3/31).
 (2) For installation, please refer to the "product data sheet" on our website www.schneider-electric.com.
 (3) To be ordered separately (see page 3/30).



HMI PWC5 D0E01
(screen side)



HMI PWC7 D0E01
(screen side)



HMI PWC D0E01
(CPU side)

**Magelis Optimum Panel PC - 10.4" or 15" LCD TFT LED touch screen (1)
(Intel® ATOM™ Z510 processor (1.1 GHz)/DDR2 RAM/24 V ~ supply voltage) (2)**

Screen type	Operating system	Software	Storage	DDR2 RAM (3)	Reference	Weight kg
-------------	------------------	----------	---------	--------------	-----------	-----------

For maintenance-free environment (with Aluminum front panel bezel)

10.4" LCD TFT LED touch screen SVGA 800 x 600, 16 million colors IP65 front panel protection when mounted on a panel or enclosure door	Windows® Embedded Standard 2009 (4)	Vijeo Designer RT Demo (5)	Operating system: Compact Flash ≥ 2GB User: 1 SD memory card reader (card available separately)	1 GB	HMI PWC5 D0E01	4.400
--	-------------------------------------	----------------------------	---	------	-----------------------	-------

15" LCD TFT LED touch screen XGA 1024 x 768, 16 million colors IP65 front panel protection when mounted on a panel or enclosure door	Windows® Embedded Standard 2009 (4)	Vijeo Designer RT Demo (5)	Operating system: Compact Flash ≥ 2GB User: 1 SD memory card reader (card available separately)	1 GB	HMI PWC7 D0E01	6.100
--	-------------------------------------	----------------------------	---	------	-----------------------	-------

For maintenance-free environment (with Stainless steel front panel bezel)

15" LCD TFT LED touch screen XGA 1024 x 768, 16 million colors IP65 front panel protection when mounted on a panel or enclosure door	Windows® Embedded Standard 2009 (4)	Vijeo Designer RT Demo (5)	Operating system: Compact Flash ≥ 2GB User: 1 SD memory card reader (card available separately)	1 GB	HMI PVC7 D0E01	6.300
--	-------------------------------------	----------------------------	---	------	-----------------------	-------

(1) For separate components, software and external power supply see page 3/30.

(2) For an ~ supply voltage, an external Phaseo power supply can be used (see page 3/30).

(3) Memory capacity not user-expandable; increased capacity available in made-to-order configuration (see page 3/31).

(4) Windows® Embedded Standard 2009 supplied in 9 languages (English, French, German, Italian, Portuguese, Spanish, Swedish, Chinese, Russian). Also includes:

- Acrobat Reader, Word/Excel/Power Point Viewer
- Framework.Net 3.5
- Web browser
- Vijeo Citect Web Client
- Vijeo Designer Run Time Demo (5)

(5) Vijeo Designer RT (Run Time) Demo (21-day trial version). Unlimited license, to be ordered separately (VJDSNRTMPC) (see page 3/30).



Industrial PCs

Magelis iPCs certified for automation

Magelis Panel PC – Universal and Performance ranges
15" touch screen

3

Type	Universal range - 15" touch screen (no PCI slot)	Standard (with Aluminum bezel)
Industrial environments	Maintenance-free (with Aluminum bezel)	



Fanless	★★★★★	★★★★★	★★★★★
Diskless	★★★★★	★★★★★	–

Screen	Type	15" LCD TFT LED touch screen
	Definition	XGA 1024 x 768, 16 million colors
	Degree of protection	IP65 front panel protection when mounted on panel or enclosure door
	Front panel bezel material	Aluminum

CPU (1)	Processor	Intel® ATOM™ N270 (1.6 GHz)		
	PCI slot	–		
	Storage	Compact Flash card ≥ 4 GB (SLC technology)	Flash disk ≥ 60 GB with 5 year warranty (3)	Hard disk ≥ 250 GB
	RAM (2)	1 GB	HMI PUF7 ●0P01: 1 GB HMI PUF7 D0PL1: 2 GB	1GB
	Integrated DVD-RW drive	–		
	Slide-in rack for peripheral device	1 x slide-in compact rack for storage disk		
	Integrated ports	2 x Ethernet 10/100/1000 Mbps 1 x USB 2.0 (1 A) on the front panel + 4 x USB 2.0 (0.5 and 1 A) at the top 2 x RS232C/1 x DVI (VGA RGB adaptor, optional) 1 x RS232C/RS422/RS485 (option only available in made-to-order configuration) (1)		
	Optional ports	–		
	Optional RAID PCI card	–		

Operating system	Windows® Embedded Standard 2009	Windows® XP Professional SP3
-------------------------	---------------------------------	------------------------------

Overall dimensions (W x H x D)/Cut-out (W x H)	402 x 301 x 104 mm/Cut-out: 383.5 x 282.5 mm
---	--

Temperature	During operation	0 to 50°C, conforming to IEC 61132-2, UL 508
--------------------	------------------	--

Vibration resistance	Continuous	1.75 mm amplitude from 2 to 9 Hz, 0.5 g from 9 to 200 Hz (conforming to IEC 60068-2-6 Fc)	0.125 g from 5 to 100 Hz
	Non-continuous	3.5 mm amplitude from 2 to 9 Hz, 1 g from 9 to 200 Hz (conforming to IEC 60068-2-6 Fc)	0.250 g from 5 to 100 Hz
	Merchant navy IACS E10	1 mm amplitude from 3 to 13.2 Hz, 0.7 g from 13.2 to 100 Hz, 90 minutes endurance	–

Shock resistance	During operation	15 g/11 ms conforming to IEC 60068-2-27 test Ea
-------------------------	------------------	---

Standards and certifications	CE, cULus (UL 508, CSA 22.2 n°142), cULus Haz Loc Class I Div 2 (ANSI/ISA 12.12.01, UL 1604, CSA 22.2 n°213), C-Tick, GOST
-------------------------------------	--

Marine certif.	Germanischer Lloyd (Bridge Class)	24 V --- equipped with a power supply filter HMI YLFI MAR11	–
-----------------------	-----------------------------------	---	---

ATEX certification	–
---------------------------	---

Software	Vijeo Designer Run Time Demo	21-day trial version. Unlimited license, to be ordered separately (VJD SNRTMPC)
-----------------	------------------------------	---

References of Aluminum bezel versions (1)	24 V ---	HMI PUC7 D0E01	HMI PUF7 D0P01	HMI PUH7 D0P01
	24 V --- Vijeo Citect Lite 1200 I/O	–	HMI PUF7 D0PL1	–
	24 V --- Interface for battery	–	–	–
	24 V --- Vijeo Citect Full 500 I/O	–	–	–
	100 to 240 V ~ Vijeo Citect Full 500 I/O	–	HMI PUF7 A0P01	HMI PUH7 A0P01
References of Stainless steel bezel versions (1)	24 V ---	–	–	–
	100 to 240 V ~	–	–	–

Pages	3/26
--------------	------

Made-to-order configuration	See configured Magelis Panel PC on page 3/31
------------------------------------	--

(1) Other options available (interface for backup battery, 3rd serial port, etc.) in made-to-order configuration (see page 3/31).

(2) Memory capacity not user-expandable; increased capacity available in made-to-order configuration (see page 3/31).

Universal range (2 PCI slots)		Performance range (no PCI slot)		Performance range (2 PCI slots)	
Maintenance-free (with Aluminum or Stainless steel bezel)	Standard (with Aluminum or Stainless steel bezel)	Harsh (with Aluminum bezel)	Standard (with Aluminum bezel)	Harsh (with Aluminum bezel)	Standard (with Aluminum or Stainless steel bezel)



★★★★★	★★★★★	–	–	–	–
★★★★★	–	★★★★★	–	★★★★★	–

15" LCD TFT LED touch screen					
XGA 1024 x 768, 16 million colors					
IP65 front panel protection when mounted on panel or enclosure door					
Aluminum or Stainless steel		Aluminum		Aluminum or Stainless steel	

Intel® ATOM™ N270 (1.6 GHz)		Intel® Core™ 2 Duo P8400 (2.26 GHz) + Intel® GM45 chipset			
2 (1 PCI + 1 PCI Express®)		–		2 (1 PCI + 1 PCI Express®)	
Flash disk ≥ 60 GB with 5 year warranty (3)	Hard disk ≥ 250 GB	Flash disk ≥ 60 GB with 5 year warranty (3)	Hard disk ≥ 250 GB	Flash disk ≥ 60 GB with 5 year warranty (3)	Hard disk ≥ 250 GB
HMI P●F7 A2P01: 1 GB HMI PUF7 A2PF1: 2 GB	1 GB	HMI PPF7 D0701: 2 GB HMI PPF7 D07F1: 4 GB	2 GB	HMI P●F7 A2701: 2 GB HMI PPF7 A27F1: 4 GB	2 GB
1		–		1	
1 x slide-in compact rack for storage disk (Flash disk or hard disk included) 1 x slide-in rack for DVD-RW drive (included) or storage disk via adaptor (optional)		1 x slide-in compact rack for storage disk		1 x slide-in compact rack for storage disk (Flash disk or hard disk included) 1 x slide-in rack for DVD-RW drive (included) or storage disk via adaptor (optional)	
2 x Ethernet 10/100/1000 Mbps					
1 x USB 2.0 (1 A) on the front panel (only for aluminum bezel version) + 4 x USB 2.0 (0.5 and 1 A) at the top (for all models)					
2 x RS232C/1 x DVI (VGA RGB adaptor, optional)					
1 x RS232C/RS422/RS485 (option only available in made-to-order configuration) (1)					
RAID PCI card with 2 redundant hard disks		–		RAID PCI card with 2 redundant hard disks	

Windows® XP Professional SP3		Windows® 7 Ultimate 64-bit			
402 x 301 x 153 mm/Cut-out: 383.5 x 282.5 mm		402 x 301 x 119 mm/Cut-out: 383.5 x 282.5 mm		402 x 301 x 168 mm/Cut-out: 383.5 x 282.5 mm	

0 to 50°C, conforming to IEC 61132-2, UL 508					
1.75 mm from 2 to 9 Hz, 0.5 g from 9 to 200 Hz (4)	0.125 g from 5 to 100 Hz	1.75 mm from 2 to 9 Hz, 0.5 g from 9 to 200 Hz (4)	0.125 g from 5 to 100 Hz	1.75 mm from 2 to 9 Hz, 0.5 g from 9 to 200 Hz (4)	0.125 g from 5 to 100 Hz
3.5 mm from 2 to 9 Hz, 1 g from 9 to 200 Hz (4)	0.250 g from 5 to 100 Hz	3.5 mm from 2 to 9 Hz, 1 g from 9 to 200 Hz (4)	0.250 g from 5 to 100 Hz	3.5 mm from 2 to 9 Hz, 1 g from 9 to 200 Hz (4)	0.250 g from 5 to 100 Hz

–					
15 g/11 ms conforming to IEC 60068-2-27 test Ea					

- CE, cULus (UL 508, CSA 22.2 n°142), cULus Haz Loc Class I Div 2 (ANSI/ISA 12.12.01, UL 1604, CSA 22.2 n°213), C-Tick, GOST
- EN 1672-2 Food and beverage processing machines and FDA 21CFR 177.206 specific seals (Stainless steel bezel versions only)

ATEX II 3 Gas and Dust zone 22 (Stainless steel bezel versions only)

21-day trial version. Unlimited license, to be ordered separately (VJD SNRTMPC)

–	HMI PUH7 D2P01	HMI PPF7 D0701	HMI PPH7 D0701	–	HMI PPH7 D2701
–	–	–	–	–	–
–	–	–	–	–	HMI PPH7 B2701
–	–	HMI PPF7 D07F1	–	–	–
HMI PUF7 A2P01	HMI PUH7 A2P01	–	HMI PPH7 A0701	HMI PPF7 A2701	HMI PPH7 A2701
HMI PUF7 A2PF1	–	–	–	HMI PPF7 A27F1	–
HMI PTF7 D2P01	HMI PTH7 D2P01	–	–	–	–
–	–	–	–	–	HMI PRH7 A2701

3/26	3/27
See configured Magelis Panel PC on page 3/31	

(3) For general conditions of manufacturer's 5 year warranty: please consult our Customer Care Center.
 (4) Conforming to IEC 60068-2-6 Fc.

Industrial PCs

Magelis iPCs certified for automation

Magelis Panel PC – Universal and Performance ranges
19" touch screen

Type	Universal range - 19" touch screen (no PCI slot)	
Industrial environments	Maintenance-free (with Aluminum bezel)	Standard (with Aluminum bezel)



Fanless	★★★★★	★★★★★	★★★★★															
Diskless	★★★★★	★★★★★	–															
Screen	Type Resolution Degree of protection Front panel bezel material																	
CPU (1)	Processor PCI slot Storage RAM (2) Integrated DVD-RW drive Slide-in rack for peripheral device Integrated ports Optional ports (1) Optional RAID PCI card																	
Operating system	Intel® ATOM™ N270 (1.6 GHz) – Compact Flash card ≥ 4 GB (SLC technology) Flash disk ≥ 60 GB with 5 year warranty (3) Hard disk ≥ 250 GB 1 GB HMI PUF9 D0P01: 1 GB HMI PUF9 D0PF1: 2 GB 1 GB – 1 x slide-in compact rack for storage disk																	
Overall dimensions (W x H x D)/Cut-out (W x H)	2 x Ethernet 10/100/1000 Mbps 1 x USB 2.0 (1 A) on the front panel + 4 x USB 2.0 (0.5 and 1 A) at the top 2 x RS232C/1 x DVI (VGA RGB adaptor, optional) 1 x RS232C/RS422/RS485 (option only available in made-to-order configuration) (1) – Windows® Embedded Standard 2009 Windows® XP Professional SP3																	
Temperature	During operation 0 to 50°C, conforming to IEC 61132-2, UL 508																	
Vibration resistance during operation	Continuous 1.75 mm amplitude from 2 to 9 Hz, 0.5 g from 9 to 200 Hz (3) 0.125 g from 5 to 100 Hz Non-continuous 3.5 mm amplitude from 2 to 9 Hz, 1 g from 9 to 200 Hz (3) 0.250 g from 5 to 100 Hz Merchant navy IACS E10 1 mm amplitude from 3 to 13.2 Hz, 0.7 g from 13.2 to 100 Hz, 90 minutes endurance – Shock resistance During operation 15 g/11 ms conforming to IEC 60068-2-27 test Ea																	
Standards and certifications	CE, cULus (UL 508, CSA 22.2 n°142), cULus Haz Loc Class I Div 2 (ANSI/ISA 12.12.01, UL 1604, CSA 22.2 n°213), C-Tick, GOST																	
Marine certification	Germanischer Lloyd (Bridge Class) 24 V ⎓ Magelis Panel PC equipped with a power supply filter HMI YLFI MAR11 –																	
Software	Vijeo Designer Run Time Demo 21-day trial version. Unlimited license, to be ordered separately (VJDSNRTMPC)																	
References (1)	<table border="1"> <thead> <tr> <th>HMI PUC9 D0E01</th> <th>HMI PUF9 D0P01</th> <th>HMI PUH9 D0P01</th> </tr> </thead> <tbody> <tr> <td>–</td> <td>–</td> <td>–</td> </tr> <tr> <td>–</td> <td>HMI PUF9 D0PF1</td> <td>–</td> </tr> <tr> <td>–</td> <td>–</td> <td>HMI PUH9 A0P01</td> </tr> <tr> <td>–</td> <td>–</td> <td>–</td> </tr> </tbody> </table>			HMI PUC9 D0E01	HMI PUF9 D0P01	HMI PUH9 D0P01	–	–	–	–	HMI PUF9 D0PF1	–	–	–	HMI PUH9 A0P01	–	–	–
HMI PUC9 D0E01	HMI PUF9 D0P01	HMI PUH9 D0P01																
–	–	–																
–	HMI PUF9 D0PF1	–																
–	–	HMI PUH9 A0P01																
–	–	–																
Pages	3/28																	
Made-to-order configuration	See configured Magelis Panel PC on page 3/31																	

(1) Other options available (interface for backup battery, 3rd serial port, etc.) in made-to-order configuration (see page 3/31).

(2) Memory capacity not user-expandable; increased capacity available in made-to-order configuration (see page 3/31).



Universal range - 19" touch screen (2 PCI slots)		Performance range - 19" touch screen (no PCI slot)		Performance range - 19" touch screen (2 PCI slots)	
Maintenance-free (with Aluminum bezel)	Standard (with Aluminum bezel)	Harsh (with Aluminum bezel)	Standard (with Aluminum bezel)	Harsh (with Aluminum bezel)	Standard (with Aluminum bezel)



★★★★★	★★★★★	–	–	–	–
★★★★★	–	★★★★★	–	★★★★★	–

19" LCD TFT LED touch screen
 SXGA 1280 x 1024, 16 million colors
 IP65 front panel protection when mounted on panel or enclosure door
 Aluminum

Intel® ATOM™ N270 (1.6 GHz)		Intel® Core™ 2 Duo P8400 (2.26 GHz) + Intel® GM45 chipset			
2 (1 PCI + 1 PCI Express®)		–		2 (1 PCI + 1 PCI Express®)	
Flash disk ≥ 60 GB with 5 year warranty (3)	Hard disk ≥ 250 GB	Flash disk ≥ 60 GB with 5 year warranty (3)	Hard disk ≥ 250 GB	Flash disk ≥ 60 GB with 5 year warranty (3)	Hard disk ≥ 250 GB
HMI PUF9 A2P01: 1 GB HMI PUF9 A2PF1: 2 GB	1 GB	HMI PPF9 D0701: 2 GB HMI PPF9 D07F1: 4 GB	2 GB	HMI PPF9 A2701: 2 GB HMI PPF9 A27F1: 4 GB	2 GB
1		–		1	
1 x slide-in compact rack for storage disk (Flash disk or hard disk included) 1 x slide-in rack for DVD-RW drive (included) or storage disk via adaptor (optional)		1 x slide-in compact rack for storage disk		1 x slide-in compact rack for storage disk (Flash disk or hard disk included) 1 x slide-in rack for DVD-RW drive (included) or storage disk via adaptor (optional)	
2 x Ethernet 10/100/1000 Mbps					
1 x USB 2.0 (1 A) on the front panel + 4 x USB 2.0 (0.5 and 1 A) at the top					
2 x RS232C/1 x DVI (VGA RGB adaptor, optional)					
1 x RS232C/RS422/RS485 (option only available in made-to-order configuration) (1)					
RAID PCI card with 2 redundant hard disks		–		RAID PCI card with 2 redundant hard disks	
Windows® XP Professional SP3		Windows® 7 Ultimate 64-bit			
480 x 380 x 153 mm/Cut-out: 459.5 x 359.5 mm		480 x 380 x 129 mm/Cut-out: 459.5 x 359.5 mm		480 x 380 x 168 mm/Cut-out: 459.5 x 359.5 mm	

0 to 50°C, conforming to IEC 61132-2, UL 508					
1.75 mm from 2 to 9 Hz, 0.5 g from 9 to 200 Hz (4)	0.125 g from 5 to 100 Hz	1.75 mm from 2 to 9 Hz, 0.5 g from 9 to 200 Hz (4)	0.125 g from 5 to 100 Hz	1.75 mm from 2 to 9 Hz, 0.5 g from 9 to 200 Hz (4)	0.125 g from 5 to 100 Hz
3.5 mm from 2 to 9 Hz, 1 g from 9 to 200 Hz (4)	0.250 g from 5 to 100 Hz	3.5 mm from 2 to 9 Hz, 1 g from 9 to 200 Hz (4)	0.250 g from 5 to 100 Hz	3.5 mm from 2 to 9 Hz, 1 g from 9 to 200 Hz (4)	0.250 g from 5 to 100 Hz

–
 15 g/11 ms conforming to IEC 60068-2-27 test Ea
 CE, cULus (UL 508, CSA 22.2 n°142), cULus Haz Loc Class I Div 2 (ANSI/ISA 12.12.01, UL 1604, CSA 22.2 n°213), C-Tick, GOST
 –

21-day trial version. Unlimited license, to be ordered separately (VJDSNRTMPC)

–	HMI PUH9 D2P01	HMI PPF9 D0701	HMI PPH9 D0701	–	HMI PPH9 D2701
–	–	–	–	–	–
–	–	HMI PPF9 D07F1	–	–	–
HMI PUF9 A2P01	HMI PUH9 A2P01	–	HMI PPH9 A0701	HMI PPF9 A2701	HMI PPH9 A2701
HMI PUF9 A2PF1	–	–	–	HMI PPF9 A27F1	–

3/28 3/29

See configured Magelis Panel PC on page 3/31

(3) For general conditions of manufacturer's 5 year warranty: please consult our Customer Care Center.
 (4) Conforming to IEC 60068-2-6 Fc.



Magelis Panel PC 15" and 19"

3

Introduction

The Magelis Panel PC Universal and Performance ranges offer products that are rugged and certified for automation applications.

Both ranges, available with 15" or 19" screen, are suitable for different types of use:

- In a maintenance-free environment
- In a harsh environment
- In a standard environment

The 15" screen Magelis Panel PC versions with a stainless steel front panel bezel and ATEX certification are particularly recommended for certain targeted sectors (food and beverage, chemical, pharmaceutical, gas and petroleum, etc.).

The modular design of the Panel PCs allows Schneider Electric to provide a comprehensive line of referenced products with the Universal and Performance ranges. In addition to the referenced offer, the flexibility offered by the modular design allows Magelis Panel PCs to be made-to-order (see page 3/31).

Overview of the range

Magelis Panel PC Universal range (1) (2)

The Magelis Universal Panel PC is equipped with a fanless Intel® ATOM™ N270 processor (1.6 GHz) and DDR2 RAM (3).

Featuring a 15" or 19" LCD TFT LED 16 million color touch screen and IP65 front panel protection when mounted on a panel or enclosure door, this product is designed for the following environments:

- Maintenance-free (fanless, with solid-state storage disk):
 - HMI PUC7 D0E01 and HMI PUC9 D0E01:
 - No PCI slot
 - Compact Flash card/Windows® Embedded Standard 2009
 - 24 V $\overline{\text{---}}$ power supply
 - HMI PUF7 D0P01, HMI PUF7 D0PL1, HMI PUF7 A0P01, HMI PUF9 D0P01 and HMI PUF9 D0PF1:
 - No PCI slot
 - Flash disk/Windows® XP Professional SP3
 - 24 V $\overline{\text{---}}$ or 100 to 240 V \sim power supply
 - HMI PUF7 A2P01, HMI PUF7 A2PF1, HMI PUF9 A2P01 and HMI PUF9 A2PF1:
 - 1 PCI + 1 PCI Express®,
 - Flash disk/Windows® XP Professional SP3
 - 100 to 240 V \sim power supply
- Maintenance-free (fanless, with solid-state storage disk) and with Stainless steel front panel bezel:
 - HMI PTF7 D2P01:
 - 1 PCI + 1 PCI Express®,
 - Flash disk/Windows® XP Professional SP3
 - 24 V $\overline{\text{---}}$ power supply
- Standard industrial environments (with hard disk):
 - HMI PUH7 D0P01, HMI PUH7 A0P01, HMI PUH9 D0P01 and HMI PUH9 A0P01:
 - No PCI slot
 - Hard disk/Windows® XP Professional SP3
 - 24 V $\overline{\text{---}}$ or 100 to 240 V \sim power supply
 - HMI PUH7 D2P01, HMI PUH7 A2P01, HMI PUH9 D2P01 and HMI PUH9 A2P01:
 - 1 PCI + 1 PCI Express®,
 - Hard disk/Windows® XP Professional SP3
 - 24 V $\overline{\text{---}}$ or 100 to 240 V \sim power supply
- Standard industrial environments (with hard disk) and with Stainless steel front panel bezel:
 - HMI PTH7 D2P01:
 - 1 PCI + 1 PCI Express®,
 - Flash disk/Windows® XP Professional SP3
 - 24 V $\overline{\text{---}}$ power supply

(1) Types of PCI slot: Half-format PCI 2.2 and half-format PCI Express® 4x.

(2) For description, see pages 3/24 and 3/25.

(3) Not user-expandable; increased capacity available in made-to-order configuration (see page 3/31).

Introduction (continued)**Overview of the range (continued)****Magelis Panel PC Performance range (1) (2)**

The Magelis Panel PC Performance range is equipped with the Intel® Core™ 2 Duo P8400 processor (2.26 GHz) + Intel® GM45 chipset and DDR3 RAM (3).

Featuring a 15" or 19" LCD TFT LED 16 million color touch screen and IP65 front panel protection when mounted on a panel or enclosure door, this product is designed for the following environments:

- Harsh industrial environments (with solid-state storage disk):
 - HMI PPF7 D0701, HMI PPF7 D07F1, HMI PPF9 D0701 and HMI PPF9 D07F1:
 - No PCI slot
 - Flash disk/Windows® 7 Ultimate 64-bit
 - 24 V $\overline{\text{DC}}$ power supply
 - HMI PPF7 A2701, HMI PPF7 A27F1, HMI PPF9 A2701 and HMI PPF9 A27F1:
 - 1 PCI + 1 PCI Express®,
 - Flash disk/Windows® 7 Ultimate 64-bit
 - 100 to 240 V \sim power supply
- Standard industrial environments (with hard disk):
 - HMI PPH7 D0701, HMI PPH7 A0701, HMI PPH9 D0701 and HMI PPH9 A0701:
 - No PCI slot
 - Hard disk/Windows® 7 Ultimate 64-bit
 - 24 V $\overline{\text{DC}}$ or 100 to 240 V \sim power supply
 - HMI PPH7 D2701, HMI PPH7 B2701 (4), HMI PPH7 A2701, HMI PPH9 D2701 and HMI PPH9 A2701:
 - 1 PCI + 1 PCI Express®,
 - Hard disk/Windows® 7 Ultimate 64-bit
 - 24 V $\overline{\text{DC}}$ or 100 to 240 V \sim power supply
- Harsh industrial environments (with solid-state storage disk) and with Stainless steel front panel bezel:
 - HMI PRH7 A2701:
 - 1 PCI + PCI Express®
 - Hard disk/Windows® 7 Ultimate 64-bit
 - 100 to 240 V \sim power supply

Made-to-order Magelis Panel PC Universal and Performance ranges

On Magelis Universal and Performance Panel PC bases, it is possible to customize the CPU by selecting:

- Capacity of the Compact Flash card and the RAM
- Number of PCI and PCI Express® slots
- Operating system and dedicated HMI software
- Additional assembled options: PCI RAID card with 2 redundant hard disks (5), interface for backup battery, interface for battery-backed power supply module, third RS 485 port, etc.

For this HMIPCC offer see page 3/31.

(1) Types of PCI slot: Half-format PCI 2.2 and half-format PCI Express® 4x.

(2) For description, see pages 3/24 and 3/25.

(3) Not user-expandable; increased capacity available in made-to-order configuration (see page 3/31).

(4) Supplied with battery-backed interface module inserted.

(5) Operating temperature details available on our website www.schneider-electric.com.

3

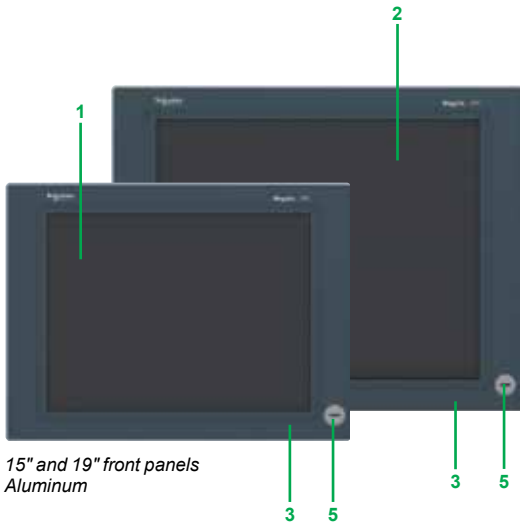

15" and 19" front panels
Aluminum

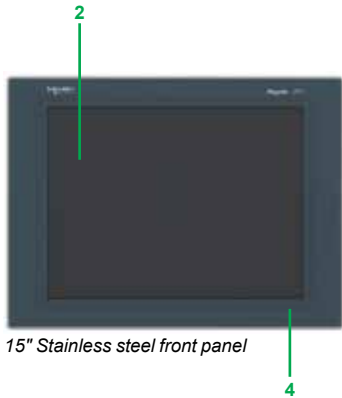

15" Stainless steel front panel

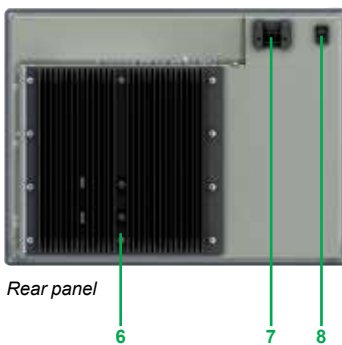

Rear panel

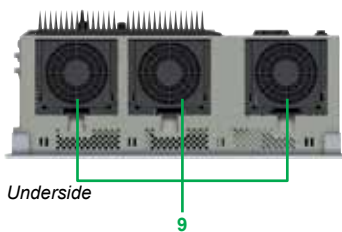

Underside

Magelis Panel PC, 15" or 19"

Description

Magelis Universal and Performance Panel PC:
15" (aluminum and stainless steel bezel) and 19" (aluminum bezel)

Front panels

- 1 15" LCD TFT LED touch screen, XGA 1024 x 768, 16 million colors for HMI P●●7 ●●●●●:
 - Brightness: 350 cd/m² (adjustable)
 - Type of touch panel: Analog resistive film, resolution 4096 x 4096
 - Typical viewing angle: 100° (vertically)/160° (horizontally)
 - 2 19" LCD TFT LED touch screen, SXGA 1280 x 1024, 16 million colors for HMI P●●9 ●●●●●:
 - Brightness: 300 cd/m² (adjustable)
 - Type of touch panel: Analog resistive film, resolution 4096 x 4096
 - Typical viewing angle: 100° (vertically)/160° (horizontally)
 - 3 Aluminum alloy front panel providing IP65 front panel protection when mounted on a panel or enclosure door; mounted on 1.6 to 10 mm thick support using screw fasteners supplied (1)
- or
- 4 Stainless steel 304 "Scotch Brite®" brushed finish front panel enabling an IP65 degree of protection of the front panel when mounted on a panel or an enclosure door. Mounting on 1.6 to 10 mm thick support using stainless steel screw fasteners supplied (1). Cleaning simplified due to absence of USB port on front panel (conforms to food and beverage processing machines standard EN 1672-2). Version fitted with specific seals (standard FDA 21 CFR 177.206)
 - 5 USB 2.0 port (1 A max.) with screw-on protective cover (only available for Aluminum version); captive protective cover option also available (2)

Rear panel

- 6 Heat sink (1)
- 7 Connector for Panel PC 100 to 240 V ~/1.6 A power supply (Panel PC HMI ●●●●A●●●●) (3)
- 8 On/Off switch for 100 to 240 V ~ power supply (Panel PC HMI ●●●●A●●●●)

Underside

- 9 Fans (Panel PC HMI PP●●●●●●●●) (4)
Natural convection (Panel PC HMI PU●●●●●●●●) (1)

(1) For installation, please refer to the "product data sheet" on our website www.schneider-electric.com.

(2) To be ordered separately (see page 3/30).

(3) Consumption excluding additional PCI card.

(4) Can be replaced with the Panel PC fan kit by the customer (to be ordered separately, see page 3/30).

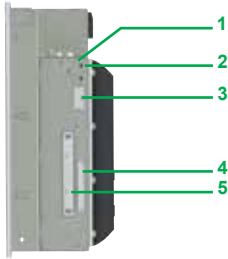

Side panel

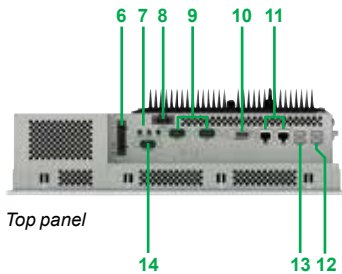

Top panel

Magelis Panel PC, 15" or 19", no PCI slot

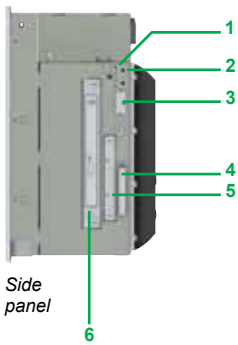

Side panel

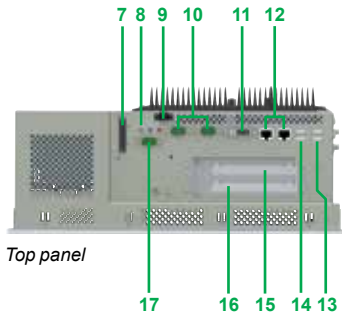

Top panel

Magelis Panel PC, 15" or 19", 2 PCI slots

Description (continued)

Magelis Universal and Performance Panel PC, 15" and 19", no PCI slot

Side panel

- 1 4 status and power supply LEDs
- 2 2 push buttons: 1 for the power supply and 1 for resetting
- 3 Battery
- 4 Slot for Compact Flash card:
 - With Compact Flash card (SLC technology) ≥ 4GB (Panel PC **HMI PUC● D0E01**)
 - Free slot (Panel PC **HMI P●F● ●0●●1**, **HMI P●H● ●0●●1**)
- 5 Slide-in compact rack:
 - Free slot (Panel PC **HMI PUC● D0E01**)
 - With Flash disk ≥ 60 GB (Panel PC **HMI P●F● ●0●●1**) and manufacturer's 5 year warranty (1)
 - With hard disk ≥ 250 GB (Panel PC **HMI P●H● ●0●●1**)

Top panel

- 6 Free slot for battery-backed power supply interface module (2)
- 7 Micro input, line input/line output
- 8 Connector for Panel PC 24 V $\overline{\text{---}}$ /7 A power supply (Panel PC **HMI P●●● D0●●1**) (3)
- 9 2 RS232C ports
- 10 DVI port - RGB connection with adaptor (**HMI YAD DVI RGB 11**) (2)
- 11 2 Ethernet 10/100/1000 Mbps ports
- 12 2 USB 2.0 ports (1 A max.)
- 13 2 USB 2.0 ports (0.5 A max.)
- 14 Slot for additional RS232C/RS422/RS485 serial link interface; to be ordered separately in made-to-order configuration (2).

Magelis Universal and Performance Panel PC, 15" and 19", 2 PCI slots

Side panel

- 1 4 status and power supply LEDs
- 2 2 push buttons: 1 for the power supply and 1 for resetting
- 3 Battery
- 4 Free slot for Compact Flash card
- 5 Slide-in compact rack:
 - with Flash disk ≥ 60 GB (Panel PC **HMI P●F● ●●●●1**) and manufacturer's 5 year warranty (1)
 - With hard disk ≥ 250 GB (Panel PC **HMI P●H● ●2●●1**)
- 6 Slide-in rack with the DVD-RW drive included (4). Can be used for an additional storage disk with adaptor (**HMI YAD SLIDEIN 11**) (5)

Top panel

- 7 Slot for battery-backed power supply interface module:
 - Module mounted on Panel PC **HMI PPH7 B2701**
 - Module not included as standard on other models (2)
- 8 Micro input, line input/line output
- 9 Connector for Panel PC 24 V $\overline{\text{---}}$ /7 A power supply (Panel PC **HMI P●D● ●●●●1**) (3)
- 10 2 RS232C ports
- 11 DVI port - RGB connection with adaptor (**HMI YAD DVI RGB 11**) (2)
- 12 2 Ethernet 10/100/1000 Mbps ports
- 13 2 USB 2.0 ports (1 A max.)
- 14 2 USB 2.0 ports (0.5 A max.)
- 15 Half-format PCI Express® 4x slot
- 16 Half-format PCI 2.2 slot
- 17 Slot for additional RS232C/RS422/RS485 serial link interface; to be ordered separately in made-to-order configuration (2).

(1) For general conditions of manufacturer's 5 year warranty: please consult our Customer Care Center.

(2) To be ordered separately in made-to-order configuration (see page 3/31).

(3) Consumption excluding additional PCI card.

(4) Operating temperature details available on our website www.schneider-electric.com.

(5) To be ordered separately as an accessory (see page 3/30).

Magelis Universal Panel PC - 15" LCD TFT LED touch screen (1) (2)
(Intel® ATOM™ N270 processor (1.6 GHz)/DDR2 RAM)

Supply voltage PCI slot	Operating system	Software	Storage	DDR2 RAM (3)	Reference	Weight kg
----------------------------	---------------------	----------	---------	-----------------	-----------	--------------

For maintenance-free environment (with Aluminum front panel bezel)

24 V --- No PCI slot	Windows® Embedded Standard 2009 (4)	Vijeo Designer RT Demo (5)	Compact Flash ≥ 4 GB	1 GB	HMI PUC7 D0E01	8.900
	Windows® XP Professional SP3	Vijeo Designer RT Demo (5)	Flash disk ≥ 60 GB with 5 year warranty (6)	1 GB	HMI PUF7 D0P01	9.000
		Vijeo Designer RT Demo (5) Vijeo Citect Lite 1200 I/O		2 GB	HMI PUF7 D0PL1	9.000

100 to 240 V ~ No PCI slot	Windows® XP Professional SP3	Vijeo Designer RT Demo (5)	Flash disk ≥ 60 GB with 5 year warranty (6)	1 GB	HMI PUF7 A0P01	9.500
-------------------------------	---------------------------------	-------------------------------	--	------	-----------------------	-------

100 to 240 V ~ 1 PCI + 1 PCI Express®	Windows® XP Professional SP3	Vijeo Designer RT Demo (5)	Flash disk ≥ 60 GB with 5 year warranty (6)	1 GB	HMI PUF7 A2P01	10.900
		Vijeo Designer RT Demo (5) Vijeo Citect Full 500 I/O		2 GB	HMI PUF7 A2PF1	10.900

For maintenance-free environment (with Stainless steel front panel bezel)

24 V --- 1 PCI + 1 PCI Express®	Windows® XP Professional SP3	Vijeo Designer RT Demo (5)	Flash disk ≥ 60 GB with 5 year warranty (6)	1 GB	HMI PTF7 D2P01	11.100
---------------------------------------	---------------------------------	-------------------------------	--	------	-----------------------	--------

For standard industrial environment (with Aluminum front panel bezel)

24 V --- No PCI slot	Windows® XP Professional SP3	Vijeo Designer RT Demo (5)	Hard disk ≥ 250 GB	1 GB	HMI PUH7 D0P01	9.000
-------------------------	---------------------------------	-------------------------------	--------------------	------	-----------------------	-------

24 V --- 1 PCI + 1 PCI Express®	Windows® XP Professional SP3	Vijeo Designer RT Demo (5)	Hard disk ≥ 250 GB	1 GB	HMI PUH7 D2P01	10.300

100 to 240 V ~ No PCI slot	Windows® XP Professional SP3	Vijeo Designer RT Demo (5)	Hard disk ≥ 250 GB	1 GB	HMI PUH7 A0P01	9.500
-------------------------------	---------------------------------	-------------------------------	--------------------	------	-----------------------	-------

100 to 240 V ~ 1 PCI + 1 PCI Express®	Windows® XP Professional SP3	Vijeo Designer RT Demo (5)	Hard disk ≥ 250 GB	1 GB	HMI PUH7 A2P01	10.900

For standard industrial environment (with Stainless steel front panel bezel)

24 V --- 1 PCI + 1 PCI Express®	Windows® XP Professional SP3	Vijeo Designer RT Demo (5)	Hard disk ≥ 250 GB	1 GB	HMI PTH7 D2P01	11.100
---------------------------------------	---------------------------------	-------------------------------	--------------------	------	-----------------------	--------

(1) 15" touch screen: XGA 1024 x 768, 16 million colors, IP65 front panel protection when mounted on panel or enclosure door.

(2) For separate components, software and external power supply see page 3/30.

(3) Memory capacity not user-expandable; increased capacity available in made-to-order configuration (see page 3/31).

(4) Windows® Embedded Standard 2009 supplied in 9 languages (English, French, German, Italian, Portuguese, Spanish, Swedish, Chinese, Russian). Also includes:

- Acrobat Reader, Word/Excel/Power Point Viewer
- Framework.Net 3.5
- Web browser
- Vijeo Citect Web Client
- Vijeo Designer Run Time Demo (5)

(5) Vijeo Designer RT (Run Time) Demo (21-day trial version). Unlimited license, to be ordered separately (VJDSNRTMPC) (see page 3/30).

(6) For general conditions of manufacturer's 5 year warranty: please consult our Customer Care Center.



HMI PU7 A0P01
(CPU side)



HMI PTF7 D2P01
HMI PTH7 D2P01
(screen side)



HMI PU7 A2P01
(CPU side)



HMI PUH7 D2P01
(CPU side)



HMI PUH7 D2P01
(CPU side)

Magelis™ Human/Machine Interfaces

Industrial PCs

Magelis iPCs certified for automation
Magelis Panel PC – Performance range
15" touch screen

Magelis Performance Panel - 15" LCD TFT LED touch screen (1) (2)						
(Intel® Core™ 2 Duo P8400 processor (2.26 GHz)/DDR3 RAM)						
Supply voltage PCI slot	Operating system	Software	Storage	DDR3 RAM (3)	Reference	Weight kg
For harsh industrial environment (with Aluminum front panel bezel)						
24 V ~ No PCI slot	Windows® 7 Ultimate 64-bit	Vijeo Designer RT Demo (4)	Flash disk ≥ 60 GB with 5 year warranty (5)	2 GB	HMI PPF7 D0701	10.100
		Vijeo Designer RT Demo (4) Vijeo Citect Full 500 I/O	Flash disk ≥ 60 GB with 5 year warranty (5)	4 GB	HMI PPF7 D07F1	10.100
100 to 240 V ~ 1 PCI + 1 PCI Express®	Windows® 7 Ultimate 64-bit	Vijeo Designer RT Demo (4)	Flash disk ≥ 60 GB with 5 year warranty (5)	2 GB	HMI PPF7 A2701	12.000
		Vijeo Designer RT Demo (4) Vijeo Citect Full 500 I/O	Flash disk ≥ 60 GB with 5 year warranty (5)	4 GB	HMI PPF7 A27F1	12.000
For standard industrial environment (with Aluminum front panel bezel)						
24 V ~ No PCI slot	Windows® 7 Ultimate 64-bit	Vijeo Designer RT Demo (4)	Hard disk ≥ 250 GB	2 GB	HMI PPH7 D0701	10.100
		Vijeo Designer RT Demo (4) Vijeo Citect Full 500 I/O	Hard disk ≥ 250 GB	2 GB	HMI PPH7 D2701	11.400
24 V ~ 1 PCI + 1 PCI Express®	Windows® 7 Ultimate 64-bit	Vijeo Designer RT Demo (4)	Hard disk ≥ 250 GB	2 GB	HMI PPH7 B2701	11.400
		Vijeo Designer RT Demo (4) Vijeo Citect Full 500 I/O	Hard disk ≥ 250 GB	2 GB	HMI PPH7 A0701	10.600
100 to 240 V ~ 1 PCI + 1 PCI Express®	Windows® 7 Ultimate 64-bit	Vijeo Designer RT Demo (4)	Hard disk ≥ 250 GB	2 GB	HMI PPH7 A2701	12.000
		Vijeo Designer RT Demo (4) Vijeo Citect Full 500 I/O	Hard disk ≥ 250 GB	2 GB	HMI PRH7 A2701	12.200
For standard industrial environment (with Stainless steel front panel bezel)						
100 to 240 V ~ 1 PCI + 1 PCI Express®	Windows® 7 Ultimate 64-bit	Vijeo Designer RT Demo (4)	Hard disk ≥ 250 GB	2 GB	HMI PRH7 A2701	12.200
		Vijeo Designer RT Demo (4) Vijeo Citect Full 500 I/O	Hard disk ≥ 250 GB	2 GB	HMI PRH7 A2701	12.200



HMI PP7 A0701
(screen side)



HMI PPF7 A2701
(screen side)



HMI PP7 A0701
(CPU side)



HMI PP7 A2701
(CPU side)



HMI PPH7 D2701
(CPU side)

(1) 15" touch screen: XGA 1024 x 768, 16 million colors, IP65 front panel protection when mounted on panel or enclosure door.
 (2) For separate components, software and external power supply see page 3/30.
 (3) Memory capacity not user-expandable; increased capacity available in made-to-order configuration (see page 3/31).
 (4) Vijeo Designer RT (Run Time) Demo (21-day trial version). Unlimited license, to be ordered separately (VJDSNRTMPC) (see page 3/30).
 (5) For general conditions of manufacturer's 5 year warranty: please consult our Customer Care Center.



Magelis™ Human/Machine Interfaces

Industrial PCs

Magelis iPCs certified for automation
Magelis Panel PC – Universal range
19" touch screen

3



HMI PU9 ●●●●1
(screen side)



HMI PU9 A2P1 ●1
(CPU side)



HMI PUH9 D2P01
(CPU side)



HMI PUH9 A0P01
(CPU side)

Magelis Universal Panel PC - 19" LCD TFT LED touch screen (1) (2) (Intel® ATOM™ N270 processor (1.6 GHz)/DDR2 RAM)

Supply voltage PCI slot	Operating system	Software	Storage	DDR2 RAM (3)	Reference	Weight kg
For maintenance-free environment (with Aluminum front panel bezel)						
24 V ~ No PCI slot	Windows® Embedded Standard 2009 (4)	Vijeo Designer RT Demo (5)	Compact Flash ≥ 4 GB	1 GB	HMI PUC9 D0E01	13.600
	Windows® XP Professional SP3	Vijeo Designer RT Demo (5)	Flash disk ≥ 60 GB with 5 year warranty (6)	1 GB	HMI PUF9 D0P01	13.700
		Vijeo Designer RT Demo (5) Vijeo Citect Full 500 I/O	Flash disk ≥ 60 GB with 5 year warranty (6)	2 GB	HMI PUF9 D0PF1	13.700
100 to 240 V ~ 1 PCI + 1 PCI Express®	Windows® XP Professional SP3	Vijeo Designer RT Demo (5)	Flash disk ≥ 60 GB with 5 year warranty (6)	1 GB	HMI PUF9 A2P01	14.700
		Vijeo Designer RT Demo (5) Vijeo Citect Full 500 I/O	Flash disk ≥ 60 GB with 5 year warranty (6)	2 GB	HMI PUF9 A2PF1	15.500
For standard industrial environment (with Aluminum front panel bezel)						
24 V ~ No PCI slot	Windows® XP Professional SP3	Vijeo Designer RT Demo (5)	Hard disk ≥ 250 GB	1 GB	HMI PUH9 D0P01	13.700
24 V ~ 1 PCI + 1 PCI Express®	Windows® XP Professional SP3	Vijeo Designer RT Demo (5)	Hard disk ≥ 250 GB	1 GB	HMI PUH9 D2P01	15.000
100 to 240 V ~ No PCI slot	Windows® XP Professional SP3	Vijeo Designer RT Demo (5)	Hard disk ≥ 250 GB	1 GB	HMI PUH9 A0P01	14.300
100 to 240 V ~ 1 PCI + 1 PCI Express®	Windows® XP Professional SP3	Vijeo Designer RT Demo (5)	Hard disk ≥ 250 GB	1 GB	HMI PUH9 A2P01	15.500

(1) 19" touch screen: SXGA 1280 x 1024, 16 million colors, IP65 front panel protection when mounted on panel or enclosure door.
 (2) For separate components, software and external power supply see page 3/30.
 (3) Memory capacity not user-expandable; increased capacity available in made-to-order configuration (see page 3/31).
 (4) Windows® Embedded Standard 2009 supplied in 9 languages (English, French, German, Italian, Portuguese, Spanish, Swedish, Chinese, Russian). Also includes:
 - Acrobat Reader, Word/Excel/Power Point Viewer
 - Framework.Net 3.5
 - Web browser
 - Vijeo Citect Web Client
 - Vijeo Designer Run Time Demo (5)
 (5) Vijeo Designer RT (Run Time) Demo (21-day trial version). Unlimited license, to be ordered separately (VJDSNRTMPC) (see page 3/30).
 (6) For general conditions of manufacturer's 5 year warranty: please consult our Customer Care Center.

Magelis™ Human/Machine Interfaces

Industrial PCs

Magelis iPCs certified for automation
Magelis Panel PC – Performance range
19" touch screen



HMI PP9 00001
(screen side)



HMI PP9 A2701
(CPU side)



HMI PPH9 D2701
(CPU side)



HMI PPH9 A0701
(CPU side)

Magelis Performance Panel - 19" LCD TFT LED touch screen^{(1) (2)}

(Intel® Core™ 2 Duo P8400 processor (2.26 GHz)/DDR3 RAM)

Supply voltage PCI slot	Operating system	Software	Storage	DDR3 RAM ⁽³⁾	Reference	Weight kg
For harsh industrial environment (with Aluminum front panel bezel)						
24 V $\overline{\text{---}}$ No PCI slot	Windows® 7 Ultimate 64-bit	Vijeo Designer RT Demo ⁽⁴⁾	Flash disk \geq 60 GB ⁽⁵⁾	2 GB	HMI PPF9 D0701	14.800
		Vijeo Designer RT Demo ⁽⁴⁾ Vijeo Citect Full 500 I/O	Flash disk \geq 60 GB ⁽⁵⁾	4 GB	HMI PPF9 D07F1	14.800
100 to 240 V \sim 1 PCI + 1 PCI Express®	Windows® 7 Ultimate 64-bit	Vijeo Designer RT Demo ⁽⁴⁾	Flash disk \geq 60 GB ⁽⁵⁾	2 GB	HMI PPF9 A2701	16.600
		Vijeo Designer RT Demo ⁽⁴⁾ Vijeo Citect Full 500 I/O	Flash disk \geq 60 GB ⁽⁵⁾	4 GB	HMI PPF9 A27F1	16.600

For standard industrial environment (with Aluminum front panel bezel)

24 V $\overline{\text{---}}$ No PCI slot	Windows® 7 Ultimate 64-bit	Vijeo Designer RT Demo ⁽⁴⁾	Hard disk \geq 250 GB	2 GB	HMI PPH9 D0701	14.800
24 V $\overline{\text{---}}$ 1 PCI + 1 PCI Express®	Windows® 7 Ultimate 64-bit	Vijeo Designer RT Demo ⁽⁴⁾	Hard disk \geq 250 GB	2 GB	HMI PPH9 D2701	16.100
100 to 240 V \sim No PCI slot	Windows® 7 Ultimate 64-bit	Vijeo Designer RT Demo ⁽⁴⁾	Hard disk \geq 250 GB	2 GB	HMI PPH9 A0701	15.400
100 to 240 V \sim 1 PCI + 1 PCI Express®	Windows® 7 Ultimate 64-bit	Vijeo Designer RT Demo ⁽⁴⁾	Hard disk \geq 250 GB	2 GB	HMI PPH9 A2701	16.500

⁽¹⁾ 19" touch screen: SXGA 1280 x 1024, 16 million colors, IP65 front panel protection when mounted on panel or enclosure door.

⁽²⁾ For separate components, software and external power supply see page 3/30.

⁽³⁾ Memory capacity not user-expandable; increased capacity available in made-to-order configuration (see page 3/31).

⁽⁴⁾ Vijeo Designer RT (Run Time) Demo (21-day trial version). Unlimited license, to be ordered separately (VJDSNRTMPC) (see page 3/30).

⁽⁵⁾ For general conditions of manufacturer's 5 year warranty: please consult our Customer Care Center.

Components

Description	Details	Compatible with Magelis Panel PC ranges:			Reference	Weight kg
		Optimum	Universal	Performance		
Storage disks, peripheral equipment, kits						
Hard disk	250 GB, blank	–	All models		HMI YHDD 0250 11	–
Flash disk with 5 year warranty (1)	60 GB, blank	–	All models		HMI YSDD 0060 11	–
Compact Flash card (SLC technology)	2 GB, blank	All models			HMI YCF S02 11	–
	4 GB, blank	All models			HMI YCF S04 11	–
	8 GB, blank	All models			HMI YCF S08 11	–
SD memory card	4 GB, blank, for user data	All models	–		HMI ZSD 4G	–
DVD-RW drive for slide-in rack (2)	CD-RW and DVD-RW reader/writer	–	Panel PC with 2 PCI slots		HMI YDR DVDRW 11	–
Slide-in adaptor for storage disk	Used to insert a hard disk or an SSD Flash disk in a slide-in rack	–	Panel PC with 2 PCI slots		HMI YAD SLIDEIN 11	–
DVI/VGA RGB adaptor	For connecting an RGB screen to the integrated DVI port	–	All models		HMI YAD DVI RGB 11	–
RAID PCI card with 2 redundant hard disks (2)	PCI card equipped with two 250 GB redundant hard disks	–	Panel PC with 2 PCI slots		HMI YRAID PCI 11	–
Hard disk for RAID PCI card	Replacement hard disk for RAID PCI card HMI YRAID PCI 11	–	Panel PC with 2 PCI slots + RAID PCI card HMI YRAID PCI 11		HMI YRAID D0250 11	–
Backup power supply kit	Provides an uninterruptible power supply. Includes: ■ 1 backup battery ■ 1 x 3 m cordset	–	Configured Magelis Panel PC with battery-backed power supply interface module (3)		HMI YUPS KT 11	–
Power supply filter for marine certification	Necessary for compliance with marine certification.	Panel PC HMI PWC7 D0E01	Panel PC HMI PUC● D●●●●/ PUF● D●●●●	–	HMI YLFI MAR 11	–
Maintenance kit for Panel PC	Includes: ■ 1 x 3-way removable connector for 24 V ∴ power supply ■ 1 x 3-way removable connector for 100 to 240 V ∼ power supply ■ 2 protective covers for USB port on front panel (only on Aluminum bezel versions) ■ 10 replacement filters for fan, including: □ 5 for Magelis Panel PC with no PCI slot □ 5 for Magelis Panel PC with 2 PCI slots ■ 18 screw fasteners (Aluminum bezel) or 14 fasteners (Stainless steel bezel)	–	All models		HMI YPMKT 11	0.060
Captive USB protective cover	2 captive covers for USB port on front panel	All Aluminum bezel version models			HMI YPUSB UN5 11	0.040
Fan kit for Panel PC	For fan replacement by user	–	All models with no PCI slot		HMI YPFKT 01	0.250
			All models with 2 PCI slots		HMI YPFKT 21	0.800
Screen protection	5 protective film sheets for 10" screen	Panel PC HMI PWC5 D0E01	–		MPC YK2 0SPS KIT	–
	5 protective film sheets for 15" screen (Aluminum and Stainless steel bezel versions)	Panel PC HMI P●C7 D0E01	Panel PC HMI P●●7 ●●●●●		MPC YK5 0SPS KIT	–
	5 protective film sheets for 19" screen	–	Panel PC HMI P●●9 ●●●●●		MPC YK9 0SPS KIT	–
Cable for iDisplay	Extra long (10 m)	–	All models		HMI YCAB DVI1011	–
Software						
Vijeo Designer Run Time license for 1 workstation	Converts the 21-day trial version of Vijeo Designer Run Time Demo to an unlimited license	All models			VJD SNR TMPC	–
License extension Intelligent Data Service for Vijeo Designer Run Time for 1 workstation	Used to track the process variables and all operator actions, and offers visibility of the key process values	All models (requires storage capacity ≥ 4GB)			VJD SNT RCK V60M	–
External Phaseo power supply						
Phaseo regulated switch mode power supply ABL 8 Rail mounting	Input voltage: 100 to 120 V/200 to 500 V ∼ (4) Output voltage: 24 V ∴ Power: 120 W	All models	–		ABL 8RPS24050 (5) (6)	0.700
Phaseo regulated switch mode power supply ABL 4 Rail mounting	Input voltage: 100 to 230 V ∼ (4) Output voltage: 24 V ∴ Power: 120 W	All models	–		ABL 4RSM24050 (5) (6)	0.500

(1) For general conditions of manufacturer's 5 year warranty: please consult our Customer Care Center.

(2) Operating temperature details available on our website www.schneider-electric.com.

(3) For configured Magelis Panel PC see page 3/31.

(4) Single-phase connection. Phase-to-phase connection possible on certain American line supplies, please consult our Customer Care Center.

(5) If adding a PCI card, you need to select a Phaseo power supply with a power rating suitable for the extra consumption. Please consult the "Phaseo power supply and transformer" catalog on our website www.schneider-electric.com.

(6) To order this reference, please consult our Customer Care Center.

Configured Magelis Panel PC industrial PC

With the “configured iPC” service, Schneider Electric offers multiple configuration combinations for Magelis iPCs.

This service, available exclusively from our Customer Care Center, allows users to configure a certified product suitable for specific automation applications and environments, based on Magelis Universal and Performance Panel PCs.

Our Customer Care Center draws up:

- Complete parts list for the configured Magelis Panel PC
- Selling price
- Complete reference (root + code which varies according to the configuration)
- Purchase order

Ordering procedure for a configured Magelis Panel PC

- 1 Please consult our Customer Care Center.
- 2 State the reference root; this root will be completed with the variable part of the reference, once configuration is complete. The root varies depending on which Magelis Panel PC base is selected:
 - **HMI PCCW** corresponds to a configured Magelis Optimum Panel PC base, with an aluminum front panel
 - **HMI PCCV** corresponds to a configured Magelis Optimum Panel PC base, with a stainless steel front panel
 - **HMI PCCP** corresponds to a configured Magelis Universal or Performance Panel PC base, with an aluminum front panel
 - **HMI PCCT** corresponds to a configured Magelis Universal or Performance Panel PC base, with a stainless steel front panel.
- 3 Configure your Magelis Panel PC (see table below).
- 4 Confirm your order.

References

Description	Magelis Panel PC base	Reference	Weight kg
Configured Magelis Panel PC The configuration should be made up from the components below. (1)	Reference root to be stated to our Customer Care Center.	Optimum, aluminum front panel bezel	HMI PCCW (2)
		Optimum, stainless steel front panel bezel (15" screen only)	HMI PCCV (2)
		Universal and Performance, aluminum front panel bezel	HMI PCCP (2)
		Optimum and Performance, stainless steel front panel bezel (15" screen only)	HMI PCCT(2)

Description	Available on Magelis Panel PC base			Reference	Weight kg
	Optimum Processor Intel® ATOM™ Z510 (1.1 GHz) DDR2 RAM 24 V ~ power supply	Universal Processor Intel® ATOM™ N270 (1.6 GHz) DDR2 RAM 24 V ~ or 100 to 240 V ~ power supply	Performance Intel® Core™ 2 Duo P8400 processor (2.26 GHz) DDR3 RAM 24 V ~ or 100 to 240 V ~ power supply		
LCD TFT LED touch screen 16 million colors	10.4" or 15"	15" or 19"		(2)	–
RAM	2 GB max. (DDR2)	3 GB max. (DDR2)	8 GB max. (DDR3)		
Peripheral storage devices	Compact Flash card 8 GB max. (SLC technology)				
		Up to 2 Flash disks (3) ≥ 60 GB (SLC technology SSD)			
		Up to 2 hard disks ≥ 250 GB			
Other peripheral device	–	DVD-RW drive			
PCI slot configuration	–	No PCI slot			
		1 PCI + 1 PCI Express® or 2 PCI			
Operating systems	Windows® Embedded Standard 2009				
		Windows® Embedded Standard 7 32-bit			
		Windows® XP PRO SP3			
		Windows® 7 Ultimate 32-bit			
		Windows® 7 Ultimate 64-bit			
Software	Vijeo Designer Run Time				
		Vijeo Citect			
Assembled options	–	RAID PCI card with 2 redundant hard disks			
	–	Interface module for backup power supply required for the HMI YUPS KT 11 backup power supply kit (see page 3/30)			
	–	Additional RS232C/RS422/RS485 serial link interface			
	1 or 2 Ethernet ports	2 Ethernet ports			

1) Please consult our Customer Care Center.

2) The reference of configured Magelis Panel PC industrial PCs is made up of a root (HMI PCCW, HMI PCCV, HMI PCCP or HMI PCCT) followed by a variable part generated during configuration.

3) Flash disk (SSD) with manufacturer's 5 year warranty. Please consult our Customer Care Center.

Old PC Panels		Replaced by Magelis Panel PC		Compatibility	
Description	References	Description	References	Cut-out for flush mounting	Screen definition
Magelis Smart (with Compact Flash card)		Magelis Panel PC (Optimum or Universal range)			
Magelis Smart 8.4" screen, 24 V ---	MPC ST1 1NDJ 00T	Magelis Optimum Panel PC 10" screen, 24 V ---	HMI PWC5 D0E01		
Magelis Smart 8.4" screen, 100 to 240 V ~	MPC ST1 1NAJ 00T	Magelis Optimum Panel PC 10" screen, 24 V ---	HMI PWC5 D0E01 + Phaseo power supply (1)		
Magelis Smart 15" screen, 24 V ---	HMI PSC7 DE03 MPC ST5 2NDJ 20T	Magelis Optimum Panel PC 15" screen, 24 V ---	HMI PWC7 D0E01		
		Magelis Optimum Panel PC 15" screen, 24 V ---, ATEX	HMI PVC7 D0E01 HMI PCCT (3)		
		Magelis Universal Panel PC 15" screen, 24 V ---	HMI PUC7 D0E01		
Magelis Smart 15" screen, 100 to 240 V ~	HMI PSC7 AE03 MPC ST5 2NAJ 20T MPC ST5 2NAJ 20H	Magelis Optimum Panel PC 15" screen, 24 V ---	HMI PWC7 D0E01 + Phaseo power supply (1)		
		Magelis Universal Panel PC 15" screen, 24 V ---	HMI PUC7 D0E01 + Phaseo power supply (1)		
Magelis Smart+ (with Flash disk)		Magelis Panel PC (Universal range)			
Magelis Smart+ 15" screen, 24 V ---	HMI PSF7 DP03	Magelis Universal Panel PC 15" screen, 24 V ---	HMI PUF7 D0P01		
		Magelis Universal Panel PC 15" screen, 24 V ---, ATEX	HMI PTF7 D2P01		
Magelis Smart+ 15" screen, 100 to 240 V ~	HMI PSF7 AP03	Magelis Universal Panel PC 15" screen, 100 to 240 V ~	HMI PUF7 A0P01		
		Magelis Universal Panel PC 15" screen, 100 to 240 V ~, ATEX	HMI PCCT(3)		
Magelis Smart+ 15" screen, 100 to 240 V ~ Vijeo Citect Lite 1200 I/O	HMI PSF7 APL3 (2)	Magelis Universal Panel PC 15" screen, 24 V --- Vijeo Citect Lite 1200 I/O	HMI PUF7 D0PL1 (2)		
		Magelis Universal Panel PC 15" screen, 100 to 240 V ~, ATEX	HMI PCCT (3)		
Magelis Smart+ 15" screen, 100 to 240 V ~ Vijeo Citect Full 500 I/O	HMI PSF7 APF3	Magelis Universal Panel PC 15" screen, 100 to 240 V ~ Vijeo Citect Full 500 I/O	HMI PUF7 A2PF1		
		Magelis Universal Panel PC 15" screen, 100 to 240 V ~, ATEX	HMI PCCT(3)		
Magelis Compact iPC - General Purpose (with hard disk)		Magelis Panel PC (Universal range)			
Magelis Compact iPC - General Purpose 15" screen, 24 V ---	MPC KT5 5NDX 20N	Magelis Universal Panel PC 15" screen, 24 V ---	HMI PUH7 D2P01		
		Magelis Universal Panel PC 15" screen, 24 V ---, ATEX	HMI PTH7 D2P01		
Magelis Compact iPC General Purpose - 15" screen, 100 to 240 V ~	MPC KT5 5NAX 20N	Magelis Universal Panel PC 15" screen, 100 to 240 V ~	HMI PUH7 A2P01		
Magelis Compact iPC - Heavy Duty (with Flash disk)		Magelis Panel PC (Universal range)			
Magelis Compact iPC - Heavy Duty 15" screen, 100 to 240 V ~	MPC KT5 5MAX 20N	Magelis Universal Panel PC 15" screen, 100 to 240 V ~	HMI PUF7 A2P01		
Magelis Compact iPC - Heavy Duty 15" screen, 100 to 240 V ~ Vijeo Citect Lite 1200 I/O	MPC KT5 5MAX 20L	Magelis Universal Panel PC 15" screen, 100 to 240 V ~ Vijeo Citect Full 500 I/O	HMI PUF7 A2PF1		
		Configured Magelis Panel PC Universal Panel PC base with: ■ 15" screen, 100 to 240 V ~ ■ Vijeo Citect Lite 1200 I/O	HMI PCCP (3)		
Magelis Compact iPC - Heavy Duty 15" screen, 100 to 240 V ~ Vijeo Citect Full 500 I/O	MPC KT5 5MAX 20V	Magelis Universal Panel PC 15" screen, 100 to 240 V ~ Vijeo Citect Full 500 I/O	HMI PUF7 A2PF1		
		Cut-out or screen definition	Identical		
			Different		

(1) ABL 8RPS24050 or ABL 4RSM24050 Phaseo power supply (see page 3/30).

(2) Correspondence between different power supplies: 100 to 240 V ~/24 V ---.

(3) Made-to-order configuration (see page 3/31).

Old Front Panels + Flex PC BOX		Replaced by Magelis iPC		Compatibility	
Description	References	Description	References (1)	Cut-out for flush mounting	Screen definition
Front Panels + Magelis Flex PC BOX					
Front Panel with 12" touch screen and keypad + Magelis Flex PC BOX 24 V $\overline{\text{---}}$ or 100 to 240 V \sim (2)	MPC YB2 0NNN 00N + MPC F/H●● ●●●● ●●●●	Magelis Optimum/Universal/Performance Panel PC 15" touch screen, 24 V $\overline{\text{---}}$ or 100 to 240 V \sim	HMI P●●7 ●●●●● (3)	Green	Green
		Magelis iDisplay with 15" screen, 100 to 240 V \sim + Magelis Universal/Performance BOX PC, 24 V $\overline{\text{---}}$	MPC YT5 0NAN 00N (3) + HMI B●●● ●●●●● (4)		
		Magelis iDisplay with 15" screen, 24 V $\overline{\text{---}}$ + Magelis Universal/Performance BOX PC, 24 V $\overline{\text{---}}$	HMI DID7 DT0 (3) + HMI B●●● ●●●●● (4)		
		Magelis iDisplay with 15" screen and keypad, 100 to 240 V \sim + Magelis Universal/Performance BOX PC, 24 V $\overline{\text{---}}$	MPC NB5 0NAN 00N + HMI B●●● ●●●●● (4)		
		Magelis Optimum/Universal/Performance Panel PC 15" touch screen, 24 V $\overline{\text{---}}$ or 100 to 240 V \sim	HMI P●●7 ●●●●●		
Front Panel with 15" touch screen + Magelis Flex PC BOX 24 V $\overline{\text{---}}$ or 100 to 240 V \sim (2)	MPC YT5 0NNN 00N + MPC F/H●● ●●●● ●●●●	Magelis iDisplay with 15" screen, 100 to 240 V \sim + Magelis Universal/Performance BOX PC, 24 V $\overline{\text{---}}$	MPC YT5 0NAN 00N + HMI B●●● ●●●●● (4)	Green	Green
		Magelis iDisplay with 15" screen, 24 V $\overline{\text{---}}$ + Magelis Universal/Performance BOX PC, 24 V $\overline{\text{---}}$	HMI DID7 DT0 + HMI B●●● ●●●●● (4)		
		Magelis iDisplay with 15" screen and keypad, 100 to 240 V \sim + Magelis Universal/Performance BOX PC, 24 V $\overline{\text{---}}$	MPC NB5 0NAN 00N + HMI B●●● ●●●●● (4)		
Front Panel with 15" touch screen and keypad + Magelis Flex PC BOX 24 V $\overline{\text{---}}$ or 100 to 240 V \sim (2)	MPC YB5 0NNN 00N + MPC F/H●● ●●●● ●●●●	Magelis Universal/Performance Panel PC 19" touch screen, 24 V $\overline{\text{---}}$ or 100 to 240 V \sim	HMI P●●9 ●●●●●	Light Green	Light Green
		Magelis iDisplay with 19" screen, 100 to 240 V \sim + Magelis Universal/Performance BOX PC, 24 V $\overline{\text{---}}$	MPC YT9 0NAN 00N + HMI B●●● ●●●●● (4)		

Cut-out or screen definition	Identical	Green
	Different	Light Green

(1) Complete references: Magelis Panel, see pages 3/17, 3/26 or 3/28/ Magelis iDisplay, see page 3/47 / Magelis BOX PC, see page 3/40.
 (2) Power provided by the Magelis Flex PC BOX CPU; the type of power supply depends on the CPU model.
 (3) Correspondence between different screen functions: touch screen + keypad/touch screen.
 (4) Correspondence between possibly different power supplies: 100 to 240 V \sim /24 V $\overline{\text{---}}$.

Industrial PCs

Magelis iPCs certified for automation

Magelis BOX PC

Universal and Performance ranges

3

Type	Industrial environments
------	-------------------------

Universal range - 1 PCI slot	
Maintenance-free	Standard



Fanless	
Diskless	
CPU (1)	Processor PCI slot Storage
	RAM (2)
	Integrated DVD-RW drive Slide-in rack for peripheral device
	Integrated ports
	Optional ports Optional RAID PCI card

★★★★★	★★★★★	★★★★★
★★★★★	★★★★★	–
Intel® ATOM™ N270 (1.6 GHz)		
1 PCI		
Compact Flash card ≥ 4 GB (SLC technology)	Flash disk ≥ 60 GB with 5 year warranty (3)	Hard disk ≥ 250 GB
1 GB	HMI BUFN D1PF1: 2 GB HMI BUFN D1P01: 1 GB	1 GB
–		
1 x slide-in compact rack for storage disk	1 x slide-in compact rack for storage disk (Flash disk or hard disk included)	
2 x Ethernet 10/100/1000 Mbps		
1 x USB 2.0 (1 A) on the front panel + 4 x USB 2.0 (0.5 and 1 A) at the top		
2 x RS232C		
1 x DVI (VGA RGB adaptor, optional)		
1 x RS232C/RS422/RS485		
RAID PCI card with 2 redundant hard disks		

Operating system	
------------------	--

Windows® Embedded Standard 2009	Windows® XP Professional SP3
---------------------------------	------------------------------

Supply voltage	Voltage Current (excluding PCI card)
----------------	---

24 V \pm (± 25%) (4)	Nominal current 6 A. Typical inrush current 7 A, 50 A < 300 μ s
------------------------	---

Mounting	
Overall dimensions (W x H x D in mm)	

Vertical, at the back of the enclosure ("book" format) or flat (requiring fan kit HMI YBFKT 11)	82 x 270 x 251
---	----------------

Temperature	during operation
Vibration resistance	Continuous
during operation	Non-continuous
	Merchant navy IACS E10

Conforming to IEC 61132-2, UL 508: 0 to 50°C (mounted vertically) or 0 to 45°C (mounted flat)	
1.75 mm amplitude from 2 to 9 Hz, 0.5 g from 9 to 200Hz (5)	0.125 g from 5 to 100 Hz
3.5 mm amplitude from 2 to 9 Hz, 1 g from 9 to 200Hz (5)	0.250 g from 5 to 100 Hz
1 mm amplitude from 5 to 13.2 Hz, 0.7 g from 13.2 to 100Hz, 90 minutes endurance	–

Shock resistance	During operation
------------------	------------------

15 g/11 ms conforming to IEC 60068-2-27 test Ea

Standards and certifications	
------------------------------	--

CE, cULus (UL 508, CSA 22.2 n°142), cULus Haz Loc Class I Div 2 (ANSI/ISA 12.12.01, UL 1604, CSA 22.2 n°213), ATEX II 3 Dust zone 22, C-Tick, GOST
--

Marine certification	Germanischer Lloyd (Bridge Class)
----------------------	-----------------------------------

With power supply filter HMI YLFI MAR11	–
---	---

Compatible screens	
--------------------	--

The whole range of Magelis iDisplay screens (see page 3/44)

Software	Vijeo Designer Run Time Demo
----------	------------------------------

Vijeo Designer Run Time Demo (21-day trial version). Unlimited license, to be ordered separately (VJDSNRTMPC)

References	Vijeo Designer Run Time Demo Vijeo Citect Full 500 I/O Vijeo Designer Run Time Demo
------------	---

–	HMI BUFN D1PF1	–
HMI BUCN D1E01	HMI BUFN D1P01	HMI BUHN D1P01

Pages	3/40
-------	------

Made-to-order configuration	See configured Magelis BOX PC on page 3/42
-----------------------------	--

(1) Memory capacity not user-expandable; increased capacity available in made-to-order configuration (see page 3/42).
 (2) For other available options (interface for backup battery, etc.) in made-to-order configuration, see pages 3/41 and 3/42.
 (3) For general conditions of manufacturer's 5 year warranty: please consult our Customer Care Center.



Universal range - 2 PCI slots		Performance range - 2 PCI slots		Performance range - 5 PCI slots	
Maintenance-free	Standard	Harsh	Standard	Harsh	Standard



★★★★★	★★★★★	–	–	–	–
★★★★★	–	★★★★★	–	★★★★★	–
Intel® ATOM™ N270 (1.6 GHz)			Intel® Core™ Duo P8400 (2.26 GHz) + Intel® GM45 chipset		
2 (1 PCI + 1 PCI Express®)			5 (2 PCI + 3 PCI Express®)		
Flash disk ≥ 60 GB with 5 year warranty (3)	Hard disk ≥ 250 GB	Flash disk ≥ 60 GB with 5 year warranty (3)	Hard disk ≥ 250 GB	Flash disk ≥ 60 GB with 5 year warranty (3)	Hard disk ≥ 250 GB
HMI BUFN D2PF1: 2 GB	1 GB	HMI BPDF D27F1: 4 GB	2 GB	HMI BPDF D57F1: 4 GB	2 GB
HMI BUFN D2P01: 1 GB		HMI BPDF D2701: 2 GB		HMI BPDF D5701: 2 GB	
1					
1 x slide-in compact rack for storage disk (Flash disk or hard disk included) 1 x slide-in rack for DVD-RW drive (included) or storage disk via adaptor (optional)			1 x slide-in compact rack for storage disk (Flash disk or hard disk included) 1 x slide-in rack for DVD-RW drive (supplied) 1 x slide-in rack for storage disk via adaptor (optional)		
2 x Ethernet 10/100/1000 Mbps					
1 x USB 2.0 (1 A) on the front panel + 4 x USB 2.0 (0.5 and 1 A) at the top					
2 x RS232C					
1 x DVI (VGA RGB adaptor, optional)					
1 x RS232C/RS422/RS485, 1 x DVI					
RAID PCI card with 2 redundant hard disks					
Windows® XP Professional SP3			Windows® 7 Ultimate 64-bit		
24 V ~ (± 25%) (4)					
Nominal current 6 A. Typical inrush current 7 A, 50 A < 300 µs					
Vertical, at the back of the enclosure ("book" format) or flat (requiring fan kit HMI YBFKT 21, for BOX PC HMI BU●N D2P●1)					
121 x 270 x 251		136 x 270 x 251		217 x 270 x 251	
Conforming to IEC 61132-2, UL 508: 0 to 50°C (mounted vertically) or 0 to 45°C (mounted flat)					
1.75 mm amplitude from 2 to 9 Hz, 0.5 g from 9 to 200Hz (5)	0.125 g from 5 to 100 Hz	1.75 mm amplitude from 2 to 9 Hz, 0.5 g from 9 to 200Hz (5)	0.125 g from 5 to 100 Hz	1.75 mm amplitude from 2 to 9 Hz, 0.5 g from 9 to 200Hz (5)	0.125 g from 5 to 100 Hz
3.5 mm amplitude from 2 to 9 Hz, 1 g from 9 to 200Hz (5)	0.250 g from 5 to 100 Hz	3.5 mm amplitude from 2 to 9 Hz, 1 g from 9 to 200Hz (5)	0.250 g from 5 to 100 Hz	3.5 mm amplitude from 2 to 9 Hz, 1 g from 9 to 200Hz (5)	0.250 g from 5 to 100 Hz
1 mm from 5 to 13.2 Hz, 0.7 g from 13.2 to 100Hz, 90 minutes endurance	–				
15 g/11 ms conforming to IEC 60068-2-27 test Ea					
CE, cULus (UL 508, CSA 22.2 n°142), cULus Haz Loc Class I Div 2 (ANSI/ISA 12.12.01, UL 1604, CSA 22.2 n°213), ATEX II 3 Dust zone 22, C-Tick, GOST					
With power supply filter HMI YLFI MAR11	–				
The whole range of Magelis iDisplay screens (see page 3/44)					
Vije Designer Run Time Demo (21-day trial version). Unlimited license, to be ordered separately (VJDSNRTMPC)					

HMI BUFN D2PF1	–	HMI BPDF D27F1	–	HMI BPDF D57F1	–
HMI BUFN D2P01	HMI BUHN D2P01	HMI BPDF D2701	HMI BPHD D2701	HMI BPDF D5701	HMI BPHD D5701

3/40

See configured Magelis BOX PC on page 3/42

(4) For an ~ supply voltage, an external Phaseo power supply can be used (see page 3/41).

(5) Conforming to IEC 60068-2-6 Fc.



See more technical information online at www.schneider-electric.com



Universal BOX PC
1 PCI



Universal BOX PC/Performance BOX PC
1 PCI + 1 PCI Express®



Performance BOX PC
2 PCI + 3 PCI Express®

Introduction

The Magelis BOX PC industrial PC product offer includes products that are rugged and certified for automation applications.

With its Universal (1 or 2 PCI slots) and Performance (2 or 5 PCI slots) ranges, this Magelis BOX PC offer is suitable for all types of uses that do not require an integrated screen:

- In a maintenance-free environment: Fanless Magelis BOX PC (unaffected by dust, no filters to clean) and without any rotating parts such as a hard disk. Data storage on Compact Flash card or on Flash disk offers good resistance to vibration and long life.
- In a harsh environment: Magelis BOX PC without hard disk
- In a standard environment: Magelis BOX PC with hard disk

In addition to the referenced offer, the flexibility offered by the modular design allows made-to-order configuration of the Magelis BOX PC (see page 3/42).

This offer is compatible with Magelis iDisplay screens (see page 3/44).

Overview of the range

Universal Magelis BOX PC range (1) (2)

The Universal BOX PC range is equipped with the fanless Intel® ATOM™ N270 processor (1.6 GHz) and DDR2 RAM (3).

It is specifically for the following environments:

- "Maintenance-free" (fanless, with solid-state storage disk):
 - HMI BUCN D1E01:
 - 1 PCI slot/Compact Flash card/Windows® Embedded Standard 2009, etc.
 - HMI BUFN D1P01 and HMI BUFN D1 PF1:
 - 1 PCI slot, Flash disk, Windows® XP Professional SP3, etc.
 - HMI BUFN D2P01 and HMI BUFN D2 PF1:
 - 1 PCI + 1 PCI Express® slot/Flash disk/Windows® XP Professional SP3, etc.
- Standard industrial environments (with hard disk):
 - HMI BUHN D1P01:
 - 1 PCI slot/hard disk/Windows® XP Professional SP3, etc.
 - HMI BUHN D2P01:
 - 1 PCI + 1 PCI Express® slot/hard disk/Windows® XP Professional SP3, etc.

Performance Magelis BOX PC range (1) (2)

The Performance BOX PC range is equipped with the Intel® Core™ 2 Duo P8400 processor (2.26 GHz) + Intel® GM45 chipset and DDR3 RAM (3).

It is specifically for the following environments:

- Harsh industrial environments (with solid-state storage disk):
 - HMI BPDF D2701 and HMI BPDF D27F1:
 - 1 PCI + 1 PCI Express® /Flash disk/Windows® 7 Ultimate 64-bit, etc.
 - HMI BPDF D5701 and HMI BPDF D57F1:
 - 2 PCI + 3 PCI Express® /Flash disk/Windows® 7 Ultimate 64-bit, etc.
- Standard industrial environments (with hard disk):
 - HMI BPHD D2701:
 - 1 PCI + 1 PCI Express® /hard disk/Windows® 7 Ultimate 64-bit, etc.
 - HMI BPHD D5701:
 - 2 PCI + 3 PCI Express® /hard disk/Windows® 7 Ultimate 64-bit, etc.

(1) Types of PCI slot: Half-format PCI 2.2 and half-format PCI Express® (1x for Magelis BOX PC 1 or 5 slots, 4x for Magelis BOX PC 2 slots).

(2) For description, see pages 3/38 and 3/39.

(3) Not user-expandable; increased capacity available in made-to-order configuration (see page 3/42).

Introduction (continued)

Overview of the range (continued)

Made-to-order Magelis BOX PC range (1)

On Universal and Performance Magelis BOX PC bases, it is possible to customize the CPU by selecting the:

- Capacity of the Compact Flash card and the RAM
- Number of PCI and PCI Express® slots
- Operating system and dedicated HMI software
- Additional assembled options: PCI RAID card with 2 redundant hard disks (2), battery-backed power supply interface module, etc.

For this HMI PCCB1 offer see page 3/42.

(1) Types of PCI slot: Half-format PCI 2.2 and half-format PCI Express® (1x for Magelis BOX PC 1 or 5 slots, 4x for Magelis BOX PC 2 slots).

(2) Operating temperature details available on our website www.schneider-electric.com.

Industrial PCs

Magelis iPCs certified for automation

Magelis BOX PC

Universal and Performance ranges



Front panel of Magelis BOX PC, door open
1 PCI slot

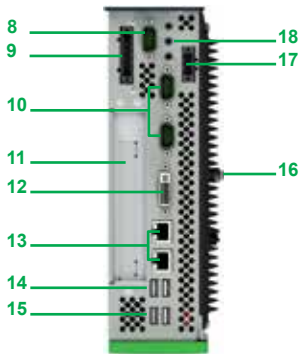

Top panel of Magelis BOX PC
1 PCI slot

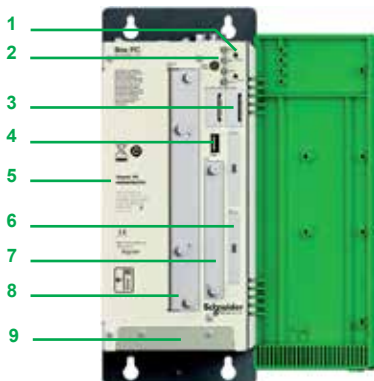

Front panel of Magelis BOX PC, door open
2 PCI slots

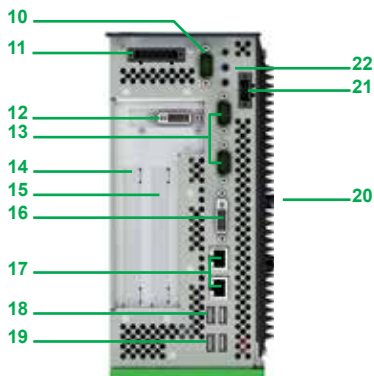

Top panel of Magelis BOX PC
2 PCI slots

Description

Universal Magelis BOX PC CPUs, 1 PCI slot

Front panel, door open

- 1 2 push buttons: 1 for the power supply and 1 for resetting
- 2 4 status and power supply LEDs, also visible with the front panel door closed
- 3 Battery
- 4 USB 2.0 port (1 A max.)
- 5 Identification (reference, serial number, etc.)
- 6 Slot for Compact Flash card:
 - With Compact Flash (SLC technology) \geq 4GB (BOX PC HMI BUCN D1E01)
 - Free slot (BOX PC HMI BUFN D1P●1, BOX PC HMI BUHN D1P01)
- 7 Slide-in compact rack:
 - Free slot (BOX PC HMI BUCN D1E01)
 - With Flash disk (1) (SLC technology SSD) \geq 60 GB (BOX PC HMI BUFN D1P●1)
 - With hard disk \geq 250 GB (BOX PC HMI BUHN D1P01)

Top panel

- 8 Free slot for additional RS232C/RS422/RS485 serial link interface (HMI YBIN SL 11) (2)
- 9 Free slot for battery-backed power supply interface module (3)
- 10 2 RS232C ports
- 11 Half-format PCI 2.2 slot
- 12 DVI port - RGB connection with adaptor (HMI YAD DVI RGB 11) (2)
- 13 2 Ethernet 10/100/1000 Mbps ports
- 14 2 USB 2.0 ports (0.5 A max.)
- 15 2 USB 2.0 ports (1 A max.)
- 16 Heat sink (4)
- 17 Connector for the CPU 24 V $\overline{\text{---}}$ /6 A power supply (5)
- 18 Micro input, line input/line output

Universal and Performance Magelis BOX PC CPUs, 2 PCI slots

Front panel, door open

- 1 2 push buttons: 1 for the power supply and 1 for resetting
- 2 4 status and power supply LEDs, also visible with the front panel door closed
- 3 Battery
- 4 USB 2.0 port (1 A max.)
- 5 Identification (reference, serial number, etc.)
- 6 Free slot for Compact Flash card
- 7 Slide-in compact rack:
 - With Flash disk (1) (SLC technology SSD) \geq 60 GB (BOX PC HMI B●F● D2●●1)
 - With hard disk \geq 250 GB (BOX PC HMI B●H● D2●●01)
- 8 Slide-in rack with the DVD-RW drive included (6). Can be used for an additional storage disk with adaptor (HMI YAD SLIDEIN 11) (2)
- 9 Access to the fan filters (7) (BOX PC HMI BP●D D●7●1)

Top panel

- 10 Free slot for additional RS232C/RS422/RS485 serial link interface (HMI YBIN SL 11) (2)
- 11 Free slot for battery-backed power supply interface module (3)
- 12 Free slot for additional DVI interface (HMI YIN DVI RGB 11) (2)
- 13 2 RS232C ports
- 14 Half-format PCI Express® 4x slot
- 15 Half-format PCI 2.2 slot
- 16 DVI port - RGB connection with adaptor (HMI YAD DVI RGB 11) (2)
- 17 2 Ethernet 10/100/1000 Mbps ports
- 18 2 USB 2.0 ports (0.5 A max.)
- 19 2 USB 2.0 ports (1 A max.)
- 20 Heat sink (4)
- 21 Connector for the CPU 24 V $\overline{\text{---}}$ /6 A power supply (5)
- 22 Micro input, line input/line output

(1) Flash disk (SSD) with manufacturer's 5 year warranty. Please consult our Customer Care Center.

(2) To be ordered separately (see page 3/41).

(3) To be ordered separately in made-to-order configuration (see page 3/42).

(4) For installation, please refer to the "product data sheet" on our website www.schneider-electric.com.

(5) Consumption excluding additional PCI card. For an \sim supply voltage, an external Phaseo power supply can be used (see page 3/41).

(6) Operating temperature details available on our website www.schneider-electric.com.

(7) Fans can be replaced by the user using the BOX PC fan kit (to be ordered separately, see page 3/41).

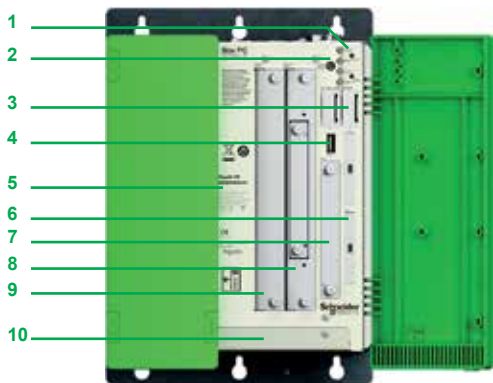

Front panel of Magelis BOX PC, door open
5 PCI slots

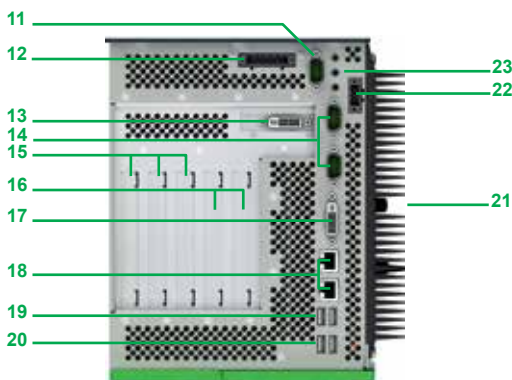

Top panel of Magelis BOX PC
5 PCI slots

Description (continued)

Performance Magelis BOX PC CPUs, 5 PCI slots

Front panel, door open

- 1 2 push buttons: 1 for the power supply and 1 for resetting
- 2 4 status and power supply LEDs, also visible with the front panel door closed
- 3 Battery
- 4 USB 2.0 port (1 A max.)
- 5 Identification (reference, serial number, etc.)
- 6 Free slot for Compact Flash card
- 7 Slide-in compact rack:
 - With Flash disk (1) (SLC technology SSD) ≥ 60 GB (BOX PC HMI BPF D5701)
 - With hard disk ≥ 250 GB (BOX PC HMI BPHD D5701)
- 8 Slide-in rack with the DVD-RW drive included (2)
- 9 Slide-in rack for additional storage disk with adaptor (HMI YAD SLIDEIN 11) (3)
- 10 Access to the fan filters (4)

Top panel

- 11 Free slot for additional RS232C/RS422/RS485 serial link interface (HMI YBIN SL 11) (3)
- 12 Free slot for battery-backed power supply interface module (5)
- 13 Free slot for additional DVI interface (HMI YIN DVI RGB 11) (3)
- 14 2 RS232C ports
- 15 3 half-format PCI Express® 1x slots
- 16 2 half-format PCI 2.2 slots
- 17 DVI port - RGB connection with adaptor (HMI YAD DVI RGB 11) (2)
- 18 2 Ethernet 10/100/1000 Mbps ports
- 19 2 USB 2.0 ports (0.5 A max.)
- 20 2 USB 2.0 ports (1 A max.)
- 21 Heat sink (6)
- 22 Connector for the CPU 24 V $\overline{\text{---}}$ /6 A power supply (7)
- 23 Micro input, line input/line output

(1) Flash disk (SSD) with manufacturer's 5 year warranty. Please consult our Customer Care Center.

(2) Operating temperature details available on our website www.schneider-electric.com.

(3) To be ordered separately (see page 3/42).

(4) Fans can be replaced by the user using the BOX PC fan kit (to be ordered separately, see page 3/42).

(5) To be ordered separately in made-to-order configuration (see page 3/42).

(6) Refer to the installation precautions available on our website www.schneider-electric.com.

(7) Consumption excluding additional PCI card. For an \sim supply voltage, an external Phaseo power supply can be used (see page 3/42).



HMI BU•N D1••1

Universal Magelis BOX PC, 1 or 2 PCI slots

(Intel® ATOM™ N270 processor (1.6 GHz)/DDR2 RAM/24 V --- supply voltage) (1)

PCI slot	Operating system	Software	Storage disk	DDR2 RAM (5)	Reference	Weight kg
For maintenance-free environment						
1 PCI	Windows® Embedded Standard 2009 (2)	Vijeo Designer RT Demo (3)	Compact Flash ≥ 4 GB	1 GB	HMI BUCN D1E01	4.000
	Windows® XP Professional SP3	Vijeo Designer RT Demo (3)	Flash disk ≥ 60 GB with 5 year warranty (4)	1 GB	HMI BUFN D1P01	4.000
1 PCI + 1 PCI Express®	Windows® XP Professional SP3	Vijeo Designer RT Demo (3)	Flash disk ≥ 60 GB with 5 year warranty (4)	2 GB	HMI BUFN D1PF1	4.000
		Vijeo Designer RT Demo (3) Vijeo Citect Full 500 I/O	Flash disk ≥ 60 GB with 5 year warranty (4)	1 GB	HMI BUFN D2P01	5.000
1 PCI + 1 PCI Express®	Windows® XP Professional SP3	Vijeo Designer RT Demo (3)	Flash disk ≥ 60 GB with 5 year warranty (4)	2 GB	HMI BUFN D2PF1	5.000
		Vijeo Designer RT Demo (3) Vijeo Citect Full 500 I/O	Flash disk ≥ 60 GB with 5 year warranty (4)	1 GB	HMI BUHN D1P01	4.000

For standard industrial environment

1 PCI	Windows® XP Professional SP3	Vijeo Designer RT Demo (3)	Hard disk ≥ 250 GB	1 GB	HMI BUHN D1P01	4.000
1 PCI + 1 PCI Express®	Windows® XP Professional SP3	Vijeo Designer RT Demo (3)	Hard disk ≥ 250 GB	1 GB	HMI BUHN D2P01	5.000

Performance Magelis BOX PC, 2 or 5 PCI slots

(Intel® Core™ 2 Duo P8400 processor (2.26 GHz) / DDR3 RAM / 24 V --- supply voltage) (1)

PCI slot	Operating system	Software	Storage disk	DDR3 RAM (5)	Reference	Weight kg
For standard industrial environment						
1 PCI + 1 PCI Express®	Windows® 7 Ultimate 64-bit	Vijeo Designer RT Demo (3)	Hard disk ≥ 250 GB	2 GB	HMI BPHD D2701	6.000
2 PCI + 3 PCI Express®	Windows® 7 Ultimate 64-bit	Vijeo Designer RT Demo (3)	Hard disk ≥ 250 GB	2 GB	HMI BPHD D5701	7.000
For harsh industrial environment						
1 PCI + 1 PCI Express®	Windows® 7 Ultimate 64-bit	Vijeo Designer RT Demo (3)	Flash disk ≥ 60 GB with 5 year warranty (4)	2 GB	HMI BPDF D2701	6.000
		Vijeo Designer RT Demo (3) Vijeo Citect Full 500 I/O	Flash disk ≥ 60 GB with 5 year warranty (4)	4 GB	HMI BPDF D27F1	6.000
2 PCI + 3 PCI Express®	Windows® 7 Ultimate 64-bit	Vijeo Designer RT Demo (3)	Flash disk ≥ 60 GB with 5 year warranty (4)	2 GB	HMI BPDF D5701	7.000
		Vijeo Designer RT Demo (3) Vijeo Citect Full 500 I/O	Flash disk ≥ 60 GB with 5 year warranty (4)	4 GB	HMI BPDF D57F1	7.000



HMI BU•N D2P•1
HMI BP•D D27•1



HMI BP•D D57•1

(1) For an ~ supply voltage, an external Phaseo power supply can be used (see page 3/41).

(2) Windows® Embedded Standard 2009 supplied in 9 languages (English, French, German, Italian, Portuguese, Spanish, Swedish, Chinese, Russian). Also includes:

- Acrobat Reader, Word/Excel/Power Point Viewer
- Framework.Net 3.5
- Web browser
- Vijeo Citect Web Client
- Vijeo Designer Run Time Demo (3)

(3) Vijeo Designer RT (Run Time) Demo (21-day trial version). Unlimited license, to be ordered separately (VJDSNRTMPC) (see page 3/41).

(4) For general conditions of manufacturer's 5 year warranty: please consult our Customer Care Center.

(5) Memory capacity not user-expandable; increased capacity available in made-to-order configuration (see page 3/41).

Magelis™ Human/Machine Interfaces

Industrial PCs

Magelis iPCs certified for automation
Magelis BOX PC
Separate components

Separate components

Description	Details	Compatible with Magelis BOX PC ranges:		Reference	Weight kg
		Universal	Performance		
Storage disks, peripheral equipment, kits					
Hard disk	250 GB, blank	All models		HMI YHDD 0250 11	–
Flash disk with 5 year warranty (1)	60 GB, blank	All models		HMI YSDD 0060 11	–
Compact Flash card (SLC technology)	2 GB, blank	All models		HMI YCF S02 11	–
	4 GB, blank	All models		HMI YCF S04 11	–
	8 GB, blank	All models		HMI YCF S08 11	–
DVD-RW drive for slide-in rack (2)	CD-RW and DVD-RW reader/writer	BOX PC, 2 PCI and 5 PCI slots		HMI YDR DVDRW 11	–
Slide-in adaptor for storage disk	Used to insert a hard disk or an SSD Flash disk in a slide-in rack	BOX PC, 2 PCI and 5 PCI slots		HMI YAD SLIDEIN 11	–
Additional DVI interface	Provides a second DVI interface	BOX PC, 2 PCI and 5 PCI slots		HMI YIN DVI RGB 11	–
DVI/VGA RGB adaptor	For connecting an RGB screen to the integrated DVI port	All models		HMI YAD DVI RGB 11	–
RAID PCI card with 2 redundant hard disks (2)	PCI card equipped with two 250 GB redundant hard disks	All models		HMI YRAID PCI 11	–
Hard disk for RAID PCI card	Replacement hard disk for RAID PCI card HMI YRAID PCI 11	BOX PC + RAID PCI card HMI YRAID PCI 11		HMI YRAID D0250 11	–
Additional serial link interface	RS232C/RS422/RS485 serial link	All models		HMI YBIN SL 11	–
Backup power supply kit	Provides an uninterruptible power supply. Includes: ■ 1 backup battery ■ 1 x 3 m cordset	Magelis BOX PC configured with battery-backed power supply interface module (3)		HMI YUPS KT 11	–
Power supply filter for marine certification	Necessary for compliance with marine certification.	BOX PC: HMI BUCN D1E01 and HMI BUFN D●P●1	–	HMI YLFI MAR 11	–
Maintenance kit for BOX PC	Includes: ■ 1 x 3-way removable connector for 24 V $\overline{\text{---}}$ power supply ■ 15 replacement filters for fan, including: □ 5 for Magelis BOX PC - 1 PCI □ 5 for Magelis BOX PC - 2 PCI □ 5 for Magelis BOX PC - 5 PCI	All models		HMI YBMKT 11	–
Fan kit for BOX PC	Enables: ■ Replacement of fans by the user ■ Flat mounting of fanless Magelis BOX PC (4)	BOX PC, 1 PCI		HMI YBFKT 11	–
		BOX PC, 2 PCI		HMI YBFKT 21	–
		BOX PC, 5 PCI		HMI YBFKT 51	–
Software					
Vijeo Designer Run Time license for 1 workstation	Converts the 21-day trial version of Vijeo Designer Run Time Demo to an unlimited license.	All models		VJD SNR TMPC	–
Intelligent Data Service license extension for Vijeo Designer Run Time for 1 workstation	Used to track the process variables and all operator actions, and offers visibility of the key process values	All models (requires storage capacity \geq 4 GB)		VJD SNT RCK V60M	–
External Phaseo power supply					
Phaseo regulated switch mode power supply ABL 8 Rail mounting	Input voltage: 100 to 120 V/200 to 500 V \sim (5) Output voltage: 24 V $\overline{\text{---}}$ Power: 120 W	All models		ABL 8RPS24050 (6) (7)	0.700
Phaseo regulated switch mode power supply ABL 4 Rail mounting	Input voltage: 100 to 230 V \sim (5) Output voltage: 24 V $\overline{\text{---}}$ Power: 120 W	All models		ABL 4RSM24050 (6) (7)	0.500

(1) For general conditions of manufacturer's 5 year warranty: please consult our Customer Care Center.

(2) Operating temperature details available on our website www.schneider-electric.com.

(3) For configured Magelis BOX PC see page 3/41.

(4) Operating temperature for flat mounting: 0 to 45°C (see page 3/34).

(5) Single-phase connection. Phase-to-phase connection possible on certain American line supplies, please consult our Customer Care Center.

(6) If adding a PCI card, you need to select a Phaseo power supply with a power rating suitable for the extra consumption. Please consult the "Phaseo power supply and transformer" catalog on our website www.schneider-electric.com.

(7) To order this reference, please consult our Customer Care Center.

Configured Magelis BOX PC industrial PC

With the “configured iPC” service, Schneider Electric offers multiple configuration combinations for Magelis iPCs.

This service, available exclusively from our Customer Care Center, allows users to configure a certified product suitable for specific automation applications and environments, based on Universal and Performance Magelis BOX PCs.

Our Customer Care Center draws up the:

- Complete parts list for the configured Magelis BOX PC
- Selling price
- Complete reference (root + code which varies according to the configuration)
- Purchase order

Ordering procedure for a configured Magelis BOX PC

- 1 Please consult our Customer Care Center.
- 2 State the reference root **HMI PCCB1** corresponding to a request for a configured Magelis BOX PC. It will be completed with the variable part of the reference, once configuration is complete.
- 3 Configure your Magelis BOX PC (see table below).
- 4 Confirm your order.

References

Description	Reference	Weight kg
Configured Magelis BOX PC (1)	Reference root to be stated to our Customer Care Center. The configuration should be made up from the components below.	HMI PCCB1 (2) –

Description	Available on Magelis BOX PC base		Reference	Weight kg
	Universal	Performance		
	Processor Intel® ATOM™ N270 (1.6 GHz)	Intel® Core™ 2 Duo P8400 processor (2.26 GHz)		
	DDR2 RAM	DDR3 RAM		
	Supply voltage 24 V ~ supply voltage	24 V ~ supply voltage		
RAM	3 GB max. (DDR2)	8 GB max. (DDR3)	(2)	–
Peripheral storage devices	Compact Flash card 8 GB max. (SLC technology)			
	Up to 2 Flash disks ≥ 60 GB with 5 year warranty (3)			
	Up to 2 hard disks ≥ 250 GB			
Other peripheral device	DVD-RW drive			
PCI slot configuration	1 PCI or 1 PCI Express®			
	1 PCI + 1 PCI Express® or 2 PCI			
	2 PCI + 3 PCI Express® or 4 PCI + 1 PCI Express®			
Operating systems	Windows® Embedded Standard 2009			
	Windows® Embedded Standard 7 32-bit			
	Windows® XP PRO SP3			
	Windows® 7 Ultimate 32-bit			
	Windows® 7 Ultimate 64-bit			
Software	Vijeo Designer Run Time			
	Vijeo Citect			
Assembled options	RAID PCI card with 2 redundant hard disks			
	Interface module for backup power supply required for the HMI YUPS KT 11 backup power supply kit (see page 3/41)			
	Additional RS232C/RS422/RS485 serial link interface			
	Additional DVI interface (needs a configuration with 2 or 5 PCI slots)			

(1) Please consult our Customer Care Center.

(2) The reference of configured Magelis BOX PC industrial PCs is made up of a root (HMI PCCB1) followed by a variable part generated during configuration.

(3) For general conditions of manufacturer's 5 year warranty: please consult our Customer Care Center.

Old industrial PCs		Replaced by Magelis BOX PCs	
Description	Reference	Description	References
Magelis Smart BOX		Magelis BOX PC (1 PCI slot)	
Magelis Smart BOX 100 to 240 V ~	MPC SN0 1NAJ 00T	Universal Magelis BOX PC	HMI BUCN D1E01 + Phaseo power supply (1)
Magelis Smart BOX 24 V ---	MPC SN0 1NDJ 00T	Universal Magelis BOX PC	HMI BUCN D1E01
Magelis Compact PC BOX (1 PCI slot)		Magelis BOX PC (1 PCI slot)	
Magelis Compact PC BOX 100 to 240 V ~	MPC KN0 2NAX 00N	Universal Magelis BOX PC	HMI BUHN D1P01 + Phaseo power supply (1)
Magelis Flex PC BOX F (2 PCI slots)		Magelis BOX PC (2 PCI slots)	
Magelis Flex PC BOX (Celeron M) 100 to 240 V ~	MPC FN0 2NAX 00N	Universal Magelis BOX PC	HMI BUHN D2P01 + Phaseo power supply (1)
Magelis Flex PC BOX (Celeron M) 24 V ---	MPC FN0 2NDX 00N	Universal Magelis BOX PC	HMI BUHN D2P01
Magelis Flex PC BOX (Core Duo) 100 to 240 V ~	MPC FN0 5NAX 00N	Performance Magelis BOX PC	HMI BPHD D2701 + Phaseo power supply (1)
Magelis Flex PC BOX (Core Duo) 24 V ---	MPC FN0 5NDX 00N	Performance Magelis BOX PC	HMI BPHD D2701
Magelis Flex PC BOX (Core Duo) 100 to 240 V ~	MPC FN0 5MAX 00N	Performance Magelis BOX PC	HMI BPDF D2701 + Phaseo power supply (1)
Magelis Flex PC BOX (Core Duo) 100 to 240 V ~ Vijeo Citect Full 500 I/O	MPC FN0 5MAX 00V	Performance Magelis BOX PC Vijeo Citect Full 500 I/O	HMI BPDF D27F1 + Phaseo power supply (1)
Magelis Flex PC BOX H (4 PCI slots)		Magelis BOX PC (5 PCI slots)	
Magelis Flex PC BOX (Celeron M) 100 to 240 V ~	MPC HN0 2NAX 00N	Performance Magelis BOX PC	HMI BPHD D5701
Magelis Flex PC BOX (Core Duo) 100 to 240 V ~	MPC HN0 5NAX 00N	Performance Magelis BOX PC	HMI BPHD D5701 + Phaseo power supply (1)
Magelis Flex PC BOX (Core Duo) 100 to 240 V ~ with backup battery	MPC HN0 5NBX 00N	Configured Magelis BOX PC (2)	HMI PCCB 1B5CB26K10N + kit HMI YUPS KT11 + Phaseo power supply (1)
Magelis Flex PC BOX (Core Duo) 24 V ---	MPC HN0 5NDX00N	Performance Magelis BOX PC	HMI BPHD D5701
Magelis Flex PC BOX (Core Duo) 100 to 240 V ~	MPC HN0 5MAX 00N	Performance Magelis BOX PC	HMI BPDF D5701 + Phaseo power supply (1)
Magelis Flex PC BOX (Core Duo) 100 to 240 V ~ Vijeo Citect Full 500 I/O	MPC HN0 5MAX 00V	Performance Magelis BOX PC Vijeo Citect Full 500 I/O	HMI BPDF D57F1 + Phaseo power supply (1)

(1) ABL 8RPS24050 or ABL 4RSM24050 Phaseo power supply (see page 3/41).

(2) See page 3/42



3

Industrial PCs	Magelis iDisplay flat screens	
Model	15" touch screens	15" touch screen and keypad



Screen	Type	15" color TFT LCD		
	Definition	XGA 1024 x 768		
	Number of colors	16,777,216		
	Brightness	≥ 200 cd/m ² adjustable		
	Backlighting service life	50,000 hours		
Touch screen		Analog resistive, 35 million cycles		
Keypad		–	70 standard IBM keys 2 x 20 user function keys	
I/O ports	On the front panel	1 x USB 2.0 type A		
	Other	1 x VGA video (analog RGB, 15-way male SUB-D) 1 x DVI-D video (analog RGB, 24-way male DVI-D) 1 x USB 2.0 type B 1 x COM1 (RS 232C, 9-way male SUB-D)		
Standards and certifications	UL 508, CSA, IEC 61131-2	cULus Haz Loc Class I Div 2 (ANSI/ISA 12.12.01, UL 1604, CSA 22.2 n° 213)	UL 1604, UL 508, IEC 61131-2	
Supply voltage	100 to 240 V ~ (98 to 264 V), according to EN 61131-2	24 V = (19,2 to 28,8 V)	100 to 240 V ~	
Consumption	120 VA max.	17 A (typical inrush current 30 A max.)	200 VA max.	
Degree of protection	IP65 for the front of the screen IP 20 for the sides and back of the screen			
Dimensions	Overall dimensions (W x H x D)	395 x 294 x 60 mm	483 x 365 x 31 mm	
	Cut-out (W x H)	383.5 x 282.5 (+1, -0) mm	441.5 x 313.5 (+1, -0) mm	
Environment	Operating temperature	0 to 50°C, according to EN 61131-2 and UL		
	Vibration resistance	Conforming to JIS B 3501 and IEC 61131-2 standards: ■ 5 to 9 Hz, 3.5 mm mounted amplitude ■ 9 to 150 Hz: constant acceleration of 1 g (9.8 m/s ²) ■ X, Y, Z directions tested 10 times (100 minutes)		
Type	MPC YT5 0NAN 00N	HMI DID 7DT0	MPC NB5 0NAN 00N	
Pages	3/47			



Magelis iDisplay flat screens

19" touch screen



19" color TFT LCD

SVGA 1280 x 1024

16,777,216

≥ 200 cd/m² adjustable

50,000 hours

Analog resistive, 35 million cycles

–

1 x USB 2.0 type A

1 x VGA video (analog RGB, 15-way male SUB-D)

1 x DVI-D video (analog RGB, 24-way male DVI-D)

1 x USB 2.0 type B

1 x COM1 (RS 232C, 9-way male SUB-D)

UL 508, CSA, IEC 61131-2

100 to 240 V ~ (85 to 265 V), according to EN 61131-2

200 VA max.

IP65 for the front of the screen

IP 20 for the sides and back of the screen

460 x 390 x 65 mm

419.5 x 352.5 (+1, -0) mm

0 to 50°C, according to EN 61131-2 and UL

Conforming to JIS B 3501 and IEC 61131-2 standards:

- 5 to 9 Hz, 3.5 mm mounted amplitude
- 9 to 150 Hz: constant acceleration of 1 g (9.8 m/s²)
- X, Y, Z directions tested 10 times (100 minutes)

MPC YT9 0NAN 00N

3/47



See more technical information online at www.schneider-electric.com

Magelis™ Human/Machine Interfaces

Industrial PCs

Magelis iDisplay screens certified for automation
15" and 19" flat screens

3

Introduction

Magelis iDisplay screens are monitors with industrial flat screens designed for use in conjunction with PCs.

Two screen sizes are available: 15" and 19" to suit various requirements.

Featuring the latest TFT LCD technology, these iDisplay screens offer top class viewing and extended service life. Their touch screen interface enables easy creation of user-friendly and high performance HMI interfaces.

The Magelis iDisplay screen **MPC NB5 0NAN 00N** also has a 70-key (standard IBM) keypad and user function keys (2 x 20 keys).

Certified in accordance with PLC product standards, designed for use in severe industrial environments, and offering an excellent screen size/dimensions ratio, they can be installed easily on most equipment. They are suitable for use in many different environments.

15" Magelis iDisplay screens have the same cut-out dimensions as 15" Magelis Panel PCs, which makes it easy to upgrade installations.



MPC NB5 0NAN 00N

Architecture

Magelis iDisplay screens are compatible with Magelis BOX PC industrial PCs.

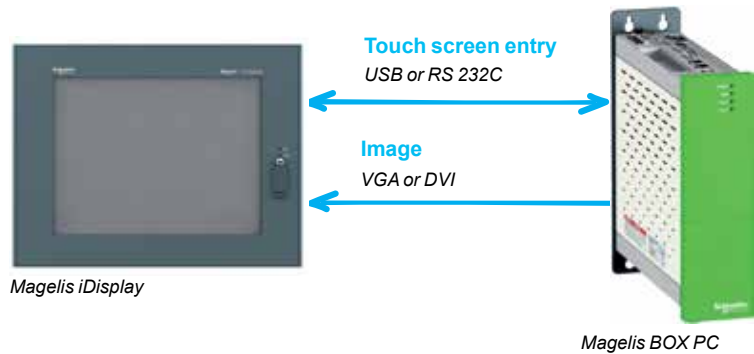

References					
Description	Screen	Interface	Supply voltage	Reference	Weight kg
Flat screen for flush mounting, IP65 front panel	15", XGA (1024 x 768)	Touch	100 to 240 V ~	MPC YT5 0NAN 00N (1)	–
		Touch	24 V ---	HMI DID 7DT0 (2)	–
	Touch and keypad	100 to 240 V ~	MPC NB5 0NAN 00N (1)	–	
	19", SXGA (1280 x 1024)	Touch	100 to 240 V ~	MPC YT9 0NAN 00N (1)	–

Separate parts				
Description	For	Reference	Weight kg	
Maintenance kit: mounting brackets + seals	Magelis iPC 15"	MPC YK5 0MNT KIT	–	
	Magelis iPC 19"	MPC YK9 0MNT KIT	–	
Protective films for screen: 5 peel-off films	Magelis iPC 15"	MPC YK5 0SPS KIT	–	
	Magelis iPC 19"	MPC YK9 0SPS KIT	–	
Extra long cable (10 m) for connection with Magelis BOX PC and Magelis Panel PC industrial PCs	Magelis iPC 15" only	HMI CAB DVI1011	–	

Mounting

Magelis iDisplay flat screens can be mounted on a panel or enclosure door using the mounting parts (3 x 4 spring clips) supplied with each screen.

(1) Supplied with 3 m VGA cable

(2) Supplied with 5 m DVI-D cable

4.1 - HMI configuration software

Selection guide4/2

- Vijeo™ Designer™ Lite
 - Introduction4/4
 - Vijeo Designer Lite configuration software4/7
- Vijeo Designer
 - Introduction4/8
 - Vijeo Designer configuration software4/13

Applications

Traditional architecture, HMI executed on PC platform or dedicated terminal
 Configuration software for operator dialog applications



Compatible products	Type
	Maximum number of targets
	Operating system on terminals

Magelis™ XBT N/R/RT Small Panels (1)
1
Proprietary Magelis

Functions	Reading/writing of PLC variables
	Display of variables
	Data processing
	Sharing of variables between HMI applications
	Saving of variables to external database

Yes
Yes
–
–
–

Internationalization

–

Development of graphic applications	Native library of graphic objects
	Curves and alarms
	Scripts

Yes
Yes (2)
–

Communication between HMI application and PLCs

Via I/O drivers: Schneider Electric or third party protocols (Mitsubishi, Omron, Rockwell Automation, Siemens) (3)

Uploading of applications

Yes

Simulation of HMI applications

Yes

Recipe management

–

Report and barcode printing

–

Screen capture

–

Access security

Linked to user profiles

Interface languages

Screens, online help and documentation in electronic format available in 6 languages: English, French, German, Italian, Simplified Chinese and Spanish

OS compatibility

Windows XP Professional, Windows Vista Business (32-bit), Windows 2000 Professional

Software type

Vijeo Designer™ Lite

Page

4/7

(1) All Magelis XBT and Magelis GTO terminals behave transparently on restoration of power.
 (2) Depending on compatible product.
 (3) See protocols supported on page 4/6.
 (4) See protocols supported on page 4/12.

Traditional architecture, HMI executed on PC platform or dedicated terminal

Configuration software for operator dialog applications



Magelis™ STO/STU Small Panels
Magelis™ XBT GT/GK/GH/GTW and Magelis™ GTO Advanced Panels (1)
Magelis™ industrial PCs

32

Proprietary for Magelis STO/STU, Magelis XBT GT/GK/GH and Magelis GTO
Windows XP embedded for Magelis GTW

Yes, up to 8000 internal and external variables

Yes

Yes, using expression editor or Java programming

Up to 300 variables between 8 terminals, without router PLC
Proprietary protocol above TCP/IP

Yes, with the Intelligent Data Service extension

Up to 15 languages supported by 34 western alphabets, 4 Asian alphabets and 2 middle eastern alphabets embedded in the application

Yes

Yes, with log

Java

Via I/O drivers: Schneider Electric or third party protocols (Mitsubishi, Omron, Rockwell Automation, Siemens) (4)

Yes

Yes

Yes, up to 32 groups, 1024 ingredients for 256 recipes per group, proprietary or CSV format, complete multilingual support for labels and ingredients

On the fly alarms, log data. Up to 9999 active alarms, record or logs

Main barcode types supported: UPC-A, UPC-E, JAN/EAN8, JAN/EAN13, ITF, CODE39, CODE93, CODE128, CODABAR (NW-7)

Yes, for Magelis XBT GT (XBT GT 1105 and higher), Magelis GTO and Magelis industrial PCs. JPEG format

Linked to user profiles

Screens, online help and documentation in electronic format available in 7 languages: English, French, German, Italian, Brazilian Portuguese, Simplified Chinese and Spanish

Windows XP Professional, Windows 7 Business (32-bit and 64-bit)

Vijeo Designer™

4/13





Vijeo Designer Lite software

Introduction

Vijeo Designer™ Lite configuration software allows you to create operator dialog applications for Magelis™ XBT N/R/RT Small Panels for controlling simple automation systems.

For operator dialog terminals Magelis™ STO/STU Small Panels and Magelis™ GT/GTO/GK/GH/GTW Advanced Panels, refer to the Vijeo Designer configuration software on pages 4/8 to 4/10.

Vijeo Designer Lite has been designed with simplicity in mind and is inspired by the same user-friendly philosophy as Vijeo Designer. The primary aim of Vijeo Designer Lite is to show users – who have not had any prior training – how to create applications. It does this by adopting an intuitive approach to operation and providing advice in the form of wizards.

Vijeo Designer Lite is used to design page content in WYSIWYG (*What You See Is What You Get*) format: everything created using this software is displayed in exactly the same way as it appears on the dialog terminal screen.

Since Vijeo Designer Lite is capable of simultaneously defining, within the same project, as many versions in different languages as the terminal's memory can support, users have the option of globalizing their applications.

The interface and documentation for Vijeo Designer Lite are available in 6 languages: English, French, German, Italian, Simplified Chinese and Spanish.

Since applications created with Vijeo Designer Lite are independent of the communication protocol used, the same application can be used with various PLCs offered by major suppliers.

Vijeo Designer Lite works on compatible PCs with Windows 2000, XP or Vista operating software.

Configuration

With Vijeo Designer Lite configuration software, operator dialog applications can be developed quickly and easily using its very simple and user-friendly tools.

The development environment has two main windows:

- Application browser: This is a logical guide to designing applications. All project-related information can be clearly displayed at any time.
- Dialog view: This displays the contextual information for the selection made in the application browser. This information is arranged on a tab.

Vijeo Designer Lite applications have different types of pages:

- Application pages, which can be interlinked
- Alarm pages
- Preconfigured system pages

Pages can contain text or bitmaps, as well as all kinds of variables and graphic objects.

Applications can be configured without dialog boxes. Instead of dialog boxes, preconfigured lists of parameters are available to help users make their selections and avoid errors.

Vijeo Designer Lite comes with a toolset:

- Graphics editor
- Library of pictograms and symbols
- Editor for linking to PLC variables
- Simulator
- Application printing

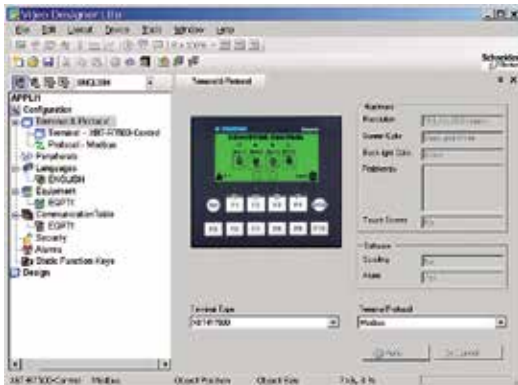

Example project

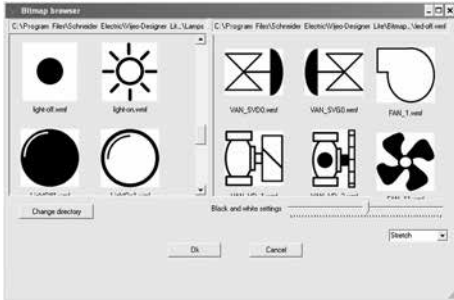

Symbols library



Communication table

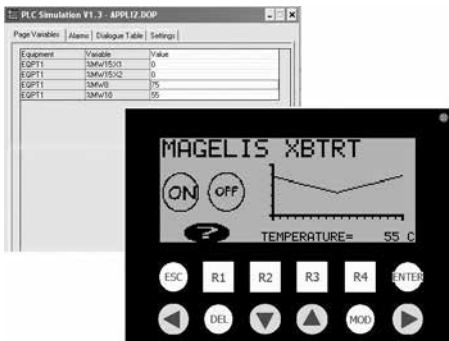

Simulation

Graphics editor

The graphics editor in Vijeo Designer Lite makes it easy for developers of operator dialog applications to create pages based on objects:

- Point, line, rectangle, ellipse
- Text and image
- Graphic, trending curve, button, light
- Enumerated list and scrolling text

Symbols library

The symbols library makes the process of creating pages more efficient. It contains pictograms which are easily recognizable within industrial contexts as well as drawings of the main components used in automation.

With Vijeo Designer Lite, the linking of these graphic symbols to the function keys of the terminal is instantaneous.

Links with PLC variables

Vijeo Designer Lite also enables the user to easily link symbols with the internal variables of Schneider Electric PLCs by importing Twido Soft, PL7 and Concept automation database files.

Communication table

The communication table in Vijeo Designer Lite provides the user with an easy way of configuring all data exchanged between the Magelis compact XBT terminal and the main device.

The communication table is also used to define:

- Access to data: read/write
- All the alarm conditions

Simulator

Vijeo Designer Lite makes it possible to simulate the entire operator dialog application at design office level without using a Magelis compact terminal or a PLC. The simulator program can be used to thoroughly check the following application specifications:

- Navigation between pages
- Entry of variable data
- Display of variables
- Display of alarms

Application printing

You can print all or part of the HMI application using the Vijeo Designer Lite print function. It is possible to send the data to a printer or to print to file.

Protocols for communication between the HMI application and the PLCs

Communication between the operator dialog application and the connected control equipment is established using a communication protocol (driver), which is selected when creating the application in Vijeo Designer Lite.

Schneider Electric protocols

Vijeo Designer Lite supports the following Schneider Electric protocols:

- Modbus RTU Master/Slave
- Unitelway
- Zelio Logic

Third-party protocols

Vijeo Designer Lite supports the following third-party protocols:

- Mitsubishi:
 - Melsec FX protocol (CPU)
- Omron:
 - Sysmac protocols
- Rockwell Automation:
 - Allen Bradley protocols: DF1-Full Duplex, RS DataHighway 485
- Siemens:
 - Simatic PPI protocols



VJD SUD TMS V13M

References

Licenses for the Vijeo Designer Lite configuration software listed below consist of a CD-ROM containing:

- Vijeo Designer Lite V1.3 software
- User documentation in electronic format
- The communication protocols described on page 4/6
- XBT L1001 development software for converting existing XBT applications

Single-station licenses

Description	License type	Application transfer cable		Reference	Weight kg
		PC side port	Magelis terminal side		
Vijeo Designer Lite configuration software	Single (1 station)	–	– (1)	VJD SND TMS V13M	0.125
		USB	Magelis XBT N/R/RT (2)	VJD SUD TMS V13M	0.675

(1) References for application transfer cables (PC to Magelis XBT N/R/RT terminal) are listed under "Connection to PCs and printers" on page 1/24.

(2) USB cable for PC TSX CUSB 485 connection and XBT adaptor for USB cable XBT Z925 included (see page 1/24).



Vijeo Designer software

Introduction

Versatile, cross-platform Vijeo Designer™ configuration software can be used to create operator dialog applications for controlling automation systems for:

- Magelis™ STO and STU terminals (Vijeo Designer Limited Edition is sufficient)
- Magelis™ GTO terminals
- Magelis™ XBT GT and XBT GK terminals
- Magelis™ XBT GH portable terminals
- Magelis™ GTW open terminals
- Magelis™ industrial PCs Panel PC and BOX PC

Note: For semi-graphic terminals Magelis XBT N/R/RT, please refer to the Vijeo Designer Lite development software. **Magelis XBT G terminals are no longer supported.**

Vijeo Designer and a suitable terminal can be combined to provide a solution for each and every control station requirement, at the cost of a simple software reconfiguration.

Capable of supporting video image streaming, Magelis Vijeo Designer provides access to new types of application. Users can view their process instantly or subject to a delay, on the same screen as the HMI dialog.

Vijeo Designer uses Magelis Ethernet TCP/IP connectivity and is able to support WEB Gate remote access, the sharing of application data between terminals, the transfer of recipes and logs for variables, and much more.

Applications can be globalized, because Vijeo Designer supports up to 15 languages simultaneously in one project (40 alphabets are available on the Magelis GT/GTO/GK terminal). The interface and documentation for Vijeo Designer are available in 7 languages: English, French, German, Italian, Brazilian Portuguese, Simplified Chinese and Spanish.

Vijeo Designer is the HMI component of SoMachine software, and will run on any PC with Windows XP Professional or Windows 7. It supports WYSIWYG simulation (1) of the developed application (without the target Magelis GT/GTO/GK/GTW terminal or Magelis iPC), simulation of the PLC variables (I/O, internal bits and words), and ensures that the application runs in total security on the Magelis GT/GTO/GK/GTW terminal or Magelis industrial PC.

Configuration

Vijeo Designer configuration software enables operator dialog projects to be processed quickly and easily thanks to its advanced ergonomics using up to 5 configurable windows:

- 1 Browser window
- 2 Object List window
- 3 Recipes window
- 4 Library of Animated Graphic Objects and Image Objects window
- 5 Report window

The software also offers a complete set of application management tools for:

- Project creation, whereby a project includes one or a number of applications for Magelis GT/GTO/GK/GTW, Panel PC and PC BOX with sharing of variables between terminals (up to 8 terminals and 300 variables)
- Recipe management (32 groups of 256 recipes with up to 1024 ingredients)
- Cross-referencing of application variables
- Documentation of views for an application
- Full simulation mode for testing the application from the design office
- Bar code reader management via:
 - USB port on multifunction XBT GT terminals, Magelis GT/GTO/GK/GTW keypad terminals and Magelis industrial PCs
 - COM1 or COM2 serial port on Magelis GT/GK/GTW (2)
- USB keyboard and mouse support for all terminals incorporating a USB port (only one peripheral can be connected at any one time)
- Retrieval of symbol files for PLC variables generated by TwidoSuite, PL7, Concept, ProWORX 32 and Unity Pro software (3)
- Report printing
- Barcode printing

(1) What You See Is What You Get (on the screen of the target terminal).

(2) Except XBT GT11 terminals.

(3) DDT structured types and "unlocated" variables are supported.



Graphic toolbar

Graphics editor

The graphics editor in Vijeo Designer offers interface consistency for simple objects as well as for more sophisticated ones. It enables application developers to create views easily based on:

- Simple objects to be configured:
 - points, lines, rectangles, ellipses, arcs
 - bar graphs, meters, tanks, fillers, pie charts, curves
 - polylines, polygons, regular polygons, Bézier curves, scales
 - texts, images or alarm summary, etc.
- Preconfigured advanced objects: switches, radio buttons, indicators, buttons, tanks, bar graphs, potentiometers, selector switches, text or number fields, and enumerated lists.
- Screen masks and skeletons for type applications



Object animation example

Object animations

8 types of graphic-object animation support the rapid creation of animated mimics on the basis of:

- Pressing the touch panel
- Change of color
- Filling
- Movement
- Rotation
- Size
- Visibility
- Display of associated value



Library of animated graphic objects

The library of “ready-made” animated graphic objects makes the creation of mimics very efficient. This library includes more than 4000 2-D and 3-D “industrial” vector images. Simply “drag and drop” the object using the mouse to position it on the mimic being created.

User-defined objects can be added to this library using the same simple “drag and drop” method.



Library of animated graphic objects

Java scripts

Vijeo Designer supports data processing using Java language scripts. This function facilitates the running of complex animations, the automation of tasks within the terminal, and the management of calculations in order to relieve the load on the PLC programs.

The scripts (50 lines, max.) can be associated with:

- Variables
- Operator actions
- Screens
- The application itself

User-customizable resources

To enable applications to be customized in accordance with customer requirements, Vijeo Designer features a new resource concept that makes it possible to define styles (colors, images, character fonts, text lists).

To quickly customize a generic application to meet customer requirements, simply assign these styles to the objects concerned.

The resource concept is supported by the following native objects: *Meter*, *Bar Graph*, *Slider*, *Potentiometer*, *Selector*, *Text List* and *Image List*.

```
//Script Created: 10/02/2001
//
// Description:
//
//
// Replace this line with your script
int pos;

if (movebottles.getValue() != 0) // If conveyor is OFF, do not move bottles.
{
    pos = BottlePos.getValue();
    if (pos >= 1000)
        pos = 0;
    pos = pos + 10 + 2 * ConveyorSpeed.getValue();
    BottlePos.write(pos);
}
}
```

Java script example



Data Manager: Transfer recipes, videos, images, etc. via Ethernet or USB, by simply clicking the mouse

Advanced functions

Based on new information technologies, Vijeo Designer features a large number of advanced functions for processing a higher volume of data, both faster and more reliably:

- Multimedia data management in the most popular formats:
 - image display (jpeg, bmp, emf and png files)
 - text display and processing (txt files)
 - sound message processing (wav files)
- Alarm or curve logs recorded
- Zoom in/out function on trending curves for a detailed analysis
- Alarm management. All variables can be categorized as "Alarms" and can be customized in respect of visualization and acknowledgment. These Boolean and analog threshold type alarms can be printed on the fly.
- Multimode application transfer: via serial link, USB, Ethernet and Compact Flash memory card (on multifunction terminals)
- Backup of application source files on the terminal or iPC to facilitate maintenance
- User-friendly data exchange between PC and terminal using the Data Manager tool
- Integrated FTP server for downloading/uploading recipes via Ethernet TCP/IP and restoring logs to Magelis GT/GTO/GK/GTW and Magelis iPC
- Multipoint communication for multifunction terminals, 2 serial links and 1 Ethernet network can be active simultaneously
- Action table for associating a particular behavior with an event
- Use of a USB memory stick (up to 4 GB) for application downloads/uploads, data retrieval or recipe exchange
- E-mail on action and event (the e-mail text can contain up to 1000 characters)

WEB Gate remote connection

Vijeo Designer supports a WEB Gate remote connection with any platform which has an Ethernet connection point.

WEB Gate supports remote visualization of Vijeo Designer applications with Internet Explorer on any PC running Windows XP or Windows 7. The size of the page displayed is determined by the terminal.

WEB Gate supports the display of pages similar to those in the Vijeo Designer application, or of different pages. For example, startup pages and navigation pages can be differentiated in order to indicate the type of access (terminal/WEB Gate).

Several connections are possible at the same time, with the number depending on the size of the application.

The high security mode of WEB Gate excludes any risk of applications jamming as a result of variables being modified via the terminal and WEB Gate at the same time.

For increased confidentiality:

- WEB Gate access can be restricted to only those PCs whose IP address appears in the licensing list.
- Some Vijeo Designer functions are not supported by WEB Gate:
 - application shutdown, restart
 - terminal configuration
 - reading of an acoustic animation (sound file)
 - display a recorded video sequence

WEB Maintenance remote diagnostics

In addition to WEB Gate, Vijeo Designer features the embedded diagnostics service WEB Maintenance - Transparent Ready WEB Server Class B15 (1). This server's navigation bar features an option for accessing the following functions:

- WEB Gate
- Animation tables
- Web interface for retrieving data files (recipes, logs, multimedia files)

Note: Terminals programmed using Vijeo Designer can be accessed directly via their names. This function is supported by the DHCP and DNS network services.



Alarm management



Report printing

(1) Please consult our website www.schneider-electric.com

Integrated diagnostics

Vijeo Designer can be used to access the “Diag buffer” function of Modicon M340, Premium, and Quantum PLCs via the following protocols:

	Modicon M340 Unity Pro	Premium PL7	Premium Unity Pro	Quantum Unity Pro
UNITE-Series	Accessible	Accessible	Accessible	Accessible
UNITE-TCP/IP XWAY	Accessible	Accessible	Accessible	Accessible
UMAS Modbus TCP	Accessible	Accessible	Accessible	Accessible
UMAS Modbus RTU	Accessible	Accessible	Accessible	Accessible
UMAS Modbus Plus	Accessible	Accessible	Accessible	Accessible
UMAS UNITE-Series	Accessible	Accessible	Accessible	Accessible
UMAS UNITE-TCP/IP XWAY	Accessible	Accessible	Accessible	Accessible
UMAS Modbus TCP USB PPP	Accessible	Accessible	Accessible	Accessible

 Accessible
 Not accessible

Intelligent Data Service option

Intelligent Data Service (IDS) is an extension of Vijeo Designer for the target PC (Magelis or standard PC) which supports the implementation of control solutions for one or a number of terminals (up to 8).

This extension offers full process traceability. Both process variables and operator actions are tracked so that the right decisions can be made at the right time (*Industrial Business Intelligence*).

Powerful

The IDS extension enables data to be collected from multiple terminals via Ethernet without impairing HMI reaction times.

Flexible

The IDS extension supports various storage methods; CSV files can be read directly in MS Excel, saving as free format in an SQL database or secure IDV (*Intelligent Data Vault*) files to ensure compatibility with the requirements of 21 CFR Part 11.

Innovative

In just a few clicks of the mouse, the IDS extension allows you to create dashboards that can be accessed from any WEB browser (Silverlight) as well as clear and well organized reporting documents.

Intelligent Data Service Report Printing option

Intelligent Data Service (IDS) Report Printing is an extension of Intelligent Data Service for the PC (Magelis or Standard PC).

This extension allows you to create new reports “from scratch” and link them to IDS data.

In addition to editing functions, IDS Report Printing allows you to preview the report before printing, print it, or save it to file on disk.

Communication protocols between the HMI application and the PLCs

Communication between the operator dialog application and the connected control equipment is established using a communication protocol (driver), which is selected when creating the application in Vijeo Designer.

Schneider Electric protocols

Vijeo Designer supports the following Schneider Electric protocols:

- Modbus RTU Master
- Modbus TCP/IP Master
- Modbus Plus (1)
- Modbus 32-bit extensions
- ELAU PacDrive (ELAU C00x/LMCx00)
- Unitelway
- UniTE TCP/IP
- USB terminal port for Modicon M340 CPUs
- FIPIO (2), FIPWAY (2)

All Schneider Electric drivers provide IEC access to input bits/words and output bits/words: Modbus (RTU and TCP/IP), Modbus Plus (GMU and USB), Uni-Telway, Xway.

Direct I/O access authorizes access to the hardware input and output registers.

Register addresses comply with the syntax of IEC standards and the address rules for UNITY configuration software (%I, %IW, %Q, %QW).

If requested by the user, the variables associated with a PLC can be read (“on demand scan” function). The DDT and unlocated variables of Unity Pro are supported.

Third-party protocols

Vijeo Designer supports the following third-party protocols:

- Emerson
 - ROC Plus (SIO) and ROC Plus TCP/IP protocols.
- Mitsubishi
 - Melsec protocols: A/Q CPU (SIO), A/Q Ethernet (TCP), QnU Ethernet (TCP), A/Q Link (SIO), QnA CPU (SIO), Q Ethernet (UDP), QnU Ethernet (UDP), FX (CPU), QUTE for Q00JCPU.
 - Except for Melsec-A Link (SIO) protocol, Mitsubishi serial link protocols do not work on the RJ45 port (1).
- Omron
 - Sysmac protocols: FINS (SIO), LINK (SIO), FINS (Ethernet) and Trajexia.
 - OMRON serial link protocols do not work on the RJ45 port (3).
- Rockwell Automation
 - Allen-Bradley protocols: DF1-Full Duplex, RS DataHighway 485, Ethernet IP (4) (PLC5, SLC500, MicroLogix, ControlLogix), Ethernet IP native (3) (ControlLogix), Ethernet IP High Speed access, DeviceNet Slave (6), Ethernet IP Explicit.
- Siemens
 - Simatic protocols: MPI (S7-300/400), MPI Direct, RK512/3964R (S7-300/400), PPI, Siemens Ethernet (ISO-on-TCP/Profinet), MPI pass-through function.
 - The S7-300/400 MPI Adapter and RK512/3964R - RS485 connection serial link protocols do not work on the RJ45 port (3).
 - Profibus DP protocol (5).
- Toyoda
 - Toyopuc Ethernet PC3J (TCP/IP) and Toyopuc Link (SIO) protocols.

Migration of XBTL 1000 applications

The **Switch2VijeoDesigner** service offer makes it even easier to migrate XBTL 1000 applications created on XBT F terminals to Vijeo Designer applications for use on XBT GT/GK terminals. For further information on this service offer, please consult your Customer Care Center.

(1) Via USB Modbus Plus gateways: **XBT ZGUMP** for Magelis XBT GT 2●●● and higher, **TSX CUSBMBP** for Smart and Compact iPC (see page 1/69).

(2) Via USB FIPIO gateway **TSX CUSB FIP** (see page 1/69).

(3) They are supported on XBT GT (SUB-D connector, XBT GT2 and higher).

(4) Certified ODVA compatibility.

(5) Via Profibus DP Bus expansion card **XBT ZGPD** (see page 1/69). Certified by Profibus Foundation.

(6) Via Device Net Bus expansion card **XBT ZGDVN** (see page 1/69).



VJD SUD TGA V61M

References

All licenses for the Vijeo Designer configuration software listed below consist of a DVD containing:

- Vijeo Designer software, including:
 - Copyright-free stand-alone installation of Data Manager
- User documentation in electronic format, including:
 - Online help for the software
 - User Manual for the supported targets
 - Setup Manual for the different protocols supported
- Multimedia self-learning tool lasting 1 hour 30 minutes in English/French
- Supported communication protocols

Note: Magelis STO/STU terminals can be programmed using Vijeo Designer Limited Edition. Vijeo Designer V6.1 supports applications created with any version of Vijeo Designer ≥ V4.6.

If you are updating an earlier application, please consult your Schneider Electric Customer Care Center.

Single-station Build Time licenses

Description	License type	Application transfer cable		Reference	Weight kg
		PC side port	Magelis terminal side		
Vijeo Designer configuration software	Single (1 station)	–	– (1)	VJD SND TGS V61M	0.125
		USB	Magelis STO/STU Magelis GT/GTO/GK/GH/GTW Magelis industrial PCs (2)	VJD SUD TGA V61M	0.330

Multi-station Build Time licenses

Description	License type	Number of stations	Reference	Weight
Vijeo Designer configuration software	Group	3	VJD GND TGS V61M	0.125
	Team	10	VJD TND TGS V61M	0.125
	Facility	Unlimited number of stations on one site	VJD FND TGS V61M	0.125

Run Time licenses (3)

Description	License type	Number of stations	Reference	Weight
Vijeo Designer Run Time license for Magelis GTW & iPC	Single	1	VJD SNR TMPC	–
Intelligent Data Service license extension for Vijeo Designer Run Time	Single	1	VJD SNT RCK V61M	–
Intelligent Data Service Report Printing for IDS	Single	1	VJD SNT RPR V61M	–
Vijeo Designer Run Time IDS Report Print pack (4)	Single	1	VJD SNT RPK V61M	–

(1) References for application transfer cables (PC to Magelis GT/GTO/GK/GH/GTW terminal) are listed under "Application transfer cables - terminal to PC" on page 1/64

(2) USB cable for PC connection included, for Magelis XBT 2●●● and higher: XBT ZG935 (see page 1/64).

(3) The Run Time license drives the execution of an application. It is only used for Magelis industrial PCs and Magelis GTW terminals.

(4) Pack of 3 licenses: Vijeo Designer Run Time license for Magelis iPC, Intelligent Data Service license extension and Intelligent Data Service Report Printing license extension.

5.1 - Technical appendices

- Certifications for automation products 5/2

5.2 - Product reference index

- Product reference index. 5/4



Magelis™ Human/Machine Interfaces

Technical appendices

Automation product certifications

EC regulations

Some countries require certain electrical components to undergo certification by law. This certification takes the form of a certificate of conformity to the relevant standards and is issued by the official body in question. Where applicable, certified devices must be labelled accordingly. Use of electrical equipment on board merchant vessels generally implies that it has gained prior approval (i.e. certification) by certain shipping classification societies.

Abbreviation	Certification body	Country
CSA	Canadian Standards Association	Canada
C-Tick	Australian Communications and Media Authority	Australia, New Zealand
GOST	Scientific research institute for GOST standards	Russia
UL	Underwriters Laboratories	USA











Abbreviation	Classification authority	Country
IACS	International Association of Classification Societies	International
ABS	American Bureau of Shipping	USA
BV	Bureau Veritas	France
DNV	Det Norske Veritas	Norway
GL	Germanischer Lloyd	Germany
LR	Lloyd's Register	UK
RINA	Registro Italiano Navale	Italy
RMRS	Russian Maritime Register of Shipping	Russia
RRR	Russian River Register	Russia
CCS	China Classification Society	China

The tables below provide an overview of the situation as at 1st October 2012 in terms of which certifications (listed next to their respective bodies) have been granted or are pending for our automation products.

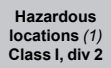
Up-to-date information on which certifications have been obtained by products bearing the Schneider Electric brand can be viewed on our website: www.schneider-electric.com

5

Product certifications

	Certifications									
										
	UL	CSA	ACMA	GOST	USA, Canada	(6)	TÜV Rheinland			
	USA	Canada	Australia	Russia	USA, Canada	(6)	TÜV Rheinland	Australia		Europe
Modicon OTB										
Modicon STB					FM	Zone 2 (2)(5)				
Modicon Telefast ABE 7										
ConneXium					(2)					
Magelis IPC/GTW		(3)		(2)	(3)	Zone 2/22 (2)				
Magelis XBT GT		(3)		(2)	(2) (3)	Zone 2/22 (2)(5)				
Magelis XBT GK		(3)			(3)					
Magelis XBT N/R/RT					CSA	Zone 2/22 (2)(5)				
Magelis HMI GTO		(3)		(2)	(3)	(2)				
Magelis HMI STO/STU		(3)		(2)	(2)(3)	(2)				
Modicon M340					CSA	Zone 2/22 (2)(8)				(2)
Modicon Momentum										
Modicon Premium				(2)	CSA			(2)		(2)
Modicon Quantum				(2)	FM (2)	Zone 2/22 (2)				
Modicon Quantum Safety				(2)	CSA	Zone 2/22 (2)		SIL 2, SIL 3 (7)		
Preventa XPSMF								SIL 3 (7)		
Modicon TSX Micro										(2)
Phaseo	(3)									
Twido	(4)	(4)			CSA/UL (4)					(2)

(1) Hazardous locations: According to UL 1604, ANSI/ISA 12.12.01, CSA 22.2 No. 213 and FM 3611, certified products are only approved for use in hazardous locations categorized as Class I, division 2, groups A, B, C and D, or in non-classified locations.

(2) Depends on product; please visit our website: www.schneider-electric.com.

(3) North American certification cULus (Canada and USA).

(4) Except for AS-Interface module TWD NOI 10M3, CE only.

(5) For zones not covered by this specification, Schneider Electric offers a solution as part of the CAPP (Collaborative Automation Partner Program). Please consult our Customer Care Center.

(6) Refer to the instructions supplied with each ATEX and/or IECEx certified product.

(7) According to IEC 61508. Certified by TÜV Rheinland for integration into a safety function of up to SIL 2 or SIL 3.

(8) Can be used in gassy mines under certain conditions.











Magelis™ Human/Machine Interfaces

Technical appendices

Automation product certifications

EC regulations

Merchant navy certifications

Certified Certification pending	Shipping classification societies										
											
	ABS	BV	DNV	GL	KRS	LR	RINA	RMRS	RRR	PRS	CCS
	USA	France	Norway	Germany	Korea	Great Britain	Italy	Russia	Russia	Poland	China
Modicon OTB											
Modicon STB	(1) (2)	(2)	(2)	(2)		(2)	(2)	(2)	(2)		
Modicon Telefast ABE 7											
ConneXium		(2)		(2)		(2)					
Magelis iPC/GTW				Bridge (2)							
Magelis XBT GT	(2)	(2)	(2)	(2)		(2)	(2)	(2)	(2)		
Magelis XBT GK											
Magelis XBT N/R											
Magelis XBT RT											
Magelis HMI GTO											
Magelis HMI STO/STU		(2)	(2)								
Modicon M340	(2)	(2)	(2)	(2)		(2)	(2)	(2)	(2)		
Modicon Momentum											
Modicon Premium	(2)	(2)	(2)	(2)		(2)	(2)				
Modicon Quantum	(2)	(2)	(2)	(2)		(2)	(2)	(2)			
Modicon TSX Micro											
Phaseo											
Twido			(2)	(2)		(2)					

(1) Also covers US Navy requirements ABS-NRV part 4.

(2) Depends on product; please visit our website: www.schneider-electric.com.

EC regulations

European Directives

The open nature of the European markets assumes harmonization between the regulations set by the member states of the European Union. European Directives are texts whose aim is to remove restrictions on free circulation of goods and which must be applied within all European Union states.

Member states are obligated to incorporate each Directive into their national legislation, and to simultaneously withdraw any regulations that contradict it.

Directives - and particularly those of a technical nature with which we are concerned - merely set out the objectives to be fulfilled (referred to as "essential requirements"). Manufacturers must take all necessary measures to ensure that their products conform to the requirements of each Directive applicable to their equipment.

As a general rule, manufacturers certify compliance with the essential requirements of the Directive(s) that apply to their products by applying a CE mark. The CE mark is affixed to our products where applicable.

Significance of the CE mark

The CE mark on a product indicates the manufacturer's certification that the product conforms to the relevant European Directives; this is a prerequisite for placing a product which is subject to the requirements of one or more Directives on the market and allowing its free circulation within European Union countries. The CE mark is intended for use by those responsible for regulating national markets.

Where electrical equipment is concerned, conformity to standards indicates that the product is fit for use. Only a warranty by a well-known manufacturer can provide assurance of a high level of quality.

As far as our products are concerned, one or more Directives are likely to apply in each case; in particular:

- The Low Voltage Directive (2006/95/EC)
- The Electromagnetic Compatibility Directive (2004/108/EC)
- The ATEX CE Directive (94/9/EC)

Dangerous substances

These products are compatible with:

- The WEEE Directive (2002/96/EC)
- The RoHS Directive (2002/95/EC)
- The China RoHS Directive (Standard SJ/T 11363-2006)
- The REACH regulations Directive (EC 1907/2006)

Note: Documentation on sustainable development is available on our website www.schneider-electric.com (product environmental profiles and instructions for use, ROHS and REACH directives).

End of life (WEEE)

End of life products containing electronic cards must be dealt with by specific treatment processes.

When products containing backup batteries are unusable or at end of life they must be collected and treated separately. Batteries do not contain a percentage by weight of heavy metals above the limit specified by European Directive 2006/66/EC.

MPC YN0 0CF2 00N	1/61 3/8	TM2 DMM 8DRT	2/15	X	XBT GT2330	1/58 1/74 1/79 2/26	XBT Z968	1/20 1/21 1/25 1/27 1/65	
MPC YN0 0CF4 00N	1/61 3/8	TM2 DMM 24DRF	2/15	XB5 S1B 2L2	1/81	XBT GT2430	1/58 1/79 2/26	XBT Z980	1/26 1/66
MPC YN0 0CFE 00N	1/61	TM2 DRA 8RT	2/15	XB5 S1B 2M12	1/81	XBT GT2930	1/58 1/74 1/79 2/26	XBT Z988	1/20 1/25 1/65
MPC YN0 0PWA CTE	3/8 3/9	TM2 DRA 16RT	2/15	XB5 S2B 2L2	1/81	XBT GT4230	1/58 1/74 1/79 2/26	XBT Z3002	1/24 1/62
MPC YNK2 MSD 20N	3/9	TM2 XMT GB	2/16	XB5 S2B 2M12	1/81	XBT GT4330	1/58 1/74 1/79 2/26	XBT Z3004	1/24
MPC YNK2 SHD 20N	3/9	TSX CAN CA50	2/29	XB5 S3B 2L2	1/81	XBT GT4340	1/58 1/79 2/26	XBT Z9008	1/65 1/68
MPC YT5 0NAN 00N	3/33 3/47	TSX CAN CA100	2/29	XB5 S3B 2M12	1/81	XBT GT5230	1/74 1/79	XBT Z9018	1/65 1/68
MPC YT5 0NNN 00N	3/33	TSX CAN CA300	2/29	XB5 S4B 2L2	1/81	XBT GT5330	1/58 1/74 1/79 2/26	XBT Z9680	1/20 1/25
MPC YT9 0NAN 00N	3/33 3/47	TSX CAN CADD1	2/29	XB5 S4B 2M12	1/81	XBT GT5340	1/58 1/79 2/26	XBT Z9681	1/20 1/21 1/25 1/27 1/65
MPC YT9 0NNN 00N	3/33	TSX CAN CADD03	2/29	XB5 S5B 2L2	1/81	XBT GT5430	1/58 1/79 2/26	XBT Z9686	1/27
MSD CHL LMF V31 S0	2/33	TSX CAN CADD5	2/29	XB5 SFF USB EXT	1/81	XBT GT6330	1/58 1/74 1/79 2/26	XBT Z9687	1/27
MSD CHL LMT V31 S0	2/33	TSX CAN CB50	2/29	XBL YGH2	1/63	XBT GT6340	1/58 1/79 2/26	XBT Z9688	1/27
MSD CHL LMU V31 S0	2/33	TSX CAN CB100	2/29	XBL YGK2	1/63	XBT GT7340	1/58 1/79 2/26	XBT Z9710	1/20 1/25 1/65
MSD CHN LMFA	2/33	TSX CAN CB300	2/29	XBL YGK5	1/63	XBT GTW652	1/60	XBT Z9711	1/20 1/25 1/65
MSD CHN LMTA	2/33	TSX CAN CBDD1	2/29	XBL YN00	1/18	XBT N200	1/18	XBT Z9715	1/26 1/65
MSD CHN LMUA	2/33	TSX CAN CBDD03	2/29	XBL YN01	1/18	XBT N400	1/18	XBT Z9720	1/21 1/26
MSD CHN SFN V31	2/33	TSX CAN CBDD5	2/29	XBL YR00	1/19	XBT N401	1/18	XBT Z9721	1/21 1/26
S		TSX CAN CD50	2/29	XBL YR01	1/19	XBT N410	1/18	XBT Z9730	1/21 1/26 1/67
SR2 CBL 06	1/20	TSX CAN CD100	2/29	XBL YRT00	1/23	XBT NU400	1/18	XBT Z9731	1/21 1/26 1/67
SR2 CBL 08	1/25	TSX CAN CD300	2/29	XBL YRT01	1/23	XBT R400	1/19	XBT Z9732	1/21 1/26 1/67
SR2 CBL 09	1/25	TSX CAN CBDD1	2/29	XBT GC 2●●●T	2/19	XBT R410	1/19	XBT Z9740	1/21 1/26 1/66
STB XCA 4002	1/65	TSX CAN CBDD03	2/29	XBT GC1100T	1/79 2/14 2/19	XBT RT500	1/22	XBT Z9743	1/26 1/66
T		TSX CAN CBDD5	2/29	XBT GC1100U	1/79 2/14	XBT RT511	1/22	XBT Z9780	1/25 1/27 1/65 1/68
TCS CAR01NM120	2/28	TSX CAN CDF 90T	2/28	XBT GC2120T	1/79 2/14	XBT Z908	1/21 1/27 1/68	XBT Z9782	1/25 1/65
TCS CAR013M120	2/28	TSX CAN CDF 90TP	2/28	XBT GC2120U	1/79 2/14	XBT Z915	1/20 1/24 1/64	XBT Z9980	1/25 1/26 1/27 1/65 1/68
TCS CCN 4F3 M1T	2/29	TSX CAN CDF 180T	2/28	XBT GC2330T	1/79 2/14	XBT Z918	1/20 1/25 1/65	XBT Z9982	1/25 1/65
TCS CCN 4F3 M3T	2/29	TSX CAN TDM4	2/28	XBT GC2330U	1/79 2/14	XBT Z925	1/24	XBT ZG5H	1/63
TCS CCN 4F3 M05T	2/29	TSX CUSB 485	1/24	XBT GH2460	1/59 1/79	XBT Z926	1/20 1/24	XBT ZG43	1/63
TCS CTN011M11F	2/29	TSX CUSB FIP	1/69	XBT GH2460B	1/59 1/79	XBT Z936	1/20	XBT ZG45	1/63
TCS CTN 023F 13M03	2/28	TSX CUSB MBP	1/69	XBT GK2120	1/59 1/79 2/27	XBT Z938	1/20 1/21 1/25 1/65	XBT ZG45B	1/63
TCS CTN 026M 16M	2/28	TSX PCX 1031	1/65	XBT GK2330	1/59 1/79 2/27	XBT Z945	1/24		
TLA CD CBA0	2/29	TWD FCN2K20	2/21	XBT GK5330	1/59 1/79 2/27				
TLA CD CBA 005	2/29	TWD FCN2K26	2/21	XBT GT1100	1/74				
TLA CD CBA 015	2/29	TWD FCW30K	2/21	XBT GT1105	1/74 1/79				
TLA CD CBA 030	2/29	TWD FCW50K	2/21	XBT GT1130	1/74				
TM2 ALM 3LT	2/16	TWD FTB2T10	2/21	XBT GT1135	1/74 1/79				
TM2 AMI 2LT	2/16	TWD FTB2T11	2/21	XBT GT1335	1/74 1/79				
TM2 AMI 4LT	2/16	TWD XMT 5	2/16	XBT GT2110	1/74 1/79 2/26				
TM2 AMI 8LT	2/16	V		XBT GT2120	1/58 1/74 1/79 2/26				
TM2 AMM 3HT	2/16	VJD FND TGS V61M	4/13	XBT GT2130	1/58 1/74 1/79 2/26				
TM2 AMM 6HT	2/16	VJD GND TGS V61M	4/13						
TM2 AMO 1HT	2/16	VJD SND TGS V61M	4/13						
TM2 ARI 8LRJ	2/16	VJD SNT TMS V13M	4/7						
TM2 ARI 8LT	2/16	VJD SNR TMPC	3/8 3/9 3/30 3/41 4/13						
TM2 AVO 2HT	2/16	VJD SNT RCK V60M	3/30 3/41 4/13						
TM2 DAI 8DT	2/15	VJD SNT RCK V61M	4/13						
TM2 DDI 8DT	2/15	VJD SNT RPK V61M	4/13						
TM2 DDI 16DK	2/15 2/19	VJD SNT RPR V61M	4/13						
TM2 DDI 16DT	2/15	VJD SUD TGA V61M	4/13						
TM2 DDI 32DK	2/19	VJD SUD TMS V13M	4/7						
TM2 DDO 8TT	2/15	VJD TND TGS V61M	4/13						
TM2 DDO 8UT	2/15	VW3 A8 306	1/68						
TM2 DDO 16TK	2/15 2/19	VW3 A8 306 D30	1/67						
TM2 DDO 16UK	2/15	VW3 A8 306 R30	1/65						
TM2 DDO 32TK	2/15 2/19	VW3 A8 306R30	1/68						
		VW3 A8 306 TF10	1/68						
		VW3 CAN A71	2/29						
		VW3 CAN CARR1	2/29						
		VW3 CAN CARR03	2/29						
		VW3 CAN KCDF 180T	2/29						
		VW3 CAN TAP2	2/28						
		VW3 M38 05 R010	2/29						

XBT ZG46	1/63	XBT ZGCO2	1/62
XBT ZG47	1/63	XBT ZGCO3	1/62
XBT ZG51	1/63 2/14	XBT ZGCO4	1/62
XBT ZG52	1/63 2/14	XBT ZG DIO1	2/14
XBT ZG54	1/63	XBT ZG DIO2	2/14
XBT ZG55	1/63	XBT ZGDVN	1/69
XBT ZG56	1/63	XBT ZGESGD	1/63
XBT ZG57	1/63	XBT ZGHCAP	1/62
XBT ZG58	1/63	XBT ZGHL3	1/59
XBT ZG59	1/63	XBT ZGHL5	1/59
XBT ZG60	1/61 2/14	XBT ZGHL10	1/59
XBT ZG62	1/61 2/14	XBT ZGHL20	1/59
XBT ZG64	1/61	XBT ZGHSTP	1/63
XBT ZG65	1/61	XBT ZGI232	1/64
XBT ZG66	1/61	XBT ZGI485	1/64
XBT ZG68	1/61	XBT ZGJBOX	1/59 1/79
XBT ZG69	1/61	XBT ZGM128	1/61
XBT ZG70	1/61	XBT ZGM256	1/61
XBT ZG71	1/61	XBT ZG Mount	1/63 2/14
XBT ZG909	1/64	XBT ZGNSTP	1/62
XBT ZG919	1/64	XBT ZGPDP	1/69
XBT ZG935	1/24 1/64 2/14	XBT ZGPEN	1/63
XBT ZG939	1/64	XBT ZGPWS1	1/24 1/63 2/14
XBT ZG949	1/67	XBT ZGPWS2	1/63
XBT ZG979	1/66	XBT ZGUMP	1/69
XBT ZG9292	1/67	XBT ZGUSB	1/24 1/62 2/11 2/14
XBT ZG9721	1/26 1/67	XBT ZGUSBB	1/62 2/14
XBT ZG9722	1/67	XBT ZGWMKT	1/62
XBT ZG9731	1/66 1/67	XBT ZN01	1/18
XBT ZG9740	1/66	XBT ZN02	1/18
XBT ZG9772	1/66	XBT ZN999	1/18
XBT ZG9773	1/66	XBT ZNCO	1/18
XBT ZG9774	1/66	XBT ZR01	1/19 1/23
XBT ZG9775	1/66	XBT ZR02	1/19 1/23
XBT ZG9778	1/66	XBT ZRCO	1/19 1/23
XBT ZG ABE1	2/19 2/20	XBT ZRT 999	1/23 1/24
XBT ZG ABE2	2/19 2/20	XBT ZRT PW	1/24
XBT ZGADT	1/62 3/8	XBT ZS61	2/11
XBT ZGAUX	1/63	XBT ZS62	2/11
XBT ZGC04	1/74	XVGU 3SHAV	1/78
XBT ZG CANM	2/24	XVGU 3SWV	1/78
XBT ZGC CAN	2/14 2/22	Z	
XBT ZGCHOK	2/14	ZB5 AZ9 01	1/11 2/11
XBT ZGCLP1	1/63	ZB5 AZ9 05	1/11 2/11
XBT ZGCLP2	1/63 2/14	ZB5 SZ70	1/81
XBT ZGCLP3	1/63	ZB5 SZ71	1/81
XBT ZGCLP4	2/14	ZBY 010 1T	1/81
XBT ZGCNC	1/63		
XBT ZGCO1	1/62		



<http://www.schneider-electric.com/>

Schneider Electric USA, Inc.

8001 Knightdale Blvd.
Knightdale, NC 27545

USA Customer Care Center
Tel: 888-778-2733

Schneider Electric Canada

5985 McLaughlin Rd.
Mississauga, Ontario, Canada L5R 1B8

Canada Customer Care Center
Tel: 800-565-6699

The information and dimensions in this catalog are provided for the convenience of our customers. While this information is believed to be accurate, Schneider Electric reserves the right to make updates and changes without prior notification and assumes no liability for any errors or omissions.

Advantys, Altistart, Altivar, CANopen, Compact, Concept, Harmony, Lexium, M238, M258, M340, Magelis, Modbus, Modicon, Momentum, Nano, PL7, Premium, Quantum, Telefast, TeSys, TSX Micro, Twido, TwidoSoft, Uni-TE, Uni-Telway, Vijeo Citect, Vijeo Designer, Zelio, Schneider Electric and logo, and "Make the most of your energy" are trademarks or registered trademarks of Schneider Electric or its affiliates in the United States and other countries. Other trademarks used herein are the property of their respective owners.

Design: Schneider Electric
Photos: Schneider Electric