



Harmony STO and STU

Compact color HMI panels from
3.5" to 5.7" screen



Harmony

Discover **Harmony**

Advanced operator interface and industrial relays

Harmony operator interface and industrial relays enhance operational efficiency and equipment availability across industrial and building applications. **Harmony** includes intelligent connected products and edge terminals that visualize, gather and process data, enabling informed operator decisions

Explore our offer

- **Harmony** Push Buttons and Switches
- **Harmony** HMI Operator Terminals, IPC and EdgeBox
- **Harmony** Signaling Devices
- **Harmony** Electrical Relays
- **Harmony** Safety

Life Is **On**

Schneider
Electric

Quick access to product information

Get technical information about your product

References

Modicon TM3 I/O expansion modules for Modicon controllers
Analog I/O modules

References	Modicon TM3 analog input modules	Input range	Resolution	Input terminal block (T)	Reference	Weight (kg)
2 voltage/current inputs	-10...+10 VDC 0...+10 VDC 0...20 mA / -20 mA	16 bits of	16 bits of	0 581.2	TM3AI2H	0.150
		16 bits of	16 bits of	0 581.2	TM3AI2H	0.254
4 voltage/current inputs	-10...+10 VDC 0...+10 VDC 0...20 mA / -20 mA	12 bits of	12 bits of	3 310.15	TM3AI4	0.200
		11 bits of	11 bits of	3 310.15	TM3AI4	0.200
4 voltage/current or temperature inputs (I, K, R, S, E, T, N, E, C)	-10...+10 VDC 0...+10 VDC 0...20 mA / -20 mA	16 bits of	16 bits of	3 310.15	TM3AI4	0.200
		11 bits of	11 bits of	3 310.15	TM3AI4	0.200
4 differential temperature inputs (I, K, R, S, E, T, N, E, C)	-10...+10 VDC 0...+10 VDC 0...20 mA / -20 mA	16 bits of	16 bits of	3 310.15	TM3AI4	0.200
		11 bits of	11 bits of	3 310.15	TM3AI4	0.200
4 voltage/current	-10...+10 VDC	16 bits of	16 bits of	0 581.2	TM3AI4	0.150
		16 bits of	16 bits of	0 581.2	TM3AI4	0.254

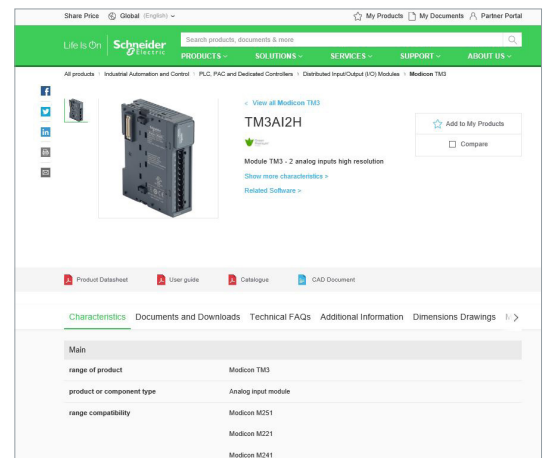

Each commercial reference presented in a catalog contains a hyperlink. Click on it to obtain the technical information of the product:

- Characteristics, Dimensions and drawings, Mounting and clearance, Connections and schemas, Performance curves
- Product image, Instruction sheet, User guide, Product certifications, End of life manual

Find your catalog

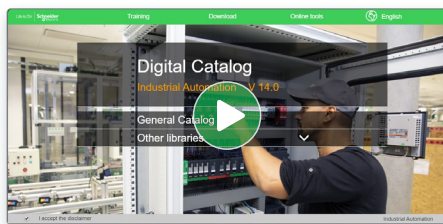

- > With just 3 clicks, you can access the Industrial Automation and Control catalogs, in both English and French
- > Consult digital automation catalogs at [Digi-Cat Online](#)

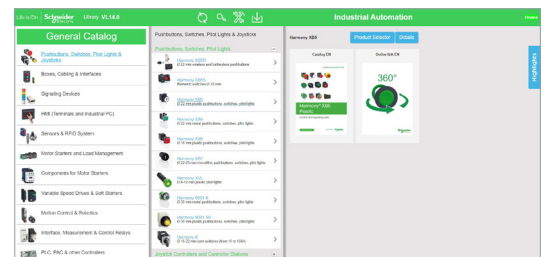

- Up-to-date catalogs
- Embedded product selectors, 360° pictures
- Optimized search by commercial references

Select your training



- > Find the right [Training](#) for your needs on our Global website
- > Locate the training center with the selector tool, using this [link](#)

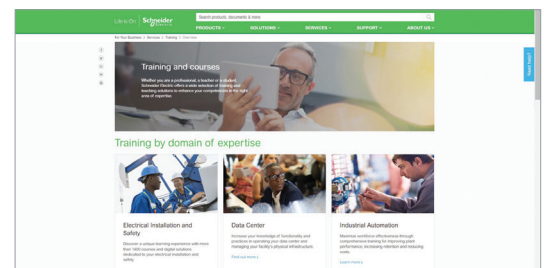

Life Is On

Schneider Electric

General contents

Harmony STO and STU

■ General Presentation	page 2
□ Harmony STU	page 2
- High performance communication	page 2
- Simplified installation	page 2
□ Harmony STO	page 2
- Best-in-class display	page 2
- Panel adaptation for backward compatibility	page 3
□ HMI software for Harmony Small Panels	page 3
- Vijeo Designer for Harmony STU	page 3
- EcoStruxure Operator Terminal Expert for Harmony STO7●●	page 3
Selection guide	page 4
■ Presentation	page 6
■ Architecture	page 7
■ Description	
□ Harmony STU	page 8
□ Harmony STO	page 9
■ References	
□ Harmony STO and STU	page 10
□ Software	page 10
□ Separate components	page 11
- Replacement parts	page 11
- Accessories	page 12
- Connection to PCs and printers	page 12
- Cables for connecting Harmony terminals	page 13
■ Product reference index	page 14

Harmony STO and STU

Compact color HMI panels from 3.5" to 5.7" screen

Harmony STO and STU compact color Panels

Schneider Electric touch screen small panels offer greater efficiency and ease of use while retaining the inherent features of HMI.

Harmony STO and STU panels are compact open panels offering greater communication capabilities. The high-resolution touch screens, clever mounting system, and HMI software make them ideal for machine manufacturer solutions in industry and infrastructure.



Harmony STU



Harmony STO

Harmony STU

High-performance communication

With embedded Ethernet connection, communication is more open and faster with Harmony STU panels. In addition, multi-protocol RS-485/232 standard RJ45 ports and USB ports (mini and standard versions) make it easy to communicate with commercially available equipment without extra cost.



USB, Serial and Ethernet ports

Simplified installation

No panel cut-out is required to install a Harmony STU small panel. All you need to do is drill a hole measuring 22 mm in diameter - just like installing a pushbutton. The front module (comprising the screen) is connected to the rear module (comprising the terminals and connectors) via this 22 mm drilled hole.



Pushbutton hole mounting system

Harmony STO

Best-in-class display

With screen quality based on PPI similar to Harmony GTU, the Harmony STO7●● 4.3" color screens support crisp-clear visualization and a high-quality display. This enables to create more attractive and distinguished applications for the industry.



Brilliant screen quality

+ Harmony STU/STO → For simple machine manufacturer solutions

Harmony STO (continued)

Panel adaptation for backward compatibility

The unique design of Harmony STO7●● panels with optional adapter frame supports eight times more pixels and a 50 % larger screen size while keeping the same panel cut-out as STO5. This reduces the need for machine redesign or maintenance and also makes it backward-compatible.



Innovative mounting adapter

HMI software for Harmony compact color panels

Vijeo Designer for Harmony STU

Harmony STU terminals are configured using Vijeo Designer software. Vijeo Designer software has an advanced user interface with multiple configurable windows, enabling operator dialogue projects to be developed quickly and easily. A complete set of drivers and function allows you to create everything you need for machine interaction tasks.

EcoStruxure Operator Terminal Expert for Harmony STO7●●

Harmony STO7●● terminals are configured using EcoStruxure Operator Terminal Expert, the innovative software that focuses on the user. The new navigation concepts combined with optimized graphics and animations make it easy to create an intuitive user interface and also provide flexibility in coping with existing HMI screen limitations, resulting in a high quality design experience.



Vijeo Designer software



EcoStruxure Operator Terminal Expert

Harmony STO and STU

Compact color HMI panels from 3.5" to 5.7" screen

Applications		Display of graphic pages	
Type of terminal		Small Panels with touch screen	
		  	
Display	Type	Color QVGA TFT LCD (320 x 240 pixels)	
	Capacity	3.5" color	5.7" color
Data entry		Via touch screen	
Memory capacity	Application	32 MB Flash	
	Expansion	-	
Functions	Maximum number of pages	Limited by internal FLASH EPROM memory capacity	
	Variables per page	Unlimited	
	Representation of variables	Alphanumeric, bitmap, bargraph, gauge, curves, buttons, LEDs	
	Recipes	32 groups of 64 recipes	
	Curves	Yes, with log	
	Alarm logs	Yes	
	Real-time clock	Access to the PLC real-time clock	
	Alarm relay	-	
Buzzer	Yes		
Communication	Asynchronous serial link	RS-232C/RS-485	
	Downloadable protocols	Uni-TE, Modbus, and for PLC brands: Allen-Bradley, Omron, Mitsubishi, Siemens	
	Printer link	USB for serial or parallel printer	
	USB ports	1x host Type A and 1 device Type mini-B	
	Networks	1x Ethernet TCP/IP port (10BASE-T/100BASE-TX)	
Development Software		Vijeo Designer (on Windows XP Professional and Windows 7 Business 32-bit and 64-bit)	
Operating system		Harmony	
References		HMISTU655 HMISTU855 HMISTU655W HMISTU855W	
Page		10	

Display of graphic pages	
Small Panels with touch screen	
 	
Color TFT LCD (480 x 272 pixels)	
4.3" color	
Via touch screen	
26 MB Flash	
-	
Limited by internal FLASH EPROM memory capacity	
Unlimited	
Alphanumeric, bitmap, bargraph, gauge, curves, buttons, LEDs	
32 groups of 64 recipes	
Yes, with log	
Yes	
Option: RTC battery set	
-	
Yes	
RS-232C/RS-485	
Uni-TE, Modbus and for PLC brands: Allen-Bradley, Omron, Mitsubishi, Siemens	
USB for serial or parallel printer	
1x host Type A and 1 device Type mini-B	
1x Ethernet TCP/IP port (10BASE-T/100BASE-TX)	
EcoStruxure Operator Terminal Expert (on Windows 7 and Windows 8, Windows 10)	
Harmony	
HMISTO7.5	
10	

Harmony STO and STU

Compact color HMI panels from 3.5" to 5.7" screen



Harmony STU 5.7"



Harmony STU 3.5"



Harmony STO 4.3"



Green product

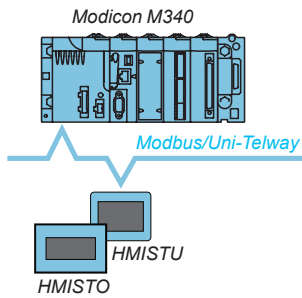

Example of serial link architecture

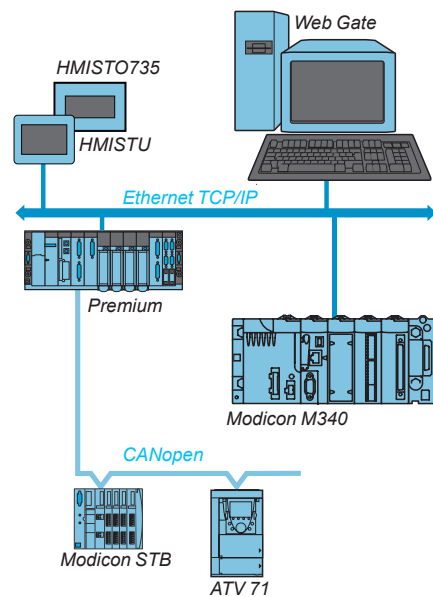

Example of Ethernet TCP/IP network architecture

Presentation

The Harmony small panels offer includes the following touch screen terminals:

- Harmony STU, with 3.5" and 5.7" TFT color screens
- Harmony STO, with 4.3" 64 K TFT color screen

Operation

The features of Harmony STU and STO terminals draw on key technological innovations:

- All Harmony STU and STO models are equipped with:
 - 2 USB V2.0 ports for data transfer
 - Harmony STU models feature:
 - 1 RJ45 port, enabling integration of an Ethernet TCP/IP network and the use of the services associated with this (in particular, the Web Gate function)
 - Harmony STO735 supports Ethernet only and Harmony STO715 supports RJ45 port

Green product

Harmony STO/STU is a Green Premium product designed to provide full transparency on environmental impact:

- Transparent environment information
- Complaint to RoHS and REACH
- Life cycle analysis, compliant with ISO14025
- Circular instructions

Communication

Harmony STO/STU terminals communicate with PLCs via an integrated serial link, using the following communication protocols:

- **Schneider Electric** (Uni-TE, Modbus)
- **Third-party**: Mitsubishi Electric, Omron, Allen-Bradley and Siemens

Harmony STU and STO 735 terminals are connected on Ethernet TCP/IP networks via Modbus TCP or a third-party protocol.

Harmony STO and STU

Compact color HMI panels from 3.5" to 5.7" screen
Architectures, connection to automation systems

Presentation

Harmony Human Machine Interfaces communicate with automation system equipment:

- Via serial link
- By means of integration in an Ethernet TCP/IP architecture

Communication via serial link

All Harmony terminals feature an integrated RS-232C or RS-422/485 asynchronous serial link.

Use of the Uni-TE or Modbus protocol makes it easy to set up communication with Schneider Electric PLCs. Third-party protocols enable connection to PLCs offered by major manufacturers on the market:

- DF1, DH485 for Allen-Bradley PLCs
- SysmacWay for Omron PLCs
- MPI/PP1 for Siemens Simatic S7 PLCs
- Mitsubishi Melsec FX PLC

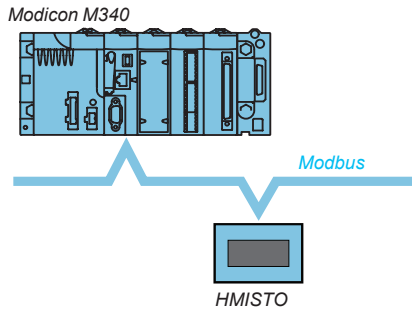

Examples of connections

Integration in an architecture with Ethernet TCP/IP network

Automation platforms provide transparent routing of Uni-TE or Modbus messages from a TCP/IP network to a Uni-TE or Modbus network and vice versa. The various services offered for the terminals are:

- **Modbus TCP/IP messaging** (HMIGTU and HMIGTO(1), access with Ethernet TCP/IP Modbus protocol)
With Vijeo Designer Configuration software:
- **Browse function** with HMIGTU or standard PC
- **Web Gate function:** Diagnostics for remote control of the application
- **FTP server:** Transfer of data files to the terminal
- **Data Sharing function:** Data exchange on Ethernet between 8 terminals (maximum)
- **E-mail function**

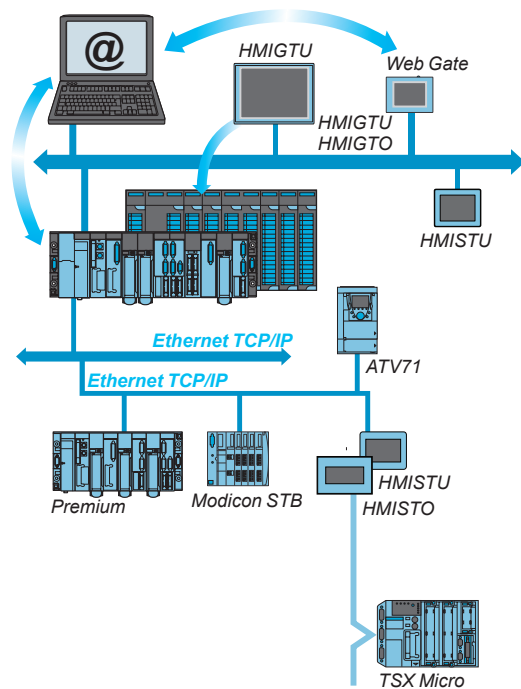

Harmony STO and STU

Compact color HMI panels from 3.5" to 5.7" screen
Harmony STU - 3.5" and 5.7"

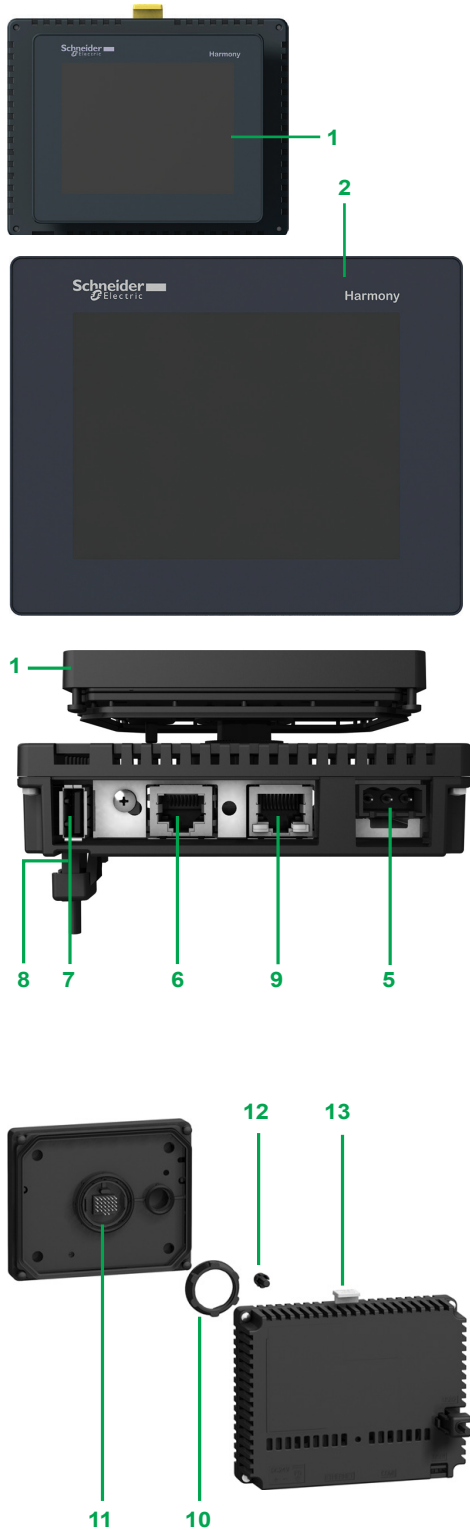

Description

Harmony STU 3.5" and 5.7"

Front view

Harmony STU panels have the following on the front, depending on the model:

- 1 Harmony STU655: A touch screen for displaying synoptic views (3.5" color TFT)
- 2 Harmony STU855: A touch screen for displaying synoptic views (5.7" color TFT)
- 3 Harmony STU655W: STU655 touch screen (3.5" color TFT) without Schneider logo on front face
- 4 Harmony STU855W: STU855 touch screen (5.7" color TFT) without Schneider logo on front face

Rear view

Harmony STU panels have the following on the rear:

- 5 A removable screw terminal block for 24 V \square power supply
- 6 An RJ45 connector for RS-232C or RS-485 serial link connection to PLCs (COM1)
- 7 A USB Type A host connector for:
 - Connection of a peripheral device
 - Connection of a USB memory stick
 - Application transfer
- 8 A USB Type mini-B device connector for application transfer (on the left-hand side)
- 9 An RJ45 connector for the Ethernet TCP/IP 10BASE-T/100BASE-TX link

Fixing system

A Harmony STU is made up of a front module (comprising the screen) and a rear module (comprising the CPU plus terminals and connectors). The two modules are fixed together via a hole measuring 22 mm in diameter. The fixing system contains the following elements:

- 10 A fixing nut
- 11 A seal
- 12 An anti-rotation tee (can be used as an option)
- 13 A release mechanism: simply press to separate the two modules once they have been fixed together

Harmony STO and STU

Compact color HMI panels from 3.5" to 5.7" screen

Harmony STO - 4.3"

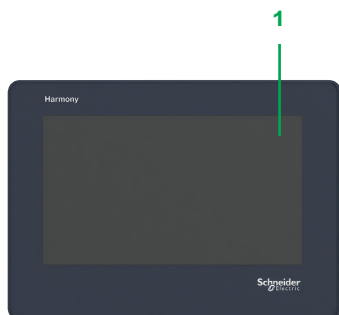

Harmony STO705 front view

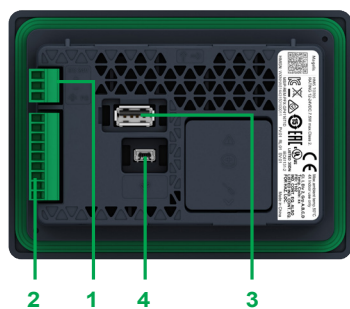

Harmony STO705 rear view

Description (continued)

Harmony STO 4.3"

Front view

Harmony STO panels have the following on the front:

- 1 A touch screen for displaying synoptic views (4.3" color TFT)

Rear view

Harmony STO panels have the following on the rear:

- 1 A removable screw terminal block for the power supply:
 - 12...24 V $\overline{\text{---}}$ power supply for STO7●●
- 2 A connector for connecting to PLCs or controllers, depending on the terminal model:
 - Harmony STO-715: An RJ45 (COM1) connector for RS-232C or RS-485 serial link
 - Harmony STO-735: An RJ45 (ETHERNET) connector for Ethernet 10BASE-T/100BASE-TX link
 - Harmony STO -705: A 9-way removable screw terminal block (COM1) for RS-232C serial link using Zelio protocol
- 3 A USB Type A host connector for:
 - Connection of a peripheral device
 - Connection of a USB memory stick
 - Application transfer
- 4 A USB Type mini-B device connector for:
 - Power supply for program transfer to STO7●●

Harmony STO and STU

Compact color HMI panels from 3.5" to 5.7" screen



HMISTU655



HMISTU855



HMISTU715

Harmony STO						
Type of screen	Number of ports	Application memory capacity	CFast memory	Embedded Ethernet	Reference	Weight kg/lb
4.3" color touch screen						
TFT	1 COM1 (4) 2 USB	26 MB	No	No	HMISTO705	0.220/ 0.485
TFT	1 COM1 (1) 2 USB	26 MB	No	No	HMISTO715	0.220/ 0.485
TFT	1 ETHERNET (2) 2 USB	26 MB	No	1	HMISTO735	0.220/ 0.485

Harmony STU						
Type of screen	Number of ports	Application memory capacity	CFast memory	Embedded Ethernet	Reference	Weight kg/lb
3.5" color touch screen						
TFT	1 COM1 (1) 1 ETHERNET (2) 2 USB	32 MB	No	1	HMISTU655	1.000/ 2.205
Without logo on front face	1 COM1 (1) 1 ETHERNET (2) 2 USB	32 MB	No	1	HMISTU655W	1.000/ 2.205
5.7" color touch screen						
TFT	1 COM1 (1) 1 ETHERNET (2) 2 USB	32 MB	No	1	HMISTU855	0.615/ 1.356
Without logo on front face	1 COM1 (1) 1 ETHERNET (2) 2 USB	32 MB	No	1	HMISTU855W	0.615/ 1.356

Software		
Configuration software		
Description	Operating system	Compatible with
Vijeo Designer	Windows XP Professional Windows 7 Business (32-bit and 64-bit)	HMISTU
EcoStruxure Operator Terminal Expert	Windows 7, Windows 8 and Windows 10	HMISTO color panels

(1) RS-232C or RS-485 serial interface with RJ45 connector.
 (2) Ethernet 10BASE-T/100BASE-TX link.
 (3) RS-232C serial interface using Zelio protocol, for direct connection to Zelio Logic SR2/SR3 controllers.
 (4) RS-232C serial interface with 9-pin terminal block connector.

Harmony STO and STU

Compact color HMI panels from 3.5" to 5.7" screen

Separate components

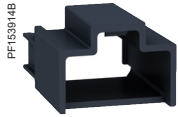

HMIZCLP1



HMIZCLP3



ZB5AZ905

Separate components

Description	Description/function	Compatible with	Reference	Weight kg/lb
Accessory kit	Contains: <ul style="list-style-type: none"> ■ An anti-rotation tee ■ A USB Type A clamp ■ A USB Type mini-B clamp ■ A panel adapter for mounting on an enclosure 1 mm thick 	HMISTU655 HMISTU655W HMISTU855 HMISTU855W	HMIZSUKIT	–
USB clamp	Holds the usb Type A connection in place	HMISTO5●●	HMIZSCLP1	–
	Hold the USB type mini-B connection in place	HMISTO5●●	HMIZSCLP3	–
Protective sheets	5 peel-off sheets for protecting the screen	HMISTU655 HMISTU655W	HMIZS61	–
		HMISTU855 HMISTU855W	HMIZS62	–

Replacement parts

Description	Description/function	Compatible with	Reference	Weight kg/lb
Nuts	Set of 10 nuts, 22 mm (front module of the HMI STU is fixed to the enclosure using a 22 mm nut (see page 10))	HMISTU655 HMISTU655W HMISTU855 HMISTU855W	ZB5AZ901	–
Bezel key	Used to tighten the fixing nut	HMISTU655 HMISTU655W HMISTU855 HMISTU855W	ZB5AZ905	–
Front display	Front display for 3.5" screen	HMISTU655	HMIS65	–
	Front display for 3.5" screen without Schneider logo	HMISTU655W	HMIS65W	–
	Front display for 5.7" screen	HMISTU855	HMIS85	–
	Front display for 5.7" screen without Schneider logo	HMISTU855W	HMIS85W	–
Rear module	Rear module for Harmony STU product	HMISTU655 HMISTU655W HMISTU855 HMISTU855W	HMIS5T	–

Note: The separate or replacement part products may be changed or discontinued without notice. Please check our website www.se.com for the latest information.

Harmony STO and STU

Compact color HMI panels from 3.5" to 5.7" screen
Separate components

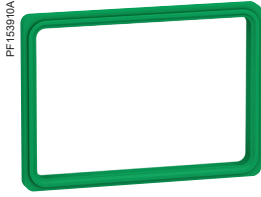

HMIZS501



HMIZSRTC1

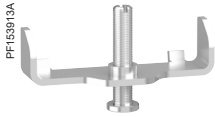

HMIZSFIX1



HMIZUV0W

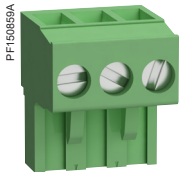

HMIZSPWO

Accessories					
Type	Description/function	Compatible with	Sold in lots of	Unit reference	Weight kg/lb
Installation gasket	Installation gasket for 4.3" screen	HMISTO	-	HMIZS501	-
Panel cut-out adapter	For mounting a 4.3" screen into a 3.4" STO panel cut-out	HMISTO	-	HMIZSADCO1	-
RTC battery set	For back-up of real-time clock data during power-off	HMISTO	-	HMIZSRTC1	-
Installation fastener	For mounting the screen into a solid panel	HMISTO	2	HMIZSFIX1	-
Protection sheet	4.3" wide anti-UV screen protection sheet	HMISTO	1	HMIZUV0W	-
Spring clips (replacement parts)	Spring clip for STO7●● with panel cut-out adapter	HMISTO	12	XBTZ3002	0.200/ 0.441
Power supply connector (replacement parts)	Power supply connector for all Harmony STO panels	HMISTO	5	HMIZSPWO	-
	Power supply connector for all Harmony STU panels	HMISTU	5	XBTZGPWS1	-

Connection to PCs and printers					
Used	Compatible with	Length m/ft	Peripheral side connector	Reference	Weight kg/lb
USB cable for PC connection (1)	HMISTO/STU	2.5/ 8.20	USB Type A male	XBTZG935	-
	HMISTO/STU	1.8/ 5.91	USB Type mini-B male	BMXXCAUSBH018	0.230/ 0.507
Serial printer cables	HMISTO/STU	1.8/ 5.91	9-way male SUB-D	HMIZURS	-
USB host extension cable	HMISTO/STU	2/ 6.56	USB Type A male, dust and damp proof	XBTZGUSB	0.220/ 0.485
USB device extension cable	HMISTO/STU	2/ 6.56	USB Type mini-B male, dust and damp proof	HMIZUSBB	-

(1) Adapter to be used with XBTZ925 cable.

Note: The separate components may be changed or discontinued without notice. Please check our website www.se.com for the latest information.

Harmony STO and STU

Compact color HMI panels from 3.5" to 5.7" screen
Separate components

cable_male_miniDin_RJ45



XBTZ9780

XBTZ9980_eps



XBTZ9980

Cables for connecting Harmony terminals

Type of PLC to be connected	Type of connector	Physical link	Protocol	Length m/ft	Reference	Weight kg/lb
Direct connection of HMI STO/STU terminals to Schneider Electric PLCs						
Modicon Nano, Modicon TSX Micro, Modicon Premium	Mini-DIN	RS-485	Modbus/Uni-TE	2.5/ 8.20	XBTZ9780	–
				10/ 32.81	XBTZ9782 (1)	–
Modicon M340	RJ45	RS-485	Modbus	2.5/ 8.20	XBTZ9980	–
				10/ 32.81	XBTZ9982 (1)	–
Direct connection of Harmony STO/STU terminals to Modicon STB I/O (3)						
Modicon STB	HE13 (NIM)	RS-232	Modbus	2.5/ 8.20	XBTZ9715	–
Direct connection of Harmony STO/STU terminals to Schneider Electric motor starters and drives (1)						
TeSys U, T ATV 312/32/61/71 variable speed drives ATS 48 starter Lexium 32, Preventa XPSMC	RJ45	RS-485	Modbus	2.5/ 8.20	XBTZ9980	–
Direct connection of Harmony STO/STU terminals to third-party PLCs (3)						
Allen-Bradley SLC5	9-way male SUB-D	RS-232	DF1	2.5/ 8.20	XBTZ9734	–
	Micro-logix	Micro-logix 1000	RS-232	DF1	2.5/ 8.20	XBTZ9733
Mitsubishi FX	8-way female mini-DIN	RS-232/ RS-422 converter	Melsec FX	2.5/ 8.20	XBTZ980 + (4)	–
Omron CPM1, CPM2, CJ1, CS1	9-way male SUB-D	RS-232	Symacway	2.5/ 8.20	XBTZ9743	–
Siemens S7 (PG)	9-way male SUB-D	RS-485	PPI	2.5/ 8.20	XBTZG9721	0.210/ 0.463

Bus and network connections for Harmony STO/STU terminals

Type of bus/network	Tap-off units	Type of connector	Length	Reference	Weight kg/lb
Uni-Telway serial link	Connection box TSXPACC01	8-way female mini-DIN	2.5/ 8.20	XBTZ9780	0.180/ 0.397
Modbus serial link	8-port Modbus splitter box LU9GC3, Modbus tap-off, TWDXCAISO, TWDXCAT3RJ	RJ45	2.5/ 8.20	XBTZ9980	–

(1) For Harmony XBTN200/N400/R400/RT500, use a cable with [XBTZRTPW](#) adapter and a 5 V \pm power supply.

(2) Cable included with 9-way removable screw terminal block.

(3) For [XBTRT500](#), use a cable with [XBTZRTPW](#) adapter and a 5 V \pm power supply.

(4) [XBTZG939](#) adapter to be used with cables with " + (4) " after the reference.

Note: The separate components may be changed or discontinued without notice. Please check our website www.se.com for the latest information.

B	
BMXXCAUSBH018	12
H	
HMIS5T	11
HMIS65	11
HMIS65W	11
HMIS85	11
HMIS85W	11
HMISTO705	10
HMISTO715	10
HMISTO735	10
HMISTU655	10
HMISTU655W	10
HMISTU855	10
HMISTU855W	10
HMIZS501	12
HMIZS61	11
HMIZS62	11
HMIZSADCO1	12
HMIZSCLP1	11
HMIZSCLP3	11
HMIZSFIX1	12
HMIZSPWO	12
HMIZSRTC1	12
HMIZSUKIT	11
HMIZSUSBB	12
HMIZURS	12
HMIZUV0W	12
X	
XBTZ3002	12
XBTZ9715	13
XBTZ9733	13
XBTZ9734	13
XBTZ9743	13
XBTZ9780	13
XBTZ9782	13
XBTZ980	13
XBTZ9980	13
XBTZ9982	13
XBTZG935	12
XBTZG9721	13
XBTZGPWS1	12
XBTZGUSB	12
Z	
ZB5AZ901	11
ZB5AZ905	11

mySchneider, your personalized digital experience

Access an all-in-one customized online experience and benefit from tailored business services, resources, and tools to efficiently support your business operations.

- **Efficiency:** In just a few clicks, find all the information and support you need to get the job done.
- **Simplicity:** Use a single login to access all business services, in one place, available 24/7. You no longer need to log in to multiple platforms.
- **Personalization:** Benefit from content, tools, and business services tailored to your activity, and customize your landing page based on your preferences.

Watch the How-to Videos



Order management

- > [Select Products and Add to Cart](#)
- > [Check for Products' Price and Availability](#)
- > [Order Products with Generic Commercial References](#)



Product information

- > [Find a Product Data Sheet and Related Documents](#)
- > [Select Products and Add to Cart](#)
- > [Stay Up to Date on the Status of My Products](#)



Support

- > [Get Quicker Answers Thanks to Online Support](#)

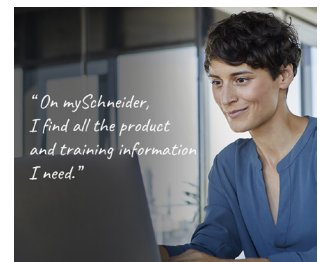

Training

- > [Access Trainings Dedicated to My Activity](#)

[Create your account](#)

Life Is 

Schneider
Electric

Legal information

The information provided in this Catalog contains description of Schneider Electric products, solutions and services ("Offer") with technical specifications and technical characteristics of the performance of the corresponding Offer.

The content of this document is subject to revision at any time without notice due to continued progress in methodology, design and manufacturing.

To the extent permitted by applicable law, no responsibility or liability is assumed by Schneider Electric and its subsidiaries for any type of damages arising out of or in connection with (i) informational content of this Catalog not conforming with or exceeding the technical specifications, or (ii) any error contained in this Catalog, or (iii) any use, decision, act or omission made or taken on basis of or in reliance on any information contained or referred to in this Catalog.

SCHNEIDER ELECTRIC MAKES NO WARRANTY OR REPRESENTATION OF ANY KIND, WHETHER EXPRESS OR IMPLIED, AS TO WHETHER THIS CATALOG OR ANY INFORMATION CONTAINED THEREIN SUCH AS PRODUCTS AND SERVICES WILL MEET REQUIREMENTS, EXPECTATIONS OR PURPOSE OF ANY PERSON MAKING USE THEREOF.

Schneider Electric brand and any trademarks of Schneider Electric and its subsidiaries referred to in this Catalog are property of Schneider Electric or its subsidiaries. All other brands are trademarks of their respective owners.

This Catalog and its content are protected under applicable copyright laws and provided for informative use only. No part of this Catalog may be reproduced or transmitted in any form or by any means (electronic, mechanical, photocopying, recording, or otherwise), for any purpose, without the prior written permission of Schneider Electric.

Copyright, intellectual, and all other proprietary rights in the content of this Catalog (including but not limited to software, audio, video, text, and photographs) rests with Schneider Electric or its licensors. All rights in such content not expressly granted herein are reserved. No rights of any kind are licensed or assigned or shall otherwise pass to persons accessing this information.

Life Is On



Learn more about our products at www.se.com/hmi

The information provided in this documentation contains general descriptions and/or technical characteristics of the performance of the products contained herein. This documentation is not intended as a substitute for and is not to be used for determining suitability or reliability of these products for specific user applications. It is the duty of any such user or integrator to perform the appropriate and complete risk analysis, evaluation and testing of the products with respect to the relevant specific application or use thereof. Neither Schneider Electric nor any of its affiliates or subsidiaries shall be responsible or liable for misuse of the information contained herein.

Design: Schneider Electric
Photos: Schneider Electric

Schneider Electric Industries SAS

Head Office
35, rue Joseph Monier - CS 30323
F-92500 Rueil-Malmaison Cedex
France

DIA5ED2130607EN
May 2024 - V6.1