

# Universal Enclosures

Protecting your equipment for more than 50 years





# Schneider Electric

Our Universal Enclosures ranges, solutions for each application



## Spacial

Metal enclosures and boxes

From our small boxes to large suitable floor-standing enclosures, with the Spacial range you can find the perfect fit for your applications. Our extensive range of easy-to-use accessories helps you save time during your projects.

Select between steel or stainless steel to better suit the installation environment. In our stainless-steel offer you can find the optimal solution where cleanliness is required, or for highly corrosive environments.



## Thalassa

Insulating enclosures

Working in difficult environments can, without the right protection, expose your installation to chemical or aggressive substances. Developed to efficiently protect it; our Thalassa offer, from boxes to floor-standing enclosures, made in fibreglass-reinforced polyester, resists in hard conditions and outdoor applications.

Our Thalassa industrial boxes in ABS or polycarbonate are strong, easy to install and designed to be used in highly demanding environments.

**New**

### Early 2016, the Thalassa polyester enclosure range changes color



#### > What products will be affected?

All our Thalassa range of polyester enclosures.

#### > What happen with the part numbers (references)?

Every product that have changed in colour have also changed the part number. It is done just adding a letter "G" at the end on reference. *Example:*

RAL 7032	RAL 7035
NSYPLM43	NSYPLM43G

#### > How can I obtain RAL 7032 enclosures?

Consult us.



## ClimaSys

Thermal management

Preserving and keeping the right temperature inside your enclosure is vital for maximising the lifetime of your installed devices. With our ClimaSys offer you can find the right solution, be it Ventilation, Cooling or Heating, including control units for temperature, humidity and much more.

# Industry and Infrastructure Offer

## A material for every environment

PB500013-55



### > Solution:

The Spacial range in steel (wall-mounting, monobloc and suitable floor-standing enclosures).

### > Steel

#### Indoor non-clean industrial environment

The industrial environment in mechanical plants is especially demanding as regards the protection of electric and electronic components against dust, splashing with oil and impacts. This environment therefore requires a range that is suited to the applications and easy to implement.

- **Standard range**, for industry.
- **E.M.C. range**, against electromagnetic disturbances (treated with Aluzinc).
- **Range of ATEX enclosures**, for potentially explosive atmospheres.

PB500014-55



### > Solution:

The Spacial range in stainless steel (wall-mounting, monobloc and suitable floor-standing enclosures).

### > 304L - 316L stainless steel

#### Demanding industrial environment

Food and beverage, pharmaceutical, petrochemical and infrastructure industries are particularly demanding in terms of hygiene and resistance to corrosion. With two grades of stainless steel:

- **304L stainless steel:**  
Resistance to corrosion and cleanability (often used in food production environments).
- **316L stainless steel, also known as "marine stainless steel":**  
Very high resistance to corrosion (saline or chlorinated environment).
- **Range of ATEX enclosures**, for potentially explosive atmospheres.

PB500015-28



PB500016-48



### > Solution:

The Thalassa range (boxes, wall-mounting and floor-standing enclosures).

### > Insulating polyester and plastic materials (ABS, polycarbonate)

#### Infrastructures and industrial environments

Outdoor infrastructures and electrical installations are exposed to direct sunlight, rain, saline mist, extreme temperatures, oil splashes, chemical and corrosive agents.

- **Standard range**, for industry and infrastructures.
- **Range of ATEX enclosures**, for potentially explosive atmospheres.

PB502732-46



PB502733-26



### > Solution:

The Thalassa PHD and Spacial S3HD and SFHD ranges (wall-mounting and floor-standing).

### > Heavy Duty materials New

#### Severe outdoor environments, generally requested by OEMs, telecom, water treatment and transportation

- Polyester Heavy Duty is suitable for outdoor public areas thanks to its multiple virtues:
  - pressure and shock resistant (IEC 61439-5: 2010),
  - anti-posting thanks to its special ribbed-surface door,
  - insulated (ready to be Class II according to IEC 61439-1: 2011).
- Steel Heavy Duty enclosures are designed for outdoor private areas:
  - they are engineered to resist aggressive environments (anti-corrosion certification class C4H, ISO 12944:1999).

# Selection tools

PE500009-185



## > [www.schneider-electric.com](http://www.schneider-electric.com)

Our web site allows you to access all the Schneider Electric products in just two clicks with direct links to:

- A complete library of technical documents, catalogues, FAQs brochures, etc.
- Certificates.
- 2D & 3D drawings.
- Selection Guides from the e-catalogue.
- Product discovery sites.



You may also find illustrated overviews, news to which you can subscribe, a list of country contacts and more useful information.

## Our software suite

60120-24



### > [Spacial.pro](#)

#### Find the right dimension for your enclosure

Spacial.pro allows you to make control panel quotations based on dimensions of electrical devices. A full project with several sets of control panels is quoted in minutes, with automatic creation of the Bill of Material and 2D drawings for front/side views.



### > [Digital Rules](#)

#### Find the accessories that suit your enclosure

The digital rules allow you to select the best components from the current product range. There will be no risk of mistake, since product and accessory selection take place automatically, saving you time and money.

PE500011-38



### > [ProClima](#)

#### Find the best thermal solution for your enclosure

Select and calculate your thermal management requirements, according to the environment and the electrical/electronic devices installed inside the enclosure.

DB300837-21



### > [Spacial.conf](#) New

#### Get your enclosure pre-engineered for your special needs

Spacial.conf software gives you total autonomy to configure and quote enclosures with services (cut-outs, painting, accessory mounting) in less than 3 minutes. Spacial.conf is designed for convenient, error-free, and time-saving orders.

Have a smartphone or a tablet? Scan this >



# The customised solutions

Over 50 years of experience, knowledge and expertise to have the best enclosure solution that meets your needs.

## Two offer levels to cover your different requirements

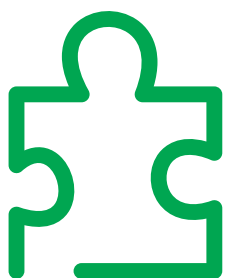

### Configured: the enriched standard offer

Feasibility automatically guaranteed by the configurator software Spacial.conf, which gives you autonomy and flexibility to quickly define your customized enclosure.

 Committed delivery date.

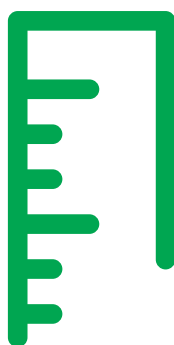

### Specific: the co-developed offer

Special dimensions, accessories and logistic needs. You participate to the whole development process of your "Tailor-made" solution.

 According to co-developed specifications.

	Steel	Stainless steel	Insulating material
Boxes	● ○	○	● ○
Wall-mounting	● ○	● ○	● ○
Compact floor-standing	● ○	● ○	● ○
Modular floor-standing	● ○	● ○	● ○

● Configured offers
○ Specific offers



### Time saving

Delivered with cut-outs & painting: no waste of time



### Logistics

- Flexible management of your logistic option (scheduled delivery service for on-going orders)
- Special packaging



### Installation simplified

Enclosures delivered with cut-outs: you don't need special tools



### Ergonomic design

Customized project dedicate to your personal concern



PE500518-1B2



### Life time increased

- Cut-outs done before painting guarantees better anti-corrosion/sealing
- Painting service for better protection



### Quality improved

- No burrs on edges of cut-outs
- Guaranteed machining tolerances



### Aesthetics

- Large choice of colours
- External surfaces with no scratches











### Higher performances

- Adapted thermal management
- Upgraded stainless steel type

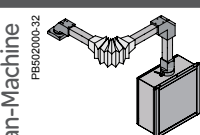
# Offers overview

## Spacial enclosures

	Steel	Stainless-steel
<b>Boxes</b>	 <p><b>SDB</b> Derivation boxes and small enclosures p. 34  <b>SBM</b> Steel industrial boxes p. 36</p> <ul style="list-style-type: none"> <li>SBMC FL21 Entry box p. 36</li> <li>SBMB Bus box p. 36</li> </ul> <p><b>Characteristics</b></p> <ul style="list-style-type: none"> <li>From 85 x 85 x 49 to 400 x 800 x 120 mm</li> <li>IP55 or IP66</li> <li>Up to IK10</li> </ul>	<p><b>Consult us</b></p>
	<p><b>Wall-mounting</b></p>  <p><b>S3D</b> Wall-mounting steel p. 48</p> <ul style="list-style-type: none"> <li>S3DEX Potentially explosive atmospheres p. 352</li> <li>S3HF Electromagnetic compatibility p. 342</li> <li>S3D 6G, S3D 6G K3 Seismic and nuclear enclosures p. 320</li> </ul> <p><b>Characteristics</b></p> <ul style="list-style-type: none"> <li>From 300 x 200 x 150 to 1400 x 1000 x 300 mm</li> <li>Up to IP66</li> <li>Up to IK10</li> </ul> <p><b>New</b></p>	
<b>Floor-standing</b>	 <p><b>SM</b> Floor-standing compact p. 108</p> <ul style="list-style-type: none"> <li>SMHF Electromagnetic compatibility p. 343</li> </ul> <p><b>SF</b> Floor-standing suitable p. 109</p> <ul style="list-style-type: none"> <li>Automobile application p. 394</li> <li>SFHF Electromagnetic compatibility p. 343</li> <li>SF 5G, SFP 5G Seismic and nuclear enclosures p. 320</li> </ul> <p><b>Characteristics</b></p> <ul style="list-style-type: none"> <li>From 1200 x 600 x 300 to 2200 x 1600 x 800 mm</li> <li>IP55</li> <li>Up to IK10</li> </ul> <p><b>New</b></p>	 <p><b>SMX</b> Floor-standing monobloc p. 160</p> <p><b>SFX</b> Floor-standing suitable p. 160</p> <p><b>Characteristics</b></p> <ul style="list-style-type: none"> <li>From 1200 x 600 x 300 to 2200 x 1600 x 800 mm</li> <li>IP66</li> <li>Up to IK10</li> </ul>
	<p><b>Outdoor</b></p>  <p><b>S3HD</b> Wall-mounting Heavy Duty enclosures p. 306</p> <p><b>SFHD</b> Floor-standing Heavy Duty enclosures p. 306</p> <p>Spacial S3HD and SFHD are engineered to resist aggressive environments (anti-corrosion certification class C4 H, ISO 12.944).</p> <p><b>Options</b></p> <p>Ventilated plinths, roof ventilation module, slim fanbox, Heavy Duty mountings.</p> <p><b>Why should I choose it?</b></p> <p>Designed to resist in outdoor private areas.</p> <p><b>Characteristics</b></p> <ul style="list-style-type: none"> <li>From 300 x 200 x 180 to 2000 x 800 x 630 mm</li> <li>Up to IP66</li> <li>IK10</li> </ul> <p><b>New</b></p>	<p><b>Consult us</b></p>
<b>Interface</b>	<p><b>Human-Machine</b></p>  <p><b>S3CM</b> Control enclosures with suspension system p. 358</p> <p><b>SD</b> Compact control desks p. 368</p> <p><b>SDF</b> Control desks with console p. 368</p> <p><b>SF</b> PC rack p. 384</p>	 <p><b>SDX</b> Control desk p. 369</p> <p><b>SMX</b> PC rack p. 388</p>
	<p><b>ClimaSys</b></p> <p><b>Thermal management</b></p>  <p><b>CV</b> Ventilation Systems p. 406</p> <p><b>CA</b> Natural airing p. 420</p> <p><b>CE</b> Exchangers p. 424</p> <p><b>CU</b> Cooling Units p. 435</p> <p><b>New</b></p>	 <p><b>CC</b> Thermal Control p. 459</p> <p><b>CR</b> Resistance Heaters p. 452</p> <p><b>New</b></p>



# Offers overview

## Thalassa enclosures

### Insulating materials



**PLS** Insulating modular boxes  
**TBP** Polycarbonate industrial boxes  
**TBS** ABS industrial boxes

p. 184  
 p. 170  
 p. 170

#### Characteristics

- From 74 x 74 x 54 to 540 x 720 x 230 mm
- Up to IP66, NEMA 4X
- Up to IK09

Details and technical datasheets available on [www.schneider-electric.com](http://www.schneider-electric.com)



**Spatial.pro**  
 Graphic configurator



**Digital Rules**  
 Enclosures selector



**Spatial.conf**  
 Services configurator



**ProClima**  
 Thermal calculation software



**PLM** Wall-mounting polyester  
 • **PLMEX** Potentially explosive atmospheres

p. 194  
 p. 352

#### Characteristics

- From 308 x 215 x 160 to 1056 x 852 x 350 mm
- Up to IP66, NEMA 4X
- Up to IK10



**PLA** Floor-standing polyester enclosures

p. 210

#### Characteristics

- From 500 x 500 x 320 to 1500 x 1250 x 420 mm
- Up to IP65, NEMA 4
- Up to IK10



**PHD** Polyester Heavy Duty enclosures

p. 306

Thalassa PHD has multiple virtues:  
 ■ pressure and shock resistant (IEC 61439-5),  
 ■ anti-posting thanks to its special front door,  
 ■ insulated (Class II).

#### Options

Anti-burglary accessory, ventilated plinths, roof ventilation module, slim fanbox.

#### Why should I choose it?

Suitable for harsh environments in outdoor public areas.

#### Characteristics

- From 500 x 500 x 320 to 2000 x 750 x 620 mm
- Up to IP65, NEMA 4
- IK10

### Accessories



Mounting

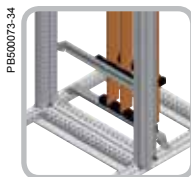

Power distribution



Cable management

New

### Project & Services



Configured offer  
 Adapted services: cut-outs, painting, assemblies...

Specific offer  
 The co-development service tailor-made for you

### Spare Parts



Cable gland plate



Doors



Door accessories



Mounting hardware



Roof accessories



---

**Selection guide** **12**

**Steel**

**New** Steel industrial boxes **33**

Steel wall-mounting enclosures **47**

Steel floor-standing enclosures **107**

---

**Stainless-steel**

Stainless-steel wall-mounting enclosures **149**

Stainless-steel floor-standing enclosures **159**

---

**Insulating materials**

Insulating boxes **169**

Insulating wall-mounting enclosures **193**

Insulating floor-standing enclosures **209**

---

**Accessories** **235**

**New** **Applicative and customised solutions** **305**

**New** **Thermal management system** **401**

---

**Technical guides and spare parts** **477**

---

**Index of references** **501**

# Selection guide

## Steel industrial boxes

### Metallic junction boxes SDB IP55

	External dimensions (mm)			Models without knock-outs	Models with knock-outs, n° of drill holes, knock-outs and group			Dimensions (mm)			Plain mounting plate	Weight (kg)
	Height (A)	Width (B)	Depth (C)	References	References	Height (A)	Width (B)	D	E	F	References	
Low cover models	85	85	49	NSYDBN88	NSYDB88M	1 n° 1	1 n° 1	58	58	-	-	0.18
	105	105	49	NSYDBN1010	NSYDB1010M	2 n° 1	1 n° 1	76	76	-	-	0.25
	155	105	61	NSYDBN1510	NSYDB1510M	3 n° 1	1 n° 2	124	74	56	NSYPMD1510	0.38
	206	156	83	NSYDBN2015	NSYDB2015M	3 n° 3	2 n° 3	172	122	78	NSYPMD2015	1
	256	206	93	NSYDBN2520	NSYDB2520M	3 n° 4	2 n° 4	220	170	88	NSYPMD2520	1.5
	307	257	116	NSYDBN3025	NSYDB3025M	2 n° 3, 2 n° 4	3 n° 4	268	218	110	NSYPMD3025	3.3
High cover models	357	307	136	NSYDBN3530	NSYDB3530M	2 n° 3, 3 n° 4	2 n° 3, 2 n° 4	318	268	130	NSYPMD3530	4.8
	155	105	88	NSYDAN1510	NSYDA1510M	3 n° 2	1 n° 2	124	74	83	NSYPMD1510	0.45
	206	156	122	NSYDAN2015	NSYDA2015M	3 n° 3	2 n° 3	172	122	121	NSYPMD2015	1.2
	256	206	140	NSYDAN2520	NSYDA2520M	3 n° 4	2 n° 4	220	170	131	NSYPMD2520	1.9

### Small metallic junction boxes SDB IP55

	External dimensions (mm)			Models without knock-outs	Dimensions (mm)				Plain mounting plate	Weight (kg)
	Height (A)	Width (B)	Depth (C)	References	D	E	F	G	References	
Low cover models	206	156	83	NSYDBN2015D	172	122	78	55	NSYPMD2015	1
	256	206	93	NSYDBN2520D	220	170	88	55	NSYPMD2520	1.5
	307	257	116	NSYDBN3025D	268	218	110	55	NSYPMD3025	3.3
	357	307	136	NSYDBN3530D	318	268	130	55	NSYPMD3530	4.8
High cover models	206	156	122	NSYDAN2015D	172	122	121	45	NSYPMD2015	1.2
	256	206	140	NSYDAN2520D	220	170	131	45	NSYPMD2520	1.9
	307	257	174	NSYDAN3025D	268	218	168	45	NSYPMD3025	4
	357	307	210	NSYDAN3530D	318	268	204	45	NSYPMD3530	5.8

### Metallic modular boxes

External dimensions (mm)			SBM range			
Height	Width	Depth	SBM	SBM	SBMB	
150	150	80	NSYSBM15158	-	-	
		120	NSYSBM151512	-	-	
	200	80	NSYSBM15208	-	-	
		120	NSYSBM152012	-	-	
	300	80	80	NSYSBM15308	-	-
			120	NSYSBM153012	NSYSBMC153012	-
		400	80	NSYSBM15408	-	-
			120	NSYSBM154012	NSYSBMC154012	-
180	130	96	-	-	-	
	165	96	-	-	-	
200	200	80	NSYSBM20208	-	-	
		120	NSYSBM202012	-	-	
	300	80	NSYSBM20308	-	-	
		120	NSYSBM203012	NSYSBMC203012	NSYSBMB203012	
	400	80	80	NSYSBM20408	-	-
			120	NSYSBM204012	NSYSBMC204012	NSYSBMB204012
		500	80	NSYSBM20508	-	-
			120	NSYSBM205012	-	-
	600	80	80	NSYSBM20608	-	-
			120	NSYSBM206012	NSYSBMC206012	NSYSBMB206012
800		120	NSYSBM208012	NSYSBMC208012	NSYSBMB208012	
		-	-	-	-	
230	210	126	-	-	-	
300	300	120	NSYSBM303012	NSYSBMC303012	-	
	400	120	NSYSBM304012	NSYSBMC304012	-	
	500	120	NSYSBM305012	-	-	
	600	120	NSYSBM306012	NSYSBMC306012	-	
	800	120	NSYSBM308012	NSYSBMC308012	-	
400	400	120	NSYSBM404012	NSYSBMC404012	-	
	500	120	NSYSBM405012	-	-	
	600	120	NSYSBM406012	NSYSBMC406012	-	
	800	120	NSYSBM408012	NSYSBMC408012	-	

# Selection guide

## Insulating industrial boxes

### Universal boxes with IP66

PB500090-16



PB500091-24



Overall external dimensions (mm)			Overall internal dimensions (mm)			Body (mm)	Cover (mm)	Material		PC-UL IP66 IK08	
Height	Width	Depth	Height	Width	Depth			ABS IP66 IK07	Transparent cover	Opaque cover	Transparent cover
74	74	54	65	65	47	37	10	NSYTBS775	-	NSYTBP775	-
89	89	54	80	80	47	37	10	NSYTBS885	-	NSYTBP885	-
116	74	62	105	65	55	45	10	NSYTBS1176	-	NSYTBP1176	-
		94	105	65	85	45	40	NSYTBS1179H	-	-	-
		62	105	105	55	45	10	NSYTBS11116	-	NSYTBP11116	-
138	93	72	125	80	65	45	20	NSYTBS1397	NSYTBS1397T	NSYTBP1397	NSYTBP1397T
		87	150	105	80	60	20	NSYTBS16128	NSYTBS16128T	NSYTBP16128	NSYTBP16128T
164	121	87	175	105	80	60	20	NSYTBS19128	NSYTBS19128T	NSYTBP19128	NSYTBP19128T
		105	175	105	100	60	40	NSYTBS191210H	NSYTBS191210HT	NSYTBP191210H	NSYTBP191210HT
		87	175	150	80	60	20	NSYTBS19168	NSYTBS19168T	NSYTBP19168	NSYTBP19168T
241	194	105	175	150	100	60	40	NSYTBS191610H	NSYTBS191610HT	NSYTBP191610H	NSYTBP191610HT
		87	225	175	80	60	20	NSYTBS24198	NSYTBS24198T	NSYTBP24198	NSYTBP24198T
		107	225	175	100	80	20	NSYTBS241910	NSYTBS241910T	NSYTBP241910	NSYTBP241910T
291	241	107	225	175	100	60	40	NSYTBS241910H	NSYTBS241910HT	NSYTBP241910H	NSYTBP241910HT
		127	225	175	120	80	40	NSYTBS241912H	NSYTBS241912HT	NSYTBP241912H	NSYTBP241912HT
		88	275	225	80	60	20	NSYTBS29248	NSYTBS29248T	NSYTBP29248	NSYTBP29248T
341	291	128	275	225	120	100	20	NSYTBS292412	NSYTBS292412T	NSYTBP292412	NSYTBP292412T
		128	275	225	120	60	60	NSYTBS292412H	NSYTBS292412HT	NSYTBP292412H	NSYTBP292412HT
		168	275	225	160	100	60	NSYTBS292416H	NSYTBS292416HT	NSYTBP292416H	NSYTBP292416HT
341	291	128	325	275	120	100	20	NSYTBS342912	NSYTBS342912T	NSYTBP342912	NSYTBP342912T
		168	325	275	160	100	60	NSYTBS342916H	NSYTBS342916HT	NSYTBP342916H	NSYTBP342916HT

### Modular boxes



Dimensions (mm)			Complete box			Complete boxes in batches		
Height	Width	Depth	Transparent cover	Opaque cover	Polyester cover	Transparent cover	Amount per batch	
180	270	180	NSYPLS1827	NSYPLSC1827	NSYPLSP1827	NSYPLS1827L	56	
270	270	180	NSYPLS2727	NSYPLSC2727	NSYPLSP2727	NSYPLS2727L	56	
		230	NSYPLS2727A	NSYPLSC2727A	NSYPLSP2736	NSYPLS2727AL	56	
360	360	180	NSYPLS2736	NSYPLSC2736	-	NSYPLS2736L	56	
		230	NSYPLS2736A	NSYPLSC2736A	NSYPLSP2754	NSYPLS2736AL	56	
540	540	180	NSYPLS2754	NSYPLSC2754	-	NSYPLS2754L	28	
		230	NSYPLS2754A	NSYPLSC2754A	NSYPLSP3636	NSYPLS2754AL	28	
360	360	180	NSYPLS3636	NSYPLSC3636	NSYPLSP3654	NSYPLS3636L	28	
		540	180	NSYPLS3654	NSYPLSC3654	-	NSYPLS3654L	28
		230	NSYPLS3654A	NSYPLSC3654A	-	NSYPLS3654AL	28	
540	540	720	230	NSYPLS3672A	NSYPLSC3672A	NSYPLSP5454	NSYPLS3672AL	27
		180	NSYPLS5454	NSYPLSC5454	-	NSYPLS5454L	14	
		230	NSYPLS5454A	NSYPLSC5454A	-	NSYPLS5454AL	14	
720	230	NSYPLS5472A	NSYPLSC5472A	-	NSYPLS5472AL	14		

# Selection guide

## Steel wall-mounting enclosures

PE60010B-15



PE60010C-12



Specifications						Spacial CRN - CRNG		
Dimensions			No. of doors	IP	Weight (1)	Plain door with mounting plate	Plain door without mounting plate	Glazed door without mounting plate
H	W	D						
<b>CRN Wall-mounting steel enclosures</b>								
200	200	150	1	66	2.5	-	NSYCRN22150 (2)	-
	300	150	1	66	3.9	-	NSYCRN23150 (2)	-
250	200	150	1	66	3.2	NSYCRN252150P	NSYCRN252150	-
300	250	150	1	66	4.2	NSYCRN325150P	NSYCRN325150	NSYCRN325150T
		200	1	66	4.9	NSYCRN325200P	NSYCRN325200	NSYCRN325200T
	300	150	1	66	5.0	NSYCRN33150P	NSYCRN33150	NSYCRN33150T
		200	1	66	6.0	NSYCRN33200P	NSYCRN33200	NSYCRN33200T
	400	200	1	66	6.4	-	NSYCRN34200	NSYCRN34200T
	450	150	1	66	6.7	-	NSYCRN345150 (2)	-
400	300	150	1	66	6.0	NSYCRN43150P	NSYCRN43150	NSYCRN43150T
		200	1	66	6.8	NSYCRN43200P	NSYCRN43200	NSYCRN43200T
	400	200	1	66	8.0	NSYCRN44200P	NSYCRN44200	NSYCRN44200T
	600	250	1	66	10.0	NSYCRN46250P	NSYCRN46250	NSYCRN46250T
		300	1	66	11.2	-	NSYCRN46300	NSYCRN46300T
500	400	150	1	66	8.7	NSYCRN54150P	NSYCRN54150	NSYCRN54150T
		200	1	66	9.8	NSYCRN54200P	NSYCRN54200	NSYCRN54200T
		250	1	66	11.0	NSYCRN54250P	NSYCRN54250	NSYCRN54250T
	500	250	1	66	12.8	NSYCRN55250P	NSYCRN55250	NSYCRN55250T
600	400	150	1	66	9.3	NSYCRN64150P	NSYCRN64150	NSYCRN64150T
		200	1	66	10.8	NSYCRN64200P	NSYCRN64200	NSYCRN64200T
		250	1	66	12.3	NSYCRN64250P	NSYCRN64250	NSYCRN64250T
	500	150	1	66	11.3	NSYCRN65150P	NSYCRN65150	NSYCRN65150T
		200	1	66	14.3	NSYCRN65200P	NSYCRN65200	NSYCRN65200T
		250	1	66	16.2	NSYCRN65250P	NSYCRN65250	NSYCRN65250T
	600	200	1	66	16.3	-	NSYCRN66200	NSYCRN66200T
		250	1	66	18.2	NSYCRN66250P	NSYCRN66250	NSYCRN66250T
		300	1	66	19.8	NSYCRN66300P	NSYCRN66300	NSYCRN66300T
	800	300	1	66	26.0	-	NSYCRN68300	NSYCRN68300T
700	500	200	1	66	17.3	NSYCRN75200P	NSYCRN75200	NSYCRN75200T
		250	1	66	19.3	NSYCRN75250P	NSYCRN75250	NSYCRN75250T
800	600	200	1	66	21.8	NSYCRN86200P	NSYCRN86200	NSYCRN86200T
		250	1	66	24.8	NSYCRN86250P	NSYCRN86250	NSYCRN86250T
		300	1	66	26.3	NSYCRN86300P	NSYCRN86300	NSYCRN86300T
	800	200	1	66	29.5	NSYCRN88200P	NSYCRN88200	NSYCRN88200T
		300	1	66	32.5	NSYCRN88300P	NSYCRN88300	NSYCRN88300T
1000	600	250	1	66	28.4	NSYCRN106250P	NSYCRN106250	NSYCRN106250T
		300	1	66	30.6	NSYCRN106300P	NSYCRN106300	NSYCRN106300T
	800	250	1	66	34.5	NSYCRN108250P	NSYCRN108250	NSYCRN108250T
		300	1	66	37.4	NSYCRN108300P	NSYCRN108300	NSYCRN108300T
<b>CRNG Wall-mounting steel enclosures with three-point locking system</b>								
800	600	400	1	66	30.0	-	NSYCRNG86400	NSYCRNG86400T
	1000	300	2	55	40.0	-	NSYCRNG810300D	-
	1200	300	2	55	46.0	-	NSYCRNG812300D	-
1000	600	400	1	66	36.0	-	NSYCRNG106400	NSYCRNG106400T
	800	400	1	66	43.0	-	NSYCRNG108400	NSYCRNG108400T
	1000	300	2 (3)	55	47.0	-	NSYCRNG1010300D	NSYCRNG1010300T
	1200	300	2	55	55.0	-	NSYCRNG1012300D	-
			400	2	55	60.0	-	NSYCRNG1012400D
1200	600	300	1	66	37.0	-	NSYCRNG126300	NSYCRNG126300T
		400	1	66	42.0	-	NSYCRNG126400	NSYCRNG126400T
	800	300	1	66	45.0	-	NSYCRNG128300	NSYCRNG128300T
		400	1	66	50.0	-	NSYCRNG128400	NSYCRNG128400T
	1000	300	2	55	56.0	-	NSYCRNG1210300D	-
		400	2	55	61.0	-	NSYCRNG1210400D	-
	1200	300	2	55	64.0	-	NSYCRNG1212300D	-
		400	2	55	90.0	-	NSYCRNG1212400D	-
	1400	1000	300	2	55	80.0	-	NSYCRNG1410300D

(1) Enclosure without mounting plate.  
 (2) Two cable gland plates, one on the top, one on the bottom.  
 (3) Except glazed door in single door.

# Selection guide

## Steel wall-mounting enclosures



Mounting plate				Accessories		
Plain	Silkscreened	Microperforated	Telequick	Bakelite	DIN rails chassis	Step slides
NSYMM22	-	-	-	-	-	-
NSYMM32	-	NSYMF32	-	NSYMB32	-	-
NSYMM2520	-	-	-	-	-	-
NSYMM3025	-	-	NSYMR3025	NSYMB3025	-	-
NSYMM3025	-	-	NSYMR3025	NSYMB3025	-	NSYSDCR200
NSYMM33	-	NSYMF33	NSYMR33	NSYMB33	NSYMD33	-
NSYMM33	-	NSYMF33	NSYMR33	NSYMB33	NSYMD33	NSYSDCR200
NSYMM43	NSYMS43	NSYMF43	NSYMR34	NSYMB43	-	NSYSDCR200
NSYMM3045	-	-	-	NSYMB43	-	-
NSYMM43	NSYMS43	NSYMF43	NSYMR43	NSYMB43	NSYMD43	-
NSYMM43	NSYMS43	NSYMF43	NSYMR43	NSYMB43	NSYMD43	NSYSDCR200
NSYMM44	NSYMS44	NSYMF44	NSYMR44	-	-	NSYSDCR200
NSYMM64	NSYMS64	NSYMF64	NSYMR46	NSYMB64	-	NSYSDCR250
NSYMM64	NSYMS64	NSYMF64	NSYMR46	NSYMB64	-	NSYSDCR300
NSYMM54	NSYMS54	NSYMF54	NSYMR54	NSYMB54	NSYMD54	-
NSYMM54	NSYMS54	NSYMF54	NSYMR54	NSYMB54	NSYMD54	NSYSDCR200
NSYMM54	NSYMS54	NSYMF54	NSYMR54	NSYMB54	NSYMD54	NSYSDCR250
NSYMM55	NSYMS55	NSYMF55	NSYMR55	-	-	NSYSDCR250
NSYMM64	NSYMS64	NSYMF64	NSYMR64	NSYMB64	NSYMD64	-
NSYMM64	NSYMS64	NSYMF64	NSYMR64	NSYMB64	NSYMD64	NSYSDCR200
NSYMM64	NSYMS64	NSYMF64	NSYMR64	NSYMB64	NSYMD64	NSYSDCR250
NSYMM65	-	NSYMF65	NSYMR65	NSYMB65	-	-
NSYMM65	-	NSYMF65	NSYMR65	NSYMB65	-	NSYSDCR200
NSYMM65	-	NSYMF65	NSYMR65	NSYMB65	-	NSYSDCR250
NSYMM66	NSYMS66	NSYMF66	NSYMR66	-	NSYMD66	NSYSDCR200
NSYMM66	NSYMS66	NSYMF66	NSYMR66	-	NSYMD66	NSYSDCR250
NSYMM66	NSYMS66	NSYMF66	NSYMR66	-	NSYMD66	NSYSDCR300
NSYMM86	NSYMS86	NSYMF86	NSYMR86	-	-	NSYSDCR300
NSYMM75	NSYMS75	NSYMF75	NSYMR75	NSYMB75	NSYMD75	NSYSDCR200
NSYMM75	NSYMS75	NSYMF75	NSYMR75	NSYMB75	NSYMD75	NSYSDCR250
NSYMM86	NSYMS86	NSYMF86	NSYMR86	NSYMB86	NSYMD86	NSYSDCR200
NSYMM86	NSYMS86	NSYMF86	NSYMR86	NSYMB86	NSYMD86	NSYSDCR250
NSYMM86	NSYMS86	NSYMF86	NSYMR86	NSYMB86	NSYMD86	NSYSDCR300
NSYMM88	-	NSYMF88	NSYMR88	-	-	NSYSDCR200
NSYMM86	-	NSYMF88	NSYMR88	-	-	NSYSDCR300
NSYMM106	-	NSYMF106	NSYMR106	NSYMB106	-	NSYSDCR250
NSYMM106	-	NSYMF106	NSYMR106	NSYMB106	-	NSYSDCR300
NSYMM108	-	NSYMF108	NSYMR108	NSYMB108	NSYMD108	NSYSDCR250
NSYMM108	-	NSYMF108	NSYMR108	NSYMB108	NSYMD108	NSYSDCR300
NSYMM86	NSYMS86	NSYMF86	NSYMR86	NSYMB86	NSYMD86	NSYSDCR400
NSYMM108	-	NSYMF108	NSYMR810	-	-	NSYSDCR300
NSYMM128	-	NSYMF128	2 x NSYMR86*	-	-	NSYSDCR300**
NSYMM106	-	NSYMF106	NSYMR106	NSYMB106	-	NSYSDCR400
NSYMM108	-	NSYMF108	NSYMR108	NSYMB108	NSYMD108	NSYSDCR400
NSYMM1010	-	NSYMF1010	NSYMR1010 (4)	NSYMB1210	-	NSYSDCR300
NSYMM1210	-	NSYMF1210	NSYMR1012 (4)	NSYMB1210	-	NSYSDCR300**
NSYMM1210	-	NSYMF1210	NSYMR1012 (4)	-	-	NSYSDCR400**
NSYMM126	-	NSYMF126	NSYMR126	-	-	NSYSDCR300
NSYMM126	-	NSYMF126	NSYMR126	-	-	NSYSDCR400
NSYMM128	-	NSYMF128	NSYMR128	-	NSYMD128	NSYSDCR300
NSYMM128	-	NSYMF128	NSYMR128	-	NSYMD128	NSYSDCR400
NSYMM1210	-	NSYMF1210	NSYMR1210 (4)	NSYMB1210	-	NSYSDCR300
NSYMM1210	-	NSYMF1210	NSYMR1210 (4)	NSYMB1210	-	NSYSDCR400
NSYMM1212	-	2 x NSYMF126*	2 x NSYMR126*	-	-	NSYSDCR300**
NSYMM1212	-	2 x NSYMF126*	2 x NSYMR126*	-	-	NSYSDCR400**
NSYMM1410	-	-	NSYMR1410 (4)	-	-	NSYSDCR300

(4) Ref. NSYEMR mandatory.

\* Order NSYCRNGSDR to mount double mounting plate.

\*\* Except for double mounting plate, order in addition ref. NSYSDRSDCR300 (D300) or NSYSDRSDCR400 (D400).

# Selection guide

## Wall-mounting enclosures



Dimensions (mm and Inches)						Number of doors	IP	Spacial S3DC painted steel enclosures	Spacial S3X Stainless steel 304L
H (mm)	W (mm)	D (mm)	H (in.)	W (in.)	D (in.)			Plain door without mounting plate	Plain door without mounting plate
300	200	150	11.81	7.87	5.91	1	66	NSYS3DC3215	NSYS3X3215
300	300	150	11.81	11.81	5.91	1	66	NSYS3DC3315	NSYS3X3315
300	300	200	11.81	11.81	7.87	1	66	NSYS3DC3320	-
400	300	150	15.75	11.81	5.91	1	66	NSYS3DC4315	NSYS3X4315
400	300	200	15.75	11.81	7.87	1	66	NSYS3DC4320	NSYS3X4320
400	400	200	15.75	15.75	7.87	1	66	NSYS3DC4420	NSYS3X4420
500	400	200	19.69	15.75	7.87	1	66	NSYS3DC5420	NSYS3X5420
500	400	250	19.69	15.75	9.84	1	66	NSYS3DC5425	-
500	500	200	19.69	19.69	7.87	1	66	NSYS3DC5520	-
500	500	250	19.69	19.69	9.84	1	66	NSYS3DC5525	-
600	400	200	23.62	15.75	7.87	1	66	NSYS3DC6420	NSYS3X6420
600	400	250	23.62	15.75	9.84	1	66	NSYS3DC6425	-
600	600	200	23.62	23.62	7.87	1	66	NSYS3DC6620	-
600	600	250	23.62	23.62	9.84	1	66	NSYS3DC6625	NSYS3X6625
600	600	300	23.62	23.62	11.81	1	66	NSYS3DC6630	-
700	500	250	27.56	19.69	9.84	1	66	NSYS3DC7525	NSYS3X7525
800	600	200	31.50	23.62	7.87	1	66	NSYS3DC8620	-
800	600	250	31.50	23.62	9.84	1	66	NSYS3DC8625	NSYS3X8625
800	600	300	31.50	23.62	11.81	1	66	NSYS3DC8630	-
800	600	400	31.50	23.62	15.75	1	66	NSYS3DC8640	-
800	800	250	31.50	31.50	9.84	1	66	NSYS3DC8825	-
800	800	300	31.50	31.50	11.81	1	66	NSYS3DC8830	NSYS3X8830
1000	600	250	39.37	23.62	9.84	1	66	NSYS3D10625	-
1000	800	250	39.37	31.50	9.84	1	66	NSYS3DC10825	-
1000	800	300	39.37	31.50	11.81	1	66	NSYS3DC10830	NSYS3X10830
1000	800	400	39.37	31.50	15.75	1	66	NSYS3DC10840	-
1000	1000	300	39.37	39.37	11.81	1	66	NSYS3DC101030	-
1200	800	300	47.24	31.50	11.81	1	66	NSYS3DC12830	NSYS3X12830
1200	800	400	47.24	31.50	15.75	1	66	NSYS3DC12840	-
1200	1000	300	47.24	39.37	11.81	1	66	NSYS3DC121030	-

Wall mounting bracket (x4)		
	Steel	NSYAEFPFSC
	Stainless steel	NSYPFPCX
	Polyester	NSYPFPLM

Lighting		
	Neon light magnetic or mechanical mounting	NSYLAM75
	Door contact S3DC/S3X	NSYINLCRN

Mounting		
	M6 nut for PLM direct mounting	NSYTCSPML
	Self-tapping screw for microperforated mounting plate	NSYS13M5HS
	Hexagonal screw M6 x 12 for alum. upright	NSYS12M6H
	Hexagonal screw M6 x 16 for alum. upright	NSYS16M6H
	Hexagonal screw M6 x 18 for alum. upright	NSYS18M6H
	M6 nut for alum. upright	NSYNM6

Door accessories		
	Door cable trunking support for Ø 0.86 in / 22 mm (x10)	NSYSPCP
	Plastic document pocket A4, d = 20 mm	NSYDPA4
	Plastic document pocket A4, d = 40 mm	NSYDPA44
	Plastic window 248 x 235 x 13	NSYVA2736M
	Plastic window 78 x 95 x 15	NSYVA274M



# Selection guide

for applicative and customised solutions  
wall-mounting enclosures



	Spacial S3XH Stainless steel 316L	Thalassa PLM Polyester	Plain mounting plate painted white	Plain mounting plate galvanized	Microperforated mounting plate	Perforated (Telequick)*	Aluminum upright**
	Plain door without mounting plate	Plain door without mounting plate					
	NSYS3X3215H	NSYPLM32	NSYMM32WH	NSYMM32	NSYMF32	NSYMR32	NSYMDVR3
	NSYS3X3315H	-	NSYMM33WH	NSYMM33	NSYMF33	NSYMR33	NSYMDVR3
	-	-	NSYMM33WH	NSYMM33	NSYMF33	NSYMR33	NSYMDVR3
	NSYS3X4315H	-	NSYMM43WH	NSYMM43	NSYMF43	NSYMR43	NSYMDVR4
	NSYS3X4320H	NSYPLM43	NSYMM43WH	NSYMM43	NSYMF43	NSYMR43	NSYMDVR4
	NSYS3X4420H	-	NSYMM44WH	NSYMM44	NSYMF44	NSYMR44	NSYMDVR4
	NSYS3X5420H	NSYPLM54	NSYMM54WH	NSYMM54	NSYMF54	NSYMR54	NSYMDVR5
	-	-	NSYMM54WH	NSYMM54	NSYMF54	NSYMR54	NSYMDVR5
	-	-	NSYMM55WH	NSYMM55	NSYMF55	NSYMR55	NSYMDVR5
	-	-	NSYMM55WH	NSYMM55	NSYMF55	NSYMR55	NSYMDVR5
	NSYS3X6420H	-	NSYMM64WH	NSYMM64	NSYMF64	NSYMR64	NSYMDVR6
	-	NSYPLM64	NSYMM64WH	NSYMM64	NSYMF64	NSYMR64	NSYMDVR6
	-	-	NSYMM66WH	NSYMM66	NSYMF66	NSYMR66	NSYMDVR6
	NSYS3X6625H	-	NSYMM66WH	NSYMM66	NSYMF66	NSYMR66	NSYMDVR6
	-	-	NSYMM66WH	NSYMM66	NSYMF66	NSYMR66	NSYMDVR6
	NSYS3X7525H	-	NSYMM75WH	NSYMM75	NSYMF75	NSYMR75	NSYMDVR7
	-	-	NSYMM86WH	NSYMM86	NSYMF86	NSYMR86	NSYMDVR8
	NSYS3X8625H	-	NSYMM86WH	NSYMM86	NSYMF86	NSYMR86	NSYMDVR8
	-	NSYPLM86	NSYMM86WH	NSYMM86	NSYMF86	NSYMR86	NSYMDVR8
	-	-	NSYMM86WH	NSYMM86	NSYMF86	NSYMR86	NSYMDVR8
	-	-	NSYMM88WH	NSYMM88	NSYMF88	NSYMR88	NSYMDVR8
	NSYS3X8830H	-	NSYMM88WH	NSYMM88	NSYMF88	NSYMR88	NSYMDVR8
	-	-	NSYMM106WH	NSYMM106	NSYMF106	NSYMR106	NSYMDVR10
	-	-	NSYMM108WH	NSYMM108	NSYMF108	NSYMR108	NSYMDVR10
	NSYS3X10830H	NSYPLM108	NSYMM108WH	NSYMM108	NSYMF108	NSYMR108	NSYMDVR10
	-	-	NSYMM108WH	NSYMM108	NSYMF108	NSYMR108	NSYMDVR10
	-	-	NSYMM1010WH	NSYMM1010	NSYMF1010	NSYMR1010	NSYMDVR10
	NSYS3X12830H	-	NSYMM128WH	NSYMM128	NSYMF128	NSYMR128	NSYMDVR12
	-	-	NSYMM128WH	NSYMM128	NSYMF128	NSYMR128	NSYMDVR12
	-	-	NSYMM1210WH	NSYMM1210	NSYMF1210	NSYMR1210	NSYMDVR12

\*NSYEMR is mandatory for Spacial S3DC enclosure width > 1000 mm.

\*\*NSYAMCSF mandatory for S3DC and S3X enclosures.

Grounding	
	Grounding lead 160, sec.6² <b>NSYEL166D8</b>
	Grounding lead L350, sec.25² <b>NSYEL3525D8</b>
	Grounding strip connection points 87 <b>NSYECB1M153</b>
	2 grounding collector supports <b>NSYEDCOS</b>
	2 grounding collector rail supports <b>NSYEDCOC</b>

Locking system	
	Screwdriver insert for Thalassa PLM <b>NSYAEDLSD</b>

# Selection guide

## Steel floor-standing enclosures

**SM**

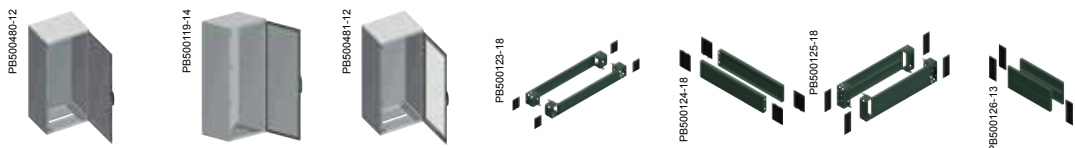

Characteristics			Door			Plinth					
Dimensions (mm)			No. of doors	Plain		Transparent	Height 100 mm		Height 200 mm		
H (A)	W (B)	D (C)		With mounting plate	Without mounting plate	Without mounting plate	Front kit (corners + front panels)	Side panels, 2 u.	Front kit (corners + front panels)	Side panels, 4 u.	
1200	800	300	1	NSYSM12830P	NSYSM12830	-	NSYSPF8100	NSYSPS3100	NSYSPF8200	NSYSPS3200	
	1000	300	2	NSYSM1210302DP	NSYSM1210302D	-	NSYSPF10100	NSYSPS3100	NSYSPF10200	NSYSPS3200	
	1200	400	2	NSYSM1212402DP	NSYSM1212402D	-	NSYSPF12100	NSYSPS4100	NSYSPF12200	NSYSPS4200	
1400	600	300	1	NSYSM14630P	NSYSM14630	-	NSYSPF6100	NSYSPS3100	NSYSPF6200	NSYSPS3200	
		400	1	NSYSM14640P	NSYSM14640	-	NSYSPF6100	NSYSPS4100	NSYSPF6200	NSYSPS4200	
	800	300	1	NSYSM14830P	NSYSM14830	-	NSYSPF8100	NSYSPS3100	NSYSPF8200	NSYSPS3200	
		400	1	NSYSM14840P	NSYSM14840	NSYSM14840T	NSYSPF8100	NSYSPS4100	NSYSPF8200	NSYSPS4200	
		1000	400	2	NSYSM1410402DP	NSYSM1410402D	-	NSYSPF10100	NSYSPS4100	NSYSPF10200	NSYSPS4200
		1200	400	2	NSYSM1412402DP	NSYSM1412402D	-	NSYSPF12100	NSYSPS4100	NSYSPF12200	NSYSPS4200
1600	600	300	1	NSYSM16630P	NSYSM16630	-	NSYSPF6100	NSYSPS3100	NSYSPF6200	NSYSPS3200	
		400	1	NSYSM16640P	NSYSM16640	NSYSM16640T	NSYSPF6100	NSYSPS4100	NSYSPF6200	NSYSPS4200	
	800	300	1	NSYSM16830P	NSYSM16830	NSYSM16830T	NSYSPF8100	NSYSPS3100	NSYSPF8200	NSYSPS3200	
		400	1	NSYSM16840P	NSYSM16840	NSYSM16840T	NSYSPF8100	NSYSPS4100	NSYSPF8200	NSYSPS4200	
	1000	300	2	NSYSM1610302DP	NSYSM1610302D	-	NSYSPF10100	NSYSPS3100	NSYSPF10200	NSYSPS3200	
		400	2	NSYSM1610402DP	NSYSM1610402D	-	NSYSPF10100	NSYSPS4100	NSYSPF10200	NSYSPS4200	
	1200	300	2	NSYSM1612302DP	NSYSM1612302D	-	NSYSPF12100	NSYSPS3100	NSYSPF12200	NSYSPS3200	
		400	2	NSYSM1612402DP	NSYSM1612402D	-	NSYSPF12100	NSYSPS4100	NSYSPF12200	NSYSPS4200	
	1800	600	300	1	NSYSM18630P	NSYSM18630	-	NSYSPF6100	NSYSPS3100	NSYSPF6200	NSYSPS3200
			400	1	NSYSM18640P	NSYSM18640	NSYSM18640T	NSYSPF6100	NSYSPS4100	NSYSPF6200	NSYSPS4200
			500	1	NSYSM18650P	NSYSM18650	-	NSYSPF6100	NSYSPS5100	NSYSPF6200	NSYSPS5200
		800	300	1	NSYSM18830P	NSYSM18830	NSYSM18830T	NSYSPF8100	NSYSPS3100	NSYSPF8200	NSYSPS3200
400			1	NSYSM18840P	NSYSM18840	NSYSM18840T	NSYSPF8100	NSYSPS4100	NSYSPF8200	NSYSPS4200	
500			1	NSYSM18850P	NSYSM18850	NSYSM18850T	NSYSPF8100	NSYSPS5100	NSYSPF8200	NSYSPS5200	
600		300	1	NSYSM18860P	NSYSM18860	-	NSYSPF8100	NSYSPS6100	NSYSPF8200	NSYSPS6200	
		400	1	NSYSM181040P	NSYSM181040	-	NSYSPF10100	NSYSPS4100	NSYSPF10200	NSYSPS4200	
			2	NSYSM1810402DP	NSYSM1810402D	-	NSYSPF10100	NSYSPS4100	NSYSPF10200	NSYSPS4200	
500		2	NSYSM1810502DP	NSYSM1810502D	-	NSYSPF10100	NSYSPS5100	NSYSPF10200	NSYSPS5200		
		400	2	NSYSM1812402DP	NSYSM1812402D	-	NSYSPF12100	NSYSPS4100	NSYSPF12200	NSYSPS4200	
			2	NSYSM1812502DP	NSYSM1812502D	-	NSYSPF12100	NSYSPS5100	NSYSPF12200	NSYSPS5200	
1600		400	2	NSYSM1816402DP	NSYSM1816402D	-	NSYSPF16100	NSYSPS4100	NSYSPF16200	NSYSPS4200	
		500	2	NSYSM1816502DP	NSYSM1816502D	-	NSYSPF16100	NSYSPS5100	NSYSPF16200	NSYSPS5200	
		600	2	NSYSM1816502DP	NSYSM1816502D	-	NSYSPF16100	NSYSPS6100	NSYSPF16200	NSYSPS6200	
2000		600	300	1	NSYSM20630P	NSYSM20630	-	NSYSPF6100	NSYSPS3100	NSYSPF6200	NSYSPS3200
			400	1	NSYSM20640P	NSYSM20640	NSYSM20640T	NSYSPF6100	NSYSPS4100	NSYSPF6200	NSYSPS4200
			500	1	NSYSM20650P	NSYSM20650	-	NSYSPF6100	NSYSPS5100	NSYSPF6200	NSYSPS5200
	800	300	1	NSYSM20830P	NSYSM20830	NSYSM20830T	NSYSPF8100	NSYSPS3100	NSYSPF8200	NSYSPS3200	
		400	1	NSYSM20840P	NSYSM20840	NSYSM20840T	NSYSPF8100	NSYSPS4100	NSYSPF8200	NSYSPS4200	
		500	1	NSYSM20850P	NSYSM20850	NSYSM20850T	NSYSPF8100	NSYSPS5100	NSYSPF8200	NSYSPS5200	
	600	1	NSYSM20860P	NSYSM20860	NSYSM20860T	NSYSPF8100	NSYSPS6100	NSYSPF8200	NSYSPS6200		
		400	2	NSYSM2010402DP	NSYSM2010402D	-	NSYSPF10100	NSYSPS4100	NSYSPF10200	NSYSPS4200	
			2	NSYSM2010502DP	NSYSM2010502D	-	NSYSPF10100	NSYSPS5100	NSYSPF10200	NSYSPS5200	
	1200	400	2	NSYSM2012402DP	NSYSM2012402D	-	NSYSPF12100	NSYSPS4100	NSYSPF12200	NSYSPS4200	
		500	2	NSYSM2012502DP	NSYSM2012502D	-	NSYSPF12100	NSYSPS5100	NSYSPF12200	NSYSPS5200	
		600	2	NSYSM2012602DP	NSYSM2012602D	-	NSYSPF12100	NSYSPS6100	NSYSPF12200	NSYSPS6200	
	1600	400	2	NSYSM2016402DP	NSYSM2016402D	-	NSYSPF16100	NSYSPS4100	NSYSPF16200	NSYSPS4200	
		500	2	NSYSM2016502DP	NSYSM2016502D	-	NSYSPF16100	NSYSPS5100	NSYSPF16200	NSYSPS5200	
		600	2	NSYSM2016602DP	NSYSM2016602D	-	NSYSPF16100	NSYSPS6100	NSYSPF16200	NSYSPS6200	

➤ Specific accessories overview page 120

# Selection guide

## Steel floor-standing enclosures

**SM**

PE500475-12



PE500477-7



PE500482-10



PE500483-13



PE500473-12



Characteristics			Inner door	Mounting plate	Vertical uprights		Off-centre 19" swing rack	Centred 19" swing rack		
Dimensions (mm)					Standard	Technical				
H (A)	W (B)	D (C)	No. of doors							
1200	800	300	1	-	NSYMP128	-	NSYTVR12	-	-	
	1000	300	2	-	NSYMP1210	-	NSYTVR12	-	-	
	1200	400	2	-	NSYMP1212	-	NSYTVR12	-	-	
1400	600	300	1	-	NSYMP146	-	NSYTVR14	-	-	
		400	1	-	NSYMP146	-	NSYTVR14	-	-	
	800	300	1	-	NSYMP148	-	NSYTVR14	NSYRSW27	NSYRSWC27	
		400	1	-	NSYMP148	-	NSYTVR14	NSYRSW27	NSYRSWC27	
	1000	400	2	-	NSYMP1410	-	NSYTVR14	-	-	
	1200	400	2	-	NSYMP1412	-	NSYTVR14	-	-	
1600	600	300	1	NSYID166	NSYMP166	-	NSYTVR16	-	-	
		400	1	NSYID166	NSYMP166	-	NSYTVR16	-	-	
	800	300	1	NSYID168	NSYMP168	-	NSYTVR16	NSYRSW31	NSYRSWC31	
		400	1	NSYID168	NSYMP168	-	NSYTVR16	NSYRSW31	NSYRSWC31	
	1000	300	2	-	NSYMP1610	-	NSYTVR16	-	-	
		400	2	-	NSYMP1610	-	NSYTVR16	-	-	
	1200	300	2	-	NSYMP1612	-	NSYTVR16	-	-	
		400	2	-	NSYMP1612	-	NSYTVR16	-	-	
	1800	600	300	1	NSYID186	NSYMP186	NSYVR18	NSYTVR18	-	-
			400	1	NSYID186	NSYMP186	NSYVR18	NSYTVR18	-	-
500			1	NSYID186	NSYMP186	NSYVR18	NSYTVR18	-	-	
800		300	1	NSYID188	NSYMP188	NSYVR18	NSYTVR18	NSYRSW36	NSYRSWC36	
		400	1	NSYID188	NSYMP188	NSYVR18	NSYTVR18	NSYRSW36	NSYRSWC36	
		500	1	NSYID188	NSYMP188	NSYVR18	NSYTVR18	NSYRSW36	NSYRSWC36	
		600	1	NSYID188	NSYMP188	NSYVR18	NSYTVR18	NSYRSW36	NSYRSWC36	
1000		400	1	NSYID1810	NSYMP1810	NSYVR18	NSYTVR18	-	-	
		400	2	NSYID1810	NSYMP1810	NSYVR18	NSYTVR18	-	-	
		500	2	NSYID1810	NSYMP1810	NSYVR18	NSYTVR18	-	-	
1200		400	2	-	NSYMP1812	NSYVR18	NSYTVR18	-	-	
		500	2	-	NSYMP1812	NSYVR18	NSYTVR18	-	-	
1600		400	2	-	NSYMP1816	NSYVR18	NSYTVR18	-	-	
		500	2	-	NSYMP1816	NSYVR18	NSYTVR18	-	-	
2000		600	300	1	NSYID206	NSYMP206	NSYVR20	NSYTVR20	-	-
			400	1	NSYID206	NSYMP206	NSYVR20	NSYTVR20	-	-
	500		1	NSYID206	NSYMP206	NSYVR20	NSYTVR20	-	-	
	800	300	1	NSYID208	NSYMP208	NSYVR20	NSYTVR20	NSYRSW40	NSYRSWC40	
		400	1	NSYID208	NSYMP208	NSYVR20	NSYTVR20	NSYRSW40	NSYRSWC40	
		500	1	NSYID208	NSYMP208	NSYVR20	NSYTVR20	NSYRSW40	NSYRSWC40	
		600	1	NSYID208	NSYMP208	NSYVR20	NSYTVR20	NSYRSW40	NSYRSWC40	
	1000	400	2	NSYID2010	NSYMP2010	NSYVR20	NSYTVR20	-	-	
		500	2	NSYID2010	NSYMP2010	NSYVR20	NSYTVR20	-	-	
	1200	400	2	-	NSYMP2012	NSYVR20	NSYTVR20	-	-	
		500	2	-	NSYMP2012	NSYVR20	NSYTVR20	-	-	
		600	2	-	NSYMP2012	NSYVR20	NSYTVR20	-	-	
	1600	400	2	-	NSYMP2016	NSYVR20	NSYTVR20	-	-	
		500	2	-	NSYMP2016	NSYVR20	NSYTVR20	-	-	
		600	2	-	NSYMP2016	NSYVR20	NSYTVR20	-	-	

# Selection guide

## Steel floor-standing enclosures

SF

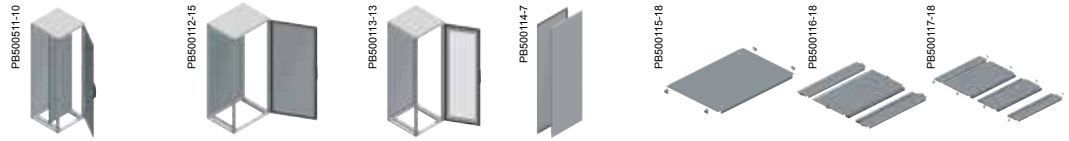

Nominal dimensions (mm)			No. of doors	Door			Side panels	Cable-entry plate			
Height (A)	Width (B)	Depth (C)		Plain	Transparent			Plain	1 entry	2 entries	
				With mounting plate	Without mounting plate	Without mounting plate					
1200	600	400	1	NSYSF12640P	NSYSF12640	-	NSY2SP124	NSYEC64	NSYEC641	-	
		600	1	NSYSF12660P	NSYSF12660	-	NSY2SP126	NSYEC66	NSYEC661	NSYEC662	
	800	400	1	NSYSF12840P	NSYSF12840	-	NSY2SP124	NSYEC84	NSYEC841	-	
1400	600	600	1	NSYSF12860P	NSYSF12860	-	NSY2SP126	NSYEC86	NSYEC861	NSYEC862	
		400	1	NSYSF14640P	NSYSF14640	-	NSY2SP144	NSYEC64	NSYEC641	-	
	800	400	1	NSYSF14840P	NSYSF14840	-	NSY2SP144	NSYEC84	NSYEC841	-	
1600	600	600	1	NSYSF16660P	NSYSF16660	-	NSY2SP166	NSYEC66	NSYEC661	NSYEC662	
		800	1	NSYSF16680P	NSYSF16680	-	NSY2SP168	NSYEC68	NSYEC681	NSYEC682	
	800	600	1	NSYSF16860P	NSYSF16860	-	NSY2SP166	NSYEC86	NSYEC861	NSYEC862	
1800	400	400	1	-	NSYSF18440	-	NSY2SP184	NSYEC44	NSYEC441	-	
		500	1	-	NSYSF18450	-	NSY2SP185	NSYEC45	NSYEC451	-	
		600	1	-	NSYSF18460	-	NSY2SP186	-	NSYEC461	-	
	600	400	1	NSYSF18640P	NSYSF18640	NSYSF18640T	NSY2SP184	NSYEC64	NSYEC641	-	
		500	1	NSYSF18650P	NSYSF18650	NSYSF18650T	NSY2SP185	NSYEC65	NSYEC651	-	
		600	1	NSYSF18660P	NSYSF18660	-	NSY2SP186	NSYEC66	NSYEC661	NSYEC662	
	800	400	1	-	-	NSYSF18680T	NSY2SP188	NSYEC68	NSYEC681	NSYEC682	
		400	1	NSYSF18840P	NSYSF18840	NSYSF18840T	NSY2SP184	NSYEC84	NSYEC841	-	
		500	1	NSYSF18850P	NSYSF18850	NSYSF18850T	NSY2SP185	NSYEC85	NSYEC851	-	
	1000	600	600	1	NSYSF18860P	NSYSF18860	NSYSF18860T	NSY2SP186	NSYEC86	NSYEC861	NSYEC862
			600	2	NSYSF188602DP	NSYSF188602D	-	NSY2SP186	NSYEC86	NSYEC861	NSYEC862
			400	1	NSYSF181040P	NSYSF181040	-	NSY2SP184	NSYEC104	NSYEC1041	-
1200		400	2	NSYSF1810402DP	NSYSF1810402D	-	NSY2SP184	NSYEC104	NSYEC1041	-	
		500	1	NSYSF181050P	NSYSF181050	-	NSY2SP185	NSYEC105	NSYEC1051	-	
		600	1	NSYSF181060P	NSYSF181060	-	NSY2SP186	NSYEC106	NSYEC1061	NSYEC1062	
2000	300	600	2	NSYSF1810602DP	NSYSF1810602D	-	NSY2SP186	NSYEC106	NSYEC1061	NSYEC1062	
		400	2	NSYSF1812402DP	NSYSF1812402D	-	NSY2SP184	NSYEC124	NSYEC1241	-	
		500	2	NSYSF1812502DP	NSYSF1812502D	-	NSY2SP185	NSYEC125	NSYEC1251	-	
	400	600	2	NSYSF1812602DP	NSYSF1812602D	-	NSY2SP186	NSYEC126	NSYEC1261	NSYEC1262	
		500	1	-	NSYSF20350	-	NSY2SP205	NSYEC35	NSYEC351	-	
		600	1	-	NSYSF20360	-	NSY2SP206	NSYEC36	NSYEC361	-	
2200	400	800	1	-	NSYSF20380	-	NSY2SP208	-	NSYEC381	-	
		400	1	-	NSYSF20440	-	NSY2SP204	NSYEC44	NSYEC441	-	
		500	1	-	NSYSF20450	-	NSY2SP205	NSYEC45	NSYEC451	-	
	600	600	1	-	NSYSF20460	-	NSY2SP206	NSYEC64	NSYEC641	-	
		800	1	-	NSYSF20480	-	NSY2SP208	NSYEC84	NSYEC841	-	
		400	1	NSYSF20640P	NSYSF20640	NSYSF20640T	NSY2SP204	NSYEC64	NSYEC641	-	
	800	500	1	NSYSF20650P	NSYSF20650	NSYSF20650T	NSY2SP205	NSYEC65	NSYEC651	-	
		600	1	NSYSF20660P	NSYSF20660	-	NSY2SP206	NSYEC66	NSYEC661	NSYEC662	
		800	1	NSYSF20680P	NSYSF20680	-	NSY2SP208	NSYEC68	NSYEC681	NSYEC682	
		400	1	NSYSF20840P	NSYSF20840	NSYSF20840T	NSY2SP204	NSYEC84	NSYEC841	-	
		500	1	NSYSF20850P	NSYSF20850	NSYSF20850T	NSY2SP205	NSYEC85	NSYEC851	-	
		600	1	NSYSF20860P	NSYSF20860	NSYSF20860T	NSY2SP206	NSYEC86	NSYEC861	NSYEC862	
1000	600	2	NSYSF208602DP	NSYSF208602D	-	NSY2SP206	NSYEC86	NSYEC861	NSYEC862		
	800	1	NSYSF20880P	NSYSF20880	NSYSF20880T	NSY2SP208	NSYEC88	NSYEC881	NSYEC882		
	400	1	NSYSF201040P	NSYSF201040	NSYSF201040T	NSY2SP204	NSYEC104	NSYEC1041	-		
	400	2	NSYSF2010402DP	NSYSF2010402D	-	NSY2SP204	NSYEC104	NSYEC1041	-		
	500	1	NSYSF201050P	NSYSF201050	NSYSF201050T	NSY2SP205	NSYEC105	NSYEC1051	-		
	500	2	NSYSF2010502DP	NSYSF2010502D	-	NSY2SP205	NSYEC105	NSYEC1051	-		
1200	600	1	NSYSF201060P	NSYSF201060	NSYSF201060T	NSY2SP206	NSYEC106	NSYEC1061	NSYEC1062		
	600	2	NSYSF2010602DP	NSYSF2010602D	-	NSY2SP206	NSYEC106	NSYEC1061	NSYEC1062		
	800	1	NSYSF201080P	NSYSF201080	-	NSY2SP208	NSYEC108	NSYEC1081	NSYEC1082		
	400	2	NSYSF2012402DP	NSYSF2012402D	-	NSY2SP204	NSYEC124	NSYEC1241	-		
	500	2	NSYSF2012502DP	NSYSF2012502D	-	NSY2SP205	NSYEC125	NSYEC1251	-		
	600	2	NSYSF2012602DP	NSYSF2012602D	-	NSY2SP206	NSYEC126	NSYEC1261	NSYEC1262		
1600	800	2	NSYSF2012802DP	NSYSF2012802D	-	NSY2SP208	NSYEC128	NSYEC1281	NSYEC1282		
	400	2	NSYSF2016402DP	NSYSF2016402D	-	NSY2SP204	NSYEC164	NSYEC1641	-		
	500	2	NSYSF2016502DP	NSYSF2016502D	-	NSY2SP205	NSYEC165	NSYEC1651	-		
	600	2	NSYSF2016602DP	NSYSF2016602D	-	NSY2SP206	NSYEC166	NSYEC1661	NSYEC1662		
	400	600	1	-	NSYSF22460	-	NSY2SP226	-	NSYEC461	-	
	600	600	1	NSYSF22660P	NSYSF22660	-	NSY2SP226	NSYEC66	NSYEC661	NSYEC662	
800	800	1	NSYSF22680P	NSYSF22680	-	NSY2SP228	NSYEC68	NSYEC681	NSYEC682		
	600	1	NSYSF22860P	NSYSF22860	-	NSY2SP226	NSYEC86	NSYEC861	NSYEC862		
1000	800	1	NSYSF22880P	NSYSF22880	NSYSF22880T	NSY2SP228	NSYEC88	NSYEC881	NSYEC882		
	600	1	NSYSF221060P	NSYSF221060	-	NSY2SP226	NSYEC106	NSYEC1061	NSYEC1062		
1200	600	2	NSYSF2212602DP	NSYSF2212602D	-	NSY2SP226	NSYEC126	NSYEC1261	NSYEC1262		
	800	2	NSYSF2212802DP	NSYSF2212802D	-	NSY2SP228	NSYEC128	NSYEC1281	NSYEC1282		

# Selection guide

## Steel floor-standing enclosures

SF

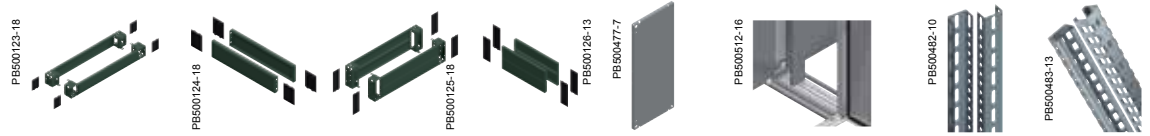

Nominal dimensions (mm)			Plinth				Mounting plate	Intermediate mounting plate	Vertical uprights		
Height (A)	Width (B)	Depth (C)	Height 100 mm		Height 200 mm				Standard	Technical	
			Front kit (corners + front panels)	Side panels, 2 u.	Front kit (corners + front panels)	Side panels, 4 u.					
1200	600	400	NSYSPPF6100	NSYSPPS4100	NSYSPPF6200	NSYSPPS4200	NSYMP126	NSYSIMP12	-	NSYTVR12	
		600	NSYSPPF6100	NSYSPPS6100	NSYSPPF6200	NSYSPPS6200	NSYMP126	NSYSIMP12	-	NSYTVR12	
		800	400	NSYSPPF8100	NSYSPPS4100	NSYSPPF8200	NSYSPPS4200	NSYMP128	NSYSIMP12	-	NSYTVR12
1400	600	400	NSYSPPF6100	NSYSPPS4100	NSYSPPF6200	NSYSPPS4200	NSYMP146	NSYSIMP14	-	NSYTVR14	
		800	400	NSYSPPF8100	NSYSPPS4100	NSYSPPF8200	NSYSPPS4200	NSYMP148	NSYSIMP14	-	NSYTVR14
1600	600	600	NSYSPPF6100	NSYSPPS6100	NSYSPPF6200	NSYSPPS6200	NSYMP166	NSYSIMP16	-	NSYTVR16	
		800	NSYSPPF6100	NSYSPPS8100	NSYSPPF6200	NSYSPPS8200	NSYMP166	NSYSIMP16	-	NSYTVR16	
		800	600	NSYSPPF8100	NSYSPPS6100	NSYSPPF8200	NSYSPPS6200	NSYMP168	NSYSIMP16	-	NSYTVR16
1800	400	400	NSYSPPF4100	NSYSPPS4100	NSYSPPF4200	NSYSPPS4200	-	-	-	NSYVVR18	NSYTVR18
		500	NSYSPPF4100	NSYSPPS5100	NSYSPPF4200	NSYSPPS5200	-	-	-	NSYVVR18	NSYTVR18
		600	NSYSPPF4100	NSYSPPS6100	NSYSPPF4200	NSYSPPS6200	-	-	-	NSYVVR18	NSYTVR18
		600	400	NSYSPPF6100	NSYSPPS4100	NSYSPPF6200	NSYSPPS4200	NSYMP186	NSYSIMP18	NSYVVR18	NSYTVR18
		500	NSYSPPF6100	NSYSPPS5100	NSYSPPF6200	NSYSPPS5200	NSYMP186	NSYSIMP18	NSYVVR18	NSYTVR18	
		600	NSYSPPF6100	NSYSPPS6100	NSYSPPF6200	NSYSPPS6200	NSYMP186	NSYSIMP18	NSYVVR18	NSYTVR18	
	800	400	NSYSPPF6100	NSYSPPS8100	NSYSPPF6200	NSYSPPS8200	NSYMP186	NSYSIMP18	NSYVVR18	NSYTVR18	
		400	NSYSPPF8100	NSYSPPS4100	NSYSPPF8200	NSYSPPS4200	NSYMP188	NSYSIMP18	NSYVVR18	NSYTVR18	
		500	NSYSPPF8100	NSYSPPS5100	NSYSPPF8200	NSYSPPS5200	NSYMP188	NSYSIMP18	NSYVVR18	NSYTVR18	
		600	NSYSPPF8100	NSYSPPS6100	NSYSPPF8200	NSYSPPS6200	NSYMP188	NSYSIMP18	NSYVVR18	NSYTVR18	
		1000	400	NSYSPPF10100	NSYSPPS4100	NSYSPPF10200	NSYSPPS4200	NSYMP1810	NSYSIMP18	NSYVVR18	NSYTVR18
		400	NSYSPPF10100	NSYSPPS4100	NSYSPPF10200	NSYSPPS4200	NSYMP1810	NSYSIMP18	NSYVVR18	NSYTVR18	
1200	400	NSYSPPF10100	NSYSPPS5100	NSYSPPF10200	NSYSPPS5200	NSYMP1810	NSYSIMP18	NSYVVR18	NSYTVR18		
	500	NSYSPPF10100	NSYSPPS6100	NSYSPPF10200	NSYSPPS6200	NSYMP1810	NSYSIMP18	NSYVVR18	NSYTVR18		
	600	NSYSPPF10100	NSYSPPS6100	NSYSPPF10200	NSYSPPS6200	NSYMP1810	NSYSIMP18	NSYVVR18	NSYTVR18		
	600	400	NSYSPPF12100	NSYSPPS4100	NSYSPPF12200	NSYSPPS4200	NSYMP1812	NSYSIMP18	NSYVVR18	NSYTVR18	
	500	NSYSPPF12100	NSYSPPS5100	NSYSPPF12200	NSYSPPS5200	NSYMP1812	NSYSIMP18	NSYVVR18	NSYTVR18		
	600	NSYSPPF12100	NSYSPPS6100	NSYSPPF12200	NSYSPPS6200	NSYMP1812	NSYSIMP18	NSYVVR18	NSYTVR18		
2000	300	500	NSYSPPF3100	NSYSPPS5100	NSYSPPF3200	NSYSPPS5200	-	-	-	NSYVVR20	NSYTVR20
		600	NSYSPPF3100	NSYSPPS6100	NSYSPPF3200	NSYSPPS6200	-	-	-	NSYVVR20	NSYTVR20
		800	NSYSPPF3100	NSYSPPS8100	NSYSPPF3200	NSYSPPS8200	-	-	-	NSYVVR20	NSYTVR20
		400	NSYSPPF4100	NSYSPPS4100	NSYSPPF4200	NSYSPPS4200	-	-	-	NSYVVR20	NSYTVR20
		500	NSYSPPF4100	NSYSPPS5100	NSYSPPF4200	NSYSPPS5200	-	-	-	NSYVVR20	NSYTVR20
		600	NSYSPPF4100	NSYSPPS6100	NSYSPPF4200	NSYSPPS6200	-	-	-	NSYVVR20	NSYTVR20
	600	400	NSYSPPF4100	NSYSPPS8100	NSYSPPF4200	NSYSPPS8200	-	-	-	NSYVVR20	NSYTVR20
		400	NSYSPPF6100	NSYSPPS4100	NSYSPPF6200	NSYSPPS4200	NSYMP206	NSYSIMP20	NSYVVR20	NSYTVR20	
		500	NSYSPPF6100	NSYSPPS5100	NSYSPPF6200	NSYSPPS5200	NSYMP206	NSYSIMP20	NSYVVR20	NSYTVR20	
		600	NSYSPPF6100	NSYSPPS6100	NSYSPPF6200	NSYSPPS6200	NSYMP206	NSYSIMP20	NSYVVR20	NSYTVR20	
		800	NSYSPPF6100	NSYSPPS8100	NSYSPPF6200	NSYSPPS8200	NSYMP206	NSYSIMP20	NSYVVR20	NSYTVR20	
		800	400	NSYSPPF8100	NSYSPPS4100	NSYSPPF8200	NSYSPPS4200	NSYMP208	NSYSIMP20	NSYVVR20	NSYTVR20
	800	500	NSYSPPF8100	NSYSPPS5100	NSYSPPF8200	NSYSPPS5200	NSYMP208	NSYSIMP20	NSYVVR20	NSYTVR20	
		600	NSYSPPF8100	NSYSPPS6100	NSYSPPF8200	NSYSPPS6200	NSYMP208	NSYSIMP20	NSYVVR20	NSYTVR20	
		600	NSYSPPF8100	NSYSPPS6100	NSYSPPF8200	NSYSPPS6200	NSYMP208	NSYSIMP20	NSYVVR20	NSYTVR20	
		800	NSYSPPF8100	NSYSPPS8100	NSYSPPF8200	NSYSPPS8200	NSYMP208	NSYSIMP20	NSYVVR20	NSYTVR20	
		1000	400	NSYSPPF10100	NSYSPPS4100	NSYSPPF10200	NSYSPPS4200	NSYMP2010	NSYSIMP20	NSYVVR20	NSYTVR20
		400	NSYSPPF10100	NSYSPPS4100	NSYSPPF10200	NSYSPPS4200	NSYMP2010	NSYSIMP20	NSYVVR20	NSYTVR20	
	1200	500	NSYSPPF10100	NSYSPPS5100	NSYSPPF10200	NSYSPPS5200	NSYMP2010	NSYSIMP20	NSYVVR20	NSYTVR20	
		500	NSYSPPF10100	NSYSPPS5100	NSYSPPF10200	NSYSPPS5200	NSYMP2010	NSYSIMP20	NSYVVR20	NSYTVR20	
		600	NSYSPPF10100	NSYSPPS6100	NSYSPPF10200	NSYSPPS6200	NSYMP2010	NSYSIMP20	NSYVVR20	NSYTVR20	
		600	NSYSPPF10100	NSYSPPS6100	NSYSPPF10200	NSYSPPS6200	NSYMP2010	NSYSIMP20	NSYVVR20	NSYTVR20	
		800	NSYSPPF10100	NSYSPPS8100	NSYSPPF10200	NSYSPPS8200	NSYMP2010	NSYSIMP20	NSYVVR20	NSYTVR20	
		400	NSYSPPF12100	NSYSPPS4100	NSYSPPF12200	NSYSPPS4200	NSYMP2012	NSYSIMP20	NSYVVR20	NSYTVR20	
500		NSYSPPF12100	NSYSPPS5100	NSYSPPF12200	NSYSPPS5200	NSYMP2012	NSYSIMP20	NSYVVR20	NSYTVR20		
600		NSYSPPF12100	NSYSPPS6100	NSYSPPF12200	NSYSPPS6200	NSYMP2012	NSYSIMP20	NSYVVR20	NSYTVR20		
800		NSYSPPF12100	NSYSPPS8100	NSYSPPF12200	NSYSPPS8200	NSYMP2012	NSYSIMP20	NSYVVR20	NSYTVR20		
1600		400	NSYSPPF16100	NSYSPPS4100	NSYSPPF16200	NSYSPPS4200	NSYMP2016	NSYSIMP20	NSYVVR20	NSYTVR20	
500		NSYSPPF16100	NSYSPPS5100	NSYSPPF16200	NSYSPPS5200	NSYMP2016	NSYSIMP20	NSYVVR20	NSYTVR20		
600		NSYSPPF16100	NSYSPPS6100	NSYSPPF16200	NSYSPPS6200	NSYMP2016	NSYSIMP20	NSYVVR20	NSYTVR20		
2200	400	600	NSYSPPF4100	NSYSPPS6100	NSYSPPF4200	NSYSPPS6200	-	-	-	NSYVVR22	NSYTVR22
		600	NSYSPPF6100	NSYSPPS6100	NSYSPPF6200	NSYSPPS6200	NSYMP226	NSYSIMP22	NSYVVR22	NSYTVR22	
	600	800	NSYSPPF6100	NSYSPPS8100	NSYSPPF6200	NSYSPPS8200	NSYMP226	NSYSIMP22	NSYVVR22	NSYTVR22	
		800	NSYSPPF8100	NSYSPPS6100	NSYSPPF8200	NSYSPPS6200	NSYMP228	NSYSIMP22	NSYVVR22	NSYTVR22	
	800	800	NSYSPPF8100	NSYSPPS8100	NSYSPPF8200	NSYSPPS8200	NSYMP228	NSYSIMP22	NSYVVR22	NSYTVR22	
		1000	600	NSYSPPF10100	NSYSPPS6100	NSYSPPF10200	NSYSPPS6200	NSYMP2210	NSYSIMP22	NSYVVR22	NSYTVR22
	1200	600	NSYSPPF12100	NSYSPPS6100	NSYSPPF12200	NSYSPPS6200	NSYMP2212	NSYSIMP22	NSYVVR22	NSYTVR22	
		800	NSYSPPF12100	NSYSPPS8100	NSYSPPF12200	NSYSPPS8200	NSYMP2212	NSYSIMP22	NSYVVR22	NSYTVR22	

# Selection guide

## Steel floor-standing enclosures

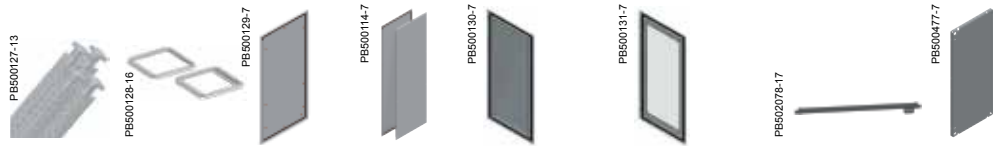

Nominal dimensions (mm)			No. of doors	Vertical uprights	Bottom frame and top frame with roof	Rear panel	Side panels	Plain door (1)	Transparent door (Securit® glass) (1)	Door Trim plate	Mounting plate	
Height (A)	Width (B)	Depth (C)										
1200	600	400	1	NSYSFV12	NSYSFC64	NSYBP126	NSY2SP124	NSYSFD126	NSYSFD126T	NSYTRIM6SF	NSYMP126	
		500	1	NSYSFV12	NSYSFC65	NSYBP126	NSY2SP125	NSYSFD126	NSYSFD126T	NSYTRIM6SF	NSYMP126	
		600	1	NSYSFV12	NSYSFC66	NSYBP126	NSY2SP126	NSYSFD126	NSYSFD126T	NSYTRIM6SF	NSYMP126	
		800	1	NSYSFV12	NSYSFC68	NSYBP126	NSY2SP128	NSYSFD126	NSYSFD126T	NSYTRIM6SF	NSYMP126	
	800	400	1	NSYSFV12	NSYSFC84	NSYBP128	NSY2SP124	NSYSFD128	NSYSFD128T	NSYTRIM8SF	NSYMP128	
		500	1	NSYSFV12	NSYSFC85	NSYBP128	NSY2SP125	NSYSFD128	NSYSFD128T	NSYTRIM8SF	NSYMP128	
		600	1	NSYSFV12	NSYSFC86	NSYBP128	NSY2SP126	NSYSFD128	NSYSFD128T	NSYTRIM8SF	NSYMP128	
		800	1	NSYSFV12	NSYSFC88	NSYBP128	NSY2SP128	NSYSFD128	NSYSFD128T	NSYTRIM8SF	NSYMP128	
	1400	600	400	1	NSYSFV14	NSYSFC64	NSYBP146	NSY2SP144	NSYSFD146	NSYSFD146T	NSYTRIM6SF	NSYMP146
			500	1	NSYSFV14	NSYSFC65	NSYBP146	NSY2SP145	NSYSFD146	NSYSFD146T	NSYTRIM6SF	NSYMP146
			600	1	NSYSFV14	NSYSFC66	NSYBP146	NSY2SP146	NSYSFD146	NSYSFD146T	NSYTRIM6SF	NSYMP146
			800	1	NSYSFV14	NSYSFC68	NSYBP146	NSY2SP148	NSYSFD146	NSYSFD146T	NSYTRIM6SF	NSYMP146
800		400	1	NSYSFV14	NSYSFC84	NSYBP148	NSY2SP144	NSYSFD148	NSYSFD148T	NSYTRIM8SF	NSYMP148	
		500	1	NSYSFV14	NSYSFC85	NSYBP148	NSY2SP145	NSYSFD148	NSYSFD148T	NSYTRIM8SF	NSYMP148	
		600	1	NSYSFV14	NSYSFC86	NSYBP148	NSY2SP146	NSYSFD148	NSYSFD148T	NSYTRIM8SF	NSYMP148	
		800	1	NSYSFV14	NSYSFC88	NSYBP148	NSY2SP148	NSYSFD148	NSYSFD148T	NSYTRIM8SF	NSYMP148	
1600	600	400	1	NSYSFV16	NSYSFC64	NSYBP166	NSY2SP164	NSYSFD166	NSYSFD166T	NSYTRIM6SF	NSYMP166	
		500	1	NSYSFV16	NSYSFC65	NSYBP166	NSY2SP165	NSYSFD166	NSYSFD166T	NSYTRIM6SF	NSYMP166	
		600	1	NSYSFV16	NSYSFC66	NSYBP166	NSY2SP166	NSYSFD166	NSYSFD166T	NSYTRIM6SF	NSYMP166	
		800	1	NSYSFV16	NSYSFC68	NSYBP166	NSY2SP168	NSYSFD166	NSYSFD166T	NSYTRIM6SF	NSYMP166	
	800	400	1	NSYSFV16	NSYSFC84	NSYBP168	NSY2SP164	NSYSFD168	NSYSFD168T	NSYTRIM8SF	NSYMP168	
		500	1	NSYSFV16	NSYSFC85	NSYBP168	NSY2SP165	NSYSFD168	NSYSFD168T	NSYTRIM8SF	NSYMP168	
		600	1	NSYSFV16	NSYSFC86	NSYBP168	NSY2SP166	NSYSFD168	NSYSFD168T	NSYTRIM8SF	NSYMP168	
		800	1	NSYSFV16	NSYSFC88	NSYBP168	NSY2SP168	NSYSFD168	NSYSFD168T	NSYTRIM8SF	NSYMP168	
	1800	400	400	1	NSYSFV18	NSYSFC44	NSYBP184	NSY2SP184	NSYSFD184	-	NSYTRIM4SF	-
			500	1	NSYSFV18	NSYSFC45	NSYBP184	NSY2SP185	NSYSFD184	-	NSYTRIM4SF	-
			600	1	NSYSFV18	NSYSFC46	NSYBP184	NSY2SP186	NSYSFD184	-	NSYTRIM4SF	-
			800	1	NSYSFV18	NSYSFC48	NSYBP184	NSY2SP188	NSYSFD184	-	NSYTRIM4SF	-
600		400	1	NSYSFV18	NSYSFC64	NSYBP186	NSY2SP184	NSYSFD186	NSYSFD186T	NSYTRIM6SF	NSYMP186	
		500	1	NSYSFV18	NSYSFC65	NSYBP186	NSY2SP185	NSYSFD186	NSYSFD186T	NSYTRIM6SF	NSYMP186	
		600	1	NSYSFV18	NSYSFC66	NSYBP186	NSY2SP186	NSYSFD186	NSYSFD186T	NSYTRIM6SF	NSYMP186	
		800	1	NSYSFV18	NSYSFC68	NSYBP186	NSY2SP188	NSYSFD186	NSYSFD186T	NSYTRIM6SF	NSYMP186	
800		400	1	NSYSFV18	NSYSFC84	NSYBP188	NSY2SP184	NSYSFD188	NSYSFD188T	NSYTRIM8SF	NSYMP188	
		500	1	NSYSFV18	NSYSFC85	NSYBP188	NSY2SP185	NSYSFD188	NSYSFD188T	NSYTRIM8SF	NSYMP188	
		600	1	NSYSFV18	NSYSFC86	NSYBP188	NSY2SP186	NSYSFD188	NSYSFD188T	NSYTRIM8SF	NSYMP188	
		800	2	NSYSFV18	NSYSFC86	NSYBP188	NSY2SP186	NSYSFD1882D	-	NSYTRIM8SF2D	NSYMP188	
1000	400	400	1	NSYSFV18	NSYSFC88	NSYBP188	NSY2SP188	NSYSFD188	NSYSFD188T	NSYTRIM8SF	NSYMP188	
		800	2	NSYSFV18	NSYSFC88	NSYBP188	NSY2SP188	NSYSFD1882D	-	NSYTRIM8SF2D	NSYMP188	
	400	400	1	NSYSFV18	NSYSFC104	NSYBP1810	NSY2SP184	NSYSFD1810	NSYSFD1810T	NSYTRIM10SF	NSYMP1810	
		400	2	NSYSFV18	NSYSFC104	NSYBP1810	NSY2SP184	NSYSFD18102D	-	NSYTRIM10SF2D	NSYMP1810	
1200	400	500	1	NSYSFV18	NSYSFC105	NSYBP1810	NSY2SP185	NSYSFD1810	NSYSFD1810T	NSYTRIM10SF	NSYMP1810	
		600	1	NSYSFV18	NSYSFC106	NSYBP1810	NSY2SP186	NSYSFD1810	NSYSFD1810T	NSYTRIM10SF	NSYMP1810	
	600	600	2	NSYSFV18	NSYSFC106	NSYBP1810	NSY2SP186	NSYSFD18102D	-	NSYTRIM10SF2D	NSYMP1810	
		800	1	NSYSFV18	NSYSFC108	NSYBP1810	NSY2SP188	NSYSFD1810	NSYSFD1810T	NSYTRIM10SF	NSYMP1810	
1200	400	800	2	NSYSFV18	NSYSFC108	NSYBP1810	NSY2SP188	NSYSFD18102D	-	NSYTRIM10SF2D	NSYMP1810	
		400	2	NSYSFV18	NSYSFC124	NSYBP1812	NSY2SP184	NSYSFD18122D	NSYSFD18122DT	NSYTRIM12SF2D	NSYMP1812	
	500	500	2	NSYSFV18	NSYSFC125	NSYBP1812	NSY2SP185	NSYSFD18122D	NSYSFD18122DT	NSYTRIM12SF2D	NSYMP1812	
		600	2	NSYSFV18	NSYSFC126	NSYBP1812	NSY2SP186	NSYSFD18122D	NSYSFD18122DT	NSYTRIM12SF2D	NSYMP1812	
800	800	2	NSYSFV18	NSYSFC128	NSYBP1812	NSY2SP188	NSYSFD18122D	NSYSFD18122DT	NSYTRIM12SF2D	NSYMP1812		

(1) Hinges, locking bar catches and handle with 5-mm double-bar insert included.

# Selection guide

## Steel floor-standing enclosures

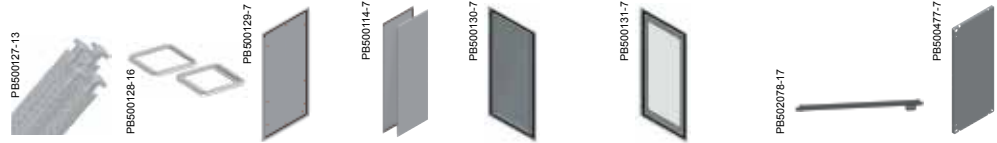

Nominal dimensions (mm)			No. of doors	Vertical uprights	Bottom frame and top frame with roof	Rear panel	Side panels	Plain door (1)	Transparent door (Securit® glass) (1)	Door Trim plate	Mounting plate		
Height (A)	Width (B)	Depth (C)											
2000	300	500	1	NSYSFV20	NSYSFC35	NSYBP203	NSY2SP205	NSYSFD203	-	NSYTRIM3SF	-		
		600	1	NSYSFV20	NSYSFC36	NSYBP203	NSY2SP206	NSYSFD203	-	NSYTRIM3SF	-		
		400	400	1	NSYSFV20	NSYSFC44	NSYBP204	NSY2SP204	NSYSFD204	-	NSYTRIM4SF	-	
			500	1	NSYSFV20	NSYSFC45	NSYBP204	NSY2SP205	NSYSFD204	-	NSYTRIM4SF	-	
	600	400	600	1	NSYSFV20	NSYSFC46	NSYBP204	NSY2SP206	NSYSFD204	-	NSYTRIM4SF	-	
			800	1	NSYSFV20	NSYSFC48	NSYBP204	NSY2SP208	NSYSFD204	-	NSYTRIM4SF	-	
		500	400	1	NSYSFV20	NSYSFC64	NSYBP206	NSY2SP204	NSYSFD206	NSYSFD206T	NSYTRIM6SF	NSYMP206	
			600	1	NSYSFV20	NSYSFC65	NSYBP206	NSY2SP205	NSYSFD206	NSYSFD206T	NSYTRIM6SF	NSYMP206	
	800	600	600	1	NSYSFV20	NSYSFC66	NSYBP206	NSY2SP206	NSYSFD206	NSYSFD206T	NSYTRIM6SF	NSYMP206	
			800	1	NSYSFV20	NSYSFC68	NSYBP206	NSY2SP208	NSYSFD206	NSYSFD206T	NSYTRIM6SF	NSYMP206	
		400	400	1	NSYSFV20	NSYSFC84	NSYBP208	NSY2SP204	NSYSFD208	NSYSFD208T	NSYTRIM8SF	NSYMP208	
			500	1	NSYSFV20	NSYSFC85	NSYBP208	NSY2SP205	NSYSFD208	NSYSFD208T	NSYTRIM8SF	NSYMP208	
	1000	600	600	1	NSYSFV20	NSYSFC86	NSYBP208	NSY2SP206	NSYSFD208	NSYSFD208T	NSYTRIM8SF	NSYMP208	
			800	2	NSYSFV20	NSYSFC86	NSYBP208	NSY2SP206	NSYSFD2082D	-	NSYTRIM8SF2D	NSYMP208	
		800	800	1	NSYSFV20	NSYSFC88	NSYBP208	NSY2SP208	NSYSFD208	NSYSFD208T	NSYTRIM8SF	NSYMP208	
			800	2	NSYSFV20	NSYSFC88	NSYBP208	NSY2SP208	NSYSFD2082D	-	NSYTRIM8SF2D	NSYMP208	
	1200	400	400	1	NSYSFV20	NSYSFC104	NSYBP2010	NSY2SP204	NSYSFD2010	NSYSFD2010T	NSYTRIM10SF	NSYMP2010	
			400	2	NSYSFV20	NSYSFC104	NSYBP2010	NSY2SP204	NSYSFD20102D	-	NSYTRIM10SF2D	NSYMP2010	
		500	400	1	NSYSFV20	NSYSFC105	NSYBP2010	NSY2SP205	NSYSFD2010	NSYSFD2010T	NSYTRIM10SF	NSYMP2010	
			500	2	NSYSFV20	NSYSFC105	NSYBP2010	NSY2SP205	NSYSFD20102D	-	NSYTRIM10SF2D	NSYMP2010	
		600	400	600	1	NSYSFV20	NSYSFC106	NSYBP2010	NSY2SP206	NSYSFD2010	NSYSFD2010T	NSYTRIM10SF	NSYMP2010
				600	2	NSYSFV20	NSYSFC106	NSYBP2010	NSY2SP206	NSYSFD20102D	-	NSYTRIM10SF2D	NSYMP2010
			800	400	1	NSYSFV20	NSYSFC108	NSYBP2010	NSY2SP208	NSYSFD2010	NSYSFD2010T	NSYTRIM10SF	NSYMP2010
				800	2	NSYSFV20	NSYSFC108	NSYBP2010	NSY2SP208	NSYSFD20102D	-	NSYTRIM10SF2D	NSYMP2010
1600		400	400	2	NSYSFV20	NSYSFC124	NSYBP2012	NSY2SP204	NSYSFD20122D	NSYSFD20122DT	NSYTRIM12SF2D	NSYMP2012	
			500	2	NSYSFV20	NSYSFC125	NSYBP2012	NSY2SP205	NSYSFD20122D	NSYSFD20122DT	NSYTRIM12SF2D	NSYMP2012	
		600	400	2	NSYSFV20	NSYSFC126	NSYBP2012	NSY2SP206	NSYSFD20122D	NSYSFD20122DT	NSYTRIM12SF2D	NSYMP2012	
			800	2	NSYSFV20	NSYSFC128	NSYBP2012	NSY2SP208	NSYSFD20122D	NSYSFD20122DT	NSYTRIM12SF2D	NSYMP2012	
2200	400	400	2	NSYSFV20	NSYSFC164	NSYBP2016	NSY2SP204	NSYSFD20162D	-	NSYTRIM16SF2D	NSYMP2016		
		500	2	NSYSFV20	NSYSFC165	NSYBP2016	NSY2SP205	NSYSFD20162D	-	NSYTRIM16SF2D	NSYMP2016		
		600	2	NSYSFV20	NSYSFC166	NSYBP2016	NSY2SP206	NSYSFD20162D	-	NSYTRIM16SF2D	NSYMP2016		
		600	400	400	1	NSYSFV22	NSYSFC44	NSYBP224	NSY2SP224	NSYSFD224	-	NSYTRIM4SF	-
	500			1	NSYSFV22	NSYSFC45	NSYBP224	NSY2SP225	NSYSFD224	-	NSYTRIM4SF	-	
	600		400	1	NSYSFV22	NSYSFC46	NSYBP224	NSY2SP226	NSYSFD224	-	NSYTRIM4SF	-	
			800	1	NSYSFV22	NSYSFC48	NSYBP224	NSY2SP228	NSYSFD224	-	NSYTRIM4SF	-	
	800	400	400	1	NSYSFV22	NSYSFC64	NSYBP226	NSY2SP224	NSYSFD226	NSYSFD226T	NSYTRIM6SF	NSYMP226	
			500	1	NSYSFV22	NSYSFC65	NSYBP226	NSY2SP225	NSYSFD226	NSYSFD226T	NSYTRIM6SF	NSYMP226	
		600	400	1	NSYSFV22	NSYSFC66	NSYBP226	NSY2SP226	NSYSFD226	NSYSFD226T	NSYTRIM6SF	NSYMP226	
			800	1	NSYSFV22	NSYSFC68	NSYBP226	NSY2SP228	NSYSFD226	NSYSFD226T	NSYTRIM6SF	NSYMP226	
	1000	400	400	1	NSYSFV22	NSYSFC84	NSYBP228	NSY2SP224	NSYSFD228	NSYSFD228T	NSYTRIM8SF	NSYMP228	
			500	1	NSYSFV22	NSYSFC85	NSYBP228	NSY2SP225	NSYSFD228	NSYSFD228T	NSYTRIM8SF	NSYMP228	
		600	400	1	NSYSFV22	NSYSFC86	NSYBP228	NSY2SP226	NSYSFD228	NSYSFD228T	NSYTRIM8SF	NSYMP228	
			800	1	NSYSFV22	NSYSFC88	NSYBP228	NSY2SP228	NSYSFD228	NSYSFD228T	NSYTRIM8SF	NSYMP228	
	1200	400	400	1	NSYSFV22	NSYSFC104	NSYBP2210	NSY2SP224	NSYSFD2210	NSYSFD2210T	NSYTRIM10SF	NSYMP2210	
			500	1	NSYSFV22	NSYSFC105	NSYBP2210	NSY2SP225	NSYSFD2210	NSYSFD2210T	NSYTRIM10SF	NSYMP2210	
		600	400	1	NSYSFV22	NSYSFC106	NSYBP2210	NSY2SP226	NSYSFD2210	NSYSFD2210T	NSYTRIM10SF	NSYMP2210	
			800	1	NSYSFV22	NSYSFC108	NSYBP2210	NSY2SP228	NSYSFD2210	NSYSFD2210T	NSYTRIM10SF	NSYMP2210	
	1600	400	400	2	NSYSFV22	NSYSFC124	NSYBP2212	NSY2SP224	NSYSFD22122D	NSYSFD22122DT	NSYTRIM12SF2D	NSYMP2212	
			500	2	NSYSFV22	NSYSFC125	NSYBP2212	NSY2SP225	NSYSFD22122D	NSYSFD22122DT	NSYTRIM12SF2D	NSYMP2212	
		600	400	2	NSYSFV22	NSYSFC126	NSYBP2212	NSY2SP226	NSYSFD22122D	NSYSFD22122DT	NSYTRIM12SF2D	NSYMP2212	
			800	2	NSYSFV22	NSYSFC128	NSYBP2212	NSY2SP228	NSYSFD22122D	NSYSFD22122DT	NSYTRIM12SF2D	NSYMP2212	

(1) Hinges, locking bar catches and handle with 5-mm double-bar insert included.

# Selection guide

## Stainless-steel wall-mounting enclosures



Dimensions (mm)			No. of locks	No. of doors	304L stainless-steel		316L stainless-steel	304L stainless-steel canopy	Plain mounting plate***
Height	Width	Depth			Plain door	Glazed door**	Plain door		
300	200	150	1	1	NSYS3X3215	-	NSYS3X3215H	NSYTX2015	NSYMM32
	250	150	1	1	NSYS3X302515	-	NSYS3X302515H	NSYTX2515	NSYMM3025
	300	150	1	1	NSYS3X3315	-	NSYS3X3315H	NSYTX3015	NSYMM33
400	300	150	1	1	NSYS3X4315	-	NSYS3X4315H	NSYTX3015	NSYMM43
		200	1	1	NSYS3X4320	NSYS3X4320T	NSYS3X4320H	NSYTX3020	NSYMM43
	400	200	1	1	NSYS3X4420	-	NSYS3X4420H	NSYTX4020	NSYMM44
	600	200	1	1	NSYS3X4620	-	NSYS3X4620H	NSYTX6020	NSYMM64
500	400	200	2	1	NSYS3X5420	NSYS3X5420T	NSYS3X5420H	NSYTX4020	NSYMM54
600	400	200	2	1	NSYS3X6420	NSYS3X6420T	NSYS3X6420H	NSYTX4020	NSYMM64
	600	250	2	1	NSYS3X6625	-	NSYS3X6625H	NSYTX6025	NSYMM66
	1000	300	1	2	NSYS3X601030	-	-	-	-
	1200	300	1	2	NSYS3X601230	-	-	NSYTX12030	-
700	500	250	2	1	NSYS3X7525	NSYS3X7525T	NSYS3X7525H	NSYTX5025	NSYMM75
800	600	250	2	1	NSYS3X8625	NSYS3X8625T	NSYS3X8625H	NSYTX6025	NSYMM86
	800	300	2	1	NSYS3X8830	-	NSYS3X8830H	NSYTX8030	NSYMM88
	1000	300	1	2	NSYS3X801030	-	-	-	-
	1200	300	1	2	NSYS3X801230	-	-	NSYTX12030	-
1000	800	300	2	1	NSYS3X10830	NSYS3X10830T	NSYS3X10830H	NSYTX8030	NSYMM108
	1000	300	*	2	NSYS3X101030	-	NSYS3X101030H	NSYTX10030	NSYMM1010
1200	800	300	2	1	NSYS3X12830	-	NSYS3X12830H	NSYTX8030	NSYMM128
	1000	300	*	2	NSYS3X121030	-	NSYS3X121030H	NSYTX10030	NSYMM1210

\* Three-point closure system.

\*\* The glazed door has no reinforcement.

\*\*\* See other mounting plates in common accessoires.

### Selection guide for wall-mounting enclosures and main accessories

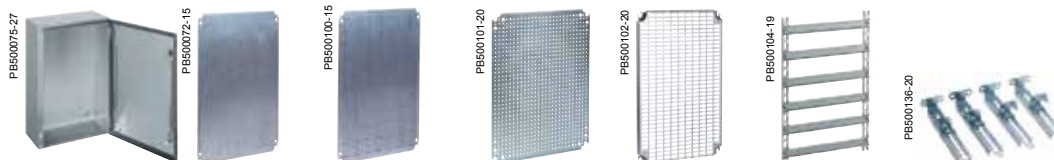

Dimensions (mm)			Enclosure	Mounting plate reference				DIN rail chassis	Step slides
Height	Width	Depth	References	Plain	Silkscreened	Microperforated	Telequick		
300	200	150	NSYS3XEX3215	NSYMM32	-	NSYMF32	NSYMR32	-	-
400	300	200	NSYS3XEX4320	NSYMM43	NSYMS43	NSYMF43	NSYMR43	NSYMD43	NSYSDCR200
500	400	200	NSYS3XEX5420	NSYMM54	NSYMS54	NSYMF54	NSYMR54	NSYMD54	NSYSDCR200
600	400	200	NSYS3XEX6420	NSYMM64	NSYMS64	NSYMF64	NSYMR64	NSYMD64	NSYSDCR200
700	500	250	NSYS3XEX7525	NSYMM75	NSYMS75	NSYMF75	NSYMR75	NSYMD75	NSYSDCR250
800	600	250	NSYS3XEX8625	NSYMM86	NSYMS86	NSYMF86	NSYMR86	NSYMD86	NSYSDCR250
1000	800	300	NSYS3XEX10830	NSYMM108	-	NSYMF108	NSYMR108	NSYMD108	NSYSDCR300



# Selection guide

## Stainless-steel floor-standing enclosures



### Stainless-steel floor-standing monobloc

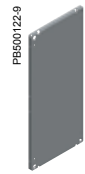
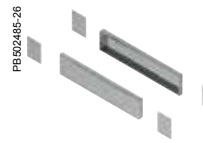

Dimensions (mm)			Number of front doors	Stainless-steel floor-standing enclosure 304L / 316L*	Brushed 304L / 316L* stainless-steel plinth height 100 mm**		Brushed 304L / 316L* stainless-steel plinth height 200 mm**		Plain mounting plate***
Height	Width	Depth			Kit (4 corners + front and back)	Set of 2 side panels	Kit (4 corners + front and back)	Set of 2 side panels (x2)	
1400	1000	300	2	NSYSMX141030	NSYSFPX10100	NSYSPSX3100	NSYSFPX10200	NSYSPSX3200	NSYMP1410
1600	800	400	1	NSYSMX16840	NSYSFPX8100	NSYSPSX4100	NSYSFPX8200	NSYSPSX4200	NSYMP168
1800	600	400	1	NSYSMX18640	-	NSYSPSX4100	-	NSYSPSX4200	NSYMP186
	800	400	1	NSYSMX18840*	NSYSFPX8100	NSYSPSX4100	NSYSFPX8200	NSYSPSX4200	NSYMP188
	1200	400	2	NSYSMX181240*	NSYSFPX12100	NSYSPSX4100	NSYSFPX12200	NSYSPSX4200	NSYMP1812
	1600	400	2	NSYSMX181640*	NSYSFPX16100	NSYSPSX4100	NSYSFPX16200	NSYSPSX4200	NSYMP1816
2000	800	500	1	NSYSMX20850	NSYSFPX8100	NSYSPSX5100	NSYSFPX8200	NSYSPSX5200	NSYMP208
	1000	400	2	NSYSMX201040*	NSYSFPX10100	NSYSPSX4100	NSYSFPX10200	NSYSPSX4200	NSYMP2010
	1200	500	2	NSYSMX201250*	NSYSFPX12100	NSYSPSX5100	NSYSFPX12200	NSYSPSX5200	NSYMP2012
	1600	600	2	NSYSMX201660*	NSYSFPX16100	NSYSPSX6100	NSYSFPX16200	NSYSPSX6200	NSYMP2016

\* For version in AISI 316L stainless steel, add the lettre H to the end of the reference. Example NSYSMX18840H.  
 \*\* See section on stainless-steel composition accessories. - \*\*\* See other mounting plates in common accessories.



### Stainless-steel floor-standing suitable

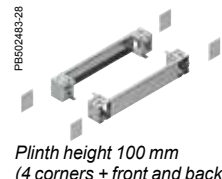

Dimensions (mm)			No. of front doors	References in 304L stainless steel (1)			Brushed 304L / 316L* stainless-steel plinth height 100 mm (2)		Brushed 304L / 316L* stainless-steel plinth height 200 mm (2)		Plain mounting plate (3)
H	W	D		Suitable enclosure	Set of 2 side panels	Coupling kit	Kit (4 corners + front and back)	Set of 2 side panels	Kit (4 corners + front and back)	Side Set of 2 side panels (x2)	
1800	600	400	1	NSYSFX18640	NSY2SPX184	NSYSFBK19 + NSYSFXJG	NSYSFPX6100**	NSYSPSX4100SF	NSYSFPX6200**	NSYSPSX4200SF	NSYMP186
	800	400	1	NSYSFX18840	NSY2SPX184	NSYSFBK19 + NSYSFXJG	NSYSFPX8100	NSYSPSX4100SF	NSYSFPX8200	NSYSPSX4200SF	NSYMP188
	1200	400	2	NSYSFX181240	NSY2SPX184	NSYSFBK19 + NSYSFXJG	NSYSFPX12100	NSYSPSX4100SF	NSYSFPX12200	NSYSPSX4200SF	NSYMP1812
2000	600	500	1	NSYSFX20650	NSY2SPX205	NSYSFBK19 + NSYSFXJG	NSYSFPX6100**	NSYSPSX5100SF	NSYSFPX6200**	NSYSPSX5200SF	NSYMP206
	800	400	1	NSYSFX20840	NSY2SPX204	NSYSFBK19 + NSYSFXJG	NSYSFPX8100	NSYSPSX4100SF	NSYSFPX8200	NSYSPSX4200SF	NSYMP208
	600	1	NSYSFX20860	NSY2SPX206	NSYSFBK19 + NSYSFXJG	NSYSFPX8100	NSYSPSX6100SF	NSYSFPX8200	NSYSPSX6200SF	NSYMP208	
	1000	600	2	NSYSFX201060	NSY2SPX206	NSYSFBK19 + NSYSFXJG	NSYSFPX10100	NSYSPSX6100SF	NSYSFPX10200	NSYSPSX6200SF	NSYMP2010
	1200	600	2	NSYSFX201260	NSY2SPX206	NSYSFBK19 + NSYSFXJG	NSYSFPX12100	NSYSPSX6100SF	NSYSFPX12200	NSYSPSX6200SF	NSYMP2012

(1) 316L stainless-steel enclosures on request. - (2) See section on stainless-steel composition accessories. - (3) See other mounting plates in common accessories.  
 \* For version in AISI 316L stainless steel, add the lettre H to the end of the reference and delete the SF termination. Example NSYSFPX8100H. - \*\* Only for 304L.



### Stainless-steel floor-standing suitable



Dimensions (mm)			References	Number of front doors	316L stainless-steel plinth, height 100 mm (1)		316L stainless-steel plinth, height 200 mm (1)		Plain mounting plate (2)
Height	Width	Depth			Front and rear	side panels	Front and rear	side panels	
1000	600	500	NSYSDX6	1	NSYSFPX6100H	NSYSPSX5100H	NSYSFPX6200H	2 x NSYSPSX5100H	NSYPMP8560
	800	500	NSYSDX8	1	NSYSFPX8100H	NSYSPSX5100H	NSYSFPX8200H	2 x NSYSPSX5100H	NSYPMP8580
	1000	500	NSYSDX10	2	NSYSFPX10100H	NSYSPSX5100H	NSYSFPX10200H	2 x NSYSPSX5100H	NSYPMP85100
	1200	500	NSYSDX12	2	NSYSFPX12100H	NSYSPSX5100H	NSYSFPX12200H	2 x NSYSPSX5100H	NSYPMP85120

(1) See section on stainless-steel composition accessories. - (2) See other mounting plates in common accessories.

**[!]** Stainless-steel plinths compatible with steel offer.

# Selection guide

## Polyester wall-mounting enclosures

### Polyester wall-mounting enclosures IP66



Dimensions (mm)			ABS/PC wall-mounting enclosures IP66		Polyester wall-mounting enclosures IP66			
Height	Width	Depth	Plain door	Transp. door	Plain door	Transp. door	Plain door 3-point closure	Transp. door 3-point closure
310	215	160	<b>NSYPLM32</b>	<b>NSYPLM32T</b>	-	-	-	-
308	255	160	-	-	<b>NSYPLM3025</b>	<b>NSYPLM3025T</b>	-	-
430	330	200	-	-	<b>NSYPLM43</b>	<b>NSYPLM43T</b>	<b>NSYPLM43V</b>	<b>NSYPLM43TV</b>
530	430	200	-	-	<b>NSYPLM54</b>	<b>NSYPLM54T</b>	<b>NSYPLM54V</b>	<b>NSYPLM54TV</b>
647	436	250	-	-	<b>NSYPLM64</b>	<b>NSYPLM64T</b>	<b>NSYPLM64V</b>	<b>NSYPLM64TV</b>
747	536	300	-	-	<b>NSYPLM75</b>	<b>NSYPLM75T</b>	<b>NSYPLM75V</b>	<b>NSYPLM75TV</b>
847	636	300	-	-	<b>NSYPLM86</b>	<b>NSYPLM86T</b>	<b>NSYPLM86V</b>	<b>NSYPLM86TV</b>
1056	852	350	-	-	<b>NSYPLM108</b>	<b>NSYPLM108T</b>	-	-

### Polyester wall-mounting PLMEX and accessories

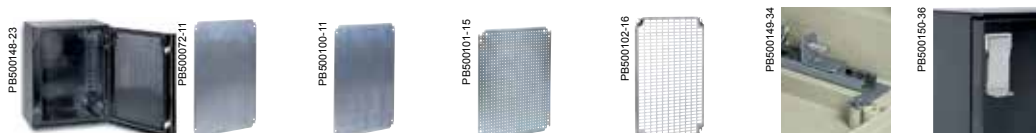

Dimensions (mm)			ATEX solution	Metallic mounting plate				Step slides	Padlocking
Height	Width	Depth	References	Plain	Silkscreened	Microperforated	Telequick	References	
308	255	160	<b>NSYPLMEX3025</b>	<b>NSYMM3025</b>	-	-	<b>NSYMR3025</b>	-	-
430	330	200	<b>NSYPLMEX43</b>	<b>NSYMM43</b>	<b>NSYMS43</b>	<b>NSYMF43</b>	<b>NSYMR43</b>	<b>NSYDPLM200</b>	<b>NSYKPLM</b>
530	430	200	<b>NSYPLMEX54</b>	<b>NSYMM54</b>	<b>NSYMS54</b>	<b>NSYMF54</b>	<b>NSYMR54</b>	<b>NSYDPLM200</b>	<b>NSYKPLM</b>
647	436	250	<b>NSYPLMEX64</b>	<b>NSYMM64</b>	<b>NSYMS64</b>	<b>NSYMF64</b>	<b>NSYMR64</b>	<b>NSYDPLM250</b>	<b>NSYKPLM</b>
747	536	300	<b>NSYPLMEX75</b>	<b>NSYMM75</b>	<b>NSYMS75</b>	<b>NSYMF75</b>	<b>NSYMR75</b>	<b>NSYDPLM300</b>	<b>NSYKPLM</b>
847	636	300	<b>NSYPLMEX86</b>	<b>NSYMM86</b>	<b>NSYMS86</b>	<b>NSYMF86</b>	<b>NSYMR86</b>	<b>NSYDPLM300</b>	<b>NSYKPLM</b>
1056	852	350	<b>NSYPLMEX108</b>	<b>NSYMM108</b>	-	<b>NSYMF108</b>	<b>NSYMR108</b>	<b>NSYDPLM350</b>	<b>NSYBCPL</b>

### Mounting accessories



Dimensions (mm)			Metallic mounting plates				Insulating mounting plates		Modular distribution chassis	Step slides	Symmetrical DIN rail
Height	Width	Depth	Plain	Silkscreened	Microperforated	Telequick	Bakelite	Polyester			
310	215	160	NSYMM32	-	-	NSYMR32	NSYMB32	NSYMPP32	-	-	NSYCS200PLM
308	255	160	NSYMM3025	-	-	NSYMR3025	NSYMB3025	NSYMPP3025	NSYDLPLM18	-	-
430	330	200	NSYMM43	NSYMS43	NSYMF43	NSYMR43	NSYMB43	NSYMPP43	NSYDLA24	NSYDPLM200	NSYCS300PLM
530	430	200	NSYMM54	NSYMS54	NSYMF54	NSYMR54	NSYMB54	NSYMPP54	NSYDLA48	NSYDPLM200	NSYCS400PLM
647	436	250	NSYMM64	NSYMS46	NSYMF64	NSYMR64	NSYMB64	NSYMPP64	NSYDLA48P	NSYDPLM250	NSYCS400PLM
747	536	300	NSYMM75	NSYMS75	NSYMF75	NSYMR75	NSYMB75	NSYMPP75	NSYDLA66 and NSYDLA88	NSYDPLM300	NSYCS500PLM
847	636	300	NSYMM86	NSYMS86	NSYMF86	NSYMR86	NSYMB86	NSYMPP86	NSYDLA84 and NSYDLA112	NSYDPLM300	NSYCS600PLM
1056	852	350	NSYMM108	-	NSYMF108	NSYMR108	NSYMB108	NSYMPP108	NSYDLA234	NSYDPLM350	NSYCS800PLM

### Main accessories



Dimensions (mm)			Mounting brackets	Post-mounting device	Floor-mounting pillar	Coupling frame	Cable-gland plate	Internal door	Blanking plates	Plinth ZM RAL 7032
Height	Width	Depth								
310	215	160	NSYPFPLM32	-	-	-	-	-	NSYCEPLMA	-
308	255	160	NSYPFPLM	-	-	-	-	NSYPA3025PLM	-	-
430	330	200	NSYPFPLM	NSYSFP300	-	-	-	NSYPAP43	NSYCEPLMB	-
530	430	200	NSYPFPLM	NSYSFP400	NSYSFSPLM	-	-	NSYPAP54	NSYCEPLMB	-
647	436	250	NSYPFPLM	NSYSFP400	NSYSFSPLM	-	-	NSYPAP64	NSYCEPLMC	-
747	536	300	NSYPFPLM	NSYSFP500	-	NSYBUPLM	NSYTLA4420	NSYPAP75	NSYCEPLMC	NSYZM253
847	636	300	NSYPFPLM	NSYSFP600	-	NSYBUPLM	NSYTLA4420	NSYPAP86	NSYCEPLMC	NSYZM263
1056	852	350	NSYPFPLM	-	-	NSYBU108PLM	NSYTLA6420	NSYPAP108	-	NSYZM283

#### Water drain plug



Page 205

#### Rail-mounting nuts



Page 204

#### Ventilation louvre



Page 205

# Selection guide

## Polyester floor-standing enclosures

PB50289F-22



PB50289B-23



PB502899-21



Dimensions (mm)				Completely sealed enclosures, IP65		Enclosures with plinth-type open bottom part, IP54
References of enclosures with door						
Height (A)	Width (B)	Depth (C)	N° of doors	Plain	Glazed	Plain
500	500	320	1	NSYPLA553	NSYPLA553T	NSYPLAZ553
		420	1	NSYPLA554	NSYPLA554T	NSYPLAZ554
	750	320	1	NSYPLA573	NSYPLA573T	NSYPLAZ573
		420	1	NSYPLA574	NSYPLA574T	NSYPLAZ574
	1000	320	2	NSYPLA5103	NSYPLA5103T	NSYPLAZ5103
		420	2	NSYPLA5104	NSYPLA5104T	NSYPLAZ5104
	1250	320	2	NSYPLA5123	NSYPLA5123T	NSYPLAZ5123
		420	2	NSYPLA5124	NSYPLA5124T	NSYPLAZ5124
750	500	320	1	NSYPLA753	NSYPLA753T	NSYPLAZ753
		420	1	NSYPLA754	NSYPLA754T	NSYPLAZ754
	750	320	1	NSYPLA773	NSYPLA773T	NSYPLAZ773
		420	1	NSYPLA774	NSYPLA774T	NSYPLAZ774
	1000	320	2	NSYPLA7103	NSYPLA7103T	NSYPLAZ7103
		420	2	NSYPLA7104	NSYPLA7104T	NSYPLAZ7104
	1250	320	2	NSYPLA7123	NSYPLA7123T	NSYPLAZ7123
		420	2	NSYPLA7124	NSYPLA7124T	NSYPLAZ7124
1000	500	320	1	NSYPLA1053	NSYPLA1053T	NSYPLAZ1053
		420	1	NSYPLA1054	NSYPLA1054T	NSYPLAZ1054
	750	320	1	NSYPLA1073	NSYPLA1073T	NSYPLAZ1073
		420	1	NSYPLA1074	NSYPLA1074T	NSYPLAZ1074
	1000	320	2	NSYPLA10103	NSYPLA10103T	NSYPLAZ10103
		420	2	NSYPLA10104	NSYPLA10104T	NSYPLAZ10104
	1250	320	2	NSYPLA10123	NSYPLA10123T	NSYPLAZ10123
		420	2	NSYPLA10124	NSYPLA10124T	NSYPLAZ10124
1250	500	320	1	NSYPLA1253	NSYPLA1253T	NSYPLAZ1253
		420	1	NSYPLA1254	NSYPLA1254T	NSYPLAZ1254
	750	320	1	NSYPLA1273	NSYPLA1273T	NSYPLAZ1273
		420	1	NSYPLA1274	NSYPLA1274T	NSYPLAZ1274
	1000	320	2	NSYPLA12103	NSYPLA12103T	NSYPLAZ12103
		420	2	NSYPLA12104	NSYPLA12104T	NSYPLAZ12104
	1250	320	2	NSYPLA12123	NSYPLA12123T	NSYPLAZ12123
		420	2	NSYPLA12124	NSYPLA12124T	NSYPLAZ12124
1500	500	320	1	NSYPLA1553	NSYPLA1553T	NSYPLAZ1553
		420	1	NSYPLA1554	NSYPLA1554T	NSYPLAZ1554
	750	320	1	NSYPLA1573	NSYPLA1573T	NSYPLAZ1573
		420	1	NSYPLA1574	NSYPLA1574T	NSYPLAZ1574
	1000	320	2	NSYPLA15103	NSYPLA15103T	NSYPLAZ15103
		420	2	NSYPLA15104	NSYPLA15104T	NSYPLAZ15104
	1250	320	2	NSYPLA15123	NSYPLA15123T	NSYPLAZ15123
		420	2	NSYPLA15124	NSYPLA15124T	NSYPLAZ15124

# Selection guide

## Polyester floor-standing enclosures

PE502900-21



PE502901-19



Dimensions (mm)				Enclosures with ventilated canopy, IP44	Enclosures with plinth-type open bottom part and ventilated canopy, IP44
<b>References of enclosures with door</b>					
Height (A)	Width (B)	Depth (C)	N° of doors	Plain	Plain
500	500	320	1	NSYPLAT553	NSYPLAZT553
		420	1	NSYPLAT554	NSYPLAZT554
	750	320	1	NSYPLAT573	NSYPLAZT573
		420	1	NSYPLAT574	NSYPLAZT574
	1000	320	2	NSYPLAT5103	NSYPLAZT5103
		420	2	NSYPLAT5104	NSYPLAZT5104
	1250	320	2	NSYPLAT5123	NSYPLAZT5123
		420	2	NSYPLAT5124	NSYPLAZT5124
750	500	320	1	NSYPLAT753	NSYPLAZT753
		420	1	NSYPLAT754	NSYPLAZT754
	750	320	1	NSYPLAT773	NSYPLAZT773
		420	1	NSYPLAT774	NSYPLAZT774
	1000	320	2	NSYPLAT7103	NSYPLAZT7103
		420	2	NSYPLAT7104	NSYPLAZT7104
	1250	320	2	NSYPLAT7123	NSYPLAZT7123
		420	2	NSYPLAT7124	NSYPLAZT7124
1000	500	320	1	NSYPLAT1053	NSYPLAZT1053
		420	1	NSYPLAT1054	NSYPLAZT1054
	750	320	1	NSYPLAT1073	NSYPLAZT1073
		420	1	NSYPLAT1074	NSYPLAZT1074
	1000	320	2	NSYPLAT10103	NSYPLAZT10103
		420	2	NSYPLAT10104	NSYPLAZT10104
	1250	320	2	NSYPLAT10123	NSYPLAZT10123
		420	2	NSYPLAT10124	NSYPLAZT10124
1250	500	320	1	NSYPLAT1253	NSYPLAZT1253
		420	1	NSYPLAT1254	NSYPLAZT1254
	750	320	1	NSYPLAT1273	NSYPLAZT1273
		420	1	NSYPLAT1274	NSYPLAZT1274
	1000	320	2	NSYPLAT12103	NSYPLAZT12103
		420	2	NSYPLAT12104	NSYPLAZT12104
	1250	320	2	NSYPLAT12123	NSYPLAZT12123
		420	2	NSYPLAT12124	NSYPLAZT12124
1500	500	320	1	NSYPLAT1553	NSYPLAZT1553
		420	1	NSYPLAT1554	NSYPLAZT1554
	750	320	1	NSYPLAT1573	NSYPLAZT1573
		420	1	NSYPLAT1574	NSYPLAZT1574
	1000	320	2	NSYPLAT15103	NSYPLAZT15103
		420	2	NSYPLAT15104	NSYPLAZT15104
	1250	320	2	NSYPLAT15123	NSYPLAZT15123
		420	2	NSYPLAT15124	NSYPLAZT15124

# Selection guide

## Polyester floor-standing enclosures

### Mounting accessories

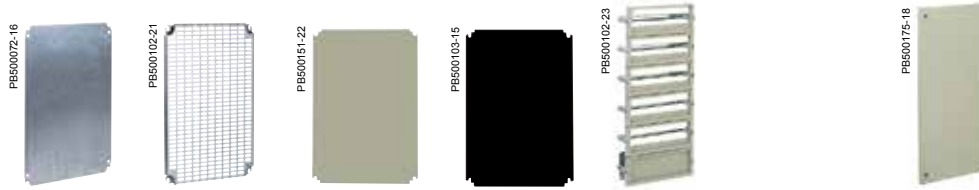

Dimensions (mm)			Metallic mounting plates		Insulating mounting plates		Modular distribution chassis		Internal door
Height	Width	N° of doors	Plain	Telequick	Polyester	Bakelite			
500	500	1	NSYPMM55	NSYPMR55	NSYPMA55	NSYPMB55	-	-	NSYPAPLA55
	750	1	NSYPMM75	NSYPMR57	NSYPMA75	NSYPMB75	-	-	NSYPAPLA57
	1000	2	NSYPMM510	2 x NSYPMR55	NSYPMA510	NSYPMB510	-	-	2 x NSYPAPLA55
	1250	2	NSYPMM55 + NSYPMM75	NSYPMR55 + NSYPMR57	NSYPMA55 + NSYPMA75	NSYPMB55 + NSYPMB75	-	-	NSYPAPLA55 + NSYPAPLA57
750	500	1	NSYPMM75	NSYPMR75	NSYPMA75	NSYPMB75	NSYDLP76	NSYDLP57	NSYPAPLA75
	750	1	NSYPMM77	NSYPMR77	NSYPMA77	NSYPMB77	NSYDLP132	NSYDLP99	NSYPAPLA77
	1000	2	NSYPMM710	2 x NSYPMR75	NSYPMA710	NSYPMB710	2 x NSYDLP76	2 x NSYDLP57	2 x NSYPAPLA75
	1250	2	NSYPMM712	NSYPMR75 + NSYPMR77	NSYPMA712	NSYPMB712	NSYDLP76 + NSYDLP132	NSYDLP57 + NSYDLP99	NSYPAPLA75 + NSYPAPLA77
1000	500	1	NSYPMM105	NSYPMR105	NSYPMA105	NSYPMB105	NSYDLP114	NSYDLP95	NSYPAPLA105
	750	1	NSYPMM107	NSYPMR107	NSYPMA107	NSYPMB107	NSYDLP198	NSYDLP165	NSYPAPLA107
	1000	2	NSYPMM1010	2 x NSYPMR105	NSYPMA1010	NSYPMB1010	2 x NSYDLP114	2 x NSYDLP95	2 x NSYPAPLA105
	1250	2	NSYPMM1012	NSYPMR105 + NSYPMR107	NSYPMA1012	NSYPMB1012	NSYDLP114 + NSYDLP198	NSYDLP95 + NSYDLP165	NSYPAPLA105 + NSYPAPLA107
1250	500	1	NSYPMM125	NSYPMR125	NSYPMA125	NSYPMB125	NSYDLP133	NSYDLP114P	NSYPAPLA125
	750	1	NSYPMM127	NSYPMR127	NSYPMA127	NSYPMB127	NSYDLP231	NSYDLP198P	NSYPAPLA127
	1000	2	NSYPMM1210	2 x NSYPMR125	NSYPMA1210	NSYPMB1210	2 x NSYDLP133	2 x NSYDLP114P	2 x NSYPAPLA125
	1250	2	NSYPMM1212	NSYPMR125 + NSYPMR127	NSYPMA1212	NSYPMB1212	NSYDLP133 + NSYDLP231	NSYDLP114P + NSYDLP198P	NSYPAPLA125 + NSYPAPLA127
1500	500	1	NSYPMM155	NSYPMR155	-	NSYPMB155	NSYDLP171	NSYDLP152	NSYPAPLA155
	750	1	NSYPMM157	NSYPMR157	-	NSYPMB157	NSYDLP297	NSYDLP264	NSYPAPLA157
	1000	2	NSYPMM1510	2 x NSYPMR155	-	NSYPMB1510	2 x NSYDLP171	2 x NSYDLP152	2 x NSYPAPLA155
	1250	2	NSYPMM1512	NSYPMR155 + NSYPMR157	-	NSYPMB1512	NSYDLP171 + NSYDLP297	NSYDLP152 + NSYDLP264	NSYPAPLA155 + NSYPAPLA157

#### Step slides



Page 230

#### Uprights and mounting rails



Page 231

#### Door retainer



Page 224

# Selection guide

## Polyester floor-standing enclosures

### Composition accessories

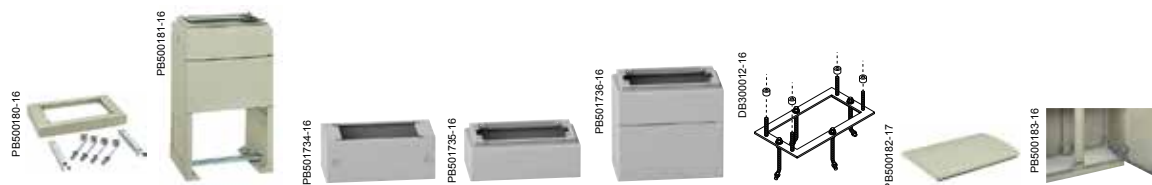

Dimensions (mm)		N plinth	H plinth	ZA plinth	ZZ plinth		Floor-fixing frame	Canopy	Cable-entry plate
Width	Depth	Height 60 mm	Height 900 mm	Height 200 mm	Height 200 mm	Height 500 mm			
500	320	NSYZNPLA53	NSYZHPLA53	NSYZA253	NSYZZ253	NSYZZ553	NSYMFPLAZ53	NSYTJPLA53	NSYECPLAZ53
	420	NSYZNPLA54	NSYZHPLA54	NSYZA273	NSYZZ273	NSYZZ573	NSYMFPLAZ54	NSYTJPLA54	NSYECPLAZ54
750	320	NSYZNPLA73	NSYZHPLA73	NSYZA2103	NSYZZ2103	NSYZZ5103	NSYMFPLAZ73	NSYTJPLA73	NSYECPLAZ73
	420	NSYZNPLA74	NSYZHPLA74	NSYZA2123	NSYZZ2123	NSYZZ5123	NSYMFPLAZ74	NSYTJPLA74	NSYECPLAZ74
1000	320	NSYZNPLA103	NSYZHPLA103	NSYZA254	NSYZZ254	NSYZZ554	NSYMFPLAZ103	NSYTJPLA103	NSYECPLAZ103
	420	NSYZNPLA104	NSYZHPLA104	NSYZA274	NSYZZ274	NSYZZ574	NSYMFPLAZ104	NSYTJPLA104	NSYECPLAZ104
1250	320	NSYZNPLA123	NSYZHPLA123	NSYZA2104	NSYZZ2104	NSYZZ5104	NSYMFPLAZ123	NSYTJPLA123	NSYECPLAZ123
	420	NSYZNPLA124	NSYZHPLA124	NSYZA2124	NSYZZ2124	NSYZZ5124	NSYMFPLAZ124	NSYTJPLA124	NSYECPLAZ124

**Door switch**  
 Page 224  
 PB500186-24

**Insert**  
 Page 225  
 PB500187-22

**Document pocket**  
 Page 297  
 PB500188-23

**VDI accessories and mountings**  
 Page 267  
 PB500189-18, PB500190-23

**Coupling Kit**  
 Page 218  
 DB300013-33

**Anti-graffiti paint**  
 Page 205  
 PB500191-15

**Handles and inserts**  
 Page 225  
 PB500192-10, PB500193-11

**Wall-mounting lug**  
 Page 219  
 PB500194-21

# Steel industrial boxes



# Steel industrial boxes

## Contents

PE500198-13



### Spacial SDB Metallic junction boxes and small metallic enclosures **34**

Characteristics **34**

PE502069-20



**New**

### Spacial SBM Steel industrial boxes **36**

Introduction **36**

Characteristics **37**

Technical characteristics **38**

Dimensions **39**

Specific accessories overview **40**

Common accessories overview **41**

Mounting accessories **42**

Mounting accessories **44**

# Metallic junction boxes

## Characteristics

PB500198-38



PB500237-38



Characteristics		Metallic junction boxes			
		<ul style="list-style-type: none"> <li>■ PVC sealing gasket on sizes up to 20/15 and a rubber gasket for &gt; 25/20.</li> <li>■ Back ready for threaded drill holes for mounting equipment. From size 15/10 and up, there are four M4 threaded holes fitted with removable plugs for direct mounting of the mounting plate.</li> <li>■ The SDB series consists of 4 basic models:                             <table border="0" style="width: 100%;"> <tr> <td style="width: 50%; vertical-align: top;"> <ul style="list-style-type: none"> <li>□ without knock-outs: with high cover,</li> <li>□ with knock-outs: <b>NSYDA●●●M</b> with high cover.</li> </ul> </td> <td style="width: 50%; vertical-align: top;"> <ul style="list-style-type: none"> <li>□ without knock-outs: with low cover,</li> <li>□ with knock-outs: <b>NSYDB●●●M</b> with low cover.</li> </ul> </td> </tr> </table> </li> </ul>	<ul style="list-style-type: none"> <li>□ without knock-outs: with high cover,</li> <li>□ with knock-outs: <b>NSYDA●●●M</b> with high cover.</li> </ul>	<ul style="list-style-type: none"> <li>□ without knock-outs: with low cover,</li> <li>□ with knock-outs: <b>NSYDB●●●M</b> with low cover.</li> </ul>	
<ul style="list-style-type: none"> <li>□ without knock-outs: with high cover,</li> <li>□ with knock-outs: <b>NSYDA●●●M</b> with high cover.</li> </ul>	<ul style="list-style-type: none"> <li>□ without knock-outs: with low cover,</li> <li>□ with knock-outs: <b>NSYDB●●●M</b> with low cover.</li> </ul>				
Material	Sheet steel				
Finish	Protected inside and outside with textured epoxy-polyester paint				
Colour	RAL 7035 grey				
Ingress protection rating	IP55 according to IEC 60529				
Mechanical protection rating	IK07				
Installation	Indoor installation: direct wall-mounting by means of drill holes fitted with plastic plugs to ensure sealing Outdoor installation: compliant with IEC 62208 regarding type tests specified in §9.12 (resistance to ultra-violet (UV) radiation) and §9.13 (resistance to corrosion). It is always advisable to install a canopy to avoid water stagnation on the upper part of the enclosure				
References		<b>NSYDAN●●●</b>	<b>NSYDBN●●●</b>		

## Dimensions

Models	External dimensions (mm)			Models without knock-outs	Models with knock-outs, no. of drill holes, knock-outs and group	Dimensions (mm)			Plain mounting plate	Weight (kg)
	Height (A)	Width (B)	Depth (C)			References	References	Height (A)		
Low cover	85	85	49	<b>NSYDBN88</b>	<b>NSYDB88M</b>	1 n° 1	1 n° 1	58 58 -	-	0.18
	105	105	49	<b>NSYDBN1010</b>	<b>NSYDB1010M</b>	2 n° 1	1 n° 1	76 76 -	-	0.25
	155	105	61	<b>NSYDBN1510</b>	<b>NSYDB1510M</b>	3 n° 1	1 n° 2	124 74 56	<b>NSYPMD1510</b>	0.38
	206	156	83	<b>NSYDBN2015</b>	<b>NSYDB2015M</b>	3 n° 3	2 n° 3	172 122 78	<b>NSYPMD2015</b>	1
	256	206	93	<b>NSYDBN2520</b>	<b>NSYDB2520M</b>	3 n° 4	2 n° 4	220 170 88	<b>NSYPMD2520</b>	1.5
	307	257	116	<b>NSYDBN3025</b>	<b>NSYDB3025M</b>	2 n° 3, 2 n° 4	3 n° 4	268 218 110	<b>NSYPMD3025</b>	3.3
High cover	357	307	136	<b>NSYDBN3530</b>	<b>NSYDB3530M</b>	2 n° 3, 3 n° 4	2 n° 3, 2 n° 4	318 268 130	<b>NSYPMD3530</b>	4.8
	155	105	88	<b>NSYDAN1510</b>	<b>NSYDA1510M</b>	3 n° 2	1 n° 2	124 74 83	<b>NSYPMD1510</b>	0.45
	206	156	122	<b>NSYDAN2015</b>	<b>NSYDA2015M</b>	3 n° 3	2 n° 3	172 122 121	<b>NSYPMD2015</b>	1.2
	256	206	140	<b>NSYDAN2520</b>	<b>NSYDA2520M</b>	3 n° 4	2 n° 4	220 170 131	<b>NSYPMD2520</b>	1.9

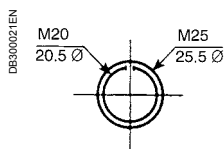

Group n° 1

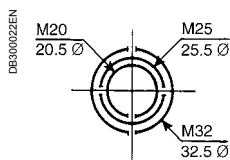

Group n° 2

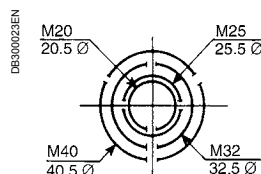

Group n° 3

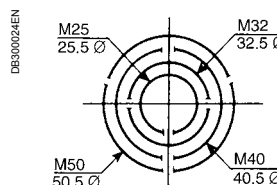

Group n° 4

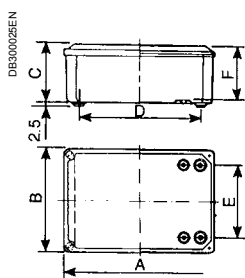

NSYDBN

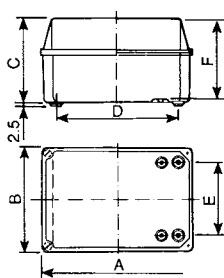

NSYDAN

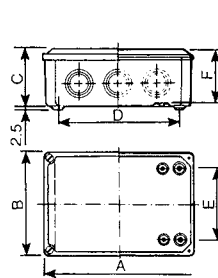

NSYDB●●●M

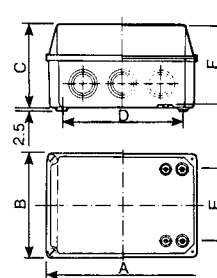

NSYDA●●●M



### Small metallic enclosures

- Enclosures fitted with sealing gasket and M4 threaded holes fitted with removable plugs for mounting the mounting plate and/or equipment in general.
- Lock with double-bar insert operated with key (standard supply ). Mounting this key to the insert will convert it into a handle lock. See other lock possibilities in the insert table.
- The Spacial SDB series with hinges consists of 2 models:
  - low cover.
  - high cover.

Sheet steel  
 Protected inside and outside with textured epoxy-polyester paint  
 RAL 7035 grey  
 IP55 according to IEC 60529

NSYDAN...D

NSYSDBN...D

### Dimensions

Models	External dimensions (mm)			Models without knock-outs	Dimensions (mm)				Plain mounting plate	Weight (kg)
	Height (A)	Width (B)	Depth (C)		References	D	E	F		
Low cover	206	156	83	NSYDBN2015D	172	122	78	55	NSYPMD2015	1
	256	206	93	NSYDBN2520D	220	170	88	55	NSYPMD2520	1.5
	307	257	116	NSYDBN3025D	268	218	110	55	NSYPMD3025	3.3
	357	307	136	NSYDBN3530D	318	268	130	55	NSYPMD3530	4.8
High cover	206	156	122	NSYDAN2015D	172	122	121	45	NSYPMD2015	1.2
	256	206	140	NSYDAN2520D	220	170	131	45	NSYPMD2520	1.9
	307	257	174	NSYDAN3025D	268	218	168	45	NSYPMD3025	4
	357	307	210	NSYDAN3530D	318	268	204	45	NSYPMD3530	5.8

### Conversions of standard lock into normalised solutions

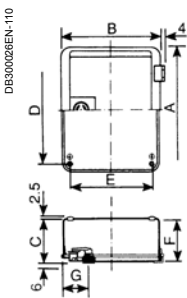

NSYDBN...D

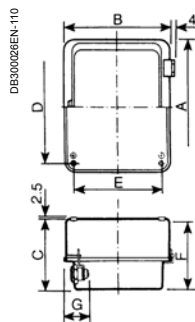

NSYDAN...D

Type and size	Operated with a key	References
 Square insert	<input type="checkbox"/> 6 mm	LC-7  NSYTC6CRN
	<input type="checkbox"/> 7 mm	LC-7  NSYTC7CRN
	<input type="checkbox"/> 8 mm	LC-8  NSYTC8CRN
 Triangular insert	<input type="checkbox"/> 6 mm	LT-8  NSYTT6CRN
	<input type="checkbox"/> 7 mm	LT-8  NSYTT7CRN
	<input type="checkbox"/> 8 mm	LT-8  NSYTT8CRN
405 key-type lock		NSYCL405CRN

# Steel industrial boxes

## Introduction

**New**

> Simplicity, ergonomics and versatility, it's all in the box.

PB502105-40



PB502112-17



### Selection

- 3 versions: flat box (SBM), FL21 entry box (SBMC) and bus box (SBMB).
- 80 mm and 120 mm depth.
- FL21 cable entries available according to the version.

PB502113-30



### Modularity

- 28 sizes available.
- Up to 42 sizes possible thanks to the optional Extension box accessory.

PB 902073-20



### Ergonomics

- Cover opening and accessory mounting with **just a screwdriver**.
- Better accessibility thanks to the Extension box accessory.

PB502085-20



### Sturdy and good ingress protection

- Mechanical protection rating up to IK10.
- Ingress protection rating up to IP66.

DB300080

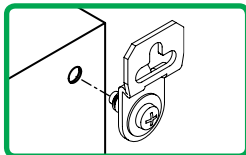

### Easy installation

- Direct mounting through the rear.
- Mounting with versatile external lugs.

PB502071-20



### Added value to your work

- Quality and aesthetics.

**This range can be configured according to your needs**

4 different services available:



Assemble to order



Mounting of standard accessories



Painting



Machining

See page 396 for details or consult our web site [www.schneider-electric.com](http://www.schneider-electric.com)

New

PE502069-40



PE502070-35



PE502071-35



	Spacial SBM Flat box	Spacial SBMC FL21 Entry box	Spacial SBMB Bus box
	Box with plain faces.	Equipped with two or more FL21 cable gland plates.	Equipped with FL 21 cable gland plates, a hinged cover with a transparent polycarbonate window and a DIN rail.
	<p><b>Box body</b> Single-piece body (rectangular structure). Front design incorporating folded gutters. Flat rear. 2 (or 3*) drilled profiles for installing mounting plates and DIN rails, with mounting centres of 12.5 mm. 2 or more FL21 cable gland plates (1) for easy drilling and to guarantee the maximum access area, delivered with the enclosure.</p> <p><b>Box cover</b> Equipped with 2, 3, 4 or 6 half-turn thread screws, according to the version (2) to ensure maximum watertightness. Bus boxes equipped with cover hinges for a comfortable 180° door opening. Polyurethane sealing gasket.</p> <p><b>Protection of personnel</b> Earth connection mandatory for all boxes: Spacial SBM steel boxes are equipped with a M6 x 16 earth stud welded in the cover, to be linked with the body for equipotential connection. Earth braid to be ordered separately (Ø 6.4 mm terminal).</p>		
Material	Sheet steel		
Finish	Structured		
Colour	RAL 7035 grey		
Ingress protection rating	IP66	IP55	
Mechanical protection rating	IK10		IK08
Standard	Compliance with enclosure standard IEC 62208 and the RoHS directive		
Certifications	<ul style="list-style-type: none"> <li>■ UL, BV, DNV, LR, GL</li> <li>■ Type 4, 4X according to UL 508A standard</li> <li>■ Fire class: M0</li> </ul>	<ul style="list-style-type: none"> <li>■ UL, BV, DNV, LR, GL</li> <li>■ Type 12, 12K according to UL 508A standard</li> <li>■ Fire class: M0</li> </ul>	
Installation	<p><b>Indoor installation</b> Direct wall-mounting (4 x Ø 10 mm holes with sealing plugs to maintain the IP rating) or with the help of mounting brackets installed from the outside (to be ordered separately, see the specific accessory pages). Distance between mounting holes enables the installation of the box in the same locations as many existing enclosures. Marks on the rear of the box locate the mounting points of obsolete Schneider Electric models. Marks on the sides help with drilling the body to install hinges</p> <p><b>Outdoor installation</b> Compliant with IEC 62208 regarding type tests specified in §9.12 (resistance to ultra-violet (UV) radiation) and §9.13 (resistance to corrosion). It is always advisable to place the box under shelter to avoid water stagnation on the upper part of the enclosure</p>		
Maximum load	Loading capacity on the body: 50 kg/m <sup>2</sup>		
Other characteristics	<p><b>Vibration constraints</b> Specific construction of the Spacial SBM - Single-piece body (rectangular structure). The rear is flat without added parts - this ensures compliance with certain vibration constraints. The tests were conducted according to the marine application by "Det Norske Veritas". Boxes labelled "DNV" have undergone these tests and obtained classification "A"</p>		

\* 3 profiles for width 800 mm.

(1) Only on Entry boxes and Bus boxes.

(2) 2 for Bus box (3 screws for width greater than 400 mm), 4 for Flat and Entry boxes (6 screws for width greater than 400 mm).

# Steel industrial boxes

## Technical characteristics

New

Box			Extension box	FL21 cable gland*		Power dissipation**	Sheet thickness
Height (mm)	Width (mm)	Depth (mm)	Total depth (mm)	Along Height (mm)	Width (mm)	(W)	(mm)
150	150	80				13.5	10/10 <sup>e</sup>
		120				17.2	10/10 <sup>e</sup>
	200	80				16.6	10/10 <sup>e</sup>
		120				20.8	10/10 <sup>e</sup>
	300	80				22.8	10/10 <sup>e</sup>
		120			1+1	28.1	10/10 <sup>e</sup>
400	80				29.0	10/10 <sup>e</sup>	
	120			1+1	35.3	10/10 <sup>e</sup>	
200	200	80	160			20.6	10/10 <sup>e</sup>
		120	200			25.6	10/10 <sup>e</sup>
	300	80	160			28.2	10/10 <sup>e</sup>
		120	200		1+1	34.2	10/10 <sup>e</sup>
	400	80	160			35.7	10/10 <sup>e</sup>
		120	200		1+1	42.8	10/10 <sup>e</sup>
	500	80	160			43.3	12/10 <sup>e</sup>
		120	200			51.4	12/10 <sup>e</sup>
	600	80	160			50.8	12/10 <sup>e</sup>
		120	200			60.1	12/10 <sup>e</sup>
800	120				2+2	77.3	12/10 <sup>e</sup>
					2+2		
300	300	120	200	1+1	1+1	46.4	10/10 <sup>e</sup>
	400	120	200	1+1	1+1	57.8	10/10 <sup>e</sup>
	500	120	200			69.1	12/10 <sup>e</sup>
	600	120	200	1+1	2+2	80.4	12/10 <sup>e</sup>
	800	120		1+1	2+2	103.0	12/10 <sup>e</sup>
400	400	120		1+1	1+1	72.7	10/10 <sup>e</sup>
	500	120				86.7	12/10 <sup>e</sup>
	600	120		1+1	2+2	100.7	12/10 <sup>e</sup>
	800	120		1+1	2+2	128.7	12/10 <sup>e</sup>

\* Only on SBMB and SBMC boxes.

\*\* Power dissipation calculated for a box mounted on a wall, at external temperature 25°C and maximum internal temperature 55°C.

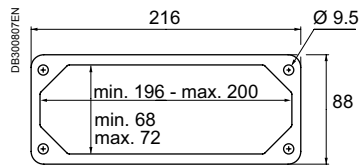

New

### External mounting of box & mounting accessories

Box		Mounting			Mounting					
Height (mm)	Width (mm)	Ah (mm)	Bh (mm)	Bw (mm)	C (mm)	D (mm)	E (mm)	F (mm)	G (mm)	H (mm)
150	150	20.5	109	109	125	-	12.5	85	85	-
	200	20.5	109	159	175	-	12.5	85	135	-
	300	20.5	109	259	275	-	12.5	85	235	-
	400	20.5	109	359	375	-	12.5	85	335	-
200	200	20.5	159	159	175	-	12.5	135	135	-
	300	20.5	159	259	275	-	12.5	135	235	-
	400	20.5	159	359	375	-	12.5	135	335	-
	500	20.5	159	459	475	-	12.5	135	435	200
	600	20.5	159	559	575	-	12.5	135	535	250
	800	20.5	159	759	775	387.5	12.5	135	735	350
300	300	20.5	259	259	275	-	12.5	235	235	-
	400	20.5	259	359	375	-	12.5	235	335	-
	500	20.5	259	459	475	-	12.5	235	435	200
	600	20.5	259	559	575	-	12.5	235	535	250
400	400	20.5	359	359	375	-	12.5	335	335	-
	500	20.5	359	459	475	-	12.5	335	435	200
	600	20.5	359	559	575	-	12.5	335	535	250
	800	20.5	359	759	775	387.5	12.5	335	735	350

Section A-A

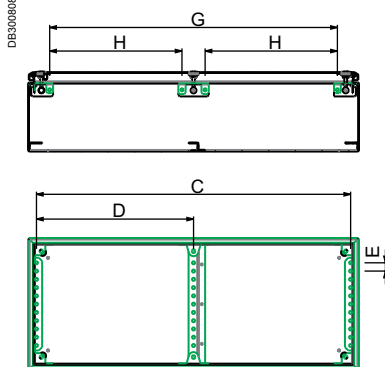

Section B-B

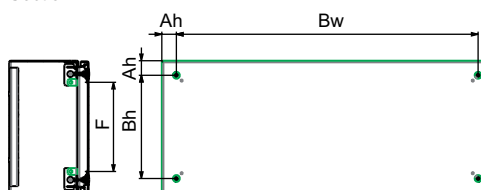

### Mounting accessories

Extension box

PB50211-29



Page 42

Mounting plate

PB502100-29



Page 43

DIN rail

PB502101-29



Page 43

Post fastening

PE502098-20



Page 43

Coupling kit

PE502097-29



Page 43

### Mounting accessories

Mounting brackets

PB502088-10



Page 45

Self-tapping screws

PB502104-8



Page 45

Hinges

PB502102-17



Page 45

Double-bar shaped head screw

PB502105-10



Page 45

Triangle shaped head screw

PB502106-7



Page 45

Sealing kit

PB502103-18



Page 45



### Cable management

#### Cable entries



Page 270

---

# Steel industrial boxes

## Mounting accessories

New

PB502089-20



PB502070-20



PB502071-20



PB502111-20



Characteristics				Flat box	FL21 entry box	Bus box	Extension box (2)	
							Extension box that fits onto the corresponding box of the same height and width: <ul style="list-style-type: none"> <li>■ improved ergonomics and accessibility inside the box,</li> <li>■ increases the interior depth of the box (+80 mm).</li> </ul>	
Material							Sheet steel	
Colour							RAL 7035	
Ingress protection rating							IP66 (1 extension)	
Installation							Two earth braids must be used with the extension box	
Maximum load							30 kg/m <sup>2</sup> on the extension box	
Supply				1 unit	1 unit	1 unit	1 unit	
Dimensions (mm)			Cover screws (1)	References				
Height	Width	Depth	Qty	SBM	SBMC	SBMB		
150	150	80	4	NSYSBM15158	-	-	-	
		120	4	NSYSBM151512	-	-	-	
	200	80	4	NSYSBM15208	-	-	-	
		120	4	NSYSBM152012	-	-	-	
	300	80	4	NSYSBM15308	-	-	-	
		120	4	NSYSBM153012	NSYSBMC153012	-	-	
	400	80	4	NSYSBM15408	-	-	-	
		120	4	NSYSBM154012	NSYSBMC154012	-	-	
200	200	80	4	NSYSBM20208	-	-	NSYAES228SB	
		120	4	NSYSBM202012	-	-	NSYAES228SB	
	300	80	4	NSYSBM20308	-	-	NSYAES238SB	
		120	4	NSYSBM203012	NSYSBMC203012	NSYSBMB203012	NSYAES238SB	
	400	80	4	NSYSBM20408	-	-	NSYAES248SB	
		120	4	NSYSBM204012	NSYSBMC204012	NSYSBMB204012	NSYAES248SB	
	500	80	6	NSYSBM20508	-	-	NSYAES258SB	
		120	6	NSYSBM205012	-	-	NSYAES258SB	
	600	80	6	NSYSBM20608	-	-	NSYAES268SB	
		120	6	NSYSBM206012	NSYSBMC206012	NSYSBMB206012	NSYAES268SB	
	800	120	6	NSYSBM208012	NSYSBMC208012	NSYSBMB208012	-	
	300	300	120	4	NSYSBM303012	NSYSBMC303012	-	NSYAES338SB
		400	120	4	NSYSBM304012	NSYSBMC304012	-	NSYAES348SB
		500	120	6	NSYSBM305012	-	-	NSYAES358SB
		600	120	6	NSYSBM306012	NSYSBMC306012	-	NSYAES368SB
800		120	6	NSYSBM308012	NSYSBMC308012	-	-	
400	400	120	4	NSYSBM404012	NSYSBMC404012	-	-	
	500	120	6	NSYSBM405012	-	-	-	
	600	120	6	NSYSBM406012	NSYSBMC406012	-	-	
	800	120	6	NSYSBM408012	NSYSBMC408012	-	-	

(1) For Bus box, divide by 2.  
 (2) Not compatible with Bus box.



Mounting plate	DIN rail (3)	Post fastening	Coupling kit
-	Symmetrical DIN rails 35 x 7.5 mm.	Rail fixed externally to the rear of the box with 8 mm screws for installation on posts with diameters between 150 mm and 215 mm. For steel boxes with widths of 150, 200, 300, 400, 500, 600 and 800 mm.	Entry boxes or Bus boxes can be coupled with each other through their FL21 cable entry openings. They can be coupled together in any combination.
Galvanised steel	Galvanised steel	Galvanised steel	-
-	-	-	-
-	-	-	IP55
Mounting by means of 2* or 4 x Ø 5 mm self-tapping screws, Pozidriv head, ref. <b>NSYAMFSB</b> (4). Mounting plate mounting points compatible with many other brands of accessories	Mounting by means of 2 x Ø 5 mm self-tapping screws, Pozidriv head, ref. <b>NSYAMFSB</b> (4)	-	For boxes bigger than 500 mm, order the same amount of units as the cable gland plate openings on the face of the box to be coupled, see table on page 38
-	-	100 kg	-
1 unit, supplied without screws	10 rails, supplied without screws	1 unit	1 gasket and necessary hardware

<b>NSYMM11SB</b>	<b>NSYAMRD15357SB</b>	<b>NSYSFPSC15</b>	<b>NSYAEUBU148**</b>
<b>NSYMM11SB</b>	<b>NSYAMRD15357SB</b>	<b>NSYSFPSC15</b>	
<b>NSYMM12SB</b>	<b>NSYAMRD20357SB</b>	<b>NSYSFPSC20</b>	
<b>NSYMM12SB</b>	<b>NSYAMRD20357SB</b>	<b>NSYSFPSC20</b>	
<b>NSYMM13SB</b>	<b>NSYAMRD30357SB</b>	<b>NSYSFPSC30</b>	
<b>NSYMM13SB</b>	<b>NSYAMRD30357SB</b>	<b>NSYSFPSC30</b>	
<b>NSYMM14SB</b>	<b>NSYAMRD40357SB</b>	<b>NSYSFPSC40</b>	
<b>NSYMM14SB</b>	<b>NSYAMRD40357SB</b>	<b>NSYSFPSC40</b>	
<b>NSYMM22SB</b>	<b>NSYAMRD20357SB</b>	<b>NSYSFPSC20</b>	
<b>NSYMM22SB</b>	<b>NSYAMRD20357SB</b>	<b>NSYSFPSC20</b>	
<b>NSYMM23SB</b>	<b>NSYAMRD30357SB</b>	<b>NSYSFPSC30</b>	
<b>NSYMM23SB</b>	<b>NSYAMRD30357SB</b>	<b>NSYSFPSC30</b>	
<b>NSYMM24SB</b>	<b>NSYAMRD40357SB</b>	<b>NSYSFPSC40</b>	
<b>NSYMM24SB</b>	<b>NSYAMRD40357SB</b>	<b>NSYSFPSC40</b>	
<b>NSYMM25SB</b>	<b>NSYAMRD50357SB</b>	<b>NSYSFPSC50</b>	
<b>NSYMM25SB</b>	<b>NSYAMRD50357SB</b>	<b>NSYSFPSC50</b>	
<b>NSYMM26SB</b>	<b>NSYAMRD60357SB</b>	<b>NSYSFPSC60</b>	
<b>NSYMM26SB</b>	<b>NSYAMRD60357SB</b>	<b>NSYSFPSC60</b>	
<b>NSYMM28SB</b>	<b>NSYAMRD80357SB</b>	<b>NSYSFPSC80</b>	
<b>NSYMM33SB</b>	<b>NSYAMRD30357SB</b>	<b>NSYSFPSC30</b>	
<b>NSYMM34SB</b>	<b>NSYAMRD40357SB</b>	<b>NSYSFPSC40</b>	
<b>NSYMM35SB</b>	<b>NSYAMRD50357SB</b>	<b>NSYSFPSC50</b>	
<b>NSYMM36SB</b>	<b>NSYAMRD60357SB</b>	<b>NSYSFPSC60</b>	
<b>NSYMM38SB</b>	<b>NSYAMRD80357SB</b>	<b>NSYSFPSC80</b>	
<b>NSYMM44SB</b>	<b>NSYAMRD40357SB</b>	<b>NSYSFPSC40</b>	
<b>NSYMM45SB</b>	<b>NSYAMRD50357SB</b>	<b>NSYSFPSC50</b>	
<b>NSYMM46SB</b>	<b>NSYAMRD60357SB</b>	<b>NSYSFPSC60</b>	
<b>NSYMM48SB</b>	<b>NSYAMRD80357SB</b>	<b>NSYSFPSC80</b>	

(3) Standard equipped in Bus box.

(4) All boxes are delivered with 5 x Ø 5 mm self-tapping screws.

\* Only 2 screws for mounting plates with height 150 mm.

\*\* Same reference for all dimensions. Only compatible with FL21 entry box and Bus box.

# Steel industrial boxes

## Mounting accessories

New

PB502089-20



PB502070-20



PB502071-20



Characteristics				Flat box	FL21 entry box	Bus box
Colour						
Ingress protection rating						
Installation						
Maximum load						
Supply				1 unit	1 unit	1 unit
Dimensions (mm)			Cover screws (1)	References		
Height	Width	Depth	Qty	SBM	SBMC	SBMB
150	150	80	4	NSYSBM15158	-	-
		120	4	NSYSBM151512	-	-
	200	80	4	NSYSBM15208	-	-
		120	4	NSYSBM152012	-	-
	300	80	4	NSYSBM15308	-	-
		120	4	NSYSBM153012	NSYSBMC153012	-
	400	80	4	NSYSBM15408	-	-
		120	4	NSYSBM154012	NSYSBMC154012	-
200	200	80	4	NSYSBM20208	-	-
		120	4	NSYSBM202012	-	-
	300	80	4	NSYSBM20308	-	-
		120	4	NSYSBM203012	NSYSBMC203012	NSYSBMB203012
	400	80	4	NSYSBM20408	-	-
		120	4	NSYSBM204012	NSYSBMC204012	NSYSBMB204012
	500	80	6	NSYSBM20508	-	-
		120	6	NSYSBM205012	-	-
	600	80	6	NSYSBM20608	-	-
		120	6	NSYSBM206012	NSYSBMC206012	NSYSBMB206012
	800	120	6	NSYSBM208012	NSYSBMC208012	NSYSBMB208012
		300	120	4	NSYSBM303012	NSYSBMC303012
300	400	120	4	NSYSBM304012	NSYSBMC304012	-
	500	120	6	NSYSBM305012	-	-
	600	120	6	NSYSBM306012	NSYSBMC306012	-
	800	120	6	NSYSBM308012	NSYSBMC308012	-
400	400	120	4	NSYSBM404012	NSYSBMC404012	-
	500	120	6	NSYSBM405012	-	-
	600	120	6	NSYSBM406012	NSYSBMC406012	-
	800	120	6	NSYSBM408012	NSYSBMC408012	-

(1) For Bus box, divide by 2.



# Steel wall-mounting enclosures

PB500198-22



### **Spacial S3DC** **48** **Steel wall-mounting enclosures**

Introduction	48
Characteristics	56
Protection	58
Dimensions	59
Selection Guide	60
Accessories	62
Cable Management	76
Disconnect Enclosures	78

PB500389-31



### **Spacial CRN-CRNG** **84** **Steel wall-mounting enclosures**

Introduction	84
Characteristics	85
Selection Guide	86
Dimensions	90
Accessories	92
Cable Management	

PB500086-54



### **Associated applicative offers** **305**

<b>S3HD</b> Wall-mounting Heavy Duty enclosures	306
<b>S3D 6G, S3D 6G K3</b> Seismic and nuclear enclosures	320
<b>S3HF</b> Electromagnetic compatibility	342
<b>S3DEX</b> Potentially explosive atmospheres	352

Spacial® S3DC, CRN and CRNG

### Steel enclosures

#### > Mounting & cabling systems

for setting up devices and managing cabling

#### > Thermal management

for controlling the internal temperature & humidity of the enclosure



## 3 Material Solutions

Steel

Stainless-steel

Polyester

### Time-saving & easy to equip

...with direct installation of the mounting plate.

**Spacial S3DC, CRN and CRNG** are designed to protect your equipment in most indoor installations with **harsh & dirty environments**, such as:

- > Machines
- > Manufacturing plants
- > Logistics centers, etc

Whatever the installation environment, you can select the material according to your needs: steel, stainless-steel or polyester. Our enclosures share the same sizes and most of the mounting, cabling and installation accessories, to make selection and mounting simpler!

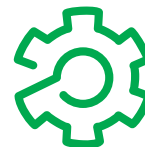

Machines



Industry



+ Simple to choose,  
simple to order  
and simple to use!

Spacial S3X

Stainless-steel enclosures



Thalassa™ PLM

Polyester enclosures



Durable & hygienic

...using highly corrosion-resistant material with a detailed finish, to reduce the risk of contamination.

**Spacial S3X** is commonly used in:

- > **Food & beverage** and **pharmaceutical industries**, where the ability to clean hard water is required to help prevent the growth of bacteria.
- > The **oil & gas** industries, for its chemical resistance.



Food & Beverage

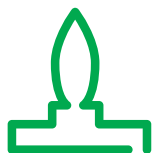

Oil & Gas

Safety & low maintenance

...thanks to its long-lasting and insulated material construction (Class II protection level from hazard).

**Thalassa PLM** offers excellent performance in:

- > **Outdoor applications**, such as road & train infrastructures, airports and harbors, including saline environments.
- > A good choice for harsh environments where non-corrosive materials are required.



Desalination



Airport

# Wall-mounting enclosures

## Selection guide



Dimensions (mm and inches)						Number of doors	IP	Spacial S3DC painted steel enclosures	Spacial S3X Stainless steel 304L
H (mm)	W (mm)	D (mm)	H (in.)	W (in.)	D (in.)			Plain door without mounting plate	Plain door without mounting plate
300	200	150	11.81	7.87	5.91	1	66	NSYS3DC3215	NSYS3X3215
300	300	150	11.81	11.81	5.91	1	66	NSYS3DC3315	NSYS3X3315
300	300	200	11.81	11.81	7.87	1	66	NSYS3DC3320	-
400	300	150	15.75	11.81	5.91	1	66	NSYS3DC4315	NSYS3X4315
400	300	200	15.75	11.81	7.87	1	66	NSYS3DC4320	NSYS3X4320
400	400	200	15.75	15.75	7.87	1	66	NSYS3DC4420	NSYS3X4420
500	400	200	19.69	15.75	7.87	1	66	NSYS3DC5420	NSYS3X5420
500	400	250	19.69	15.75	9.84	1	66	NSYS3DC5425	-
500	500	200	19.69	19.69	7.87	1	66	NSYS3DC5520	-
500	500	250	19.69	19.69	9.84	1	66	NSYS3DC5525	-
600	400	200	23.62	15.75	7.87	1	66	NSYS3DC6420	NSYS3X6420
600	400	250	23.62	15.75	9.84	1	66	NSYS3DC6425	-
600	600	200	23.62	23.62	7.87	1	66	NSYS3DC6620	-
600	600	250	23.62	23.62	9.84	1	66	NSYS3DC6625	NSYS3X6625
600	600	300	23.62	23.62	11.81	1	66	NSYS3DC6630	-
700	500	250	27.56	19.69	9.84	1	66	NSYS3DC7525	NSYS3X7525
800	600	200	31.50	23.62	7.87	1	66	NSYS3DC8620	-
800	600	250	31.50	23.62	9.84	1	66	NSYS3DC8625	NSYS3X8625
800	600	300	31.50	23.62	11.81	1	66	NSYS3DC8630	-
800	600	400	31.50	23.62	15.75	1	66	NSYS3DC8640	-
800	800	250	31.50	31.50	9.84	1	66	NSYS3DC8825	-
800	800	300	31.50	31.50	11.81	1	66	NSYS3DC8830	NSYS3X8830
1000	600	250	39.37	23.62	9.84	1	66	NSYS3D10625	-
1000	800	250	39.37	31.50	9.84	1	66	NSYS3DC10825	-
1000	800	300	39.37	31.50	11.81	1	66	NSYS3DC10830	NSYS3X10830
1000	800	400	39.37	31.50	15.75	1	66	NSYS3DC10840	-
1000	1000	300	39.37	39.37	11.81	1	66	NSYS3DC101030	-
1200	800	300	47.24	31.50	11.81	1	66	NSYS3DC12830	NSYS3X12830
1200	800	400	47.24	31.50	15.75	1	66	NSYS3DC12840	-
1200	1000	300	47.24	39.37	11.81	1	66	NSYS3DC121030	-

Wall-mounting bracket (x4)		
	Steel	NSYAEFPFSC
	Stainless steel	NSYPFCX
	Polyester	NSYPPFLM

Lighting		
	Neon light, magnetic or mechanical mounting	NSYLAM75
	Door contact S3DC/S3X	NSYINLCRN

Mounting		
	M6 nut for PLM direct mounting	NSYTCSPML
	Self-tapping screw for microperforated mounting plate	NSYS13M5HS
	Hexagonal screw M6 × 12 for alum. upright	NSYS12M6H
	Hexagonal screw M6 × 16 for alum. upright	NSYS16M6H
	Hexagonal screw M6 × 18 for alum. upright	NSYS18M6H
	M6 nut for alum. upright	NSYNM6

Door accessories		
	Door cable trunking support for Ø 22 mm / 0.86 in (×10)	NSYSPCP
	Plastic document pocket A4, d = 20 mm	NSYDPA4
	Plastic document pocket A4, d = 40 mm	NSYDPA44
	Plastic window 248 × 235 × 13	NSYVA2736M
	Plastic window 78 × 95 × 15	NSYVA274M

# Wall-mounting enclosures

## Selection guide



	Spacial S3XH Stainless steel 316L	Thalassa PLM Polyester	Plain mounting plate painted white	Plain mounting plate galvanized	Microperforated mounting plate	Perforated (Telequick™)*	Aluminum upright**
	Plain door without mounting plate	Plain door without mounting plate					
	NSYS3X3215H	NSYPLM32	NSYMM32WH	NSYMM32	NSYMF32	NSYMR32	NSYMDVR3
	NSYS3X3315H	-	NSYMM33WH	NSYMM33	NSYMF33	NSYMR33	NSYMDVR3
	-	-	NSYMM33WH	NSYMM33	NSYMF33	NSYMR33	NSYMDVR3
	NSYS3X4315H	-	NSYMM43WH	NSYMM43	NSYMF43	NSYMR43	NSYMDVR4
	NSYS3X4320H	NSYPLM43	NSYMM43WH	NSYMM43	NSYMF43	NSYMR43	NSYMDVR4
	NSYS3X4420H	-	NSYMM44WH	NSYMM44	NSYMF44	NSYMR44	NSYMDVR4
	NSYS3X5420H	NSYPLM54	NSYMM54WH	NSYMM54	NSYMF54	NSYMR54	NSYMDVR5
	-	-	NSYMM54WH	NSYMM54	NSYMF54	NSYMR54	NSYMDVR5
	-	-	NSYMM55WH	NSYMM55	NSYMF55	NSYMR55	NSYMDVR5
	-	-	NSYMM55WH	NSYMM55	NSYMF55	NSYMR55	NSYMDVR5
	NSYS3X6420H	-	NSYMM64WH	NSYMM64	NSYMF64	NSYMR64	NSYMDVR6
	-	NSYPLM64	NSYMM64WH	NSYMM64	NSYMF64	NSYMR64	NSYMDVR6
	-	-	NSYMM66WH	NSYMM66	NSYMF66	NSYMR66	NSYMDVR6
	NSYS3X6625H	-	NSYMM66WH	NSYMM66	NSYMF66	NSYMR66	NSYMDVR6
	-	-	NSYMM66WH	NSYMM66	NSYMF66	NSYMR66	NSYMDVR6
	NSYS3X7525H	-	NSYMM75WH	NSYMM75	NSYMF75	NSYMR75	NSYMDVR7
	-	-	NSYMM86WH	NSYMM86	NSYMF86	NSYMR86	NSYMDVR8
	NSYS3X8625H	-	NSYMM86WH	NSYMM86	NSYMF86	NSYMR86	NSYMDVR8
	-	NSYPLM86	NSYMM86WH	NSYMM86	NSYMF86	NSYMR86	NSYMDVR8
	-	-	NSYMM86WH	NSYMM86	NSYMF86	NSYMR86	NSYMDVR8
	-	-	NSYMM88WH	NSYMM88	NSYMF88	NSYMR88	NSYMDVR8
	NSYS3X8830H	-	NSYMM88WH	NSYMM88	NSYMF88	NSYMR88	NSYMDVR8
	-	-	NSYMM106WH	NSYMM106	NSYMF106	NSYMR106	NSYMDVR10
	-	-	NSYMM108WH	NSYMM108	NSYMF108	NSYMR108	NSYMDVR10
	NSYS3X10830H	NSYPLM108	NSYMM108WH	NSYMM108	NSYMF108	NSYMR108	NSYMDVR10
	-	-	NSYMM108WH	NSYMM108	NSYMF108	NSYMR108	NSYMDVR10
	-	-	NSYMM1010WH	NSYMM1010	NSYMF1010	NSYMR1010	NSYMDVR10
	NSYS3X12830H	-	NSYMM128WH	NSYMM128	NSYMF128	NSYMR128	NSYMDVR12
	-	-	NSYMM128WH	NSYMM128	NSYMF128	NSYMR128	NSYMDVR12
	-	-	NSYMM1210WH	NSYMM1210	NSYMF1210	NSYMR1210	NSYMDVR12

\*NSYEMR is mandatory for Spacial S3DC enclosure width > 1000 mm.

\*\*NSYAMCSF is mandatory for S3DC and S3X enclosures.

Grounding	
	Grounding lead 160, sec. 6² <b>NSYEL166D8</b>
	Grounding lead L350, sec. 25² <b>NSYEL3525D8</b>
	Grounding strip connection points 87 <b>NSYECB1M153</b>
	2 grounding collector supports <b>NSYEDCOS</b>
	2 grounding collector rail sup- ports <b>NSYEDCOC</b>

Locking system	
	Screwdriver insert for Thalassa PLM <b>NSYAEDLSD</b>

# Steel wall-mounting enclosures

## Selection guide



S3DC

**You need an efficient, sealed multipurpose and aesthetic enclosure for an indoor industrial facility.**

**Our solution: the Spacial S3DC universal offer.**

A universal enclosure with 3-point locks and a broad range of accessories to conform to all your applications.

NEMA 4, 4X, IP66 water and dust tightness.

A complete offer of 30 dimensions from 300 × 200 × 150 mm (11.8 × 7.9 × 5.9 in.) to 1200 × 1000 × 300 mm (47.2 × 39.4 × 11.8 in.):

- With plain door, without cable-gland plate
- Resistance to mechanical impacts: IK10 plain door
- Compliance with enclosure standard EN 62208 and IEC 62208
- A broad range of accessories to conform to all your applications
- See the Selection Guide on page 60.



S3DCD

**You need an efficient sealed enclosure for a specific application such as electronics and electricity distribution.**

**Our solution: the Spacial S3DC application offer.**

- Models sized and suited for your applications
- Discover our S3DCD disconnect enclosure on page 78.



S3HF

**You need an efficient sealed enclosure for an industrial facility with EMC constraints.**

**Our solution: the offer for EMC environments.**

**Enclosures suited to different EMC environments.**

- IP55 water and dust tightness
- See page 342.





**Spacial S3DC:**  
The multipurpose enclosure

# Steel wall-mounting enclosures

## Features

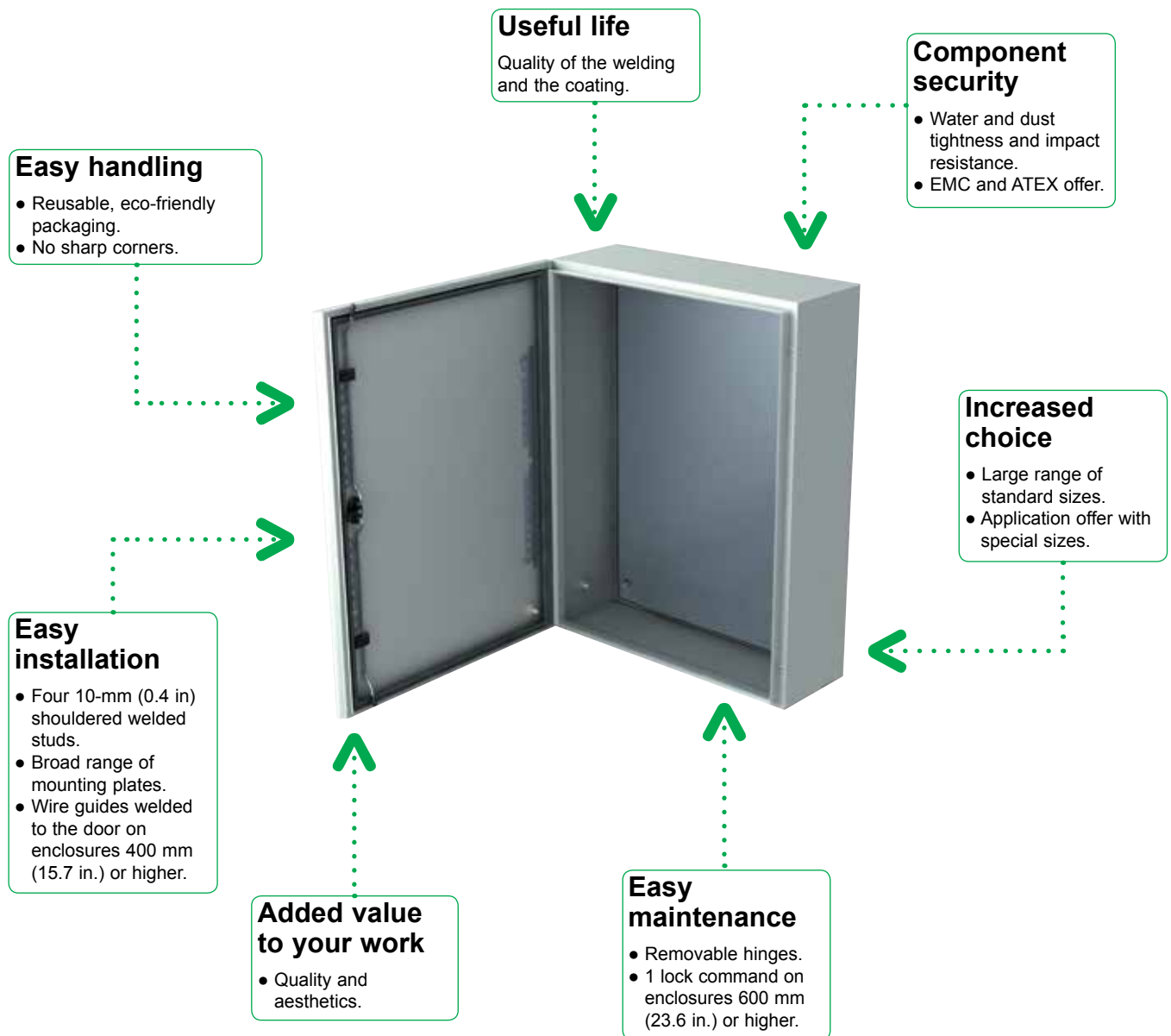



### > Mounting

- ① Wall-mounting
- ② Floor-standing
- ③ Roof
- ④ Viewing and grounding

### > Cable installation and management

- ⑤ Installation
- ⑥ Cable entries
- ⑦ Cable management
- ⑧ Thermal management



3-point lock enclosure.



One action point enclosure.



Welded studs for the ground connection.



Screwdriver lock (coin protected).

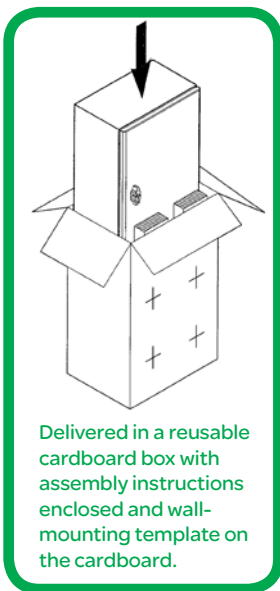

Delivered in a reusable cardboard box with assembly instructions enclosed and wall-mounting template on the cardboard.

### The Spacial S3DC steel enclosure universal offer

- Enclosure with plain door.
- Structured finish, epoxy-polyester powder, RAL 7035 gray color. See the Selection Guide on page 60.

### Technical characteristics

#### Enclosure body

- Single-piece body (cross-shaped structure). Gutter-shaped front profile with double fold. Flat rear.
- 4 (or 6\*\*) M8 × 25 shouldered backstuds for installing mounting plates and step slides, leaving a space of 10 mm (0.4 in.) behind them.
- M6 × 16 grounding studs for equipotential connection between the door and the body of the enclosure.
- Four direct wall-mounting drill holes (∅ 10 mm (0.4 in.)) are sealed with plugs to maintain the degree of protection. Or mount with lugs installed from the outside (lugs ordered separately, see page 66).

#### Enclosure door

- Wall-mounting enclosure supplied with screwdriver insert lock as standard.
- Polyurethane door gasket.
- M6 × 16 grounding studs for equipotential connection between the door and the body of the enclosure.
- Easily removable and reversible, with 20-mm (0.8 in.) return with double thickness for excellent rigidity, opening to 120°, equipped with 2 or 3 invisible hinges\*.
- For heights from 600 mm (23.6 in.), three locking points with linkage, with a single control point. Simple reversal of linkage. Maximum load: 50 kg/m<sup>2</sup>.
- Perforated rails on the door, with pre-drilled holes with a diameter of 4.2 mm (0.2 in.) in steps of 25 mm (1.0 in.):
  - 2 vertical rails from the height of 400 mm (15.7 in.),
  - 2 vertical rails and 2 horizontal rails from the width of 800 mm (31.5 in.).

\* From the height of 800 mm (31.5 in.).

\*\* Widths of 1000 and 1200 mm (39.4 and 47.2 in.).

#### Standards

Compliance with enclosure standards IEC 62208, UL 508A. Environmental testing to UL 50E.

The Spacial S3DC wall-mounting enclosures are compliant with the RoHS directive.

#### Certifications

For certification table, see page 478.



Our certificates can be downloaded from our website.





Our empty enclosures are marked CE according to the Low-Voltage Directive (LVD). It is the responsibility of the final equipment manufacturer to respect the regulations in force.

### Technical characteristics

#### Protection degree

- IP66 for the single-door enclosures and IP55 for the double-door enclosures, according to IEC 60529.
- UL/NEMA rated 4, 4X for the single-door enclosures and 12, 12K, 13 for the double-door enclosures according to UL 50E and NEMA 250.

#### Resistance to external mechanical impacts

- IK10 for the plain-door enclosures, according to IEC 62262.
- IK08 for the glazed-door enclosures.

### Mechanical characteristics

#### Attachment of mounting hardware

- 4 (or 6\*\*) M8 × 25 shouldered backstuds for installing mounting plates and step slides, leaving a space of 10 mm (0.4 in.) behind them.
- \*\* 6 studs for widths 1000 and 1200 mm (39.4 and 47.2 in.).

#### Personnel protection

**Ground connection:** Spacial S3DC steel enclosures are equipped with M6 × 16 grounding studs welded in the body and the door for equipotential connection. Grounding braid ordered separately (see page 303).

**Closing the enclosure:** enclosures of 600 mm (23.6 in.) and higher are equipped with three linked locking points, with a single control point, preventing the enclosures from being left ajar. For locks and inserts see page 72.

#### Coating properties

**Color:** RAL 7035 gray; finish: structured.

**Coating thickness:** 60 µm.

**Fire class:** M0.

**Resistance to corrosion:** compliance with standard IEC 62208 for outdoor installation: 288 h of humid heat and 336 h of salt mist.

**Note:** the Spacial S3DC is specially designed for indoor installations. For outdoor installations, it is advisable to install a canopy or contact us.

**Protection from nuclear contamination (NFT 30901):** RAL 7035 and AFNOR A550 tests available on request.



For further information, see the technical annexes on page 478.



### EMC protection

Standard Spacial S3DC enclosures are tested against electromagnetic disruptions. Since the enclosure is tested empty, it is advisable to rerun the tests with the enclosure equipped in its final configuration.

Grounding braids ordered separately, see page 303.

For another EMC solution and additional information on electromagnetic compatibility, see the Spacial S3HF enclosure, page 342.

### Attenuation curve of the Spacial S3DC compared with the Spacial S3HF

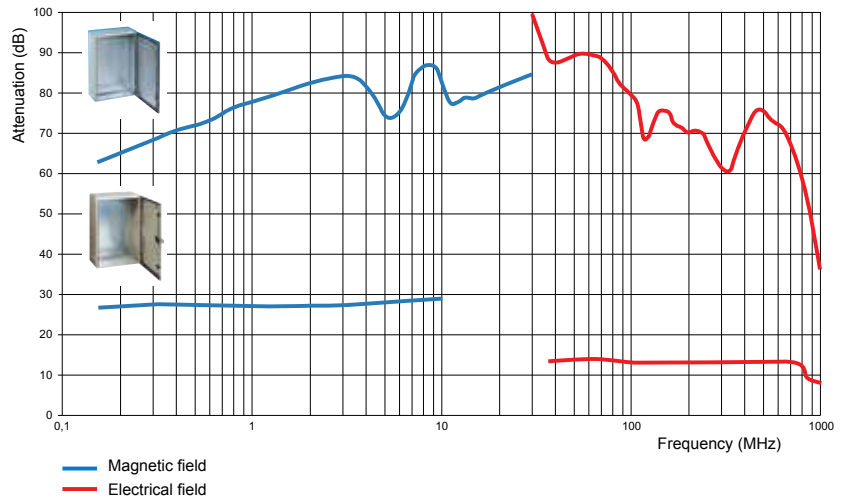

Frequency: 3 - 13.2 Hz  
 Amplitude: 1 mm/sec below 22 Hz  
 Frequency: 3 - 100 Hz  
 Acceleration: 0.7 g above 30 Hz

### Vibration constraints

The Spacial S3DC enclosure is constructed as a single-piece body with a cross-shaped structure. The rear is flat without added parts, allowing it to comply with specific vibration constraints.

The tests were conducted according to the "rules for ships" by "Det Norske Veritas." Enclosures labelled "DNV" have undergone these tests and obtained classification "A." Since the enclosure is tested empty, it is advisable to rerun the tests with the enclosure equipped in its final configuration.



### ATEX compliance

The Spacial S3DC enclosure (with adaptation) is certified ATEX by the LCIE.

### Environmental consideration

Compliance with RoHS standard.

A: Enclosure height  
 B: Enclosure width  
 C: Enclosure depth

- (1) 4 or 6 M8 × 25 mm (1.0 in.) backstuds with widths 1000 to 1200 mm (39.4 to 47.2 in.).
- (2) 2 M6 × 17.5 mm (0.7 in.) grounding studs.
- (3) Stud center-to-center distance.
- (4) Center-to-center distance of the holes for direct mounting.



The DXF diagrams can be downloaded from our website.

### 1-door enclosure

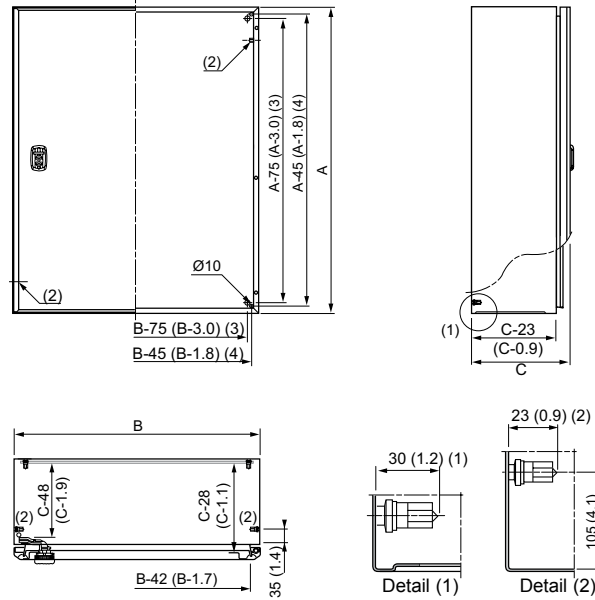

### Perforated rails on plain door

Enclosure (*): mm (in.)		Perforated rails on the door: mm (in.)				Perforated rails on the internal door: mm (in.)			
		Vertical		Horizontal		Vertical		Horizontal	
Height	Width	F	D	E	C	F	D	E	C
400 (15.7)	300 (11.8)	320 (12.6)	237 (9.3)	-	-	-	-	-	-
400 (15.7)	400 (15.7)	320 (12.6)	337 (13.3)	-	-	-	-	-	-
500 (19.7)	400 (15.7)	370 (14.6)	337 (13.3)	-	-	-	-	-	-
500 (19.7)	500 (19.7)	370 (14.6)	437 (17.2)	-	-	-	-	-	-
600 (23.6)	400 (15.7)	370 (14.6)	337 (13.3)	-	-	-	-	-	-
600 (23.6)	600 (23.6)	370 (14.6)	537 (21.1)	-	-	-	-	-	-
700 (27.6)	500 (19.7)	470 (18.5)	437 (17.2)	-	-	-	-	-	-
800 (31.5)	600 (23.6)	570 (22.4)	537 (21.1)	-	-	-	-	-	-
800 (31.5)	800 (31.5)	570 (22.4)	737 (29.0)	620 (24.4)	749 (29.5)	-	-	-	-
1000 (39.4)	600 (23.6)	770 (30.3)	537 (21.1)	420 (16.5)	949 (37.4)	-	-	-	-
1000 (39.4)	800 (31.5)	770 (30.3)	737 (29.0)	620 (24.4)	949 (37.4)	-	-	-	-
1000 (39.4)	1000 (39.4)	770 (30.3)	937 (36.9)	820 (32.3)	949 (37.4)	820 (32.3)	437 (17.2)	320 (12.6)	949 (37.4)
1200 (47.2)	800 (31.5)	970 (38.2)	737 (29.0)	620 (24.4)	1149 (45.2)	-	-	-	-
1200 (47.2)	1000 (39.4)	970 (38.2)	937 (36.9)	820 (32.3)	1149 (45.2)	1020 (40.2)	437 (17.2)	320 (12.6)	1149 (45.2)

(\* ) The doors of enclosures smaller than 800 × 600 mm (31.5 × 23.6 in.) do not have horizontal cable guides.

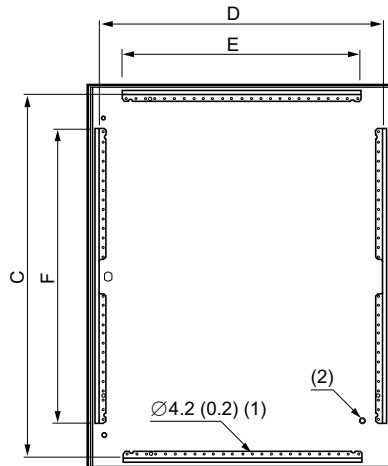

- (1) Perforations in steps of 25 mm (1.0 in.).
- (2) 1 M6 × 17.5 mm (0.7 in.) grounding stud.





Areas without cut-outs, see page 65.



Dimensions (mm and Inches)						Number of doors	IP	Weight of empty enclosures: kg (lbs)	Plain front door		
H (mm)	W (mm)	D (mm)	H (in.)	W (in.)	D (in.)				Without mounting plate	Plain mounting plate painted white	Plain mounting plate galvanized
300	200	150	11.81	7.87	5.91	1	66	2.82 (6.2)	NSYS3DC3215	NSYMM32WH	NSYMM32
300	300	150	11.81	11.81	5.91	1	66	3.18 (7.0)	NSYS3DC3315	NSYMM33WH	NSYMM33
300	300	200	11.81	11.81	7.87	1	66	4.07 (9.0)	NSYS3DC3320	NSYMM33WH	NSYMM33
400	300	150	15.75	11.81	5.91	1	66	4.66 (10.3)	NSYS3DC4315	NSYMM43WH	NSYMM43
400	300	200	15.75	11.81	7.87	1	66	4.57 (10.1)	NSYS3DC4320	NSYMM43WH	NSYMM43
400	400	200	15.75	15.75	7.87	1	66	5.92 (13.1)	NSYS3DC4420	NSYMM44WH	NSYMM44
500	400	200	19.69	15.75	7.87	1	66	8.72 (19.2)	NSYS3DC5420	NSYMM54WH	NSYMM54
500	400	250	19.69	15.75	9.84	1	66	9.62 (21.2)	NSYS3DC5425	NSYMM54WH	NSYMM54
500	500	200	19.69	19.69	7.87	1	66	10.41 (23.0)	NSYS3DC5520	NSYMM55WH	NSYMM55
500	500	250	19.69	19.69	9.84	1	66	11.29 (24.9)	NSYS3DC5525	NSYMM55WH	NSYMM55
600	400	200	23.62	15.75	7.87	1	66	10.11 (22.3)	NSYS3DC6420	NSYMM64WH	NSYMM64
600	400	250	23.62	15.75	9.84	1	66	11.42 (25.2)	NSYS3DC6425	NSYMM64WH	NSYMM64
600	600	200	23.62	23.62	7.87	1	66	13.11 (28.9)	NSYS3DC6620	NSYMM66WH	NSYMM66
600	600	250	23.62	23.62	9.84	1	66	14.11 (31.1)	NSYS3DC6625	NSYMM66WH	NSYMM66
600	600	300	23.62	23.62	11.81	1	66	15.59 (34.4)	NSYS3DC6630	NSYMM66WH	NSYMM66
700	500	250	27.56	19.69	9.84	1	66	14.23 (31.4)	NSYS3DC7525	NSYMM75WH	NSYMM75
800	600	200	31.50	23.62	7.87	1	66	20.11 (44.3)	NSYS3DC8620	NSYMM86WH	NSYMM86
800	600	250	31.50	23.62	9.84	1	66	22.11 (48.7)	NSYS3DC8625	NSYMM86WH	NSYMM86
800	600	300	31.50	23.62	11.81	1	66	23.59 (52.0)	NSYS3DC8630	NSYMM86WH	NSYMM86
800	600	400	31.50	23.62	15.75	1	66	27.59 (60.8)	NSYS3DC8640	NSYMM86WH	NSYMM86
800	800	250	31.50	31.50	9.84	1	66	29.42 (64.9)	NSYS3DC8825	NSYMM88WH	NSYMM88
800	800	300	31.50	31.50	11.81	1	66	31.42 (69.3)	NSYS3DC8830	NSYMM88WH	NSYMM88
1000	600	250	39.37	23.62	9.84	1	66	27.11 (59.8)	NSYS3DC10625	NSYMM106WH	NSYMM106
1000	800	250	39.37	31.50	9.84	1	66	33.84 (74.6)	NSYS3DC10825	NSYMM108WH	NSYMM108
1000	800	300	39.37	31.50	11.81	1	66	36.84 (81.2)	NSYS3DC10830	NSYMM108WH	NSYMM108
1000	800	400	39.37	31.50	15.75	1	66	40.84 (90.0)	NSYS3DC10840	NSYMM108WH	NSYMM108
1000	1000	300	39.37	39.37	11.81	1	66	44.46 (98.0)	NSYS3DC101030	NSYMM1010WH	NSYMM1010
1200	800	300	47.24	31.50	11.81	1	66	43.84 (96.7)	NSYS3DC12830	NSYMM128WH	NSYMM128
1200	800	400	47.24	31.50	15.75	1	66	47.84 (105.5)	NSYS3DC12840	NSYMM128WH	NSYMM128
1200	1000	300	47.24	39.37	11.81	1	66	51.46 (113.4)	NSYS3DC121030	NSYMM1210WH	NSYMM1210

### Installation accessories

	Description	Catalog number
	Set of 4 steel mounting lugs	NSYAEFPFSC
	Set of 4 stainless-steel mounting lugs	NSYAEFPFXSC
	Kit for heavy loads	NSYAEFAHLBSC
	Batch of 2 M8 eyebolts	NSYAELYTCRG8



See also these accessories

Equipment mounting plate  
Page 64

Accessories for mounting plate  
Page 64

Cable-management accessories  
Page 76





Mounting plate					Accessories				
Microperforated mounting plate galvanized	Aluminum upright*	Perforated Telequick**	19" fixed chassis	19" pivoting chassis	Internal door	Adjustable brackets	Door cross rail	Canopy	
NSYMF32	NSYMDVR3	NSYMR32	-	-	-	-	-	NSYTJ2015	
NSYMF33	NSYMDVR3	NSYMR33	-	-	-	-	-	NSYTJ3015	
NSYMF33	NSYMDVR3	NSYMR33	-	-	-	NSYSDCR200	-	NSYTJ3020	
NSYMF43	NSYMDVR4	NSYMR43	-	-	NSYPIN43	-	-	NSYTJ3015	
NSYMF43	NSYMDVR4	NSYMR43	-	-	NSYPIN43	NSYSDCR200	-	NSYTJ3020	
NSYMF44	NSYMDVR4	NSYMR44	-	-	-	NSYSDCR200	NSYTFPCR4	NSYTJ4020	
NSYMF54	NSYMDVR5	NSYMR54	-	-	NSYPIN54	NSYSDCR200	NSYTFPCR4	NSYTJ4020	
NSYMF54	NSYMDVR5	NSYMR54	-	-	NSYPIN54	NSYSDCR250	NSYTFPCR4	NSYTJ4025	
NSYMF55	NSYMDVR5	NSYMR55	-	-	-	NSYSDCR200	NSYTFPCR5	NSYTJ5020	
NSYMF55	NSYMDVR5	NSYMR55	-	-	-	NSYSDCR250	NSYTFPCR5	NSYTJ5025	
NSYMF64	NSYMDVR6	NSYMR64	-	-	NSYPIN64	NSYSDCR200	NSYTFPCR4	NSYTJ4020	
NSYMF64	NSYMDVR6	NSYMR64	-	-	NSYPIN64	NSYSDCR250	NSYTFPCR4	NSYTJ4025	
NSYMF66	NSYMDVR6	NSYMR66	NSYVDM12UF	NSYVDM11UP	-	NSYSDCR200	NSYTFPCR6	NSYTJ6020	
NSYMF66	NSYMDVR6	NSYMR66	NSYVDM12UF	NSYVDM11UP	-	NSYSDCR250	NSYTFPCR6	NSYTJ6025	
NSYMF66	NSYMDVR6	NSYMR66	NSYVDM12UF	NSYVDM11UP	-	NSYSDCR300	NSYTFPCR6	NSYTJ6030	
NSYMF75	NSYMDVR7	NSYMR75	-	-	NSYPIN75	NSYSDCR250	NSYTFPCR5	NSYTJ5025	
NSYMF86	NSYMDVR8	NSYMR86	NSYVDM17UF	NSYVDM16UP	NSYPIN86	NSYSDCR200	NSYTFPCR6	NSYTJ6020	
NSYMF86	NSYMDVR8	NSYMR86	NSYVDM17UF	NSYVDM16UP	NSYPIN86	NSYSDCR250	NSYTFPCR6	NSYTJ6025	
NSYMF86	NSYMDVR8	NSYMR86	NSYVDM17UF	NSYVDM16UP	NSYPIN86	NSYSDCR300	NSYTFPCR6	NSYTJ6030	
NSYMF86	NSYMDVR8	NSYMR86	NSYVDM17UF	NSYVDM16UP	NSYPIN86	NSYSDCR400	NSYTFPCR6	NSYTJ6040	
NSYMF88	NSYMDVR8	NSYMR88	-	-	-	NSYSDCR250	NSYTFPCR8	NSYTJ8025	
NSYMF88	NSYMDVR8	NSYMR88	-	-	-	NSYSDCR300	NSYTFPCR8	NSYTJ8030	
NSYMF106	NSYMDVR10	NSYMR106	NSYVDM21UF	NSYVDM20UP	NSYPIN106	NSYSDCR250	NSYTFPCR6	NSYTJ6025	
NSYMF108	NSYMDVR10	NSYMR108	-	NSYVDM20U8P	NSYPIN108	NSYSDCR250	NSYTFPCR8	NSYTJ8025	
NSYMF108	NSYMDVR10	NSYMR108	-	NSYVDM20U8P	NSYPIN108	NSYSDCR300	NSYTFPCR8	NSYTJ8030	
NSYMF108	NSYMDVR10	NSYMR108	-	NSYVDM20U8P	NSYPIN108	NSYSDCR400	NSYTFPCR8	NSYTJ8040	
NSYMF1010	NSYMDVR10	NSYMR1010	-	-	-	NSYSDCR300	NSYTFPCR10	NSYTJ10030	
NSYMF128	NSYMDVR12	NSYMR128	-	NSYVDM25U8P	NSYPIN128	NSYSDCR300	NSYTFPCR8	NSYTJ8030	
NSYMF128	NSYMDVR12	NSYMR128	-	NSYVDM25U8P	NSYPIN128	NSYSDCR400	NSYTFPCR8	NSYTJ8040	
NSYMF1210	NSYMDVR12	NSYMR1210	-	-	-	NSYSDCR300	NSYTFPCR10	NSYTJ10030	



\*NSYAMCSF mandatory.

\*\*NSYEMR mandatory for enclosure width > 1000.

### Door accessories

	Description	Catalog number
	Steel door retainer for S3DC steel enclosure	NSYAEDRSCST
	Door switch for wall-mounting enclosures	NSYINLCRN
	Grounding lead 160, sec. 6 mm²	NSYEL166D8

### Mounting

	Description	Catalog number
	Mounting for the grounding strip	NSYEDCOS
	Self-tapping screw for microperforated mounting plate	NSYS13M5HS

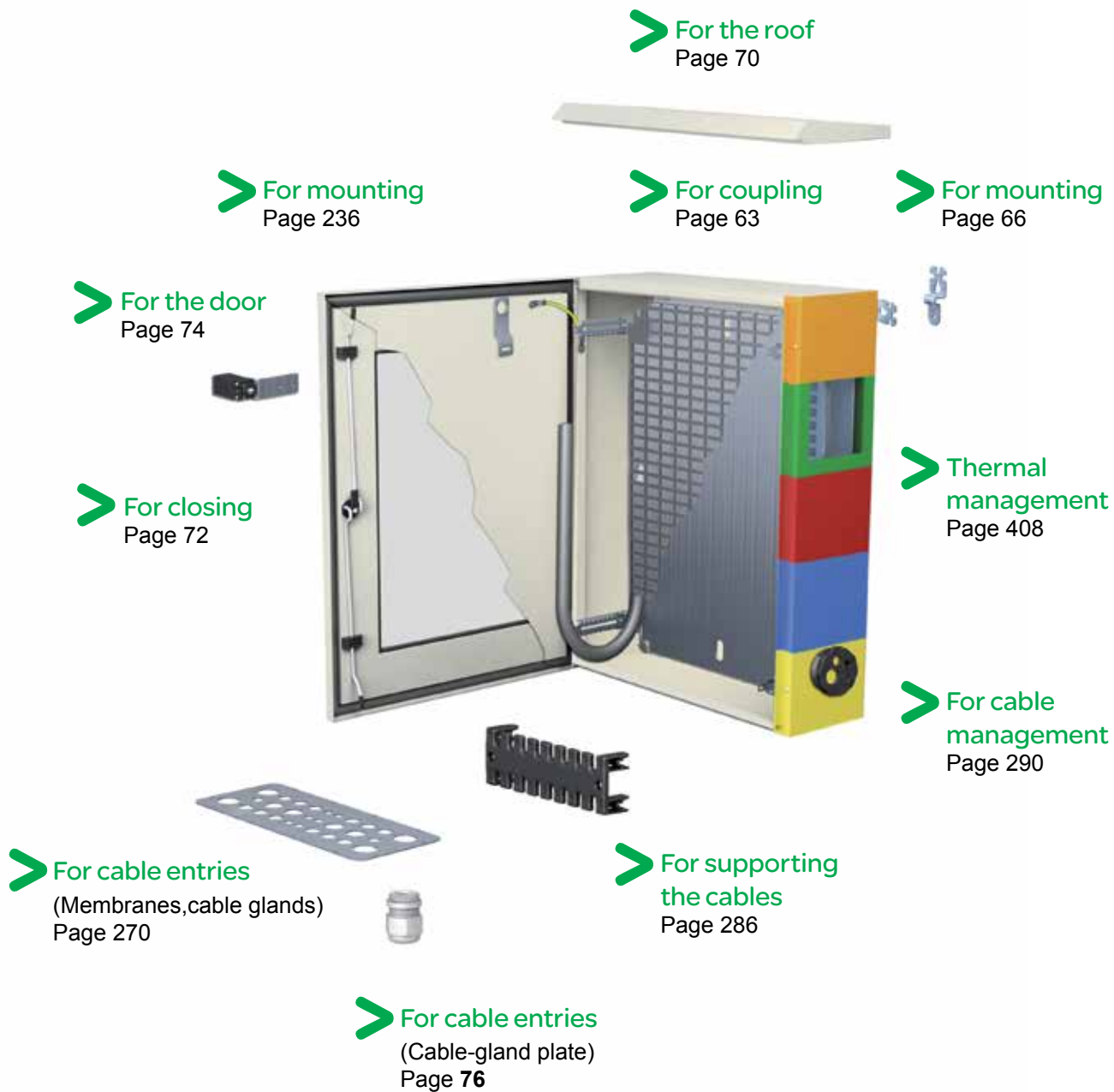

See also  
these accessories

Mounting plate  
Page 236

DIN rail and mountings  
Page 260



Installation example.

### Coupling Spacial steel enclosures

Available in 2 versions:

- Version without cable entry.
- Version with a coupling frame allowing the entry of cables.
- Separation of 17 mm (0.7 in.) between 2 coupled enclosures, allowing full opening of the doors.

### Kit for mounting 2 joined enclosures

- The kit consists of 4 spacers and hardware.

### Coupling frame

- Allows lateral coupling of 2 enclosures.
- The frame is made of polyester charged with self-extinguishing fiberglass.
- A built-in sealing gasket helps ensure the IP66 degree of protection.
- Mounting by screws, included.
- Dimensions: 435 × 185 mm (17.1 × 7.3 in.) and 635 × 185 mm (25.0 × 7.3 in.).
- These frames allow the door to open to 120°.

Description	Catalog number
Batch of 4 coupling spacers	<b>NSYAEUBUSC</b>
Coupling frame, 435 × 185 mm (17.1 × 7.3 in.)	<b>NSYAEUBU41SC</b>
Coupling frame, 635 × 185 mm (25.0 × 7.3 in.)	<b>NSYAEUBU61SC</b>



Version without cable entry.

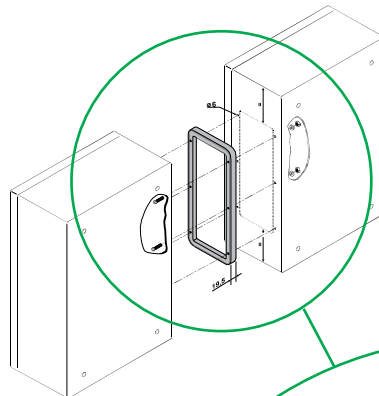

Version with cable entry.

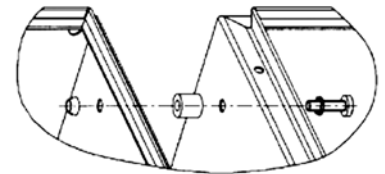

Version without cable entry.



Version with cable entry.

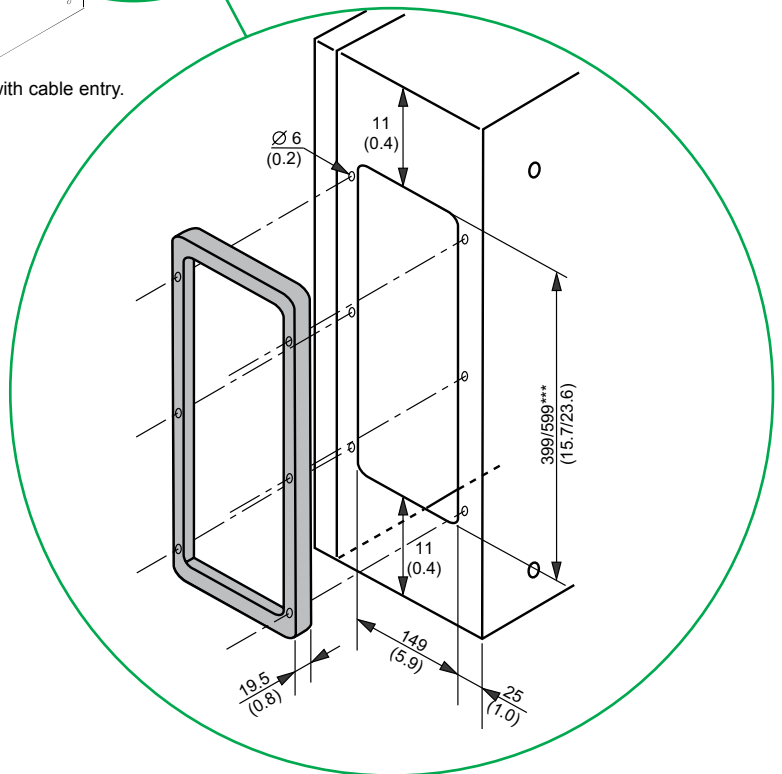

# Accessories

## Telequick mounting plates

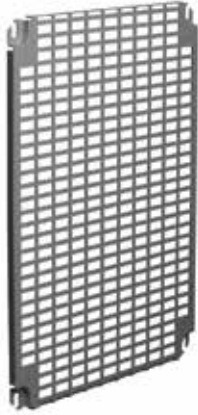

### Installation of Telequick mounting plates

Spacers for raising the mounting plate in the enclosures equipped with 6 studs (enclosure widths  $\geq 1000$  mm [39.4 in]).

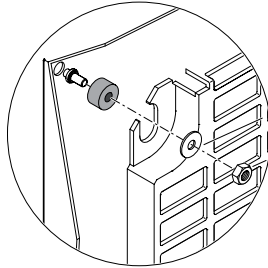

Catalog number  
NSYEMR



### Advantages of Telequick mounting solution

- No more drawing on the mounting plate.
- No more machining of the mounting plate.

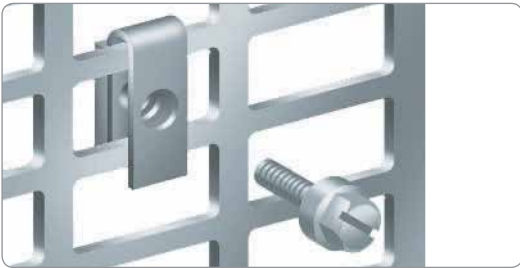

**Direct mounting of equipment on nuts.**



**Mount your cable duct easily.**



**Accessories designed for cable management.**



**Allows accessories to be clipped on.**



# Accessories

## Telequick mounting plates



### Acceptable loads on the mounting plates, bases and doors

Acceptable loads: kg (lbs)					Catalog number
On plain mounting plates	On base	On door (1)	On vertical lug	On horizontal lug	
<b>Spacial S3DC wall-mounting enclosures</b>					
60 (132.3)	135 (297.6)	50 (110.2)	350 (771.6)	190 (418.9)	NSYS3D3215 to NSYS3D5320
90 (198.4)	135 (297.6)	50 (110.2)	350 (771.6)	190 (418.9)	NSYS3D5420 to NSYS3D6425
135 (297.6)	135 (297.6)	50 (110.2)	350 (771.6)	190 (418.9)	NSYS3D6620 to NSYS3D8630
150 (330.7)	135 (297.6)	50 (110.2)	350 (771.6)	190 (418.9)	NSYS3D10625 to NSYS3D10830
180 (396.8)	135 (297.6)	50 (110.2)	350 (771.6)	190 (418.9)	NSYS3D101030D to NSYS3D141030D

(1) On a sheet door with a thickness of 20/10 mm (0.8/0.4 in.), maximum acceptable load is 60 kg (132.3 lbs). Please contact us.

### Areas without cut-outs

- A: Enclosure height
- B: Enclosure width
- C: Enclosure depth

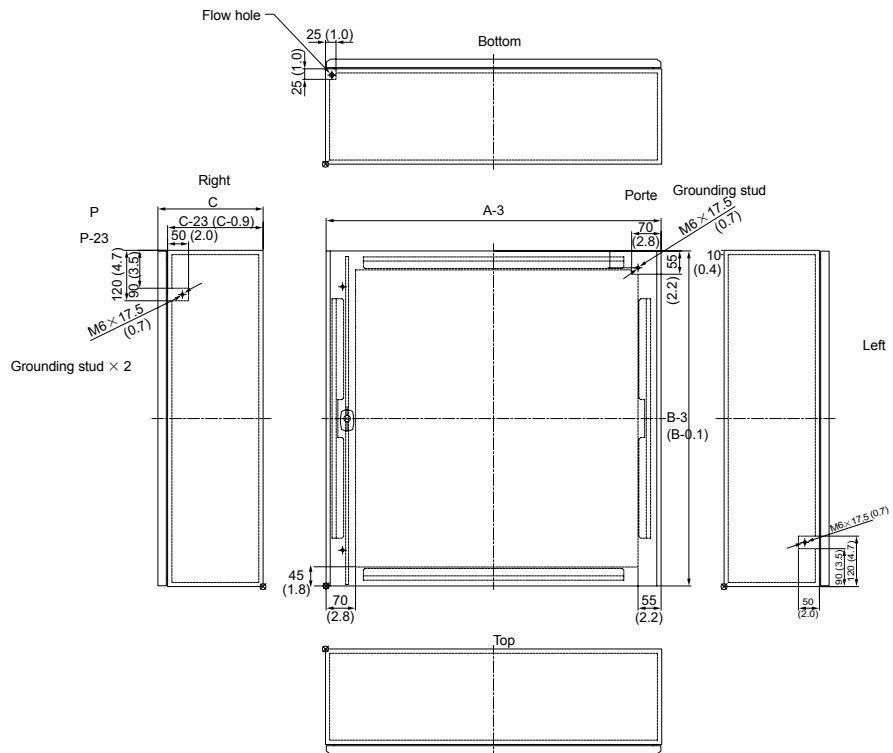

Vertical cable guides from 400-mm (15.7 in.) height. Horizontal cable guides from 800-mm (31.5 in.) width.

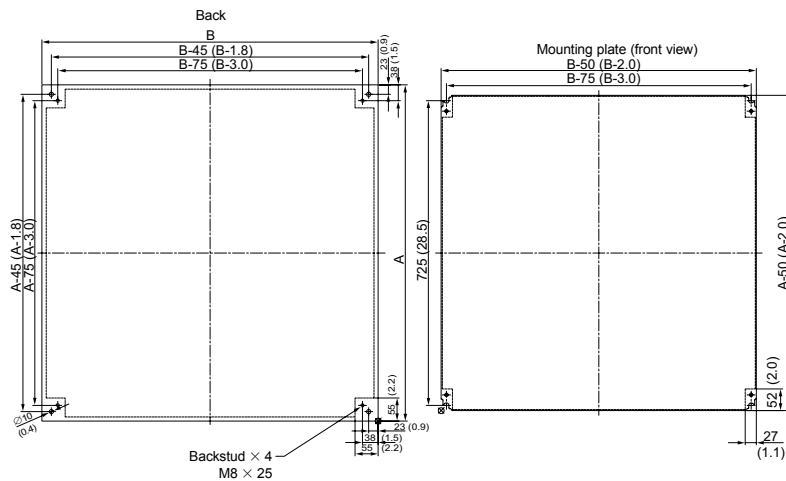

Download our DXF diagrams from our website.

# Accessories

## Mounting accessories

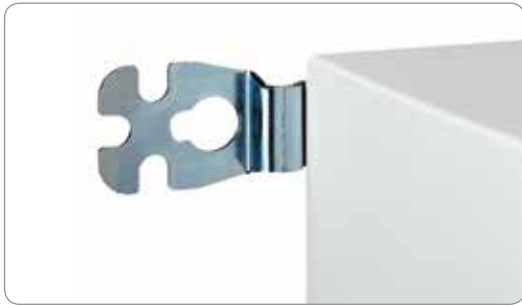

### Wall-mounting lugs

Set of 4 wall-mounting lugs

- Mounted directly on the rear of the enclosure, either in horizontal or vertical position.
- Available in two materials, steel and 304L stainless steel. Can be mounted in two positions, vertical or horizontal, for a wall enclosure separation of 10 mm (0.4 in.).
- Acceptable load:
  - Horizontal lug: 180 kg (396.8 lbs).
  - Vertical lug: 350 kg (771.6 lbs).
- Supplied with mounting screws and pre-mounted sealing gaskets.

Description	Catalog number
Set of 4 steel mounting lugs	<b>NSYAEFPFSC</b>
Set of 4 stainless-steel mounting lugs	<b>NSYAEFPFXSC</b>

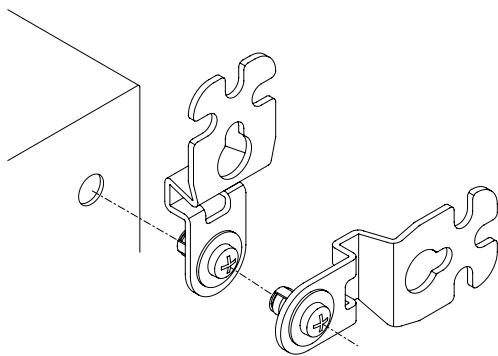

Installation from the outside.

### Mounting center-to-center distance with lugs (M8 screw)

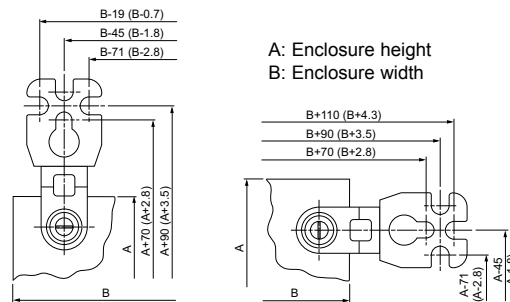

Vertical position.

Horizontal position.

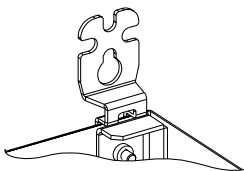

### Kit for heavy loads

Kit made up of 2 steel reinforcement pieces.

- Maximum load: 400 kg (881.8 lbs).
- To be mounted before installing the mounting plate in top position with the standard lugs (ordered separately).

Description	Catalog number
Kit for heavy loads	<b>NSYAEFAHLBSC</b>

# Accessories

## Mounting accessories



### Full-width mounting lugs

- Kit consists of 2 parts (top and bottom).
- Made from passivated zinc-coated steel.
- Mounted with screws from the inside.
- Permissible load: 350 kg (771.6 lbs).

Width: mm (in.)	Catalog number
200 (7.9)	NSYAEFPFS3DW20
300 (11.8)	NSYAEFPFS3DW30
400 (15.7)	NSYAEFPFS3DW40
500 (19.7)	NSYAEFPFS3DW50
600 (23.6)	NSYAEFPFS3DW60
800 (31.5)	NSYAEFPFS3DW80
1000 (39.4)	NSYAEFPFS3DW100

### Dimensions and cut-outs

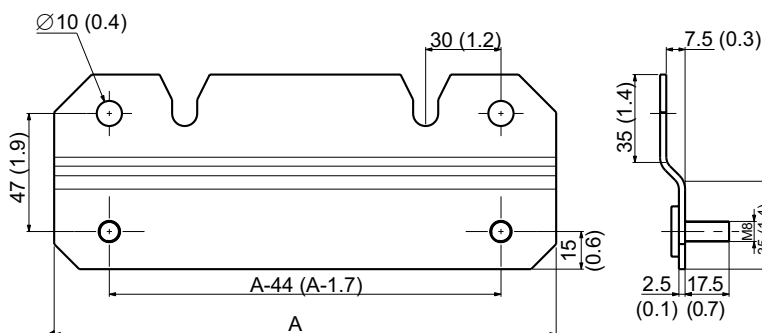

A: width of enclosure

# Accessories

## Mounting accessories



### Post-mounting device for Spacial steel enclosure

For indoor installations on posts with a maximum circumference of 675 mm (26.6 in.) [min. diameter 150 mm (5.9 in.) and max. diameter 215 mm (8.5 in.).

- Material: galvanized steel.
- Rail fixed to the inserts in the rear of the enclosure with 8-mm (0.3 in.) screws.
- Maximum load: 100 kg (220.5 lbs).
- They allow the mounting of protection canopies.
- For steel enclosures with widths of 300, 400, 500, 600 and 800 mm (11.8, 15.7, 19.7, 23.6 and 31.5 in.).

Description	A: mm (in.)	Catalog number
Post-mounting for enclosure with W 300 mm (11.8 in.)	295 (11.6)	<b>NSYSFPSC30</b>
Post-mounting for enclosure with W 400 mm (15.7 in.)	395 (15.6)	<b>NSYSFPSC40</b>
Post-mounting for enclosure with W 500 mm (19.7 in.)	495 (19.5)	<b>NSYSFPSC50</b>
Post-mounting for enclosure with W 600 mm (23.6 in.)	595 (23.4)	<b>NSYSFPSC60</b>
Post-mounting for enclosure with W 800 mm (31.5 in.)	795 (31.3)	<b>NSYSFPSC80</b>

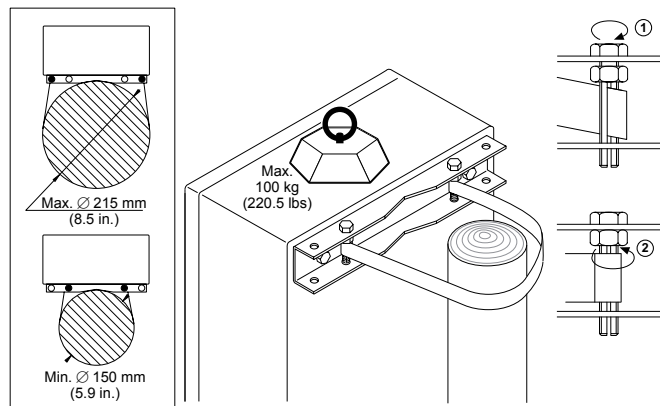
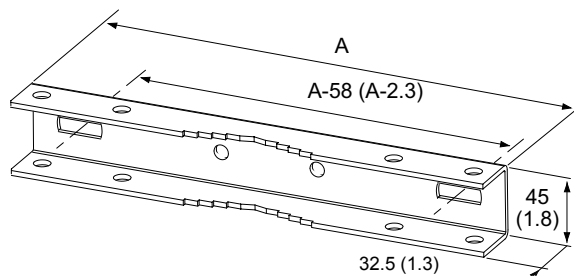

# Accessories

## Mounting accessories



### Floor stand kit for wall-mounting enclosure

- Set of 2 legs, for elevation of wall-mounting enclosures.
- Mounting holes that match the holes of the existing structure.
- Made of galvanized steel: thickness 2.5 mm (0.09 in.) for sides and 3 mm (0.11 in) for the base.
- Coating: RAL 7035 gray polyester powder finish.
- Maximum load: 1300 kg (2866.0 lbs).



Supply: 2 platform legs (right and left) and mounting hardware.

Enclosure depth		Legs height		Catalog number
mm	inches	mm	inches	
300	11.8	300	11.8	<b>NSYW MK33</b>
400	15.7	300	11.8	<b>NSYW MK43</b>
300	11.8	450	17.7	<b>NSYW MK34</b>
400	15.7	450	17.7	<b>NSYW MK44</b>



# Accessories

## Hoisting accessories



### Eyebolts

Set of two M8 eyebolts.

- Material: zinc-coated molded steel.
- The eyebolts are mounted directly to the body of the enclosure.
- Maximum load: 210 kg (463.0 lbs) per enclosure with the sling at 60°.
- Cannot be installed with the canopy in place.
- The reinforcing brackets are attached to the rings.
- The reinforcing brackets also act as a drilling template.

Description	Catalog number
Batch of 2 M8 eyebolts	<b>NSYAELYTCRG8</b>

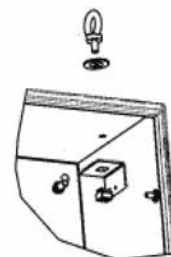

# Accessories

## Hoisting accessories

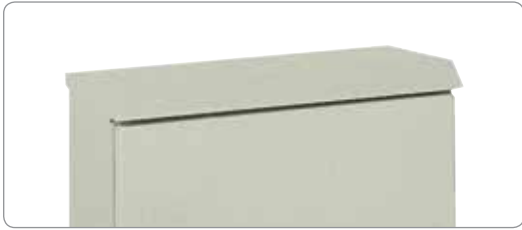

### Protection canopy

Direct mounting to the body of the enclosure by 4 M6 screws.

- Material: painted galvanized steel, structured finish, epoxy-polyester powder, RAL 7035 gray color.
- Delivered with installation hardware.
- To be used for all outdoor installations.

Enclosures: mm (in.)					Catalog number
Width	Depth	F	G	H	
200 (7.9)	150 (5.9)	36 (1.4)	75 (3.0)	23 (0.9)	NSYTJ2015
250 (9.8)	150 (5.9)	36 (1.4)	75 (3.0)	23 (0.9)	NSYTJ2515
300 (11.8)	150 (5.9)	36 (1.4)	75 (3.0)	23 (0.9)	NSYTJ3015
400 (15.7)	150 (5.9)	36 (1.4)	75 (3.0)	23 (0.9)	NSYTJ4015
500 (19.7)	150 (5.9)	36 (1.4)	75 (3.0)	23 (0.9)	NSYTJ5015
500 (19.7)	200 (7.9)	36 (1.4)	130 (5.1)	23 (0.9)	NSYTJ5020
600 (23.6)	200 (7.9)	36 (1.4)	130 (5.1)	23 (0.9)	NSYTJ6020
250 (9.8)	200 (7.9)	36 (1.4)	130 (5.1)	23 (0.9)	NSYTJ2520
300 (11.8)	200 (7.9)	36 (1.4)	130 (5.1)	23 (0.9)	NSYTJ3020
400 (15.7)	200 (7.9)	36 (1.4)	130 (5.1)	23 (0.9)	NSYTJ4020
800 (31.5)	200 (7.9)	36 (1.4)	130 (5.1)	23 (0.9)	NSYTJ8020
400 (15.7)	250 (9.8)	42 (1.7)	150 (5.9)	48 (1.9)	NSYTJ4025
500 (19.7)	250 (9.8)	42 (1.7)	150 (5.9)	48 (1.9)	NSYTJ5025
600 (23.6)	250 (9.8)	42 (1.7)	150 (5.9)	48 (1.9)	NSYTJ6025
800 (31.5)	250 (9.8)	42 (1.7)	150 (5.9)	48 (1.9)	NSYTJ8025
600 (23.6)	300 (11.8)	42 (1.7)	200 (7.9)	48 (1.9)	NSYTJ6030
800 (31.5)	300 (11.8)	42 (1.7)	200 (7.9)	48 (1.9)	NSYTJ8030
1000 (39.4)	300 (11.8)	42 (1.7)	200 (7.9)	48 (1.9)	NSYTJ10030
1200 (47.2)	300 (11.8)	42 (1.7)	200 (7.9)	48 (1.9)	NSYTJ12030
600 (23.6)	400 (15.7)	42 (1.7)	300 (11.8)	48 (1.9)	NSYTJ6040
800 (31.5)	400 (15.7)	42 (1.7)	300 (11.8)	48 (1.9)	NSYTJ8040
1000 (39.4)	400 (15.7)	42 (1.7)	300 (11.8)	48 (1.9)	NSYTJ10040
1200 (47.2)	400 (15.7)	42 (1.7)	300 (11.8)	48 (1.9)	NSYTJ12040

### Dimensions and cut-outs

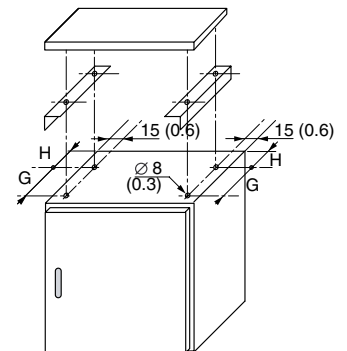
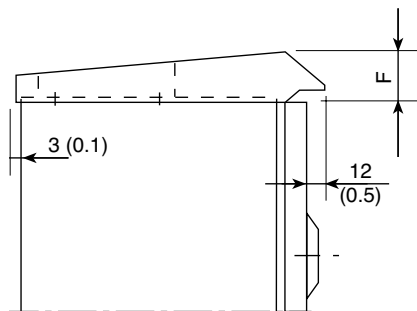

# Accessories

## Locking accessories



### Standard locks

Spacial S3DC wall-mounting enclosures are supplied with a screwdriver insert (coin protected) lock as standard.

- Large range of standardized inserts covering the most common needs.
- Installation and removal with a single screw.

Description	Catalog number of form insert*
6-mm (0.2 in.) square	NSYAEDLS6S3D
7-mm (0.3 in.) square	NSYAEDLS7S3D
8-mm (0.3 in.) square	NSYAEDLS8S3D
3-mm (0.1 in.) double bar	NSYAEDLB3S3D
5-mm (0.2 in.) double bar	NSYAEDLB5S3D
CNOMO 6.5-mm (0.3 in.) triangular	NSYAEDLT6S3D
8-mm (0.3 in.) triangular	NSYAEDLT8S3D

\* Delivered with 1 plastic key.



### Standard handles with keys

Attractive and ergonomic bi-material handle.

- Large range of barrels covering the most common needs.
- Standard cam (see diagram above).
- The installation of the standard handle does not require the escutcheon to be removed.

Description	Catalog number of handle with keys*
1242	NSYAEDL1242S3D
405	NSYAEDL405S3D
421	NSYAEDL421S3D
455	NSYAEDL455S3D
2331A	NSYAEDL2331S3D
2433A	NSYAEDL2433S3D
3113A	NSYAEDL3113S3D

\* Delivered with 2 keys.



### Lock with screwdriver insert and metal latch

Catalog number

NSYAEDLSDS3D



### Handle lock operated using screwdriver insert

Catalog number

NSYTSMLS3D



# Accessories

## Locking accessories



### Double lock

- Easy mounting in place of the standard lock.
  - Material: zamack.
- Delivered with 3-mm (0.1 in.) double-bar metal key.

Description	Catalog number
DIN half-cylinder (1)	<b>NSYAEDLDINS3D</b>
Padlockable 405 (2)	<b>NSYAEDLPADS3D</b>

(1) Delivered without barrel. Please contact us.  
 (2) Diameter 8 mm (0.3 in.).

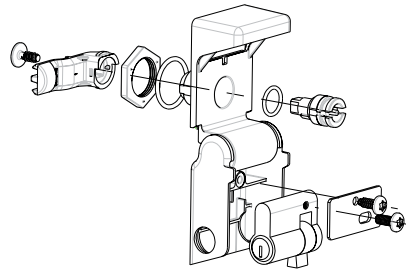

### Locks with keys

- Easy mounting in place of the standard lock.
- Metal cam supplied.

EDF lock	Catalog number
EDF 900	<b>NSYAEDLEDF9S3D</b>
EDF 1300	<b>NSYAEDLEDF13S3D</b>
EDF 1400	<b>NSYAEDLEDF14S3D</b>



180° hinge.

### Door hinges

- Two models:
- For opening the door to an angle of 180°.
  - Spare standard hinges (120°).
  - Captive pin, indexed by a spring.
  - Batch of 1 hinge, delivered with hardware.
  - Material: zamack body for catalog number **NSYAEDH180S3D**, treated sheet-steel body for catalog number **NSYAEDH120S3D**, aluminum pin.
  - For the 180° hinge, the maximum allowable load on the door is 20 kg / m<sup>2</sup>.
  - For the 120° hinge, the maximum allowable load on the door is 50 kg / m<sup>2</sup>.

Description	Catalog number
180° hinge for S3DC enclosure	<b>NSYAEDH180S3D</b>
Standard 120° hinge for S3DC	<b>NSYAEDH120S3D</b>



120° hinge.

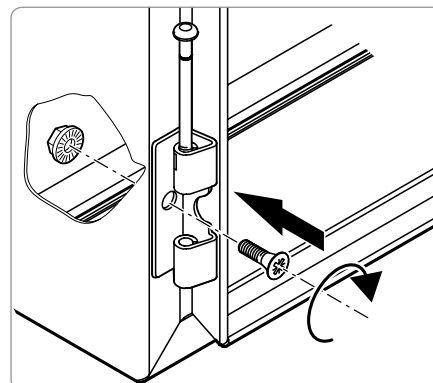

# Accessories

## Doors



### Inner door

- Sheet-steel door, RAL 7035 gray color.
- Locking with 3-mm (0.1 in.) double-bar lock.
- Maximum load, 30 kg/m<sup>2</sup>.
- The inner door can be installed directly on the front face of the enclosure or on the step slides (not supplied as standard).
- It is possible to mount an internal door and a mounting plate together on the step slides with the standard supply.
- Incompatible with the installation of the door stop and door switch. For further details, please contact us.
- All doors with a height > 700 mm (27.6 in.) are equipped with welded vertical profiles in order to facilitate cable management. Those profiles allows the mounting of our standard door cross rail.

### Dimensions

Installation on the front of the enclosure (A) or installation on step slides (B).

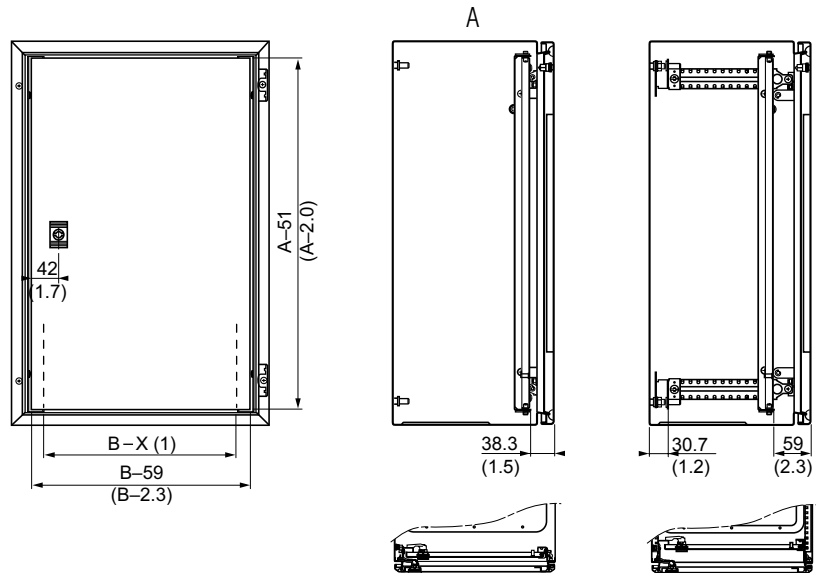

- (1) Dimension resulting from installation on step slides: B-83 mm (B-3.3 in.).  
 Dimension resulting from direct installation (without step slides): B-91 mm (B-3.6 in.).

# Accessories

## Door accessories



### Steel door retainer

For blocking the door at the end of its travel.

- It is installed on enclosures with heights from 400 mm (15.7 in.) and widths from 300 mm (11.8 in.).
- Connection for grounding the enclosure on the reinforcement rail.
- Grounding accessories supplied with the enclosure (ground-connection wire to be ordered separately), see page 303.
- Please note: cannot be installed on 19" mounting plates or on enclosures equipped with an internal door.

Description	Catalog number
Steel door retainer for Spacial wall-mounting steel enclosure	<b>NSYAEDRSCST</b>



### Door-holding system

To hold the door open while working on the enclosure.

- It is installed on the perforated rails of the enclosure doors at the required height.
- Material: polyamide 6 (PA6).
- It can be mounted on enclosures with a height > 400 mm (15.7 in.) [no door cross rail on heights < 400 mm (15.7 in.)].
- It cannot be installed in the Spacial CRN enclosures.

Description	Catalog number
Door-holding system for Spacial S3DC wall-mounting steel enclosure	<b>NSYAEDRS3DPA6</b>

# Cable management

## Cable entries



### Standard cable-gland plate

Made from self-extinguishing ABS with 30% fiberglass material. Color RAL 7035.

- Pre-marked holes with diameter Pg for coupling cable glands, membrane glands, tubes, etc.
- With a polyurethane sealing gasket.
- Excellent thermal resistance.
- Pre-marked holes for cable glands.

Catalog number	Fig.
NSYTSACRNA	1
NSYTSACRNB	2
NSYTSACRNB	3
NSYTSACRNC	3
NSYTSACRND	4
NSYTSACRNC	3



Example of use.

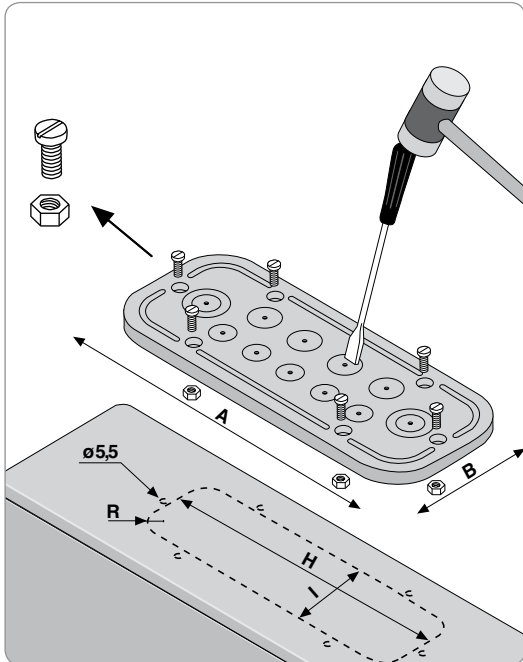

Fig. 1

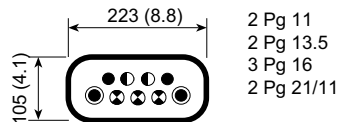

Fig. 2

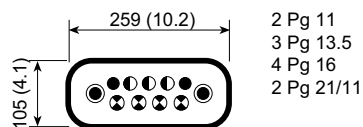

Fig. 3

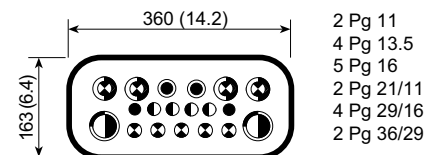
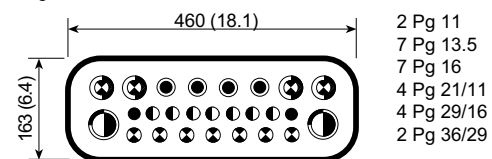

Fig. 4



- Pg 11: 18.6 mm (0.7 in)
- ◐ Pg 13.5: 20.4 mm (0.8 in)
- ⊗ Pg 16: 22.5 mm (0.9 in)
- ⊙ Pg 21/11: 28.3/18.6 mm (1.1/0.7 in)
- ⊗ Pg 29/16: 37/22.5 mm (1.5/0.9 in)
- ◐ Pg 36/29: 47/37 mm (1.9/1.5 in)

### Possibility of mounting cable-gland plates on Spacial S3DC enclosures

Enclosure catalog number	Height: mm (in.)	Width: mm (in.)	Depth: mm (in.)	NSYTSACRNA	NSYTSACRNB	NSYTSACRNC	NSYTSACRND
NSYS3DC3215	300 (11.8)	200 (7.9)	150 (5.9)	–	–	–	–
NSYS3DC3315	300 (11.8)	300 (11.8)	150 (5.9)	•	•	–	–
NSYS3DC3320	300 (11.8)	300 (11.8)	200 (7.9)	•	•	–	–
NSYS3DC4315	400 (15.7)	300 (11.8)	150 (5.9)	•	•	–	–
NSYS3DC4320	400 (15.7)	300 (11.8)	200 (7.9)	•	•	–	–
NSYS3DC4420	400 (15.7)	400 (15.7)	200 (7.9)	•	•	•	–
NSYS3DC5420	500 (19.7)	400 (15.7)	200 (7.9)	•	•	•	–
NSYS3DC5425	500 (19.7)	400 (15.7)	250 (9.8)	•	•	•	–
NSYS3DC5520	500 (19.7)	500 (19.7)	200 (7.9)	•	•	•	•
NSYS3DC5525	500 (19.7)	500 (19.7)	250 (9.8)	•	•	•	•
NSYS3DC6420	600 (23.6)	400 (15.7)	200 (7.9)	•	•	•	–
NSYS3DC6425	600 (23.6)	400 (15.7)	250 (9.8)	•	•	•	–
NSYS3DC6620	600 (23.6)	600 (23.6)	200 (7.9)	•	•	•	•
NSYS3DC6625	600 (23.6)	600 (23.6)	250 (9.8)	•	•	•	•
NSYS3DC6630	600 (23.6)	600 (23.6)	300 (11.8)	•	•	•	•
NSYS3DC7525	700 (27.6)	500 (19.7)	250 (9.8)	•	•	•	•
NSYS3DC8620	800 (31.5)	600 (23.6)	200 (7.9)	•	•	•	•
NSYS3DC8625	800 (31.5)	600 (23.6)	250 (9.8)	•	•	•	•
NSYS3DC8630	800 (31.5)	600 (23.6)	300 (11.8)	•	•	•	•
NSYS3DC8640	800 (31.5)	600 (23.6)	400 (15.7)	•	•	•	•
NSYS3DC8825	800 (31.5)	800 (31.5)	250 (9.8)	•	•	•	•
NSYS3DC8830	800 (31.5)	800 (31.5)	300 (11.8)	•	•	•	•
NSYS3DC10625	1000 (39.4)	600 (23.6)	250 (9.8)	•	•	•	•
NSYS3DC10825	1000 (39.4)	800 (31.5)	250 (9.8)	•	•	•	•
NSYS3DC10830	1000 (39.4)	800 (31.5)	300 (11.8)	•	•	•	•
NSYS3DC10840	1000 (39.4)	800 (31.5)	400 (15.7)	•	•	•	•
NSYS3DC101030	1000 (39.4)	1000 (39.4)	300 (11.8)	•	•	•	•
NSYS3DC12830	1200 (47.2)	800 (31.5)	300 (11.8)	•	•	•	•
NSYS3DC12840	1200 (47.2)	800 (31.5)	400 (15.7)	•	•	•	•
NSYS3DC121030	1200 (47.2)	1000 (39.4)	300 (11.8)	•	•	•	•

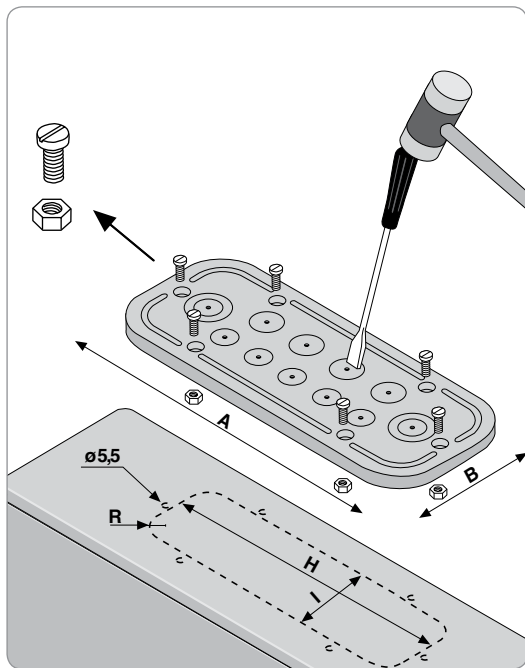

Mounting scheme for steel Spacial S3DC enclosures.

**Dimensions of cable-gland plate: mm (in.)**

- NSYTSACRNA: 223 × 105 (8.8 × 4.1 in.)
- NSYTSACRNB: 259 × 105 (10.2 × 4.1 in.)
- NSYTSACRNC: 360 × 163 (14.2 × 6.4 in.)
- NSYTSACRND: 460 × 163 (18.1 × 6.4 in.)

Max.: mm (in.)				
A	B	H	I	R
223 (8.8)	105 (4.1)	180 (7.1)	62 (2.4)	18 (0.7)
259 (10.2)	105 (4.1)	216 (8.5)	62 (2.4)	18 (0.7)
360 (14.2)	163 (6.4)	317 (12.5)	120 (4.7)	32 (1.3)
460 (18.1)	163 (6.4)	417 (16.4)	120 (4.7)	32 (1.3)

# Disconnect enclosures

## Overview

### S3DCD Disconnect enclosure

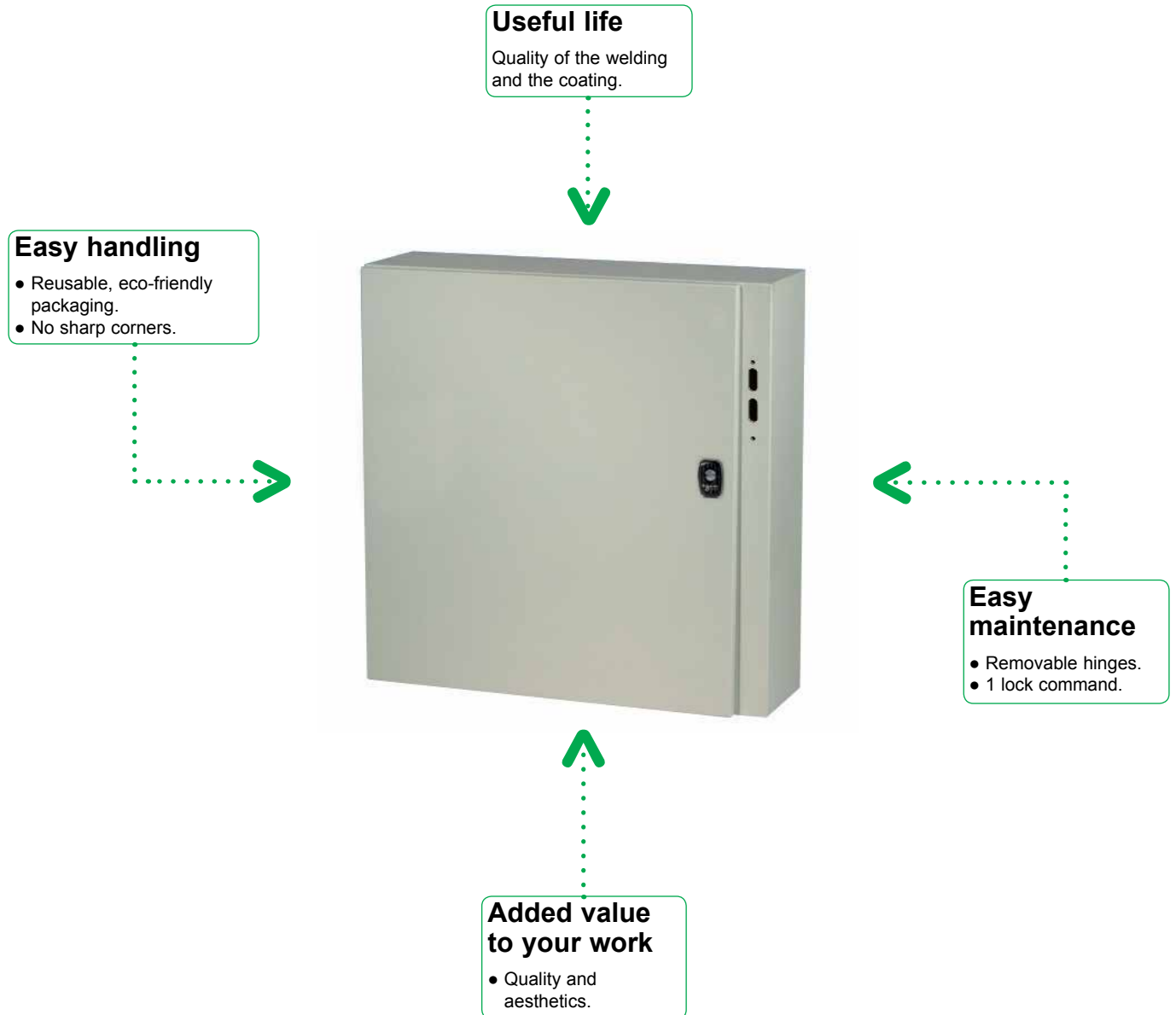

# Disconnect enclosures

## Overview



### Application

- Designed to house the following enclosure disconnect equipment:
- **Square D®** class 9422 disconnect switches with flange-mounted variable depth operating mechanisms or cable mechanisms and Class 9422 flange-mounted variable depth operating mechanisms or cable mechanisms for circuit breakers. Will not accept Square D Class 9422 bracket-mounted disconnect devices, 9422TG1 or TG2 devices (contact us).
- **ABB Controls** flange-mounted variable depth operating mechanism for disconnect switches and circuit breakers.
- **Allen Bradley** 1494V variable depth flange-mounted disconnect switches and circuit breaker operators. Will not accept Allen Bradley 1494F disconnect switches, 1494D circuit breaker operators.
- **C-H Westinghouse** C361 flange-mounted variable depth operating mechanism with disconnect switches and C371 flange-mounted variable depth operating mechanisms for circuit breakers. Also Flex-Shaft handle mechanisms for circuit breakers.
- **General Electric** Type STDA flange handles and variable depth operating mechanism for disconnect switches and circuit breakers. Also Spectra-Flex cable operators for circuit breakers.
- **I-T-E Max-Flex** flange-mounted variable depth handles for disconnect switches and circuit breakers.



### Ordering

The disconnect switch, operating handle, and operating mechanism must be ordered from the disconnect equipment supplier.

# Disconnect enclosures

## Characteristics



### S3DCD disconnect enclosure: our wall-mounting circuit breaker interlocking enclosure

- Three-point lock enclosure with plain door.
- Structured finish, epoxy-polyester powder, RAL 7035 gray color.
- IP66 for the single-door enclosures, according to IEC 60529.
- UL/NEMA rated 4, 4X for the single-door enclosures according to NEMA 250 and UL 50E.
- IK10 for the plain-door enclosures, according to IEC 62262.

### Technical characteristics

#### Enclosure body

- Single-piece body (cross-shaped structure). Gutter-shaped front profile with double fold. Flat rear.
- 4 (or 6\*\*) M8 × 25 shouldered backstuds for installing mounting plates and step slides, leaving a space of 10 mm (0.4 in.) behind them.
- M6 × 16 grounding screws for equipotential connection between the door and the body of the enclosure.
- Four direct wall-mounting drill holes [∅ 10 mm (0.4 in.)] are sealed with plugs to maintain the degree of protection. Or mount with lugs installed from the outside (lugs ordered separately, see page 82).

#### Enclosure door

- Wall-mounting enclosure supplied with screwdriver insert lock as standard. Polyurethane door gasket.
- M6 × 16 grounding screws for equipotential connection between the door and the body of the enclosure.
- Easily removable, with 20-mm (0.8 in.) return with double thickness for excellent rigidity, opening to 120°, equipped with 2 or 3 invisible hinges\*.
- Door opening to 180° with optional hinges (page 73).
- For heights from 600 mm (23.6 in.), three linked locking points with a single control point. Maximum load: 50 kg/m<sup>2</sup>.
- Perforated rails on the door, with drill holes with a diameter of 4.2 mm (0.2 in.) in steps of 25 mm (1.0 in.):
  - 1 vertical rail from the height of 500 mm (19.7 in.) on the side with the hinges.
  - 1 vertical rail and 2 horizontal rails from the width of 800 mm (31.5 in.).
  - Load on door, see page 65.

#### Standards

Compliance with enclosure standards IEC 62208 and UL 508A. Environmental testing to UL 50E.

The Spacial S3DCD wall-mounting enclosures are compliant with the RoHS directive.



# Disconnect enclosures

## Dimensions

A: Enclosure height  
 B: Enclosure width  
 C: Enclosure depth

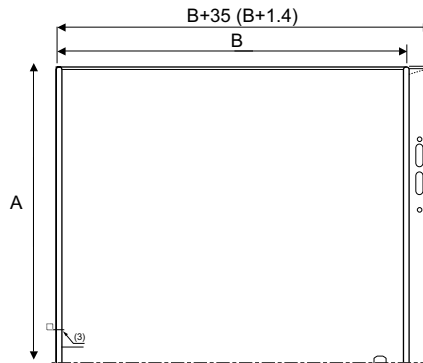

(1) 4 or 6 M8 × 25 mm (1.0 in.) backstuds with widths 1000 to 1200 mm (39.4 to 47.2 in.).  
 (2) 2 M6 × 17.5 mm (0.7 in.) grounding studs.

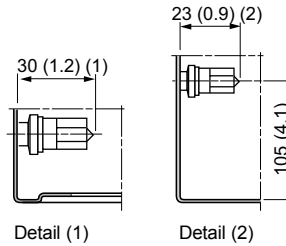
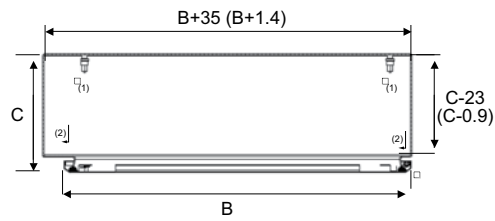

(3) Perforations in steps of 25 mm (1.0 in.).  
 (4) 1 M6 × 17.5 mm (0.7 in.) grounding stud.

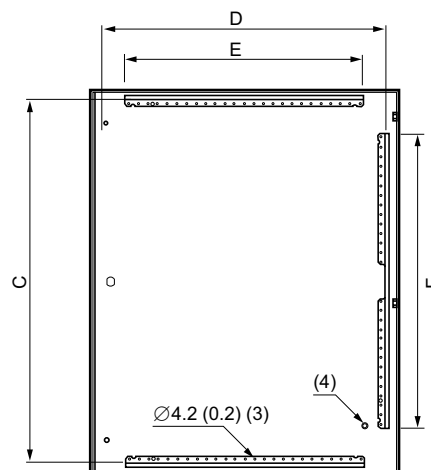

Ø1 vertical rail beginning with height 500 mm (19.7 in.).  
 Ø2 vertical rails beginning with width 800 mm (31.5 in.).



The DXF diagrams can be downloaded from our website.





# Disconnect enclosures

## Characteristics



Height (mm)	Width (mm)	Depth (mm)	Height (in.)	Width (in.)	Depth (in.)	Number of doors	IP	Weight of empty enclosures: kg (lbs)	Catalog number
500	500	200	19.69	19.69	7.87	1	66	11.50 (25.4)	<b>NSYS3DCD5520</b>
600	600	200	23.62	23.62	7.87	1	66	14.40 (31.7)	<b>NSYS3DCD6620</b>
700	500	200	27.56	19.69	7.87	1	66	14.80 (32.6)	<b>NSYS3DCD7520</b>
800	600	200	31.50	23.62	7.87	1	66	21.40 (47.2)	<b>NSYS3DCD8620</b>
1000	600	200	39.37	23.62	7.87	1	66	27.80 (61.3)	<b>NSYS3DCD10620</b>
1000	800	200	39.37	31.50	7.87	1	66	34.80 (76.7)	<b>NSYS3DCD10820</b>
1000	1000	300	39.37	39.37	11.81	1	66	46.40 (102.3)	<b>NSYS3DCD101030</b>
1200	1000	300	47.24	39.37	11.81	1	66	53.40 (117.7)	<b>NSYS3DCD121030</b>

### Installation accessories

	Description	Catalog number	
	Set of 4 steel mounting lugs	<b>NSYAEFPFSC</b>	
	Set of 4 stainless-steel mounting lugs	<b>NSYAEFPFXSC</b>	
	Kit for heavy loads	<b>NSYAEFAHLBSC</b>	
	Batch of 2 M8 eyebolts	<b>NSYAELYTCRG8</b>	
	Description	Width: mm (in.)	Catalog number
	Full-width mounting lugs	200 (7.9)	<b>NSYAEFPFS3DW20</b>
		300 (11.8)	<b>NSYAEFPFS3DW30</b>
		400 (15.7)	<b>NSYAEFPFS3DW40</b>
		500 (19.7)	<b>NSYAEFPFS3DW50</b>
		600 (23.6)	<b>NSYAEFPFS3DW60</b>
		800 (31.5)	<b>NSYAEFPFS3DW80</b>
		1000 (39.4)	<b>NSYAEFPFS3DW100</b>

# Disconnect enclosures

## Dimensions





Plain mounting plate painted white	Plain mounting plate galvanized	Microperforated mounting plate galvanized	Aluminum upright*	Perforated Telequick**	Adjustable brackets
NSYMM55WH	NSYMM55	NSYMF55	NSYMDVR5	NSYMR55	NSYSDCR200
NSYMM66WH	NSYMM66	NSYMF66	NSYMDVR6	NSYMR66	NSYSDCR200
NSYMM75WH	NSYMM75	NSYMF75	NSYMDVR7	NSYMR75	NSYSDCR200
NSYMM86WH	NSYMM86	NSYMF86	NSYMDVR8	NSYMR86	NSYSDCR200
NSYMM106WH	NSYMM106	NSYMF106	NSYMDVR10	NSYMR106	NSYSDCR200
NSYMM108WH	NSYMM108	NSYMF108	NSYMDVR10	NSYMR108	NSYSDCR200
NSYMM1010WH	NSYMM1010	NSYMF1010	NSYMDVR10	NSYMR1010	NSYSDCR200
NSYMM1210WH	NSYMM1210	NSYMF1210	NSYMDVR12	NSYMR1210	NSYSDCR200

\*NSYAMCSF mandatory.

\*\*NSYEMR mandatory for enclosure width > 1000 mm (39.4 in.).

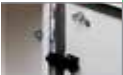
### Door accessories

	Description	Catalog number
	Steel door retainer for S3DC steel enclosure	NSYAEDRSCST
	Grounding lead 160, sec. 6 <sup>2</sup>	NSYEL166D8

### Mounting

	Description	Catalog number
	Self-tapping screw for microperforated mounting plate	NSYS13M5HS

# Steel wall-mounting enclosures

## Introduction

➤ You need an enclosure for indoor non-clean industrial environment.

### CRN

PE500369-68



PE500377-48



#### Time Lasting

- Industrial welding process.
  - Epoxy-polyester painting.
  - Foamed-in polyurethane gasket.
- All of the above guarantees quality, water and dust tightness for years.  
Front folded gutter prevents the entry of water, oil or liquids, ensuring IP66 protection.

PE500379-44



#### Safety

- For people:**
- Two welded M6 x 15 earth studs welded to the back and one M6 x 15 stud on the door.
- For your installation:**
- Water and dust tightness IP66.
  - Ruggedness IK10 to protect your component from external impact.
  - Hidden hinges to prevent the removal of the door.

PE500376-64



#### Smart

Welded door reinforcement profile allowing the mounting of equipment in models from 500 mm high.

### CRNG

PE500373-70



PE500110-35



#### Sealed

Glazed tempered glass door and fully water and dust tight, maintaining IP66 and IK08 protection.

PE500366-167



#### Practical

4 welded M8 x 15 back studs shouldered 10 mm for direct installation of mounting plate.

PE500278



#### Convenient

- Large embedded cable-entry plate with a neoprene seal, flush with the back of the enclosure.
- Direct mounting or using the brackets fixed from outside.

This range can be configured according to your needs

4 different services available:



Assemble to order



Mounting of standard accessories



Painting



Machining

See page 396 for details or consult our web site [www.schneider-electric.com](http://www.schneider-electric.com).

# Steel wall-mounting enclosures

## Characteristics



Characteristics	Spacial CRN	Spacial CRNG
	39 dimensions for this metal monobloc. Back piece joined to the sides using a special profile forming a protected sealed area.	<ul style="list-style-type: none"> <li>■ 17 dimensions with three-point locking system for this metal construction suite of enclosures.</li> <li>■ All Spacial CRNG models include a three-point locking system.</li> </ul>
Material	Steel	
Finish	Both externally and internally painted with texturised epoxy-polyester resin	
Colour	RAL 7035 grey	
Ingress protection rating	<ul style="list-style-type: none"> <li>■ IP66 for one-door enclosures</li> <li>■ IP55 for two-door enclosures according to IEC 60529</li> </ul>	
Mechanical protection rating	IK10 according to IEC 62262	
Standards	IEC 62208	
Certifications	<ul style="list-style-type: none"> <li>■ UL, CUL</li> <li>■ NEMA 4 for single-door enclosure according to NEMA 250</li> <li>■ NEMA 12, 12K and 13 for double-door enclosure according to NEMA 250</li> <li>■ RoHS compliance</li> </ul>	
Installation	<ul style="list-style-type: none"> <li>■ Given their strength, metal enclosures are particularly well suited to indoor areas where they may experience impacts</li> <li>■ Outdoor installation: compliant with IEC 62208 regarding type tests specified in §9.12 (resistance to ultra-violet (UV) radiation) and §9.13 (resistance to corrosion). It is always advisable to install a canopy to avoid water stagnation on the upper part of the enclosure</li> </ul>	
Supply	<p><b>Body</b></p> <ul style="list-style-type: none"> <li>■ 4 holes for direct mounting</li> <li>■ Wall-mounting drill holes sealed with plastic plugs to ensure the degree of protection (supplied as standard)</li> <li>■ Wall-mounting bracket fixed from outside (brackets to be ordered separately)</li> <li>■ Direct cable entry</li> <li>■ Built-in cable-entry plate, flush with the back of the enclosure (without foamed-in gasket to facilitate machining)</li> <li>■ Insulated cable entries with knock-outs, available as an accessory</li> <li>■ Easy to equip with 4 welded back studs shouldered 10 mm</li> </ul> <p><b>Door</b></p> <ul style="list-style-type: none"> <li>■ 3-mm standard double-bar lock as standard. See page 100 (Wide choice of inserts as accessories).</li> <li>■ Foamed-in polyurethane gasket on the doors to guarantee water and dust tightness for many years</li> <li>■ Easily reversible door, fixed with two or three invisible hinges allowing the door to open to 120°</li> <li>■ Reinforcement on plain doors with welded perforated door profiles for equipment mounting from models NSYCRN54150</li> <li>■ Metal hinges - Easily reversible door</li> <li>■ Welded earth studs on door and body</li> <li>■ Delivered with a reusable packaging and technical instructions</li> </ul>	<p><b>Body</b></p> <ul style="list-style-type: none"> <li>■ 4 holes for direct mounting</li> <li>■ Wall-mounting drill holes sealed with plastic plugs to ensure water and dust tightness (supplied as standard)</li> <li>■ Wall-mounting bracket fixed from outside, specific for large dimensions (to be ordered separately). See page 94.</li> <li>■ Built-in cable-entry plate, flush with the back of the enclosure (without foamed-in gasket to facilitate machining)</li> <li>■ Easy to equip with 4 welded back studs shouldered 10 mm (6 for widths of 1000 and 1200)</li> <li>■ Welded earth studs on door and body</li> </ul> <p><b>Door</b></p> <ul style="list-style-type: none"> <li>■ Three-point locking system for one and two doors. Standard 5-mm double-bar lock</li> <li>■ Metal hinges - Easily reversible door</li> <li>■ Door-centring piece on two-door enclosures to ensure proper door alignment</li> <li>■ Foamed-in polyurethane gasket on the doors to guarantee water and dust tightness for many years</li> <li>■ Reinforcement on plain doors with welded perforated door profiles for equipment mounting</li> <li>■ Delivered with a reusable packaging and technical instructions</li> </ul>

# Steel wall-mounting enclosures

## Selection guide



PB500109-15



PB500110-12



PB500072-10



PB500100-10



PB500101-13



Dimensions (mm)			No. of doors	IP	Weight (1)	Door			Plain	Silkscreened	Microperforated
Height (A)	Width (B)	Depth (C)				Plain with mounting plate	Plain without mounting plate	Glazed without mounting plate			

CRN steel wall-mounting enclosures												
200	200	150	1	66	2.5	-	NSYCRN22150 (2)	-	NSYMM22	-	-	
	300	150	1	66	3.9	-	NSYCRN23150 (2)	-	NSYMM32	-	NSYMF32	
250	200	150	1	66	3.2	-	NSYCRN252150P	NSYCRN252150	NSYMM2520	-	-	
300	250	150	1	66	4.2	-	NSYCRN325150P	NSYCRN325150	NSYCRN325150T	NSYMM3025	-	-
		200	1	66	4.9	-	NSYCRN325200P	NSYCRN325200	NSYCRN325200T	NSYMM3025	-	-
	300	150	1	66	5.0	-	NSYCRN33150P	NSYCRN33150	NSYCRN33150T	NSYMM33	-	NSYMF33
		200	1	66	6.0	-	NSYCRN33200P	NSYCRN33200	NSYCRN33200T	NSYMM33	-	NSYMF33
	400	200	1	66	6.4	-	NSYCRN34200	NSYCRN34200	NSYMM43	NSYMS43	NSYMF43	
	450	150	1	66	6.7	-	NSYCRN345150 (2)	-	NSYMM3045	-	-	
400	300	150	1	66	6.0	-	NSYCRN43150P	NSYCRN43150	NSYCRN43150T	NSYMM43	NSYMS43	NSYMF43
		200	1	66	6.8	-	NSYCRN43200P	NSYCRN43200	NSYCRN43200T	NSYMM43	NSYMS43	NSYMF43
	400	200	1	66	8.0	-	NSYCRN44200P	NSYCRN44200	NSYCRN44200T	NSYMM44	NSYMS44	NSYMF44
	600	250	1	66	10.0	-	NSYCRN46250P	NSYCRN46250	NSYCRN46250T	NSYMM64	NSYMS64	NSYMF64
	300	1	66	11.2	-	-	NSYCRN46300	NSYCRN46300	NSYMM64	NSYMS64	NSYMF64	
500	400	150	1	66	8.7	-	NSYCRN54150P	NSYCRN54150	NSYCRN54150T	NSYMM54	NSYMS54	NSYMF54
		200	1	66	9.8	-	NSYCRN54200P	NSYCRN54200	NSYCRN54200T	NSYMM54	NSYMS54	NSYMF54
	250	1	66	11.0	-	NSYCRN54250P	NSYCRN54250	NSYCRN54250T	NSYMM54	NSYMS54	NSYMF54	
	500	250	1	66	12.8	-	NSYCRN55250P	NSYCRN55250	NSYCRN55250T	NSYMM55	NSYMS55	NSYMF55
600	400	150	1	66	9.3	-	NSYCRN64150P	NSYCRN64150	NSYCRN64150T	NSYMM64	NSYMS64	NSYMF64
		200	1	66	10.8	-	NSYCRN64200P	NSYCRN64200	NSYCRN64200T	NSYMM64	NSYMS64	NSYMF64
	250	1	66	12.3	-	NSYCRN64250P	NSYCRN64250	NSYCRN64250T	NSYMM64	NSYMS64	NSYMF64	
	500	150	1	66	11.3	-	NSYCRN65150P	NSYCRN65150	NSYCRN65150T	NSYMM65	-	NSYMF65
		200	1	66	14.3	-	NSYCRN65200P	NSYCRN65200	NSYCRN65200T	NSYMM65	-	NSYMF65
	250	1	66	16.2	-	NSYCRN65250P	NSYCRN65250	NSYCRN65250T	NSYMM65	-	NSYMF65	
	600	200	1	66	16.3	-	NSYCRN66200	NSYCRN66200	NSYCRN66200T	NSYMM66	NSYMS66	NSYMF66
		250	1	66	18.2	-	NSYCRN66250P	NSYCRN66250	NSYCRN66250T	NSYMM66	NSYMS66	NSYMF66
	300	1	66	19.8	-	NSYCRN66300P	NSYCRN66300	NSYCRN66300T	NSYMM66	NSYMS66	NSYMF66	
	800	300	1	66	26.0	-	NSYCRN68300	NSYCRN68300	NSYCRN68300T	NSYMM86	NSYMS86	NSYMF86
700	500	200	1	66	17.3	-	NSYCRN75200P	NSYCRN75200	NSYCRN75200T	NSYMM75	NSYMS75	NSYMF75
		250	1	66	19.3	-	NSYCRN75250P	NSYCRN75250	NSYCRN75250T	NSYMM75	NSYMS75	NSYMF75
800	600	200	1	66	21.8	-	NSYCRN86200P	NSYCRN86200	NSYCRN86200T	NSYMM86	NSYMS86	NSYMF86
		250	1	66	24.8	-	NSYCRN86250P	NSYCRN86250	NSYCRN86250T	NSYMM86	NSYMS86	NSYMF86
	300	1	66	26.3	-	NSYCRN86300P	NSYCRN86300	NSYCRN86300T	NSYMM86	NSYMS86	NSYMF86	
	800	200	1	66	29.5	-	NSYCRN88200P	NSYCRN88200	NSYCRN88200T	NSYMM88	-	NSYMF88
		300	1	66	32.5	-	NSYCRN88300P	NSYCRN88300	NSYCRN88300T	NSYMM88	-	NSYMF88
1000	600	250	1	66	28.4	-	NSYCRN106250P	NSYCRN106250	NSYCRN106250T	NSYMM106	-	NSYMF106
		300	1	66	30.6	-	NSYCRN106300P	NSYCRN106300	NSYCRN106300T	NSYMM106	-	NSYMF106
	800	250	1	66	34.5	-	NSYCRN108250P	NSYCRN108250	NSYCRN108250T	NSYMM108	-	NSYMF108
		300	1	66	37.4	-	NSYCRN108300P	NSYCRN108300	NSYCRN108300T	NSYMM108	-	NSYMF108

CRNG Wall-mounting steel enclosures with three-point locking system											
800	600	400	1	66	30.0	-	NSYCRNG86400	NSYCRNG86400T	NSYMM86	NSYMS86	NSYMF86
	1000	300	2	55	40.0	-	NSYCRNG810300D	-	NSYMM108	-	NSYMF108
	1200	300	2	55	46.0	-	NSYCRNG812300D	-	NSYMM128	-	NSYMF128
1000	600	400	1	66	36.0	-	NSYCRNG106400	NSYCRNG106400T	NSYMM106	-	NSYMF106
	800	400	1	66	43.0	-	NSYCRNG108400	NSYCRNG108400T	NSYMM108	-	NSYMF108
	1000	300	2 (3)	55	47.0	-	NSYCRNG1010300D	NSYCRNG1010300T	NSYMM1010	-	NSYMF1010
	1200	300	2	55	55.0	-	NSYCRNG1012300D	-	NSYMM1210	-	NSYMF1210
		400	2	55	60.0	-	NSYCRNG1012400D	-	NSYMM1210	-	NSYMF1210
1200	600	300	1	66	37.0	-	NSYCRNG126300	NSYCRNG126300T	NSYMM126	-	NSYMF126
		400	1	66	42.0	-	NSYCRNG126400	NSYCRNG126400T	NSYMM126	-	NSYMF126
	800	300	1	66	45.0	-	NSYCRNG128300	NSYCRNG128300T	NSYMM128	-	NSYMF128
		400	1	66	50.0	-	NSYCRNG128400	NSYCRNG128400T	NSYMM128	-	NSYMF128
	1000	300	2	55	56.0	-	NSYCRNG1210300D	-	NSYMM1210	-	NSYMF1210
		400	2	55	61.0	-	NSYCRNG1210400D	-	NSYMM1210	-	NSYMF1210
	1200	300	2	55	64.0	-	NSYCRNG1212300D	-	NSYMM1212	-	2 x NSYMF126*
		400	2	55	90.0	-	NSYCRNG1212400D	-	NSYMM1212	-	2 x NSYMF126*
1400	1000	300	2	55	80.0	-	NSYCRNG1410300D	-	NSYMM1410	-	-

(1) Enclosure without mounting plate.

(2) Two cable gland plates, one on the top, one on the bottom.

(3) Except glazed door in single door.

(4) With two holes.

(5) For flange openings type E, two NSYTSACRNC are required.

(6) Ref. NSYEMR mandatory.

# Steel wall-mounting enclosures

## Selection guide



Telequick		Bakelite		DIN rails chassis		Aluminum upright (7)		Step slides		Cable entry					
										Fig.	Type of cable entry	Cable-gland plate standard	Cable-gland plate insulated	Cable-gland plate with FL cut-out	FlexiCable
-	-	-	-	-	-	-	-	-	1	0	NSYTLCRNO	-	-	-	
-	NSYMB32	-	-	-	-	-	-	-	1	B	NSYTLCRNB	-	-	-	
-	-	-	-	-	-	-	-	-	1	0	NSYTLCRNO	-	-	-	
NSYMR3025	NSYMB3025	-	-	NSYMDVR3	-	-	-	-	1	A	NSYTLCRNA	NSYTSACRNA	-	-	
NSYMR3025	NSYMB3025	-	-	NSYMDVR3	NSYSDCR200	-	-	-	1	A	NSYTLCRNA	NSYTSACRNA	NSYFL13CRNA	-	
NSYMR33	NSYMB33	NSYMD33	-	NSYMDVR3	-	-	-	-	1	B	NSYTLCRNB	NSYTSACRNB	NSYFL13CRNB	-	
NSYMR33	NSYMB33	NSYMD33	-	NSYMDVR3	NSYSDCR200	-	-	-	1	B	NSYTLCRNB	NSYTSACRNB	NSYFL13CRNB	-	
NSYMR34	NSYMB43	-	-	NSYMDVR3	NSYSDCR200	-	-	-	1	C	NSYTLCRNC	NSYTSACRNC	NSYFL21CRNC	-	
-	NSYMB43	-	-	NSYMDVR3	-	-	-	-	1	B	NSYTLCRNB	NSYTSACRNB	NSYFL13CRNB	-	
NSYMR43	NSYMB43	NSYMD43	-	NSYMDVR4	-	-	-	-	1	B	NSYTLCRNB	NSYTSACRNB	NSYFL13CRNB	-	
NSYMR43	NSYMB43	NSYMD43	-	NSYMDVR4	NSYSDCR200	-	-	-	1	B	NSYTLCRNB	NSYTSACRNB	NSYFL13CRNB	-	
NSYMR44	-	-	-	NSYMDVR4	NSYSDCR200	-	-	-	1	C	NSYTLCRNC	NSYTSACRNC	NSYFL21CRNC	-	
NSYMR46	NSYMB64	-	-	NSYMDVR4	NSYSDCR250	-	-	-	1	D	NSYTLCRND	NSYTSACRND	NSYFL21CRND	-	
NSYMR46	NSYMB64	-	-	NSYMDVR4	NSYSDCR300	-	-	-	1	D	NSYTLCRND	NSYTSACRND	NSYFL21CRND	-	
NSYMR54	NSYMB54	NSYMD54	-	NSYMDVR5	-	-	-	-	2	B	NSYTLCRNB	NSYTSACRNB	NSYFL13CRNB	-	
NSYMR54	NSYMB54	NSYMD54	-	NSYMDVR5	NSYSDCR200	-	-	-	2	C	NSYTLCRNC	NSYTSACRNC	NSYFL21CRNC	-	
NSYMR54	NSYMB54	NSYMD54	-	NSYMDVR5	NSYSDCR250	-	-	-	2	C	NSYTLCRNC	NSYTSACRNC	NSYFL21CRNC	-	
NSYMR55	-	-	-	NSYMDVR5	NSYSDCR250	-	-	-	2	D	NSYTLCRND	NSYTSACRND	NSYFL21CRND	-	
NSYMR64	NSYMB64	NSYMD64	-	NSYMDVR6	-	-	-	-	2	B	NSYTLCRNB	NSYTSACRNB	NSYFL13CRNB	-	
NSYMR64	NSYMB64	NSYMD64	-	NSYMDVR6	NSYSDCR200	-	-	-	2	C	NSYTLCRNC	NSYTSACRNC	NSYFL21CRNC	-	
NSYMR64	NSYMB64	NSYMD64	-	NSYMDVR6	NSYSDCR250	-	-	-	2	C	NSYTLCRNC	NSYTSACRNC	NSYFL21CRNC	-	
NSYMR65	NSYMB65	-	-	NSYMDVR6	-	-	-	-	2	B	NSYTLCRNB	NSYTSACRNB	NSYFL13CRNB	-	
NSYMR65	NSYMB65	-	-	NSYMDVR6	NSYSDCR200	-	-	-	2	D	NSYTLCRND	NSYTSACRND	NSYFL21CRND	-	
NSYMR65	NSYMB65	-	-	NSYMDVR6	NSYSDCR250	-	-	-	2	D	NSYTLCRND	NSYTSACRND	NSYFL21CRND	-	
NSYMR66	-	NSYMD66	-	NSYMDVR6	NSYSDCR200	-	-	-	2	D	NSYTLCRND	NSYTSACRND	NSYFL21CRND	-	
NSYMR66	-	NSYMD66	-	NSYMDVR6	NSYSDCR250	-	-	-	2	D	NSYTLCRND	NSYTSACRND	NSYFL21CRND	-	
NSYMR66	-	NSYMD66	-	NSYMDVR6	NSYSDCR300	-	-	-	2	D	NSYTLCRND	NSYTSACRND	NSYFL21CRND	-	
NSYMR68	-	-	-	NSYMDVR6	NSYSDCR300	-	-	-	2	E	NSYTLCRNC (4)	NSYTSACRNC	NSYFL21CRNC	-	
NSYMR75	NSYMB75	NSYMD75	-	NSYMDVR7	NSYSDCR200	-	-	-	2	D	NSYTLCRND	NSYTSACRND	NSYFL21CRND	-	
NSYMR75	NSYMB75	NSYMD75	-	NSYMDVR7	NSYSDCR250	-	-	-	2	D	NSYTLCRND	NSYTSACRND	NSYFL21CRND	-	
NSYMR86	NSYMB86	NSYMD86	-	NSYMDVR8	NSYSDCR200	-	-	-	2	D	NSYTLCRND	NSYTSACRND	NSYFL21CRND	-	
NSYMR86	NSYMB86	NSYMD86	-	NSYMDVR8	NSYSDCR250	-	-	-	2	D	NSYTLCRND	NSYTSACRND	NSYFL21CRND	-	
NSYMR86	NSYMB86	NSYMD86	-	NSYMDVR8	NSYSDCR200	-	-	-	2	D	NSYTLCRND	NSYTSACRND	NSYFL21CRND	-	
NSYMR88	-	-	-	NSYMDVR8	NSYSDCR300	-	-	-	2	E	NSYTLCRNC (4)	NSYTSACRNC (5)	NSYFL21CRNC	-	
NSYMR88	-	-	-	NSYMDVR8	NSYSDCR300	-	-	-	2	E	NSYTLCRNC (4)	NSYTSACRNC (5)	NSYFL21CRNC	-	
NSYMR106	NSYMB106	-	-	NSYMDVR10	NSYSDCR250	-	-	-	2	D	NSYTLCRND	NSYTSACRND	NSYFL21CRND	-	
NSYMR106	NSYMB106	-	-	NSYMDVR10	NSYSDCR300	-	-	-	2	D	NSYTLCRND	NSYTSACRND	NSYFL21CRND	-	
NSYMR108	NSYMB108	NSYMD108	-	NSYMDVR10	NSYSDCR250	-	-	-	2	E	NSYTLCRNC (4)	NSYTSACRNC (5)	NSYFL21CRNC	-	
NSYMR108	NSYMB108	NSYMD108	-	NSYMDVR10	NSYSDCR300	-	-	-	2	E	NSYTLCRNC (4)	NSYTSACRNC (5)	NSYFL21CRNC	-	
NSYMR86	NSYMB86	NSYMD86	-	NSYMDVR8	NSYSDCR400	-	-	-	3	G	NSYTLG	-	NSYTLG2FL	NSYTLGME	
NSYMR810	-	-	-	NSYMDVR8	NSYSDCR300	-	-	-	4	H	NSYTLG	-	NSYTLG2FL	2 x NSYTLGME	
2 x NSYMR86*	-	-	-	NSYMDVR8	NSYSDCR300**	-	-	-	4	H	NSYTLG	-	NSYTLG2FL	2 x NSYTLGME	
NSYMR106	NSYMB106	-	-	NSYMDVR10	NSYSDCR400	-	-	-	3	G	NSYTLG	-	NSYTLG2FL	NSYTLGME	
NSYMR108	NSYMB108	NSYMD108	-	NSYMDVR10	NSYSDCR400	-	-	-	4	H	NSYTLG	-	NSYTLG2FL	2 x NSYTLGME	
NSYMR1010 (6)	NSYMB1210	-	-	NSYMDVR10	NSYSDCR300	-	-	-	4	H	NSYTLG	-	NSYTLG2FL	2 x NSYTLGME	
NSYMR1012 (6)	NSYMB1210	-	-	NSYMDVR10	NSYSDCR300**	-	-	-	4	H	NSYTLG	-	NSYTLG2FL	2 x NSYTLGME	
NSYMR1012 (6)	-	-	-	NSYMDVR10	NSYSDCR400**	-	-	-	4	H	NSYTLG	-	NSYTLG2FL	2 x NSYTLGME	
NSYMR126	-	-	-	NSYMDVR12	NSYSDCR300	-	-	-	3	G	NSYTLG	-	NSYTLG2FL	NSYTLGME	
NSYMR126	-	-	-	NSYMDVR12	NSYSDCR400	-	-	-	3	G	NSYTLG	-	NSYTLG2FL	NSYTLGME	
NSYMR128	-	NSYMD128	-	NSYMDVR12	NSYSDCR300	-	-	-	4	H	NSYTLG	-	NSYTLG2FL	2 x NSYTLGME	
NSYMR128	-	NSYMD128	-	NSYMDVR12	NSYSDCR400	-	-	-	4	H	NSYTLG	-	NSYTLG2FL	2 x NSYTLGME	
NSYMR1210 (6)	NSYMB1210	-	-	NSYMDVR12	NSYSDCR300	-	-	-	4	H	NSYTLG	-	NSYTLG2FL	2 x NSYTLGME	
NSYMR1210 (6)	NSYMB1210	-	-	NSYMDVR12	NSYSDCR400	-	-	-	4	H	NSYTLG	-	NSYTLG2FL	2 x NSYTLGME	
2 x NSYMR126*	-	-	-	NSYMDVR12	NSYSDCR300**	-	-	-	4	H	NSYTLG	-	NSYTLG2FL	2 x NSYTLGME	
2 x NSYMR126*	-	-	-	NSYMDVR12	NSYSDCR400**	-	-	-	4	H	NSYTLG	-	NSYTLG2FL	2 x NSYTLGME	
NSYMR1410 (6)	-	-	-	-	NSYSDCR300	-	-	-	4	H	NSYTLG	-	NSYTLG2FL	2 x NSYTLGME	

(7) Order NSYAMCSF, NSYMDVR12 in steel.

\* Order NSYCRNGSDR to mount double mounting plate.

\*\* Except for double mounting plate, order in addition ref. NSYSRSDCR300 (D300) or NSYSRSDCR400 (D400).

# Steel wall-mounting enclosures

## Selection guide

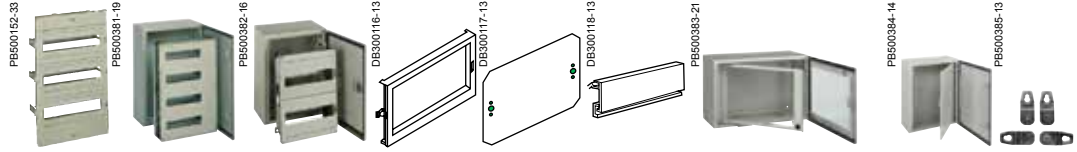

Nominal dimensions (mm)			No. of doors	Electric distribution						Electronic and network		Installation system		
Height (A)	Width (B)	Depth (C)		DLA insulated distribution chassis	DL metal distribution chassis	DLM metal distribution chassis	Plain cover plate for DLM	Mounting plate for DLM	Blanking plate	Fixed 19" rack	Swing 19" rack	Inner door	Wall-fixing lugs	
<b>CRN steel wall-mounting enclosures</b>														
200	200	150	1	-	-	-	-	-	-	-	-	-	NSYPFCR	
	300	150	1	-	-	-	-	-	-	-	-	-	NSYPFCR	
250	200	150	1	-	-	-	-	-	-	-	-	-	NSYPFCR	
300	250	150	1	-	NSYDLCR18	-	-	-	-	-	-	-	NSYPFCR	
		200	1	-	NSYDLCR18	-	-	-	-	-	-	-	NSYPFCR	
	300	150	1	-	-	-	-	-	-	-	-	-	NSYPFCR	
		200	1	-	-	-	-	-	-	-	-	-	-	NSYPFCR
400	300	150	1	NSYDLA24G	NSYDLCR24	NSYDLM24	NSYCTL300DLM	NSYPMP300DLM	NSYATP72G	-	-	NSYPIN43	NSYPFCR	
		200	1	NSYDLA24G	NSYDLCR36	NSYDLM24	NSYCTL300DLM	NSYPMP300DLM	NSYATP72G	-	-	NSYPIN43	NSYPFCR	
	400	200	1	-	NSYDLCR24* (1)	-	-	-	-	-	-	-	NSYPFCR	
		600	250	1	-	NSYDLCR36* (1)	-	-	-	-	NSYVDM8UF	NSYVDM7UP	-	NSYPFCR
500	400	150	1	NSYDLA48G	-	NSYDLM48	NSYCTL400DLM	NSYPMP400DLM	NSYATP72G	-	-	NSYPIN54	NSYPFCR	
		200	1	NSYDLA48G	-	NSYDLM48	NSYCTL400DLM	NSYPMP400DLM	NSYATP72G	-	-	NSYPIN54	NSYPFCR	
		250	1	NSYDLA48G	NSYDLCR48	NSYDLM48	NSYCTL400DLM	NSYPMP400DLM	NSYATP72G	-	-	NSYPIN54	NSYPFCR	
		500	250	1	-	NSYDLCR48* (1)	-	-	-	-	-	-	-	NSYPFCR
	600	400	150	1	NSYDLA48PG	-	NSYDLM48P	NSYCTL400DLM	NSYPMP400DLM	NSYATP72G	-	-	NSYPIN64	NSYPFCR
			200	1	NSYDLA48PG	-	NSYDLM48P	NSYCTL400DLM	NSYPMP400DLM	NSYATP72G	-	-	NSYPIN64	NSYPFCR
		500	250	1	NSYDLA48PG	NSYDLCR64	NSYDLM48P	NSYCTL400DLM	NSYPMP400DLM	NSYATP72G	-	-	NSYPIN64	NSYPFCR
			600	150	1	-	NSYDLCR64	-	-	-	-	-	-	-
600	500	200	1	-	-	-	-	-	-	-	-	-	NSYPFCR	
		250	1	-	NSYDLCR88	-	-	-	-	-	-	-	NSYPFCR	
		600	200	1	-	NSYDLCR88	NSYDLM84P	NSYCTL600DLM	NSYPMP600DLM	NSYATP72G	NSYVDM12UF	NSYVDM11UP	-	NSYPFCR
	800	250	1	-	-	NSYDLM84P	NSYCTL600DLM	NSYPMP600DLM	NSYATP72G	NSYVDM12UF	NSYVDM11UP	-	NSYPFCR	
		300	1	-	-	NSYDLM84P	NSYCTL600DLM	NSYPMP600DLM	NSYATP72G	NSYVDM12UF	NSYVDM11UP	-	NSYPFCR	
		800	300	1	-	-	-	-	-	-	-	-	-	NSYPFCR
700	500	200	1	NSYDLA66G/NSYDLA88G	-	NSYDLM66/NSYDLM88	NSYCTL500DLM	NSYPMP500DLM	NSYATP72G	-	-	NSYPIN75	NSYPFCR	
		250	1	NSYDLA66G/NSYDLA88G	-	NSYDLM66/NSYDLM88	NSYCTL500DLM	NSYPMP500DLM	NSYATP72G	-	-	NSYPIN75	NSYPFCR	
800	600	200	1	NSYDLA84G/NSYDLA112G	NSYDLCR110	NSYDLM84/NSYDLM112	NSYCTL600DLM	NSYPMP600DLM	NSYATP72G	NSYVDM17UF	-	NSYPIN86	NSYPFCR	
		250	1	NSYDLA84G/NSYDLA112G	-	NSYDLM84/NSYDLM112	NSYCTL600DLM	NSYPMP600DLM	NSYATP72G	NSYVDM17UF	NSYVDM16UP	NSYPIN86	NSYPFCR	
		300	1	NSYDLA84G/NSYDLA112G	NSYDLCR135	NSYDLM84/NSYDLM112	NSYCTL600DLM	NSYPMP600DLM	NSYATP72G	NSYVDM17UF	NSYVDM16UP	NSYPIN86	NSYPFCR	
	800	200	1	-	-	-	-	-	-	-	-	-	NSYPFCR	
1000	600	300	1	-	-	-	-	-	-	-	-	-	NSYPFCR	
		250	1	-	-	NSYDLM168	NSYCTL600DLM	NSYPMP600DLM	NSYATP72G	NSYVDM21UF	NSYVDM20UP	NSYPIN106	NSYPFCR	
		300	1	-	-	NSYDLM168	NSYCTL600DLM	NSYPMP600DLM	NSYATP72G	NSYVDM21UF	NSYVDM20UP	NSYPIN106	NSYPFCR	
	800	250	1	NSYDLA234G	-	NSYDLM240	NSYCTL800DLM	NSYPMP800DLM	NSYATP72G	-	NSYVDM20U8P	NSYPIN108	NSYPFCR	
		300	1	NSYDLA234G	-	NSYDLM240	NSYCTL800DLM	NSYPMP800DLM	NSYATP72G	-	NSYVDM20U8P	NSYPIN108	NSYPFCR	
		1400	1000	300	2	-	-	-	-	-	-	-	-	NSYAEFPFSC
<b>CRNG Wall-mounting steel enclosures with three-point locking system</b>														
800	600	400	1	NSYDLA84G/NSYDLA112G	-	NSYDLM84/NSYDLM112	NSYCTL600DLM	NSYPMP600DLM	NSYATP72G	NSYVDM17UF	NSYVDM16UP	NSYPIN86	NSYAEFPFSC	
		1000	300	2	-	-	-	-	-	-	-	-	NSYAEFPFSC	
		1200	300	2	-	-	-	-	-	-	-	-	NSYAEFPFSC	
1000	600	400	1	-	-	NSYDLM168	NSYCTL600DLM	NSYPMP600DLM	NSYATP72G	NSYVDM21UF	NSYVDM20UP	NSYPIN106	NSYAEFPFSC	
		800	400	1	NSYDLA234G	-	NSYDLM240	NSYCTL800DLM	NSYPMP800DLM	NSYATP72G	-	NSYVDM20U8P	NSYPIN108	NSYAEFPFSC
	1000	300	2	-	-	-	-	-	-	-	-	-	NSYAEFPFSC	
		1200	300	2	-	-	-	-	-	-	-	-	NSYAEFPFSC	
		400	2	-	-	-	-	-	-	-	-	-	NSYAEFPFSC	
1200	600	300	1	-	-	-	-	-	-	-	-	NSYPIN126	NSYAEFPFSC	
		400	1	-	-	-	-	-	-	-	-	NSYPIN126	NSYAEFPFSC	
	800	300	1	-	-	-	-	-	-	NSYVDM25U8P	NSYPIN128	NSYAEFPFSC		
		400	1	-	-	-	-	-	-	NSYVDM25U8P	NSYPIN128	NSYAEFPFSC		
	1000	300	2	-	-	-	-	-	-	-	-	-	NSYAEFPFSC	
		400	2	-	-	-	-	-	-	-	-	-	NSYAEFPFSC	
1200	300	2	-	-	-	-	-	-	-	-	-	NSYAEFPFSC		
	400	2	-	-	-	-	-	-	-	-	-	NSYAEFPFSC		

(1) To be coupled in 200 mm depth enclosure, the lifting bracket ref. **NSYEX608** must be ordered separately.  
 (2) 2 coupling plates and supporting poles are required.



# Steel wall-mounting enclosures

## Selection guide



	Kit for heavy loads*	Post-mounting device	Single plinths side plate**		Single plinths front plate**		Supporting pole	Coupling plates	Canopies	Floor stand kit for WM		Support bracket for enclosure with anti-tilt kit and reinforcement
			100 mm	200 mm	100 mm	200 mm				300 mm	400 mm	
-	-	-	-	-	-	-	-	-	-	-	-	NSYCOCNS1400
-	-	-	-	-	-	-	-	-	-	-	-	NSYCOCNS1400
-	-	-	-	-	-	-	NSYCOCN80	-	NSYTJ2015	-	-	NSYCOCNS1400
-	-	-	-	-	-	-	NSYCOCN80	NSYCHCOA	NSYTJ2515	-	-	NSYCOCNS1400
-	-	-	-	-	-	-	NSYCOCN80	NSYCHCOA	NSYTJ2520	-	-	NSYCOCNS1400
-	NSYFFPSC30	-	-	-	-	-	NSYCOCN80	NSYCHCOB	NSYTJ3015	-	-	NSYCOCNS1400
-	NSYFFPSC30	-	-	-	-	-	NSYCOCN80	NSYCHCOB	NSYTJ3020	-	-	NSYCOCNS1400
-	NSYFFPSC40	-	-	-	-	-	NSYCOCN80	NSYCHCOC	NSYTJ4020	-	-	NSYCOCNS1400
-	-	-	-	-	-	-	-	-	-	-	-	NSYCOCNS1400
-	NSYFFPSC30	-	-	-	-	-	NSYCOCN80	NSYCHCOB	NSYTJ3015	-	-	NSYCOCNS1400
-	NSYFFPSC30	-	-	-	-	-	NSYCOCN80	NSYCHCOB	NSYTJ3020	-	-	NSYCOCNS1400
-	NSYFFPSC40	-	-	-	-	-	NSYCOCN80	NSYCHCOC	NSYTJ4020	-	-	NSYCOCNS1400
-	NSYFFPSC60	-	-	-	-	-	NSYCOCN80	NSYCHCOD	NSYTJ6025	-	-	NSYCOCNS1400
-	NSYFFPSC60	NSYSPS3100SD	NSYSPS3200SD	NSYSPF6100	NSYSPF6200	NSYCOCN80	NSYCHCOD	NSYTJ6030	-	-	-	NSYCOCNS1400
-	NSYFFPSC40	-	-	-	-	-	NSYCOCN80	NSYCHCOB	NSYTJ4015	-	-	NSYCOCNS1400
-	NSYFFPSC40	-	-	-	-	-	NSYCOCN80	NSYCHCOC	NSYTJ4020	-	-	NSYCOCNS1400
-	NSYFFPSC40	-	-	-	-	-	NSYCOCN80	NSYCHCOC	NSYTJ4025	-	-	NSYCOCNS1400
-	NSYFFPSC50	-	-	-	-	-	NSYCOCN80	NSYCHCOD	NSYTJ5025	-	-	NSYCOCNS1400
-	NSYFFPSC40	-	-	-	-	-	NSYCOCN80	NSYCHCOB	NSYTJ4015	-	-	NSYCOCNS1400
-	NSYFFPSC40	-	-	-	-	-	NSYCOCN80	NSYCHCOC	NSYTJ4020	-	-	NSYCOCNS1400
-	NSYFFPSC40	-	-	-	-	-	NSYCOCN80	NSYCHCOC	NSYTJ4025	-	-	NSYCOCNS1400
-	NSYFFPSC50	-	-	-	-	-	NSYCOCN80	NSYCHCOD	NSYTJ5015	-	-	NSYCOCNS1400
-	NSYFFPSC50	-	-	-	-	-	NSYCOCN80	NSYCHCOD	NSYTJ5020	-	-	NSYCOCNS1400
-	NSYFFPSC50	-	-	-	-	-	NSYCOCN80	NSYCHCOD	NSYTJ5025	-	-	NSYCOCNS1400
-	NSYFFPSC60	-	-	-	-	-	NSYCOCN80	NSYCHCOD	NSYTJ6020	-	-	NSYCOCNS1400
-	NSYFFPSC60	-	-	-	-	-	NSYCOCN80	NSYCHCOD	NSYTJ6025	-	-	NSYCOCNS1400
-	NSYFFPSC60	NSYSPS3100SD	NSYSPS3200SD	NSYSPF6100	NSYSPF6200	NSYCOCN80	NSYCHCOD	NSYTJ6030	-	-	-	NSYCOCNS1400
-	NSYFFPSC80	NSYSPS3100SD	NSYSPS3200SD	NSYSPF8100	NSYSPF8200	NSYCOCN80	NSYCHCOC (2)	NSYTJ8030	-	-	-	NSYCOCNS1400
-	NSYFFPSC50	-	-	-	-	-	NSYCOCN80	NSYCHCOD	NSYTJ5020	-	-	NSYCOCNS1400
-	NSYFFPSC50	-	-	-	-	-	NSYCOCN80	NSYCHCOD	NSYTJ5025	-	-	NSYCOCNS1400
-	NSYFFPSC60	-	-	-	-	-	NSYCOCN80	NSYCHCOD	NSYTJ6020	-	-	NSYCOCNS1400
-	NSYFFPSC60	-	-	-	-	-	NSYCOCN80	NSYCHCOD	NSYTJ6025	-	-	NSYCOCNS1400
-	NSYFFPSC60	NSYSPS3100SD	NSYSPS3200SD	NSYSPF6100	NSYSPF6200	NSYCOCN80	NSYCHCOD	NSYTJ6030	-	-	-	NSYCOCNS1400
-	NSYFFPSC80	-	-	-	-	-	NSYCOCN80	NSYCHCOC (2)	NSYTJ8020	-	-	NSYCOCNS1400
-	NSYFFPSC80	NSYSPS3100SD	NSYSPS3200SD	NSYSPF8100	NSYSPF8200	NSYCOCN80	NSYCHCOC (2)	NSYTJ8030	-	-	-	NSYCOCNS1400
-	-	-	-	-	-	-	NSYCOCN80	NSYCHCOD	NSYTJ6025	-	-	NSYCOCNS1400
-	-	NSYSPS3100SD	NSYSPS3200SD	NSYSPF6100	NSYSPF6200	NSYCOCN80	NSYCHCOD	NSYTJ6030	-	-	-	NSYCOCNS1400
-	-	-	-	-	-	-	NSYCOCN80	NSYCHCOD	NSYTJ6025	-	-	NSYCOCNS1400
-	-	NSYSPS3100SD	NSYSPS3200SD	NSYSPF6100	NSYSPF6200	NSYCOCN80	NSYCHCOD	NSYTJ6030	-	-	-	NSYCOCNS1400
-	-	-	-	-	-	-	NSYCOCN80	NSYCHCOC (2)	NSYTJ8025	-	-	NSYCOCNS1400
-	-	NSYSPS3100SD	NSYSPS3200SD	NSYSPF8100	NSYSPF8200	NSYCOCN80	NSYCHCOC (2)	NSYTJ8030	-	-	-	NSYCOCNS1400
NSYAEFAHLBSC	NSYFFPSC60	NSYSPS4100SD	NSYSPS4200SD	NSYSPF6100	NSYSPF6200	-	-	NSYTJ6040	-	-	-	-
NSYAEFAHLBSC	-	NSYSPS3100SD	NSYSPS3200SD	NSYSPF10100	NSYSPF10200	-	-	NSYTJ10030	NSYWMK33	NSYWMK34	-	-
NSYAEFAHLBSC	-	NSYSPS3100SD	NSYSPS3200SD	NSYSPF12100	NSYSPF12200	-	-	NSYTJ12030	NSYWMK33	NSYWMK34	-	-
NSYAEFAHLBSC	-	NSYSPS4100SD	NSYSPS4200SD	NSYSPF6100	NSYSPF6200	-	-	NSYTJ6040	-	-	-	-
NSYAEFAHLBSC	-	NSYSPS4100SD	NSYSPS4200SD	NSYSPF8100	NSYSPF8200	-	-	NSYTJ8040	NSYWMK43	NSYWMK44	-	-
NSYAEFAHLBSC	-	NSYSPS3100SD	NSYSPS3200SD	NSYSPF10100	NSYSPF10200	-	-	NSYTJ10030	NSYWMK33	NSYWMK34	-	-
NSYAEFAHLBSC	-	NSYSPS3100SD	NSYSPS3200SD	NSYSPF12100	NSYSPF12200	-	-	NSYTJ12030	NSYWMK33	NSYWMK34	-	-
NSYAEFAHLBSC	-	NSYSPS4100SD	NSYSPS4200SD	NSYSPF12100	NSYSPF12200	-	-	NSYTJ12040	NSYWMK43	NSYWMK44	-	-
NSYAEFAHLBSC	-	NSYSPS3100SD	NSYSPS3200SD	NSYSPF6100	NSYSPF6200	-	-	NSYTJ6030	-	-	-	-
NSYAEFAHLBSC	-	NSYSPS4100SD	NSYSPS4200SD	NSYSPF6100	NSYSPF6200	-	-	NSYTJ6040	-	-	-	-
NSYAEFAHLBSC	-	NSYSPS3100SD	NSYSPS3200SD	NSYSPF8100	NSYSPF8200	-	-	NSYTJ8030	NSYWMK33	NSYWMK34	-	-
NSYAEFAHLBSC	-	NSYSPS4100SD	NSYSPS4200SD	NSYSPF8100	NSYSPF8200	-	-	NSYTJ8040	NSYWMK43	NSYWMK44	-	-
NSYAEFAHLBSC	-	NSYSPS3100SD	NSYSPS3200SD	NSYSPF10100	NSYSPF10200	-	-	NSYTJ10030	NSYWMK33	NSYWMK34	-	-
NSYAEFAHLBSC	-	NSYSPS4100SD	NSYSPS4200SD	NSYSPF10100	NSYSPF10200	-	-	NSYTJ10040	NSYWMK43	NSYWMK44	-	-
NSYAEFAHLBSC	-	NSYSPS3100SD	NSYSPS3200SD	NSYSPF12100	NSYSPF12200	-	-	NSYTJ12030	NSYWMK33	NSYWMK34	-	-
NSYAEFAHLBSC	-	NSYSPS4100SD	NSYSPS4200SD	NSYSPF12100	NSYSPF12200	-	-	NSYTJ12040	NSYWMK43	NSYWMK44	-	-
NSYAEFAHLBSC	-	NSYSPS3100SD	NSYSPS3200SD	NSYSPF10100	NSYSPF10200	-	-	NSYTJ10030	NSYWMK33	NSYWMK34	-	-

\* Order the NSYAEFPFSC wall-mounting brackets separately.  
 \*\* To install the plinth to a wall-mounting enclosure, order ref. NSYAPFWM.  
 \*\*\* Available in version 1800 mm: ref. NSYCOCNS1800.

**CRN**

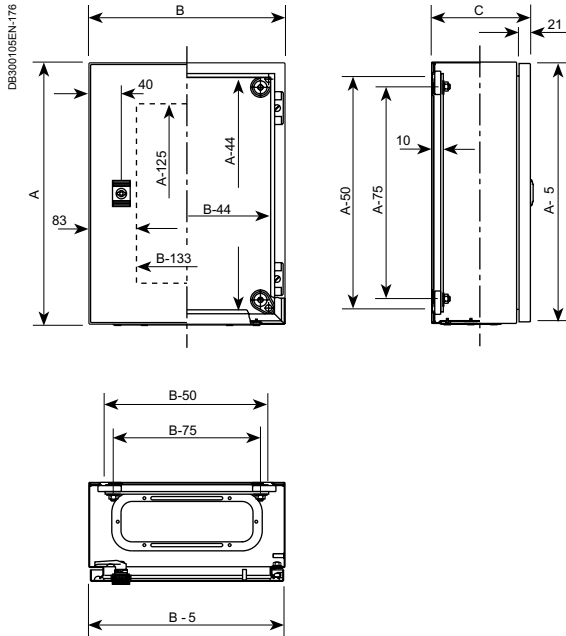

Fig. 1

A: Enclosure height  
 B: Enclosure width  
 C: Enclosure depth

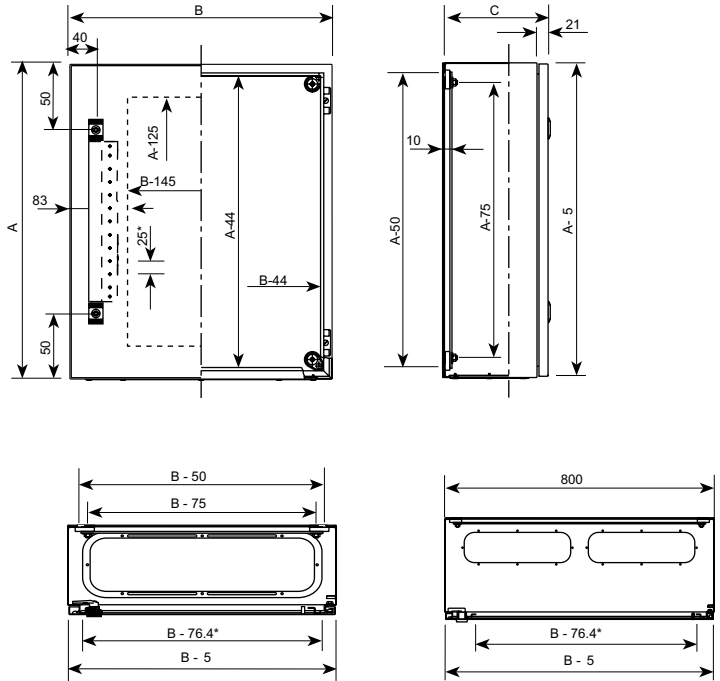
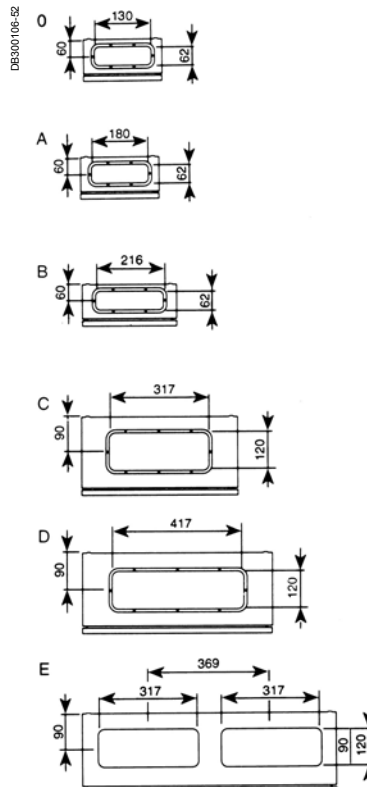

Fig. 2

Width < 800

Width ≥ 800

### Spacial CRN cable entry dimensions and type



None of the T glazed-door enclosures have door reinforcement profiles.

Our DXF diagrams and technical instruction sheets can be downloaded from our websites.

**CRNG**

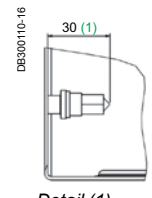
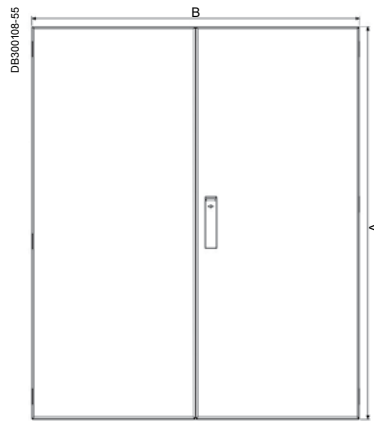
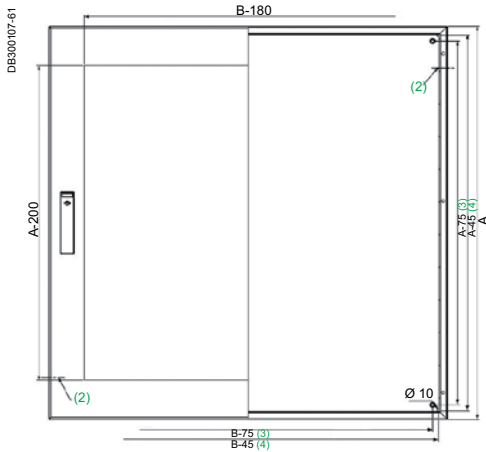

Detail (1)

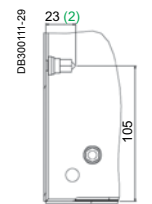

Detail (2)

Dimensions of enclosure (mm)					
Width (B)	Depth (C)	J	K	L	M
600	300-400	126	470	195	-
800	300-400	95	320	105	400
1000 (5)	300	125	420	105	500
1000	300-400	95	420	105	500
1200	300	95	420	105	500
	400	125	420	105	600

- (1) Four M8 x 25 back studs.
- (2) Two M6 x 17.5 earth studs.
- (3) Spacing between the studs.
- (4) Space between perforations for direct mounting.
- (5) Only models 1400 x 1000 x 300.

A: Enclosure height  
 B: Enclosure width  
 C: Enclosure depth

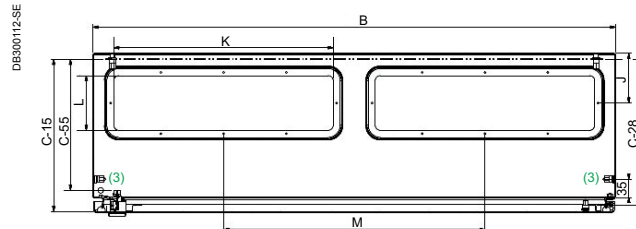

Cable entry type H: enclosure width ≥ 800 mm.

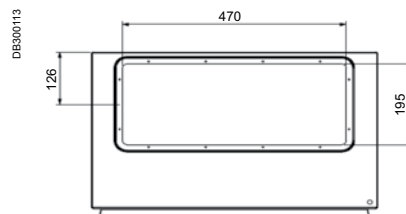

Cable entry type G: enclosure width 600 mm.

### Dimensions of the door-reinforcement profiles (6)

1-door enclosure		Reinforcement profile	
Height (A)	Width (B)	F	D
800	600	620	487
1000	600	820	487
	800	820	687
1200	600	1020	480
	800	1020	687

2-door enclosure		Reinforcement profile			
Height (A)	Width (B)	Rt. Door		Lft. Door	
		F	D	F	D
800	1000	620	387	620	437
	1200	620	487	620	537
1000	1000	820	387	820	437
	1200	820	487	820	537
1200	1000	1020	387	1020	437
	1200	1020	487	1020	537
1400	1000	1020	387	1020	437

- (6) The T doors only include vertical profiles.
  - (7) 25-mm passage.
  - (8) 1 M6 x 17.5 earth stud.
- Download our DXF diagrams from our website.

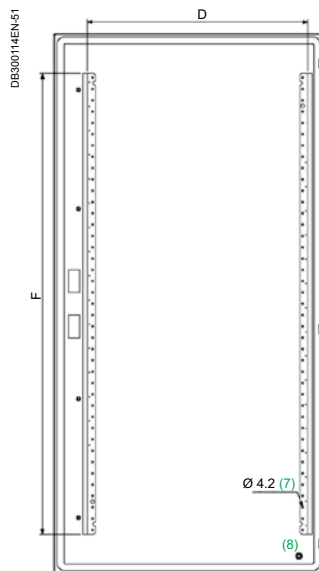

PB500371-74



### Composition accessories

#### Mounting



Page 94

#### Floor



Page 97

#### Coupling



Page 98

#### Hoisting



Page 99

#### Protection



Page 99

#### Locking systems



Page 100

#### Cable-gland plates



Page 103

#### Door



Page 104

#### Mounting accessories



Page 236

PB502439-65



### Cable management

#### Cable holding

PB500986-40



Page 286

#### Cable ducting

PB500959-22

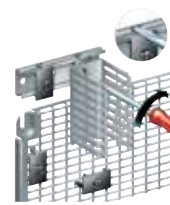

Page 289

### Thermal management

#### Heaters

PB502050-29



Page 454

#### Ventilation

PB501044-26



Page 412

#### Cooling units

PB502614-15



Page 435

### Others

#### Earthing

PB500217-29



Page 302

## Mounting



Characteristics	Wall-mounting kit for Spacial CRN enclosures	Wall-mounting brackets	Kit for heavy loads
	They are fixed from the outside and can be positioned vertically or horizontally indistinctly. Not included in the standard supply.	Set of 4 wall-mounting brackets. Mounted directly on the rear of the enclosure, either in horizontal or vertical position. Two types of position, for a wall-enclosure separation of 10 mm. Do not use for dynamic loads.	Kit made up of 2 reinforcement pieces. To be mounted before installing the mounting plate in top position with the standard lugs (to be ordered separately).
Material	Passivated zinc-coated steel or stainless-steel	Steel	AISI 304 stainless-steel
Maximum load	150 kg	150 kg	400 kg
Supply	4 wall-mounting brackets	Supplied with mounting screws and pre-mounted sealing gaskets	-

References	Steel	Stainless-steel			
	NSYPFCR	NSYPFC2X	NSYAEFPFSC	NSYAEFPFXSC	NSYAEFAHLBSC
	<p>A: Enclosure height B: Enclosure width</p>		<p>Installation from the outside.</p> <p>Mounting centre-to-centre distance with M8 screws</p> <p>Vertical position. Horizontal position.</p>		

You will find the weights of the Spacial CRN - CRNG enclosures without mounting plate in the selection guide on page 86.

### Mounting



Characteristics	Post-mounting device for Spacial steel enclosure	
	For indoor installations on posts with a maximum circumference of 675 mm (minimum diameter 150 mm and maximum diameter 215 mm). Rail fixed to the inserts in the rear of the enclosure with 8-mm screws. They allow the mounting of protection canopies.	
Material	Galvanised steel	
Maximum load	100 kg	
<b>Width (mm)</b>	<b>A (mm)</b>	<b>References</b>
300	295	<b>NSYSFPSC30</b>
400	395	<b>NSYSFPSC40</b>
500	495	<b>NSYSFPSC50</b>
600	595	<b>NSYSFPSC60</b>
800	795	<b>NSYSFPSC80</b>

### Mounting

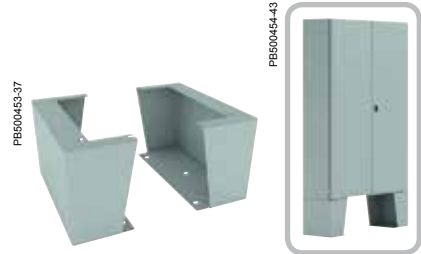
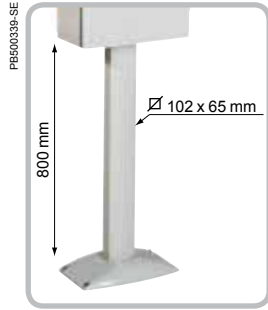

Characteristics	Support pillar	Support bracket for enclosure with anti-tilt kit and reinforcement	Floor Stand Kit for wall-mounting enclosure																																		
	The support pillar is fixed directly to the bottom face of the Spacial steel enclosure by means of an adapter plate. The latter, to be ordered in addition to the pillar, replaces the cable-gland plate. Overall height of the support foot: 800 mm. Mounting possible on all enclosures with dimensions up to 600 x 400 x 250 mm (except 200 x 200 x 150 and 250 x 200 x 150 enclosures).	The support bracket for Spacial S3D and Spacial CRN steel enclosures is used when the enclosure cannot be hung from a wall or a post. Suitable for outdoor use. Compatible with other enclosure ranges: <ul style="list-style-type: none"> <li>■ S3X (stainless-steel),</li> <li>■ S3HF (EMC),</li> <li>■ Thalassa (polyester).</li> </ul> Maximum enclosure dimensions: 1000 x 800 x 300 mm. Floor attachment by standard M12 fastenings.	Set of 2 feet, elevating wall-mounting enclosures. Cut-outs needed on enclosure – drilling template provided with the kit.																																		
Material	Extruded aluminium	Steel	Steel																																		
Finish	Polyester powder	Painted	Polyester powder																																		
Colour	RAL 7035 grey	RAL 7035 grey	RAL 7035 grey																																		
Thickness	-	-	<ul style="list-style-type: none"> <li>■ Sides: 2.5 mm</li> <li>■ Base: 3 mm</li> </ul>																																		
Maximum load	-	120 kg	250 kg																																		
Supply	-	-	2 platform feet (right and left) & mounting elements																																		
Height (mm)	Reference	References	<table border="1"> <thead> <tr> <th rowspan="2">Enclosure depth</th> <th colspan="2">Foot height</th> <th rowspan="2">References</th> </tr> <tr> <th>mm</th> <th>Inches</th> </tr> </thead> <tbody> <tr> <td>800</td> <td>-</td> <td>-</td> <td>-</td> </tr> <tr> <td>1400</td> <td>-</td> <td>-</td> <td>-</td> </tr> <tr> <td>1800</td> <td>-</td> <td>-</td> <td>-</td> </tr> <tr> <td>-</td> <td>-</td> <td>-</td> <td>300* 12 300 12 NSYWWMK33</td> </tr> <tr> <td>-</td> <td>-</td> <td>-</td> <td>400** 16 300 12 NSYWWMK43</td> </tr> <tr> <td>-</td> <td>-</td> <td>-</td> <td>300* 12 450 18 NSYWWMK34</td> </tr> <tr> <td>-</td> <td>-</td> <td>-</td> <td>400** 16 450 18 NSYWWMK44</td> </tr> </tbody> </table>	Enclosure depth	Foot height		References	mm	Inches	800	-	-	-	1400	-	-	-	1800	-	-	-	-	-	-	300* 12 300 12 NSYWWMK33	-	-	-	400** 16 300 12 NSYWWMK43	-	-	-	300* 12 450 18 NSYWWMK34	-	-	-	400** 16 450 18 NSYWWMK44
Enclosure depth	Foot height		References																																		
	mm	Inches																																			
800	-	-	-																																		
1400	-	-	-																																		
1800	-	-	-																																		
-	-	-	300* 12 300 12 NSYWWMK33																																		
-	-	-	400** 16 300 12 NSYWWMK43																																		
-	-	-	300* 12 450 18 NSYWWMK34																																		
-	-	-	400** 16 450 18 NSYWWMK44																																		
			<p>* When enclosures are equipped with a cable gland plate, it only fits with enclosures of width 800, 1000 &amp; 1200 mm, except model H 600 x W 800 x D 300 mm.</p> <p>** When enclosures are equipped with a cable gland plate, it does not fit with enclosures of width 600 mm.</p> <p>Compatible with Spacial S3D, S3DC &amp; CRNG enclosures.</p>																																		
	<h4>Support pillar adaptation plate</h4> <p><b>Description:</b> plate for mounting the support pillar on the enclosure. This plate replaces the cable-gland plate delivered with the enclosure.</p> <p><b>Material:</b> steel</p> <p><b>Finish:</b> polyester powder</p> <p><b>Colour:</b> RAL 7035 grey</p>																																				
	<table border="1"> <thead> <tr> <th colspan="2">For enclosure (mm)</th> <th>To be coupled with cable entry*</th> <th>References</th> </tr> <tr> <th>Width</th> <th>Depth</th> <th></th> <th></th> </tr> </thead> <tbody> <tr> <td>250</td> <td>150-200</td> <td>A</td> <td>NSYCHCOA</td> </tr> <tr> <td>300-400-450-500</td> <td>150-200</td> <td>B</td> <td>NSYCHCOB</td> </tr> <tr> <td>400</td> <td>200-250</td> <td>C</td> <td>NSYCHCOC</td> </tr> <tr> <td>500-600</td> <td>200-250-300</td> <td>D</td> <td>NSYCHCOD</td> </tr> </tbody> </table>	For enclosure (mm)		To be coupled with cable entry*	References	Width	Depth			250	150-200	A	NSYCHCOA	300-400-450-500	150-200	B	NSYCHCOB	400	200-250	C	NSYCHCOC	500-600	200-250-300	D	NSYCHCOD												
For enclosure (mm)		To be coupled with cable entry*	References																																		
Width	Depth																																				
250	150-200	A	NSYCHCOA																																		
300-400-450-500	150-200	B	NSYCHCOB																																		
400	200-250	C	NSYCHCOC																																		
500-600	200-250-300	D	NSYCHCOD																																		
	* See type of entry in drawings on page 90.																																				



### Floor



Characteristics	Front and rear plinth	Plinth side panels
	The front and rear of the plinth consists of 4 corners with 2 or 4 panels.	They are fixed to the corner of the plinth by 2 mounting screws.
Material	Folded sheet steel, corner with a thickness of 2.5 mm	Folded sheet steel
Finish	Painted with epoxy-polyester resin	Painted with epoxy-polyester resin
Colour	RAL 7022 grey	RAL 7022 grey
Ingress protection rating	IP30	IP30
Mechanical protection rating	IK10	IK10
Installation	It is necessary to order separately the plinth mounting kit (ref. <b>NSYAPFWM</b> ) composed by mounting hardware and drilling jig	
Supply	<ul style="list-style-type: none"> <li>■ Height 100 mm: 4 corners, 2 panels (front and rear), 4 corner covers and mounting elements</li> <li>■ Height 200 mm: 4 corners, 4 panels (2 front and 2 rear), 4 corner covers and mounting elements</li> </ul>	<ul style="list-style-type: none"> <li>■ Height 100 mm: 2 side panels, 4 corner covers and mounting elements</li> <li>■ Height 200 mm: 4 side panels (height of 100 mm, 2 for each side), 4 corner covers and mounting elements</li> </ul>

References					
Width (mm)	Depth (mm)	100 mm	200 mm	100 mm	200 mm
600	-	NSYS PF6100	NSYS PF6200	-	-
800	-	NSYS PF8100	NSYS PF8200	-	-
1000	-	NSYS PF10100	NSYS PF10200	-	-
1200	-	NSYS PF12100	NSYS PF12200	-	-
-	300	-	-	NSYS PS3100SD	NSYS PS3200SD
-	400	-	-	NSYS PS4100SD	NSYS PS4200SD

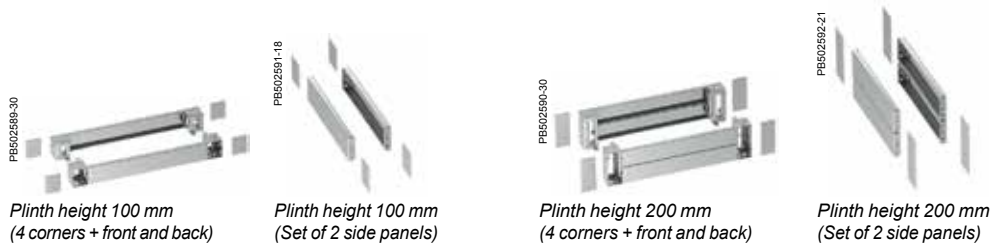

Characteristics		Stainless-steel plinths								
Material		Stainless-steel, AISI 304L				Stainless-steel, AISI 316L				
Finish		Scotch-Brite® brushing, to guarantee the durability in application where the contact with the floor increase the risk of corrosion								
Installation		It is necessary to order separately the plinth mounting kit (ref. <b>NSYAPFXWM</b> ) composed by mounting hardware and drilling jig								
External dimensions (mm)			Plinth height 100 mm		Plinth height 200 mm		Plinth height 100 mm		Plinth height 200 mm	
Height (A)	Width (B)	Depth (C)	Kit (4 corners + front and back)	Set of 2 side panels	Kit (4 corners + front and back)	Set of 2 side panels (x2)	Kit (4 corners + front and back)	Set of 2 side panels	Kit (4 corners + front and back)	Set of 2 side panels (x2)
800	800	300	NSYS PF8100	NSYS PSX3100	NSYS PF8200	NSYS PSX3200	NSYS PF8100H	NSYS PSX3100H	NSYS PF8200H	NSYS PSX3200H
1000	800	300	NSYS PF8100	NSYS PSX3100	NSYS PF8200	NSYS PSX3200	NSYS PF8100H	NSYS PSX3100H	NSYS PF8200H	NSYS PSX3200H
	1000	300	NSYS PF10100	NSYS PSX3100	NSYS PF10200	NSYS PSX3200	NSYS PF10100H	NSYS PSX3100H	NSYS PF10200H	NSYS PSX3200H
1200	800	300	NSYS PF8100	NSYS PSX3100	NSYS PF8200	NSYS PSX3200	NSYS PF8100H	NSYS PSX3100H	NSYS PF8200H	NSYS PSX3200H
	1000	300	NSYS PF10100	NSYS PSX3100	NSYS PF10200	NSYS PSX3200	NSYS PF10100H	NSYS PSX3100H	NSYS PF10200H	NSYS PSX3200H

## Coupling

PB500335-42



Installation example.

PB500336-34



Version without cable entry.

PB500337-26



Version with cable entry.

Characteristics	Coupling of Spacial steel enclosures
	Available in 2 versions: <ul style="list-style-type: none"> <li>■ Coupling version without cable entry.</li> <li>■ Version with coupling frame allowing the entry of cables.</li> <li>■ Separation of 17 mm between 2 coupled enclosures, allowing full opening of the doors.</li> </ul> Allows lateral coupling of 2 enclosures. These frames allow the door to open to 120°.
Material	Polyester charged with fibreglass, self-extinguishing
Ingress protection rating	IP66
Supply	<ul style="list-style-type: none"> <li>■ Kit made up of 4 spacers and their mountings</li> <li>■ Mounting by screws, included</li> </ul>
References	
Batch of 4 coupling spacers	<b>NSYAEUBUSC</b>
Coupling frame, 435 x 185 mm	<b>NSYAEUBU41SC</b>
Coupling frame, 635 x 185 mm	<b>NSYAEUBU61SC</b>

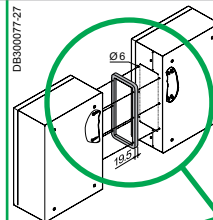

Version with cable entry.

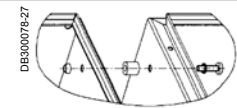

Version without cable entry.

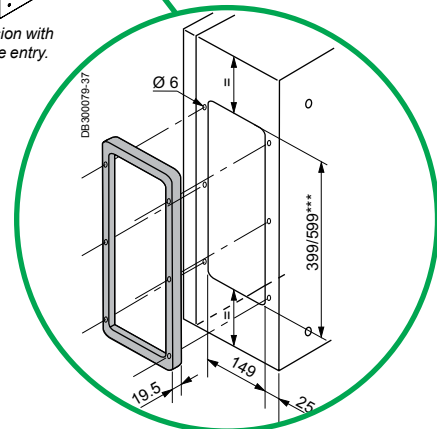

### Hoisting



Characteristics		Eyebolts
		Set of two M8 eyebolts. They are fixed directly to the body of the floor-standing enclosure. Cannot be installed with the canopy in place.
Material	Zinc-coated moulded steel	
Maximum load	210 kg per enclosure when slinging at 60°	
Options	Have your cut-outs made by our configured service, page 6. Paint touch-up pen, page 303.	
Supply	Reinforcing brackets attached to the rings (these brackets also act as a drilling template)	
<b>Reference</b>		
Batch of 2 M8 eyebolts	NSYAELYTCR8	

### Protection



Characteristics		Protection canopy			
		Direct mounting to the body of the enclosure by 4 M6 screws. To be used for all outdoor installations.			
Material	Sheet steel				
Finish	Painted galvanised steel, structured finish				
Colour	RAL 7035 grey				
Supply	Delivered with the mountings required for installation				
Depth (mm)	Width (mm)	F (mm)	G (mm)	H (mm)	References
150	200	36	75	23	NSYTJ2015
	250	36	75	23	NSYTJ2515
	300	36	75	23	NSYTJ3015
	400	36	75	23	NSYTJ4015
	500	36	75	23	NSYTJ5015
200	500	36	130	23	NSYTJ5020
	600	36	130	23	NSYTJ6020
	250	36	130	23	NSYTJ2520
	300	36	130	23	NSYTJ3020
	400	36	130	23	NSYTJ4020
	800	36	130	23	NSYTJ8020
250	400	42	150	48	NSYTJ4025
	500	42	150	48	NSYTJ5025
	600	42	150	48	NSYTJ6025
	800	42	150	48	NSYTJ8025
300	600	42	200	48	NSYTJ6030
	800	42	200	48	NSYTJ8030
	1000	42	200	48	NSYTJ10030
	1200	42	200	48	NSYTJ12030
400	600	42	300	48	NSYTJ6040
	800	42	300	48	NSYTJ8040
	1000	42	300	48	NSYTJ10040
	1200	42	300	48	NSYTJ12040

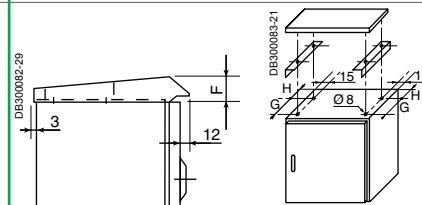



CRN













## Locking systems



### Lock for Spacial CRN enclosure

**NSYCDB3** 3 mm Ø standard double-bar lock.  
By mounting the wing nut to the lock, the double-bar lock becomes a handle lock.

- Operation using:
  - wing key ref.: **NSYDBP** 
  - key **NSYLD5** (according to DIN 43668) 

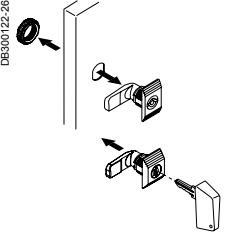
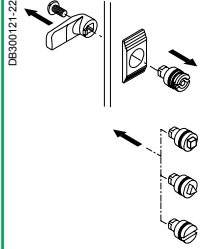
Type of lock	Insert references	Key references
 3 mm double bar	<b>NSYTDBCRN*</b>	 <b>NSYLD5</b>
□ 6 mm	<b>NSYTC6CRN</b>	 <b>NSYLC7</b>
□ 7 mm	<b>NSYTC7CRN</b>	 <b>NSYLC7</b>
□ 8 mm	<b>NSYTC8CRN</b>	 <b>NSYLC8</b>
△ 6.5 mm	<b>NSYTT6CRN</b>	 <b>NSYLT8</b>
△ 7 mm	<b>NSYTT7CRN</b>	 <b>NSYLT8</b>
△ 8 mm	<b>NSYTT8CRN</b>	 <b>NSYLT8</b>
 Screw driver lock	<b>NSYAEDLSD</b>	-
Complete manual handle lock, operated with key 405	<b>NSYCL405CRN</b>	
Complete manual handle lock, operated with key 220	<b>NSYCL220CRN</b>	
Complete metal lock, operated with key 405E	<b>NSYCLL405CRN</b>	
 Lock change.	 Insert change.	

\* Delivered with 1 metal key.



PB500391-32



PB500390-65

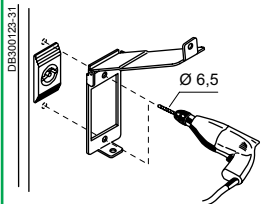

### Padlock

References	Ø 8 mm. Stainless-steel.	Ø 7.5 mm / Ø 10 mm.
 <b>NSYKPLM</b>	 <b>NSYCBCCRN</b>	
 <b>NSYKPLM padlock assembly</b>		



### Locking systems



#### Lock for Spacial CRNG enclosure (three-point lock)

Transformation of the standard lock to standardised variations in enclosures with three-point locks			Transformation of the standard lock to a retractable three-point lock with various types of inserts		
<ul style="list-style-type: none"> <li>Standard 5 mm double-bar lock for CRNG models.</li> <li>Operation using: key <b>NSYLDDB5</b> (according to DIN 43668) </li> </ul>					
Type of insert	Insert references	Key references*	Type of insert	Insert references	Key references*
□ 6 mm square	NSYTC6ML	NSYLC7	Key operated bar lock	NSYTEDB5ML	NSYLDDB5
□ 7 mm square	NSYTC7ML	NSYLC7	□ 7 mm square lock	NSYTEC7ML	NSYLC7
□ 8 mm square	NSYTC8ML	NSYLC8	□ 8 mm square lock	NSYTEC8ML	NSYLC8
△ 7 mm side triangle	NSYTT7ML	NSYLT8	△ 7 mm side triangle lock	NSYTET7ML	NSYLT8
△ 8 mm side triangle	NSYTT8ML	NSYLT8	△ 8 mm side triangle lock	NSYTET8ML	NSYLT8
Handle lock	NSYTSML		Lock operated with key type 405	NSYTEL405ML	
Handle lock operated using key 405 (included)	NSYTL405SML		Lock operated with reinforced key	NSYTERML	

\* Insert without keys (unless indicated).

#### Padlocking accessories

	Padlocking system, positioned around the long rectangular escutcheon of the enclosures, to block access to the lock, for a Ø 9 mm padlock.	Padlocking system, to block access to the retractable handle, for a Ø 9 mm padlock.
--	--	---

References	NSYBCPL	NSYBCME

**CRN**

## Cable-gland plates

PB500395-34



PB500327-33



PB500396-31



Characteristics	Standard	With FL cut-outs	Insulated
	The cable-gland plate for Spacial CRN guarantees water and dust tightness.	Cable-gland plate.	<ul style="list-style-type: none"> <li>With a polyurethane sealing gasket.</li> <li>Excellent thermal resistance.</li> <li>Pre-marked holes for cable entry plates.</li> </ul>
Material	Steel	Steel	Self-extinguishing ABS with 30 % fibreglass
Colour	RAL 7035	RAL 7035	RAL 7035
Installation	<ul style="list-style-type: none"> <li>Mounting with screws</li> <li>It is flattened with the body</li> </ul>	Mounting with screws	Pre-marked holes with diameter Pg for coupling of cable glands, membrane glands, tubes, etc
Supply	<ul style="list-style-type: none"> <li>Included as a standard with the Spacial CRN enclosure</li> <li>It is delivered with a separate seal: it allows easy cut-outs with no risk of damaging the seal and can be easily repainted</li> </ul>	Includes cut-outs for FL13 and FL21 according to the dimension	-

Width (mm)	Depth (mm)	To be coupled with entry	Fig. (only insulated)	References		
200	150	0	-	NSYTLCRNO	-	-
250	150/200	A	1	NSYTLCRNA	NSYTFL13CRNA	NSYTSACRNA
300	150/200	B	2	NSYTLCRNB	NSYTFL13CRNB	NSYTSACRNB
400/500	150	B	3	NSYTLCRNB	NSYTFL13CRNB	NSYTSACRNB
400	200/250	C	3	NSYTLCRNC	NSYTFL21CRNC	NSYTSACRNC
500/600	200/250/300	D	4	NSYTLCRND	NSYTFL21CRND	NSYTSACRND
800	200/250/300	E*	-	NSYTLCRNC	NSYTFL21CRNC	-
	200/250/300	E**	3	-	-	NSYTSACRNC

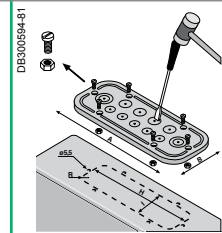

See cable entry on page 272.

\* Enclosure with 2 entries.

\*\* For type E cable entry, use two NSYTSACRNC.

PB500397-88



Example of use (insulated).

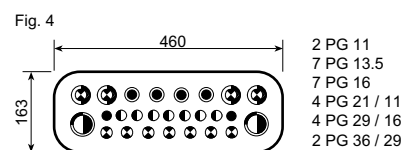
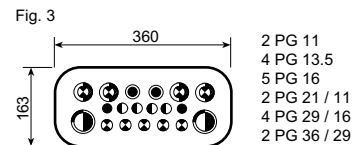
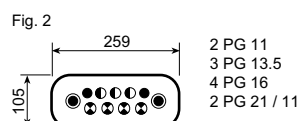
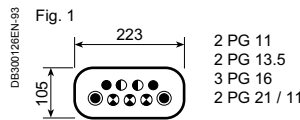

- PG 11 (18.6 mm)
- PG 13.5 (20.4 mm)
- PG 16 (22.5 mm)
- PG 21 / 11 (28.3 / 18.6 mm)
- PG 29 / 16 (37 / 22.5 mm)
- PG 36 / 29 (47 / 37 mm)



## Cable-gland plates



Characteristics	Standard	For membrane glands	FlexiCable
	Cable entries.	Cable entries.	FlexiCable is an innovative cable-gland plate for simple and fast cable entrance. There is no need to drill holes: the creation of the cable entrances takes a few seconds. ■ <b>Cable diameter:</b> up to 26 mm.
Material	Steel painted with textured epoxy-polyester resin	Steel painted with textured epoxy-polyester resin	-
Colour	RAL 7035	RAL 7035	-
Ingress protection rating	-	The membranes are built to accommodate water and dust tight cable entries in insulated material (flame classification V0), guaranteeing IP65 (to be ordered separately)	IP55
Certifications	-	-	■ Fire resistant 650°C following IEC 60695-2-11 ■ Tested on short-circuit effect 250 A, 25 kA following IEC 61439-1
Installation	■ Surface with a grid pattern in 25 mm intervals to facilitate perforation ■ Mounting with screws	Mounting with screws	<b>Installation possibilities:</b> replaces cable-gland plate (S3D or CRN-G) or directly on enclosure
Other characteristics	-	-	Exists in 5 sizes matching 46 sizes (132 models) of Spacial S3D steel wall-mounting enclosures
Supply	Standard supply with the Spacial CRNG enclosures	-	■ 1 metallic frame with pre-mounted membrane ■ 1 gasket ■ Hardware

Width (mm)	Depth (mm)	To be coupled with entry	Dimensions A x B (mm)	References	Effective cable entrance dimensions (mm)	References
600	300-400	-	495 x 220	-	428 x 153	NSYTLGME
	400	G		NSYTLG		
800	300-400	H*	345 x 130	NSYTLG2FL**	-	-
		-		NSYTLDFL**	-	-
		-		-	-	2 x NSYTLDME
1000-1200	300-400	H*	445 x 130	NSYTLG2FL**	-	-
		-		NSYTLDFL**	-	-
		-		-	-	2 x NSYTLME

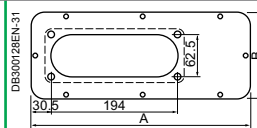
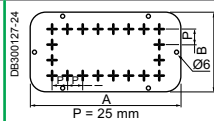

Mount FlexiCable on your CRN enclosure.

Create a hole with a screw driver.



Push the cable through FlexiCable and finish-off your installation.

### FlexiCable repair kit



To fill-in unused holes.

Reference  
NSYTLREP

\* 2 entries.  
\*\* FL21 cut-outs.

### Door



PBE000384-54

#### Internal door

		<ul style="list-style-type: none"> <li>■ 3-mm double-bar lock.</li> <li>■ Not compatible with mounting with door stop and door contact. Consult us.</li> </ul>
Material		Sheet-steel
Colour		RAL 7035 grey
Installation		<ul style="list-style-type: none"> <li>■ The internal door can be mounted either on the front face of the enclosure or on step slides (not supplied as standard)</li> <li>■ To mount an inner door and a mounting plate at the same time on the step slides, is possible as standard</li> </ul>
Maximum load		30 kg/m <sup>2</sup>
Dimensions (mm)		References
Height (A)	Width (B)	
400	300	NSYPIN43
500	400	NSYPIN54
600	400	NSYPIN64
700	500	NSYPIN75
800	600	NSYPIN86 (1)
1000	600	NSYPIN106 (1)
	800	NSYPIN108 (1)
1200	600	NSYPIN126
	800	NSYPIN128 (1)

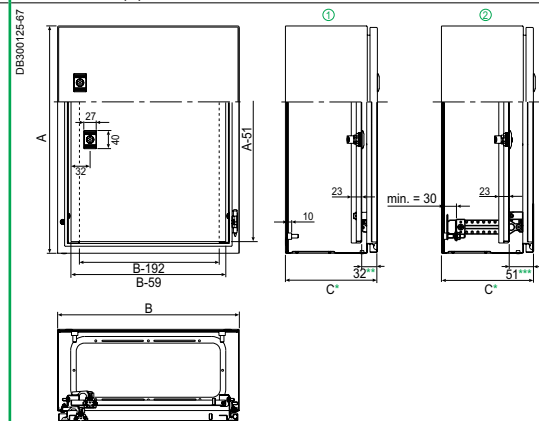

① NSYPIN... internal door fixed directly to the enclosure.

② NSYPIN... internal door fixed to the adjustable NSYSDCR support. In this case, both the internal door and the mounting plate may be depth adjustable.

(1) Equipped with welded vertical profiles in order to facilitate cable management.

\* Dimension C according to general table on page 88.

\*\* Except H 1200 x W 600: 38.3.

\*\*\* Except H 1200 x W 600: 59 and H 1200 x W 800: 52.





# Steel floor-standing enclosures

PB500067-39



### **Spacial SM-SF Steel floor-standing enclosures** **108**

Introduction	108
Characteristics	110
Dimensions	112
Selection guide	114
Specific accessories overview	120
Common accessories overview	122
Accessories	124

PB500205-22



### **Associated applicative offers**

<b>SFHD</b> Floor-standing Heavy Duty enclosures	306
<b>SF 5G, SFP 5G</b> Seismic and nuclear enclosures	320
<b>SMHF</b> Electromagnetic compatibility	343
<b>SFHF</b> Electromagnetic compatibility	343
Automobile application	394

**SM**

> Multi-purpose **IP55 compact steel enclosure** for fast and simple solutions.



**Robust**

- Body made as a single piece with welded rear panel.
- Front part forming a rigid frame with welded corners.



**Practical**

- Door rails, which can be height-adjustable and used for mounting cables.
- The adaptation profile installed in the front of the enclosure and the universal 40-mm cross rail (1 row) in the rear provide the same mounting points as the modular enclosure.



**Protection**

- IP guaranteed by the rigidity of the enclosure, the expanded-polyurethane sealing gasket of the enclosure and the subsequent welding.
- Double-door enclosures with inner lock on the left door.



**Comfort**

- Handle with sturdy design for easily activating the locking system, allowing the installation of any shape insert and any cylindrical combination key.
- Easily interchangeable insert with one click.

**This range can be configured according to your needs**

4 different services available:



Assemble to order



Mounting of standard accessories



Painting



Machining

See page 396 for details or consult our web site [www.schneider-electric.com](http://www.schneider-electric.com)

➤ Multi-purpose **IP55 modular steel enclosure**.

**SF**

Adapts to all your needs.  
Assembled delivery for a ready-to-use solution.



**SF kit**

Adapts to customer needs.  
Delivered as kit, with up to 600 different possible configurations.



### Robust

- Structure formed from a single 15/10°-mm galvanised-steel section, with a high rigidity.
- Vertical uprights screwed together with connections of full steel. Placement and screwing of the 4 vertical uprights at the corners of the top and bottom frames. Mounting by 8 screws, one at each corner of the enclosure.
- Capable of withstanding 1000 kg distributed in its volume.



### Reliable

- The design of the profile creates a double protective barrier against the entry of water and dust when coupling two enclosures.
- The first barrier is the metal connection of the sections, and the second barrier is the EPDM gasket that guarantees the sealing.



### Aesthetics

The built-in panels and handle with new design give the enclosure a new appearance.

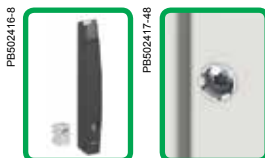

### Comfort

- Handle with robust design for easily activating the locking system, allowing the installation of any shape insert and any cylindrical combination key.
- Panels with captive screws for easier assembly and dismantling.



### Practical

Suspension of the rear panel using a self-centering piece to facilitate screwing.



### Simple

The new design allows enclosures to be coupled in any direction, adapting to all installation surfaces.



### Accessible

The symmetric design of the profile allows doors to be installed on any side of the enclosure, opening to right or left, providing full accessibility to the enclosure.

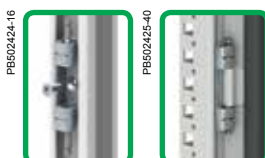

### Fast

- The double system of cut-outs on the structure allows most accessories to be installed using self-tapping TORX T30 M6 screws or nuts.
- Clip-on quick-mounting cross rails, fixed with self-tapping screws.
- Door installation inserting the captive pins of the hinge in their housing in the door.

# Steel floor-standing enclosures

## Characteristics



Characteristics	Compact enclosures Spacial SM
	<p>Compact body with a front rigid frame with welded corners and rear panel 4 supports installed in depth to adjust and fix the equipment with a pitch of 25 mm</p> <p><b>Basic composition</b></p> <ul style="list-style-type: none"> <li>■ Front door with a reinforcement frame (horizontal rails height-adjustable)</li> <li>■ The double doors are overlapping, with system for mounting the left door</li> <li>■ Door reversible, 120° opening</li> <li>■ Welded rear panel</li> <li>■ 4 locking points system with handle 5 mm double-bar insert</li> <li>■ Cable-gland plate 1 entry</li> <li>■ Mounting plate support brackets</li> </ul> <p><b>Versions / Configurations</b></p> <ul style="list-style-type: none"> <li>■ Compact enclosure with plain door and mounting plate</li> <li>■ Compact enclosure with plain door and without mounting plate</li> <li>■ Compact enclosure with transparent Securit® glass door and without mounting plate</li> </ul> <p><b>Protection of personnel</b> Earthing accessories needed to ensure the grounding continuity, see page 300</p>
Material	Sheet steel
Finish	Textured finish with epoxy-polyester powder
Colour	RAL 7035 grey
Ingress protection rating	IP55 according to IEC 60529
Mechanical protection rating	IK10 for plain door and IK08 for transparent door according to IEC 62262
Standards	Compliance with enclosure standard IEC 62208 and the RoHS directive
Certifications	BV, DNV, UL * and cUL *1 door: 1, 2, 3R, 4, 5, 12K and 13 * 2 doors: 1, 12, 12K
Installation	Indoor / Outdoor* installation * Compliant with IEC 62208 regarding type tests specified in §9.12 (resistance to UV radiation) and §9.13 (resistance to corrosion) Outdoor installation: canopy needed to avoid water stagnation on the upper part of the enclosure, see page 138
Maximum load	700
Options	<ul style="list-style-type: none"> <li>■ Plinths, heights 100 mm and 200 mm, see page 132</li> <li>■ Lifting eyebolts, reference <b>NSYSMEB</b></li> <li>■ Internal door, see page 141</li> <li>■ Door accessories, see page 142</li> <li>■ Other locking options, see page 144</li> <li>■ Mounting plates and Telequick system, see page 242.</li> </ul>

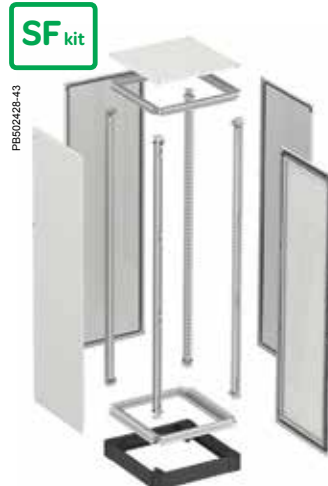

Suitable enclosures Spacial SF - Assembled supply	Suitable enclosures Spacial SF - Supplied as a kit
<p>Structure made up of vertical uprights joined with top and bottom frames Panels and doors built into the structure Formed from a single section and perforated structure with a pitch of 25 mm</p> <p><b>Basic composition</b></p> <ul style="list-style-type: none"> <li>■ Front door with a reinforcement frame (horizontal rails height-adjustable) and a trim plate</li> <li>■ The double doors are overlapping, with system for mounting the left door</li> <li>■ Door reversible, 120° opening</li> <li>■ Rear panel screwed on with captive screws</li> <li>■ Removable roof</li> <li>■ 4 locking points system with handle 5 mm double-bar insert</li> <li>■ Mounting plate support brackets</li> <li>■ Mounting plate sliding rails</li> <li>■ 2 quick mounting cross rails</li> </ul> <p><b>Versions / Configurations</b></p> <ul style="list-style-type: none"> <li>■ Modular enclosure with plain door and mounting plate</li> <li>■ Modular enclosure with plain door and without mounting plate</li> <li>■ Modular enclosure with transparent Securit® glass door and without mounting plate</li> </ul> <p><b>Protection of personnel</b> Earthing accessories needed to ensure the grounding continuity, see page 300</p>	<p>Structure made up of vertical uprights joined with top and bottom frames Panels and doors built into the structure Formed from a single section and perforated structure with a pitch of 25 mm</p> <p><b>Basic composition</b></p> <ul style="list-style-type: none"> <li>■ Front door with a reinforcement frame (horizontal rails height-adjustable)</li> <li>■ The double doors are overlapping, with system for mounting the left door</li> <li>■ Door reversible, 120° opening</li> <li>■ Rear panel to be screwed on with captive screws</li> <li>■ Removable roof delivered with top frame</li> <li>■ 4 locking points system with handle 5 mm double-bar insert</li> <li>■ Mounting plate support brackets delivered with top &amp; bottom frames kit</li> <li>■ Mounting plate sliding rails delivered with top &amp; bottom frames kit</li> <li>■ 2 quick mounting cross rails delivered with top &amp; bottom frames kit</li> </ul> <p><b>Versions / Configurations</b></p> <ul style="list-style-type: none"> <li>■ Uprights kit</li> <li>■ Top and bottom frames kit</li> <li>■ Rear panel kit</li> <li>■ Door kit (plain or transparent)</li> </ul> <p><b>Protection of personnel</b> Earthing accessories needed to ensure the grounding continuity, see page 300</p>
Sheet steel	
Textured finish with epoxy-polyester powder	
RAL 7035 grey	
IP55 according to IEC 60529	IP55 according to IEC 60529
IK10 for plain door and IK08 for transparent door according to IEC 62262	IK10 for plain door and IK08 for transparent door according to IEC 62262
Compliance with enclosure standard IEC 62208 and the RoHS directive	
BV, DNV, UL and cUL* *1 door: 1, 3R, 12, 12K *2 doors: 1, 3R, 12, 12K	BV, DNV, UL and cUL* *1 door: 1, 3R, 12, 12K *2 doors: 1, 3R, 12, 12K
Indoor / Outdoor* installation * Compliant with IEC 62208 regarding type tests specified in §9.12 (resistance to UV radiation) and §9.13 (resistance to corrosion) Outdoor installation: canopy needed to avoid water stagnation on the upper part of the enclosure, see page 138	Indoor / Outdoor* installation * Compliant with IEC 62208 regarding type tests specified in §9.12 (resistance to UV radiation) and §9.13 (resistance to corrosion) Outdoor installation: canopy needed to avoid water stagnation on the upper part of the enclosure, see page 138
1000	1000
<ul style="list-style-type: none"> <li>■ Side panels options, see page 124</li> <li>■ Enclosure suites options, see page 126</li> <li>■ Plinths, heights 100 mm and 200 mm, see page 132</li> <li>■ Cable-gland plates, see page 134</li> <li>■ Lifting systems, see page 136</li> <li>■ Roof options, see page 138</li> <li>■ Door accessories, see page 142</li> <li>■ Other locking options, see page 144</li> <li>■ Mounting plates and Telequick system, see page 242.</li> </ul>	<ul style="list-style-type: none"> <li>■ Door trim plates, see page 142</li> <li>■ Side panels options, see page 124</li> <li>■ Enclosure suites options, see page 126</li> <li>■ Plinths, heights 100 mm and 200 mm, see page 132</li> <li>■ Cable-gland plates, see page 134</li> <li>■ Lifting systems, see page 136</li> <li>■ Roof options, see page 138</li> <li>■ Other locking options, see page 144</li> <li>■ Mounting plates and Telequick system, see page 242</li> </ul>

**SM**

DE500190EN-176

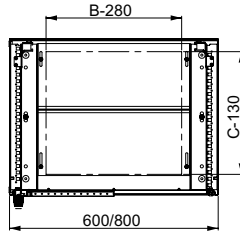
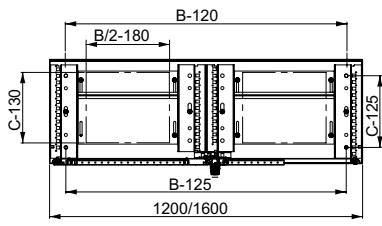
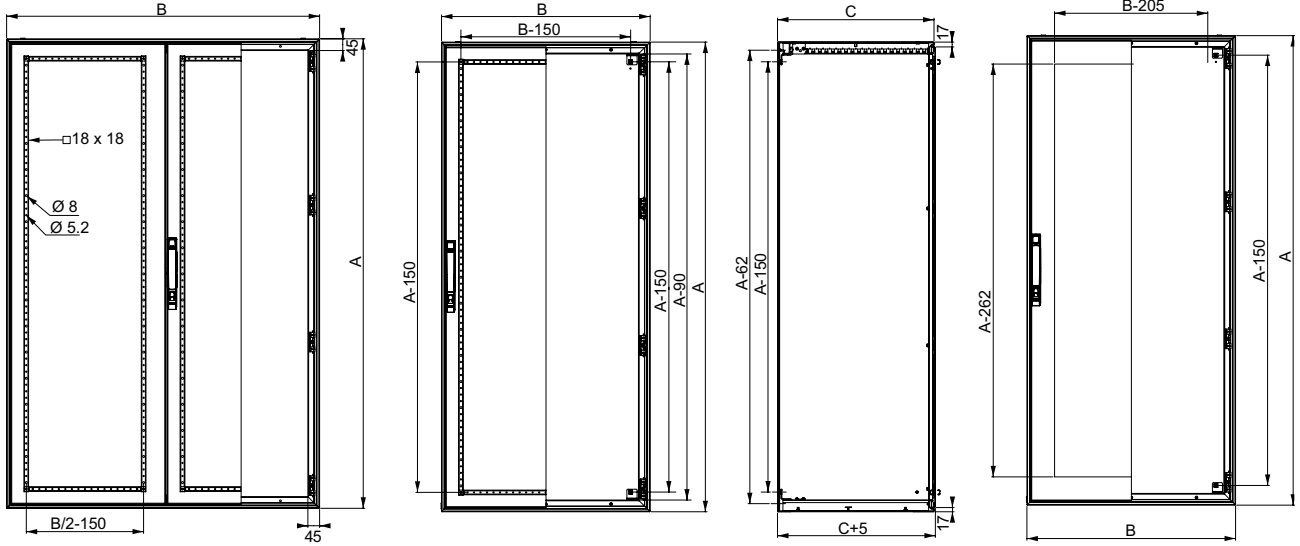

Models with a width of 1200 mm without top/bottom adjustment rails



SF

SF kit

DB630085ZEN

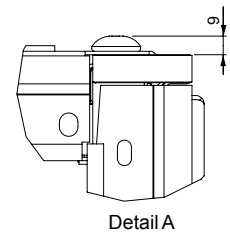
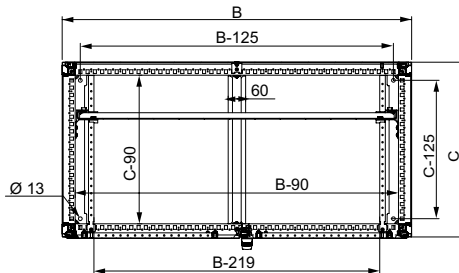
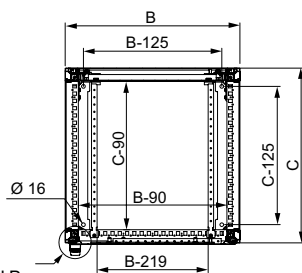
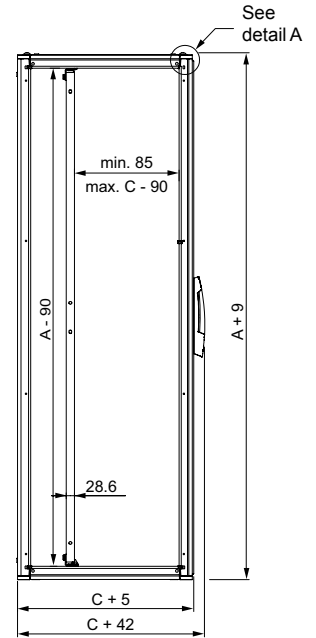
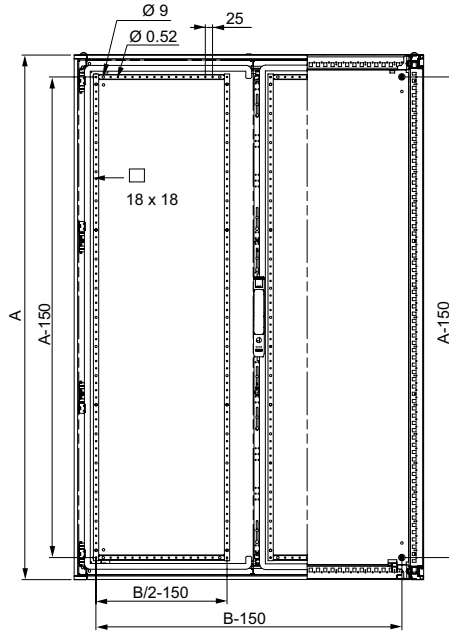
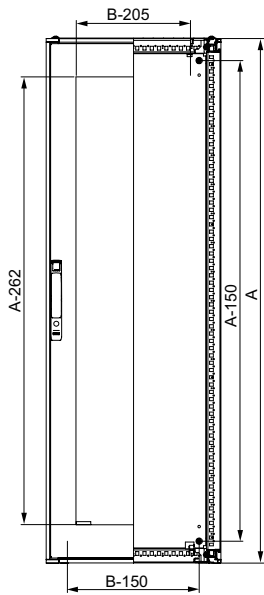

See detail B

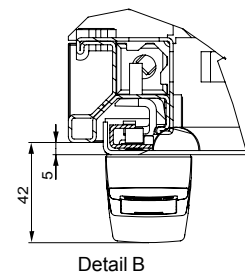

**SM**

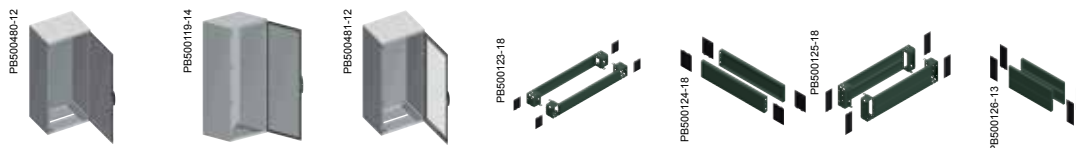

Characteristics			Door			Plinth					
Dimensions (mm)			No. of doors	Plain		Transparent	Height 100 mm		Height 200 mm		
H (A)	W (B)	D (C)		With mounting plate	Without mounting plate	Without mounting plate	Front kit (corners + front panels)	Side panels, 2 u.	Front kit (corners + front panels)	Side panels, 4 u.	
1200	800	300	1	NSYSM12830P	NSYSM12830	-	NSYSPF8100	NSYSPS3100	NSYSPF8200	NSYSPS3200	
	1000	300	2	NSYSM1210302DP	NSYSM1210302D	-	NSYSPF10100	NSYSPS3100	NSYSPF10200	NSYSPS3200	
	1200	400	2	NSYSM1212402DP	NSYSM1212402D	-	NSYSPF12100	NSYSPS4100	NSYSPF12200	NSYSPS4200	
1400	600	300	1	NSYSM14630P	NSYSM14630	-	NSYSPF6100	NSYSPS3100	NSYSPF6200	NSYSPS3200	
		400	1	NSYSM14640P	NSYSM14640	-	NSYSPF6100	NSYSPS4100	NSYSPF6200	NSYSPS4200	
	800	300	1	NSYSM14830P	NSYSM14830	-	NSYSPF8100	NSYSPS3100	NSYSPF8200	NSYSPS3200	
		400	1	NSYSM14840P	NSYSM14840	NSYSM14840T	NSYSPF8100	NSYSPS4100	NSYSPF8200	NSYSPS4200	
		1000	400	2	NSYSM1410402DP	NSYSM1410402D	-	NSYSPF10100	NSYSPS4100	NSYSPF10200	NSYSPS4200
		1200	400	2	NSYSM1412402DP	NSYSM1412402D	-	NSYSPF12100	NSYSPS4100	NSYSPF12200	NSYSPS4200
1600	600	300	1	NSYSM16630P	NSYSM16630	-	NSYSPF6100	NSYSPS3100	NSYSPF6200	NSYSPS3200	
		400	1	NSYSM16640P	NSYSM16640	NSYSM16640T	NSYSPF6100	NSYSPS4100	NSYSPF6200	NSYSPS4200	
	800	300	1	NSYSM16830P	NSYSM16830	NSYSM16830T	NSYSPF8100	NSYSPS3100	NSYSPF8200	NSYSPS3200	
		400	1	NSYSM16840P	NSYSM16840	NSYSM16840T	NSYSPF8100	NSYSPS4100	NSYSPF8200	NSYSPS4200	
	1000	300	2	NSYSM1610302DP	NSYSM1610302D	-	NSYSPF10100	NSYSPS3100	NSYSPF10200	NSYSPS3200	
		400	2	NSYSM1610402DP	NSYSM1610402D	-	NSYSPF10100	NSYSPS4100	NSYSPF10200	NSYSPS4200	
	1200	300	2	NSYSM1612302DP	NSYSM1612302D	-	NSYSPF12100	NSYSPS3100	NSYSPF12200	NSYSPS3200	
		400	2	NSYSM1612402DP	NSYSM1612402D	-	NSYSPF12100	NSYSPS4100	NSYSPF12200	NSYSPS4200	
	1800	600	300	1	NSYSM18630P	NSYSM18630	-	NSYSPF6100	NSYSPS3100	NSYSPF6200	NSYSPS3200
			400	1	NSYSM18640P	NSYSM18640	NSYSM18640T	NSYSPF6100	NSYSPS4100	NSYSPF6200	NSYSPS4200
			500	1	NSYSM18650P	NSYSM18650	-	NSYSPF6100	NSYSPS5100	NSYSPF6200	NSYSPS5200
		800	300	1	NSYSM18830P	NSYSM18830	NSYSM18830T	NSYSPF8100	NSYSPS3100	NSYSPF8200	NSYSPS3200
400			1	NSYSM18840P	NSYSM18840	NSYSM18840T	NSYSPF8100	NSYSPS4100	NSYSPF8200	NSYSPS4200	
500			1	NSYSM18850P	NSYSM18850	NSYSM18850T	NSYSPF8100	NSYSPS5100	NSYSPF8200	NSYSPS5200	
600		300	1	NSYSM18860P	NSYSM18860	-	NSYSPF8100	NSYSPS6100	NSYSPF8200	NSYSPS6200	
		400	1	NSYSM181040P	NSYSM181040	-	NSYSPF10100	NSYSPS4100	NSYSPF10200	NSYSPS4200	
		400	2	NSYSM1810402DP	NSYSM1810402D	-	NSYSPF10100	NSYSPS4100	NSYSPF10200	NSYSPS4200	
500		2	NSYSM1810502DP	NSYSM1810502D	-	NSYSPF10100	NSYSPS5100	NSYSPF10200	NSYSPS5200		
		400	2	NSYSM1812402DP	NSYSM1812402D	-	NSYSPF12100	NSYSPS4100	NSYSPF12200	NSYSPS4200	
		500	2	NSYSM1812502DP	NSYSM1812502D	-	NSYSPF12100	NSYSPS5100	NSYSPF12200	NSYSPS5200	
1600		400	2	NSYSM1816402DP	NSYSM1816402D	-	NSYSPF16100	NSYSPS4100	NSYSPF16200	NSYSPS4200	
		500	2	NSYSM1816502DP	NSYSM1816502D	-	NSYSPF16100	NSYSPS5100	NSYSPF16200	NSYSPS5200	
		600	2	NSYSM1816602DP	NSYSM1816602D	-	NSYSPF16100	NSYSPS6100	NSYSPF16200	NSYSPS6200	
2000		600	300	1	NSYSM20630P	NSYSM20630	-	NSYSPF6100	NSYSPS3100	NSYSPF6200	NSYSPS3200
			400	1	NSYSM20640P	NSYSM20640	NSYSM20640T	NSYSPF6100	NSYSPS4100	NSYSPF6200	NSYSPS4200
			500	1	NSYSM20650P	NSYSM20650	-	NSYSPF6100	NSYSPS5100	NSYSPF6200	NSYSPS5200
	800	300	1	NSYSM20830P	NSYSM20830	NSYSM20830T	NSYSPF8100	NSYSPS3100	NSYSPF8200	NSYSPS3200	
		400	1	NSYSM20840P	NSYSM20840	NSYSM20840T	NSYSPF8100	NSYSPS4100	NSYSPF8200	NSYSPS4200	
		500	1	NSYSM20850P	NSYSM20850	NSYSM20850T	NSYSPF8100	NSYSPS5100	NSYSPF8200	NSYSPS5200	
	600	1	NSYSM20860P	NSYSM20860	NSYSM20860T	NSYSPF8100	NSYSPS6100	NSYSPF8200	NSYSPS6200		
		400	2	NSYSM2010402DP	NSYSM2010402D	-	NSYSPF10100	NSYSPS4100	NSYSPF10200	NSYSPS4200	
		500	2	NSYSM2010502DP	NSYSM2010502D	-	NSYSPF10100	NSYSPS5100	NSYSPF10200	NSYSPS5200	
	1200	400	2	NSYSM2012402DP	NSYSM2012402D	-	NSYSPF12100	NSYSPS4100	NSYSPF12200	NSYSPS4200	
		500	2	NSYSM2012502DP	NSYSM2012502D	-	NSYSPF12100	NSYSPS5100	NSYSPF12200	NSYSPS5200	
		600	2	NSYSM2012602DP	NSYSM2012602D	-	NSYSPF12100	NSYSPS6100	NSYSPF12200	NSYSPS6200	
	1600	400	2	NSYSM2016402DP	NSYSM2016402D	-	NSYSPF16100	NSYSPS4100	NSYSPF16200	NSYSPS4200	
		500	2	NSYSM2016502DP	NSYSM2016502D	-	NSYSPF16100	NSYSPS5100	NSYSPF16200	NSYSPS5200	
		600	2	NSYSM2016602DP	NSYSM2016602D	-	NSYSPF16100	NSYSPS6100	NSYSPF16200	NSYSPS6200	

**SM**

PE500475-12



PE500477-7



PE500482-10



PE500483-13



PE500473-12



Characteristics			Inner door	Mounting plate	Vertical uprights		Off-centre 19" swing rack	Centred 19" swing rack		
Dimensions (mm)					No. of doors	Standard			Technical	
H (A)	W (B)	D (C)								
1200	800	300	1	-	NSYMP128	-	NSYTVR12	-	-	
	1000	300	2	-	NSYMP1210	-	NSYTVR12	-	-	
	1200	400	2	-	NSYMP1212	-	NSYTVR12	-	-	
1400	600	300	1	-	NSYMP146	-	NSYTVR14	-	-	
		400	1	-	NSYMP146	-	NSYTVR14	-	-	
	800	300	1	-	NSYMP148	-	NSYTVR14	NSYRSW27	NSYRSWC27	
		400	1	-	NSYMP148	-	NSYTVR14	NSYRSW27	NSYRSWC27	
	1000	400	2	-	NSYMP1410	-	NSYTVR14	-	-	
	1200	400	2	-	NSYMP1412	-	NSYTVR14	-	-	
1600	600	300	1	NSYID166	NSYMP166	-	NSYTVR16	-	-	
		400	1	NSYID166	NSYMP166	-	NSYTVR16	-	-	
	800	300	1	NSYID168	NSYMP168	-	NSYTVR16	NSYRSW31	NSYRSWC31	
		400	1	NSYID168	NSYMP168	-	NSYTVR16	NSYRSW31	NSYRSWC31	
	1000	300	2	-	NSYMP1610	-	NSYTVR16	-	-	
		400	2	-	NSYMP1610	-	NSYTVR16	-	-	
	1200	300	2	-	NSYMP1612	-	NSYTVR16	-	-	
		400	2	-	NSYMP1612	-	NSYTVR16	-	-	
	1800	600	300	1	NSYID186	NSYMP186	NSYVR18	NSYTVR18	-	-
			400	1	NSYID186	NSYMP186	NSYVR18	NSYTVR18	-	-
500			1	NSYID186	NSYMP186	NSYVR18	NSYTVR18	-	-	
800		300	1	NSYID188	NSYMP188	NSYVR18	NSYTVR18	NSYRSW36	NSYRSWC36	
		400	1	NSYID188	NSYMP188	NSYVR18	NSYTVR18	NSYRSW36	NSYRSWC36	
		500	1	NSYID188	NSYMP188	NSYVR18	NSYTVR18	NSYRSW36	NSYRSWC36	
		600	1	NSYID188	NSYMP188	NSYVR18	NSYTVR18	NSYRSW36	NSYRSWC36	
1000		400	1	NSYID1810	NSYMP1810	NSYVR18	NSYTVR18	-	-	
		400	2	NSYID1810	NSYMP1810	NSYVR18	NSYTVR18	-	-	
		500	2	NSYID1810	NSYMP1810	NSYVR18	NSYTVR18	-	-	
1200		400	2	-	NSYMP1812	NSYVR18	NSYTVR18	-	-	
		500	2	-	NSYMP1812	NSYVR18	NSYTVR18	-	-	
1600		400	2	-	NSYMP1816	NSYVR18	NSYTVR18	-	-	
		500	2	-	NSYMP1816	NSYVR18	NSYTVR18	-	-	
2000		600	300	1	NSYID206	NSYMP206	NSYVR20	NSYTVR20	-	-
			400	1	NSYID206	NSYMP206	NSYVR20	NSYTVR20	-	-
			500	1	NSYID206	NSYMP206	NSYVR20	NSYTVR20	-	-
		800	300	1	NSYID208	NSYMP208	NSYVR20	NSYTVR20	NSYRSW40	NSYRSWC40
	400		1	NSYID208	NSYMP208	NSYVR20	NSYTVR20	NSYRSW40	NSYRSWC40	
	500		1	NSYID208	NSYMP208	NSYVR20	NSYTVR20	NSYRSW40	NSYRSWC40	
	600		1	NSYID208	NSYMP208	NSYVR20	NSYTVR20	NSYRSW40	NSYRSWC40	
	1000	400	2	NSYID2010	NSYMP2010	NSYVR20	NSYTVR20	-	-	
		500	2	NSYID2010	NSYMP2010	NSYVR20	NSYTVR20	-	-	
	1200	400	2	-	NSYMP2012	NSYVR20	NSYTVR20	-	-	
		500	2	-	NSYMP2012	NSYVR20	NSYTVR20	-	-	
		600	2	-	NSYMP2012	NSYVR20	NSYTVR20	-	-	
	1600	400	2	-	NSYMP2016	NSYVR20	NSYTVR20	-	-	
		500	2	-	NSYMP2016	NSYVR20	NSYTVR20	-	-	
		600	2	-	NSYMP2016	NSYVR20	NSYTVR20	-	-	

# Steel floor-standing enclosures

## Selection guide

SF

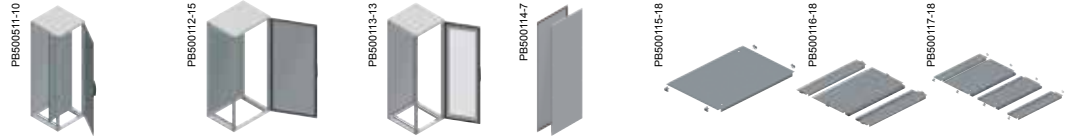

Nominal dimensions (mm)			No. of doors	Door			Side panels	Cable-entry plate		
Height (A)	Width (B)	Depth (C)		Plain	Transparent	Without mounting plate		Plain	1 entry	2 entries
				With mounting plate	Without mounting plate	Without mounting plate				
1200	600	400	1	NSYSF12640P	NSYSF12640	-	NSY2SP124	NSYEC64	NSYEC641	-
		600	1	NSYSF12660P	NSYSF12660	-	NSY2SP126	NSYEC66	NSYEC661	NSYEC662
	800	400	1	NSYSF12840P	NSYSF12840	-	NSY2SP124	NSYEC84	NSYEC841	-
1400	600	600	1	NSYSF12860P	NSYSF12860	-	NSY2SP126	NSYEC86	NSYEC861	NSYEC862
		400	1	NSYSF14640P	NSYSF14640	-	NSY2SP144	NSYEC64	NSYEC641	-
	800	400	1	NSYSF14840P	NSYSF14840	-	NSY2SP144	NSYEC84	NSYEC841	-
1600	600	600	1	NSYSF16660P	NSYSF16660	-	NSY2SP166	NSYEC66	NSYEC661	NSYEC662
		800	1	NSYSF16680P	NSYSF16680	-	NSY2SP168	NSYEC68	NSYEC681	NSYEC682
	800	600	1	NSYSF16860P	NSYSF16860	-	NSY2SP166	NSYEC86	NSYEC861	NSYEC862
1800	400	400	1	-	NSYSF18440	-	NSY2SP184	NSYEC44	NSYEC441	-
		500	1	-	NSYSF18450	-	NSY2SP185	NSYEC45	NSYEC451	-
		600	1	-	NSYSF18460	-	NSY2SP186	-	NSYEC461	-
	600	400	1	NSYSF18640P	NSYSF18640	NSYSF18640T	NSY2SP184	NSYEC64	NSYEC641	-
		500	1	NSYSF18650P	NSYSF18650	NSYSF18650T	NSY2SP185	NSYEC65	NSYEC651	-
		600	1	NSYSF18660P	NSYSF18660	-	NSY2SP186	NSYEC66	NSYEC661	NSYEC662
	800	400	1	-	-	NSYSF18680T	NSY2SP188	NSYEC68	NSYEC681	NSYEC682
		400	1	NSYSF18840P	NSYSF18840	NSYSF18840T	NSY2SP184	NSYEC84	NSYEC841	-
		500	1	NSYSF18850P	NSYSF18850	NSYSF18850T	NSY2SP185	NSYEC85	NSYEC851	-
	1000	600	2	NSYSF18860P	NSYSF18860	NSYSF18860T	NSY2SP186	NSYEC86	NSYEC861	NSYEC862
		600	2	NSYSF18860DP	NSYSF18860DP	-	NSY2SP186	NSYEC86	NSYEC861	NSYEC862
		400	1	NSYSF181040P	NSYSF181040	-	NSY2SP184	NSYEC104	NSYEC1041	-
1200	400	2	NSYSF181040DP	NSYSF181040DP	-	NSY2SP184	NSYEC104	NSYEC1041	-	
	500	1	NSYSF181050P	NSYSF181050	-	NSY2SP185	NSYEC105	NSYEC1051	-	
	600	1	NSYSF181060P	NSYSF181060	-	NSY2SP186	NSYEC106	NSYEC1061	NSYEC1062	
2000	300	600	2	NSYSF181060DP	NSYSF181060DP	-	NSY2SP186	NSYEC106	NSYEC1061	NSYEC1062
		400	2	NSYSF181240DP	NSYSF181240DP	-	NSY2SP184	NSYEC124	NSYEC1241	-
		500	2	NSYSF181250DP	NSYSF181250DP	-	NSY2SP185	NSYEC125	NSYEC1251	-
2200	400	600	2	NSYSF181260DP	NSYSF181260DP	-	NSY2SP186	NSYEC126	NSYEC1261	NSYEC1262
		500	1	-	NSYSF20350	-	NSY2SP205	NSYEC35	NSYEC351	-
		600	1	-	NSYSF20360	-	NSY2SP206	NSYEC36	NSYEC361	-
	600	800	1	-	NSYSF20380	-	NSY2SP208	-	NSYEC381	-
		400	1	-	NSYSF20440	-	NSY2SP204	NSYEC44	NSYEC441	-
		500	1	-	NSYSF20450	-	NSY2SP205	NSYEC45	NSYEC451	-
	800	600	1	-	NSYSF20460	-	NSY2SP206	NSYEC64	NSYEC641	-
		800	1	-	NSYSF20480	-	NSY2SP208	NSYEC84	NSYEC841	-
		400	1	NSYSF20640P	NSYSF20640	NSYSF20640T	NSY2SP204	NSYEC64	NSYEC641	-
	1000	500	1	NSYSF20650P	NSYSF20650	NSYSF20650T	NSY2SP205	NSYEC65	NSYEC651	-
		600	1	NSYSF20660P	NSYSF20660	-	NSY2SP206	NSYEC66	NSYEC661	NSYEC662
		800	1	NSYSF20680P	NSYSF20680	-	NSY2SP208	NSYEC68	NSYEC681	NSYEC682
1200	400	1	NSYSF20840P	NSYSF20840	NSYSF20840T	NSY2SP204	NSYEC84	NSYEC841	-	
	500	1	NSYSF20850P	NSYSF20850	NSYSF20850T	NSY2SP205	NSYEC85	NSYEC851	-	
	600	1	NSYSF20860P	NSYSF20860	NSYSF20860T	NSY2SP206	NSYEC86	NSYEC861	NSYEC862	
1400	600	2	NSYSF20860DP	NSYSF20860DP	-	NSY2SP206	NSYEC86	NSYEC861	NSYEC862	
	800	1	NSYSF20880P	NSYSF20880	NSYSF20880T	NSY2SP208	NSYEC88	NSYEC881	NSYEC882	
	400	1	NSYSF201040P	NSYSF201040	NSYSF201040T	NSY2SP204	NSYEC104	NSYEC1041	-	
1600	400	2	NSYSF201040DP	NSYSF201040DP	-	NSY2SP204	NSYEC104	NSYEC1041	-	
	500	1	NSYSF201050P	NSYSF201050	NSYSF201050T	NSY2SP205	NSYEC105	NSYEC1051	-	
	500	2	NSYSF201050DP	NSYSF201050DP	-	NSY2SP205	NSYEC105	NSYEC1051	-	
1800	600	1	NSYSF201060P	NSYSF201060	NSYSF201060T	NSY2SP206	NSYEC106	NSYEC1061	NSYEC1062	
	600	2	NSYSF201060DP	NSYSF201060DP	-	NSY2SP206	NSYEC106	NSYEC1061	NSYEC1062	
	800	1	NSYSF201080P	NSYSF201080	-	NSY2SP208	NSYEC108	NSYEC1081	NSYEC1082	
2000	400	2	NSYSF201240DP	NSYSF201240DP	-	NSY2SP204	NSYEC124	NSYEC1241	-	
	500	2	NSYSF201250DP	NSYSF201250DP	-	NSY2SP205	NSYEC125	NSYEC1251	-	
	600	2	NSYSF201260DP	NSYSF201260DP	-	NSY2SP206	NSYEC126	NSYEC1261	NSYEC1262	
2200	400	800	2	NSYSF201280DP	NSYSF201280DP	-	NSY2SP208	NSYEC128	NSYEC1281	NSYEC1282
		400	2	NSYSF201640DP	NSYSF201640DP	-	NSY2SP204	NSYEC164	NSYEC1641	-
		500	2	NSYSF201650DP	NSYSF201650DP	-	NSY2SP205	NSYEC165	NSYEC1651	-
2400	600	600	2	NSYSF201660DP	NSYSF201660DP	-	NSY2SP206	NSYEC166	NSYEC1661	NSYEC1662
		400	1	-	NSYSF22460	-	NSY2SP226	-	NSYEC461	-
		600	1	NSYSF22660P	NSYSF22660	-	NSY2SP226	NSYEC66	NSYEC661	NSYEC662
2600	800	800	1	NSYSF22680P	NSYSF22680	-	NSY2SP228	NSYEC68	NSYEC681	NSYEC682
		600	1	NSYSF22860P	NSYSF22860	-	NSY2SP226	NSYEC86	NSYEC861	NSYEC862
		800	1	NSYSF22880P	NSYSF22880	NSYSF22880T	NSY2SP228	NSYEC88	NSYEC881	NSYEC882
2800	1000	600	1	NSYSF221060P	NSYSF221060	-	NSY2SP226	NSYEC106	NSYEC1061	NSYEC1062
		600	2	NSYSF221260DP	NSYSF221260DP	-	NSY2SP226	NSYEC126	NSYEC1261	NSYEC1262
		800	2	NSYSF221280DP	NSYSF221280DP	-	NSY2SP228	NSYEC128	NSYEC1281	NSYEC1282

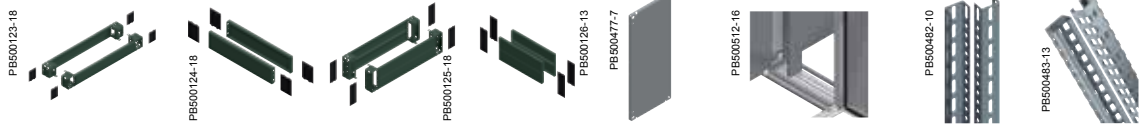

Nominal dimensions (mm)			Plinth				Mounting plate	Intermediate mounting plate	Vertical uprights		
Height (A)	Width (B)	Depth (C)	Height 100 mm		Height 200 mm				Standard	Technical	
			Front kit (corners + front panels)	Side panels, 2 u.	Front kit (corners + front panels)	Side panels, 4 u.					
1200	600	400	NSYSPPF6100	NSYSPPS4100	NSYSPPF6200	NSYSPPS4200	NSYMP126	NSYSIMP12	-	NSYTVR12	
		600	NSYSPPF6100	NSYSPPS6100	NSYSPPF6200	NSYSPPS6200	NSYMP126	NSYSIMP12	-	NSYTVR12	
		800	400	NSYSPPF8100	NSYSPPS4100	NSYSPPF8200	NSYSPPS4200	NSYMP128	NSYSIMP12	-	NSYTVR12
1400	600	400	NSYSPPF6100	NSYSPPS4100	NSYSPPF6200	NSYSPPS4200	NSYMP146	NSYSIMP14	-	NSYTVR14	
		800	400	NSYSPPF8100	NSYSPPS4100	NSYSPPF8200	NSYSPPS4200	NSYMP148	NSYSIMP14	-	NSYTVR14
1600	600	600	NSYSPPF6100	NSYSPPS6100	NSYSPPF6200	NSYSPPS6200	NSYMP166	NSYSIMP16	-	NSYTVR16	
		800	NSYSPPF6100	NSYSPPS8100	NSYSPPF6200	NSYSPPS8200	NSYMP166	NSYSIMP16	-	NSYTVR16	
		800	600	NSYSPPF8100	NSYSPPS6100	NSYSPPF8200	NSYSPPS6200	NSYMP168	NSYSIMP16	-	NSYTVR16
1800	400	400	NSYSPPF4100	NSYSPPS4100	NSYSPPF4200	NSYSPPS4200	-	-	-	NSYVVR18	NSYTVR18
		500	NSYSPPF4100	NSYSPPS5100	NSYSPPF4200	NSYSPPS5200	-	-	-	NSYVVR18	NSYTVR18
		600	NSYSPPF4100	NSYSPPS6100	NSYSPPF4200	NSYSPPS6200	-	-	-	NSYVVR18	NSYTVR18
		600	NSYSPPF6100	NSYSPPS4100	NSYSPPF6200	NSYSPPS4200	NSYMP186	NSYSIMP18	NSYVVR18	NSYTVR18	
		500	NSYSPPF6100	NSYSPPS5100	NSYSPPF6200	NSYSPPS5200	NSYMP186	NSYSIMP18	NSYVVR18	NSYTVR18	
		600	NSYSPPF6100	NSYSPPS6100	NSYSPPF6200	NSYSPPS6200	NSYMP186	NSYSIMP18	NSYVVR18	NSYTVR18	
	800	400	NSYSPPF6100	NSYSPPS8100	NSYSPPF6200	NSYSPPS8200	NSYMP186	NSYSIMP18	NSYVVR18	NSYTVR18	
		400	NSYSPPF8100	NSYSPPS4100	NSYSPPF8200	NSYSPPS4200	NSYMP188	NSYSIMP18	NSYVVR18	NSYTVR18	
		500	NSYSPPF8100	NSYSPPS5100	NSYSPPF8200	NSYSPPS5200	NSYMP188	NSYSIMP18	NSYVVR18	NSYTVR18	
		600	NSYSPPF8100	NSYSPPS6100	NSYSPPF8200	NSYSPPS6200	NSYMP188	NSYSIMP18	NSYVVR18	NSYTVR18	
		1000	400	NSYSPPF10100	NSYSPPS4100	NSYSPPF10200	NSYSPPS4200	NSYMP1810	NSYSIMP18	NSYVVR18	NSYTVR18
		400	NSYSPPF10100	NSYSPPS4100	NSYSPPF10200	NSYSPPS4200	NSYMP1810	NSYSIMP18	NSYVVR18	NSYTVR18	
1200	400	NSYSPPF10100	NSYSPPS5100	NSYSPPF10200	NSYSPPS5200	NSYMP1810	NSYSIMP18	NSYVVR18	NSYTVR18		
	500	NSYSPPF10100	NSYSPPS6100	NSYSPPF10200	NSYSPPS6200	NSYMP1810	NSYSIMP18	NSYVVR18	NSYTVR18		
	600	NSYSPPF10100	NSYSPPS6100	NSYSPPF10200	NSYSPPS6200	NSYMP1810	NSYSIMP18	NSYVVR18	NSYTVR18		
	600	NSYSPPF12100	NSYSPPS4100	NSYSPPF12200	NSYSPPS4200	NSYMP1812	NSYSIMP18	NSYVVR18	NSYTVR18		
	500	NSYSPPF12100	NSYSPPS5100	NSYSPPF12200	NSYSPPS5200	NSYMP1812	NSYSIMP18	NSYVVR18	NSYTVR18		
	600	NSYSPPF12100	NSYSPPS6100	NSYSPPF12200	NSYSPPS6200	NSYMP1812	NSYSIMP18	NSYVVR18	NSYTVR18		
2000	300	500	NSYSPPF3100	NSYSPPS5100	NSYSPPF3200	NSYSPPS5200	-	-	-	NSYVVR20	NSYTVR20
		600	NSYSPPF3100	NSYSPPS6100	NSYSPPF3200	NSYSPPS6200	-	-	-	NSYVVR20	NSYTVR20
		800	NSYSPPF3100	NSYSPPS8100	NSYSPPF3200	NSYSPPS8200	-	-	-	NSYVVR20	NSYTVR20
		400	NSYSPPF4100	NSYSPPS4100	NSYSPPF4200	NSYSPPS4200	-	-	-	NSYVVR20	NSYTVR20
		500	NSYSPPF4100	NSYSPPS5100	NSYSPPF4200	NSYSPPS5200	-	-	-	NSYVVR20	NSYTVR20
		600	NSYSPPF4100	NSYSPPS6100	NSYSPPF4200	NSYSPPS6200	-	-	-	NSYVVR20	NSYTVR20
	400	800	NSYSPPF4100	NSYSPPS8100	NSYSPPF4200	NSYSPPS8200	-	-	-	NSYVVR20	NSYTVR20
		600	400	NSYSPPF6100	NSYSPPS4100	NSYSPPF6200	NSYSPPS4200	NSYMP206	NSYSIMP20	NSYVVR20	NSYTVR20
		500	NSYSPPF6100	NSYSPPS5100	NSYSPPF6200	NSYSPPS5200	NSYMP206	NSYSIMP20	NSYVVR20	NSYTVR20	
		600	NSYSPPF6100	NSYSPPS6100	NSYSPPF6200	NSYSPPS6200	NSYMP206	NSYSIMP20	NSYVVR20	NSYTVR20	
		800	400	NSYSPPF8100	NSYSPPS4100	NSYSPPF8200	NSYSPPS4200	NSYMP208	NSYSIMP20	NSYVVR20	NSYTVR20
		500	NSYSPPF8100	NSYSPPS5100	NSYSPPF8200	NSYSPPS5200	NSYMP208	NSYSIMP20	NSYVVR20	NSYTVR20	
	800	600	NSYSPPF8100	NSYSPPS6100	NSYSPPF8200	NSYSPPS6200	NSYMP208	NSYSIMP20	NSYVVR20	NSYTVR20	
		600	NSYSPPF8100	NSYSPPS8100	NSYSPPF8200	NSYSPPS8200	NSYMP208	NSYSIMP20	NSYVVR20	NSYTVR20	
		1000	400	NSYSPPF10100	NSYSPPS4100	NSYSPPF10200	NSYSPPS4200	NSYMP2010	NSYSIMP20	NSYVVR20	NSYTVR20
		400	NSYSPPF10100	NSYSPPS4100	NSYSPPF10200	NSYSPPS4200	NSYMP2010	NSYSIMP20	NSYVVR20	NSYTVR20	
		500	NSYSPPF10100	NSYSPPS5100	NSYSPPF10200	NSYSPPS5200	NSYMP2010	NSYSIMP20	NSYVVR20	NSYTVR20	
		500	NSYSPPF10100	NSYSPPS6100	NSYSPPF10200	NSYSPPS6200	NSYMP2010	NSYSIMP20	NSYVVR20	NSYTVR20	
	1200	600	NSYSPPF10100	NSYSPPS6100	NSYSPPF10200	NSYSPPS6200	NSYMP2010	NSYSIMP20	NSYVVR20	NSYTVR20	
		800	NSYSPPF10100	NSYSPPS8100	NSYSPPF10200	NSYSPPS8200	NSYMP2010	NSYSIMP20	NSYVVR20	NSYTVR20	
		400	NSYSPPF12100	NSYSPPS4100	NSYSPPF12200	NSYSPPS4200	NSYMP2012	NSYSIMP20	NSYVVR20	NSYTVR20	
		500	NSYSPPF12100	NSYSPPS5100	NSYSPPF12200	NSYSPPS5200	NSYMP2012	NSYSIMP20	NSYVVR20	NSYTVR20	
		600	NSYSPPF12100	NSYSPPS6100	NSYSPPF12200	NSYSPPS6200	NSYMP2012	NSYSIMP20	NSYVVR20	NSYTVR20	
		800	NSYSPPF12100	NSYSPPS8100	NSYSPPF12200	NSYSPPS8200	NSYMP2012	NSYSIMP20	NSYVVR20	NSYTVR20	
1600	400	NSYSPPF16100	NSYSPPS4100	NSYSPPF16200	NSYSPPS4200	NSYMP2016	NSYSIMP20	NSYVVR20	NSYTVR20		
	500	NSYSPPF16100	NSYSPPS5100	NSYSPPF16200	NSYSPPS5200	NSYMP2016	NSYSIMP20	NSYVVR20	NSYTVR20		
	600	NSYSPPF16100	NSYSPPS6100	NSYSPPF16200	NSYSPPS6200	NSYMP2016	NSYSIMP20	NSYVVR20	NSYTVR20		
	600	NSYSPPF4100	NSYSPPS6100	NSYSPPF4200	NSYSPPS6200	-	-	-	NSYVVR22	NSYTVR22	
2200	400	600	NSYSPPF6100	NSYSPPS6100	NSYSPPF6200	NSYSPPS6200	NSYMP226	NSYSIMP22	NSYVVR22	NSYTVR22	
		600	NSYSPPF6100	NSYSPPS8100	NSYSPPF6200	NSYSPPS8200	NSYMP226	NSYSIMP22	NSYVVR22	NSYTVR22	
		800	600	NSYSPPF8100	NSYSPPS6100	NSYSPPF8200	NSYSPPS6200	NSYMP228	NSYSIMP22	NSYVVR22	NSYTVR22
	800	800	NSYSPPF8100	NSYSPPS8100	NSYSPPF8200	NSYSPPS8200	NSYMP228	NSYSIMP22	NSYVVR22	NSYTVR22	
		1000	600	NSYSPPF10100	NSYSPPS6100	NSYSPPF10200	NSYSPPS6200	NSYMP2210	NSYSIMP22	NSYVVR22	NSYTVR22
		1200	600	NSYSPPF12100	NSYSPPS6100	NSYSPPF12200	NSYSPPS6200	NSYMP2212	NSYSIMP22	NSYVVR22	NSYTVR22
	800	800	NSYSPPF12100	NSYSPPS8100	NSYSPPF12200	NSYSPPS8200	NSYMP2212	NSYSIMP22	NSYVVR22	NSYTVR22	

# Steel floor-standing enclosures

## Selection guide

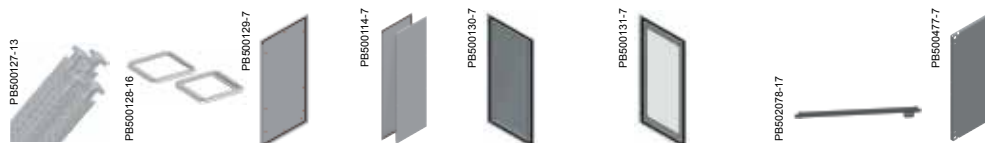

Nominal dimensions (mm)			No. of doors	Vertical uprights	Bottom frame and top frame with roof	Rear panel	Side panels	Plain door (1)	Transparent door (Securit® glass) (1)	Door Trim plate	Mounting plate	
Height (A)	Width (B)	Depth (C)										
1200	600	400	1	NSYSFV12	NSYSFC64	NSYBP126	NSY2SP124	NSYSFD126	NSYSFD126T	NSYTRIM6SF	NSYMP126	
		500	1	NSYSFV12	NSYSFC65	NSYBP126	NSY2SP125	NSYSFD126	NSYSFD126T	NSYTRIM6SF	NSYMP126	
		600	1	NSYSFV12	NSYSFC66	NSYBP126	NSY2SP126	NSYSFD126	NSYSFD126T	NSYTRIM6SF	NSYMP126	
		800	1	NSYSFV12	NSYSFC68	NSYBP126	NSY2SP128	NSYSFD126	NSYSFD126T	NSYTRIM6SF	NSYMP126	
	800	400	1	NSYSFV12	NSYSFC84	NSYBP128	NSY2SP124	NSYSFD128	NSYSFD128T	NSYTRIM8SF	NSYMP128	
		500	1	NSYSFV12	NSYSFC85	NSYBP128	NSY2SP125	NSYSFD128	NSYSFD128T	NSYTRIM8SF	NSYMP128	
		600	1	NSYSFV12	NSYSFC86	NSYBP128	NSY2SP126	NSYSFD128	NSYSFD128T	NSYTRIM8SF	NSYMP128	
		800	1	NSYSFV12	NSYSFC88	NSYBP128	NSY2SP128	NSYSFD128	NSYSFD128T	NSYTRIM8SF	NSYMP128	
	1400	600	400	1	NSYSFV14	NSYSFC64	NSYBP146	NSY2SP144	NSYSFD146	NSYSFD146T	NSYTRIM6SF	NSYMP146
			500	1	NSYSFV14	NSYSFC65	NSYBP146	NSY2SP145	NSYSFD146	NSYSFD146T	NSYTRIM6SF	NSYMP146
			600	1	NSYSFV14	NSYSFC66	NSYBP146	NSY2SP146	NSYSFD146	NSYSFD146T	NSYTRIM6SF	NSYMP146
			800	1	NSYSFV14	NSYSFC68	NSYBP146	NSY2SP148	NSYSFD146	NSYSFD146T	NSYTRIM6SF	NSYMP146
800		400	1	NSYSFV14	NSYSFC84	NSYBP148	NSY2SP144	NSYSFD148	NSYSFD148T	NSYTRIM8SF	NSYMP148	
		500	1	NSYSFV14	NSYSFC85	NSYBP148	NSY2SP145	NSYSFD148	NSYSFD148T	NSYTRIM8SF	NSYMP148	
		600	1	NSYSFV14	NSYSFC86	NSYBP148	NSY2SP146	NSYSFD148	NSYSFD148T	NSYTRIM8SF	NSYMP148	
		800	1	NSYSFV14	NSYSFC88	NSYBP148	NSY2SP148	NSYSFD148	NSYSFD148T	NSYTRIM8SF	NSYMP148	
1600	600	400	1	NSYSFV16	NSYSFC64	NSYBP166	NSY2SP164	NSYSFD166	NSYSFD166T	NSYTRIM6SF	NSYMP166	
		500	1	NSYSFV16	NSYSFC65	NSYBP166	NSY2SP165	NSYSFD166	NSYSFD166T	NSYTRIM6SF	NSYMP166	
		600	1	NSYSFV16	NSYSFC66	NSYBP166	NSY2SP166	NSYSFD166	NSYSFD166T	NSYTRIM6SF	NSYMP166	
		800	1	NSYSFV16	NSYSFC68	NSYBP166	NSY2SP168	NSYSFD166	NSYSFD166T	NSYTRIM6SF	NSYMP166	
	800	400	1	NSYSFV16	NSYSFC84	NSYBP168	NSY2SP164	NSYSFD168	NSYSFD168T	NSYTRIM8SF	NSYMP168	
		500	1	NSYSFV16	NSYSFC85	NSYBP168	NSY2SP165	NSYSFD168	NSYSFD168T	NSYTRIM8SF	NSYMP168	
		600	1	NSYSFV16	NSYSFC86	NSYBP168	NSY2SP166	NSYSFD168	NSYSFD168T	NSYTRIM8SF	NSYMP168	
		800	1	NSYSFV16	NSYSFC88	NSYBP168	NSY2SP168	NSYSFD168	NSYSFD168T	NSYTRIM8SF	NSYMP168	
	1800	400	400	1	NSYSFV18	NSYSFC44	NSYBP184	NSY2SP184	NSYSFD184	-	NSYTRIM4SF	-
			500	1	NSYSFV18	NSYSFC45	NSYBP184	NSY2SP185	NSYSFD184	-	NSYTRIM4SF	-
			600	1	NSYSFV18	NSYSFC46	NSYBP184	NSY2SP186	NSYSFD184	-	NSYTRIM4SF	-
			800	1	NSYSFV18	NSYSFC48	NSYBP184	NSY2SP188	NSYSFD184	-	NSYTRIM4SF	-
600		400	1	NSYSFV18	NSYSFC64	NSYBP186	NSY2SP184	NSYSFD186	NSYSFD186T	NSYTRIM6SF	NSYMP186	
		500	1	NSYSFV18	NSYSFC65	NSYBP186	NSY2SP185	NSYSFD186	NSYSFD186T	NSYTRIM6SF	NSYMP186	
		600	1	NSYSFV18	NSYSFC66	NSYBP186	NSY2SP186	NSYSFD186	NSYSFD186T	NSYTRIM6SF	NSYMP186	
		800	1	NSYSFV18	NSYSFC68	NSYBP186	NSY2SP188	NSYSFD186	NSYSFD186T	NSYTRIM6SF	NSYMP186	
		800	400	1	NSYSFV18	NSYSFC84	NSYBP188	NSY2SP184	NSYSFD188	NSYSFD188T	NSYTRIM8SF	NSYMP188
			500	1	NSYSFV18	NSYSFC85	NSYBP188	NSY2SP185	NSYSFD188	NSYSFD188T	NSYTRIM8SF	NSYMP188
			600	1	NSYSFV18	NSYSFC86	NSYBP188	NSY2SP186	NSYSFD188	NSYSFD188T	NSYTRIM8SF	NSYMP188
			800	2	NSYSFV18	NSYSFC86	NSYBP188	NSY2SP186	NSYSFD1882D	-	NSYTRIM8SF2D	NSYMP188
1000		400	1	NSYSFV18	NSYSFC88	NSYBP188	NSY2SP188	NSYSFD188	NSYSFD188T	NSYTRIM8SF	NSYMP188	
		800	2	NSYSFV18	NSYSFC88	NSYBP188	NSY2SP188	NSYSFD1882D	-	NSYTRIM8SF2D	NSYMP188	
		400	1	NSYSFV18	NSYSFC104	NSYBP1810	NSY2SP184	NSYSFD1810	NSYSFD1810T	NSYTRIM10SF	NSYMP1810	
		400	2	NSYSFV18	NSYSFC104	NSYBP1810	NSY2SP184	NSYSFD18102D	-	NSYTRIM10SF2D	NSYMP1810	
1200		500	1	NSYSFV18	NSYSFC105	NSYBP1810	NSY2SP185	NSYSFD1810	NSYSFD1810T	NSYTRIM10SF	NSYMP1810	
		600	1	NSYSFV18	NSYSFC106	NSYBP1810	NSY2SP186	NSYSFD1810	NSYSFD1810T	NSYTRIM10SF	NSYMP1810	
		600	2	NSYSFV18	NSYSFC106	NSYBP1810	NSY2SP186	NSYSFD18102D	-	NSYTRIM10SF2D	NSYMP1810	
		800	1	NSYSFV18	NSYSFC108	NSYBP1810	NSY2SP188	NSYSFD1810	NSYSFD1810T	NSYTRIM10SF	NSYMP1810	
	800	2	NSYSFV18	NSYSFC108	NSYBP1810	NSY2SP188	NSYSFD18102D	-	NSYTRIM10SF2D	NSYMP1810		
	400	2	NSYSFV18	NSYSFC124	NSYBP1812	NSY2SP184	NSYSFD18122D	NSYSFD18122DT	NSYTRIM12SF2D	NSYMP1812		
	500	2	NSYSFV18	NSYSFC125	NSYBP1812	NSY2SP185	NSYSFD18122D	NSYSFD18122DT	NSYTRIM12SF2D	NSYMP1812		
	600	2	NSYSFV18	NSYSFC126	NSYBP1812	NSY2SP186	NSYSFD18122D	NSYSFD18122DT	NSYTRIM12SF2D	NSYMP1812		
800	2	NSYSFV18	NSYSFC128	NSYBP1812	NSY2SP188	NSYSFD18122D	NSYSFD18122DT	NSYTRIM12SF2D	NSYMP1812			

(1) Hinges, locking bar catches and handle with 5-mm double-bar insert included.

# Steel floor-standing enclosures

## Selection guide

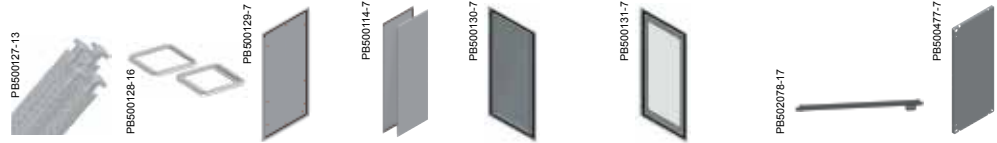

Nominal dimensions (mm)			No. of doors	Vertical uprights	Bottom frame and top frame with roof	Rear panel	Side panels	Plain door (1)	Transparent door (Securit® glass) (1)	Door Trim plate	Mounting plate		
Height (A)	Width (B)	Depth (C)											
2000	300	500	1	NSYSFV20	NSYSFC35	NSYBP203	NSY2SP205	NSYSFD203	-	NSYTRIM3SF	-		
		600	1	NSYSFV20	NSYSFC36	NSYBP203	NSY2SP206	NSYSFD203	-	NSYTRIM3SF	-		
		400	400	1	NSYSFV20	NSYSFC44	NSYBP204	NSY2SP204	NSYSFD204	-	NSYTRIM4SF	-	
			500	1	NSYSFV20	NSYSFC45	NSYBP204	NSY2SP205	NSYSFD204	-	NSYTRIM4SF	-	
	600	400	600	1	NSYSFV20	NSYSFC46	NSYBP204	NSY2SP206	NSYSFD204	-	NSYTRIM4SF	-	
			800	1	NSYSFV20	NSYSFC48	NSYBP204	NSY2SP208	NSYSFD204	-	NSYTRIM4SF	-	
		500	400	1	NSYSFV20	NSYSFC64	NSYBP206	NSY2SP204	NSYSFD206	NSYSFD206T	NSYTRIM6SF	NSYMP206	
			600	1	NSYSFV20	NSYSFC65	NSYBP206	NSY2SP205	NSYSFD206	NSYSFD206T	NSYTRIM6SF	NSYMP206	
	800	600	600	1	NSYSFV20	NSYSFC66	NSYBP206	NSY2SP206	NSYSFD206	NSYSFD206T	NSYTRIM6SF	NSYMP206	
			800	1	NSYSFV20	NSYSFC68	NSYBP206	NSY2SP208	NSYSFD206	NSYSFD206T	NSYTRIM6SF	NSYMP206	
		400	400	1	NSYSFV20	NSYSFC84	NSYBP208	NSY2SP204	NSYSFD208	NSYSFD208T	NSYTRIM8SF	NSYMP208	
			500	1	NSYSFV20	NSYSFC85	NSYBP208	NSY2SP205	NSYSFD208	NSYSFD208T	NSYTRIM8SF	NSYMP208	
	1000	600	600	1	NSYSFV20	NSYSFC86	NSYBP208	NSY2SP206	NSYSFD208	NSYSFD208T	NSYTRIM8SF	NSYMP208	
			800	2	NSYSFV20	NSYSFC86	NSYBP208	NSY2SP206	NSYSFD2082D	-	NSYTRIM8SF2D	NSYMP208	
		800	800	1	NSYSFV20	NSYSFC88	NSYBP208	NSY2SP208	NSYSFD208	NSYSFD208T	NSYTRIM8SF	NSYMP208	
			800	2	NSYSFV20	NSYSFC88	NSYBP208	NSY2SP208	NSYSFD2082D	-	NSYTRIM8SF2D	NSYMP208	
	1200	400	400	1	NSYSFV20	NSYSFC104	NSYBP2010	NSY2SP204	NSYSFD2010	NSYSFD2010T	NSYTRIM10SF	NSYMP2010	
			400	2	NSYSFV20	NSYSFC104	NSYBP2010	NSY2SP204	NSYSFD20102D	-	NSYTRIM10SF2D	NSYMP2010	
		500	400	1	NSYSFV20	NSYSFC105	NSYBP2010	NSY2SP205	NSYSFD2010	NSYSFD2010T	NSYTRIM10SF	NSYMP2010	
			500	2	NSYSFV20	NSYSFC105	NSYBP2010	NSY2SP205	NSYSFD20102D	-	NSYTRIM10SF2D	NSYMP2010	
		600	400	600	1	NSYSFV20	NSYSFC106	NSYBP2010	NSY2SP206	NSYSFD2010	NSYSFD2010T	NSYTRIM10SF	NSYMP2010
				600	2	NSYSFV20	NSYSFC106	NSYBP2010	NSY2SP206	NSYSFD20102D	-	NSYTRIM10SF2D	NSYMP2010
			800	400	1	NSYSFV20	NSYSFC108	NSYBP2010	NSY2SP208	NSYSFD2010	NSYSFD2010T	NSYTRIM10SF	NSYMP2010
				800	2	NSYSFV20	NSYSFC108	NSYBP2010	NSY2SP208	NSYSFD20102D	-	NSYTRIM10SF2D	NSYMP2010
1600		400	400	2	NSYSFV20	NSYSFC124	NSYBP2012	NSY2SP204	NSYSFD20122D	NSYSFD20122DT	NSYTRIM12SF2D	NSYMP2012	
			500	2	NSYSFV20	NSYSFC125	NSYBP2012	NSY2SP205	NSYSFD20122D	NSYSFD20122DT	NSYTRIM12SF2D	NSYMP2012	
		600	400	2	NSYSFV20	NSYSFC126	NSYBP2012	NSY2SP206	NSYSFD20122D	NSYSFD20122DT	NSYTRIM12SF2D	NSYMP2012	
			800	2	NSYSFV20	NSYSFC128	NSYBP2012	NSY2SP208	NSYSFD20122D	NSYSFD20122DT	NSYTRIM12SF2D	NSYMP2012	
2200	400	400	2	NSYSFV20	NSYSFC164	NSYBP2016	NSY2SP204	NSYSFD20162D	-	NSYTRIM16SF2D	NSYMP2016		
		500	2	NSYSFV20	NSYSFC165	NSYBP2016	NSY2SP205	NSYSFD20162D	-	NSYTRIM16SF2D	NSYMP2016		
		600	2	NSYSFV20	NSYSFC166	NSYBP2016	NSY2SP206	NSYSFD20162D	-	NSYTRIM16SF2D	NSYMP2016		
		400	1	NSYSFV22	NSYSFC44	NSYBP224	NSY2SP224	NSYSFD224	-	NSYTRIM4SF	-		
	600	500	500	1	NSYSFV22	NSYSFC45	NSYBP224	NSY2SP225	NSYSFD224	-	NSYTRIM4SF	-	
			600	1	NSYSFV22	NSYSFC46	NSYBP224	NSY2SP226	NSYSFD224	-	NSYTRIM4SF	-	
		800	400	1	NSYSFV22	NSYSFC48	NSYBP224	NSY2SP228	NSYSFD224	-	NSYTRIM4SF	-	
			400	1	NSYSFV22	NSYSFC64	NSYBP226	NSY2SP224	NSYSFD226	NSYSFD226T	NSYTRIM6SF	NSYMP226	
	800	500	500	1	NSYSFV22	NSYSFC65	NSYBP226	NSY2SP225	NSYSFD226	NSYSFD226T	NSYTRIM6SF	NSYMP226	
			600	1	NSYSFV22	NSYSFC66	NSYBP226	NSY2SP226	NSYSFD226	NSYSFD226T	NSYTRIM6SF	NSYMP226	
		800	400	1	NSYSFV22	NSYSFC68	NSYBP226	NSY2SP228	NSYSFD226	NSYSFD226T	NSYTRIM6SF	NSYMP226	
			400	1	NSYSFV22	NSYSFC84	NSYBP228	NSY2SP224	NSYSFD228	NSYSFD228T	NSYTRIM8SF	NSYMP228	
1000	500	500	1	NSYSFV22	NSYSFC85	NSYBP228	NSY2SP225	NSYSFD228	NSYSFD228T	NSYTRIM8SF	NSYMP228		
		600	1	NSYSFV22	NSYSFC86	NSYBP228	NSY2SP226	NSYSFD228	NSYSFD228T	NSYTRIM8SF	NSYMP228		
	800	400	1	NSYSFV22	NSYSFC88	NSYBP228	NSY2SP228	NSYSFD228	NSYSFD228T	NSYTRIM8SF	NSYMP228		
		400	1	NSYSFV22	NSYSFC104	NSYBP2210	NSY2SP224	NSYSFD2210	NSYSFD2210T	NSYTRIM10SF	NSYMP2210		
1200	500	500	1	NSYSFV22	NSYSFC105	NSYBP2210	NSY2SP225	NSYSFD2210	NSYSFD2210T	NSYTRIM10SF	NSYMP2210		
		600	1	NSYSFV22	NSYSFC106	NSYBP2210	NSY2SP226	NSYSFD2210	NSYSFD2210T	NSYTRIM10SF	NSYMP2210		
	800	400	1	NSYSFV22	NSYSFC108	NSYBP2210	NSY2SP228	NSYSFD2210	NSYSFD2210T	NSYTRIM10SF	NSYMP2210		
		400	2	NSYSFV22	NSYSFC124	NSYBP2212	NSY2SP224	NSYSFD22122D	NSYSFD22122DT	NSYTRIM12SF2D	NSYMP2212		
1600	500	500	2	NSYSFV22	NSYSFC125	NSYBP2212	NSY2SP225	NSYSFD22122D	NSYSFD22122DT	NSYTRIM12SF2D	NSYMP2212		
		600	2	NSYSFV22	NSYSFC126	NSYBP2212	NSY2SP226	NSYSFD22122D	NSYSFD22122DT	NSYTRIM12SF2D	NSYMP2212		
	800	400	2	NSYSFV22	NSYSFC128	NSYBP2212	NSY2SP228	NSYSFD22122D	NSYSFD22122DT	NSYTRIM12SF2D	NSYMP2212		
		400	2	NSYSFV22	NSYSFC128	NSYBP2212	NSY2SP228	NSYSFD22122D	NSYSFD22122DT	NSYTRIM12SF2D	NSYMP2212		

(1) Hinges, locking bar catches and handle with 5-mm double-bar insert included.

PB502427-57



### Composition accessories

#### Panels



Page 124

#### Coupling accessories



Page 126

#### Roofs



Page 138

#### Wall-mounting



Page 140

#### Floor



Page 128

#### Cable entry



Page 134

#### Lifting systems

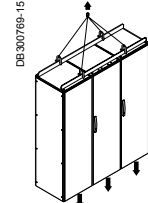

Page 136

#### Doors



Page 141

#### Locking systems



Page 144



### Installation accessories



#### Mounting acc.



Page 242

#### Telequick system

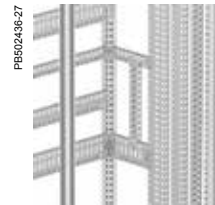

Page 252

### Power distribution



#### Busbar supports

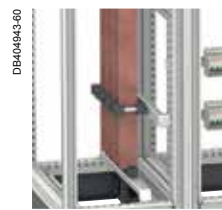

Page 256

PB502439-95



### Cable management

#### Cable holding



Page 270

#### Cable ducting

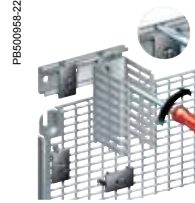

Page 289

### Thermal management

#### Heaters



Page 452

#### Ventilation



Page 406

#### Cooling units



Page 435

### Others

#### Door accessories

PBE020559-25



Page 297

#### Lighting

PBE01707-28



Page 292

#### Earthing

PBE000217-29



Page 302

### Panels



Characteristics		Side door	External mounting	Internal mounting
		Door for the side of the enclosure, replaces the side panel. Installation directly on the structure of the enclosure, opening 120°. Lock with handle and 5-mm double-bar insert. 4 locking points. Reinforcement frame, cut-out with a pitch of 25 mm. Opening to right or left.	Set of 2 side panels fixed from the outside of the enclosure.	Set of 2 side panels fixed from the enclosure, preventing access by unauthorized persons. Very useful in public spaces.
Material		Steel	Steel	Steel
Finish		Painted with epoxy-polyester resin	Painted with epoxy-polyester resin	Painted with epoxy-polyester resin
Colour		RAL 7035 grey	RAL 7035 grey	RAL 7035 grey
Supply		One side door, four hinges, four catches and handle lock	2 side panels and mounting elements	2 side panels, with sealing gasket and bag of accessories
Height (mm)	Depth (mm)	References		
1200	400	-	NSY2SP124	-
	500	-	NSY2SP125	NSY2SPI126
	600	NSYSFD126	NSY2SP126	-
	800	NSYSFD128	NSY2SP128	-
1400	400	-	NSY2SP144	-
	500	-	NSY2SP145	-
	600	NSYSFD146	NSY2SP146	-
	800	NSYSFD148	NSY2SP148	-
1600	400	-	NSY2SP164	-
	500	-	NSY2SP165	-
	600	NSYSFD166	NSY2SP166	-
	800	NSYSFD168	NSY2SP168	-
1800	400	NSYSFD184	NSY2SP184	-
	500	NSYSFD185	NSY2SP185	NSY2SPI185
	600	NSYSFD186	NSY2SP186	NSY2SPI186
	800	NSYSFD188	NSY2SP188	NSY2SPI188
	1000	-	-	-
2000	400	NSYSFD204	NSY2SP204	NSY2SPI204
	500	NSYSFD205	NSY2SP205	NSY2SPI205
	600	NSYSFD206	NSY2SP206	NSY2SPI206
	800	NSYSFD208	NSY2SP208	NSY2SPI208
	1000	-	-	-
	1200	-	-	-
2200	400	NSYSFD224	NSY2SP224	-
	500	NSYSFD225	NSY2SP225	-
	600	NSYSFD226	NSY2SP226	NSY2SPI226
	800	NSYSFD228	NSY2SP228	NSY2SPI228
	1000	-	-	-

### Panels

SF



SF



SF



SF



Quick-mounting side panels	Internal mounting rear panel	Partition panel
Set of 2 side panels fixed to the outside of the enclosure by clipping locks. No sealing gasket.	Rear panel fixed from the inside of the enclosure, preventing unauthorized personnel from accessing and removing it. Normally used in public spaces.	Partition panel for direct mounting to the structure, guarantees a water/dustproof protection of IP10 between enclosure suites.
Steel	Steel	Galvanised steel
Painted with epoxy-polyester resin	Painted with epoxy-polyester resin	-
RAL 7035 grey	RAL 7035 grey	RAL 7035 grey
2 side panels and mounting elements	1 rear panel and mounting elements	1 partition panel, sealing gasket and mounting elements
-	-	-
-	-	-
<b>NSY2SPQ126</b>	<b>NSYBPI126</b>	-
<b>NSY2SPQ128</b>	-	-
-	-	-
-	-	-
<b>NSY2SPQ146</b>	-	-
<b>NSY2SPQ148</b>	-	-
-	-	-
-	-	-
<b>NSY2SPQ166</b>	<b>NSYBPI166</b>	<b>NSYPPS166</b>
<b>NSY2SPQ168</b>	<b>NSYBPI168</b>	<b>NSYPPS168</b>
-	-	<b>NSYPPS184</b>
-	-	<b>NSYPPS185</b>
<b>NSY2SPQ186</b>	<b>NSYBPI186</b>	<b>NSYPPS186</b>
<b>NSY2SPQ188</b>	<b>NSYBPI188</b>	-
-	<b>NSYBPI1810</b>	-
-	<b>NSYBPI204</b>	<b>NSYPPS204</b>
-	-	<b>NSYPPS205</b>
<b>NSY2SPQ206</b>	<b>NSYBPI206</b>	<b>NSYPPS206</b>
<b>NSY2SPQ208</b>	<b>NSYBPI208</b>	<b>NSYPPS208</b>
-	<b>NSYBPI2010</b>	-
-	<b>NSYBPI2012</b>	-
-	-	-
-	-	-
<b>NSY2SPQ226</b>	<b>NSYBPI226</b>	<b>NSYPPS226</b>
<b>NSY2SPQ228</b>	<b>NSYBPI228</b>	<b>NSYPPS228</b>
-	<b>NSYBPI2210</b>	-

#### Trim cap

Trim cap for external mounting panels, both sides and rear.

Polyamide 6



RAL 7035 grey  
50 units

#### Reference

**NSYCSP**

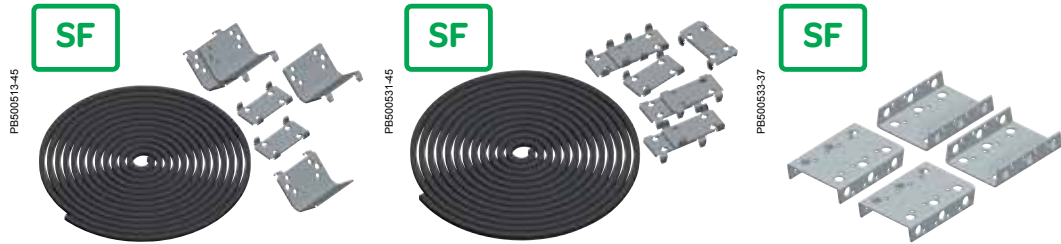

### Coupling accessories

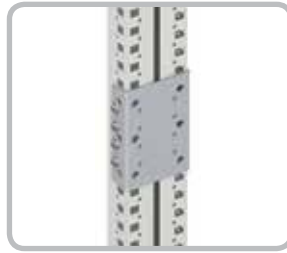

Characteristics	Standard coupling Kit	Swing 19" rack coupling Kit	Reinforced coupling
	 <p>Used for joining enclosures side-to-side or depthwise. Mounting from the inside of the enclosure.</p>	 <p>Used for joining enclosures equipped with swing 19" rack, side-to-side or depthwise. Mounting from the inside of the enclosures.</p>	 <p>It is used together with the coupling kit to reinforce the connection between 2 enclosures when they carry heavy loads. Mounting from the inside of the enclosures.</p>
Material	<ul style="list-style-type: none"> <li>Flat connectors and brackets: zinc-coated steel</li> <li>Sealing gasket: EPDM</li> </ul>	<ul style="list-style-type: none"> <li>Flat connectors: zinc-coated steel</li> <li>Sealing gasket: EPDM</li> </ul>	Zinc-coated steel
Supply	4 brackets, 2 flat connectors, sealing gasket and mounting elements	8 flat connectors, sealing gasket and mounting elements	4 reinforced connectors and mounting elements
References	<b>NSYSFBK</b>	<b>NSYSFBK19</b>	<b>NSYSFBKR</b>

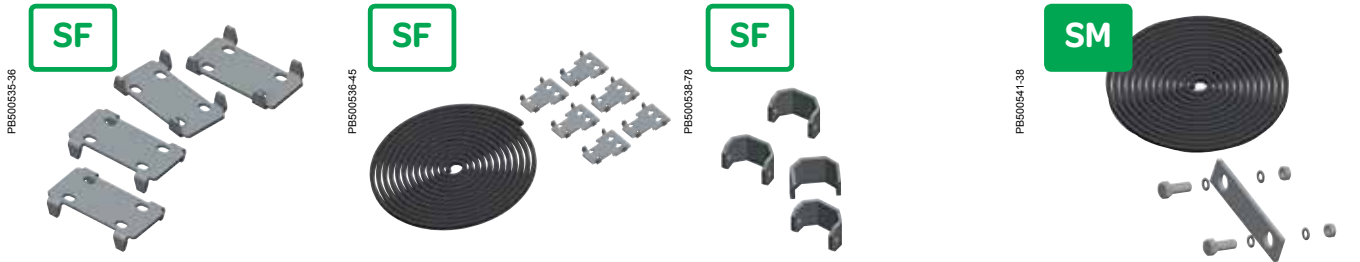
## Coupling accessories

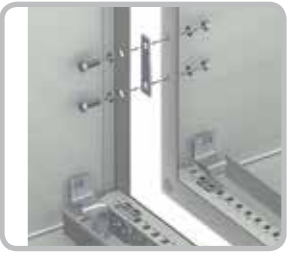

	Quick coupling	Kit for coupling the previous version with Spacial SF	External coupling	Enclosure coupling Kit for Spacial SM
 <p>PB5002553-53</p> <p>Used for quickly joining 2 enclosures. Mounting from the inside of the enclosures.</p>	 <p>PB5002568-40</p> <p>It is used for coupling an enclosure of a previous version (OLN or Spacial 6000) side-to-side or depthwise with a Spacial SF enclosure. Mounting from the inside of the enclosures.</p>	 <p>PB5002555-49</p> <ul style="list-style-type: none"> <li>■ Allows two enclosures to be joined by their structure.</li> <li>■ To be used with the standard coupling kit in those cases where front and back uprights are not accesibles.</li> <li>■ The mounting plate or vertical uprights fixed to the back of the enclosure prevent the assembly and dismantling of the kit.</li> <li>■ It can be combined with the reinforced or the quick coupling kit.</li> </ul>	 <p>PB5002566-35</p> <ul style="list-style-type: none"> <li>■ Used for joining enclosures side-to-side.</li> <li>■ Enclosures fixed from the inside.</li> </ul>	
Zinc-coated steel	<ul style="list-style-type: none"> <li>■ Flat connectors and spacers: zinc-coated steel</li> <li>■ Sealing gasket: EPDM</li> </ul>	<ul style="list-style-type: none"> <li>■ External connectors: zinc-coated steel</li> <li>■ Sealing gasket: EPDM</li> </ul>	9 x 11 sealing gasket: EPDM	
4 flat links and mounting elements	6 flat connectors, sealing gasket and mounting elements	4 external connectors and mounting elements	1 sealing gasket and mounting elements	
<b>NSYSFBKF</b>	<b>NSYSFBKSH</b>	<b>NSYSFBKE</b>	<b>NSYSMBK</b>	

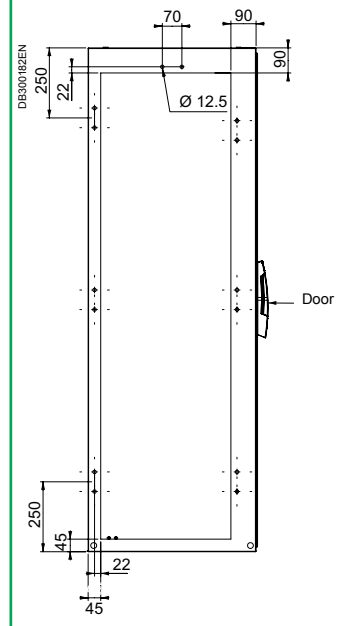

### Floor

#### Plinth in kit form

##### Front and rear kit

##### Side panels

##### Complete plinth

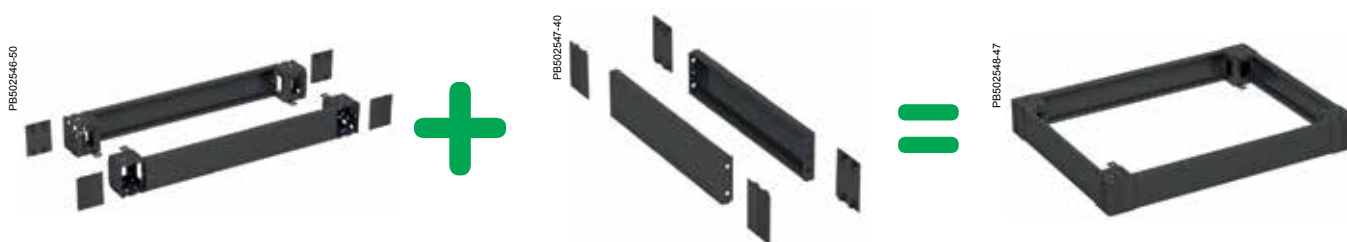

Plinth height 100 mm



Plinth height 200 mm

The complete plinth consists of two elements, one is the front and rear kit, determined by the length of the enclosure, and the other consists of the side panels, which determine the depth of the enclosure. The number of side panels required is decided according to the desired plinth combination.

- ⊕ Robust design.
- ⊕ The modular plinth system makes it possible to reduce the number of references in stock.



## Floor

### Possibility of joining plinths



**1 - The surfaces between corners are always in contact.**  
They are joined by an M8 screw and nut, not included in the standard supply.

- + Longitudinally free space for passing cables.
- + Greater rigidity of the resultant assembly unit.

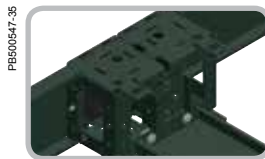

**2 - By side panels, the M6 screws and caged nuts, not included in the standard supply, reference NSYSPM6 and reference NSYCN9M625, which can be mounted above and/or below.**

- + Improves rigidity in the depthwise direction during transport.

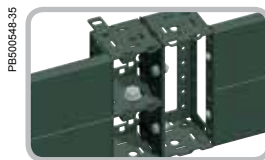

**3 - Vertical plinth assembly** by means of M12 screws and nuts, not included in the standard supply.

- + The two heights of corners can be combined.

### Possibility of mounting the enclosure to the plinth



**1 - Mounting from the inside of the enclosure by means of an M12 screw, screwing directly into the corner of the plinth.**

- + Mounting convenience and speed.



**2 - Mounting from the outside of the enclosure with a M12 screw, screwing directly onto the vertical upright.**

- + Maximum rigidity of the enclosure-plinth assembly.

## Floor

### Possibility of mounting the plinth to the floor

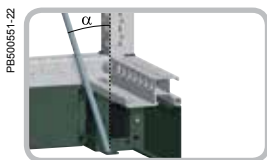

**1** - Mounting from the inside of the enclosure.

The machining angle varies according to the plinth model:

Plinth height 100 mm  $\alpha = 18^\circ$ .

Plinth height 200 mm  $\alpha = 9^\circ$ .

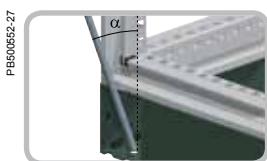

**2** - Mounting from the outside of the enclosure, optimum point for the rigidity of the assembly.

The machining angle varies according to the plinth model:

Plinth height 100 mm  $\alpha = 22^\circ$ .

Plinth height 200 mm  $\alpha = 11^\circ$ .

**3** - It is also possible to use floor-mounting supports, reference **NSYSGF**, to fix the corner or the panel and the corner to the floor.

The corners of the ends can be rotated in the event of needing to remove the side panels of the plinth and/or to obtain access to the mounting outside the floor, when the set is installed against the wall.



### Mounting the enclosure to the plinth

Mounting from the inside of the enclosure by means of an M12 screw, screwing directly into the corner of the plinth.

⊕ Mounting convenience and speed.

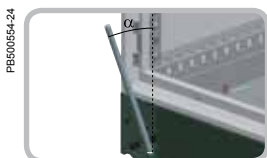

### Mounting the enclosure to the ground

Mounting from the outside of the enclosure, optimum point for the rigidity of the assembly.

The machining angle varies according to the plinth model:

Plinth height 100 mm  $\alpha = 22^\circ$ .

Plinth height 200 mm  $\alpha = 11^\circ$ .

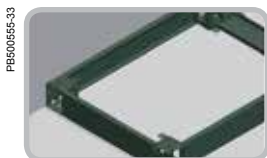

### Enclosure against a wall

Thanks to the design of the corners, when the enclosure is installed against the wall, the following is possible:

- to remove the side panels (turning back corners),
- to access the external mounting to the floor.

It is also possible to use floor-mounting supports, reference **NSYSGF**, to fix the corner or the panel and the corner to the floor.



### Assembly of the plinth panels

The panels are fixed with an M6 screw to the corner, included in the standard supply of the side panels.

The front and rear panels are delivered mounted on the corners.

### Floor

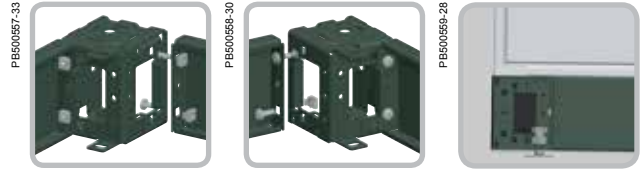

Mounting options			
<b>Characteristics</b>	<b>Screw M6</b> Torx T30 M6 x 10 screws.	<b>Caged nuts</b> M6 caged nuts.	<b>Levelling the plinth</b> The plinth allows levelling by means of an M12 screw.
<b>Supply</b>	50	100	-
<b>References</b>	<b>NSYSPM6</b>	<b>NSYCN9M625</b>	<b>NSYSPLK</b>



### Examples of solutions

PB502564-72

PB502565-51



PB502566-43

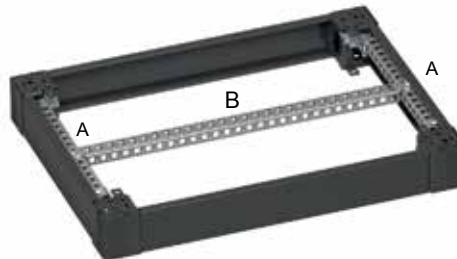

#### Plinth cross rail fixed in position B

- They are fixed to the plinth cross rails, both the universal and the quick-mounting types.
- Their depth is adjustable with a pitch of 25 mm.
- See universal and quick-mounting cross rail references, page 232.

Plinth cross rail fixes in position B.  
It requires 2 cross rails in position A to be fixed.

PB502567-104



**SM** **SF**

## Floor



Characteristics	Front plinth	Plinth side panels	Ventilated front plinth	Ventilated side panels	Panels with brush
	The front and rear of the plinth consists of 4 corners with 2 or 4 panels.	They are fixed to the corner of the plinth by 2 mounting screws.	The front and rear of the ventilated plinth is made up of 4 corners with 2 front panels.	They are fixed to the corner of the plinth by mounting screws.	They allow the entry and mounting of cables inside the enclosure, through the plinth.
Material	Folded sheet steel, corner with a thickness of 25/10° mm	Folded sheet steel	Folded sheet steel, corner with a thickness of 25/10° mm	Folded sheet steel	Folded sheet steel
Finish	Painted with epoxy-polyester resin	Painted with epoxy-polyester resin	Painted with epoxy-polyester resin	Painted with epoxy-polyester resin	Painted with epoxy-polyester resin
Colour	RAL 7022 grey	RAL 7022 grey	RAL 7022 grey	RAL 7022 grey	RAL 7022 grey
Ingress protection rating	IP30	IP30	IP20	IP20	IP20
Mechanical protection rating	IK10	IK10	IK10	IK10	IK10
Supply	<ul style="list-style-type: none"> <li>■ Height 100 mm: 4 corners, 2 panels (front and rear), 4 corner covers and mounting elements</li> <li>■ Height 200 mm: 4 corners, 4 panels (2 front and 2 rear), 4 corner covers and mounting elements</li> </ul>	<ul style="list-style-type: none"> <li>■ Height 100 mm: 2 side panels, 4 corner covers and mounting elements</li> <li>■ Height 200 mm: 4 side panels (height of 100 mm, 2 for each side), 4 corner covers and mounting elements</li> </ul>	<ul style="list-style-type: none"> <li>■ Height 100 mm: 4 corners, 2 ventilated panels (front and rear), 4 corner covers and mounting elements</li> </ul>	<ul style="list-style-type: none"> <li>■ Height 100 mm: 2 ventilated side panels, 4 corner covers and mounting elements</li> </ul>	<ul style="list-style-type: none"> <li>■ Height 100 mm: 2 panels with brushes, 4 corner covers and mounting elements</li> </ul>

References	Width (mm) (B)					
	100 mm	200 mm			100 mm	
300	NSYS PF3100	NSYS PF3200	-	-	-	-
400	NSYS PF4100	NSYS PF4200	-	-	-	-
600	NSYS PF6100	NSYS PF6200	-	-	NSYS PFV6100	-
800	NSYS PF8100	NSYS PF8200	-	-	NSYS PFV8100	-
1000	NSYS PF10100	NSYS PF10200	-	-	-	-
1200	NSYS PF12100	NSYS PF12200	-	-	-	-
1600	NSYS PF16100	NSYS PF16200	-	-	-	-
1800	-	-	-	-	-	-
2400	-	-	-	-	-	-
Depth (mm) (C)			100 mm	200 mm	100 mm	100 mm
300			NSYS PS3100	NSYS PS3200	-	-
400			NSYS PS4100	NSYS PS4200	-	-
500			NSYS PS5100	NSYS PS5200	-	-
600			NSYS PS6100	NSYS PS6200	-	NSYS PV6100
800			NSYS PS8100	NSYS PS8200	-	NSYS PV8100

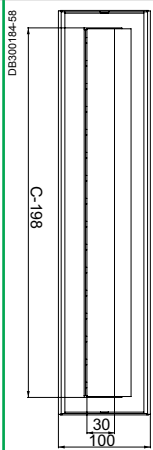
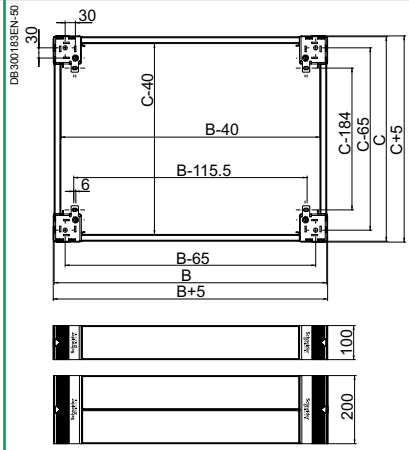

**[!]** Stainless-steel plinths compatible with steel offer.

### Floor



	Plinth for sets	Mounting to the floor	Mounting to the floor by mounting points of previous version (OLN/CMO or Spacial 6000 and 18500)	Plinth cross-rail support	Plinth cross rails
	Designed for the assembly of sets of 2 to 4 Spacial SF enclosures, joined on a single plinth.	Piece for mounting the plinth to the floor in the event of not being able to use the drill holes made in the plinth.	Pieces that reproduce the floor-mounting points of the previous plinth.	Support for mounting a cross rail inside the plinth.	They are fixed across the width and/or depth between the corners of the plinth. The plinth cross-rail supports are required for its assembly.
	Folded sheet steel	Steel	Steel	Steel	Steel
	Painted with epoxy-polyester resin	Zinc-coated	Zinc-coated	Zinc-coated	Zinc-coated
	RAL 7022 grey	-	-	-	-
	IP20	-	-	-	-
	IK10	-	-	-	-
	<ul style="list-style-type: none"> <li>Front plinth: 2 U-shaped profiles and mounting elements</li> <li>Plinth side panel: Height 100 mm: 2 plinths side panels and mounting elements</li> </ul>	4 pieces, mounting elements not supplied	4 pieces, mounting elements not supplied	12 pieces and mounting elements	2 cross rails and mounting elements

	100 mm	200 mm			Reference by unit Order by multiples of 12 (12, 24, 36...)	Cross rails	
			NSYSGF	NSYOL6GF	NSYSPCR	1 row (40)	3 rows (90)
	-	-	-	-	-	-	-
	-	-	-	-	-	NSYSUCR4030	NSYSUCR9030
	-	-	-	-	-	NSYSUCR4050	NSYSUCR9050
	-	-	-	-	-	NSYSUCR4070	NSYSUCR9070
	-	-	-	-	-	NSYSUCR4090	NSYSUCR9090
	-	-	-	-	-	NSYSUCR40110	NSYSUCR90110
	-	-	-	-	-	NSYSUCR40150	NSYSUCR90150
	NSYSPFC16100	NSYSPFC16200	-	-	-	-	-
	NSYSPFC18100	NSYSPFC18200	-	-	-	-	-
	NSYSPFC24100	NSYSPFC24200	-	-	-	-	-
	100 mm	200 mm	-	-	-	1 row (40)	3 rows (90)
	-	-	-	-	-	-	-
	NSYSPC4100	2 x NSYSPC4100	-	-	-	-	-
	NSYSPC5100	2 x NSYSPC5100	-	-	-	-	-
	NSYSPC6100	2 x NSYSPC6100	-	-	-	NSYSUCR4040	NSYSUCR9040
	NSYSPC8100	2 x NSYSPC8100	-	-	-	-	-

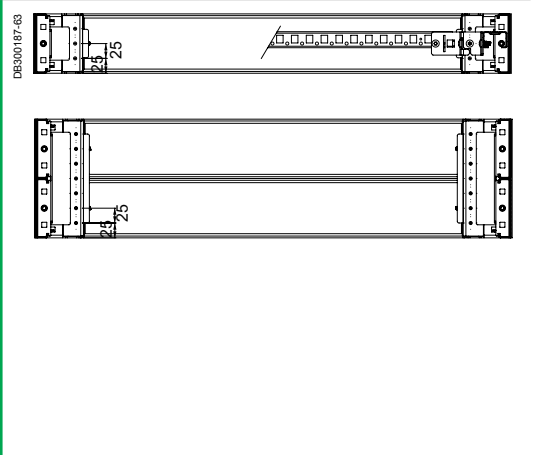
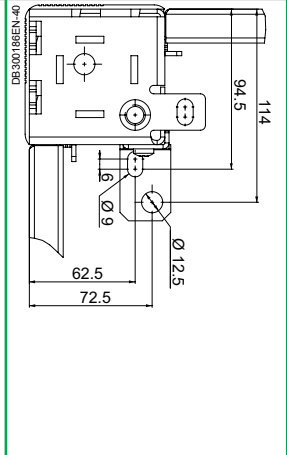
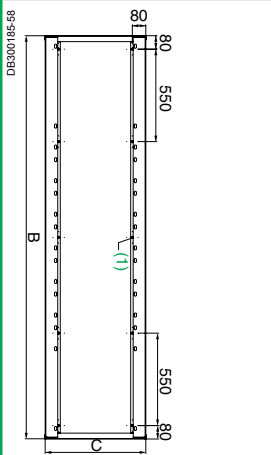

(1) Only for version with width of 2400 mm.

# Steel floor-standing enclosures Accessories

## Cable entries



Characteristics	Plain cable-gland plate	Plain	With 1 entry	With 2 entries	Cable-gland plate for connectors
	Maximum compact water/dustproof design.	Maximum compact water/dustproof design.	Facilitates the entry of cables thanks to a longitudinal opening.	Cable entry for very deep enclosures (600 and 800 mm). Two longitudinal openings allowing a large number of cables through.	Adapter plate to install cable entry plates for connectors, see page 279. To be used together with cable-gland plates, 1 or 2 entries, adding or replacing one of the parts.
Material	Steel painted with epoxy-polyester resin, RAL 7035	Galvanised steel			Galvanised steel
Thicknesses	10/10 <sup>e</sup> mm	15/10 <sup>e</sup> mm			15/10 <sup>e</sup> mm
Supply	Plain plate and mounting elements	Plain plate and mounting elements	Plate with 1 entry; self-extinguishing polyurethane adhesive gasket with cross-section of 15 x 25 mm and mounting elements	1 plate with 2 entries; polyurethane adhesive gasket with cross-section of 15 x 25 mm and mounting elements	Plate and mounting elements

  

Width (B)	Depth (C)	References	No. of cuts	References
300	500	- NSYEC35	-	-
	600	- NSYEC36	-	-
400	400	- NSYEC44	-	-
	500	- NSYEC45	-	-
	600	- NSYEC64	-	-
600	800	- NSYEC84	-	-
	300	NSYSMEC63	-	2 NSYDCE6
	400	NSYSMEC64	NSYEC64	NSYEC641
	500	NSYSMEC65	NSYEC65	NSYEC651
800	600	NSYSMEC66	NSYEC66	NSYEC661 NSYEC662
	800	-	NSYEC68	NSYEC681 NSYEC682
	300	NSYSMEC83	-	3 NSYDCE8
	400	NSYSMEC84	NSYEC84	NSYEC841
1000	500	NSYSMEC85	NSYEC85	NSYEC851
	600	NSYSMEC86	NSYEC86	NSYEC861 NSYEC862
	800	-	NSYEC88	NSYEC881 NSYEC882
	300	NSYSMEC103	-	4 NSYDCE10
1200	400	NSYSMEC104	NSYEC104	NSYEC1041
	500	NSYSMEC105	NSYEC105	NSYEC1051
	600	-	NSYEC106	NSYEC1061 NSYEC1062
	800	-	NSYEC108	NSYEC1081 NSYEC1082
1600	300	2 x NSYSMEC63	-	4 NSYDCE12
	400	2 x NSYSMEC64	NSYEC124	NSYEC1241
	500	2 x NSYSMEC65	NSYEC125	NSYEC1251
	600	2 x NSYSMEC66	NSYEC126	NSYEC1261 NSYEC1262
1600	800	-	NSYEC128	NSYEC1281 NSYEC1282
	400	2 x NSYSMEC84	NSYEC164	NSYEC1641
	500	2 x NSYSMEC85	NSYEC165	NSYEC1651
	600	2 x NSYSMEC86	NSYEC166	NSYEC1661 NSYEC1662

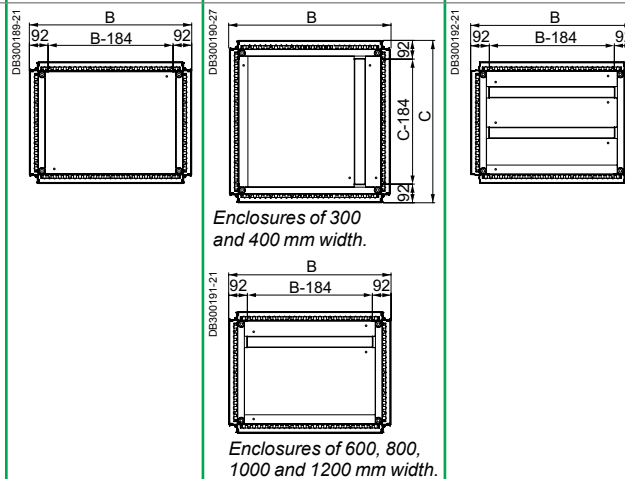



## Possibilities of cable gland-plate adjustment

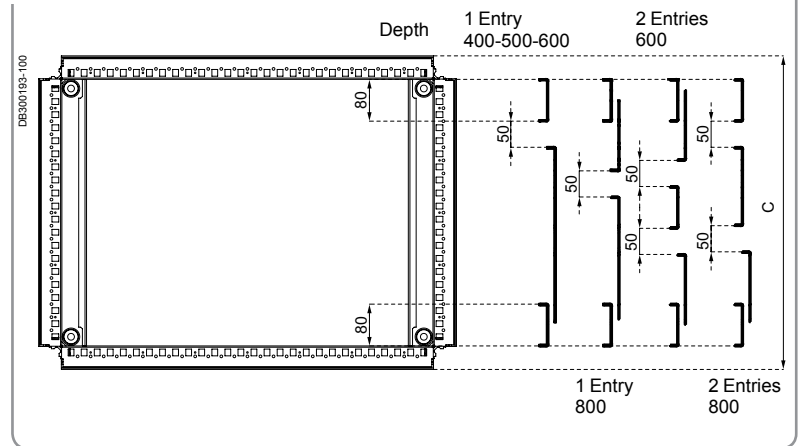

## Gaskets



PB500579-22



PB500584-21



PB500686-24



PB502385

Dimensions (mm)	Brush-type cable-entry gasket	Foam cable-entry gasket	Sealing gasket
	For plates with 1 or 2 cable entries. The cables can have different diameters.	Brush-type gasket for installation on the cable-gland plates. The cables can have different diameters.	Spare gasket, made from self-extinguishing expanded polyurethane with a cross-section of 15 x 25 mm, for mounting on cable-gland plates.
			Sealing gasket, made from ethylene-propylene with a cross-section of 3 x 10 mm, for mounting on the perimeter of the cable-gland plates. Adhesive to guarantee good sealing.
Width (mm)	References		Reference
300	NSYBCE3	-	NSYCEJ
400	NSYBCE4	-	
600	NSYBCE6	NSYSMBCE6	
800	NSYBCE8	NSYSMBCE8	
1000	NSYBCE10	NSYSMBCE10	
1200	NSYBCE12	2 x NSYSMBCE6	
1600	NSYBCE16	2 x NSYSMBCE8	NSYCEK

## Lifting systems

SF



SM

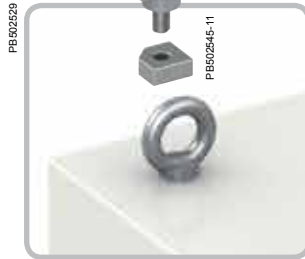

SF



Characteristics	Eyebolts	Lifting brackets
Maximum amount of assembled enclosures to be lifted	1	2
	Set of M12 lifting 12:12 which screw directly into the structure of the 13:13 the axis of the uprights.	Set of lifting and transport brackets, fixed to the structure between two coupled enclosures, in the axis of the uprights.
Material	Galvanised cast steel	Zinc-coated steel
Maximum load	340 kg	500 kg
Supply	4 eyebolts	4 brackets and M12 screws

**References**

NSYSFEB

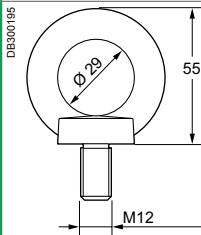

NSYSMEB

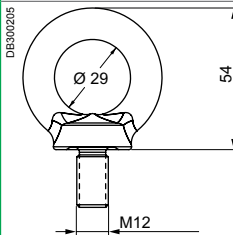

NSYSFELB

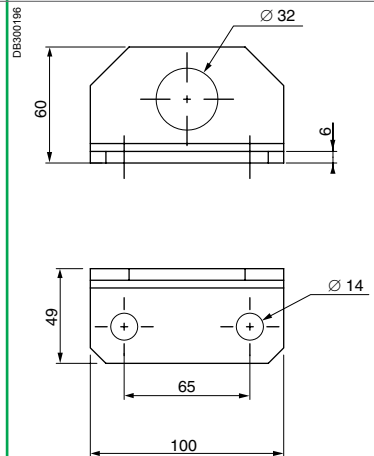



### Lifting systems

SF



Lifting bar			
2	3	4	5
Set of bars for lifting and transporting enclosures suites. They are fixed to the structure of the enclosure, in the axis of the uprights.			
Steel			
2000 kg (lenght 1600 mm)	3000 kg (lenght 1800 mm)	3000 kg (lenght 2400 mm)	4000 kg (lenght 3200 mm)
2 lifting bars and M12 screws			

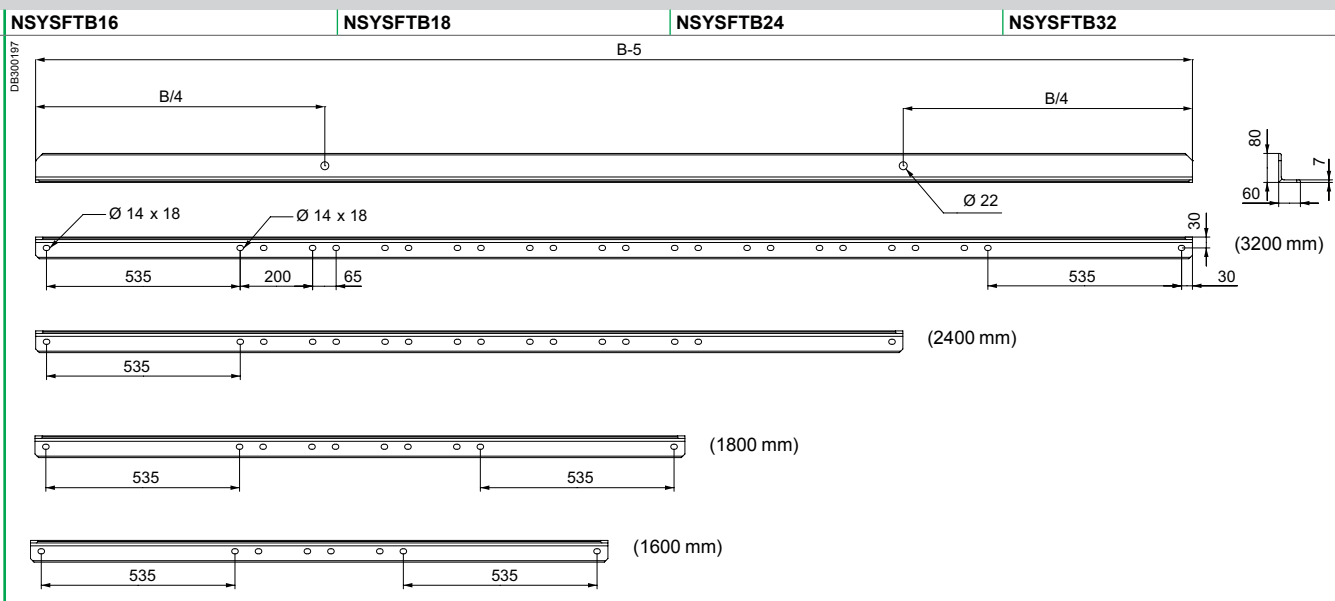

### Recommended lifting points

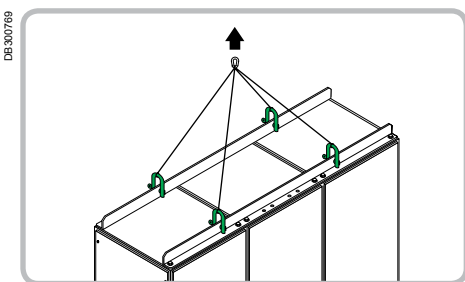

**Shackles**  
Lifting bar shackles.  
 ■ **Maximum load:** 1600 kg.  
 ■ **Supply:** 4 shackles.

**Reference**  
NSYSFTBS

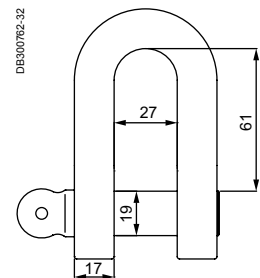

### Roof



SM

SF



SF

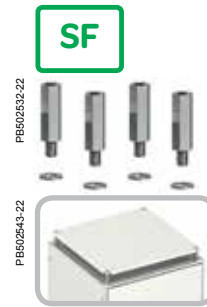

SF

Characteristics	Canopy	Ventilated roof
	Provides excellent protection against splashes from rainwater. Highly recommended for outdoor applications. Not compatible with the simultaneous use of lifting elements. Spacial SF: it is possible to use a single canopy with combinations of modular enclosures (example of a 1600 mm canopy with two coupled 800-mm enclosures).	Roof providing natural ventilation for the enclosure, with IP30 protection. Height: an extra 63 mm in relation to the structure.
Material	Galvanised steel	Steel
Finish	Painted with polyester-epoxy resin	Painted with polyester-epoxy resin
Colour	RAL 7035 grey	RAL 7035 grey
Mounting	<ul style="list-style-type: none"> <li>■ Spacial SF: mounting by drill holes to be made in the roof of the enclosure</li> <li>■ Spacial SM: mounting by drill holes already made in the roof</li> </ul>	-
Supply	One canopy, drilling template and mounting elements	One ventilated roof and four elevators
Width (B) (mm)	Depth (C) (mm)	References
600	300	NSYSC630
	400	NSYSC640
	500	NSYSC650
	600	NSYSC660
	800	-
800	300	NSYSC830
	400	NSYSC840
	500	NSYSC850
	600	NSYSC860
	800	-
1000	300	NSYSC1030
	400	NSYSC1040
	500	NSYSC1050
	600	NSYSC1060
1200	300	NSYSC1230
	400	NSYSC1240
	500	NSYSC1250
	600	NSYSC1260
1600	400	NSYSC1640
	500	NSYSC1650
	600	NSYSC1660
1800	500	NSYSC1850
	600	NSYSC1860
2000	500	NSYSC2050
	600	NSYSC2060
2400	500	NSYSC2450
	600	NSYSC2460

### Ventilation elevators for roof

	Allows the roof to be raised, providing natural ventilation. They are screwed onto the structure, at the roof mounting point.	
Material	Zinc-coated steel	
Supply	4 elevators	
Height (H) (mm)	IP	References
23	20	NSYRE26
60	10	NSYRE60

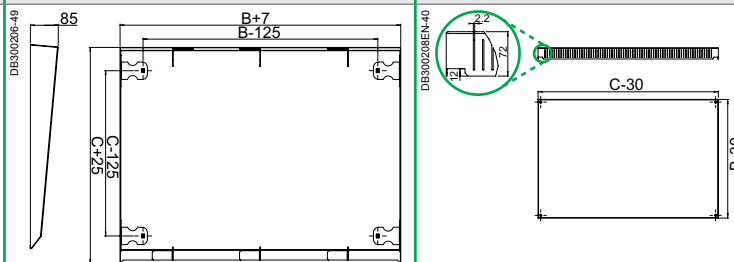
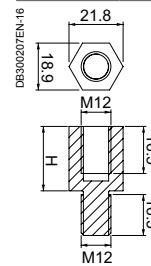

### Roof



PB500597-47



PB500598-47

PB500599-23

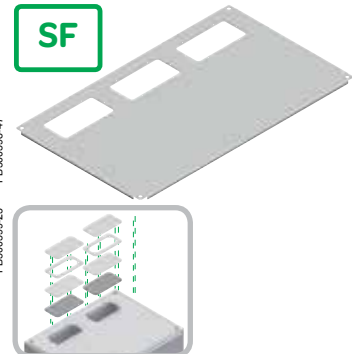

Characteristics				FL21 cable-entry roof	Cable-entry roof
				Roof prepared for installing FL21 cable-entry plates.	Roof prepared for installing cable-entry plates.
Material				Steel	Steel
Finish				Painted with epoxy-polyester resin	Painted with epoxy-polyester resin
Colour				RAL 7035 grey	RAL 7035 grey
Supply				One cut-out roof for the FL21 cable-entry plates	One cut-out roof for the cable-entry plates
Dimensions (mm)		Centre-to-centre distance (mm)		No. of entries	References
Width (B)	Depth (C)	D	E		
600	500	285	-	1	NSYSFLR65
	600		-		NSYSRCE650
800	500	195	-	2	NSYSFLR66
	600		-		NSYSRCE660
	500	220	-	-	NSYSFLR85
	600		-	-	NSYSRCE850
1000	500	195	290	3	NSYSFLR86
	600		-		-
	500	220	285	-	NSYSFLR105
	600		-	-	NSYSRCE1050
				-	NSYSFLR106
				-	NSYSRCE1060

DB300209EN-48

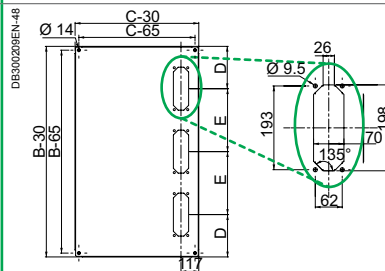

#### FL21 cable-entry membranes (1)

Membrane plate for watertight cable entries made from insulating material (fire resistance level UL94-V0).

Direct installation in the FL21 cable-entry plate adapter.

4 models: plain plate and membrane plates from 7 to 35 cable entries.

- Material: grey plastic.
- Ingress protection rating: IP65.
- Supply: membrane plate and mounting elements.

No. of cable entries	References
Plain	NSYAECFLBP
7	NSYAECFLT7
25	NSYAECFLT25
35	NSYAECFLT35

(1) For more information, see page 279.

DB300210EN-50

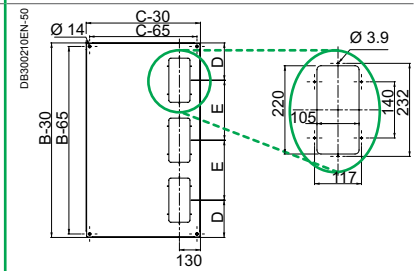

#### Standard cable-entry plate (1)

Thickness	Reference
15/10° mm	NSYTLCL

#### FlexiCable

Reference
NSYTLCLME

#### Aluminium cable-entry plate

Thickness	Reference
30/10° mm	NSYTLCLU

#### Adapter for FL21 cable-entry plate

Thickness	Reference
15/10° mm	NSYTLCLFL

DB300214EN-43

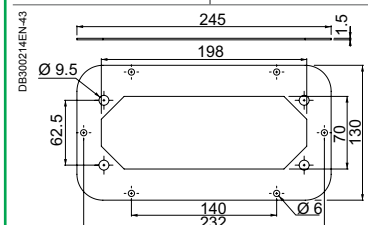

### Wall mounting

SF



SM



Characteristics	Wall mounting support	
	<p>Supports for mounting the enclosure on the wall and preventing it from turning over. They cannot be used for hanging the enclosure. They are installed using the roof mounting screws.</p>	<p>Supports for mounting the enclosure on the wall and preventing it from turning over. They are installed using the drill holes in the back of the enclosure. Enclosure fixed from the outside.</p>
Material	Zinc-coated steel	Zinc-coated steel
Supply	2 supports	2 supports
References		
	<p><b>NSYSFWFIX</b></p> <p>DB30021REN-65</p>	<p><b>NSYSMWFIX</b></p> <p>DB30021REN</p>

## Doors



Characteristics		Inner door	Side door
		Door for additional protection. Prevents the switchgear from being manipulated by unauthorised personnel. Allows the installation of switchgear mounted directly on the door. Mounting on the top and bottom frame of the enclosure. Depth adjustable with a pitch of 25 mm, from first mounting point. Opening to right or left, with two locks, 3-mm double-bar, with central handle. Reinforcement frames on the rear, cut-outs with a 25-mm pitch, for equipping the door. Maximum acceptable load: 15 kg.	Door for the side of the enclosure, replaces the side panel. Installation directly on the structure of the enclosure, opening 120°. Lock with handle and 5-mm double-bar insert. 4 locking points. Reinforcement frame, cut-out with a pitch of 25 mm. Opening to right or left.
Material		Steel	Steel
Finish		Painted with epoxy-polyester resin	Painted with epoxy-polyester resin
Colour		RAL 7035 grey	RAL 7035 grey
Supply		One inner door and mounting elements	One side door, four hinges, four catches and handle lock
<b>Height (mm)</b>	<b>Depth (mm)</b>	<b>References</b>	
1200	600	-	<b>NSYSFD126</b>
	800	-	<b>NSYSFD128</b>
1400	600	-	<b>NSYSFD146</b>
	800	-	<b>NSYSFD148</b>
1600	600	<b>NSYID166</b>	<b>NSYSFD166</b>
	800	<b>NSYID168</b>	<b>NSYSFD168</b>
1800	400	-	<b>NSYSFD184</b>
	500	-	<b>NSYSFD185</b>
	600	<b>NSYID186</b>	<b>NSYSFD186</b>
	800	<b>NSYID188</b>	<b>NSYSFD188</b>
2000	1000	<b>NSYID1810</b>	-
	400	-	<b>NSYSFD204</b>
	500	-	<b>NSYSFD205</b>
	600	<b>NSYID206</b>	<b>NSYSFD206</b>
2200	800	<b>NSYID208</b>	<b>NSYSFD208</b>
	1000	<b>NSYID2010</b>	-
	400	-	<b>NSYSFD224</b>
	500	-	<b>NSYSFD225</b>
2200	600	<b>NSYID226</b>	<b>NSYSFD226</b>
	800	<b>NSYID228</b>	<b>NSYSFD228</b>

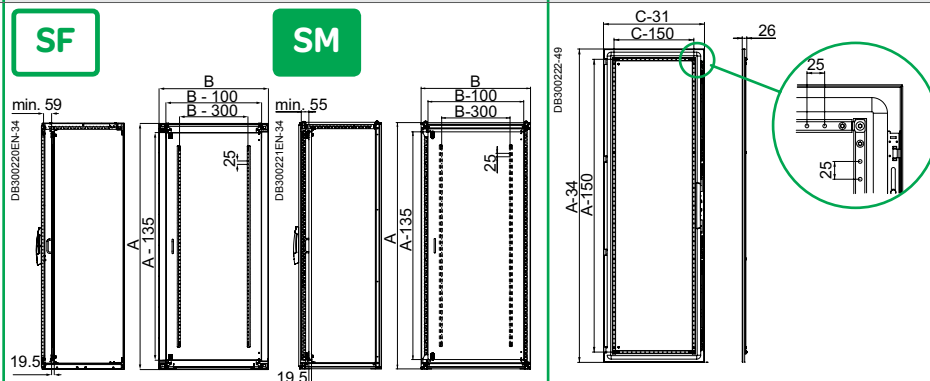

SF

SM

### Door accessories



PB502533-30



PB502534-30



PB502556-25



PB502559-25

Characteristics				Metal document pocket	Plastic document pocket	Folding support tray
				Direct mounting on the reinforcement frame of the door. Adjustable depth with a pitch of 25 mm.	Attachment by adhesive tape.	Adjustable horizontal support for laptop computers, documents or any other element. Installation on the reinforcement frame of the door. Can also be installed on the door cross rails, see page 296. 4 positions: 45°, 60°, 75° and 90°.
Material				Steel	Polystyrene (PS)	Steel
Finish				Painted with polyester-epoxy resin	-	Painted with epoxy-polyester resin
Colour				RAL 7035 grey	RAL 7035 grey (NSYDPA4: RAL9001)	RAL 7035 grey
Maximum load				-	-	30 kg
Supply				One metal document pocket and mounting elements	One plastic document pocket	One folding support tray and mounting elements
Dimensions (mm)				References		
Doc. format	A	B	C			
A5	174	188	22	-	NSYDPA5	-
A4	230	247	23	-	NSYDPA4	-
A4	234	278	40	-	NSYDPA44	-
A3	285	476	35	-	NSYDPA3	-
Width (D)						
500				-	-	NSYSDT5
600				NSYSDP6M	-	NSYSDT6
800				NSYSDP8M	-	NSYSDT8



### Door accessories

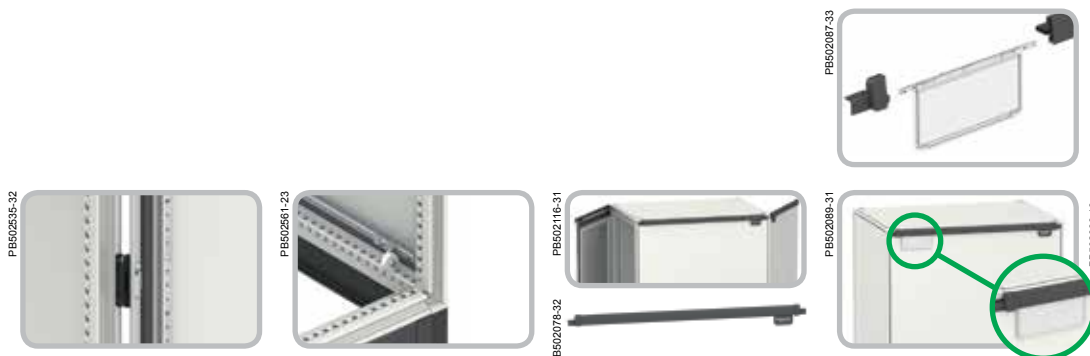

Characteristics		180° hinge	Door-centring caster	Trim plate	Customisable label holder
		Hinge with opening of 180°. Intended to replace the 120° hinges installed as standard. They are compatible with the transparent door and can be installed even with enclosure suites.	Allows the door to be raised when closing. Direct mounting on the reinforcement frame.	Trim plate for Spacial SF and SM plain and transparent doors. The Schneider Electric logo can be placed on the left or on the right.	Label holder to be placed on trim plate to customise the enclosure. Delivered with a printable blank label.
Material		Aluminium and zamak	-	UV-resistant plastic	Polycarbonate (PC)
Finish		Painted RAL 9005 black	-	-	-
Mechanical protection rating		-	-	IK09	-
Maximum load		60 kg on the door	60 kg	-	-
Supply		4 hinges, template for making the drill holes and mounting elements	One centring roller and mounting elements	1 trim plate for single doors, 2 trim plates for double doors	5 label holders
		<b>References</b>			
		<b>NSYSH180</b>	<b>NSYSDRC</b>	-	<b>NSYCBLSF</b>
<b>Width (mm)</b>	<b>No. of doors</b>	<b>References</b>			
300	1	-	-	<b>NSYTRIM3SF</b>	-
400	1	-	-	<b>NSYTRIM4SF</b>	-
500	1	-	-	<b>NSYTRIM5SF</b>	-
600	1	-	-	<b>NSYTRIM6SF</b>	-
700	1	-	-	<b>NSYTRIM7SFP</b>	-
800	1	-	-	<b>NSYTRIM8SF</b>	-
	2	-	-	<b>NSYTRIM8SF2D</b>	-
1000	1	-	-	<b>NSYTRIM10SF</b>	-
	2	-	-	<b>NSYTRIM10SF2D</b>	-
1200	2	-	-	<b>NSYTRIM12SF2D</b>	-
1600	2	-	-	<b>NSYTRIM16SF2D</b>	-



	Door switch	
	For Spacial SF & SFX	For Spacial SM
See page	295	295
Supply	1	1
<b>References</b>		
	<b>NSYDCM20</b>	<b>NSYDPCM20</b>

## Locking system

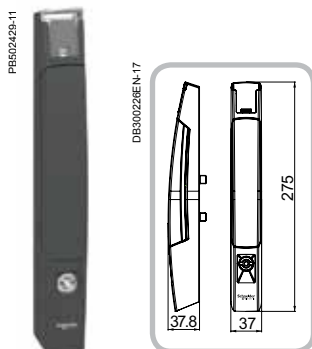

### Characteristics

#### Handle for shape inserts and cylindrical barrels



Easy to change the opening direction of the door, right/left.  
Space reserved for enclosure identification, 21 x 27 mm, protected by a label frame.

Material	Handle: polyamide 6 with 30 % fibreglass, RAL 9005 colour
Mechanical protection rating	IK10
Fire resistance	650°C
Supply	Standard handle and mounting elements (insert not included)

### References

NSYSFHS1

### Accessories

	Shape inserts	References	Cylindrical barrels	References
 Shape inserts	6-mm square insert	NSYINS61	405E key lock	NSYIN405E1
	Female 6-mm square insert	NSYINS6G1	421E key lock	NSYIN421E1
	7-mm square insert	NSYINS71	455 key lock	NSYIN4551
	8-mm square insert	NSYINS81	1242E key lock	NSYIN1242E1
	Female 8-mm square insert	NSYINS8G1	1332E key lock	NSYIN1332E1
	8-mm square insert with slot	NSYINS8H1	2124E key lock	NSYIN2124E1
	6.5-mm triangular insert	NSYINT61	2131A key lock	NSYIN2131A1
	7-mm triangular insert	NSYINT71	2132A key lock	NSYIN2132A1
	8-mm triangular insert	NSYINT81	2331A key lock	NSYIN2331A1
	9-mm triangular insert	NSYINT91	2433A key lock	NSYIN2433A1
 Push button	10-mm triangular insert	NSYINT101	2452E key lock	NSYIN2452E1
	10-mm keyless hexagonal insert	NSYINH31	3113A key lock	NSYIN3113A1
	3-mm double-bar insert	NSYINDB31	3122E key lock	NSYIN3122E1
	5-mm double-bar insert	NSYINDB51	3123A key lock	NSYIN3123A1
	Daimler Benz insert	NSYINBENZ1	3131A1 key lock	NSYIN3131A1 <span style="color: red; font-weight: bold;">New</span>
	Fiat insert	NSYINFIAT1	3133A key lock	NSYIN3133A1
	Keyless USA slot insert	NSYINUSA1	3422E key lock	NSYIN3422E1
	Keyless 2 x 4 slot insert	NSYIN241	3432E key lock	NSYIN3432E1
	Crown insert	NSYINCW1	6101 key lock	NSYIN6101 <span style="color: red; font-weight: bold;">New</span>
	 Cylindrical barrels	<b>Push button</b>	<b>Reference</b>	EDF 1300 key lock
Push button		NSYINPULS1	EDF 1400 key lock	NSYINF1401
			Michelin 8079 keyless lock	NSYINICHEL8791
			Michelin 8133 keyless lock	NSYINICHEL8131
			Michelin 8376 keyless lock	NSYINICHEL8371
			E1 keyless lock	NSYINE11



### Locking system

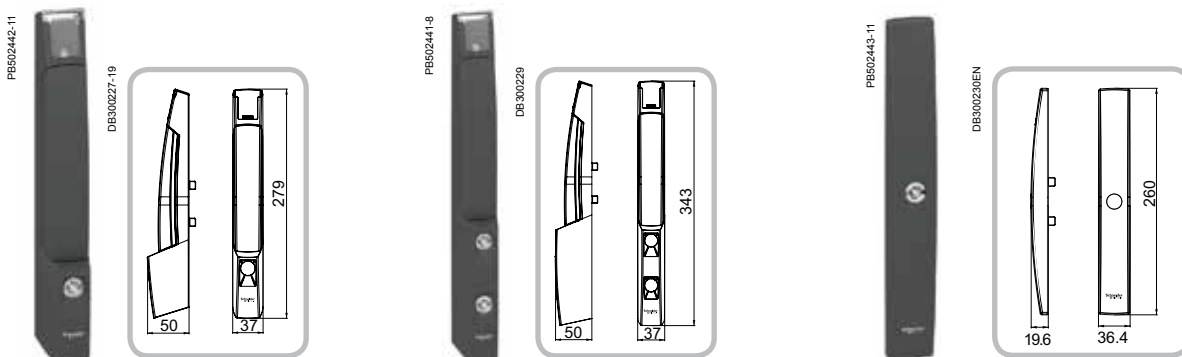

Handles for insert types DIN, KABA, ASSA		Flat escutcheon lock
<b>Insert handle</b>	<b>Double-insert handle</b>	Optional flat escutcheon lock. Replaces the handle lock. Easy to change the opening direction of the door, right/left. Possibility of changing the turning direction of the insert.
The inserts are easily and quickly mounted without any screws and allow the installation of profiled DIN, KABA and ASSA locks. To install shape inserts or cylindrical barrels, it is necessary to add adapter ref. NSYLADP. Easy to change the opening direction of the door, right/left. Space reserved for enclosure identification, 21 x 27 mm, protected by a label frame.	The double insert handle can perform the "AND" and "OR" functions (are supplied with the handle). - "AND" function: one insert blocks the activation of the other insert. - "OR" function: either insert can release the handle. Easy to change the opening direction of the door, right/left. Space reserved for enclosure identification, 21 x 27 mm, protected by a label frame. To install shape inserts or cylindrical barrels, it is necessary to add adapter ref. NSYLADP.	
Handle: polyamide 6 with 30 % fibreglass, RAL 9005 colour		
IK10		
650°C		
One handle for DIN, KABA and ASSA inserts and mounting elements (insert not included)		Flat lock, shape insert, key and mounting elements

<b>NSYSFHD2</b>	<b>NSYSFHD3</b>	-
-----------------	-----------------	---

Lock system: DIN, KABA and ASSA		References	Models	References
	Adapter for DIN cylinder	<b>NSYINDIN2</b>		<b>NSYSFLOCK24</b>
	Adapter for KABA cylinder (1)	<b>NSYINKBA2</b>		
	Adapter for ASSA cylinder	<b>NSYINASSA2</b>		<b>NSYSFLOCKT8</b>
	1242E key lock	<b>NSYIN1242E2</b>		
	Reinforced key lock	<b>NSYINKR2</b>		<b>NSYSFLOCKT7</b>
	JIS key lock	<b>NSYINKJIS2</b>		
FAC key lock	<b>NSYINKFAC2</b>		<b>NSYSFLOCKT6</b>	
(1) Adapter for receiving the KABA8, KABA20 and KABA start cylinders.				
 Insert dimensions for DIN adapters. Insert dimensions for KABA adapters.			<b>NSYSFLOCKS8</b>	
 Insert dimensions for ASSA adapters.				
 <b>Adapter for shape inserts and cylindrical barrels</b> Plastic adapter for installing shape inserts and cylindrical barrels in handle lock types DIN, KABA, ASSA. See shape inserts and cylindrical barrels. See insert types DIN, KABA, ASSA. Supply: 1 unit.			<b>NSYSFLOCKS6</b>	
<b>References</b> <b>NSYLADP</b>				

### Locking system



Characteristics	Padlock locking	CNOMO kit
	Padlock locking system, for installation in all the handles of the Spacial SF and Spacial SM enclosures. Bolt with 7.5-mm drill hole.	Locking system to be installed on the central locking bar of the door. It works as a locking bar immobiliser, preventing the handle from closing while the door is still open. It is compatible with all handle lock versions, except the flat lock and the small flat lock.
Supply	One cut-out handle, bolt for padlock and bolt mounting screw	One mechanism and mounting elements
References	<b>NSYBLKH123</b>	<b>NSYCNOH123</b>



# Stainless-steel wall-mounting enclosures

# Stainless-steel wall-mounting enclosures

## Contents

PB60075-42



### **Spacial S3X** Stainless-steel wall-mounting enclosures **150**

Introduction	150
Characteristics	153
Dimensions	154
Accessories	155

PB60075-42



### **Associated applicative offers** **S3XEX** Potentially explosive atmospheres **352**



# Stainless-steel wall-mounting enclosures

## Introduction

PE501229.eps



### What is stainless steel?

#### How is the stainless steel grade determined?

These enclosures have been specially designed for the chemical, oil and food and beverage industries, among others, which are particularly demanding in terms of hygiene and resistance to corrosion.

#### Thanks to an elaborate composition

■ The following table shows the percentages of the main alloy elements that make up stainless steels. The resistance of the material to aggressive agents in the environment depends mainly on these alloys.

Stainless-steel type		Chemical composition (%)			
AISI grade	N. Europe	Carbon	Chromium	Nickel	Molybdenum
304L	1.4307	< 0.03	17 - 19	8 - 10	0
316L	1.4404	< 0.03	17 - 19	10 - 13	2 - 2.25

PE501230



### Choosing a stainless steel grade

#### AISI 304L stainless steel

##### (known as food and beverage stainless steel)

The most commonly used type in the food and beverage industry for its resistance to corrosion and easy cleaning.

- Prevention against corrosion, especially in the presence of organic acids.
- Resistance to the action of nitrous gas in the presence of condensation water and in most aggressive environments.

PE501231



#### AISI 316L stainless steel (known as marine stainless steel)

Recommended in salty or chlorinated environments due to its very high resistance to corrosion thanks to the presence of molybdenum.

- Improved resistance to corrosion.
- Particularly well adapted to environments charged with acidity, bromine and saline halides or which use very corrosive additives and solvents.

# Stainless-steel wall-mounting enclosures

## Introduction

### The finish

#### The finish: 3 solutions against aggressive environmental agents

Surface condition plays an important role in the fight against bacteria.

The lower the roughness, the fewer bacteria become incrustated.

Reduced roughness means fewer bacteria, less adherence of materials and an impeccable finish.

To choose a finish is also to choose an appearance of the enclosures that matches the environment of other machines and equipment.

PE501232



#### > Solution 1: Scotch-Brite® brushing

The method used consists of brushing as defined by the ASTM (American Society for Testing and Material).

- Finish very commonly used for the chemical and food and beverage industries.
- Surface roughness is improved thanks to an additional polishing process which offers more efficient characteristics against polluting elements.
- Surface roughness,  $Ra \leq 0.8 \mu m$ .

PE501233



#### > Solution 2: Micro-beading (on request)

Exclusiveness, an impeccable finish with smooth silky appearance.

The method:

- Bombardment with miniscule ceramic balls of the entire surface to be treated at very high speed.
- Closes micro-cracks caused during lamination by flattening.

The result:

- Increased hardness.
- Compared to Solution 1, reduced surface roughness ( $Ra \approx 0.8 \mu m$ ). A perfectly even surface, with a silky appearance (no scratches and no burrs).
- Reduces the adherence of materials.
- Allows disinfection.

Typical application: pharmaceutical and food and beverage industries.

PE501234



#### > Solution 3: Protective painting (on request)

The highest protection against aggressions, external pollution and projections of metal particles.

- Provides the ultimate protection against corrosion.

Typical applications: marine, seaside, off-shore.

# Stainless-steel wall-mounting enclosures

## Introduction

➤ These enclosures have been specially designed for the chemical, oil and food and beverage industries, among others, which are particularly demanding in terms of hygiene and resistance to corrosion.

PB60075-75



PB601225-31



### Finishes

- Two types of steel offered as standard: 304L and 316L, with Scotch-Brite® brushed finish.
- Painted or micro-beaded finish (on request).

PB601239



### Large range of accessories

- Stainless-steel accessories: canopy, wall-fixing lugs.
- Accessories of the standard offer: mounting plate, inner door, modular chassis and step slides.
- Large selection of locks.

PB601240-60



### Sealing

- Protection rating of IP66 (1 door) or IP55 (2 doors) according to IEC 60529: complete protection against dust and water sprays.
- Polyurethane gasket.
- Gutter-shaped front profile.
- Three closure points for the double door.

PB601241



### Robustness and durability

- Resistance to external mechanical impacts:
  - IK10: plain door,
  - IK08: glazed door.
- Door reinforcement frame or profile.
- Stainless-steel hinges.

PB601242-45



### Convenience and time saving

- 304 or 316L stainless-steel wall-mounting brackets.
- Vertical reinforcement perforated profiles, which make it easier to equip the door.
- Reversible door opening to 120°.
- Easy installation directly on the machine thanks to the 4 rear drill holes.

This range can be configured according to your needs

4 different services available:



Assemble to order



Mounting of standard accessories



Painting



Machining

See page 396 for details or consult our web site [www.schneider-electric.com](http://www.schneider-electric.com)



# Stainless-steel wall-mounting enclosures

## Characteristics



Characteristics	304L stainless-steel		316L stainless-steel				
	Enclosure with plain door.	Enclosure with glazed door, Securit® glass, 4 mm thick.	Enclosure with plain door.				
Material	AISI 304L		AISI 316L				
Finish	Scotch-Brite® brushed						
Thickness	10/10° - 15/10° mm						
Ingress protection rating	IP66 (1 door) or IP55 (2 doors)						
Mechanical protection rating	IK10	IK08	IK10				
Standards	<ul style="list-style-type: none"> <li>■ IEC 62208</li> </ul>						
Certifications	<ul style="list-style-type: none"> <li>■ UL 508A</li> <li>■ CSA-C22.2 No. 14</li> <li>■ NEMA</li> <li>□ 1 door enclosure: type 1, 2, 3, 3R, 4, 4X, 5, 12, 13</li> <li>□ 2 doors enclosure: type 1, 12, 12K</li> </ul>						
Installation	Outdoor installation: compliant with IEC 62208 regarding type tests specified in §9.12 (resistance to ultra-violet (UV) radiation) and §9.13 (resistance to corrosion). It is always advisable to install a canopy to avoid water stagnation on the upper part of the enclosure						
Other characteristics	<ul style="list-style-type: none"> <li>■ Single-piece body (cross-shaped structure). Gutter-shaped front profile</li> <li>■ 4 rear studs for mounting the material</li> <li>■ 2 cut-out vertical profiles on the door (from a height of 600 mm), with drill holes with a diameter of 4.25 mm and a pitch of 25 mm for installing accessories</li> <li>■ Door strengthening frame (from a height of 1000 mm), cross-section of 20 mm x 15 mm, with drill holes with a diameter of 5 mm and a pitch of 25 mm</li> <li>■ Standard lock with 3-mm double-bar lock (chrome-plated zamak)</li> <li>■ 2 locking points for heights of more than 500 mm or three points for two-door enclosures</li> <li>■ Stainless-steel hinges screwed to the body of the enclosure. They make it easier to remove and invert the door. Opening angle: 120°</li> <li>■ Maximum load on the door: 50 kg/m²</li> <li>■ Polyurethane gasket</li> <li>■ M6 x 16 screws on the door and on the body, allowing equipotential connection between the earth connections (on request)</li> <li>■ 4 holes for mounting to wall directly or with the help of mounting lugs (on request), blocked by sealing plugs</li> </ul>						
<b>External dimensions (mm)</b>							
<b>Height</b>	<b>Width</b>	<b>Depth</b>	<b>No. of locks</b>	<b>No. of doors</b>	<b>Plain door</b>	<b>Glazed door**</b>	<b>Plain door</b>
300	200	150	1	1	NSYS3X3215	-	NSYS3X3215H
	250	150	1	1	NSYS3X302515	-	NSYS3X302515H
	300	150	1	1	NSYS3X3315	-	NSYS3X3315H
400	300	150	1	1	NSYS3X4315	-	NSYS3X4315H
		200	1	1	NSYS3X4320	NSYS3X4320T	NSYS3X4320H
	400	200	1	1	NSYS3X4420	-	NSYS3X4420H
600	600	200	1	1	NSYS3X4620	-	NSYS3X4620H
	400	200	2	1	NSYS3X5420	NSYS3X5420T	NSYS3X5420H
600	400	200	2	1	NSYS3X6420	NSYS3X6420T	NSYS3X6420H
	600	250	2	1	NSYS3X6625	-	NSYS3X6625H
	1000	300	1	2	NSYS3X601030 <span style="color: red; font-weight: bold;">New</span>	-	-
1200	300	300	1	2	NSYS3X601230 <span style="color: red; font-weight: bold;">New</span>	-	-
		500	250	2	1	NSYS3X7525	NSYS3X7525T
800	600	250	2	1	NSYS3X8625	NSYS3X8625T	NSYS3X8625H
	800	300	2	1	NSYS3X8830	-	NSYS3X8830H
	1000	300	1	2	NSYS3X801030 <span style="color: red; font-weight: bold;">New</span>	-	-
1200	300	300	1	2	NSYS3X801230 <span style="color: red; font-weight: bold;">New</span>	-	-
		800	300	2	1	NSYS3X10830	NSYS3X10830T
1000	1000	300	*	2	NSYS3X101030	-	NSYS3X101030H
		800	300	2	1	NSYS3X12830	-
1200	1000	300	*	2	NSYS3X121030	-	NSYS3X121030H

\* Three-point closure system.

\*\* The glazed door has no reinforcement.

# Stainless-steel wall-mounting enclosures

## Dimensions

External dimensions (mm)			Fig.
A	B	C	
300	200	150	1
	250	150	1
	300	150	1
400	300	150	1
	300	200	1
	400	200	1
	600	200	1
500	400	200	2*
600	400	200	2
	600	250	2
	1000	300	4
	1200	300	4
700	500	250	2
800	600	250	2
	800	300	2
	1000	300	4
1000	1200	300	4
	1000	300	3
1200	800	300	4
	1000	300	3
	1000	300	4

\* Without door reinforcement.

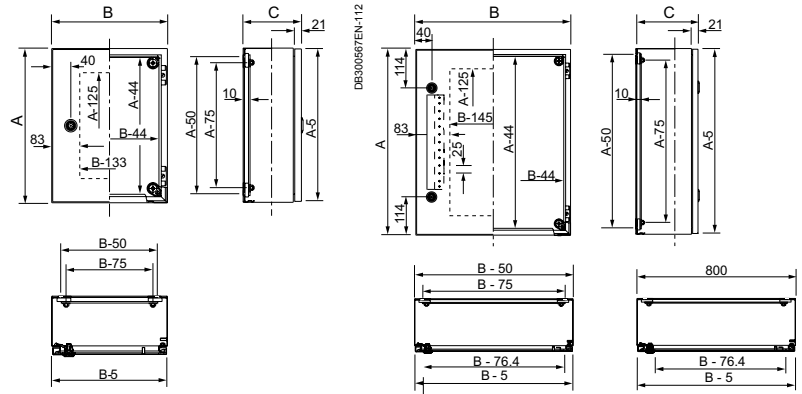

Fig. 1

Fig. 2

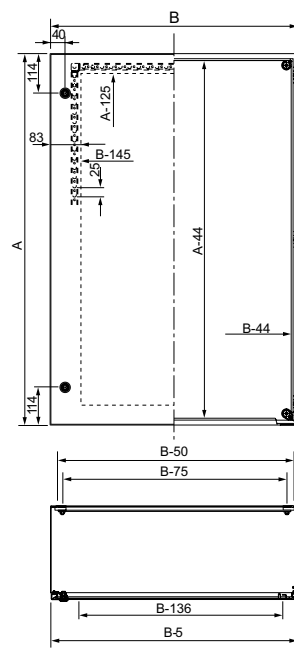

Fig. 3

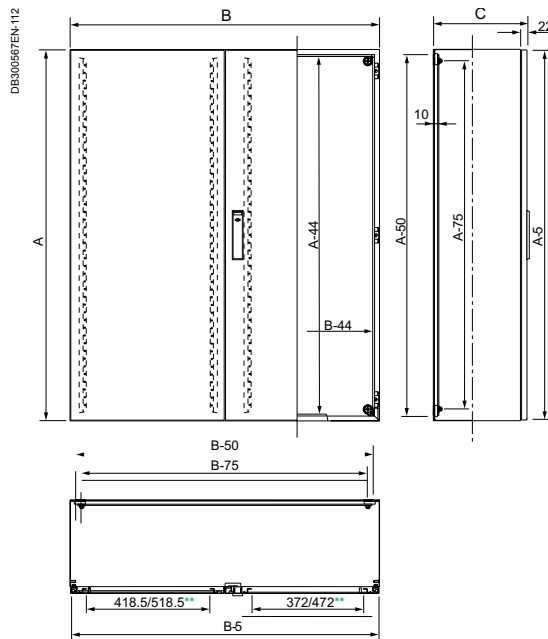
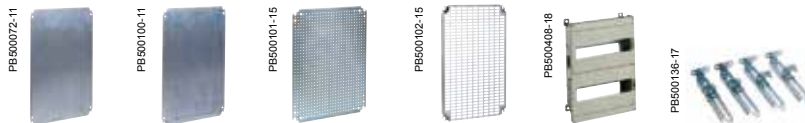

Fig. 4

\*\* For glazed door.

# Stainless-steel wall-mounting enclosures

## Accessories



External dimensions (mm)			No. of modules	References					Step slides
Height	Width	Depth		Mounting plate					
				Plain	Silkscreened	Microperforated	Telequick	Modular	
300	200	150	-	NSYMM32	-	NSYMF32	NSYMR32	-	-
		150	-	NSYMM3025	-	-	NSYMR3025	-	-
		300	-	NSYMM33	-	NSYMF33	NSYMR33	-	-
400	300	150	24	NSYMM43	NSYMS43	NSYMF43	NSYMR43	NSYDLM24	-
		200	24	NSYMM43	NSYMS43	NSYMF43	NSYMR43	NSYDLM24	NSYSDCR200
		400	-	NSYMM44	NSYMS44	NSYMF44	NSYMR44	-	NSYSDCR200
500	400	200	-	NSYMM64	NSYMS64	NSYMF64	NSYMR64	NSYDLM48P	NSYSDCR200
		250	84	NSYMM66	NSYMS66	NSYMF66	NSYMR66	NSYDLM84P	NSYSDCR250
		600	-	NSYMM106	-	NSYMF106	NSYMR106	-	NSYSDCR300
600	400	200	-	NSYMM106	-	NSYMF106	NSYMR106	-	NSYSDCR300
		250	84	NSYMM106	-	NSYMF106	NSYMR106	-	NSYSDCR300
		300	-	NSYMM106	-	NSYMF106	NSYMR106	-	NSYSDCR300
700	500	250	66	NSYMM75	NSYMS75	NSYMF75	NSYMR75	NSYDLM66	NSYSDCR250
		600	84	NSYMM86	NSYMS86	NSYMF86	NSYMR86	NSYDLM84	NSYSDCR250
		800	-	NSYMM88	-	NSYMF88	NSYMR88	-	NSYSDCR300
800	600	250	-	NSYMM108	-	NSYMF108	NSYMR108	-	NSYSDCR300
		300	-	NSYMM108	-	NSYMF108	NSYMR108	-	NSYSDCR300
		300	-	NSYMM108	-	NSYMF108	NSYMR108	-	NSYSDCR300
1000	800	300	234	NSYMM108	-	NSYMF108	NSYMR108	NSYDLM240	NSYSDCR300
		1000	-	NSYMM1010	-	NSYMF1010	NSYMR1010	-	NSYSDCR300
		1200	-	NSYMM128	-	NSYMF128	NSYMR128	-	NSYSDCR300
1200	800	300	-	NSYMM1210	-	NSYMF1210	NSYMR1210	-	NSYSDCR300
		1000	-	NSYMM1210	-	NSYMF1210	NSYMR1210	-	NSYSDCR300

\* Three-point closure system.

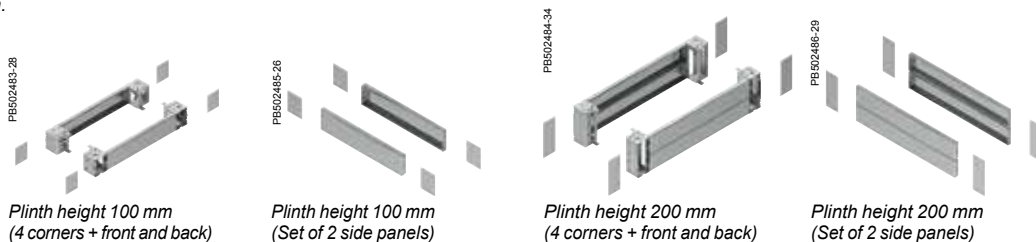

Characteristics		Plinths								
Material		Stainless-steel, AISI 304L				Stainless-steel, AISI 316L				
Finish		Scotch-Brite® brushing, to guarantee the durability in application where the contact with the floor increase the risk of corrosion								
Installation		It is necessary to order separately the plinth mounting kit (ref. NSYAPFXWM) composed by mounting hardware and drilling jig								
External dimensions (mm)		Plinth height 100 mm		Plinth height 200 mm		Plinth height 100 mm		Plinth height 200 mm		
Height (A)	Width (B)	Depth (C)	Kit (4 corners + front and back)	Set of 2 side panels	Kit (4 corners + front and back)	Set of 2 side panels (x2)	Kit (4 corners + front and back)	Set of 2 side panels	Kit (4 corners + front and back)	Set of 2 side panels (x2)
800	800	300	NSYSFPX8100	NSYSPSX3100	NSYSFPX8200	NSYSPSX3200	NSYSFPX8100H	NSYSPSX3100H	NSYSFPX8200H	NSYSPSX3200H
		1000	NSYSFPX10100	NSYSPSX3100	NSYSFPX10200	NSYSPSX3200	NSYSFPX10100H	NSYSPSX3100H	NSYSFPX10200H	NSYSPSX3200H
1200	800	300	NSYSFPX8100	NSYSPSX3100	NSYSFPX8200	NSYSPSX3200	NSYSFPX8100H	NSYSPSX3100H	NSYSFPX8200H	NSYSPSX3200H
		1000	NSYSFPX10100	NSYSPSX3100	NSYSFPX10200	NSYSPSX3200	NSYSFPX10100H	NSYSPSX3100H	NSYSFPX10200H	NSYSPSX3200H



	Cable entries	Adhesive plastic document pocket	Door switch	Lighting	Clip-on nuts	Blanking plate for modular chassis	Plain mounting plate screw	Self-tapping screw		
								M6 x 16	M5 x 13	M5 x 16
See page	266	295	295	292	246	249	-	-	-	-
Supply	10	1	1	1	100	1	100	100	100	100
References										
	-	NSYDPA44	NSYINLCRN	NSYLAMCS	NSYKNM6	NSYATP72MS	NSYS16M6HS	NSYS13M5HS	NSYS16M5HS	

# Stainless-steel wall-mounting enclosures

## Accessories



### Canopy

Material		304L stainless-steel sheet									
Finish		Scotch-Brite® brushed									
Thickness		15/10* mm									
Installation		Direct mounting to the body of the enclosure									
Supply		Delivered with the mountings required for installation									
No. of locks	No. of doors	For wall-mounting enclosures (mm)			Dimensions (mm)					References	
		Height	Width	Depth	A	B	C	D	E		
1	1	300	200	150	205	183	51	120	-	NSYTX2015	
			250	150	205	183	51	120	-	NSYTX2515	
			300	150	305	183	51	220	-	NSYTX3015	
		400	300	150	305	183	51	220	-	NSYTX3015	
			300	200	305	233	51	220	70	NSYTX3020	
			400	200	405	233	70	320	70	NSYTX4020	
2	1	500	400	200	405	233	70	320	70	NSYTX4020	
			600	400	200	405	233	70	320	70	NSYTX4020
			600	250	605	283	70	520	120	NSYTX6025	
*	2	600	1000	300	1005	333	70	920	170	NSYTX10030	
			1200	300	1205	333	70	1120	120	NSYTX12030	
2	1	600	1200	300	1205	333	70	1120	120	NSYTX12030	
			700	500	250	505	283	70	420	120	NSYTX5025
			800	600	250	605	283	70	520	120	NSYTX6025
			800	300	805	333	70	720	170	NSYTX8030	
*	2	800	1000	300	1005	333	70	920	170	NSYTX10030	
			1200	300	1205	333	70	1120	120	NSYTX12030	
2	1	800	1200	300	1205	333	70	1120	170	NSYTX12030	
			1000	800	300	805	333	70	720	170	NSYTX8030
*	2	1000	1000	300	1005	333	70	920	170	NSYTX10030	
2	1	1200	800	300	805	333	70	720	170	NSYTX8030	
*	2	1200	1000	300	1005	333	70	920	170	NSYTX10030	

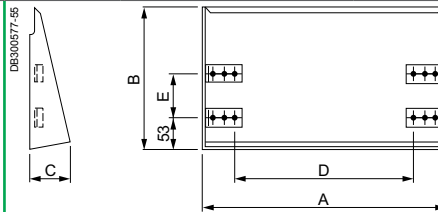

\* Three-point locking system.



### Wall-mounting brackets

Material	304 or 316L stainless-steel	
Installation	<ul style="list-style-type: none"> <li>Wall-mounting brackets can go in horizontal or vertical position</li> <li>Mounting from the outside</li> </ul>	
Maximum load	150 kg	
Supply	Set of four wall-mounting brackets	
References	304L	316L
	NSYPFCX	NSYPFC2X

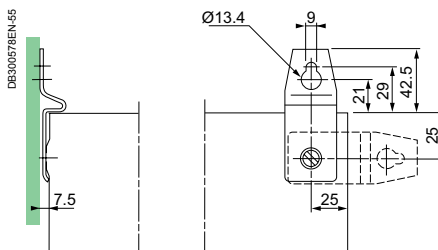

# Stainless-steel wall-mounting enclosures

## Accessories



### Inner door

Installation	<ul style="list-style-type: none"> <li>3-mm double-bar lock.</li> <li>Not compatible with door retainer and door switch. Consult us.</li> <li>As standard it can be mounted an inner door and a mounting plate, on the step slides, at the same time</li> <li>Can be mounted either on the front side of the enclosure or on step slides (not supplied with standard)</li> </ul>						
Maximum load	30 kg/m <sup>2</sup>						
Supply	1 inner door						
<b>For wall-mounting enclosures (mm)</b>	<b>Dimensions (mm)</b>	<b>References</b>					
<b>Height (A)</b>	<b>Width (B)</b>	<b>D</b>	<b>E</b>	<b>G</b>	<b>H</b>	<b>I (min.)</b>	
400	300	349	241	208	32	51	NSYPIN43
500	400	449	341	308	32	51	NSYPIN54
600	400	549	341	308	32	51	NSYPIN64
700	500	649	441	408	32	51	NSYPIN75
800	600	749	541	508	32	51	NSYPIN86*
1000	800	949	741	708	32	51	NSYPIN108*
1200	800	1149	741	708	32	52	NSYPIN128*

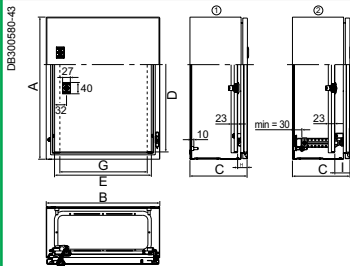

- NSYPIN inner door fixed directly to the enclosure.
- NSYPIN inner door fixed to the adjustable NSYSDCR support. In this case, both the inner door and the mounting plate may be depth adjustable.

\* Equipped with welded vertical profiles in order to facilitate cable management.

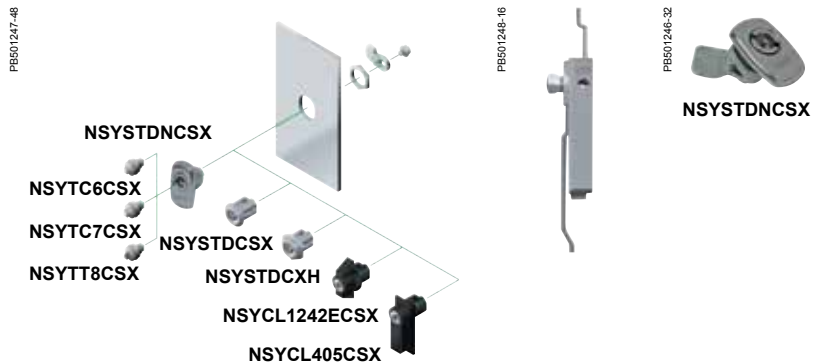

### Escutcheon

Type	Double-bar lock			Insert			Handle lock			
	Standard 3 mm	Round 3 mm (spare) 3 mm	3 mm	Triangular 8 mm	Square 7 mm	6 mm	1242E	405	610 <span style="color: red;">New</span>	Screw driver insert
Material	Chrome-plated zamak		100 % stainless-steel			Chrome-plated zamak	Polyamide		100 % stainless-steel	
Protection rating	IP66									
References	NSYSTDNCSX	NSYSTDCSX	NSYSTDCXH	NSYTT8CSX	NSYTC7CSX	NSYTC6CSX	NSYCL1242ECSX	NSYCL405CSX	NSYCL610CSX	NSYTSML

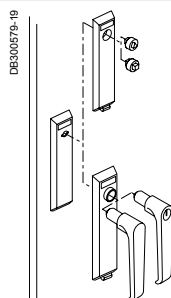

For the closures of double-door enclosures, contact us.

# Stainless-steel floor-standing enclosures

# Stainless-steel floor-standing enclosures

## Contents

P8500138-26



P8502731-22



### Spacial SMX - SFX Stainless-steel floor-standing enclosures **160**

Introduction	160
Characteristics	161
Dimensions	162
Specific accessories	164

# Stainless-steel floor-standing enclosures

## Introduction

➤ These enclosures have been specially designed for the chemical, oil and food and beverage industries, among others, which are particularly demanding in terms of hygiene and resistance to corrosion.

### SMX



PB500138-63

### SFX



PB502730-30



PB501232-36



PB500958-20



PB500141-80

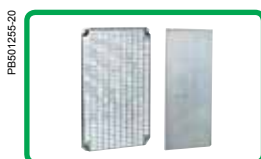

PB501255-20



PB501228-85



PB501241-40



PB501232-36

### Material and finishes

#### Stainless-steel grade:

- AISI 304L and 316L as standard (Spacial SMX).
- AISI 316L (on request) (Spacial SFX).

#### Finishes:

- Scotch-Brite® brushed (standard).
- Micro-beaded (on request).
- Painted (on request).

### Convenience and time saving

- Complete range of accessories for installation, cable management, etc.
- 316L stainless-steel plinth: easy cable entry (Spacial SMX).
- 304L or 316L stainless-steel plinth: easy cable entry (Spacial SFX).
- Reversible door opening to 120°.
- Padlock lock with key or form insert.
- Adjustment rails perforated with a pitch of 25 mm.
- Perforated reinforcement frame allowing accessories to be mounted on the door.

### Sealing

- Protection rating of IP55 (IEC 60529): complete protection against dust and water sprays.
- 3-point closures.
- Canopy (optional):
  - protects the sealing plane of the door,
  - guarantees correct water drainage,
  - no stagnation on the top.
- Single-piece cable-gland plate with polyurethane gasket.

### Compatible with the other ranges

- The mounting plates and other accessories of the Spacial SM and SF standards metal offers.

### Hygiene

- The high quality of the standard finish enables very easy maintenance while avoiding contamination.
- The hygienic feet made from 316L stainless-steel, adjustable between 140 mm and 200 mm height, make it easier to clean under the enclosures.

### Robustness and durability

- Resistance to external mechanical impacts: IK10 according to IEC 62262.
- 3 hinges made entirely from stainless-steel.
- Door reinforcement frame.

### Resistance to corrosion

- High resistance to corrosion. 304L and 316L stainless-steels provide the best solutions for applications in extremely demanding environments.

This range can be configured according to your needs

4 different services available:



Assemble to order



Mounting of standard accessories



Painting



Machining

See page 396 for details or consult our web site [www.schneider-electric.com](http://www.schneider-electric.com)



# Stainless-steel floor-standing enclosures

## Characteristics



Characteristics	Spacial SMX	Spacial SFX
	Stainless-steel sheet floor-standing enclosure, folded and welded.	<ul style="list-style-type: none"> <li>Enclosure made up of a structure, consisting of top and bottom, rear panel and vertical profiles.</li> <li>Single front door, with reinforcement frame.</li> <li>Sash-bolt handle made from painted zamak, 3 mm double bar.</li> </ul>
Material	<ul style="list-style-type: none"> <li>304L stainless-steel</li> <li>316L stainless-steel</li> </ul>	<ul style="list-style-type: none"> <li>304L stainless-steel</li> <li>316L version (on request)</li> </ul>
Finish	<ul style="list-style-type: none"> <li>Scotch-Brite® brushed finish</li> <li>Micro-beaded and painted finishes (on request)</li> </ul>	
Thickness	15/10 <sup>o</sup> mm	-
Ingress protection rating	IP55 according to IEC 60529	
Mechanical protection rating	IK10 according to IEC 62262	
Standards	IEC 62208	
Certifications	<ul style="list-style-type: none"> <li>UL 508A</li> <li>CAN/CSA C22.2 No. 14</li> <li>NEMA:                             <ul style="list-style-type: none"> <li>1 door enclosure: type 1, 2, 3, 3R, 4, 4X, 5, 12, 12K, 13</li> <li>2 doors enclosure: type 1, 12, 12K, 13</li> </ul> </li> </ul>	<ul style="list-style-type: none"> <li>CAN/CSA C22.2 No. 14</li> <li>NEMA:                             <ul style="list-style-type: none"> <li>1 door enclosure: type 1, 2, 3, 3R, 4, 4X, 5, 12, 12K, 13</li> <li>2 doors enclosure: type 1, 12, 12K, 13</li> </ul> </li> </ul>
Installation	Outdoor installation: compliant with IEC 62208 regarding type tests specified in §9.12 (resistance to ultra-violet (UV) radiation) and §9.13 (resistance to corrosion). It is always advisable to install a canopy to avoid water stagnation on the upper part of the enclosure	
Other characteristics	<ul style="list-style-type: none"> <li>Plain front door. Opening to left or right to 120° with reinforcement frame installed:                             <ul style="list-style-type: none"> <li>3 stainless-steel hinges</li> <li>3-point closure with handle made from painted zamak, 5-mm double bar</li> <li>acceptable load of 50 kg</li> </ul> </li> </ul>	
Supply	<ul style="list-style-type: none"> <li>Welded rear panel</li> <li>Single-piece cable-gland plate delivered</li> <li>Delivered with 4 mounting plate-supporting brackets</li> </ul>	<ul style="list-style-type: none"> <li>Welded rear panel</li> <li>4 mounting plate-supporting brackets</li> <li>Single-piece cable-gland plate with sealing gasket</li> </ul> <p><i>Note: the panels and plinths can be installed and the enclosures can be assembled (on request)</i></p>

External dimensions (mm)			Number of front doors	Stainless-steel enclosure		Stainless-steel suitable enclosure
Height (A)	Width (B)	Depth (C)		304L	316L	304L
1400	1000	300	2	NSYSMX141030	-	-
1600	800	400	1	NSYSMX16840	-	-
1800	600	400	1	NSYSMX18640	-	NSYSFX18640
	800	400	1	NSYSMX18840	NSYSMX18840H	NSYSFX18840
	1200	400	2	NSYSMX181240	NSYSMX181240H	NSYSFX181240
	1600	400	2	NSYSMX181640	NSYSMX181640H	-
2000	600	500	1	-	-	NSYSFX20650
	800	400	1	-	-	NSYSFX20840
	800	500	1	NSYSMX20850	-	-
	800	600	1	-	-	NSYSFX20860
	1000	400	2	NSYSMX201040	NSYSMX201040H	-
	1000	600	2	-	-	NSYSFX201060
	1200	500	2	NSYSMX201250	NSYSMX201250H	-
	1200	600	2	-	-	NSYSFX201260
1600	600	2	NSYSMX201660	NSYSMX201660H	-	

# Stainless-steel floor-standing enclosures

## Dimensions

SMX

Floor-standing enclosure dimensions (mm)			No. of cableglad plates	Dimensions (mm)	
Height (A)	Width (B)	Depth (C)		E	F
1400	1000	300	1	720	270
1600	800	400	1	520	270
1800	600	400	1	520	270
	800	400	1	520	270
	1200	400	1	920	270
	1600	400	2	1320	270
2000	800	500	1	520	370
	1000	400	1	720	270
	1200	500	1	920	370
	1600	600	2	1320	470

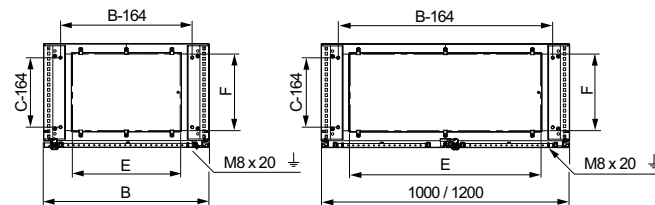
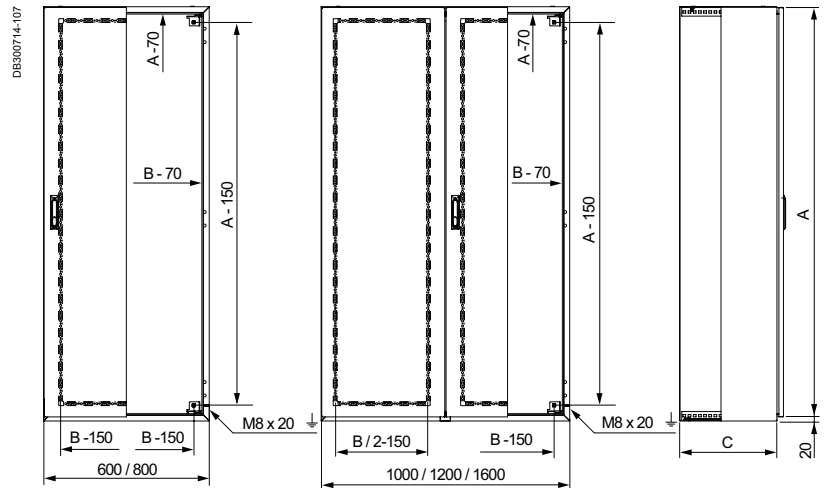

Enclosure width of 1000 and 1200 mm.

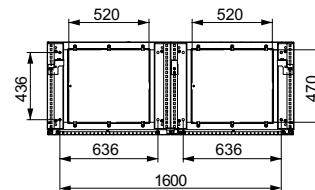

Enclosure width of 1600 mm.

# Stainless-steel floor-standing enclosures

## Dimensions



External dimensions (mm)			Number of front doors
Height (A)	Width (B)	Depth (C)	
1800	600	400	1
	800	400	1
	1200	400	2
2000	600	500	1
	800	400	1
	800	600	1
	1000	600	2
	1200	600	2

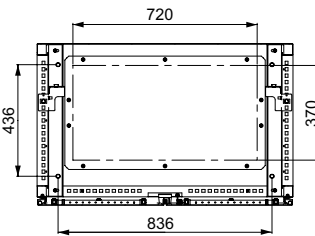
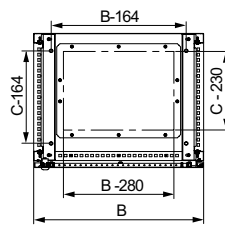
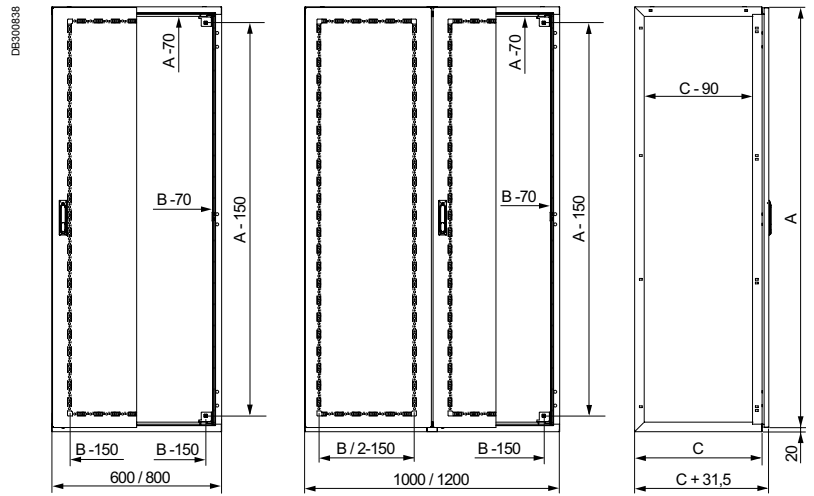

Enclosure width 1000.

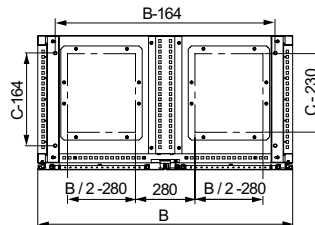

Enclosure width 1200 mm.

# Stainless-steel floor-standing enclosures

## Specific accessories

SMX



Plinth height 100 mm  
(4 corners + front and back)



Plinth height 100 mm  
(Set of 2 side panels)



Plinth height 200 mm  
(4 corners + front and back)

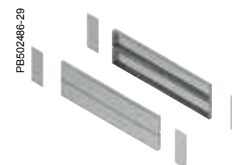

Plinth height 200 mm  
(Set of 2 side panels)

Characteristics		Stainless-steel plinths									
Material		Stainless-steel, AISI 304L				Stainless-steel, AISI 316L					
Finish		Scotch-Brite® brushing, to guarantee the durability in application where the contact with the floor increase the risk of corrosion									
Installation		Mounting in the holes for mounting the enclosures to the floor Suitable for steel floor-standing enclosures (SF and SM)									
External dimensions (mm)		Plinth height 100 mm		Plinth height 200 mm		Plinth height 100 mm		Plinth height 200 mm			
Height (A)	Width (B)	Depth (C)	Kit (4 corners + front and back)	Set of 2 side panels	Kit (4 corners + front and back)	Set of 2 side panels (x2)	Kit (4 corners + front and back)	Set of 2 side panels	Kit (4 corners + front and back)	Set of 2 side panels (x2)	
1400	1000	300	NSYSPFX10100	NSYSPSX3100	NSYSPFX10200	NSYSPSX3200	NSYSPFX10100H	NSYSPSX3100H	NSYSPFX10200H	NSYSPSX3200H	
1600	800	400	NSYSPFX8100	NSYSPSX4100	NSYSPFX8200	NSYSPSX4200	NSYSPFX8100H	NSYSPSX4100H	NSYSPFX8200H	NSYSPSX4200H	
1800	600	400	NSYSPFX6100	NSYSPSX4100	NSYSPFX6200	NSYSPSX4200	-	NSYSPSX4100H	-	NSYSPSX4200H	
		800	400	NSYSPFX8100	NSYSPSX4100	NSYSPFX8200	NSYSPSX4200	NSYSPFX8100H	NSYSPSX4100H	NSYSPFX8200H	NSYSPSX4200H
		1200	400	NSYSPFX12100	NSYSPSX4100	NSYSPFX12200	NSYSPSX4200	NSYSPFX12100H	NSYSPSX4100H	NSYSPFX12200H	NSYSPSX4200H
2000	600	400	NSYSPFX16100	NSYSPSX4100	NSYSPFX16200	NSYSPSX4200	NSYSPFX16100H	NSYSPSX4100H	NSYSPFX16200H	NSYSPSX4200H	
		800	400	NSYSPFX8100	NSYSPSX4100	NSYSPFX8200	NSYSPSX4200	NSYSPFX8100H	NSYSPSX4100H	NSYSPFX8200H	NSYSPSX4200H
		800	500	NSYSPFX8100	NSYSPSX5100	NSYSPFX8200	NSYSPSX5200	NSYSPFX8100H	NSYSPSX5100H	NSYSPFX8200H	NSYSPSX5200H
		800	600	NSYSPFX8100	NSYSPSX6100	NSYSPFX8200	NSYSPSX6200	NSYSPFX8100H	NSYSPSX6100H	NSYSPFX8200H	NSYSPSX6200H
		1000	400	NSYSPFX10100	NSYSPSX4100	NSYSPFX10200	NSYSPSX4200	NSYSPFX10100H	NSYSPSX4100H	NSYSPFX10200H	NSYSPSX4200H
		1000	600	NSYSPFX10100	NSYSPSX6100	NSYSPFX10200	NSYSPSX6200	NSYSPFX10100H	NSYSPSX6100H	NSYSPFX10200H	NSYSPSX6200H
		1200	500	NSYSPFX12100	NSYSPSX5100	NSYSPFX12200	NSYSPSX5200	NSYSPFX12100H	NSYSPSX5100H	NSYSPFX12200H	NSYSPSX5200H
1200	600	NSYSPFX12100	NSYSPSX6100	NSYSPFX12200	NSYSPSX6200	NSYSPFX12100H	NSYSPSX6100H	NSYSPFX12200H	NSYSPSX6200H		
1600	600	NSYSPFX16100	NSYSPSX6100	NSYSPFX16200	NSYSPSX6200	NSYSPFX16100H	NSYSPSX6100H	NSYSPFX16200H	NSYSPSX6200H		



The ventilated plinths in stainless steel 200 mm of Outdoor Heavy Duty enclosures (page 339) are compatible with the stainless steel monobloc and suitable enclosures.

# Stainless-steel floor-standing enclosures

## Specific accessories

SFX



Plinth height 100 mm  
(4 corners + front and back)



Plinth height 100 mm  
(Set of 2 side panels)



Plinth height 200 mm  
(4 corners + front and back)

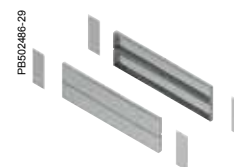

Plinth height 200 mm  
(Set of 2 side panels)

Characteristics		Stainless-steel plinths								
Material	Stainless-steel, AISI 304L				Stainless-steel, AISI 316L					
Finish	Scotch-Brite® brushing, to guarantee the durability in application where the contact with the floor increase the risk of corrosion									
Installation	Mounting in the holes for mounting the enclosures to the floor Suitable for steel floor-standing enclosures (SF and SM)									
External dimensions (mm)		Plinth height 100 mm		Socles hauteur 200 mm		Plinth height 100 mm		Plinth height 200 mm		
Height (A)	Width (B)	Depth (C)	Kit (4 corners + front and back)	Set of 2 side panels	Kit (4 corners + front and back)	Set of 2 side panels (x2)	Kit (4 corners + front and back)	Set of 2 side panels	Kit (4 corners + front and back)	Set of 2 side panels (x2)
1400	1000	300	NSYSPFX10100	-	NSYSPFX10200	-	NSYSPFX10100H	-	NSYSPFX10200H	-
1600	800	400	NSYSPFX8100	NSYSPSX4100SF	NSYSPFX8200	NSYSPSX4200SF	NSYSPFX8100H	NSYSPSX4100H	NSYSPFX8200H	NSYSPSX4200H
1800	600	400	NSYSPFX6100	NSYSPSX4100SF	NSYSPFX6200	NSYSPSX4200SF	-	NSYSPSX4100H	-	NSYSPSX4200H
	800	400	NSYSPFX8100	NSYSPSX4100SF	NSYSPFX8200	NSYSPSX4200SF	NSYSPFX8100H	NSYSPSX4100H	NSYSPFX8200H	NSYSPSX4200H
	1200	400	NSYSPFX12100	NSYSPSX4100SF	NSYSPFX12200	NSYSPSX4200SF	NSYSPFX12100H	NSYSPSX4100H	NSYSPFX12200H	NSYSPSX4200H
	1600	400	-	NSYSPSX4100SF	-	NSYSPSX4200SF	-	NSYSPSX4100H	-	NSYSPSX4200H
2000	600	500	NSYSPFX6100	NSYSPSX5100SF	NSYSPFX6200	NSYSPSX5200SF	-	NSYSPSX5100H	-	NSYSPSX5200H
	800	400	NSYSPFX8100	NSYSPSX4100SF	NSYSPFX8200	NSYSPSX4200SF	NSYSPFX8100H	NSYSPSX4100H	NSYSPFX8200H	NSYSPSX4200H
	800	500	NSYSPFX8100	NSYSPSX5100SF	NSYSPFX8200	NSYSPSX5200SF	NSYSPFX8100H	NSYSPSX5100H	NSYSPFX8200H	NSYSPSX5200H
	800	600	NSYSPFX8100	NSYSPSX6100SF	NSYSPFX8200	NSYSPSX6200SF	NSYSPFX8100H	NSYSPSX6100H	NSYSPFX8200H	NSYSPSX6200H
	1000	400	NSYSPFX10100	NSYSPSX4100SF	NSYSPFX10200	NSYSPSX4200SF	NSYSPFX10100H	NSYSPSX4100H	NSYSPFX10200H	NSYSPSX4200H
	1000	600	NSYSPFX10100	NSYSPSX6100SF	NSYSPFX10200	NSYSPSX6200SF	NSYSPFX10100H	NSYSPSX6100H	NSYSPFX10200H	NSYSPSX6200H
	1200	500	NSYSPFX12100	NSYSPSX5100SF	NSYSPFX12200	NSYSPSX5200SF	NSYSPFX12100H	NSYSPSX5100H	NSYSPFX12200H	NSYSPSX5200H
	1200	600	NSYSPFX12100	NSYSPSX6100SF	NSYSPFX12200	NSYSPSX6200SF	NSYSPFX12100H	NSYSPSX6100H	NSYSPFX12200H	NSYSPSX6200H
1600	600	-	NSYSPSX6100SF	-	NSYSPSX6200SF	-	NSYSPSX6100H	-	NSYSPSX6200H	



The ventilated plinths in stainless steel 200 mm of Outdoor Heavy Duty enclosures (page 339) are compatible with the stainless steel monobloc and suitable enclosures.

# Stainless-steel floor-standing enclosures

## Specific accessories

**SMX**

PB501259-24



**SFX**

PB501239-30



Characteristics		Canopy	
		Guarantees very high protection of the enclosure when used outdoors.	
Material	<ul style="list-style-type: none"> <li>■ 304L stainless-steel sheet</li> <li>■ Other types of stainless-steel, contact us</li> </ul>		
Finish	<ul style="list-style-type: none"> <li>■ Scotch-Brite® brushed</li> <li>■ Other finishes, contact us</li> </ul>		
Thickness	15/10° mm		
Installation	It is fixed in the same holes as the eyebolt. Delivered with mountings. Other dimensions and canopy for sets, contact us		
<b>External dimensions (mm)</b>		<b>Top-mounting</b>	
<b>Height (A)</b>	<b>Width (B)</b>	<b>Depth (C)</b>	
1400	1000	300	NSYSCX10030
1600	800	400	NSYSCX8040
1800	600	400	NSYSCX6040
	800	400	NSYSCX8040
	1200	400	NSYSCX12040
	1600	400	NSYSCX16040
2000	600	500	NSYSCX6050
	800	400	NSYSCX8040
	800	500	NSYSCX8050
	800	600	NSYSCX8060
	1000	400	NSYSCX10040
	1000	600	NSYSCX10060
	1200	500	NSYSCX12050
	1200	600	NSYSCX12060
	1600	600	NSYSCX16060

PB501259-SE-17



PB501260-SE-19



Characteristics	Closure option									
	Spare handle.	5 mm double-bar insert.	Square insert.			Triangular insert.		Padlocking device.	Barrel and key 405E.	Barrel and key 610. <span style="color: red; font-weight: bold;">New</span>
Material	<ul style="list-style-type: none"> <li>■ The enclosures are delivered as standard with handle made from painted zamak, 5 mm double bar (1242E, 405E, 455E, 6.5 mm triangle available)</li> <li>■ Large range of standard inserts available</li> </ul>									
Supply	1 pack	1 pack	1 pack	1 pack	1 pack	1 pack	1 pack	1 pack	1 pack	1 pack
<b>References</b>	<b>NSYMCXSX</b>	<b>NSYTDB5ME</b>	<b>NSYTC6ME</b>	<b>NSYTC7ME</b>	<b>NSYTC8ME</b>	<b>NSYTT6ME</b>	<b>NSYTT8ME</b>	<b>NSYBCME</b>	<b>NSYTCL405ME</b>	<b>NSYTCL610ME</b>

ISPA011\_001-35



ISPA011\_002-40



Door switch	
	<b>For Spacial SFX</b>
See page	295
Supply	1
<b>Reference</b>	<b>NSYDCM20</b>

# Stainless-steel floor-standing enclosures

## Specific accessories

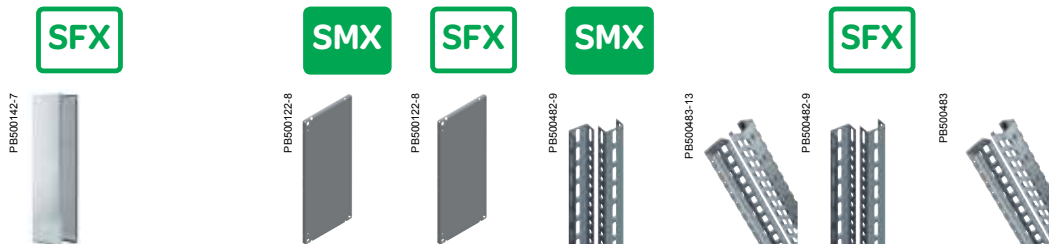

Characteristics			Side panels	Plain mounting plate		Uprights vertical			
			<ul style="list-style-type: none"> <li>Side panels including a polyurethane sealing gasket.</li> <li>Their special design guarantees the protection of the door gasket.</li> <li>304L stainless-steel sheet</li> </ul>	-	-	-	-	-	-
Material			-	-	-	-	-	-	-
External dimensions (mm)						Standard	Technical	Standard	Technical
Height (A)	Width (B)	Depth (C)							
1400	1000	300	-	NSYMP1410	-	-	NSYTVR14	-	-
1600	800	400	-	NSYMP168	-	-	NSYTVR16	-	-
1800	600	400	NSY2SPX184	NSYMP186	NSYMP186	NSYVR18	NSYTVR18	NSYVR18	NSYVR18
	800	400	NSY2SPX184	NSYMP188	NSYMP188	NSYVR18	NSYTVR18	NSYVR18	NSYVR18
	1200	400	NSY2SPX184	NSYMP1812	NSYMP1812	NSYVR18	NSYTVR18	NSYVR18	NSYVR18
	1600	400	-	NSYMP1816	-	NSYVR18	NSYTVR18	-	-
2000	600	500	NSY2SPX205	-	NSYMP206	-	-	NSYVR20	NSYVR20
	800	400	NSY2SPX204	-	NSYMP208	-	-	NSYVR20	NSYVR20
	800	500	NSY2SPX205	NSYMP208	-	NSYVR20	NSYTVR20	-	-
	800	600	NSY2SPX206	-	NSYMP208	-	-	NSYVR20	NSYVR20
	1000	400	-	NSYMP2010	-	NSYVR20	NSYTVR20	-	-
	1000	600	NSY2SPX206	-	NSYMP2010	-	-	NSYVR20	NSYVR20
	1200	500	-	NSYMP2012	-	NSYVR20	NSYTVR20	-	-
	1200	600	NSY2SPX206	-	NSYMP2012	-	-	NSYVR20	NSYVR20
	1600	600	-	NSYMP2016	-	NSYVR20	NSYTVR20	-	-



Characteristics	Eyebolts	Lifting bracket	Wall-mounting brackets	Hygienic feet	Coupling kit
	-	For SFX.	For SMX.	Recommended for applications that require special hygiene conditions.	For SFX. Used for joining enclosures side by side.
Material	Treated moulded steel	Treated steel	304L stainless-steel	316L stainless-steel	<ul style="list-style-type: none"> <li>Flat connectors and brackets: zinc-coated steel</li> <li>Sealing gasket: EPDM</li> </ul>
Ingress protection rating	-	-	-	-	IP55
Installation	With mounting nuts supplied with the enclosure	They are mounted instead of the eyebolts on two suitable enclosures side-by-side, guaranteeing the rigidity of the enclosure when lifted	<ul style="list-style-type: none"> <li>Wall-mounting brackets can go in horizontal or vertical position</li> <li>Mounting from the outside</li> </ul>	Adjustable between 140 mm and 200 mm height	Mounting from the inside of the enclosures
Maximum load	830 kg when slinging at 60°	2000 kg when slinging at 60°	<ul style="list-style-type: none"> <li>Horizontal: 180 kg</li> <li>Vertical: 350 kg</li> </ul>	Per foot: 100 kg	-
Supply	Set of four M12 eyebolts	Set of four lifting brackets	Set of four wall-mounting brackets	Set of 4 adjustable feet	-
References	NSYSMEB	NSYPUNX	NSYFCMX	NSYPHX200	NSYSFBK19 + NSYSFXJG

# Insulating boxes





### Thalassa TBS - TBP Insulating industrial boxes **170**

Introduction	170
Characteristics	171
Selection guide	172
Dimensions	174
Specific accessories	178
Common accessories	183



### Thalassa PLS Insulating modular boxes **184**

Introduction	184
Characteristics	185
Selection guide	186
Dimensions	188
Accessories	189

**New**

#### Early 2016, the PLS range changes color

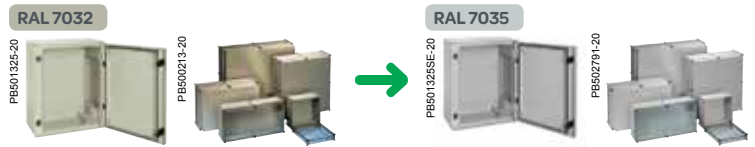

> **Why change?**

To harmonize the Schneider Electric Universal enclosures offer. Answer to customer requests and to the the market trends.

> **What happen with the part numbers (references)?**

Every product that has changed in colour also has a changed part number. The letter "G" has been added at the end on reference. *Example:*

RAL 7032	RAL 7035
NSYPLM43	NSYPLM43G

> **How can I obtain RAL 7032 enclosures?**  
Consult us.

> **Will the new RAL 7035 colour offer the same properties as RAL 7032?**  
Yes, all mechanical properties will be the same. The light reflexion is even improved.

**> Insulating industrial boxes:**

- ABS for conventional applications (IK07) with the usual constraints,
- polycarbonate for enhanced impact resistance (IK08) and for outdoor applications or applications directly exposed to UV,
- polycarbonate certified UL,
- IP55 rating for all ranges,
- Protection against electrical impacts Class II.

PB500248E55



PB500271-32



**Easy to install**

3 methods of mounting the box to its support.

PB5002073-72



**Easy to use**

Only one tool is required: a flat screwdriver.

PB500091



**Smart**

Mounting studs on the cover.

**This range can be configured according to your needs**

**4 different services available:**



Assemble to order



Mounting of standard accessories



Painting



Machining

See page 396 for details or consult our web site [www.schneider-electric.com](http://www.schneider-electric.com)

# Insulating industrial boxes

## Characteristics



Characteristics	Universal boxes with IP66	Equipped button boxes, in ABS with IP54	ABS boxes for buttons, to be equipped
	<ul style="list-style-type: none"> <li>Boxes that can be coupled (exactly the same dimensions) with kit ref. <b>13934</b>.</li> <li>Locks from box size of 116 x 116 x 62 mm:                             <ul style="list-style-type: none"> <li>cover locking by 4 plastic captive screws with coarse thread outside the sealed area,</li> <li>plumbable lock.</li> </ul> </li> <li>Locks from box size of 138 x 93 x 72 mm:                             <ul style="list-style-type: none"> <li>the standard screws (flat screwdriver) can be replaced with other standardised screws (page 178).</li> <li>The 4 "legs" of the cover ensure its robustness and perfect support during customisation operations.</li> </ul> </li> <li>Adaptable hinges on all the 20- and 40-mm covers (page 180).</li> </ul>		
Material	<ul style="list-style-type: none"> <li><b>ABS boxes:</b> <ul style="list-style-type: none"> <li>glow wire resistance: 650°C according to IEC 60695-2-11</li> <li>usage temperature: -25°C...+60°C</li> <li>installation temperature: -15°C...+40°C</li> </ul> </li> <li><b>Polycarbonate boxes:</b> <ul style="list-style-type: none"> <li>glow wire resistance: 960°C</li> <li>usage temperature: -25°C...+80°C</li> <li>installation temperature: -15°C...+60°C</li> </ul> </li> </ul>	<ul style="list-style-type: none"> <li><b>ABS boxes:</b> <ul style="list-style-type: none"> <li>glow wire resistance: 650°C according to IEC 60695-2-11</li> <li>usage temperature: -25°C...+60°C</li> <li>installation temperature: -15°C...+40°C</li> </ul> </li> </ul>	
Colour	<ul style="list-style-type: none"> <li>Body: RAL 7035 grey</li> <li>Cover: RAL 7035 grey or tinted transparent</li> </ul>		
Ingress protection rating	IP66	IP54	-
Mechanical protection rating	<b>ABS:</b> IK07 (2J) according to IEC 62262 <b>Polycarbonate:</b> IK08 (2J) according to IEC 62262	<b>ABS:</b> IK07 (2J) according to IEC 62262	
Standards	IEC 62208		
Certifications	<ul style="list-style-type: none"> <li>IEC 62208 certified by TÜV</li> <li>SEMKO, DEMKO</li> <li>UL 508A: polycarbonate range</li> <li>Product Environmental Profile</li> <li>NEMA 4.4X according to NEMA 250</li> <li>Class II according to IEC 61140</li> <li>Self-extinguishing: UL 94-V0</li> </ul>	<ul style="list-style-type: none"> <li>IEC 62208 certified by TÜV</li> <li>SEMKO, DEMKO</li> <li>UL 508A: polycarbonate range</li> <li>Product Environmental Profile</li> <li>NEMA 4.4X according to NEMA 250 and UL 50/50E</li> <li>Class II according to IEC 61140</li> </ul>	
Installation	<p><b>Mounting the box</b></p> <ul style="list-style-type: none"> <li>Outside the sealed sensitive volume by the 4 chimneys in the corners from box size of 138 x 93 x 72 mm</li> <li>Through the rear of the box by 2 or 4 elongated holes to be perforated</li> <li>With mounting brackets from box size of 116 x 116 x 62 mm (ref. <b>NSYAEFTB</b>)</li> </ul> <p><b>Outdoor installation:</b> compliant with IEC 62208 regarding type tests specified in §9.12 (resistance to ultra-violet (UV) radiation) and §9.13 (resistance to corrosion). It is always advisable to install a canopy to avoid water stagnation on the upper part of the enclosure</p> <p><b>Equipment installation</b></p> <ul style="list-style-type: none"> <li>Studs for mounting the equipment in the body and the cover of the box by means of a Ø 4-mm self-tapping screw (ref. <b>NSYAMFSTB</b>, screw Ø 4 x 10 mm with Pozidriv and slotted head)</li> <li>Option of installing rails, plates (page 181) or other types of supports (card, etc.)</li> <li>Spacers and stand-offs to be installed on the studs, for adjusting the height of the equipment</li> </ul>		
Other characteristics	<ul style="list-style-type: none"> <li><b>Thermal dissipation:</b> <ul style="list-style-type: none"> <li>use a suitable calculation method according to IEC 60890</li> <li>anti-condensation valves available as an accessory, prevent the build-up of moisture inside the box</li> </ul> </li> </ul>	<ul style="list-style-type: none"> <li><b>Thermal dissipation:</b> <ul style="list-style-type: none"> <li>use a suitable calculation method according to IEC 60890</li> <li>anti-condensation valves available as an accessory, prevent the build-up of moisture inside the box</li> </ul> </li> </ul>	

# Insulating industrial boxes

## Selection guide



Overall external dimensions			Overall internal dimensions			Body	Cover	Minor pack.	Cover screw	Universal boxes with IP66			
(mm)			(mm)			(mm)	(mm)			ABS IP66 IK07		PC-UL IP66 IK08	
Height	Width	Depth	Height	Width	Depth					Opaque cover	Transparent cover	Opaque cover	Transparent cover
74	74	54	65	65	47	37	10	5	Metal	NSYTBS775	-	NSYTBP775	-
89	89	54	80	80	47	37	10	5	Metal	NSYTBS885	-	NSYTBP885	-
116	74	62	105	65	55	45	10	5	Metal	NSYTBS1176	-	NSYTBP1176	-
		94	105	65	85	45	40	3	Metal	NSYTBS1179H	-	-	-
	116	62	105	105	55	45	10	5	Plastic	NSYTBS11116	-	NSYTBP11116	-
		133	105	105	125	45	80	2	Plastic	NSYTBS111113H	-	-	-
138	93	72	125	80	65	45	20	2	Plastic	NSYTBS1397	NSYTBS1397T	NSYTBP1397	NSYTBP1397T
164	121	87	150	105	80	60	20	2	Plastic	NSYTBS16128	NSYTBS16128T	NSYTBP16128	NSYTBP16128T
192	121	87	175	105	80	60	20	2	Plastic	NSYTBS19128	NSYTBS19128T	NSYTBP19128	NSYTBP19128T
		105	175	105	100	60	40	2	Plastic	NSYTBS191210H	NSYTBS191210HT	NSYTBP191210H	NSYTBP191210HT
	164	87	175	150	80	60	20	1	Plastic	NSYTBS19168	NSYTBS19168T	NSYTBP19168	NSYTBP19168T
		105	175	150	100	60	40	1	Plastic	NSYTBS191610H	NSYTBS191610HT	NSYTBP191610H	NSYTBP191610HT
241	194	87	225	175	80	60	20	1	Plastic	NSYTBS24198	NSYTBS24198T	NSYTBP24198	NSYTBP24198T
		107	225	175	100	80	20	1	Plastic	NSYTBS241910	NSYTBS241910T	NSYTBP241910	NSYTBP241910T
		107	225	175	100	60	40	1	Plastic	NSYTBS241910H	NSYTBS241910HT	NSYTBP241910H	NSYTBP241910HT
		127	225	175	120	80	40	1	Plastic	NSYTBS241912H	NSYTBS241912HT	NSYTBP241912H	NSYTBP241912HT
291	241	88	275	225	80	60	20	1	Plastic	NSYTBS29248	NSYTBS29248T	NSYTBP29248	NSYTBP29248T
		128	275	225	120	100	20	1	Plastic	NSYTBS292412	NSYTBS292412T	NSYTBP292412	NSYTBP292412T
		128	275	225	120	60	60	1	Plastic	NSYTBS292412H	NSYTBS292412HT	NSYTBP292412H	NSYTBP292412HT
		168	275	225	160	100	60	1	Plastic	NSYTBS292416H	NSYTBS292416HT	NSYTBP292416H	NSYTBP292416HT
341	291	128	325	275	120	100	20	1	Plastic	NSYTBS342912	NSYTBS342912T	NSYTBP342912	NSYTBP342912T
		168	325	275	160	100	60	1	Plastic	NSYTBS342916H	NSYTBS342916HT	NSYTBP342916H	NSYTBP342916HT

# Insulating industrial boxes

## Selection guide



Overall external dimensions (mm)			Overall internal dimensions (mm)			Body (mm)	Cover (mm)	Minor pack.	Boxes equipped with IP54 ABS buttons	ABS button boxes, to be equipped				
Height	Width	Depth	Height	Width	Depth				Function	References	No. of holes	Cover	References	
74	74	83	-	-	-	-	-	1	Emergency switching off	<b>XALEK1702</b> (1)	-	-	-	
116	74	62	105	65	55	45	10	5	-	-	2	Grey	<b>XALE2</b>	
		62	105	65	55	45	10	5	-	-	3	Grey	<b>XALE3</b>	
		75	-	-	-	-	-	-	1	Start / stop	<b>XALE2141</b>	-	-	-
		75	-	-	-	-	-	-	1	Up / down / stop	<b>XALE3255</b>	-	-	-

(1) Ref. **XALEK1702** houses an emergency switching off palm button with mechanical locking according to standards IEC 60364-5-53 and 60947-5-5.

### Button description

- Emergency switching off function with a red, Ø 40 mm, "turn to unlock" palm button.
- Start / Stop function with 2 push buttons.
- Up / Down / Stop function with 3 push buttons.
- Technical features of the switches:
  - "NC" switch with positive opening manoeuvre according to IEC 60947-5-1 appendix K,
  - mechanical durability of the emergency switch: 0.1 million cycles,
  - mechanical durability of the "NC" and "NO" switches: 5 million cycles,
  - protection against short circuits: 10 A.

Function	Type			Type of push
	"NO"	"NC"	"C / O"	
Emergency switching off	1	1	-	Latching, red
Start/stop				
Start	1	-	-	Flush, green
Stop	-	1	-	Projecting, red
Up / down / stop				
Up	-	-	1	Flush, black
Down	-	-	1	Flush, white
Stop	-	1	-	Projecting, red
	DE300033	DE300033	DE300033	

# Insulating industrial boxes

## Dimensions

### Box of 74 x 74 x 54 mm (external dimensions) NSYTB...775

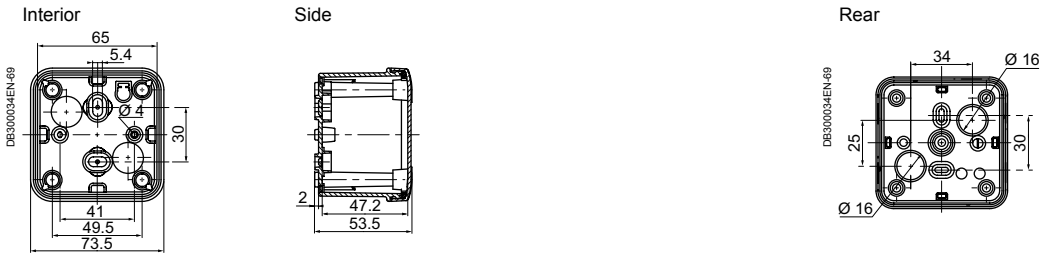

### Box of 89 x 89 x 54 mm (external dimensions) NSYTB...885

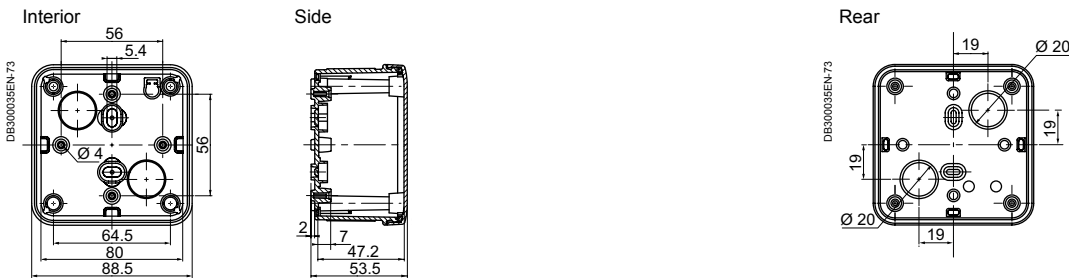

### Box of 116 x 74 x 62 or 94 mm (external dimensions) NSYTB...1176 or NSYTB...1179

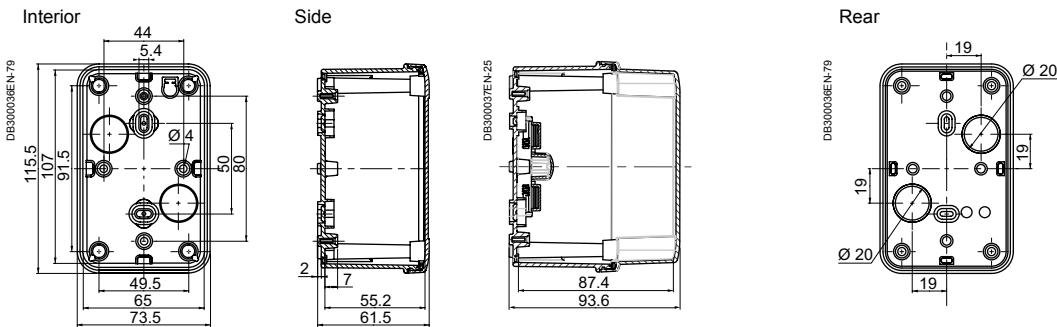

### Box of 116 x 116 x 62 or 133 mm (external dimensions) NSYTB...11116 or NSYTB...11113

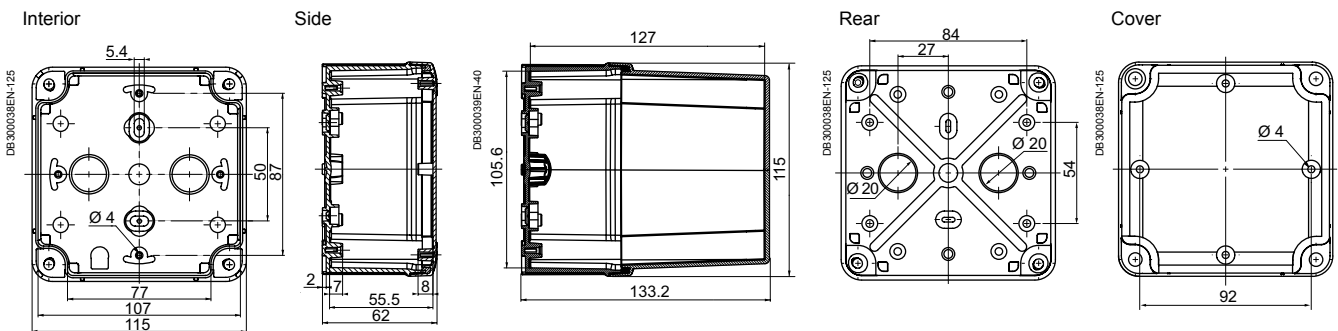

### Box of 138 x 93 x 72 mm (external dimensions) NSYTB...1397

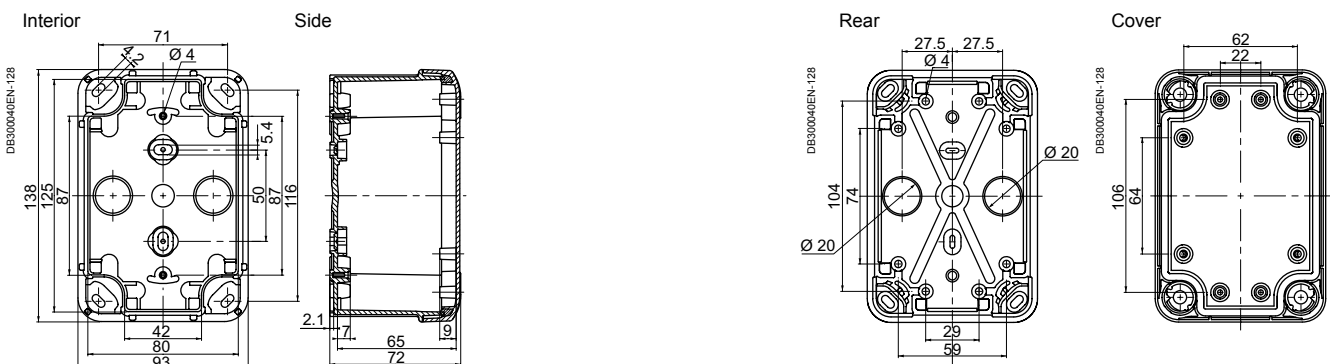

# Insulating industrial boxes

## Dimensions

### Box of 164 x 121 x 87 mm (external dimensions) NSYTB...16128

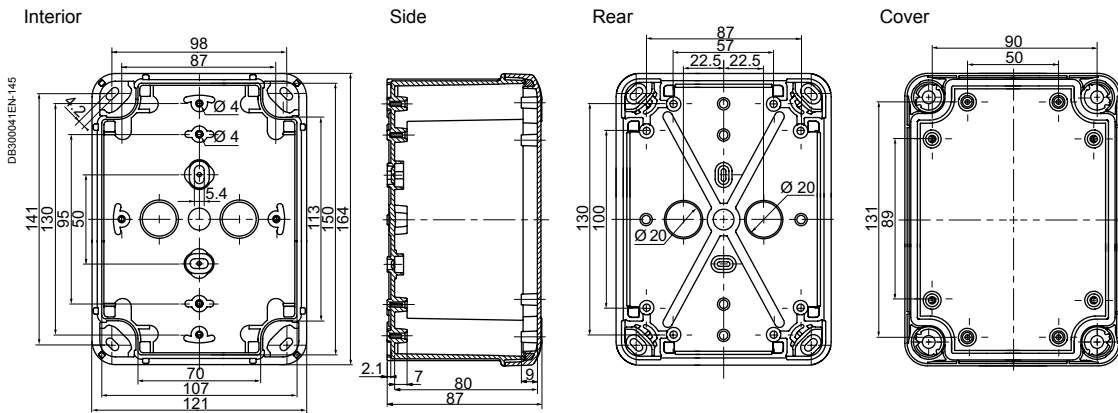

### Box of 192 x 121 x 87 or 105 mm (external dimensions) NSYTB...19128 or NSYTB...191210

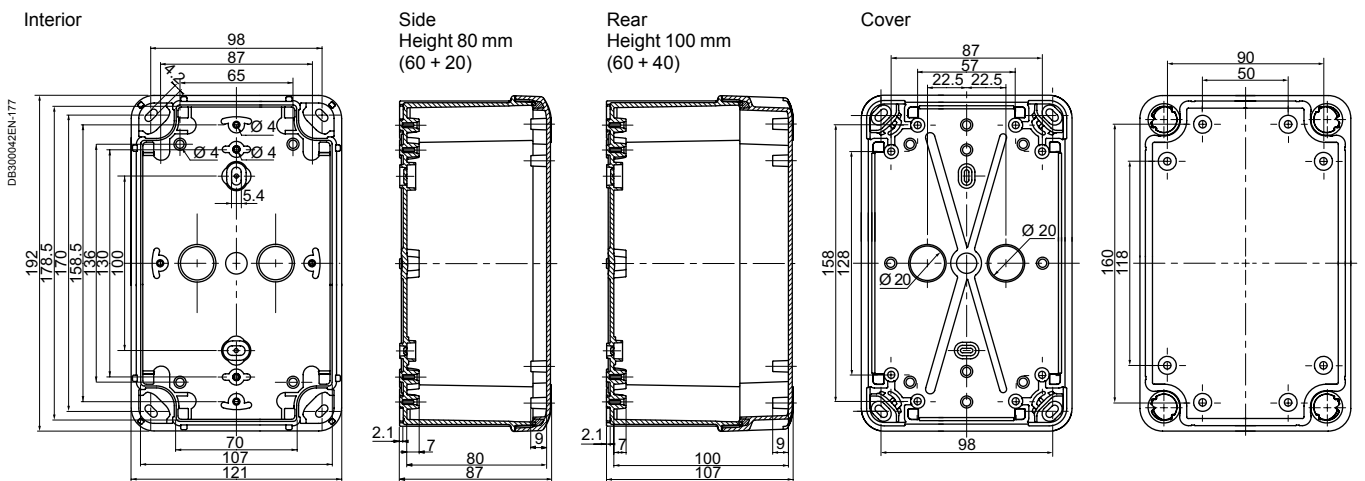

### Box of 192 x 164 x 87 or 105 mm (external dimensions) NSYTB...19168 or NSYTB...191610

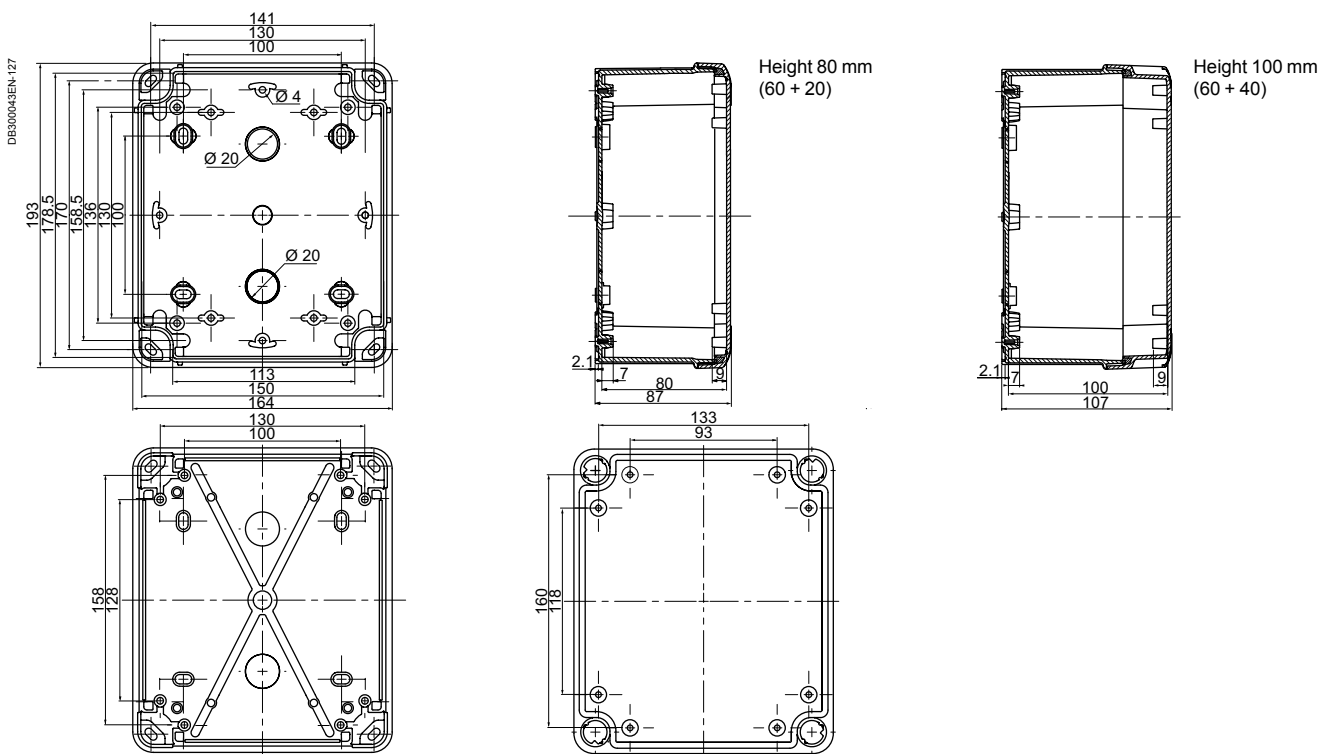

# Insulating industrial boxes

## Dimensions

**Box of 241 x 194 x 87, 107 or 127 mm (external dimensions) NSYTB...24198, NSYTB...241910 or NSYTB...241912**

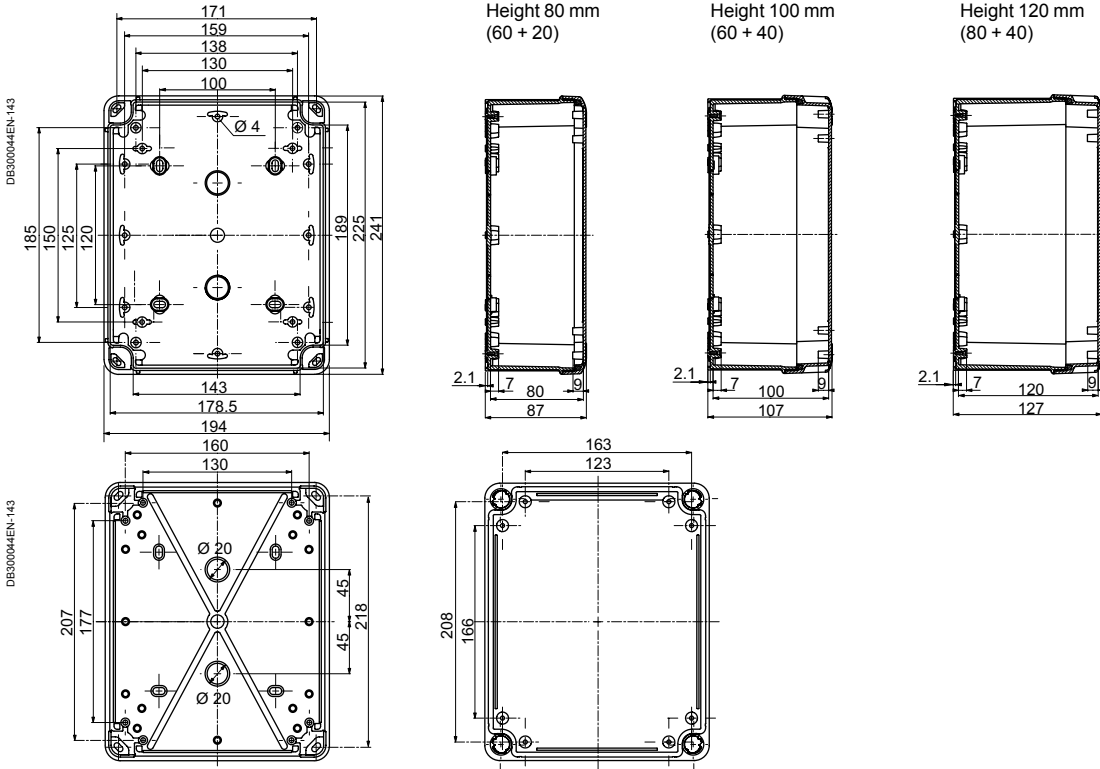

**Box of 291 x 241 x 88, 128 or 168 mm (external dimensions) NSYTB...29248, NSYTB...292412 or NSYTB...292416**

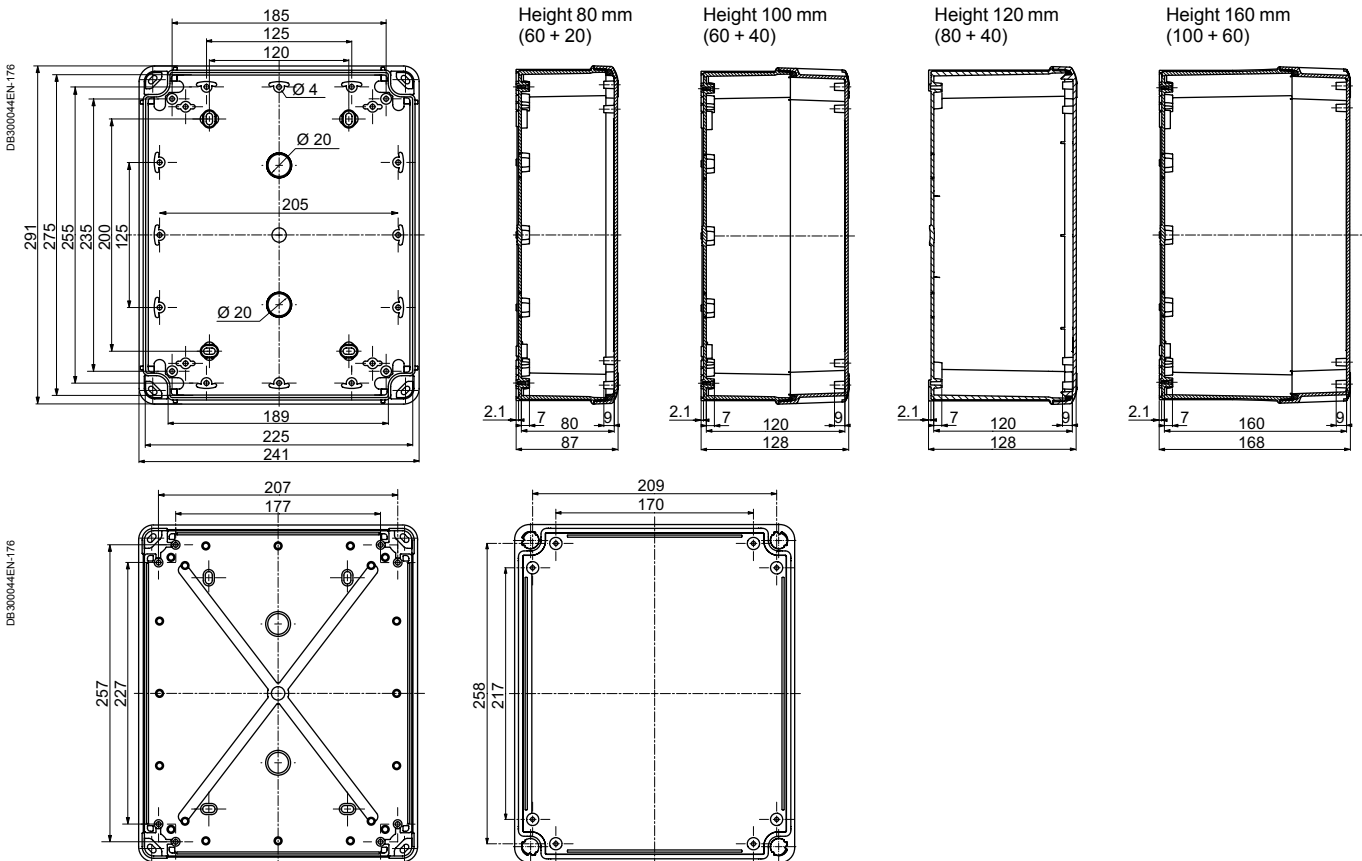



# Insulating industrial boxes

## Dimensions

Box of 341 x 291 x 128 or 168 mm (external dimensions) NSYTB...342912 or NSYTB...342916

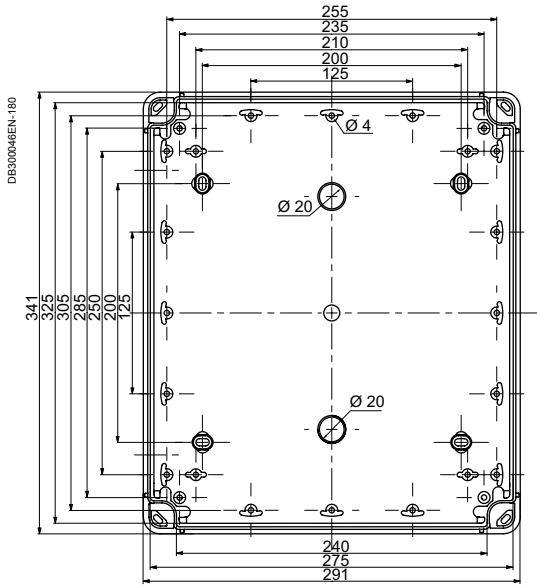

Height 120 mm  
(80 + 40)

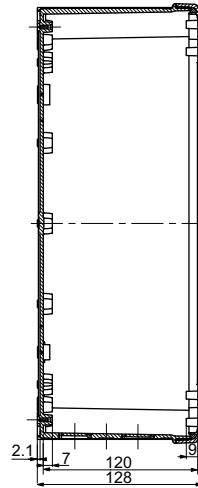

Height 160 mm  
(100 + 60)

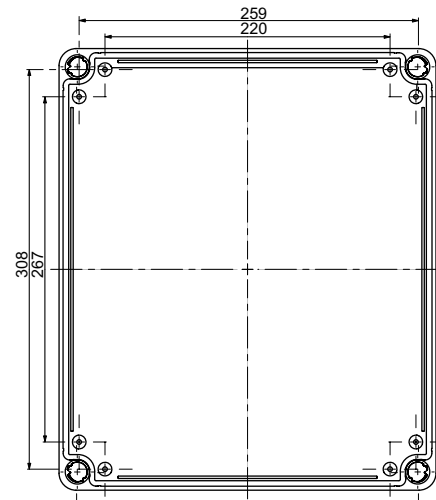
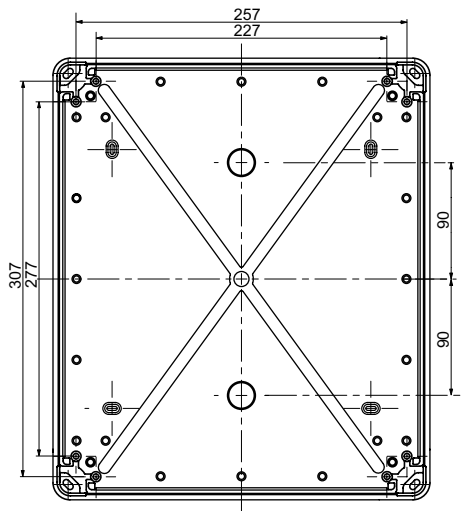
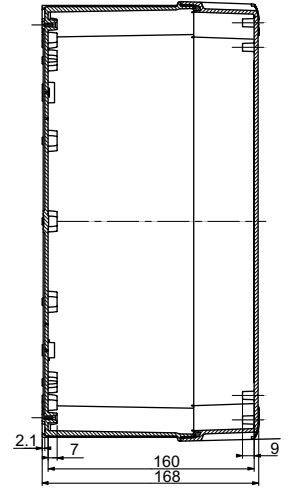

# Insulating industrial boxes

## Specific accessories

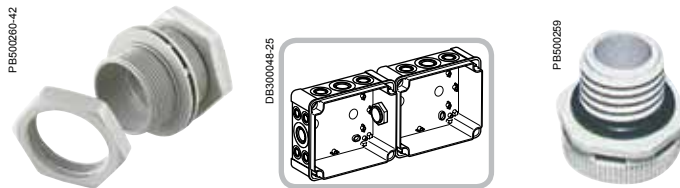

Characteristics		Coupling kit	Sealed anti-condensation valve		
		The coupling kit allows you to join several boxes with dimensions from 138 x 93 mm.	Controls the pressure to avoid condensation following an internal temperature increase. <b>Applications</b> Protection of equipment for luminaires, industrial control, transportation, pumps, etc.		
Material		Polystyrene 650°	PA6-V2, acrylic co-polymer membrane, water and oil repellent		
Ingress protection rating		IP66	IP68		
Installation		The kit is installed by drilling a hole with Ø 32 mm in the boxes to be coupled	The valve is installed by drilling a hole with Ø 12 mm in the box		
Usage temperature		-	-40...+105°C		
Supply		The kit consists of 2 linking parts, nuts and seals	10 valves, nuts and seals		
Drill Ø	Minor pack.	Reference	Permeability (1)	Pressure difference (2)	References
32 mm	1	<b>13934</b>	-	-	-
M12	10	-	16 litres/h	$\Delta P < 1$ bar	<b>NSYCAG12LPH1</b>
M12	10	-	120 litres/h	$\Delta P < 0.1$ bar	<b>NSYCAG12LPH2</b>

(1) Air flow under  $\Delta P = 0.7$  bar.  
(2) Condition for IP68.

### Cover accessories

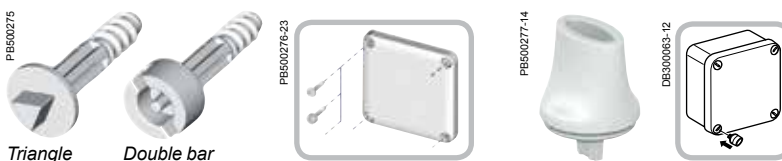

Characteristics			Set of 4 shape screws			Pack of 4 handles		
			<ul style="list-style-type: none"> <li>■ The Thalassa boxes are delivered as standard with slotted-head screws for flat screwdrivers from 4 to 5.5 mm.</li> <li>■ With box sizes from 138 x 93 x 72 mm, these screws can be replaced for screws with different standardised heads, to comply with most cases.</li> <li>■ After removing the standard screw, simply position the new screw by pressing on it.</li> <li>■ The adapter clips (intermediate parts for tightening the cover on the body of the box) are the same as those for the standard screws. They are not delivered with the shape screws (see drawing on page 180).</li> <li>■ A single key for opening the boxes as well as the other enclosures of your installation.</li> </ul>			<ul style="list-style-type: none"> <li>■ The handle (or thumbwheel) allows the screws to be handled without any tools. It is ideally associated with a box equipped with hinges.</li> <li>■ It snaps onto the head of the standard plastic screw.</li> </ul>		
Type	Minor pack.	Height of the lid (mm)						
		20	40	60				
Triangle	6.5 mm	1	NSYAEDST620TB (1)	-	-	-		
	8 mm	1	NSYAEDST820TB	-	-	-		
Double bar	3 mm	1	NSYAEDSB320TB	-	-	-		
	5 mm	1	NSYAEDSB520TB	-	-	-		
Spare standard plastic screw	1	NSYAEDS20TB	NSYAEDS40TB	NSYAEDS60TB	-	-		
Pack of 4 handles	1	-	-	-	-	NSYAEDKTB		

(1) CNOMO.

### Hinges



Characteristics	Set of 2 hinges	Set of 4 mounting brackets						
Ingress protection rating	IP66	IP66						
Installation	<ul style="list-style-type: none"> <li>The hinges can be adapted to all covers with a height of 20 and 40 mm with dimensions from 138 x 93 mm.</li> <li>The hinge allows the lid to open fully to 200°.</li> </ul>	<ul style="list-style-type: none"> <li>Plastic mounting brackets for installation on boxes with dimensions from 116 x 116 mm.</li> <li>Option of vertical or horizontal installation.</li> </ul>						
Maximum load	Hinged cover: 10 kg/m <sup>2</sup>	<ul style="list-style-type: none"> <li>Body: 30 kg/m<sup>2</sup></li> <li>Cover: 10 kg/m<sup>2</sup></li> </ul>						
Minor pack.	1	1						
Supply	The hinges (2 per set) are delivered with the mountings	4 lugs + screws						
	<table border="1"> <thead> <tr> <th>Height of the lid (mm)</th> <th>References</th> </tr> </thead> <tbody> <tr> <td>20</td> <td>NSYAEDH20TB</td> </tr> <tr> <td>40</td> <td>NSYAEDH40TB</td> </tr> </tbody> </table>	Height of the lid (mm)	References	20	NSYAEDH20TB	40	NSYAEDH40TB	Reference NSYAEFTB
Height of the lid (mm)	References							
20	NSYAEDH20TB							
40	NSYAEDH40TB							

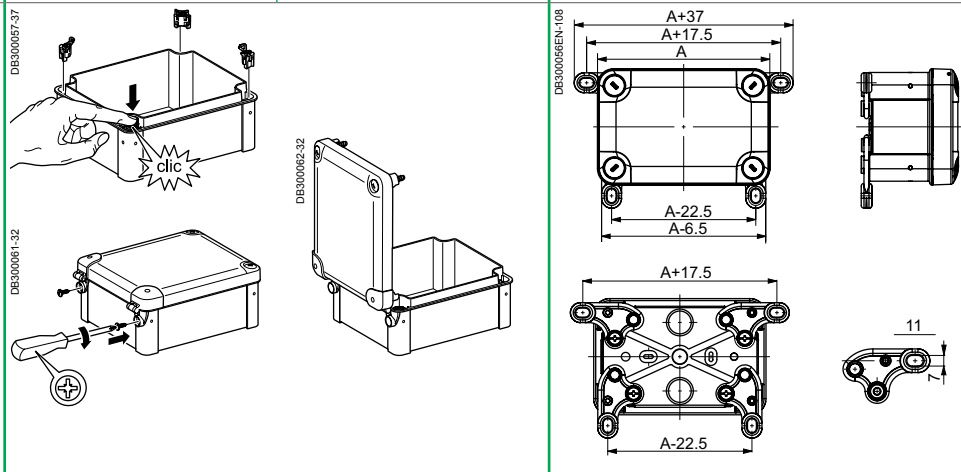

### Installation accessories

PB500256-24



PB500257-24



Characteristics					Mounting plates		
					Mounting plates made to adapt to all usage scenarios.		
Material					Galvanised-steel	Insulating polyester plate reinforced with fibreglass, halogen-free: glow wire resistance 750°C.	
Thickness					15/10° mm	25/10° mm	
Installation					<ul style="list-style-type: none"> <li>■ Mounting by means of Ø 4-mm self-tapping screws, Pozidrive and slotted head, ref. <b>NSYAMFSTB</b></li> <li>■ To raise the plate, use the stand-offs ref. <b>NSYAMFET154TB</b>, <b>NSYAMFET204TB</b>, <b>NSYAMFET304TB</b> and the screw <b>NSYAMFESTB</b></li> <li>■ To stack several mounting plates, use the spacers, ref. <b>NSYAMFEP154TB</b>, <b>NSYAMFEP204TB</b>, <b>NSYAMFEP304TB</b> and the screw <b>NSYAMFESTB</b></li> </ul>		
Supply					Plates supplied without screws		
Box (mm)		Dimensions (mm)		Minor pack.	References		
Height	Width	A	B				
192	164	168.5	140	1	<b>NSYAMP1916TB</b>	<b>NSYAMPA1916TB</b>	
241	194	215	168.5	1	<b>NSYAMP2419TB</b>	<b>NSYAMPA2419TB</b>	
291	241	265	215	1	<b>NSYAMP2924TB</b>	<b>NSYAMPA2924TB</b>	
341	291	315	265	1	<b>NSYAMP3429TB</b>	<b>NSYAMPA3429TB</b>	
Accessories					Pack of 100 screws		
Ø 4 x 10 mm					1	<b>NSYAMFSTB</b>	<b>NSYAMFSTB</b>

# Insulating industrial boxes

## Specific accessories

### Installation accessories

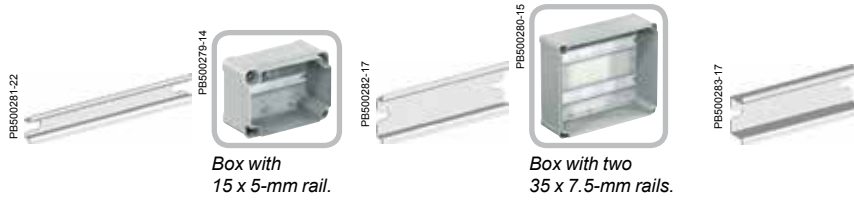

Characteristics		Rails					
		Symmetric DIN rails. ■ A 15 x 5-mm rail is provided for the compact terminal blocks. ■ To raise the rail, use stand-offs ref. <b>NSYAMFET154TB</b> , <b>NSYAMFET204TB</b> , <b>NSYAMFET304TB</b> and the screw <b>NSYAMFESTB</b> .					
Installation		Mounting of the rails with Ø 4-mm self-tapping screws, (not included), Pozidrive and slotted head, ref. <b>NSYAMFSTB</b>					
Supply		Supplied without screws (except for the 15 x 5 mm rails)					
For boxes with height or width (mm)	15 x 5 mm		35 x 7.5 mm		35 x 15 mm		
	Minor pack.	References	Minor pack.	References	Minor pack.	References	
105	10	<b>NSYAMRD11155TB</b>	10	<b>NSYAMRD11357TB</b>	-	-	
150	10	<b>NSYAMRD16155TB</b>	10	<b>NSYAMRD16357TB</b>	-	-	
175	10	<b>NSYAMRD19155TB</b>	10	<b>NSYAMRD19357TB</b>	-	-	
225	10	<b>NSYAMRD24155TB</b>	10	<b>NSYAMRD24357TB</b>	10	<b>NSYAMRD243515TB</b>	
275	10	<b>NSYAMRD29155TB</b>	10	<b>NSYAMRD29357TB</b>	10	<b>NSYAMRD293515TB</b>	
325	10	<b>NSYAMRD34155TB</b>	10	<b>NSYAMRD34357TB</b>	10	<b>NSYAMRD343515TB</b>	
Accessories		Pack of 100 screws					
Ø 4 x 10 mm		<b>NSYAMFSTB</b>					

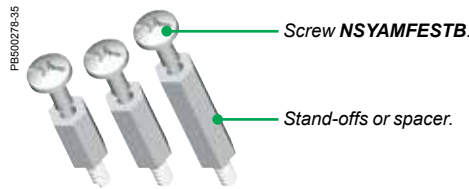

Characteristics		Stand-offs	Spacers
		Stand-offs consisting of a Ø 4-mm self-tapping thread at one end (for direct screwing into the rivets of the box) and an M4 tapping on the other end, for direct installation of a card with an M4 screw, ref. <b>NSYAMFESTB</b> , or of a spacer.	Spacer for installation on the stand-offs. M4 thread and tapping.
Material		Steel	Steel
Supply		Set of four M4 self-tapping stand-offs	Set of four M4 spacers
Height (mm)	Minor pack.	References	References
		<b>NSYAMFET154TB</b>	<b>NSYAMFEP154TB</b>
15	1	<b>NSYAMFET204TB</b>	<b>NSYAMFEP204TB</b>
20	1	<b>NSYAMFET304TB</b>	<b>NSYAMFEP304TB</b>
30	1		
Accessories		Screw for stand-offs and spacers	
		M4 x 10 mm screw for mounting cards on the spacers and stand-offs. ■ The plate always at the right level. ■ A single Ø 4-mm screw for mounting any element.	
Supply		Batch of 50 screws	
		<b>References</b> <b>NSYAMFESTB</b>	
		<b>Minor pack.</b> 1	

### Cable entries overview



Characteristics	Simple-1	Simple-2	Simple-3	Simple-4	Simple-5
	Mixed membrane entries for enclosure thickness 20/10° - 32/10° mm.	PVC adjustable cone-shaped entries for enclosure thickness 30/10° - 32/10° mm.	Quick cable entries for enclosure thickness 10/10° - 40/10° mm.	PVC adjustable cone-shaped entries for Pg tubes or for enclosure thickness 12/10° - 15/10° mm.	ISO cable gland.
Cable entry material	Soft membrane		Combined		
Cable glands to be fitted	Not applicable				
Installation possibilities	On cable gland plate or directly on enclosure				
Flexibility of the installation	Low				
Reversibility	Medium				
Ingress protection rating	IP55	IP55	IP67	IP55	IP68
Cable retention	Low	Low	Medium	Low	High
Cable diameter (mm)	From 20 to 40	From 18 to 87	From 12 to 50	From 16 to 44	From 12 to 40
Cable Installation time	Fast	Fast	Fast	Fast	Slow
Quantity of cables to be fitted for a given surface	+	+	+	+	+
Cable entries for cables with connectors	No	No	No	No	No
Cut-out dimensions (mm)	Various circular hole diameters according to cable diameter				
External dimensions (mm)	-	From Ø 25 to 98	-	From Ø 25 to 52	From Ø 15 to 46
Certificates	-	-	-	-	-
Flame resistance	750°C	-	750°C	-	750°C
<b>References*</b>					
See page	284	284	285	285	284

\* For details, type reference in the search engine of [www.schneider-electric.com](http://www.schneider-electric.com).

### Spare Parts

#### Accessories bag



**Reference**

NSYTBPASBS

# Insulating modular boxes

## Introduction

> **PLS boxes:** polyester rear and PC transparent cover with hinges and wing screws for manual opening.



### Modular

The dimensions of the sides, multiples of 9 cm, allow the creation of assemblies.

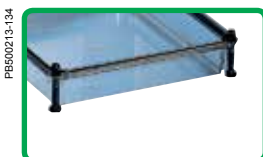

### Protection

- IP65.
- Gasket between body and cover.
- IK09.
- Insulation Class II.



### Easy

Bosses with inserts, at the rear of the body, for mounting plates or various supports.

This range can be configured according to your needs

4 different services available:



Assemble to order



Mounting of standard accessories



Painting



Machining

See page 396 for details or consult our web site [www.schneider-electric.com](http://www.schneider-electric.com)





Characteristics	Complete box	Insulating modular boxes with modular distribution chassis	Modular distribution chassis
	<ul style="list-style-type: none"> <li>■ Insulating boxes that can be coupled by all their side surfaces, allowing the creation of the greatest variety of modular assemblies.</li> <li>■ The product references show the two lateral dimensions in cm.</li> <li>■ 14 sizes of insulating boxes; the sides are multiples of 9 cm.</li> <li>■ Rear made from polyester reinforced with fibreglass, moulded by hot compression, 9 sizes.</li> <li>■ 3 types of cover available according to the sizes:                             <ul style="list-style-type: none"> <li>□ standard cover, made from transparent polycarbonate with neoprene gasket, 45 mm high,</li> <li>or 95 mm high (final index A) according to the sizes,</li> <li>□ opaque polycarbonate cover (index C), with neoprene gasket, 45 mm high, or 95 mm high (final index A) according to the sizes,</li> <li>□ polyester reinforced with fibreglass cover (index P) with PUR gasket, 45 mm high.</li> </ul> </li> <li>■ Complete box includes rear, cover, locking screws and sealing device.</li> <li>■ The rears (prefix F) and the covers (prefix T) are supplied separately as standard references. The separate covers are supplied without locking screws or sealing accessories.</li> <li>■ The PLS enclosures with transparent cover are also offered in batches; the reference refers to the complete batch.</li> <li>■ Excellent resistance to corrosion; can withstand most chemical agents.</li> <li>■ Full insulation to create class II assemblies.</li> <li>■ Standard lock with slot screws outside the volume of the boxes. Delivered with sealing system.</li> <li>■ External wall-mounting by 4 lugs, to be ordered separately.</li> <li>■ Service temperature: -30 to +70°C.</li> <li>■ Bosses with M6 inserts for mounting the mounting plate.</li> <li>■ Halogen-free and compliant with the RoHS directive.</li> </ul>	<p>PLS boxes, polyester rear and PC transparent cover with hinges and wing screws for manual opening.</p> <p>Built-in DLS modular chassis, made up of an insulating protection panel, RAL 7011 colour, 35-mm DIN rails and a 2 x 16 + 5 x 6 mm<sup>2</sup> neutral/earth connection strip.</p> <ul style="list-style-type: none"> <li>■ Opening for cable entry, delivered with lock plate, ref. <b>NSYTL27270</b>.</li> <li>■ Double-insulating installation.</li> <li>■ Plastic external hinges, allowing opening to 180°.</li> <li>■ Removable 36-mm blanking covers (2 modules): 1 per row in the standard offer.</li> </ul>	<p>Built-in DLS modular chassis, made up of an insulating protection panel, RAL 7011 colour, 35-mm DIN rails and a 2 x 16 + 5 x 6 mm<sup>2</sup> neutral/earth connection strip.</p>
Colour	RAL 7032 grey* (opaque rears and cover)	-	-
Ingress protection rating	IP65	-	-
Mechanical protection rating	IK09	-	-
Certifications	<ul style="list-style-type: none"> <li>■ Certification according to standard IEC 62208, guaranteeing IP, IK, resistance to heat and fire (self-extinguishing), insulation to 5000 V, and load of the mounting plate, 100 kg/m<sup>2</sup></li> <li>■ UL508A** CAN/CSA-C22.2 - Types 1, 2, 3, 3R, 3S, 4, 4X, 12 and 13</li> </ul>	-	-
Installation	Outdoor installation: compliant with IEC 62208 regarding type tests specified in §9.12 (resistance to ultra-violet (UV) radiation) and §9.13 (resistance to corrosion). It is always advisable to install a canopy to avoid water stagnation on the upper part of the enclosure	-	-
Options	-	The boxes can be equipped with a double-bar lock and handle ref. <b>NSYCL27M</b> , or a lock with key ref. <b>NSYCL27L405</b> , by specific demand	-
Supply	-	The modular chassis can be ordered separately	-

\* RAL 7035 from 2016.

\*\* **NSYPLS**, **NSYPLSP** and **NSYPLSC** followed by suffixes.

# Insulating modular boxes

## Selection guide



Dimensions (mm)			Complete box			Complete boxes in batches	
Height	Width	Depth	Transparent cover	Opaque cover	Polyester cover	Transparent cover	Amount per batch
180	270	180	NSYPLS1827	NSYPLSC1827	NSYPLSP1827	NSYPLS1827L	56
270	270	180	NSYPLS2727	NSYPLSC2727	NSYPLSP2727	NSYPLS2727L	56
		230	NSYPLS2727A	NSYPLSC2727A	-	NSYPLS2727AL	56
	360	180	NSYPLS2736	NSYPLSC2736	NSYPLSP2736	NSYPLS2736L	56
		230	NSYPLS2736A	NSYPLSC2736A	-	NSYPLS2736AL	56
	540	180	NSYPLS2754	NSYPLSC2754	NSYPLSP2754	NSYPLS2754L	28
		230	NSYPLS2754A	NSYPLSC2754A	-	NSYPLS2754AL	28
360	270	180	-	-	-	-	-
		360	NSYPLS3636	NSYPLSC3636	NSYPLSP3636	NSYPLS3636L	28
	540	180	NSYPLS3654	NSYPLSC3654	NSYPLSP3654	NSYPLS3654L	28
		230	NSYPLS3654A	NSYPLSC3654A	-	NSYPLS3654AL	28
	720	230	NSYPLS3672A	NSYPLSC3672A	-	NSYPLS3672AL	27
		230	NSYPLS3672A	NSYPLSC3672A	-	NSYPLS3672AL	27
540	270	180	-	-	-	-	-
		540	NSYPLS5454	NSYPLSC5454	NSYPLSP5454	NSYPLS5454L	14
	720	230	NSYPLS5454A	NSYPLSC5454A	-	NSYPLS5454AL	14
		230	NSYPLS5472A	NSYPLSC5472A	-	NSYPLS5472AL	14

\*Approximate weight.



Dimensions (mm)			Rear	Low covers: 45 mm		
Height	Width	Depth	135 mm	Transparent	Opaque	Polyester
180	270	180	NSYFPLS1827	NSYTPLS1827	NSYTPLSC1827	NSYTPLSP1827
270	270	180	NSYFPLS2727	NSYTPLS2727	NSYTPLSC2727	NSYTPLSP2727
		230	NSYFPLS2727	-	-	-
	360	180	NSYFPLS2736	NSYTPLS2736	NSYTPLSC2736	NSYTPLSP2736
		230	NSYFPLS2736	-	-	-
	540	180	NSYFPLS2754	NSYTPLS2754	NSYTPLSC2754	NSYTPLSP2754
		230	NSYFPLS2754	-	-	-
360	360	180	NSYFPLS3636	NSYTPLS3636	NSYTPLSC3636	NSYTPLSP3636
		540	NSYFPLS3654	NSYTPLS3654	NSYTPLSC3654	NSYTPLSP3654
	720	230	NSYFPLS3654	-	-	-
		230	NSYFPLS3672	-	-	-
540	540	180	NSYFPLS5454	NSYTPLS5454	NSYTPLSC5454	NSYTPLSP5454
		230	NSYFPLS5454	-	-	-
	720	230	NSYFPLS5472	-	-	-

# Insulating modular boxes

## Selection guide



Insulating modular boxes with modular distribution chassis					Modular distribution chassis
No. of 18 mm modules	No. of rows	Weight* (kg)	References	References	
12	1	1.7	NSYPLS1827DLS12	NSYDLS12	
24	2	2.5	NSYPLS2727DLS24	NSYDLS24	
-	-	-	-	-	
-	-	-	-	-	
-	-	-	-	-	
-	-	-	-	-	
24	2	2.7	NSYPLS3627DLS24	NSYDLS242	
36	3	2.8	NSYPLS3627DLS36	NSYDLS36	
-	-	-	-	-	
-	-	-	-	-	
-	-	-	-	-	
48	4	3.8	NSYPLS5427DLS48	NSYDLS48	
-	-	-	-	-	
-	-	-	-	-	
-	-	-	-	-	



High covers: 95 mm		Metallic mounting plates		Insulating mounting plates	
Transparent	Opaque	Plain	Telequick	Polyester	Bakelite
-	-	NSYPMM1827	NSYPMR1827	NSYPMA1827	NSYPMB1827
-	-	NSYPMM2727	NSYPMR2727	NSYPMA2727	NSYPMB2727
NSYTPLS2727A	NSYTPLSC2727A	-	-	-	-
-	-	NSYPMM2736	NSYPMR2736	NSYPMA2736	NSYPMB2736
NSYTPLS2736A	NSYTPLSC2736A	-	-	-	-
-	-	NSYPMM2754	NSYPMR2754	NSYPMA2754	NSYPMB2754
NSYTPLS2754A	NSYTPLSC2754A	-	-	-	-
-	-	NSYPMM3636	-	NSYPMA3636	NSYPMB3636
-	-	NSYPMM3654	NSYPMR3654	NSYPMA3654	NSYPMB3654
NSYTPLS3654A	NSYTPLSC3654A	-	-	-	-
NSYTPLS3672A	NSYTPLSC3672A	NSYPMM3672	NSYPMR3672	NSYPMA3672	NSYPMB3672
-	-	NSYPMM5454	NSYPMR5454	NSYPMA5454	NSYPMB5454
NSYTPLS5454A	NSYTPLSC5454A	-	-	-	-
NSYTPLS5472A	NSYTPLSC5472A	NSYPMM5472	NSYPMR5472	NSYPMA5472	NSYPMB5472

# Insulating modular boxes

## Dimensions

The surfaces are numbered to enable identification of the surfaces to be drilled in the customised offer.

### NSYPLS●●●1827

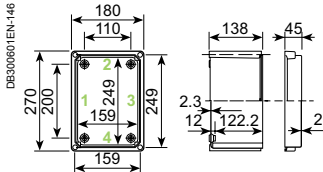

### NSYPLS●●●2727●

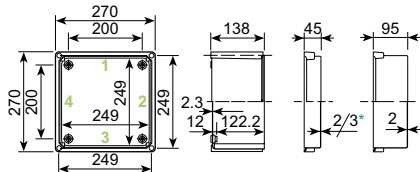

### NSYPLS●●●2736●

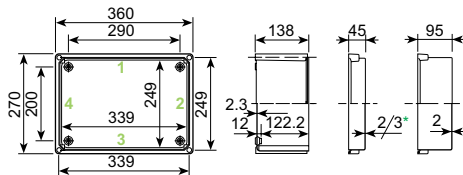

### NSYPLS●●●3636

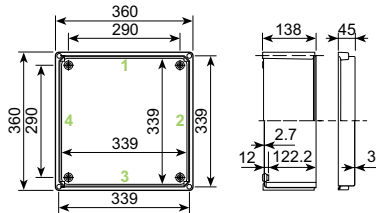

### NSYPLS●●●2754●

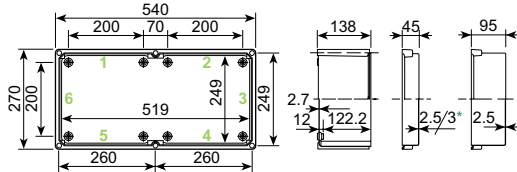

### NSYPLS●●●3654●

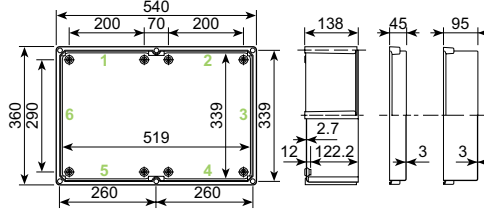

### NSYPLS●●●5454●

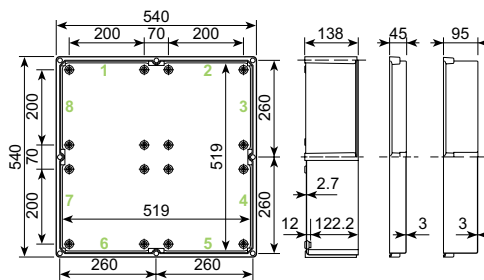

### NSYPLS●●●3672●

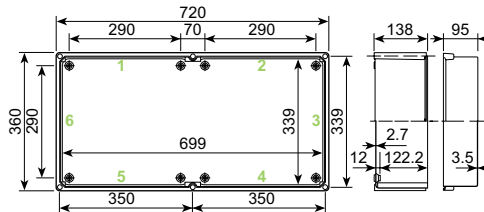

### NSYPLS●●●5472●

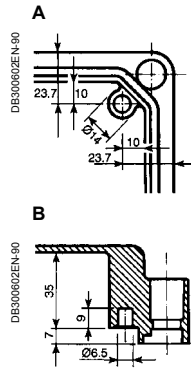
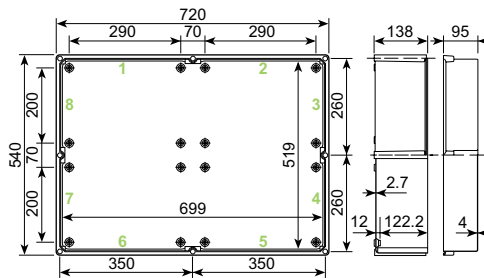

A - B: Internal view of the corners of the polyester covers with bosses for inserts ref. **NSYTEX5** for M5 screws.

\* Thickness of 30/10° mm for the polyester cover.

## Insulating modular boxes with modular distribution chassis

### NSYPLS1827DLS12

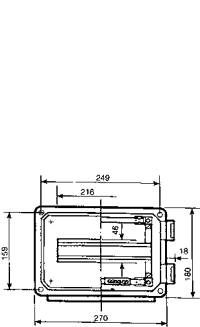

### NSYPLS2727DLS24

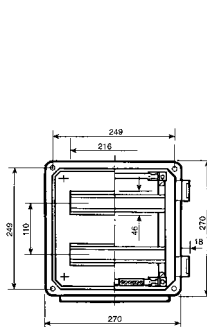

### NSYPLS3627DLS24

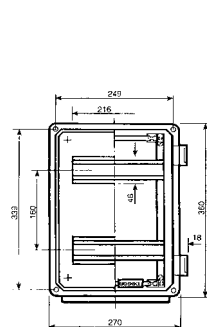

### NSYPLS3627DLS36

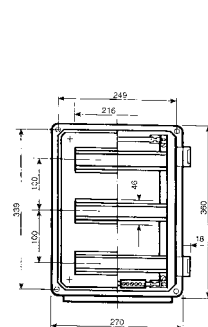

### NSYPLS5427DLS48

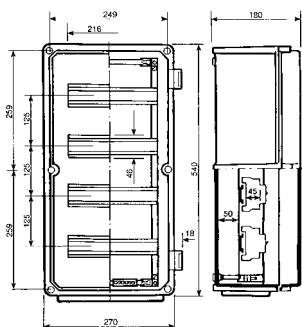

### Mounting



Characteristics	Wall-mounting brackets		Post-mounting device		Plastic carrying handle
Material	Passivated zinc-coated steel	Stainless-steel	-		Plastic
Supply	Set of 4 lugs and mountings		Contains all the elements required for mounting on a post		-
	<b>References</b>		<b>For installation on a surface with dimensions (mm)</b>	<b>References</b>	<b>Reference</b>
	NSYPF27N	NSYPF27X	270 360 540	NSYFSP27270 NSYFSP27360 NSYFSP27540	NSYATM27

### Coupling



Characteristics	Coupling frames			Side plates		Box coupling unit piece	
	Use the boxes dimensional drawings to identify what coupling frame you need. Consider the sides and surfaces you will join.			-		For coupling 2, 3 or 4 boxes, with optional wall-mounting.	
Ingress protection rating	<ul style="list-style-type: none"> <li>■ Frame with full opening: IP65</li> <li>■ Frame with partial opening: IP44</li> </ul>			IP65		-	
Supply	-			-		To be ordered in multiples of 25	
	<b>References</b>					<b>For coupling (2)</b>	
<b>For surfaces (mm)</b>	<b>Opening (mm)</b>	<b>Full-opening frame</b>	<b>Partial-opening frame</b>	<b>Side plates (mm)</b>		<b>2 boxes</b>	<b>3 or 4 boxes</b>
180	110	NSYUM27180	-	-	-	-	-
270	200	NSYUM27270	NSYUCC270 (1)	200	NSYTL27270	-	-
360	290	NSYUM27360	NSYUCC360 (1)	290	NSYTL27360	-	-
-	-	-	-	-	-	NSYPS2C27	NSYPS4C27

(1) References by unit. Order by multiples of 10 units (10, 20, 30, etc.).  
 (2) M6 x 8 screw with cylindrical head.

### Locking

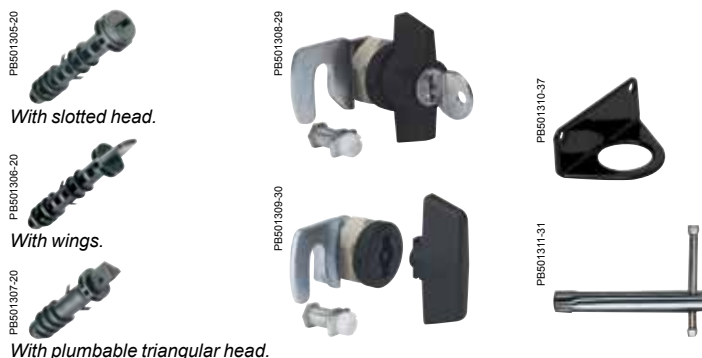

Characteristics	Closing for PLS boxes	Closing locks	Sealing and opening
Options	-	Option of installing a side lock, on the opposite side to where the hinges are installed	-
Supply	Set of 4, 6 or 8 screws. The references also include 4 M6 screws for mounting mounting plates and 2 steel sealing accessories	-	-
Name	Tool	References	
Set of 4 slotted screws (1)	Flat-blade screwdriver	<b>NSYTC274</b>	-
Set of 6 slotted screws (1)	Flat-blade screwdriver	<b>NSYTC276</b>	-
Set of 8 slotted screws (1)	Flat-blade screwdriver	<b>NSYTC278</b>	-
Set of 4 wing screws (2)	Manual	<b>NSYTCM274</b>	-
Set of 6 wing screws (2)	Manual	<b>NSYTCM276</b>	-
Set of 8 wing screws (2)	Manual	<b>NSYTCM278</b>	-
Set of 4 triangular screws	◦ NSYLT27	<b>NSYTCT274</b>	-
Set of 6 triangular screws		<b>NSYTCT276</b>	-
Set of 8 triangular screws		<b>NSYTCT278</b>	-
Double-bar side lock and handle	NSYDBP	-	<b>NSYCL27M</b>
Side lock with key 405		-	<b>NSYCL27L405</b>
Plastic-coated sealing triangle (3)	-	-	<b>NSYPPS27</b>
Triangular key for PLS	-	-	<b>NSYLT27</b>

(1) Included in the standard references of boxes **NSYPLS●●●**.  
 (2) Included in the standard references of modular distribution boxes **NSYPLS●●●DLS●●●**.  
 (3) References by unit. Order by multiples of 10 units (10, 20, 30, etc.).

### Other



Characteristics	Hinges	Insulators for busbar	
	<ul style="list-style-type: none"> <li>External hinges.</li> <li>To open the door to 180°.</li> </ul>	<ul style="list-style-type: none"> <li>Internal hinges.</li> <li>To open the door to 180°.</li> </ul>	<ul style="list-style-type: none"> <li>For 4 bars of 15 or 20 mm.</li> <li>Utilisation on the 270 mm side.</li> </ul>
Material	Plastic	Brass	-
Supply	Set of 2 hinges	Set of 2 hinges	References by unit. Order by multiples of 5 units (5, 10, 15, etc.)
References	<b>NSYBE27</b>	<b>NSYBL27</b>	<b>NSYAE25</b>
			<b>NSYAS25</b>



## Examples of assembly

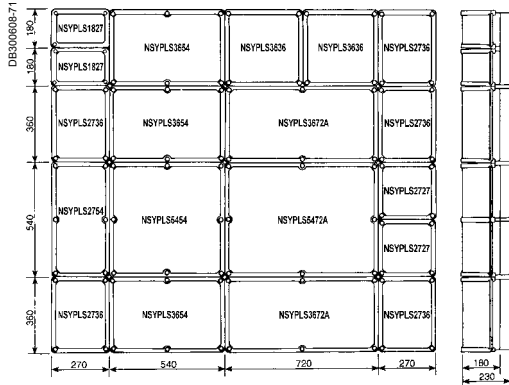

All the boxes can be joined by their lateral surfaces, using the coupling frames **NSYUM...** or **NSYUCC...**, and the joining and mounting pieces **NSYPS2C27** and **NSYPS4C27**.

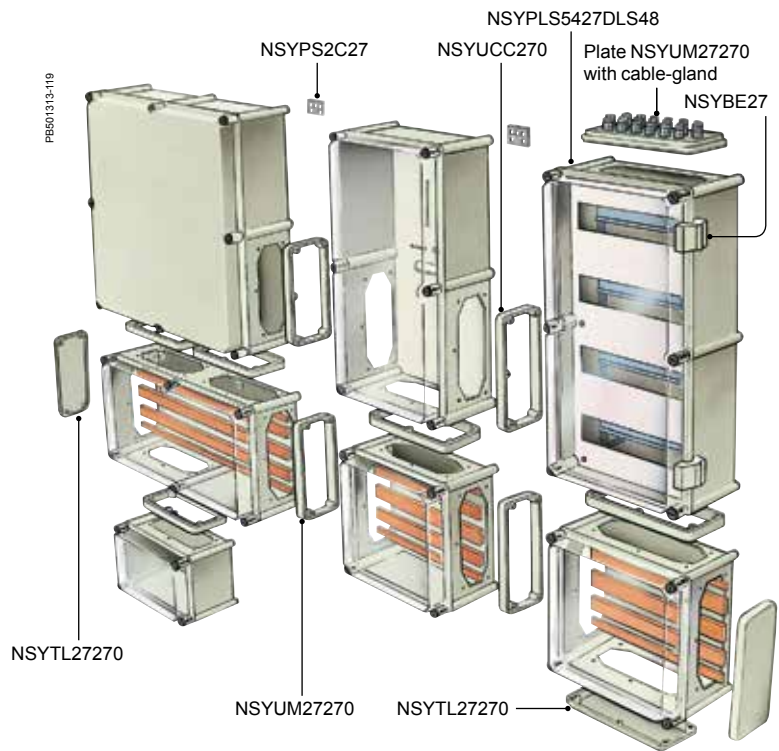

## [!] Drill holes

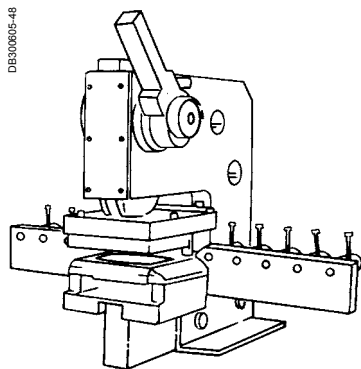

Side cut-out press, ref. **NSYPUC27**.

- The machining operations on the dimensions of the lateral plates or frames can be specifically produced in our factory.
- The surfaces can be identified by the numbers provided on page 188.

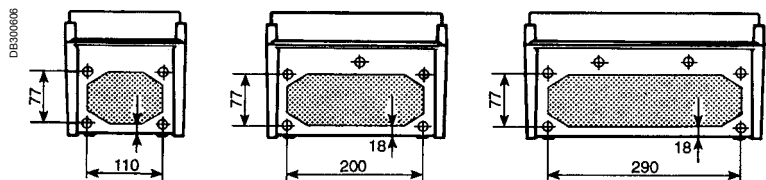



Dimensions here represented are approximate.  
Template to machine the box provided with the product.

# Insulating wall-mounting enclosures



# Insulating wall-mounting enclosures

## Contents

 <p>PB500147-14</p>	<p><b>Thalassa PLM</b> Insulating wall-mounting enclosures</p>	<p><b>194</b></p>
 <p>PB500076-54</p>	<p>Introduction Characteristics Dimensions Specific accessories overview Common accessories overview Specific accessories</p>	<p>194 195 196 197 198 199</p>
 <p>PB502863-21</p>	<p><b>Associated applicative offers</b> PHD Polyester Heavy Duty enclosures</p>	<p>306</p>

**New**

### Early 2016, the PLM range changes color



> **Why change?**

To harmonize the Schneider Electric Universal enclosures offer. Answer to customer requests and to the the market trends.

> **What happen with the part numbers (references)?**

Every product that have changed in colour have also changed the part number. It is done just adding a letter "G" at the end on reference. *Example:*

RAL 7032	RAL 7035
NSYPLM43	NSYPLM43G

> **How can I obtain RAL 7032 enclosures?**  
Consult us.

> **Will the new RAL 7035 colour offer the same properties as RAL 7032?**  
Yes, all mechanical properties will be the same. The light reflexion is even improved.

# Insulating wall-mounting enclosures

## Introduction

### > Monobloc wall-mounting enclosure

- made from polyester reinforced with fibreglass, moulded by hot compression.
- Degree of protection IP66,
- Impact resistance IK10 for the plain doors and surfaces and IK08 for the glazed doors of the polyester versions,
- UL certification and NEMA classification 4x and 13 for the polyester wall-mounting enclosures,
- Total insulation to produce class II units,
- Complies with RoHS and REACH Directives

P1237102-32



#### Service life

High resistance to corrosion in harsh environments, maintaining its mechanical properties and insulation.

PB501327-40



#### Easy

- Door easily reversible by turning it over.
- Opening to 120° or 180°.
- Easy machining with no corrosion.
- Lightness.
- Polyamide hinge pin, easily removable and captive.

PB501325-95



#### Smart

- Notches for easy mounting of DIN rails.
- Grid pattern on the rear of the door for marking the machining operations.

PB501325-60



This range can be configured according to your needs

4 different services available:



Assemble to order



Mounting of standard accessories



Painting



Machining

See page 396 for details or consult our web site [www.schneider-electric.com](http://www.schneider-electric.com)

# Insulating wall-mounting enclosures

## Characteristics



PB500144-22



PB500145-14



PB500146-14



PB500147-14



PB501264-14



PB501265-14



Characteristics	ABS/PC wall-mounting enclosures	Polyester wall-mounting enclosures
	<ul style="list-style-type: none"> <li>■ Monobloc wall-mounting enclosure.</li> <li>■ Version with transparent polycarbonate door.</li> <li>■ Closes with a 3-mm double-bar lock.</li> <li>■ Door opening: 180°.</li> <li>■ Temperature range: -35°C...+90°C.</li> </ul>	<ul style="list-style-type: none"> <li>■ Monobloc wall-mounting enclosure.</li> <li>■ Version with transparent tempered-glass door.</li> <li>■ Closes with two 3-mm double-bar locks.</li> <li>■ Door opening angle: 120°.</li> <li>■ Grid pattern with a pitch of 50 mm on the back of the door.</li> </ul>
		<ul style="list-style-type: none"> <li>■ Monobloc wall-mounting enclosure.</li> <li>■ Version with transparent tempered-glass door.</li> <li>■ Locking device outside the sealed area, guaranteeing the tightness of IP66 over time.</li> <li>■ Locking system:                             <ul style="list-style-type: none"> <li>□ enclosure height ≤ 847 mm: 2 locks with double-bar insert or 1 handle with key lock and 3-point closure,</li> <li>□ enclosure height 1056 mm: 1 lock with double-bar insert and 4-point closure.</li> </ul> </li> <li>■ Door opening angle: 180°.</li> <li>■ Bosses for accessory-mounting inserts: M6 inside the enclosure, M5 in the door for enclosure heights of 430 and 530 mm, M6 in the door for enclosure heights ≥ 647 mm.</li> <li>■ Grid pattern with a pitch of 25 mm on the back of the door.</li> </ul>
Material	ABS/PC	Polyester reinforced with fibreglass, moulded by hot compression
Temperature range - Polyester parts	-	-50°C ... +150°C
Temperature range - Gasket	-35°C ... +90°C	
Colour	RAL 7032 grey*	
Ingress protection rating	IP66 according to IEC 60529	
Mechanical protection rating	<ul style="list-style-type: none"> <li>■ IK10 (20 joules) plain door - IEC 62262</li> <li>■ IK08 (5 joules) glazed door</li> </ul>	
Certifications	<ul style="list-style-type: none"> <li>■ IEC 62208</li> <li>■ Marine</li> </ul>	<ul style="list-style-type: none"> <li>■ IEC 62208</li> <li>■ Marine</li> <li>■ UL 508A - type: 1, 2, 3, 3R, 3S, 4, 4X, 5, 12, 12K and 13</li> </ul>
Installation	<ul style="list-style-type: none"> <li>■ Direct mount of symmetrical rails ref. <b>NSYCS200PLM</b> with plastic nuts ref. <b>NSYTCSPLM</b>, to be installed in the notches on the rear of the body, with a pitch of 25 mm</li> <li>■ Mounting of installation plates on the studs at the rear of the enclosure</li> </ul>	<p>Mounting of rear accessories on 4 M8 x 18 studs</p> <ul style="list-style-type: none"> <li>■ Mounting of rear accessories on 4 M8 studs, included in the standard supply</li> <li>■ Direct mounting of symmetrical rails ref. <b>NSYCS●●●PLM</b>, with plastic nuts, ref. <b>NSYTCSPLM</b>, to be installed in the notches on the rear of the body, with a pitch of 25 mm</li> </ul>

External dimensions (mm)			References of wall-mounting enclosures with door							
Height	Width	Depth	Plain (3)	Transparent	Plain (3)	Transparent	Plain (3)	Transparent	Plain (1)	Transparent (1)
308	255	160	-	-	NSYPLM3025	NSYPLM3025T	-	-	-	-
310	215	160	NSYPLM32	NSYPLM32T	-	-	-	-	-	-
430	330	200	-	-	-	-	NSYPLM43	NSYPLM43T	NSYPLM43V	NSYPLM43TV
530	430	200	-	-	-	-	NSYPLM54	NSYPLM54T	NSYPLM54V	NSYPLM54TV
647	436	250	-	-	-	-	NSYPLM64	NSYPLM64T	NSYPLM64V	NSYPLM64TV
747	536	300	-	-	-	-	NSYPLM75	NSYPLM75T	NSYPLM75V	NSYPLM75TV
847	636	300	-	-	-	-	NSYPLM86	NSYPLM86T	NSYPLM86V	NSYPLM86TV
1056	852	350	-	-	-	-	NSYPLM108 (2)	NSYPLM108T (2)	-	-

(1) Wall-mounting enclosure with handle and lock with 3-point closure and key 1242 E delivered as standard.

(2) Wall-mounting enclosure with standard 5 mm double-bar lock and lock with 4-point closure.

(3) These enclosures are also available equipped with metallic or insulating mounting plates.

\* RAL 7035 from 2016.

External dimensions (mm)			Wall-mounting enclosures with plain door and mounting plate (4)							
Height	Width	Depth	Plain	Bakelite	Plain	Bakelite	Plain	Bakelite	Plain	Bakelite
308	255	160	-	-	NSYPLM3025P	NSYPLM3025B	-	-	-	-
310	215	160	NSYPLM32P	NSYPLM32B	-	-	-	-	-	-
430	330	200	-	-	-	-	NSYPLM43P	NSYPLM43B	NSYPLM43V	NSYPLM43BV
530	430	200	-	-	-	-	NSYPLM54P	NSYPLM54B	NSYPLM54V	NSYPLM54BV
647	436	250	-	-	-	-	NSYPLM64P	NSYPLM64B	NSYPLM64V	NSYPLM64BV
747	536	300	-	-	-	-	NSYPLM75P	NSYPLM75B	NSYPLM75V	NSYPLM75BV
847	636	300	-	-	-	-	NSYPLM86P	NSYPLM86B	NSYPLM86V	NSYPLM86BV
1056	852	350	-	-	-	-	-	-	NSYPLM108B	-

(4) Not mounted.

# Insulating wall-mounting enclosures

## Dimensions

### ABS/PC wall-mounting enclosures

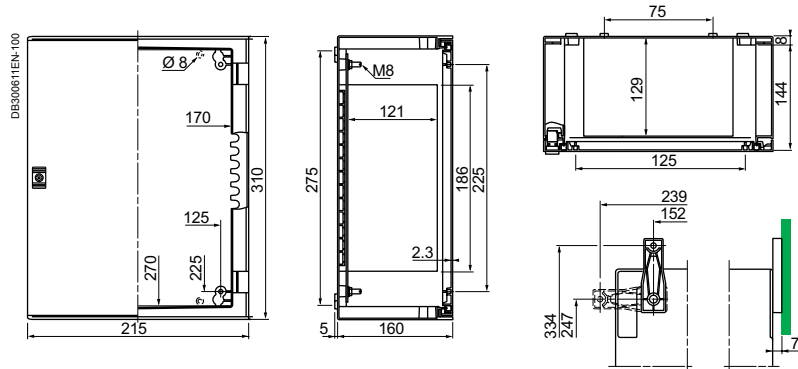

### Polyester wall-mounting enclosures 308 x 255 mm

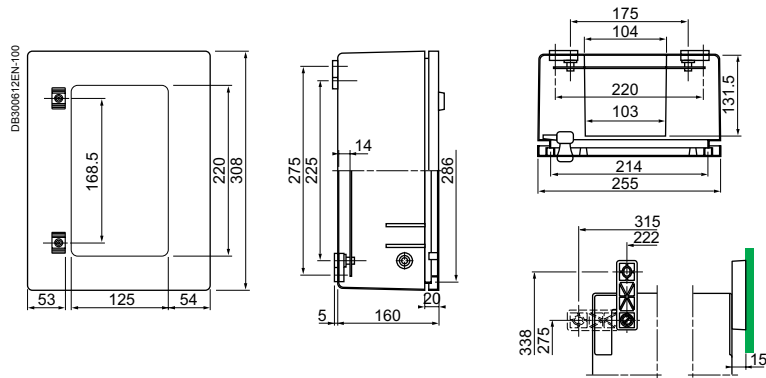

Glazed door opening (mm)		References
U	V	
273	194	NSYPLM43T
	151	NSYPLM43TV
373	294	NSYPLM54T
	251	NSYPLM54TV
463	294	NSYPLM64T
	252	NSYPLM64TV
563	394	NSYPLM75T
	352	NSYPLM75TV
663	494	NSYPLM86T
	452	NSYPLM86TV
854	661	NSYPLM108T

### Other polyester wall-mounting enclosures

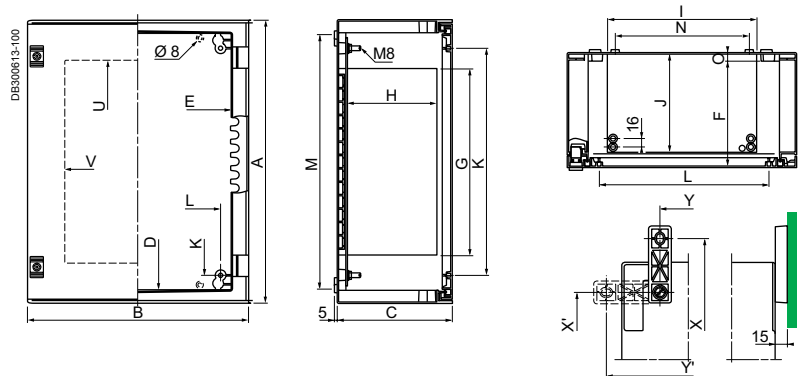

External fixing with lugs (mm)				References
Vertical		Horizontal		
X	Y	X'	Y'	
490	225	355	360	NSYPLM43
590	325	455	460	NSYPLM54
690	330	555	465	NSYPLM64
790	430	655	565	NSYPLM75
890	530	755	665	NSYPLM86
1090	750	955	885	NSYPLM108

Dimensions (mm)										Bottom screw and door bosses (mm)		Internal mounting (mm)			References
A	B	C	D	E	F	G	H	I	J	K	L	M	N	O	
430	330	200	380	260	181	247	150	179	168	325	225	375	150	13	NSYPLM43
530	430	200	480	360	181	347	150	279	168	425	325	475	250	13	NSYPLM54
647	436	250	580	360	228	388	192	279	212	525	325	575	250	13	NSYPLM64
747	536	300	680	460	278	487	241	379	261	625	425	675	350	15	NSYPLM75
847	636	300	780	560	278	587	241	479	261	725	525	775	450	15	NSYPLM86
1056	852	350	980	760	327	775	280	680	300	925	725	975	650	15	NSYPLM108

# Insulating wall-mounting enclosures

## Specific accessories overview

PB501348-88



### Composition accessories

#### Base accessories



PB501747-15

Page 199

#### Mounting



PB501333-24

Page 200

#### Coupling



PB500158-44

Page 201

#### Cable entry



PB500159-23

Page 201

#### Door



PB501335-40

Page 201

#### Locking systems



PB501336-28

Page 202

#### Mounting



PB500163-40

Page 204

#### Diverse



PB501343-32

Page 205

# Insulating wall-mounting enclosures

## Common accessories overview

### Cable management

#### Cable management

PB502492-29

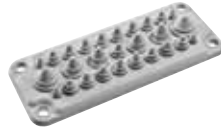

Page 270

#### Cable holding

PB500086-40



Page 270

#### Cable ducting

PB500059-22



Page 289

### Thermal management

#### Heaters

PB502050-29



Page 452

#### Ventilation

PB501044-26



Page 406

#### Thermal control

PB501162-19



Page 459

### Installation accessories

#### Mounting acc.

PB500072-17



Page 236

### Others

#### Document pocket

PB502859-18



Page 297

# Insulating wall-mounting enclosures

## Specific accessories

### Base accessories



Characteristics				ZM plinth for PLM enclosure						
				Designed to support and raise enclosures <b>NSYPLM75G</b> , <b>NSYPLM86G</b> and <b>NSYPLM108G</b> . <ul style="list-style-type: none"> <li>■ Plinth height of 200 mm; stackable to obtain a 400-mm plinth.</li> <li>■ Four floor-attachment points; the symmetry of the parts prevents incorrect assembly. The frontal parts of the plinth (front and rear) have two stainless-steel screws protected by a plastic cap; these screws make it possible (using an Allen key) to open and remove the frontal parts for easier cable installation. In stacked position, the bottom plinth can be partially buried.</li> </ul> It is provided with one transverse reinforcement rail, adjustable to adapt to the position of the cables. The reference of the plinth contains all the accessories required for attaching the enclosure to the plinth and for stacking two plinths.						
Material				Polyester reinforced with fibreglass, moulded by hot compression						
Ingress protection rating				IP44						
Mechanical protection rating				IK10						
Standards				Guarantees total insulation according to IEC 61439-1						
For enclosure				Cabling area		Plinth				
Height (mm)	Width (mm)	Depth (mm)	References	Width (mm)	Depth (mm)	Height (mm)	Width (mm)	Depth (mm)	References	
747	536	300	<b>NSYPLM75</b>	256	252	200	456	302	<b>NSYZM253</b>	
847	636	300	<b>NSYPLM86</b>	356	252	200	556	302	<b>NSYZM263</b>	
1056	852	350	<b>NSYPLM108</b>	572	302	200	772	352	<b>NSYZM283</b>	



Accessories	Cable supporting cross-rail		Kit for IP54	Feet for partially buried installation
	The lateral sides of the plinths are provided with bosses for attaching cross-rails with cut-out profiles, for supporting cables. The reference of the cross-rail includes all the elements required for assembly.		Makes it possible to obtain IP54 for the plinth and the plinth-enclosure coupling.	Allows the partially buried installation of plinths before completion of the floor. The plinths are attached by four feet with a standard length of 750 mm. Possibility of horizontal adjustment of the plinth. The reference includes a kit made up of four feet and mountings.
	For plinth	Cross-rail references	Reference	Reference
	NSYZM253	<b>NSYAC280</b>	<b>NSYAEPZM</b>	<b>NSYAEBFZ</b>
	NSYZM263	<b>NSYAC360</b>		
	NSYZM283	<b>NSYAC600</b>		

# Insulating wall-mounting enclosures

## Specific accessories

### Mounting

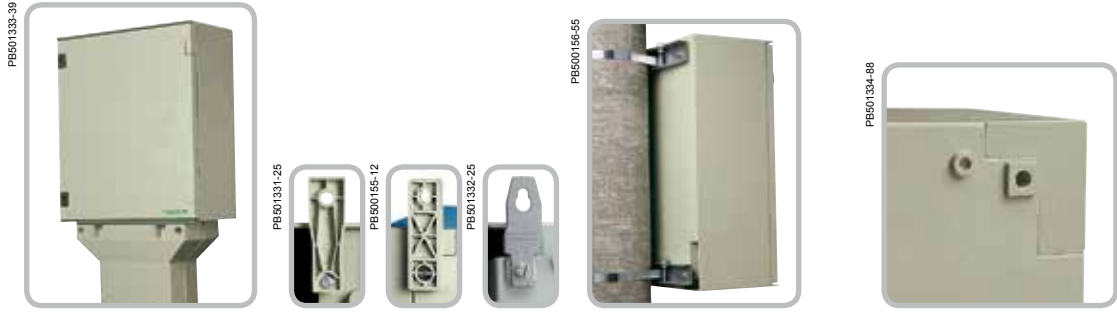

NSYPFPLM32G NSYPFPLMG NSYPFXPLM

Characteristics	Floor-mounting pillar	Wall-mounting brackets	Post-mounting device	Blanking plates			
	To protect cables entering the enclosure in outdoor installations. Cable entry section: 165 x 100 mm. For enclosures ref. <b>NSYPLM54G, NSYPLM54TG, NSYPLM64G and NSYPLM64TG.</b>	Set of 4 wall-mounting brackets. Mounted directly on the enclosure, either in horizontal position or in vertical position.	For outdoor installations on a post with a maximum circumference of 675 mm, Ø 215 mm.	They are positioned on the rear surface of the enclosures to block the openings in the corners in order to improve their appearance or prevent the entry of unwanted elements in the ventilation shaft. Supplied as standard for enclosure, ref. <b>NSYPLM108G.</b>			
Material	Polyester reinforced with fibreglass	Polyamide loaded with fibreglass	Stainless-steel	Galvanised steel			
Colour	RAL 7032 grey*	-	-	-			
Maximum load	-	<ul style="list-style-type: none"> <li>■ Vertical position: 300 kg</li> <li>■ Horizontal position: 100 kg</li> </ul>	100 kg	-			
Supply	Delivered with steel frame for secure mounting to the floor	Delivered with mountings	Supply of the rail, the strips and the mountings	-			
	<b>Reference</b>	<b>References</b>	<b>For wall-mounting enclosure</b>	<b>References</b>	<b>For wall-mounting enclosure</b>	<b>References</b>	
	<b>NSYSFSPLM</b>	<b>NSYPFPLM</b> <b>NSYPFPLM32 (1)</b>	<b>NSYPFXPLM</b>	<b>NSYPLM43</b> <b>NSYPLM54 y NSYPLM64</b> <b>NSYPLM75</b> <b>NSYPLM86</b>	<b>NSYSFP300 (2)</b> <b>NSYSFP400</b> <b>NSYSFP500</b> <b>NSYSFP600</b>	<b>NSYPLM32</b> <b>NSYPLM43 y NSYPLM54</b> <b>NSYPLM64, 75 y 86</b> -	<b>NSYCEPLMA</b> <b>NSYCEPLMB</b> <b>NSYCEPLMC</b> -

(1) Exclusive for enclosures ref. **NSYPLM32** and **NSYPLM32T.**

(2) **NSYSFP300** can be used for fixation of **NSYPLM32** using the mounting brackets **NSYPFPLM32** (screws not supplied).

The length of the cross rail is slightly larger than enclosure.

\* RAL 7035 from 2016.



# Insulating wall-mounting enclosures

## Specific accessories

### Coupling and cable-entry



Characteristics			Coupling frame	Cable-gland plates
			Allows the lateral coupling of 2 enclosures.	Dimensions: 435 x 185 mm and 635 x 185 mm.
Material			Polyester frame	Polyester
Colour			RAL 7032 grey*	RAL 7032 grey*
Ingress protection rating			A built-in sealing gasket guarantees a protection rating of IP66	-
Supply			Delivered with mountings	-
External dimensions (mm)	Entry	For wall-mounting enclosure	References	
435 x 185 x 15	398 x 148	NSYPLM75 and NSYPLM86	<b>NSYBUPLM</b>	<b>NSYTLA4420</b>
635 x 185 x 15	598 x 148	NSYPLM108	<b>NSYBU108PLM</b>	<b>NSYTLA6420</b>

\* RAL 7035 from 2016.

### Door



Characteristics			Internal door					
			<ul style="list-style-type: none"> <li>■ Reversible door.</li> <li>■ Grid pattern with a pitch of 25 mm for easier marking out before drilling.</li> <li>■ Closes with 2 double-bar locks.</li> <li>■ Door handle.</li> <li>■ Steel internal door, without grid pattern and locking by a screw, for enclosures ref. <b>NSYPLM3025G</b>.</li> <li>■ Incompatible with the modular distribution chassis.</li> </ul>					
Material			Polyester reinforced with fibreglass, self-extinguishing					
Colour			RAL 7032 grey*					
Supply			Delivered with mountings and brass inserts					
For wall-mounting enclosure (mm)			Dimensions (mm)				References	
Height	Width		A	B	C	D		
						Plain door	Transp. door	
308	255		248	165	62	76	71	<b>NSYPA3025PLM</b>
430	330		315	205	152	26	21	<b>NSYPAP43</b>
530	430		415	305	152	26	21	<b>NSYPAP54</b>
645	435		515	305	194	32	27	<b>NSYPAP64</b>
745	535		615	405	244	32	27	<b>NSYPAP75</b>
845	635		715	505	244	32	27	<b>NSYPAP86</b>
1055	850		850	650	269	37	32	<b>NSYPAP108</b>

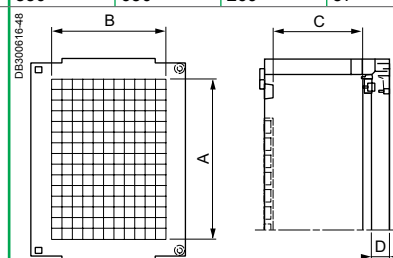

\* RAL 7035 from 2016.

# Insulating wall-mounting enclosures

## Specific accessories

### Locking system



#### Characteristics

#### Locks and inserts for enclosures with H ≤ 847 mm

- The ABS/PC 310 x 215 mm enclosure is supplied with a lock with a double-bar insert as standard.
- The 308 x 255 mm enclosure is supplied with two locks with a double-bar insert as standard.
- The polyester enclosures from 430 to 847 mm high are delivered as standard with:
  - 2 locks with double-bar insert, ref. **NSYCDBPLM**,
  - or a 3-point closure with handle and lock with key 1242 E (enclosures **NSYPLM●●V**).
- Double-bar insert ref. **NSYTDBCRN**, is placed in a rectangular escutcheon.
- A plastic key, ref. **NSYDBP**, enabling the opening of the double-bar insert, is included in the standard supply. This key can be fixed to the double-bar system to remain on the enclosure and be used as a handle.

#### Options



- NSYTC6CRN
- NSYTC7CRN
- NSYTC8CRN
- NSYTT6CRN
- NSYTT8CRN
- NSYTL405PLM
- NSYTL220PLM
- NSYTHL1242EPLM
- NSYTHL405PLM
- NSYTHL421PLM
- NSYTHL455PLM
- NSYTHL2331APLM
- NSYTHL2433APLM
- NSYTHL3113APLM
- NSYTHPLM

#### Options to transform the locks with double-bar inserts

Changing the shape inserts for locks with keys according to the following table.

Replacement for locking handle with cylindrical barrel, delivered with all the parts required to change the lock.

Name	References	Type of barrel	References
6 mm male square	<b>NSYTC6CRN</b>	Key 1242 E	<b>NSYTHL1242EPLM</b>
7 mm male square	<b>NSYTC7CRN</b>	Key 405	<b>NSYTHL405PLM</b>
8 mm male square	<b>NSYTC8CRN</b>	Key 421	<b>NSYTHL421PLM</b>
6.5 mm male triangle	<b>NSYTT6CRN</b>	Key 455	<b>NSYTHL455PLM</b>
-	-	Key 610	<b>NSYTHL610PLM</b> <span style="color: red;">New</span>
8 mm male triangle	<b>NSYTT8CRN</b>	Key 2331 A	<b>NSYTHL2331APLM</b>
Lock and key 405	<b>NSYTL405PLM</b>	Key 2433 A	<b>NSYTHL2433APLM</b>
Lock and key 220	<b>NSYTL220PLM</b>	Key 3113 A	<b>NSYTHL3113APLM</b>
-	-	Key 3131A	<b>NSYTHL3131APLM</b> <span style="color: red;">New</span>
-	-	Manual	<b>NSYTHPLM</b>

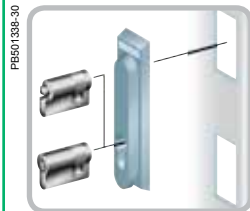

#### Options to transform versions NSYPLM●●V, with retractable handle and 3-point closure

Transformation of the standard insert (barrel for key 1242E, ref. **NSYTL1242EME**) for other shape inserts or barrels according to the following table.

Name	References
5 mm double bar	<b>NSYTDDB5ME</b>
6 mm male square	<b>NSYTC6ME</b>
7 mm male square	<b>NSYTC7ME</b>
8 mm male square	<b>NSYTC8ME</b>
6.5 mm male triangle	<b>NSYTT6ME</b>
8 mm male triangle	<b>NSYTT8ME</b>
Barrel and key 405	<b>NSYTCL405ME</b>
Reinforced key and barrel	<b>NSYTLRME</b>
JIS key and barrel	<b>NSYTLJISME</b>
Manual	<b>NSYTMME</b>

### Locking system

#### Locks and inserts for enclosures NSYPLM108/T

- Enclosures delivered as standard with 5 mm double-bar insert.
- Insert ref. **NSYTDB5PL**, placed in a long rectangular escutcheon, activates a 4-point closure system.

PB501339-30

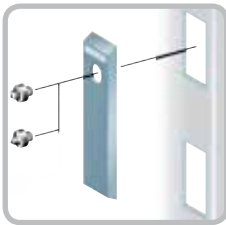

#### Options to transform the insert

The standard insert can be replaced with other shape inserts, according to the following table.

Name	References
6 mm male square	NSYTC6PL
7 mm male square	NSYTC7PL
8 mm male square	NSYTC8PL
6.5 mm male triangle	NSYTT6PL
7 mm male triangle	NSYTT7PL
8 mm male triangle	NSYTT8PL

PB501340-20

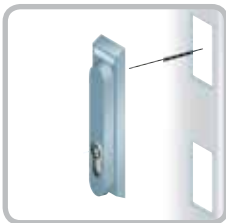

#### Options to transform for a retractable handle

The escutcheon and rosette assembly can be replaced with a lock with retractable handle equipped with inserts or barrels, according to the following table.

Name	References
5 mm double bar	NSYTEDB5PL
6 mm male square	NSYTEC6PL
7 mm male square	NSYTEC7PL
8 mm male square	NSYTEC8PL
6.5 mm male triangle	NSYTET6PL
7 mm male triangle	NSYTET7PL
8 mm male triangle	NSYTET8PL
Lock key 1242 E	NSYTEL1242EPL
Barrel and key 405	NSYTEL405PL
Reinforced key and barrel	NSYTERPL
JIS key and barrel	NSYTELJISPL
FAC key and barrel	NSYTELFACPL
Manual	NSYTEMPL

PB501341-23



DE300617-23

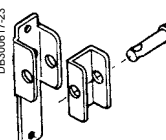

DE300618-11



#### Padlocking accessories

	Padlocking system positioned around the rectangular escutcheon of the enclosures with a height of ≤ 847 mm to block access to the lock; for a Ø 9 mm padlock.	Padlocking system positioned around the long rectangular escutcheon of the enclosures ref. <b>NSYPLM108G/TG</b> , to block access to the lock; for Ø 9 mm padlock.	Padlocking system to block access to the retractable handle, for the versions <b>NSYPLM••V</b> or optionally for enclosures ref. <b>NSYPLM108G/TG</b> , for a Ø 9 mm padlock.
References	<b>NSYKPLM</b>	<b>NSYBCPL</b>	<b>NSYBCME</b>

# Insulating wall-mounting enclosures

## Specific accessories

### Mounting accessories



Characteristics		Step slides			Plastic nuts for rail mounting		35 mm symmetrical DIN rails	
		Kit allowing depth adjustment with a pitch of 12.5 mm, and the mountings required for the installation. Incompatible with the modular distribution chassis.			They slide directly into the notches, with a pitch of 25 mm, which are located on the rear of the enclosures, except enclosure ref. <b>NSYPLM3025/T</b> . They allow direct mounting of symmetrical DIN rails by self-tapping screws. Option of raising the rails with an M6 spacer using a plastic nut containing an M6 nut.		They are fixed to the rear of the enclosure without uprights, with a pitch of 25 mm for the notches on the rear of the enclosure, with the help of direct-mounting nuts ref. <b>NSYTCSPML</b> or <b>NSYTCSM6PLM</b> .	
Material		Galvanised steel			-		Treated steel	
Supply		4 step slides with brackets			References by unit. Order by multiples of 20 units (20, 40, 60, etc.)		References by unit. Order by multiples of 2 units (2, 4, 6, etc.)	
For wall-mounting enclosure (mm)		Depth adjustment (mm)		References	Name	References	Rail length (mm)	References
Width	Depth	A	B					
-	-	-	-	-	Plastic nut with self-tapping screw	<b>NSYTCSPML</b>	-	-
-	-	-	-	-	Plastic nut containing an M6 metal nut	<b>NSYTCSM6PLM</b>	-	-
215	-	-	-	-	-	-	180	<b>NSYCS200PLM</b>
330	-	-	-	-	-	-	280	<b>NSYCS300PLM</b>
430 / 436	-	-	-	-	-	-	380	<b>NSYCS400PLM</b>
536	-	-	-	-	-	-	480	<b>NSYCS500PLM</b>
636	-	-	-	-	-	-	580	<b>NSYCS600PLM</b>
852	-	-	-	-	-	-	795	<b>NSYCS800PLM</b>
-	200	156	94	<b>NSYDPLM200</b>	-	-	-	-
-	250	200	100	<b>NSYDPLM250</b>	-	-	-	-
-	300	250	100	<b>NSYDPLM300</b>	-	-	-	-
-	350	306	106	<b>NSYDPLM350</b>	-	-	-	-

# Insulating wall-mounting enclosures

## Specific accessories

### Diverse



Characteristics	Mounting inserts			Ventilation louvres*	Water drain plug	Renovation and anti-graffiti paint		
	Expanding inserts for addition to the M6 bosses of the enclosure, the M5 or M6 bosses of the door and the M8 bosses of the external rear part of the enclosure.			They can be positioned inside the wall-mounting enclosures with heights of 430 to 846 mm, allowing ventilation through the channels of the enclosure.	For drainage of condensation water. It is placed in the Ø 8.5 mm** housing at the bottom of the enclosure.	Paint kit with 2 components (base 80 % + hardener 20 %), specially designed for polyester enclosures, for their renovation and/or as prevention to allow easy removal of graffiti.		
Colour	-			-	-	RAL 7032 grey		
Ingress protection rating	-			The IP on the rear of the enclosures is IP44	IP53 (IEC 60529 cat. 2)	-		
Supply	References by unit. Order by multiples of 8 units (8, 16, 24, etc.). M5 and M6 inserts to be ordered in multiples of 20			References by unit. Order by multiples of 2 units (2, 4, 6, etc.)	References by unit. Order by multiples of 10 units (10, 20, 30, etc.)	The 1 kg reference includes 1 pot with 800 g of base paint and 200 g of hardener (It is enough to paint a surface of around 5 m <sup>2</sup> )	The 5 kg reference includes 1 pot with 4 kg of base paint and 1 kg of hardener (It is enough to paint a surface of around 25 m <sup>2</sup> )	500 g
	<b>Insert size</b>	<b>For wall-mounting enclosure</b>	<b>References</b>	<b>Reference</b>	<b>Reference</b>	<b>References</b>		
	M5	NSYPLM43G and NSYPLM54G	NSYTEX5	NSYCAG35LP	NSYVEA9	NSYAUPG1	NSYAUPG5	NSYAUPGS
	M6	NSYPLM64G and NSYPLM108G	NSYTEX6					
	M8	For the rear of the enclosure	NSYTEX8PLM					

\* Ventilation louvres, airing devices with filters, fans and thermal adjustment accessories, see ClimaSys section.  
 \*\* 8.2 mm for wall-mounting enclosures NSYPLM32, NSYPLM32T, NSYPLM32P and NSYPLM32B.

# Insulating wall-mounting enclosures

## Specific accessories

**S3DC S3X**  
**PLM**

\* Minimum depth 200 mm.

### Power distribution accessories



#### Characteristics Dinimel DLA modular chassis

- Front panels and covers installed in the front part, are not depth adjustable.
- Rigid structure for the installation of modular devices.
- Open front panels with 35 mm DIN rail and plain front panels with mounting plate, according to the model.
- Quick installation with no mountings.
- Shoulder height adjustable from 40 to 85 mm.
- System for standard circuit marking.
- Incompatible with the internal doors and the step slides.
- Neutral / earth strip: 2 x 16 mm<sup>2</sup> + 5 x 6 mm<sup>2</sup>.

Material ■ Front panels and finish covers: self-extinguishing insulating  
 ■ Rigid structure: galvanised-steel

Colour Front panels and finish covers: RAL 7032 grey\*

Dimensions (mm)					Distribution rows				For installation in the enclosures				References
A	B	C	D min.	E min.	No. of useful rows	No. of 18 mm modules per row	No. of 18 mm modules	No. of plates	PLM enclosure		S3D enclosure (depth ≥ 200 mm)		
									References		Height	Width	
216	115	137	38	88	2	12	24	-	NSYPLM43	NSYPLM43T	400	300	NSYDLA24
286	90	112	38	88	3	16	48	-	NSYPLM54	NSYPLM54T	500	400	NSYDLA48
286	140	170	80	130	3	16	48	-	NSYPLM64	NSYPLM64T	600	400	NSYDLA48P
395	115	145	129	179	3	22	66	1	NSYPLM75	NSYPLM75T	700	500	NSYDLA66
395	115	145	129	179	4	22	88	-	NSYPLM75	NSYPLM75T	700	500	NSYDLA88
504	165	195	129	179	3	28	84	1	NSYPLM86	NSYPLM86T	800	600	NSYDLA84
504	165	195	129	179	4	28	112	-	NSYPLM86	NSYPLM86T	800	600	NSYDLA112
704	115	146	170	220	6	39	234	-	NSYPLM108	NSYPLM108T	1000	800	NSYDLA234

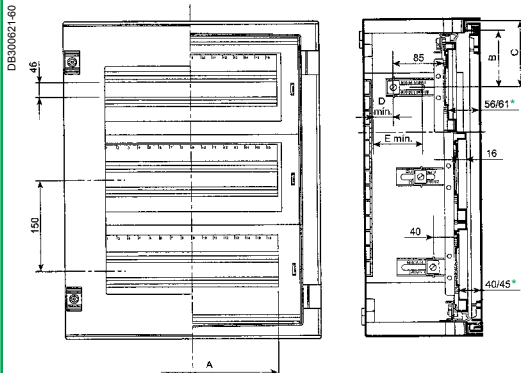
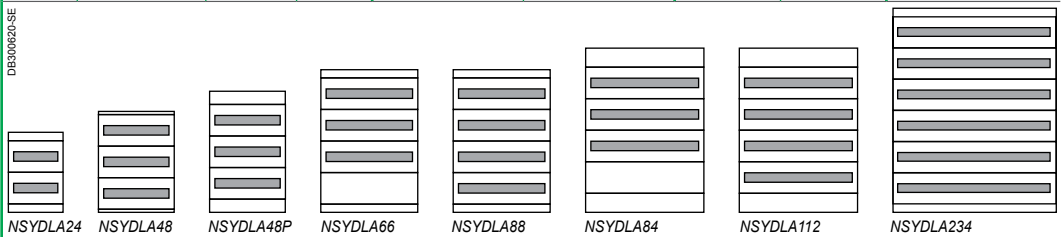

\* Models NSYDLA48P, 66, 88, 84 and 112.

\* RAL 7035 from 2016.

# Insulating wall-mounting enclosures

## Specific accessories

### Power distribution accessories

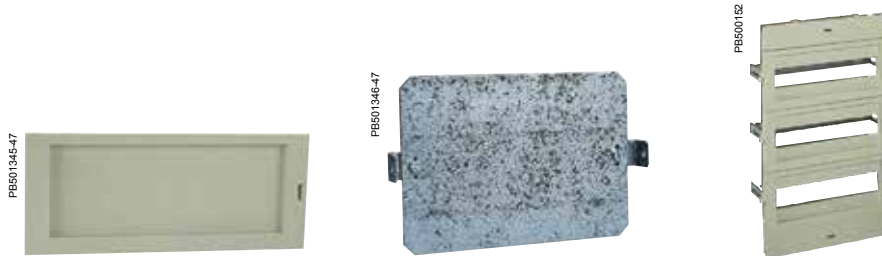

Characteristics	Plain front panels for Dinimel DLA chassis		Mounting plate for Dinimel DLA chassis		Modular distribution chassis
	<ul style="list-style-type: none"> <li>■ Front panel for non-modular device protection, on one row.</li> <li>■ To be ordered in multiples of 2.</li> </ul>		<ul style="list-style-type: none"> <li>■ Mounting plate for mounting non-modular devices, on one row.</li> <li>■ To be ordered in multiples of 2.</li> </ul>		For mounting modular devices on two rows of nine 18-mm modules.
Material	Self-extinguishing insulating		Galvanised-steel		<ul style="list-style-type: none"> <li>■ Chassis: metal</li> <li>■ Protective plate: insulating material</li> </ul>
Colour	RAL 7032 grey*		-		-
<b>For installing on the chassis</b>	<b>Width (mm)</b>	<b>References</b>	<b>Width (mm)</b>	<b>References</b>	<b>Reference</b>
<b>NSYDLA24</b>	256	<b>NSYCTL300DLA</b>	-	-	-
<b>NSYDLA48 and NSYDLA48P</b>	356	<b>NSYCTL400DLA</b>	315	<b>NSYPMP400DLA</b>	-
<b>NSYDLA66 and NSYDLA88</b>	456	<b>NSYCTL500DLA</b>	415	<b>NSYPMP500DLA</b>	-
<b>NSYDLA84 and NSYDLA112</b>	555	<b>NSYCTL600DLA</b>	514	<b>NSYPMP600DLA</b>	-
<b>NSYDLA234</b>	755	<b>NSYCTL800DLA</b>	714	<b>NSYPMP800DLA</b>	-
<b>For enclosure</b>					
<b>NSYPLM3025G/TG</b>	-	-	-	-	<b>NSYDLPLM18</b>

\* RAL 7035 from 2016.

# Insulating floor-standing enclosures



# Insulating floor-standing enclosures

## Contents



<b>Thalassa PLA</b>	<b>210</b>
<b>Polyester floor-standing enclosures</b>	
Introduction	210
Characteristics	211
Dimensions	212
Selection guide	214
Specific accessories overview	216
Common accessories overview	217
Specific accessories	218



<b>Associated applicative offers</b>	
<b>PHD Polyester Heavy Duty enclosures</b>	<b>306</b>

**New**

### Early 2016, the PLA and PLD ranges change color

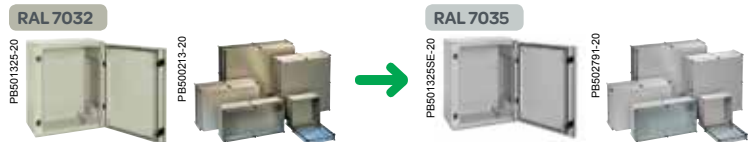

**> Why change?**

To harmonize the Schneider Electric Universal enclosures offer. Answer to customer requests and to the the market trends.

**> What happen with the part numbers (references)?**

Every product that have changed in colour have also changed the part number. It is done just adding a letter "G" at the end on reference. *Example:*

RAL 7032	RAL 7035
NSYPLM43	NSYPLM43G

**> How can I obtain RAL 7032 enclosures?**  
Consult us.

**> Will the new RAL 7035 colour offer the same properties as RAL 7032?**  
Yes, all mechanical properties will be the same. The light reflexion is even improved.

**New dimensions**  
2000 mm height  
620 mm depth

# Polyester floor-standing enclosures

## Introduction

> The **floor-standing enclosures** are made from **polyester reinforced with fibreglass**, moulded by hot compression. High resistance to corrosion in harsh environments, it maintains its mechanical and insulation properties.



### Bigger dimensions

The new options with **2000 mm** height and **620 mm** depth have been created to meet industry and infrastructure demands for motor control, power distribution, electronics or telecom applications.

#### PLAT version



##### Ventilation

Open top part with canopy allowing for ventilation.



##### Easy

Various bosses for M8 inserts.

#### PLAZ version



##### Open bottom

Big open bottom to be mounted directly on the floor or on a plinth.



##### Smart

Plain mounting plate installed on step slides and compulsory adapter plates in all the enclosures with open bottom part.

#### PLAZT version



##### Easy

Door opening to 180°.



##### Resistant

Anti-lever security system.

**This range can be configured according to your needs**

4 different services available:



Assemble to order



Mounting of standard accessories



Painting



Machining

See page 396 for details or consult our web site [www.schneider-electric.com](http://www.schneider-electric.com)

# Polyester floor-standing enclosures

## Characteristics



Characteristics	PLA version	PLAT version	PLAZ version	PLAzt version
	<p><b>Completely sealed enclosure</b></p> <ul style="list-style-type: none"> <li>■ Enclosure obtained by assembling:                             <ul style="list-style-type: none"> <li>□ 1 sealed top part,</li> <li>□ 1 sealed bottom part,</li> <li>□ 2 side parts,</li> <li>□ 1 or 2 rear panels (according to width),</li> <li>□ 1 or 2 doors (according to width).</li> </ul> </li> <li>■ Locking system with escutcheon and 5-mm double-bar insert, included in the standard supply. Other inserts or locks with handles optionally available.</li> <li>■ Door opening to 120°.</li> </ul>	<p><b>Enclosure with ventilated canopy</b></p> <ul style="list-style-type: none"> <li>■ Enclosure obtained by assembling:                             <ul style="list-style-type: none"> <li>□ 1 open top part with canopy,</li> <li>□ 1 sealed bottom part,</li> <li>□ 2 side parts,</li> <li>□ 1 or 2 rear panels (according to width),</li> <li>□ 1 or 2 doors (according to width).</li> </ul> </li> <li>■ Locking system with handle with a 5-mm double-bar insert block, included in the standard supply. Other blocks with inserts or barrels and keys optionally available.</li> <li>■ Door opening to 120°.</li> </ul>	<p><b>Enclosure with plinth-type open bottom</b></p> <ul style="list-style-type: none"> <li>■ Enclosure obtained by assembling:                             <ul style="list-style-type: none"> <li>□ 1 sealed top part,</li> <li>□ 1 plinth-type open bottom part,</li> <li>□ 2 side parts,</li> <li>□ 1 or 2 rear panels (according to width),</li> <li>□ 1 or 2 doors (according to width).</li> </ul> </li> <li>■ Locking system with handle with a 5 mm double-bar insert block, included in the standard supply. Other blocks with inserts or barrels and keys optionally available.</li> <li>■ Door opening to 120°.</li> </ul>	<p><b>Enclosure with plinth-type open bottom and ventilated canopy</b></p> <ul style="list-style-type: none"> <li>■ Enclosure obtained by assembling:                             <ul style="list-style-type: none"> <li>□ 1 open top part with canopy,</li> <li>□ 1 plinth-type open bottom part,</li> <li>□ 2 side parts,</li> <li>□ 1 or 2 rear panels (according to width),</li> <li>□ 1 or 2 doors (according to width).</li> </ul> </li> <li>■ Locking system with handle with a 5 mm double-bar insert block. Other blocks with inserts or barrels and keys optionally available.</li> <li>■ Door opening to 180°.</li> <li>■ Anti-lever system to prevent forcing of the door.</li> </ul>
Material	Polyester reinforced with fibreglass			
Finish	Moulded by hot compression: the pieces have an excellent finish on both sides and can include numerous bosses for accommodating inserts and mounting or cable management accessories			
Colour	RAL 7032 grey*			
Ingress protection rating	IP65 according to IEC 60529	<ul style="list-style-type: none"> <li>■ IP44 according to IEC 60529</li> <li>■ IP54 with 1 or 2 internal grilles, ref. <b>NSYCAG125LPP</b>, to be ordered separately</li> </ul>	IP54 according to IEC 60529	<ul style="list-style-type: none"> <li>■ IP44 according to IEC 60529</li> <li>■ IP54 with 1 or 2 internal grilles, ref. <b>NSYCAG125LPP</b>, to be ordered separately</li> </ul>
Mechanical protection rating	<ul style="list-style-type: none"> <li>■ IK10 (20 joules) plain door - IEC62262</li> <li>■ IK08 (5 joules) glazed door</li> </ul>			
Insulation	Class II according to IEC 60950-1			
Certifications	<ul style="list-style-type: none"> <li>■ UL 508A/CAN-C22.2 No. 14</li> <li>□ single door: types 1, 2, 3, 3R, 3S, 4, 4X, 5, 12 and 13</li> <li>□ double door: types 1, 2, 12 and 13</li> <li>■ Marine</li> <li>■ IEC 62208</li> <li>■ Environment: the factory complies with ISO 14 001 (Environmental management and ISO 50 001 (Energy management system)</li> </ul>	<ul style="list-style-type: none"> <li>■ 62208</li> <li>■ Environment: the factory complies with ISO 14 001 (Environmental management) and ISO 50 001 (Energy management system)</li> </ul>		
Installation	<ul style="list-style-type: none"> <li>■ Indoor use only. For outdoor use, must install a canopy</li> </ul>	<ul style="list-style-type: none"> <li>■ Outdoor or indoor installation: compliant with IEC 62208 regarding type tests specified in §9.12 (resistance to ultra-violet (UV) radiation) and §9.13 (resistance to corrosion). It is always advisable to install a canopy to avoid water stagnation on the upper part of the enclosure</li> </ul>		<ul style="list-style-type: none"> <li>■ The open bottom part forms a 60 mm plinth which is fixed to the floor directly or by means of an optional mounting frame, see page 222, or else it is installed on a semi-embedded plinth, see page 222</li> </ul>
	<ul style="list-style-type: none"> <li>■ Direct mounting to the floor or by means of a plinth with a height of 60 mm, as an option, see page 220</li> <li>■ Possibility of mounting on a semi-embedded plinth, page 220</li> <li>■ Optional wall-mounting brackets</li> </ul>			
Options	Anti-posting door upon request			

\*RAL 7035 from 2016.

➤ **PHD - Applicative and customised solutions**

See the Polyester Heavy Duty offer in the Applicative and customised solutions, page 332.

# Polyester floor-standing enclosures

## Dimensions

### PLA

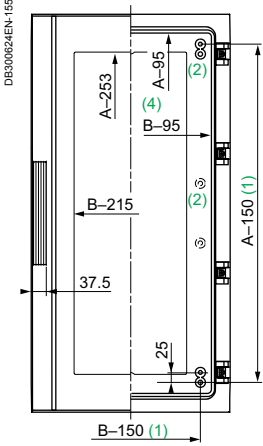

### Sealed enclosure

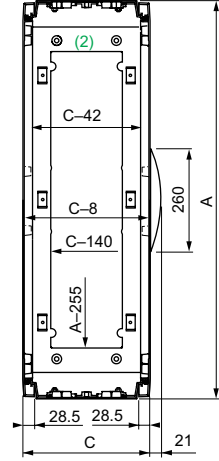
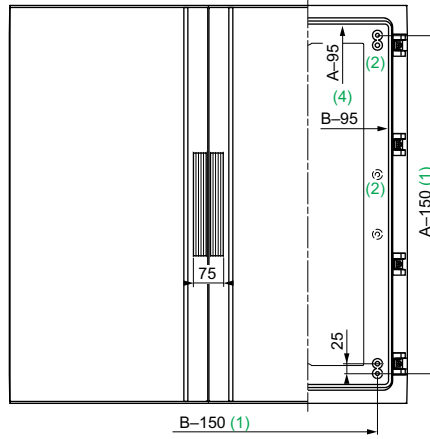

### PLAT

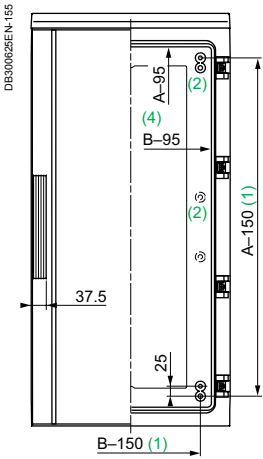

### Enclosure with ventilated canopy

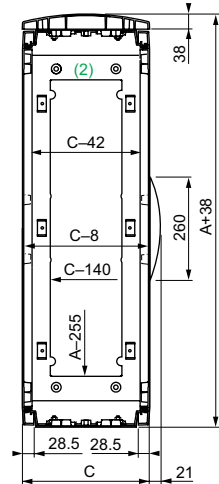
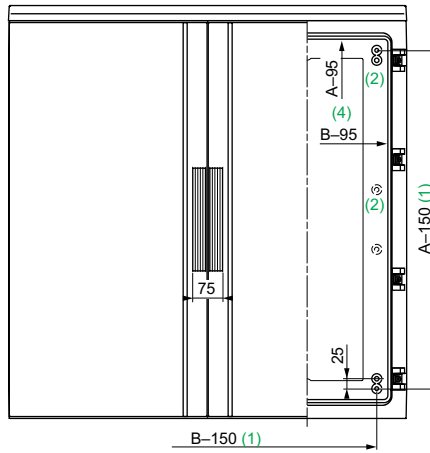

### Common top views

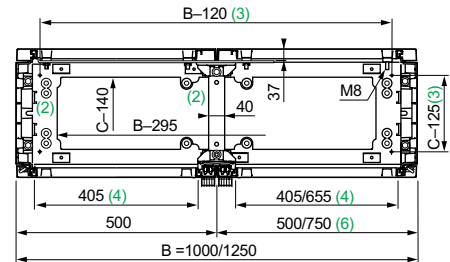
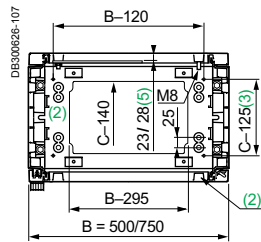

# Polyester floor-standing enclosures

## Dimensions

### PLAZ

### Enclosure with plinth-type open bottom part

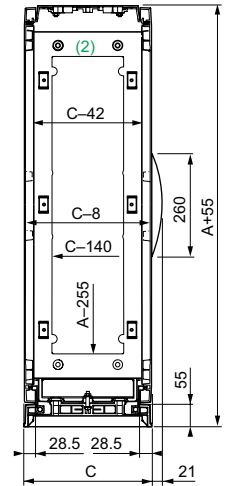
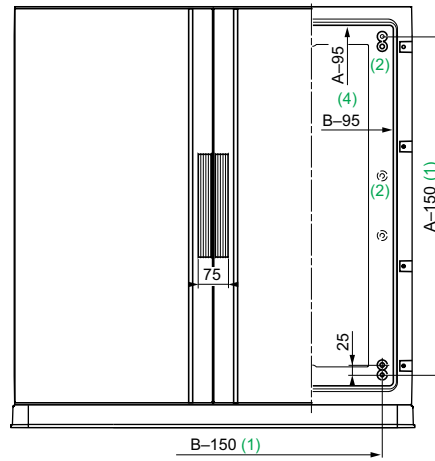
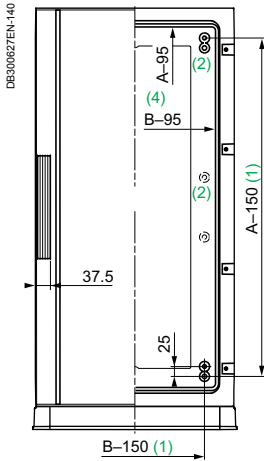

### PLAZT

### Enclosure with ventilated canopy and plinth-type open bottom part

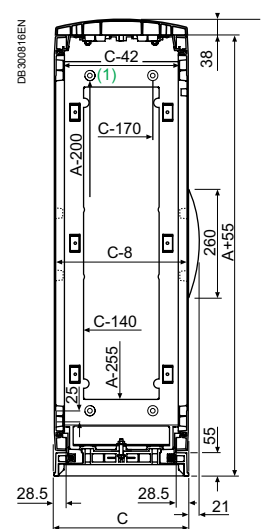
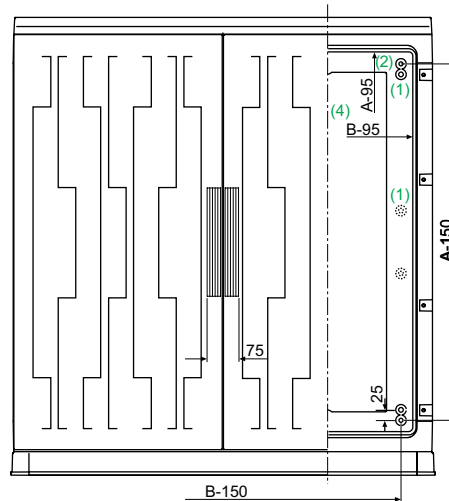
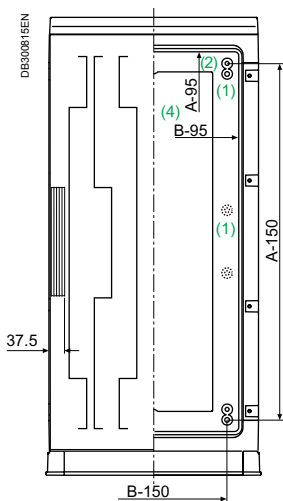

### Common top views

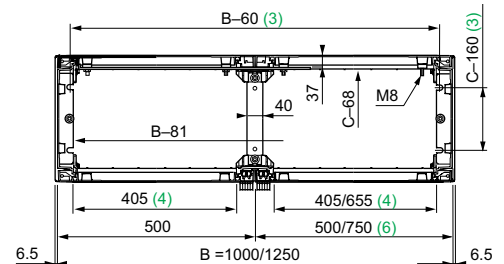
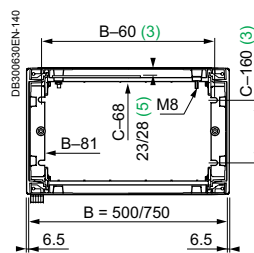

- (1) 4 bosses with M8 inserts and studs for direct mounting of mounting plates.
- (2) Bosses designed to accommodate M8 inserts, ref. **NSYTEX8**. They are placed:
  - On the back of the enclosure, from the height of 1000 mm. They allow the mounting of partial mounting plates and assorted equipment.
  - On the top and bottom parts of the enclosure. They are used for mounting the step slides, an internal door, 19" chassis, etc.
- (3) Dimensions for mounting on the floor or on a plinth.
- (4) Entry dimensions, door open.
- (5) Dimension of 28 mm for enclosures with heights of more than 1000 mm (height after the installation of the plain mounting plates with reinforcement foldings).
- (6) With a width of 1250 mm in standard supply, 500-mm door on the left and 750-mm door on the right.

# Polyester floor-standing enclosures

## Selection guide

**[!]** Indoor and Outdoor  
For outdoor use, must install a canopy.

### IP65 or IP54

**PLA**



**PLAZ**



Dimensions (mm)				Completely sealed enclosures, IP65		Enclosures with plinth-type open bottom part, IP54	
References of enclosures with door							
Height (A)	Width (B)	Depth (C)	N° of doors	Plain	Glazed	Plain	
500	500	320	1	NSYPLA553	NSYPLA553T	NSYPLAZ553	
		420	1	NSYPLA554	NSYPLA554T	NSYPLAZ554	
	750	320	1	NSYPLA573	NSYPLA573T	NSYPLAZ573	
		420	1	NSYPLA574	NSYPLA574T	NSYPLAZ574	
	1000	320	2	NSYPLA5103	NSYPLA5103T	NSYPLAZ5103	
			420	2	NSYPLA5104	NSYPLA5104T	NSYPLAZ5104
	1250	320	2	NSYPLA5123	NSYPLA5123T	NSYPLAZ5123	
			420	2	NSYPLA5124	NSYPLA5124T	NSYPLAZ5124
750	500	320	1	NSYPLA753	NSYPLA753T	NSYPLAZ753	
		420	1	NSYPLA754	NSYPLA754T	NSYPLAZ754	
	750	320	1	NSYPLA773	NSYPLA773T	NSYPLAZ773	
		420	1	NSYPLA774	NSYPLA774T	NSYPLAZ774	
	1000	320	2	NSYPLA7103	NSYPLA7103T	NSYPLAZ7103	
			420	2	NSYPLA7104	NSYPLA7104T	NSYPLAZ7104
	1250	320	2	NSYPLA7123	NSYPLA7123T	NSYPLAZ7123	
			420	2	NSYPLA7124	NSYPLA7124T	NSYPLAZ7124
	1000	500	320	1	NSYPLA1053	NSYPLA1053T	NSYPLAZ1053
			420	1	NSYPLA1054	NSYPLA1054T	NSYPLAZ1054
		750	320	1	NSYPLA1073	NSYPLA1073T	NSYPLAZ1073
			420	1	NSYPLA1074	NSYPLA1074T	NSYPLAZ1074
1000		320	2	NSYPLA10103	NSYPLA10103T	NSYPLAZ10103	
			420	2	NSYPLA10104	NSYPLA10104T	NSYPLAZ10104
1250		320	2	NSYPLA10123	NSYPLA10123T	NSYPLAZ10123	
			420	2	NSYPLA10124	NSYPLA10124T	NSYPLAZ10124
1250		500	320	1	NSYPLA1253	NSYPLA1253T	NSYPLAZ1253
			420	1	NSYPLA1254	NSYPLA1254T	NSYPLAZ1254
		750	320	1	NSYPLA1273	NSYPLA1273T	NSYPLAZ1273
			420	1	NSYPLA1274	NSYPLA1274T	NSYPLAZ1274
	1000	320	2	NSYPLA12103	NSYPLA12103T	NSYPLAZ12103	
			420	2	NSYPLA12104	NSYPLA12104T	NSYPLAZ12104
	1250	320	2	NSYPLA12123	NSYPLA12123T	NSYPLAZ12123	
			420	2	NSYPLA12124	NSYPLA12124T	NSYPLAZ12124
	1500	500	320	1	NSYPLA1553	NSYPLA1553T	NSYPLAZ1553
			420	1	NSYPLA1554	NSYPLA1554T	NSYPLAZ1554
		750	320	1	NSYPLA1573	NSYPLA1573T	NSYPLAZ1573
			420	1	NSYPLA1574	NSYPLA1574T	NSYPLAZ1574
1000		320	2	NSYPLA15103	NSYPLA15103T	NSYPLAZ15103	
			420	2	NSYPLA15104	NSYPLA15104T	NSYPLAZ15104
1250		320	2	NSYPLA15123	NSYPLA15123T	NSYPLAZ15123	
			420	2	NSYPLA15124	NSYPLA15124T	NSYPLAZ15124

**> PHD - Applicative and customised solutions**

See the Polyester Heavy Duty offer in the Applicative and customised solutions, page 332.

# Polyester floor-standing enclosures

## Selection guide

### IP44

**PLAT**



PE500170-21

**PLAZT**



PE500172-19

Dimensions (mm)				Enclosures with ventilated canopy, IP44	Enclosures with plinth-type open bottom part and ventilated canopy, IP44	
<b>References of enclosures with door</b>						
Height (A)	Width (B)	Depth (C)	N° of doors	Plain	Plain	
500	500	320	1	NSYPLAT553	NSYPLAZT553	
		420	1	NSYPLAT554	NSYPLAZT554	
	750	320	1	NSYPLAT573	NSYPLAZT573	
		420	1	NSYPLAT574	NSYPLAZT574	
	1000	320	2	NSYPLAT5103	NSYPLAZT5103	
		420	2	NSYPLAT5104	NSYPLAZT5104	
	1250	320	2	NSYPLAT5123	NSYPLAZT5123	
		420	2	NSYPLAT5124	NSYPLAZT5124	
750	500	320	1	NSYPLAT753	NSYPLAZT753	
		420	1	NSYPLAT754	NSYPLAZT754	
	750	320	1	NSYPLAT773	NSYPLAZT773	
		420	1	NSYPLAT774	NSYPLAZT774	
	1000	320	2	NSYPLAT7103	NSYPLAZT7103	
		420	2	NSYPLAT7104	NSYPLAZT7104	
	1250	320	2	NSYPLAT7123	NSYPLAZT7123	
		420	2	NSYPLAT7124	NSYPLAZT7124	
	1000	500	320	1	NSYPLAT1053	NSYPLAZT1053
			420	1	NSYPLAT1054	NSYPLAZT1054
750		320	1	NSYPLAT1073	NSYPLAZT1073	
		420	1	NSYPLAT1074	NSYPLAZT1074	
1000		320	2	NSYPLAT10103	NSYPLAZT10103	
		420	2	NSYPLAT10104	NSYPLAZT10104	
1250		320	2	NSYPLAT10123	NSYPLAZT10123	
		420	2	NSYPLAT10124	NSYPLAZT10124	
1250	500	320	1	NSYPLAT1253	NSYPLAZT1253	
		420	1	NSYPLAT1254	NSYPLAZT1254	
	750	320	1	NSYPLAT1273	NSYPLAZT1273	
		420	1	NSYPLAT1274	NSYPLAZT1274	
	1000	320	2	NSYPLAT12103	NSYPLAZT12103	
		420	2	NSYPLAT12104	NSYPLAZT12104	
	1250	320	2	NSYPLAT12123	NSYPLAZT12123	
		420	2	NSYPLAT12124	NSYPLAZT12124	
	1500	500	320	1	NSYPLAT1553	NSYPLAZT1553
			420	1	NSYPLAT1554	NSYPLAZT1554
750		320	1	NSYPLAT1573	NSYPLAZT1573	
		420	1	NSYPLAT1574	NSYPLAZT1574	
1000		320	2	NSYPLAT15103	NSYPLAZT15103	
		420	2	NSYPLAT15104	NSYPLAZT15104	
1250		320	2	NSYPLAT15123	NSYPLAZT15123	
		420	2	NSYPLAT15124	NSYPLAZT15124	

**PHD - Applicative and customised solutions**

See the Polyester Heavy Duty offer in the Applicative and customised solutions, page 332.

# Polyester floor-standing enclosures

## Specific accessories overview

PB501394-SE-90



### Composition accessories

#### Coupling kits

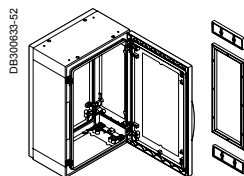

Page 218

#### Mounting



Page 219

#### Cable-entry



Page 219

#### Base accessories



Page 220

#### Door



Page 224

#### Locking system

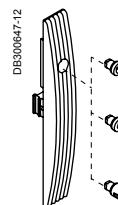

Page 225

#### Installation accessories



Page 226

#### Modular distribution accessories



Page 232

#### 19" chassis



Page 233

#### Anti-burglary accessory



Page 227



# Polyester floor-standing enclosures

## Common accessories overview

### Cable management

#### Cable management

PB502492-29



Page 270

#### Cable holding

PB500968-40



Page 270

#### Cable ducting

PB500898-22

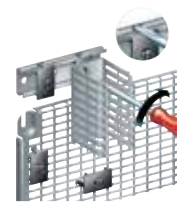

Page 289

### Thermal management

#### Heaters

PB502503-29



Page 452

#### Ventilation

PB501044-26



Page 406

#### Cooling units

PB502614-15



Page 435

### Thermal control

PB501162-19



Page 459

### Mounting accessories

#### Rails

PB500177



Page 250

### Composition accessories

#### VDI accessories and mountings

PB500189-17



Page 267

### Other accessories

#### Document pocket

PB502859-18



Page 297

# Polyester floor-standing enclosures

## Specific accessories

### Coupling kits

Characteristics	Horizontal coupling kits*			Vertical coupling kit
Ingress protection rating	IP55 at the coupling point			IP55 at the coupling point
<b>For enclosure</b>	<b>Coupling frame kit for enclosure</b>			
<b>Height (mm)</b>	<b>Depth 320 mm</b>	<b>Depth 420 mm</b>	<b>Depth 620 mm</b>	<b>NSYUVPLA</b>
500	<b>NSYMUPLA53</b>	<b>NSYMUPLA54</b>	-	
750	<b>NSYMUPLA73</b>	<b>NSYMUPLA74</b>	<b>NSYMUPLA76</b>	
1000	<b>NSYMUPLA103</b>	<b>NSYMUPLA104</b>	-	
1250	<b>NSYMUPLA123</b>	<b>NSYMUPLA124</b>	<b>NSYMUPLA126</b>	
1500	<b>NSYMUPLA153</b>	<b>NSYMUPLA154</b>	<b>NSYMUPLA156</b>	
<b>For enclosure</b>	<b>Trim kit for enclosure</b>			
	<b>Depth 320 mm</b>	<b>Depth 420 mm</b>		
Without canopy	<b>NSYSUPLA3</b>	<b>NSYSUPLA4</b>		
With canopy	<b>NSYSUPLA3T</b>	<b>NSYSUPLA4T</b>		

DE300633-60

Trim frames      Coupling frames

DE300634-27

\* Not valid for coupling 2 enclosures using ZZ or ZH type plinth.

### [!] Enhanced depth enclosure

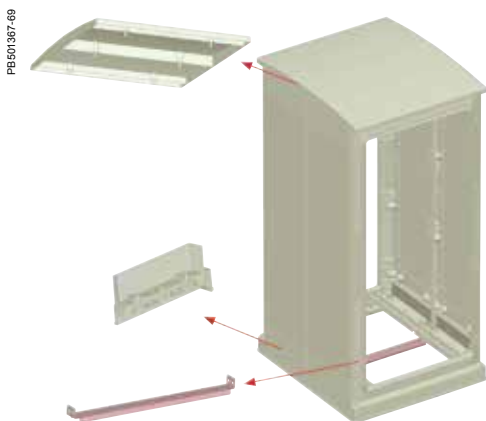

- After industrial machining, the frames of the standard enclosures are coupled in the factory to obtain enhanced depth floor-standing enclosures.
  - The internal volume of the standard enclosures remains unaffected.
  - Possible for the 4 enclosure versions, in particular for 19" applications with widths of 750 and 1250 mm.
  - IP44 in the version with ventilated canopy, IP54 for the other versions.
  - A rear door can be installed in the coupled enclosures.
- Option of installing 2 sets of step slides (at the front and at the rear).
- Supply or installation in the enclosures of a 19" chassis with side trim plate installed on the step slides:
    - 19 U, height 1000 mm,
    - 23 U, height 1250 mm,
    - 25 U, height 1500 mm.

# Polyester floor-standing enclosures

## Specific accessories

### Mounting, cable-entry and other accessories

**PLAZ PLAZT**



Characteristics		Canopy	Wall-mounting brackets	Cable-entry plate
		<ul style="list-style-type: none"> <li>It can be installed in all enclosure models.</li> <li>High resistance to impacts, temperature and bad weather.</li> <li>Increases the height (A) of the enclosure by 38 mm, without modifying its width or depth.</li> </ul>	Drilling positions and marks inside the side panels.	<ul style="list-style-type: none"> <li>Easy drilling in specific customised version.</li> <li>Incompatibility with: adapter plates, step slides, internal door and chassis for modular distribution.</li> </ul>
Material		Polyester reinforced with fibreglass	Passivated zinc-coated	Polyester reinforced with fibreglass
Colour		RAL 7032 grey*	-	RAL 7032 grey*
Thickness		-	-	40/10° mm
Ingress protection rating		-	-	IP00
Installation		Essential for outdoor use	-	-
Mounting		-	<ul style="list-style-type: none"> <li>Mounting on the sides by 4 or 6 lugs in horizontal position (6 lugs for enclosures with height <math>\geq 1000</math> mm)</li> <li>10 mm mounting distance on the rear of the enclosure plane</li> </ul>	-
Maximum load		-	180 kg	-
Supply		Delivered with the mountings required for installation	Set of 6 lugs and fixings	Delivered with the mountings required for installation
Width (mm)	Depth (mm) (C)	References		
500	320	<b>NSYTJPLA53</b>	<b>NSYFMPLA</b>	<b>NSYECPLAZ53</b>
750	320	<b>NSYTJPLA73</b>		<b>NSYECPLAZ73</b>
1000	320	<b>NSYTJPLA103</b>		<b>NSYECPLAZ103</b>
1250	320	<b>NSYTJPLA123</b>		<b>NSYECPLAZ123</b>
500	420	<b>NSYTJPLA54</b>		<b>NSYECPLAZ54</b>
750	420	<b>NSYTJPLA74</b>	<b>NSYECPLAZ74</b>	
1000	420	<b>NSYTJPLA104</b>	<b>NSYECPLAZ104</b>	
1250	420	<b>NSYTJPLA124</b>	<b>NSYECPLAZ124</b>	

(1) For enclosures with height  $\geq 1000$  mm, 1 extra lug at the centre of the A-375 side.  
\*RAL 7035 from 2016.

**PLAT PLAZT**



Characteristics	Grille for IP54 instead of IP44	Renovation and anti-graffiti paint	
	1 grille for 500 and 750 mm wide enclosures, 2 grilles for 1000 and 1250 mm wide enclosures. Prevents the entry of dust and provides the enclosure with IP 5X protection at the top. Maintains the possibility of ventilation.	2-component paint system, specially formulated for polyester enclosures. Renews enclosures and allows easy removal of graffiti. Paint composed of: base (80 %) and hardener (20 %).	
Colour	RAL 7032 grey*	RAL 7032 grey	
Installation	It is installed from the inside in the upper ventilation opening	-	
Supply	Delivered with G2 M1 standard synthetic filter, see ClimaSys section	1 kg: <input type="checkbox"/> 800 g tin of base paint <input type="checkbox"/> 200 g tin of hardener (Coverage = 5 m <sup>2</sup> )	5 kg: <input type="checkbox"/> 4 kg tin of base paint <input type="checkbox"/> 1 kg tin of hardener (Coverage = 25 m <sup>2</sup> )
References		<b>NSYAU50G1</b>	<b>NSYAU50G5</b>
		<b>NSYCAG125LPF</b>	<b>NSYAU50GS</b>

\*RAL 7035 from 2016.

# Polyester floor-standing enclosures

## Specific accessories

PLA PLAT

### Base accessories



#### Characteristics ZA plinths

Material	Polyester reinforced with fibreglass
Colour	RAL 7032 grey*
Ingress protection rating	IP44
Mechanical protection rating	IK10
Standards	IEC 61439-1
Mounting	Four floor-attachment points; the symmetry of the parts prevents incorrect assembly
Supply	The reference of the plinth contains all the accessories required for attaching the enclosure to the plinth and for stacking two plinths

For floor-standing enclosure				Plinth		Height 200 mm		Cable-gland area	
Height (mm)	Width (mm) (B)	Depth (mm) (C)	References	Width (mm)	Depth (mm)	References	Width (mm)	Depth (mm)	
500 to 1500	500	320	NSYPLA(T)•53	494	250	NSYZA253	360	205	
500 to 1500	750	320	NSYPLA(T)•73	744	250	NSYZA273	610	205	
500 to 1500	1000	320	NSYPLA(T)•103	994	250	NSYZA2103	860	205	
500 to 1500	1250	320	NSYPLA(T)•123	1244	250	NSYZA2123	1100	205	
500 to 1500	500	420	NSYPLA(T)•54	494	350	NSYZA254	360	305	
500 to 1500	750	420	NSYPLA(T)•74	744	350	NSYZA274	610	305	
500 to 1500	1000	420	NSYPLA(T)•104	994	350	NSYZA2104	860	305	
500 to 1500	1250	420	NSYPLA(T)•124	1244	350	NSYZA2124	1110	305	

#### Cable supporting cross-rail



■ **Description:** the lateral sides of the plinth are provided with bosses for attaching cross-rails with cut-out profiles, for supporting cables.  
 ■ **Supply:** the reference of the cross-rail includes all the elements required for assembly.

For plinth		Cross-rail
NSYZA253	NSYZA254	NSYAC320
NSYZA273	NSYZA274	NSYAC560
NSYZA2103	NSYZA2104	NSYAC840
NSYZA2123	NSYZA2124	NSYAC1080

#### Kit for IP54

**Description:** makes it possible to obtain IP 54 for the plinth and the plinth-enclosure connection.

**Reference**  
 NSYAEPZA

#### Feet for partially buried installation



■ **Description:** allows the partially buried installation of plinths before completion of the floor. The plinths are attached by four feet with a standard length of 750 mm. Possibility of horizontal adjustment of the plinth.  
 ■ **Supply:** the kit is made up of four feet and mountings.

**Reference**  
 NSYAEFBZ

\* RAL 7035 from 2016.

### Base accessories



#### N plinths

Designed to be installed under the closed-bottom enclosures (version PLA or PLAT).

Polyester reinforced with fibreglass  
RAL 7032 grey\*

Delivered with mountings required for installation

Height 60 mm

#### References

- NSYZNPLA53
- NSYZNPLA73
- NSYZNPLA103
- NSYZNPLA123
- NSYZNPLA54
- NSYZNPLA74
- NSYZNPLA104
- NSYZNPLA124

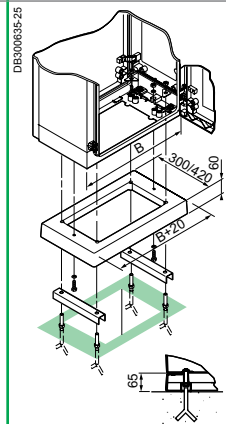

#### Connectors between plinths

- **Description:** designed to allow the adaptation of a closed-bottom enclosure + N plinth on a H-type partially buried plinth.
- **Supply:** 2 parts for adapting the centre-to-centre distances.

For floor-standing enclosure Depth (mm)	Description	References
320	Linking parts for N plinth on 320-mm H plinth	NSYAZ3PLA
420	Linking parts for N plinth on 420-mm H plinth	NSYAZ4PLA

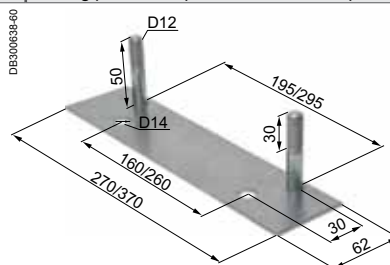
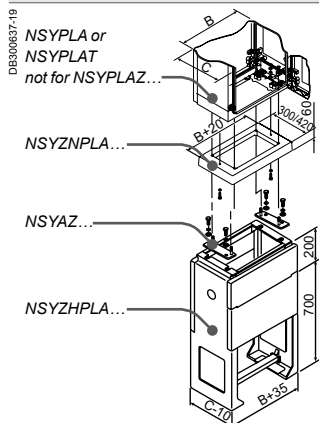

# Polyester floor-standing enclosures

## Specific accessories

PLAZ PLAZT

### Base accessories



#### Characteristics

#### ZZ plinths (1)

- The frontal parts (front and rear) are removed from the inside. Removing them makes it easier to install the cables.
- The 500-mm plinth can be partially buried.
- It is provided with one or two reinforcement cross-rails, adjustable to adapt to the position of the cables.

Material	Polyester reinforced with fibreglass
Colour	RAL 7032 grey (2)
Ingress protection rating	IP44
Mechanical protection rating	IK10
Standards	IEC 61439-1
Mounting	Four floor-attachment points; the symmetry of the parts prevents incorrect assembly
Supply	The reference of the plinth contains all the accessories required for attaching the enclosure to the plinth

For floor-standing enclosure				Plinth		Cable-gland area		Height 200 mm	Height 500 mm
Height (mm)	Width (mm) (B)	Depth (mm) (C)	References	Width (mm)	Depth (mm)	Width (mm)	Depth (mm)	References	References
500 to 1500	500	320	NSYPLAZ(T)•53	535	310	419	252	NSYZZ253	NSYZZ553
500 to 1500	750	320	NSYPLAZ(T)•73	785	310	669	252	NSYZZ273	NSYZZ573
500 to 1500	1000	320	NSYPLAZ(T)•103	1035	310	919	252	NSYZZ2103	NSYZZ5103
500 to 1500	1250	320	NSYPLAZ(T)•123	1285	310	1169	252	NSYZZ2123	NSYZZ5123
500 to 1500	500	420	NSYPLAZ(T)•54	535	410	419	352	NSYZZ254	NSYZZ554
500 to 1500	750	420	NSYPLAZ(T)•74	785	410	669	352	NSYZZ274	NSYZZ574
500 to 1500	1000	420	NSYPLAZ(T)•104	1035	410	919	352	NSYZZ2104	NSYZZ5104
500 to 1500	1250	420	NSYPLAZ(T)•124	1285	410	1169	352	NSYZZ2124	NSYZZ5124

#### Cable supporting cross-rail



- **Description:** the lateral sides of the plinths are provided with bosses for attaching cross-rails with cut-out profiles, for supporting cables.
- **Supply:** the reference of the cross-rail includes all the elements required for assembly.

For plinth				Cross-rail
NSYZZ253	NSYZZ254	NSYZZ553	NSYZZ554	NSYAC360
NSYZZ273	NSYZZ274	NSYZZ573	NSYZZ574	NSYAC600
NSYZZ2103	NSYZZ2104	NSYZZ5103	NSYZZ5104	NSYAC840
NSYZZ2123	NSYZZ2124	NSYZZ5123	NSYZZ5124	NSYAC1120

#### Outside opening kit

**Description:** the 200-mm front part of the 200- and 500-mm plinths can be opened from the outside, after installing a kit made up of two locks with double-bar insert.

#### Reference

NSYAE LZ

#### Feet for partially buried installation



- **Description:** allows the partially buried installation of plinths before completion of the floor. The plinths are attached by four feet with a standard length of 750 mm. Possibility of horizontal adjustment of the plinth.
- **Supply:** the reference includes a kit made up of four feet and mountings.

#### Reference

NSYAE BFZ

(1) The coupling kit NSYMUPLA... is not valid for enclosures using ZZ or ZH type plinths.  
 (2) RAL 7035 from 2016.

# Polyester floor-standing enclosures

## Specific accessories

### Base accessories

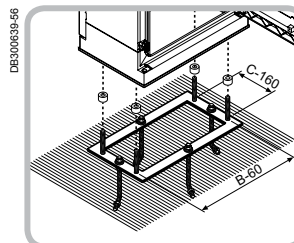

Buriable H plinths (3)	Floor-standing frame
<ul style="list-style-type: none"> <li>■ Front panel with a height of 170 mm, retractable, providing easy access to the inside.</li> <li>■ Fixed front panel with a height of 305 mm, corresponding to the finished floor height area.</li> <li>■ The height above the floor after building-in varies between 200 and 500 mm.</li> <li>■ A metal rail helps to fix the entry cables.</li> <li>■ Lateral uprights with pre-knock-out auxiliary output with Ø Pg 36 (48 mm).</li> <li>■ A pre-knock-out area is provided at the bottom of the lateral uprights for cable entry, if necessary.</li> </ul>	<p>Frame for direct mounting on the floor for installing open-bottom enclosures (version PLAZ or PLAZT).</p>
Polyester reinforced with fibreglass	Passivated zinc-coated steel
RAL 7032 grey (2)	-
-	-
-	-
-	-
Delivered with the mountings required for installation	Delivered with mountings required for installation
<b>Height 900 mm</b>	
<b>References</b>	<b>References</b>
NSYZHPLA53	NSYMFPLAZ53
NSYZHPLA73	NSYMFPLAZ73
NSYZHPLA103	NSYMFPLAZ103
NSYZHPLA123	NSYMFPLAZ123
NSYZHPLA54	NSYMFPLAZ54
NSYZHPLA74	NSYMFPLAZ74
NSYZHPLA104	NSYMFPLAZ104
NSYZHPLA124	NSYMFPLAZ124
	<p><b>Floor-mounting studs</b></p> <ul style="list-style-type: none"> <li>■ <b>Description:</b> set of four threaded parts and mountings, for mounting the enclosures on concrete plinths.</li> </ul> <p><b>Reference</b></p> <p>NSYFSPLAZ</p>

(3) Not valid for coupling 2 enclosures using ZZ or ZH type plinth.

# Polyester floor-standing enclosures

## Specific accessories

### Door

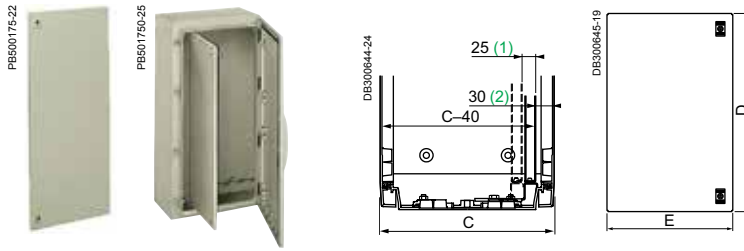

Characteristics		Internal door			
		<ul style="list-style-type: none"> <li>■ Designed for direct installation in enclosures with sealed bottom part. In the enclosures with the bottom part open, installation can be performed by ordering the necessary adapter plates, ref. <b>NSYPTZ●●●</b>.</li> <li>■ 2 depthwise mounting positions (1) according to the chosen M8 impressions, on the top and bottom parts of the enclosure, for mounting.</li> <li>■ Lock with 5-mm double-bar inserts.</li> <li>■ Incompatibility with: modular distribution chassis, 19" chassis, cable-entry plate and door retainer, ref. <b>NSYRETPLAU</b>.</li> </ul>			
Material	Aluminium				
Colour	RAL 7032 grey*				
Supply	Delivered with M8 brass inserts and mountings				
For enclosure (mm)	Internal door dimensions		Weight (kg)		References
Height	Width	D	E		
500	500	398	398	1.6	<b>NSYPAPLA55</b>
	750	398	648	2.2	<b>NSYPAPLA57</b>
	1000	398	796 (2 x 398)	3.2 (2 x 1.6)	2 x <b>NSYPAPLA55</b>
	1250	398	1046 (398 + 648)	3.8 (1.6 + 2.2)	<b>NSYPAPLA55</b> + <b>NSYPAPLA57</b>
750	500	648	398	2.2	<b>NSYPAPLA75</b>
	750	648	648	3.1	<b>NSYPAPLA77</b>
	1000	648	796 (2 x 398)	4.4 (2 x 2.2)	2 x <b>NSYPAPLA75</b>
	1250	648	1046 (398 + 648)	5.3 (2.2 + 3.1)	<b>NSYPAPLA75</b> + <b>NSYPAPLA77</b>
1000	500	898	398	2.8	<b>NSYPAPLA105</b>
	750	898	648	4.1	<b>NSYPAPLA107</b>
	1000	898	796 (2 x 398)	5.4 (2 x 2.8)	2 x <b>NSYPAPLA105</b>
	1250	898	1046 (398 + 648)	6.9 (2.8 + 4.1)	<b>NSYPAPLA105</b> + <b>NSYPAPLA107</b>
1250	500	1148	398	3.4	<b>NSYPAPLA125</b>
	750	1148	648	5	<b>NSYPAPLA127</b>
	1000	1148	796 (2 x 398)	6.8 (2 x 3.4)	2 x <b>NSYPAPLA125</b>
	1250	1148	1046 (398 + 648)	8.4 (3.4 + 5)	<b>NSYPAPLA125</b> + <b>NSYPAPLA127</b>
1500	500	1398	398	4	<b>NSYPAPLA155</b>
	750	1398	648	6	<b>NSYPAPLA157</b>
	1000	1398	796 (2 x 398)	8 (2 x 4)	2 x <b>NSYPAPLA155</b>
	1250	1398	1046 (398 + 648)	10 (4 + 6)	<b>NSYPAPLA155</b> + <b>NSYPAPLA157</b>

(1) Two positions for depthwise installation.  
 (2) The 2<sup>nd</sup> position moves the position of the internal door back by 25 mm.  
 \* RAL 7035 from 2016.

### Door accessories

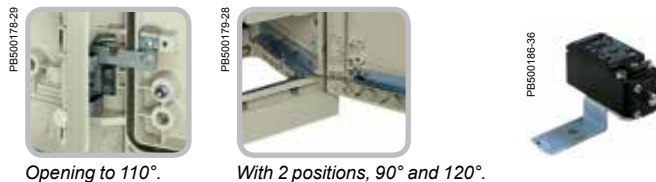

Opening to 110°.

With 2 positions, 90° and 120°.

Characteristics	Door retainer	Door switch
	<ul style="list-style-type: none"> <li>■ Designed to adapt directly to the enclosure.</li> <li>■ Can be installed on a door opening to the left or right indistinctly.</li> </ul>	<ul style="list-style-type: none"> <li>NC + NO switch.</li> <li>Incompatible with the rear door and modular distribution chassis.</li> </ul>
Material	Galvanised steel	-
Supply	Delivered with the mountings required for installation	Switch, mounting bracket and mountings
	<b>PLA, PLAZ, PLAT versions</b>   <b>For all versions*</b> <b>NSYRETPLA</b>   <b>NSYRETPLAU</b>	<b>Reference</b> <b>NSYSNLPLA</b>
	<p>* Note: ref. <b>NSYRETPLAU</b> is incompatible with internal doors, modular distribution chassis, step slides, adapter plates and cable-entry plates.                      In the event of incompatibility, use ref. <b>NSYRETPLAZ</b>.</p>	



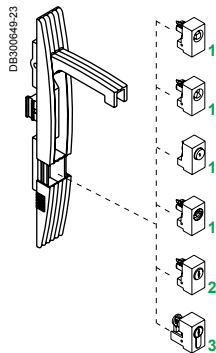

### Locking system



- 1 Block with form insert.
- 2 Block with cylindrical barrel.
- 3 Block with semi-cylindrical barrel.

Characteristics	Lock with handle
	Ergonomic locking system with pivoting handle installed as standard on enclosures with ventilated canopy and/or open bottom part, with a 5 mm double-bar insert block. ■ Fire resistance: 650°C.
Material	PA6 charged with 30 % fibreglass
Colour	RAL 7032 grey*
Mechanical protection rating	IK10

### Options

Options for changing the form-insert blocks (supplied with the required operating key)	References	Options for changing the handle lock	References
Block, 6 mm square insert	<b>NSYINS61</b>	 <p>Changing the handle for a handle including a padlocking device (Ø 10 mm) allowing the handle to be locked. The handle is delivered without barrel or insert block.</p>	<b>NSYBCMPLA</b>
Block, 7 mm square insert	<b>NSYINS71</b>		
Block, 8 mm square insert	<b>NSYINS81</b>		
Block, 6.5 mm triangular insert	<b>NSYINT61</b>		
Block, 8 mm triangular insert	<b>NSYINT81</b>		
Push-button	<b>NSYTSPLA</b>		
Double bar	<b>NSYINDB51</b>	 <p>Options for changing the handle lock for a lock with an escutcheon and without handle, delivered without insert. The insert is to be chosen from the option table on the "Locks with escutcheon and without handle" column.</p>	<b>NSYEBPLA</b>
<b>Options for changing the blocks with cylindrical barrels</b>			
<b>Type of key</b>	<b>References</b>	<b>Type of key</b>	<b>References</b>
405 E key	<b>NSYIN405E1</b>	3113 A key	<b>NSYIN3113A1</b>
421 E key	<b>NSYIN421E1</b>	3122 E key	<b>NSYIN3122E1</b>
455 key	<b>NSYIN4551</b>	3123 A key	<b>NSYIN3123A1</b>
1242 E key	<b>NSYIN1242E1</b>	3131A1 key	<b>NSYIN3131A1**</b>
1332 E key	<b>NSYIN1332E1</b>	3133 A key	<b>NSYIN3133A1</b>
2131 A key	<b>NSYIN2131A1</b>	3422 E key	<b>NSYIN3422E1</b>
2132 A key	<b>NSYIN2132A1</b>	3432 E key	<b>NSYIN3432E1</b>
2331 A key	<b>NSYIN2331A1</b>	6101 key	<b>NSYIN6101**</b>
2433 A key	<b>NSYIN2433A1</b>	EDF 1300 key	<b>NSYINF1301</b>
2452 E key	<b>NSYIN2452E1</b>	EDF 1400 key	<b>NSYINF1401</b>
** <span style="color: red;">New</span>			
<b>Options for changing the blocks with semi-cylindrical barrels</b>		<b>Padlocking device</b>	
<b>References</b>		<b>Reference</b>	
1242 E key		<b>NSYIN1242E2</b>	
DIN adapter		<b>NSYINDIN2</b>	
JIS key		<b>NSYINKJIS2</b>	
Reinforced key		<b>NSYINKR2</b>	
FAC key		<b>NSYINKFAC2</b>	
		 <p>Padlocking accessory, preventing access to the lock-control insert. Opening diameter: 14 mm.</p>	
		<b>NSYBCPLA</b>	

\* RAL 7035 from 2016.

# Polyester floor-standing enclosures

## Specific accessories

### Installation accessories



Characteristics	Metallic mounting plate				Insulating mounting plate					
	Plain mounting plate		Telequick mounting plate		Bakelite		Polyester			
	<p><b>Plain mounting plate</b></p> <ul style="list-style-type: none"> <li>Direct installation on M8 inserts at the rear of the enclosure or on step slides for depth adjustment (see page 230). The enclosures with height of <math>\geq 1000</math> mm have intermediate impressions for installing mounting plates of a lesser height (M8 inserts, ref. <b>NSYTEX8</b>, to be ordered separately).</li> <li>In the 2-door enclosures, it is possible to install 1 complete mounting plate or 2 individual mounting plates.</li> </ul>		<p><b>Telequick mounting plate</b></p> <ul style="list-style-type: none"> <li>Grille with 11 x 26 mm drill holes, with a step of 15 x 30 mm, for direct installation, with clip nuts, of all the devices with mounting at 2, 3 or 4 points, by screws with diameters of 3, 4, 5 or 6 mm.</li> <li>Direct installation on M8 inserts at the rear of the enclosure or on step slides for depth adjustment (see page 230). The enclosures with height of <math>\geq 1000</math> mm have intermediate impressions for installing mounting plates of a lesser height (M8 inserts, ref. <b>NSYTEX8</b>, to be ordered separately).</li> </ul>		<p><b>Insulating mounting plate</b></p> <ul style="list-style-type: none"> <li>Direct installation on M8 inserts at the rear of the enclosure or on step slides for depth adjustment (see page 230). The enclosures with height of <math>\geq 1000</math> mm have intermediate impressions for installing mounting plates of a lesser height (M8 inserts, ref. <b>NSYTEX8</b>, to be ordered separately).</li> <li>In the 2-door enclosures, it is possible to install 1 complete mounting plate or 2 individual mounting plates.</li> </ul>					
Material	Galvanised sheet-steel		Galvanised sheet-steel		Bakelite		Polyester			
Finish	-		-		-		-			
Colour	-		-		-		-			
Thickness	25/10 <sup>e</sup> mm		-		40/10 <sup>e</sup> mm		<ul style="list-style-type: none"> <li>40/10<sup>e</sup> mm up to 700 mm height</li> <li>50/10<sup>e</sup> mm from 800 mm height</li> </ul>			
Maximum load	150 kg/m <sup>2</sup>		150 kg/m <sup>2</sup>		100 kg/m <sup>2</sup>					
Supply	-		-		1 mounting plate					
<b>For enclosure (mm)</b>	<b>Dimensions</b>				<b>References</b>					
<b>Height (A)</b>	<b>Width (B)</b>	<b>H (mm)</b>	<b>Surface (dm<sup>2</sup>)</b>	<b>References</b>	<b>E (mm)</b>	<b>D (mm)</b>	<b>Surface (dm<sup>2</sup>)</b>	<b>References</b>		
500	500	-	14	<b>NSYPMM55</b>	350	350	13	<b>NSYPMR55</b>	<b>NSYPMB55</b>	<b>NSYPMA55</b>
	750	-	24	<b>NSYPMM75</b>	350	600	23	<b>NSYPMR57</b>	<b>NSYPMB75</b>	<b>NSYPMA75</b>
	1000	437.5	32	<b>NSYPMM510</b>	350	2 x 350	26	2 x <b>NSYPMR55</b>	<b>NSYPMB510</b>	<b>NSYPMA510</b>
	1250	-	38	<b>NSYPMM55 + NSYPMM75</b>	350	350 + 600	36	<b>NSYPMR55 + NSYPMR57</b>	<b>NSYPMB55 + NSYPMB75</b>	<b>NSYPMA55 + NSYPMA75</b>
750	500	-	24	<b>NSYPMM75</b>	600	350	23	<b>NSYPMR75</b>	<b>NSYPMB75</b>	<b>NSYPMA75</b>
	750	-	40	<b>NSYPMM77</b>	600	600	38	<b>NSYPMR77</b>	<b>NSYPMB77</b>	<b>NSYPMA77</b>
	1000	437.5	54	<b>NSYPMM710</b>	600	2 x 350	46	2 x <b>NSYPMR75</b>	<b>NSYPMB710</b>	<b>NSYPMA710</b>
	1250	687.5	70	<b>NSYPMM712</b>	600	350 + 600	61	<b>NSYPMR75 + NSYPMR77</b>	<b>NSYPMB712</b>	<b>NSYPMA712</b>
1000	500	-	33	<b>NSYPMM105</b>	850	350	32	<b>NSYPMR105</b>	<b>NSYPMB105</b>	<b>NSYPMA105</b>
	750	-	55	<b>NSYPMM107</b>	850	600	54	<b>NSYPMR107</b>	<b>NSYPMB107</b>	<b>NSYPMA107</b>
	1000	437.5	74	<b>NSYPMM1010</b>	850	2 x 350	64	2 x <b>NSYPMR105</b>	<b>NSYPMB1010</b>	<b>NSYPMA1010</b>
	1250	687.5	96	<b>NSYPMM1012</b>	850	350 + 600	86	<b>NSYPMR105 + NSYPMR107</b>	<b>NSYPMB1012</b>	<b>NSYPMA1012</b>
1250	500	-	42	<b>NSYPMM125</b>	1100	350	42	<b>NSYPMR125</b>	<b>NSYPMB125</b>	<b>NSYPMA125</b>
	750	-	70	<b>NSYPMM127</b>	1100	600	70	<b>NSYPMR127</b>	<b>NSYPMB127</b>	<b>NSYPMA127</b>
	1000	437.5	96	<b>NSYPMM1210</b>	1100	2 x 350	84	2 x <b>NSYPMR125</b>	<b>NSYPMB1210</b>	<b>NSYPMA1210</b>
	1250	687.5	124	<b>NSYPMM1212</b>	1100	350 + 600	112	<b>NSYPMR125 + NSYPMR127</b>	<b>NSYPMB1212</b>	<b>NSYPMA1212</b>
1500	500	-	51	<b>NSYPMM155</b>	1350	350	51	<b>NSYPMR155</b>	<b>NSYPMB155</b>	-
	750	-	85	<b>NSYPMM157</b>	1350	600	85	<b>NSYPMR157</b>	<b>NSYPMB157</b>	-
	1000	437.5	118	<b>NSYPMM1510</b>	1350	2 x 350	102	2 x <b>NSYPMR155</b>	<b>NSYPMB1510</b>	-
	1250	687.5	152	<b>NSYPMM1512</b>	1350	350 + 600	136	<b>NSYPMR155 + NSYPMR157</b>	<b>NSYPMB1512</b>	-

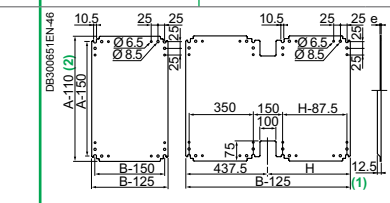
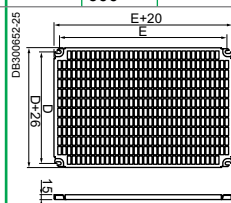
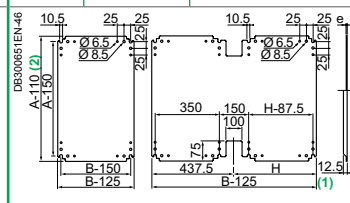

(1) Reinforcing fold for steel mounting plate **NSYPMM1010** to **NSYPMM1512**.  
 (2) A-125 for references **NSYPMM1010** to **NSYPMM1512**, A-120 for the polyester mounting plate, ref. **NSYPMA●●●**.

# Polyester floor-standing enclosures

## Specific accessories

### Installation accessories

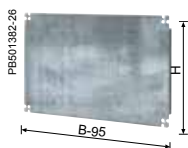

Side mounting plates			Partial plain mounting plate		Technical uprights		Anti-burglary accessory	
Polyester mounting plates fixed to the sides of the enclosure for additional installations. Installation on the M8 bosses by adding inserts, ref. <b>NSYTEX8</b> .			Direct mounting on the uprights, with the notched sliding nuts or pivoting nuts, see common accessories section.		<ul style="list-style-type: none"> <li>Supports for mounting rails, perforated grilles and plain partial mounting plates.</li> <li>Details in the common accessory section.</li> <li>Mounting at the rear on the M8 inserts or on the step slides.</li> </ul>		Anti-burglary accessory for polyester outdoor Heavy Duty in accordance with ENV 1627-1630:2011 class 2. It keeps the Insulation Class II according to IEC 61439-1:2011.	
Polyester			Galvanised sheet-steel		Zinc-coated steel		Steel with anti-corrosive coating	
-			-		-		Structured finish, 100 % polyester powder	
-			-		-		RAL 7035 grey	
<ul style="list-style-type: none"> <li>40/10° mm up to 750 mm height</li> <li>50/10° mm from 800 mm height</li> </ul>			25/10° mm		20/10° mm		-	
100 kg/m <sup>2</sup>			150 kg/m <sup>2</sup>		-		-	
Reference by unit. Order by multiples of 2			1 mounting plate		2 technical uprights		1	
References			References		Dimensions		References	
Enclosure depth			247 mm height		(mm)	References	Depth 420 mm	
320 mm	420 mm	620 mm	397 mm height				Depth 620 mm	
NSYPMLA53	NSYPMLA54	-	-	-	-	-	-	-
NSYPMLA53	NSYPMLA54	-	NSYSPMP2575	-			-	-
NSYPMLA53	NSYPMLA54	-	NSYSPMP25100	NSYSPMP40100			-	-
NSYPMLA53	NSYPMLA54	-	-	-			-	-
NSYPMLA73	NSYPMLA74	NSYPMLA76	-	-	625	NSYTVR7	-	-
NSYPMLA73	NSYPMLA74	-	NSYSPMP2575	-			NSYBGN774HD	NSYBGN776HD
NSYPMLA73	NSYPMLA74	-	NSYSPMP25100	NSYSPMP40100			-	-
NSYPMLA73	NSYPMLA74	-	-	-			-	-
NSYPMLA103	NSYPMLA104	-	-	-	875	NSYTVR10	NSYBGN1054HD	-
NSYPMLA103	NSYPMLA104	-	NSYSPMP2575	-			NSYBGN1074HD	-
NSYPMLA103	NSYPMLA104	-	NSYSPMP25100	NSYSPMP40100			-	-
NSYPMLA103	NSYPMLA104	-	-	-			-	-
NSYPMLA123	NSYPMLA124	NSYPMLA126	-	-	1125	NSYTVR125	NSYBGN1254HD	-
NSYPMLA123	NSYPMLA124	-	NSYSPMP2575	-			NSYBGN1274HD	NSYBGN1276HD
NSYPMLA123	NSYPMLA124	-	NSYSPMP25100	NSYSPMP40100			-	-
NSYPMLA123	NSYPMLA124	-	-	-			NSYBGN12124HD	NSYBGN12126HD
NSYPMLA153	NSYPMLA154	NSYPMLA156	-	-	1375	NSYTVR15	-	-
NSYPMLA153	NSYPMLA154	-	NSYSPMP2575	-			NSYBGN1574HD	NSYBGN1576HD
NSYPMLA153	NSYPMLA154	-	NSYSPMP25100	NSYSPMP40100			-	-
NSYPMLA153	NSYPMLA154	-	-	-			NSYBGN15124HD	NSYBGN15126HD
					<i>Note: enclosures with widths of 1000 and 1250 allow the installation of 4 uprights to integrate 2 mounting plates of 500 mm or of 500 and 750 mm.</i>			

Note: the diagrams above relate to the metal mounting plates. The mounting plates made from insulating material only have 4 or 8 main mounting points and the external dimensions of the diagrams.

# Polyester floor-standing enclosures

## Specific accessories

### Installation accessories



Characteristics		Modular distribution chassis*						
		<ul style="list-style-type: none"> <li>■ Chassis for modular switchgear, installed directly in the sealed enclosures (PLA version). For installation in enclosures with open bottom part (PLAZ version) it is necessary to use a set of adapter plates (ref. <b>NSYPTZ●●●</b>).</li> <li>■ Chassis made up of cover plates on a rigid structure.</li> <li>■ Quick installation without mountings.</li> <li>■ Distance between rail and front panel with adjustable depth from 40 to 85 mm.</li> <li>■ System for identifying electrical circuits supplied.</li> <li>■ Neutral/earth strip: 2 x 16 mm<sup>2</sup> + 5 x 6 mm<sup>2</sup> included in the standard offer.</li> <li>■ Incompatibility with: cable-entry plate, internal door, door switch and door retainer (ref. <b>NSYREPLAU</b>).</li> </ul>						
Material		<ul style="list-style-type: none"> <li>■ Rigid structure: galvanised-steel</li> <li>■ Cover plates: self-extinguishing insulating</li> </ul>						
Colour		Cover plates: RAL 7032 grey**						
Thickness		-						
Installation		-						
Maximum load		-						
For enclosure (mm)		No. of doors	No. of rows	Rows for module		No. of plates	References	
Height (A)	Width (B)			No.	No. of 18-mm modules			
750	500	1	4	4	76	-	NSYDLP76	
		1	4	3	57	1	NSYDLP57	
	750	1	4	4	132	-	NSYDLP132	
		1	4	3	99	1	NSYDLP99	
		1000	2	4 + 4	4 + 4	152	-	2 x NSYDLP76
			2	4 + 4	3 + 3	114	1 + 1	2 x NSYDLP57
1250	2	4 + 4	4 + 4	208	-	NSYDLP76 + NSYDLP132		
	2	4 + 4	3 + 3	156	1 + 1	NSYDLP57 + NSYDLP99		
1000	500	1	6	6	114	-	NSYDLP114	
		1	6	5	95	1	NSYDLP95	
	750	1	6	6	198	-	NSYDLP198	
		1	6	5	165	1	NSYDLP165	
	1000	2	6 + 6	6 + 6	228	-	2 x NSYDLP114	
		2	6 + 6	5 + 5	190	1 + 1	2 x NSYDLP95	
		1250	2	6 + 6	6 + 6	312	-	NSYDLP114 + NSYDLP198
			2	6 + 6	5 + 5	260	1 + 1	NSYDLP95 + NSYDLP165
	1250	500	1	7	7	133	-	NSYDLP133
			1	7	6	114	1	NSYDLP114P
		750	1	7	7	231	-	NSYDLP231
			1	7	6	198	1	NSYDLP198P
1000		2	7 + 7	7 + 7	266	-	2 x NSYDLP133	
		2	7 + 7	6 + 6	228	1 + 1	2 x NSYDLP114P	
		1250	2	7 + 7	7 + 7	364	-	NSYDLP133 + NSYDLP231
			2	7 + 7	6 + 6	312	1 + 1	NSYDLP114P + NSYDLP198P
1500		500	1	9	9	171	-	NSYDLP171
			1	9	8	152	1	NSYDLP152
	750	1	9	9	297	-	NSYDLP297	
		1	9	8	264	1	NSYDLP264	
	1000	2	9 + 9	9 + 9	342	-	2 x NSYDLP171	
		2	9 + 9	8 + 8	304	-	2 x NSYDLP152	
		1250	2	9 + 9	9 + 9	468	1 + 1	NSYDLP171 + NSYDLP297
			2	9 + 9	8 + 8	416	1 + 1	NSYDLP152 + NSYDLP264

\* Other modular distribution accessories on page 232.

\*\* RAL 7035 from 2016.

# Polyester floor-standing enclosures

## Specific accessories

### Installation accessories

#### Dimensions

#### Modular distribution chassis

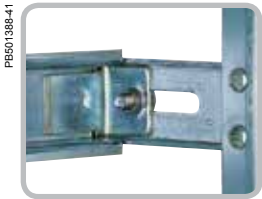

Details of the depth adjustment.



Detail from front-panel mounting.



Detail from the circuit-marking system.

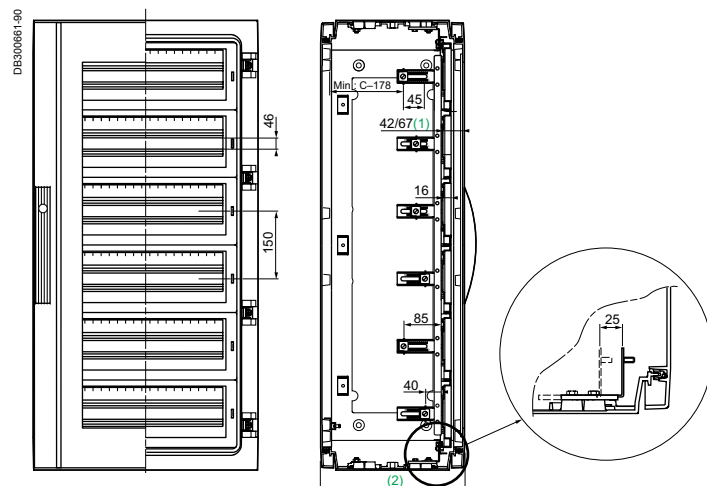
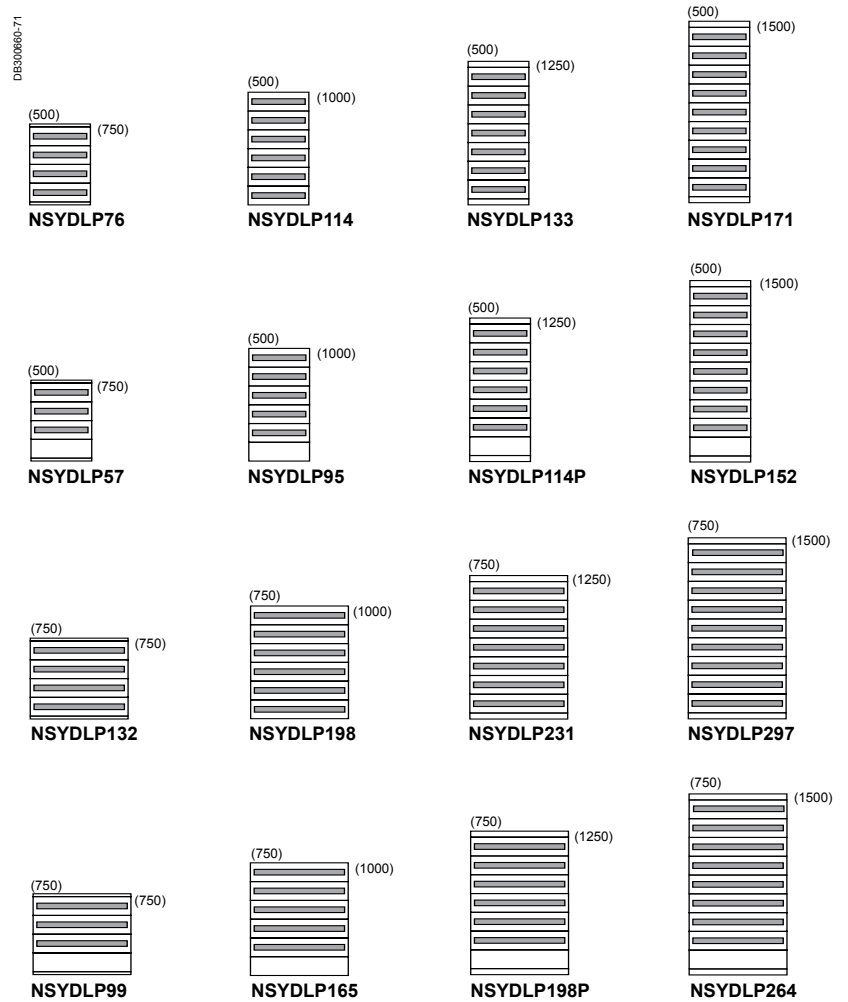

(1) Dimensions of 42 or 67 mm or a pitch of 25 mm, according to the M8 boss chosen for the installation. See details in the enlarged image on the right. In the enclosures with glazed doors, the 2 dimensions are reduced by 5 mm.  
 (2) C = Depth of the enclosure.

# Polyester floor-standing enclosures

## Specific accessories

### Installation accessories



Characteristics		Step slides	Adapter plates
		<ul style="list-style-type: none"> <li>■ Set of 4 step slides with brackets allowing continuous depth adjustment of the mounting plate, with a pitch of 25 mm.</li> <li>■ Designed for direct installation in the enclosures with sealed bottom part (versions PLA or PLAT).</li> <li>■ In the enclosures with open bottom part (versions PLAZ or PLAZT), installation is made possible by adding the relevant adapter plates.</li> <li>■ Incompatibility with: internal door, modular distribution chassis, 19" chassis, cableentry plate and door retainer, ref. <b>NSYRETPLAU</b>.</li> </ul>	<ul style="list-style-type: none"> <li>■ The enclosures with open bottom part (versions PLAZ and PLAZT) require a set of adapter plates for mounting:                             <ul style="list-style-type: none"> <li><input type="checkbox"/> an internal door,</li> <li><input type="checkbox"/> step slides,</li> <li><input type="checkbox"/> modular chassis and 19" chassis.</li> </ul> </li> </ul>
Material		Bracket with steel M8 stud on aluminium rail	Galvanised steel
Mounting		Mounting on the top and bottom parts of the enclosure by means of M8 inserts and screws (supplied)	Mounting on the bottom part of the enclosure by means of M8 inserts and screws (supplied)
For enclosure (mm)		References	
Depth	No. of doors		
320	1	<b>NSYDPLA3</b>	<b>NSYPTZ3</b>
	2	<b>2 x NSYDPLA3</b>	<b>NSYPTZ32P</b>
420	1	<b>NSYDPLA4</b>	<b>NSYPTZ4</b>
	2	<b>2 x NSYDPLA4</b>	<b>NSYPTZ42P</b>
620	1	<b>NSYDPLA6</b>	<b>NSYPTZ6</b>
	2	<b>2 x NSYDPLA6</b>	<b>NSYPTZ62P</b>

Installation of step slide ref. **NSYDPLA●●●**

Installation of step slide ref. **NSYDPLA●●●**, with adapter plate ref. **NSYPTZ●●●**

**Additional support**

Set of 4 additional brackets, to be slid into the step slides, for the installation of an additional mounting plate.

Reference **NSYEDPLA**

(1) 57 mm with one transparent door.

# Polyester floor-standing enclosures

## Specific accessories

### Installation accessories

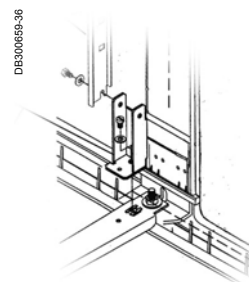
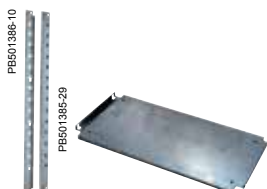

Characteristics		Support plate		M8 inserts	Intermediate support in the 2-door enclosures
		<ul style="list-style-type: none"> <li>Designed to support assorted equipment or simply to install a separation.</li> <li>In the 2-door enclosures, the installation of the plate or the uprights requires the prior installation of an intermediate support, ref. <b>NSYSBPLA</b>, presented beside.</li> </ul>		To be placed in the bosses moulded on the doors, uprights, rear panels and bottom and top parts, for mounting accessories and assorted devices.	Required accessory for installing support plates, ref. <b>NSYBANPLA●●●</b> or uprights, ref. <b>NSYSPLA●●●</b> in the 2-door enclosures.
Material		Galvanised steel		-	-
Installation		<ul style="list-style-type: none"> <li>It is installed directly on the bottom part of the enclosure</li> <li>For the installation of one or several support plates, use 2 sets of 2 uprights suitable for the height (to be ordered separately). These uprights offer the option of adjusting the height with a step of 50 mm</li> </ul>		-	-
Supply		Delivered with the mountings required for installation		References by unit. Order by multiples of 8 units (8, 16, 24, etc.)	-
For enclosure (mm)		Upright		Reference	Reference
Height	Depth	No. of adjustments	References	NSYTEX8	NSYSBPLA
750	320 420	2	2 x <b>NSYSPLA75</b>		
1000	320 420	3	2 x <b>NSYSPLA100</b>		
1250	320 420	4	2 x <b>NSYSPLA125</b>		
1500	-	5	2 x <b>NSYSPLA150</b>		
For enclosure (mm)		Plate			
Depth (C)	Width (B)	Max. load	References		
320	500	60 kg	<b>NSYBANPLA53</b>		
	750	60 kg	<b>NSYBANPLA73</b>		
420	500	50 kg	<b>NSYBANPLA54</b>		
	750	50 kg	<b>NSYBANPLA74</b>		
620	500	50 kg	<b>NSYBANPLA56</b>		
	750	50 kg	<b>NSYBANPLA76</b>		

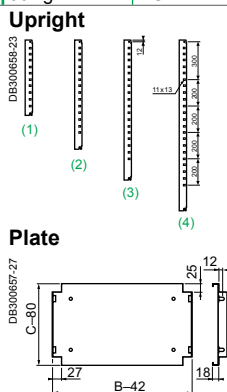

(1) NSYSPLA75 ; (2) NSYSPLA100 ; (3) NSYSPLA125 ; (4) NSYSPLA150.

# Polyester floor-standing enclosures

## Specific accessories

### Modular distribution accessories



Characteristics			Plain cover plate	Plain mounting plate
			Plain cover plate for non-modular switchgear protection.	<ul style="list-style-type: none"> <li>■ Plate for mounting non-modular devices.</li> <li>■ Depth-adjustable mounting on the supports from 40 to 85 mm.</li> <li>■ Nominal height: 150 mm or 300 mm.</li> </ul>
Material			Self-extinguishing insulating	Galvanised steel
Colour			RAL 7032 grey*	-
Thickness			-	20/10° mm
Supply			Order by multiples of 2 (2, 4, 6...)	Order by multiples of 2 (2, 4, 6...)
For enclosure (mm)	Dimensions (mm)		References	
Width	Height	Width		
500	146	402	<b>NSYCTL500DLP</b>	-
	149	361	-	<b>NSYPMP500DLP</b>
	298	361	-	<b>NSYPMP5002DLP</b>
750	146	652	<b>NSYCTL750DLP</b>	-
	149	611	-	<b>NSYPMP750DLP</b>
	298	611	-	<b>NSYPMP7502DLP</b>

\* RAL 7035 from 2016.



# Polyester floor-standing enclosures

## Specific accessories

### 19" chassis



Enclosure with 19" fixed chassis.



Enclosure with 19" swing chassis.

Characteristics	19" fixed chassis	19" swing chassis					
	<ul style="list-style-type: none"> <li>Very sturdy 19" metal chassis, designed for installation in enclosures with a width of 750 and 1250 mm. In the 1250 mm enclosure, the chassis is installed in the 750 mm part with an intermediate support, ref. <b>NSYSBPLA</b>.</li> <li>These chassis can be used as partial mounting plates in enclosures with higher than nominal height.</li> <li>Incompatible with the internal doors and the step slides.</li> <li>Fixed chassis made up of 2 uprights with mountings.</li> </ul>	<ul style="list-style-type: none"> <li>Swing chassis opening to 120° with 5 mm double-bar key lock.</li> </ul>					
Material	Sheet steel	Sheet steel					
Finish	Epoxy-polyester paint	Epoxy-polyester paint					
Colour	RAL 7032 grey*	RAL 7032 grey*					
Installation	For heights from 750 to 1500 mm, the installation requires ordering 1 batch of 2 matching uprights. If a chassis is installed in an enclosure with a greater height, it is necessary to use the suitable uprights for the size of the enclosure	For heights from 750 to 1500 mm, the installation requires ordering 1 batch of 2 matching uprights. If a chassis is installed in an enclosure with a greater height, it is necessary to use the suitable uprights for the size of the enclosure					
Maximum load	3 kg per U	3 kg per U					
<b>For enclosure (mm)</b>	<b>Number of U</b>	<b>References</b>	<b>Number of U</b>	<b>References</b>			
<b>Height</b>	<b>Width</b>	<b>19" fixed chassis</b>	<b>Batch of 2 uprights</b>	<b>19" swing chassis</b>	<b>Batch of 2 uprights</b>		
500	750	8	NSYBRF8PLA	-	-		
750	750	12	NSYBRF12PLA	NSYSPLA75	NSYBRP11PLA	NSYSPLA75	
1000	750	17	NSYBRF17PLA	NSYSPLA100	NSYBRP16PLA	NSYSPLA100	
1250	750	21	NSYBRF21PLA	NSYSPLA125	NSYBRP20PLA	NSYSPLA125	
1500	750	26	NSYBRF26PLA	NSYSPLA150	NSYBRP25PLA	NSYSPLA150	
2000	750	35	NSYBRF35PLA	2 x NSYSPLA100	2 x 16	2 x NSYBRP16PLA	2 x NSYSPLA100

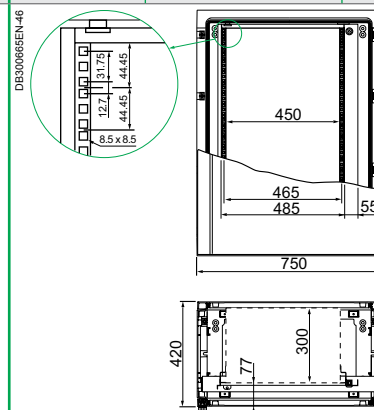
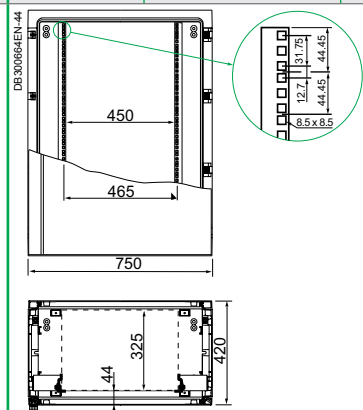

\*RAL 7035 from 2016.

### Recommendation

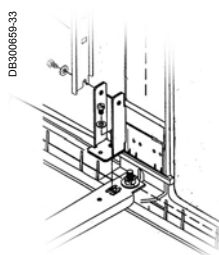

#### Intermediate support

Accessory required for installing uprights, ref. **NSYSPLA●●●**.

**Reference**  
**NSYSBPLA**

# Accessories

	<b>Mounting</b> <span style="float: right;"><b>236</b></span>
	<b>Cable management</b> <span style="float: right;"><b>270</b></span>
	<b>Lighting and power socket</b> <span style="float: right;"><b>292</b></span>
	<b>Floor accessories</b> <span style="float: right;"><b>296</b></span>
	<b>Door accessories</b> <span style="float: right;"><b>297</b></span>
	<b>Other accessories</b> <span style="float: right;"><b>302</b></span>

# Mounting

## Mounting plates for wall-mounting enclosures

S3D S3X PLM CRN

PB500072-13



PB500100-13



PB500101-18



PB500102-18



Characteristics		Mounting plates						Telequick mounting plate**			
		Plain		Silkscreened		Microperforated					
				Silkscreened for easier distribution of the products to be installed. Centimetric grid pattern.		They considerably reduce the products installation time thanks to the holes prepared to receive the self-tapping screws. Holes with Ø 3.6 mm in steps of 12.5 mm.		They allow cable guides and ducting and other installation accessories to be clipped on, making it easier to install switchgear. 11 x 26 mm slots. Switchgear mounting by clip-on nuts.			
Material		Galvanised-steel		Galvanised-steel		Galvanised-steel		Zinc-coated-steel			
Colour		-		-		-		-			
Supply		1 mounting plate without mounting elements						1 mounting plate without mounting elements			
For enclosures (mm)		Dimensions (mm)		Max. load	Surface	References	References	References	No. of perforations in		References
Height	Width	H	W	(kg)	(dm <sup>2</sup> )				Height	Width	
60	700	-	-	-	-	-	-	-	-	-	-
120	700	-	-	-	-	-	-	-	-	-	-
200	200	150	150	40	2.3	NSYMM22	-	-	-	-	-
	300	150	250	40	3.7	NSYMM23	-	-	-	-	-
250	200	200	150	40	3	NSYMM2520	-	-	-	-	-
	400	200	350	60	7	NSYMM2540	-	-	-	-	-
	500	200	450	60	9	NSYMM2550	-	-	-	-	-
300	150	-	-	-	-	-	-	-	-	-	-
	195	-	-	-	-	-	-	-	-	-	-
	200	250	150	60	3.7	NSYMM32	-	NSYMF32	16	5	NSYMR32
	250	250	200	60	5	NSYMM3025*	-	-	16	8	NSYMR3025
	300	250	250	60	6.3	NSYMM33	-	NSYMF33	16	9	NSYMR33
	400	250	350	60	8.8	NSYMM43*	NSYMS43*	NSYMF43*	18	11	NSYMR34
	450	250	400	60	10	NSYMM3045	-	-	-	-	-
	500	-	-	-	-	-	-	-	-	-	-
	600	250	550	60	13.8	NSYMM36	-	-	-	-	-
	700	-	-	-	-	-	-	-	-	-	-
400	300	-	-	-	-	-	-	-	22	9	NSYMR43
	400	350	350	60	12.3	NSYMM44	NSYMS44	NSYMF44	24	11	NSYMR44
	600	350	550	90	12.3	NSYMM64*	NSYMS64*	-	24	19	NSYMR46
	800	350	750	90	26.3	NSYMM48	-	-	-	-	-
405	300	-	-	-	-	-	-	-	-	-	
500	300	450	250	60	11.3	NSYMM53*	NSYMS53*	NSYMF53	29	9	NSYMR53
	400	450	350	90	15.8	NSYMM54	NSYMS54	NSYMF54	31	11	NSYMR54
	500	450	450	90	20.3	NSYMM55*	NSYMS55*	NSYMF55	31	14	NSYMR55
600	400	550	350	90	19.3	NSYMM64	NSYMS64	NSYMF64*	38	11	NSYMR64
	500	550	450	90	24.8	NSYMM65	-	NSYMF65	38	14	NSYMR65
	600	550	550	135	30.3	NSYMM66	NSYMS66	NSYMF66	38	17	NSYMR66
	700	-	-	-	-	-	-	-	-	-	-
	800	-	-	-	-	-	-	-	36	24	NSYMR68
700	500	650	450	135	29.3	NSYMM75	NSYMS75	NSYMF75	44	14	NSYMR75
	600	650	550	135	35.8	NSYMM76	-	-	44	17	NSYMR76
705	500	-	-	-	-	-	-	-	-	-	
795	600	-	-	-	-	-	-	-	-	-	
800	600	750	550	135	41.3	NSYMM86*	NSYMS86*	NSYMF86*	51	17	NSYMR86
	800	750	750	150	56.3	NSYMM88	-	NSYMF88	51	24	NSYMR88
	1000	-	-	-	-	-	-	-	49	31	NSYMR810
900	500	-	-	-	-	-	-	-	-	-	-
	600	-	-	-	-	-	-	-	-	-	-
	700	-	-	-	-	-	-	-	-	-	-
1000	600	950	550	150	52.3	NSYMM106	-	NSYMF106	64	17	NSYMR106
	800	950	750	150	71.3	NSYMM108*	-	NSYMF108*	64	24	NSYMR108
	1000	950	950	180	90.3	NSYMM1010	-	NSYMF1010	62	31	NSYMR1010
	1200	-	-	-	-	-	-	-	62	37	NSYMR1012
1200	600	1150	550	180	63.3	NSYMM126	-	NSYMF126	75	17	NSYMR126
	800	1150	750	180	86.3	NSYMM128*	-	NSYMF128	75	24	NSYMR128
	1000	1150	950	180	109.3	NSYMM1210*	-	NSYMF1210*	75	31	NSYMR1210
	1200	1150	1150	180	132.3	NSYMM1212	-	-	-	-	-
1400	1000	1350	950	180	128.3	NSYMM1410	-	-	88	31	NSYMR1410

\* Plate with reversible dimensions; it can be installed in enclosures with inverted dimensions.

Example: Plate ref. NSYMM64 can be used for the following enclosures: H 600 x W 400 mm or H 400 x W 600 mm.

For plain and silkscreened mounting plates: In wall-mounting enclosures with widths of 1000 and 1200 mm, it is possible to install 2 mounting plates at different depths using an additional central step slide NSYSDRSDCR (more information on page 240).



# Mounting

## Mounting plates for wall-mounting enclosures

S3D S3X PLM

### Dimensions

#### Plain and silkscreened mounting plates

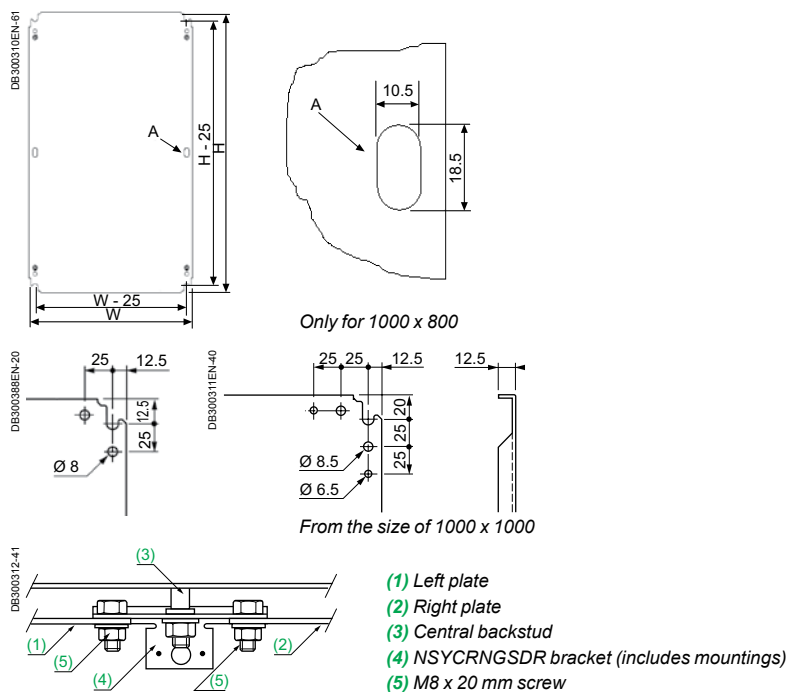

#### Microperforated mounting plate

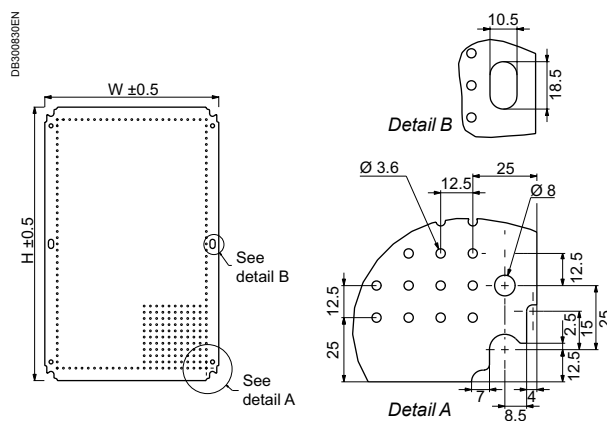

#### Telequick mounting plate

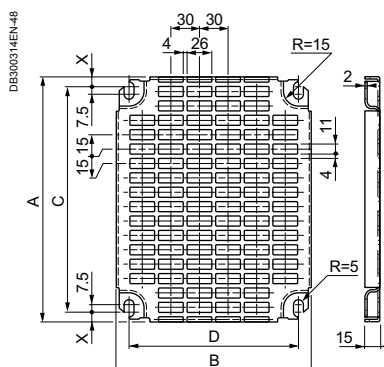

# Mounting

## Mounting plates for wall-mounting enclosures

S3D

S3X

PLM

### Dimensions

#### Joinable Telequick mounting plate

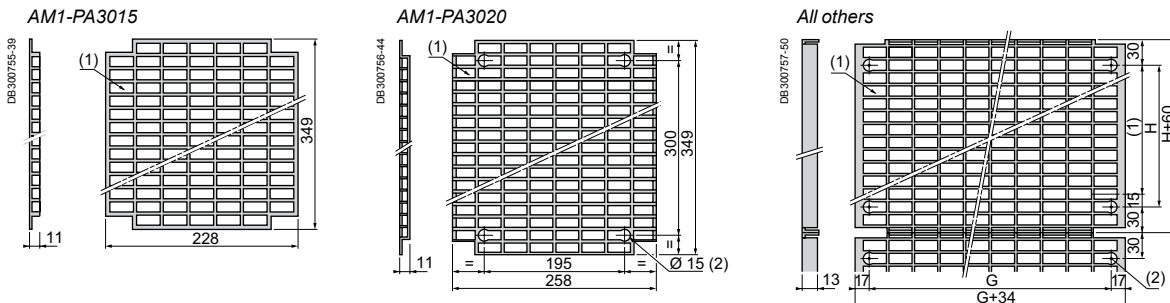

#### Bakelite and polyester mounting plate

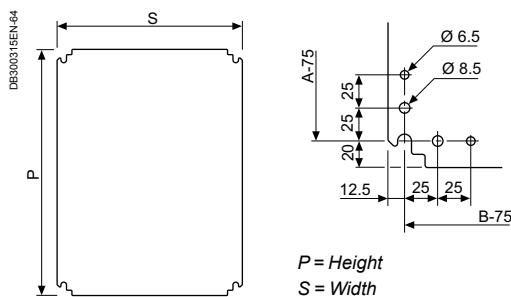

#### DIN-rail chassis

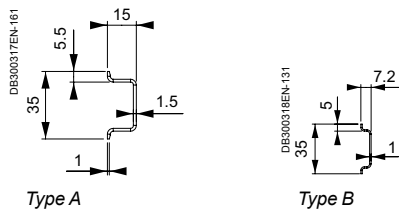

### Mounting plate accessories



Characteristics	Elevator for microperforated mounting plate	Clip-on nuts for Telequick mounting plate
	Mounting plate elevator to mount the Microperforated mounting plate at the same level as the other Telequick system components.	Used to easily fix devices in the Telequick mounting plate with the possibility of changing the lay-out as much as needed.
Supply	4 units	100 units. Reference by unit. Order by multiples of 100 (100, 200, 300...)
	<b>Reference</b> AZ1CA04	<b>Model</b> M3 M4 M5 M6
		<b>References</b> AF1EA3 AF1EA4 AF1EA5 AF1EA6

# Mounting

## Step slides for wall-mounting enclosures

S3D

S3X



Characteristics	Step slides for mounting plate	Step slides for 2 mounting plates in one enclosure	Slide bracket for 2 mounting plates at different depths
	Set of 4 supports intended for installation in enclosures with depths of 200, 250, 300 and 400 mm. The rail allows the depth of the plate and other accessories to be adjusted in steps of 12.5 mm.	In 1000 and 1200 mm wall-mounting enclosures, it is possible to install 2 mounting plates side by side, using the additional central step slides.	Additional slide bracket to be installed on the central step slides in order to mount 2 mounting plates, side by side, in different depths.
Supply	4 step slides	2 step slides	2 slide brackets
For enclosure	<b>References</b>		
Depth (mm)			
200	<b>NSYSDCR200</b>	-	<b>NSYCRNGSDR</b>
250	<b>NSYSDCR250</b>	-	
300	<b>NSYSDCR300</b>	<b>NSYSDRSDCR300*</b>	
400	<b>NSYSDCR400</b>	<b>NSYSDRSDCR400*</b>	
	 	 <p>(1) Left plate                      (2) Right plate                      (3) Central backstud                      (4) NSYCRNGSDR bracket (includes mountings)                      (5) NSYSDRSDCR slide bracket                      (6) M8 x 20 mm screw</p>	 <p>See detail A</p>  <p>Detail A</p>

\* Not applicable for stainless steel enclosures.



# Mounting

## Vertical rails for wall-mounting enclosures

S3D S3X PLM PLA



S3D S3X PLM

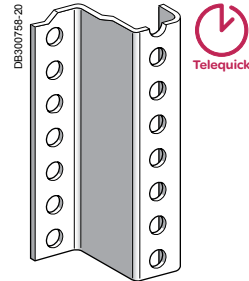

Characteristics	Aluminium vertical rails			20/10° mm zinc-coated pre-drilled uprights	
	Mounting in the enclosure with M8 nuts, ref. <b>NSYAMCSF</b> (batch of 4 adapters to be ordered separately).			Ø 11 mm holes enable to adjust the rows of equipment by 20 mm steps.	
Supply	-			4 units	
Height (a) (mm)	Material	Supply (units)	References	Weight (g)	References
300	Aluminium	10	NSYMDVR3	-	-
400	Aluminium	10	NSYMDVR4	-	-
500	Aluminium	10	NSYMDVR5	-	-
600	Aluminium	10	NSYMDVR6	-	-
700	Aluminium	10	NSYMDVR7	-	-
800	Aluminium	10	NSYMDVR8	-	-
1000	Aluminium	10	NSYMDVR10	-	-
1020	-	-	-	2330	DZ6MZ121
1200	Steel	2	NSYMDVR12	-	-
1320	-	-	-	2920	DZ6MZ151
1620	-	-	-	3375	DZ6MZ181
1920	-	-	-	4000	DZ6MZ211
3000 (3 m)	Aluminium	10	NSYMDVR3M	-	-

### Sliding Nuts

Sliding nuts to be used on aluminium vertical rails.

Type	Supply (units)	References
M4	100	NSYNM4
M5	100	NSYNM5
M6	100	NSYNM6

### Brass nuts to fix the upright to the enclosures

Supply: 4.  
Reference: **NSYAMCSF**

### Slides and brackets

They allow the depth of the plates and rails to be adjusted.  
Supply: 10 units. References per unit. To be ordered in multiples of 10 (10, 20, 30, etc.).

Type	References
90-mm slide with bracket for enclosures with depths of 150 and 200 mm	NSYSB90
130-mm slide with bracket for enclosures with depths of 250 and 300 mm	NSYSB130
Bracket for slides (customised mounting plate)	NSYFB

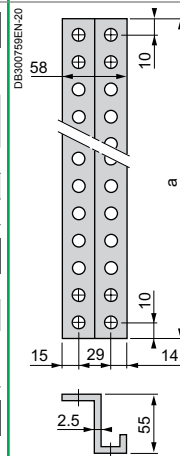

### Notched clamp nuts

Specially designed for pre-drilled uprights.  
Supply: 100 units. Reference by unit. Order by multiples of 100 (100, 200, 300...).

Type	Weight (g)	References
M6	7.0	DZ5MF6
M8	8.0	DZ5MF8

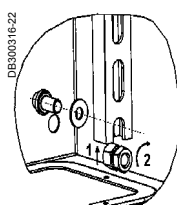

Ref. **NSYAMCSF**

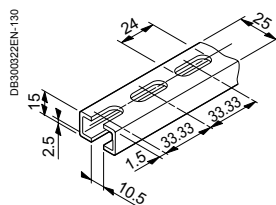

# Mounting

## Mounting plates for floor-standing enclosures

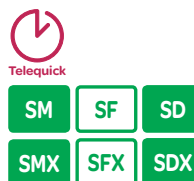

Characteristics	Plain mounting plate		Perforated mounting plate "Telequick"						Partial mounting plate			
	<ul style="list-style-type: none"> <li>Depth adjustable with a pitch of 25 mm, provided with plastic shoe for easier sliding.</li> <li>Once the plate is fixed, in advanced position, the sliding shoe can be easily removed, to increase the available plate surface.</li> <li>In sets made up of two or more enclosures with mounting plates, it is possible to obtain a continuous plate surface using intermediate mounting plates (see page 243).</li> </ul>		<ul style="list-style-type: none"> <li>Allows the installation of switchgear without drilling or screwing.</li> <li>Plate designed for quick mounting of switchgear by means of clip-on nuts ref. <b>NSYKNM3</b> to <b>NSYKNM6</b>.</li> <li>Vertical continuity is guaranteed by the vertical installation of plates.</li> <li>The top plate must be fixed in the third hole, 80 mm from the top frame.</li> </ul>						Partial mounting plate, provided with reinforcement flange on its four sides.			
Material	Galvanised steel		Zinc-coated steel						Galvanised steel			
Mounting	Mounting options: <ul style="list-style-type: none"> <li>At the sides of the enclosure with the orthogonal brackets (see page 246)</li> <li>Back-to-back, with the brackets for mounting the mounting plates in back-to-back position (see page 247)</li> </ul>		Mounting options: <ul style="list-style-type: none"> <li>Directly to the vertical uprights of the structure, by means of self-tapping screws (only Spacial SF)</li> <li>To the technical vertical uprights, by means of sliding nuts, page 250; to standard uprights by means of flat nuts, page 250 or self-tapping screws, and to cross rails</li> </ul>						Mounting options: <ul style="list-style-type: none"> <li><b>Spacial SF, SFX:</b> <ul style="list-style-type: none"> <li>Mounting to the vertical uprights of the structure</li> <li>Mounting to technical or standard vertical uprights, page 250</li> <li>For installations in advanced position, mounting to cross-rails, see page 254</li> </ul> </li> <li><b>Spacial SM:</b> <ul style="list-style-type: none"> <li>Mounting by means of adaptation profiles and 40-mm universal cross-rails (1 row) in vertical position, or also on horizontal universal cross-rails</li> <li>It can be mounted horizontally, as a tray, by means of depthwise cross rails, see page 254</li> </ul> </li> </ul>			
Maximum load	600 kg in the back of the enclosure and 500 kg in the intermediate position		-						-			
Supply	One mounting plate and sliding shoes		One perforated mounting plate and mounting elements for technical uprights and screws for mounting to the structure or cross rails						Partial mounting plate and mounting elements			
Dimensions (mm)	Dimensions (mm)	References	Plate height (mm)				Useful surface (dm <sup>2</sup> )	References	Plate height (mm)	Plate length (mm)	References	
	Width (B)	Height (A)	D	E	F	G			H	B-100		
600	1200	<b>NSYMP126</b>	450	200	-	100	11.4	<b>NSYSTMP2260</b>	247	500	<b>NSYSPMP2560</b>	
	1400	<b>NSYMP146</b>	450	425	-	325	22.8	<b>NSYSTMP4560</b>	247	750	<b>NSYSPMP2575</b>	
	1600	<b>NSYMP166</b>	450	575	125	475	30.4	<b>NSYSTMP6060</b>	397	500	<b>NSYSPMP4060</b>	
	1800	<b>NSYMP186</b>	450	800	250	700	11.9	<b>NSYSTMP8260</b>	597	500	<b>NSYSPMP6060</b>	
	2000	<b>NSYMP206</b>										
800	1200	<b>NSYMP128</b>	650	200	-	100	15.9	<b>NSYSTMP2280</b>	247	700	<b>NSYSPMP2580</b>	
	1400	<b>NSYMP148</b>	650	425	-	325	31.8	<b>NSYSTMP4580</b>	397	700	<b>NSYSPMP4080</b>	
	1600	<b>NSYMP168</b>	650	575	125	475	42.4	<b>NSYSTMP6080</b>	597	700	<b>NSYSPMP6080</b>	
	1800	<b>NSYMP188</b>	650	800	250	700	58.4	<b>NSYSTMP8280</b>				
	2000	<b>NSYMP208</b>										
1000	1200	<b>NSYMP1210</b>	850	200	-	100	20.4	<b>NSYSTMP22100</b>	247	900	<b>NSYSPMP25100</b>	
	1400	<b>NSYMP1410</b>	850	425	-	325	40.8	<b>NSYSTMP45100</b>	397	900	<b>NSYSPMP40100</b>	
	1600	<b>NSYMP1610</b>	850	575	125	475	54.4	<b>NSYSTMP60100</b>	597	900	<b>NSYSPMP60100</b>	
	1800	<b>NSYMP1810</b>	850	800	250	700	74.9	<b>NSYSTMP82100</b>				
	2000	<b>NSYMP2010</b>										
1200	1200	<b>NSYMP1212</b>	1050	200	-	100	24.9	<b>NSYSTMP22120</b>	247	1100	<b>NSYSPMP25120</b>	
	1400	<b>NSYMP1412</b>	1050	425	-	325	49.9	<b>NSYSTMP45120</b>	397	1100	<b>NSYSPMP40120</b>	
	1600	<b>NSYMP1612</b>	1050	575	125	475	66.5	<b>NSYSTMP60120</b>	597	1100	<b>NSYSPMP60120</b>	
	1800	<b>NSYMP1812</b>	1050	800	250	700	91.5	<b>NSYSTMP82120</b>				
	2000	<b>NSYMP2012</b>										
1600	1800	<b>NSYMP1816</b>	Order two 800-mm plates							397	1100	<b>NSYSPMP40160</b>
	2000	<b>NSYMP2016</b>										

# Mounting

## Mounting plates for floor-standing enclosures



PB500783-31

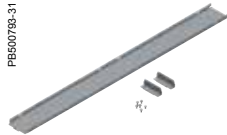

PB500784-24



PB500786-22



PB500788-29



Characteristics	Intermediate mounting plate	Intermediate mounting of mounting plate, located in the back of the enclosure	Intermediate mounting of the mounting plate, in advanced position	Reinforcement for mounting plate
	<ul style="list-style-type: none"> <li>Obtains a continuous surface of the mounting plate at enclosure suites.</li> <li>Adjustable depth with a pitch of 25 mm. When the mounting plates are located in the back of the enclosure, the vertical profiles of the structure are flush with the plates, acting as an intermediate mounting plate. In this case the intermediate plate cannot be installed.</li> </ul>	<ul style="list-style-type: none"> <li>Support for additional mounting of the mounting plate, at any height of the plate, when the plate is mounted in the back of the enclosure.</li> <li>The supports minimise the vibration of the plate during the transport and operation of the panel.</li> </ul>	<ul style="list-style-type: none"> <li>Support for additional mounting of the mounting plate, at any height of the plate, when the plate is mounted in advanced position.</li> <li>The supports minimise the vibration of the plate during the transport and operation of the panel.</li> </ul>	<ul style="list-style-type: none"> <li>Reinforcement kit for transversal mounting plate.</li> <li>Provides extra rigidity to the mounting plates and absorbs vibrations.</li> <li>Can be used as a support for mounting very heavy elements.</li> </ul>
Material	Galvanised steel	Zinc-coated steel	Zinc-coated steel	Zinc-coated steel
Thickness	-	-	-	15/10 <sup>e</sup> mm
Mounting	-	<ul style="list-style-type: none"> <li>The supports are fixed to the structure when the plate is already located in the back of the enclosure</li> <li><b>Spacial SM:</b> mounting to 40-mm universal cross rails (1 row), installed vertically in the back of the enclosure, see page 254</li> </ul>	The supports are mounted on light cross rails or on 40-mm (1 row) universal or quick-mounting cross rails (not supplied), see page 254	-
Supply	One intermediate plate and mounting elements	Ten units and mounting elements. Reference by unit. Order by multiples of 10 (10, 20, 30...)	Ten units and mounting elements. Reference by unit. Order by multiples of 10 (10, 20, 30...)	Two profiles, four supports for mounting to the mounting plate and mounting elements
Dimensions (mm)		References		
Height (A)	Width (B)			
1200	-	<b>NSYSIMP12</b>	<b>NSYSMPFB</b>	<b>NSYSMPFA</b>
1400	-	<b>NSYSIMP14</b>		
1600	-	<b>NSYSIMP16</b>		
1800	-	<b>NSYSIMP18</b>		
2000	-	<b>NSYSIMP20</b>		
2200	-	<b>NSYSIMP22</b>		
-	800	-		<b>NSYMPRK8</b>
-	1000	-		<b>NSYMPRK10</b>
-	1200	-		<b>NSYMPRK12</b>
-	1600	-		<b>NSYMPRK16</b>

PB500784-33

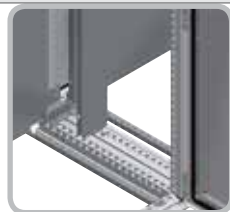

PB500785-26

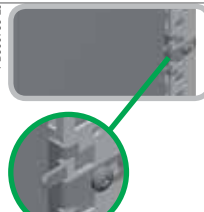

PB500787-34

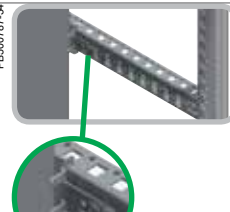

# Mounting

## Mounting plates for floor-standing enclosures

### Dimensions

#### Plain mounting plate

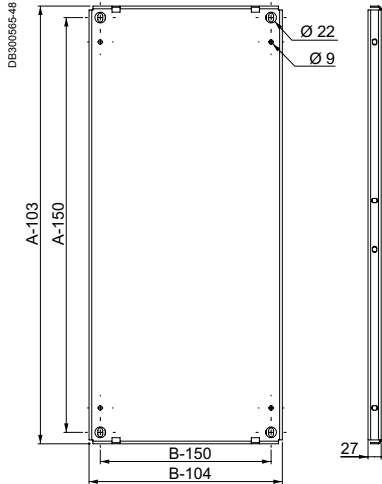

### + Advantages

- The Spacial.pro tool helps determine the optimum dimensions of the mounting plate.

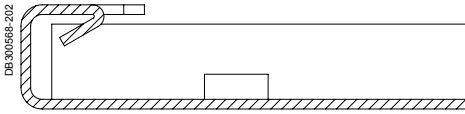

- The triple fold of the vertical edges of the mounting plate contributes to increasing the latter's rigidity and increases handling safety by preventing finger cuts.

#### Perforated mounting plate "Telequick"

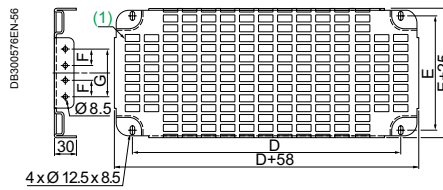

(1) Cut-outs 11 x 26 with a pitch of 15 x 30.



#### Examples of perforated mounting plate installation

PB500825-19



Perforated plate mounted on structure.

PB500826-23



Perforated plate mounted on technical vertical uprights.

PB500827-23



Perforated plate mounted on standard vertical uprights.

PB500828-22



Perforated plate mounted on cross rails.

#### Partial mounting plate

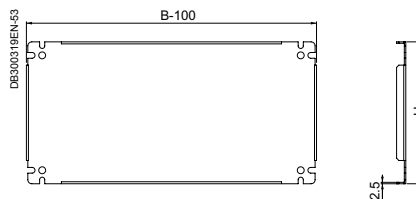

# Mounting

## Mounting plates for floor-standing enclosures

### Dimensions and mounting

#### Intermediate mounting plate

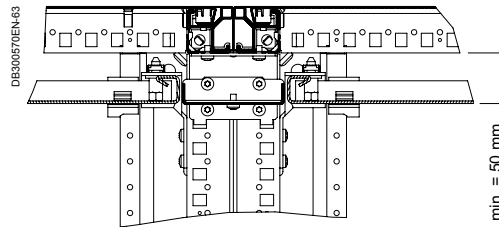

#### Reinforcement for mounting plate

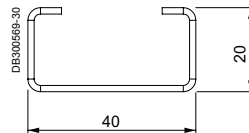

### Mounting plate accessories

#### Self-tapping screw

PB500808



- Hexagonal head, 4.8 x 16 mm thread. Drilling capacity: thicknesses between 17.5/10° and 40/10° mm.
- **Supply:** 100 units. To be ordered in multiples of 100 (100, 200, 300, etc.).

#### Reference

**NSYS16M5HS**

# Mounting

## Mounting plate brackets for floor-standing enclosures

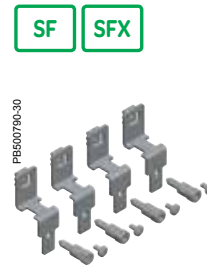
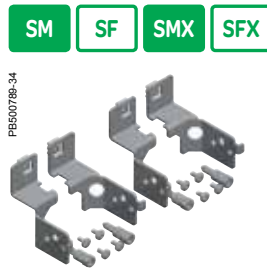

Characteristics	Mounting plate mounting brackets	Orthogonal brackets	
	<ul style="list-style-type: none"> <li>■ For direct mounting on the structure of the enclosure.</li> <li>■ Adjustable depth with a pitch of 25 mm.</li> </ul>	<ul style="list-style-type: none"> <li>■ Designed for the installation of mounting plates on the sides of the enclosure.</li> <li>■ In the event of installing one plate in the back of the enclosure and one plate at the side, they must both be installed using orthogonal brackets.</li> <li>■ <b>Spacial SFX</b>: to mount the lateral mounting plate, remove the one on the back and its mounting brackets.</li> </ul>	
Material	Zinc-coated steel	Zinc-coated steel	
Maximum load	4 brackets: 600 kg	4 brackets: 600 kg	
Supply	Four brackets and mounting elements	Four brackets and mounting elements	
<b>References</b>			
	<b>Spacial SF</b> NSYSFPB	<b>Spacial SM, Spacial SFX, Spacial SMX</b> NSYSMPB	<b>NSYSMPSB</b>

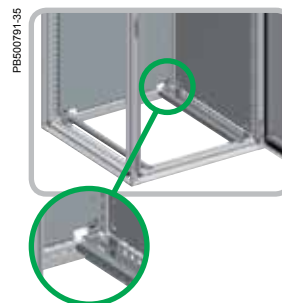

# Mounting

## Mounting plate brackets for floor-standing enclosures

SF



SF



SF SFX



Mounting plate sliding rails	Brackets for mounting mounting plates in back-to-back position	Brackets for mounting intermediate mounting plates in back-to-back position
<ul style="list-style-type: none"> <li>■ Rails which the mounting plate slides along when inserted in the enclosure.</li> <li>■ Once the mounting plate is installed and fixed to the brackets, the sliding rails can be removed to maximise the cable passage surface, and can be installed depthwise in other positions.</li> </ul>	<ul style="list-style-type: none"> <li>■ Doubling the mounting surface.</li> <li>■ Adjustable with a pitch of 25 mm.</li> </ul>	<ul style="list-style-type: none"> <li>■ Doubling the mounting surface.</li> <li>■ Adjustable with a pitch of 25 mm.</li> </ul>
Zinc-coated steel	Zinc-coated steel	Zinc-coated steel
-	-	-
Two rails and mounting elements	Four brackets for mounting back-to-back and mounting elements	2 brackets for mounting intermediate plates back-to-back and mounting elements

Depth (mm)			
400	<b>NSYSMPS4</b>	<b>NSYSBTB</b>	<b>NSYSIBTB</b>
500	<b>NSYSMPS5</b>		
600	<b>NSYSMPS6</b>		
800	<b>NSYSMPS8</b>		
		<p>C: Enclosure depth.</p>	<p>C: Enclosure depth.</p>

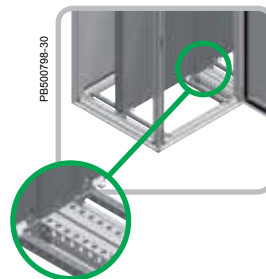
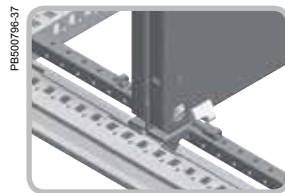
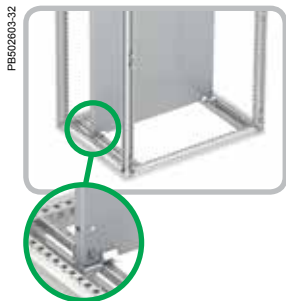

# Mounting

## Mounting rails for floor-standing enclosures

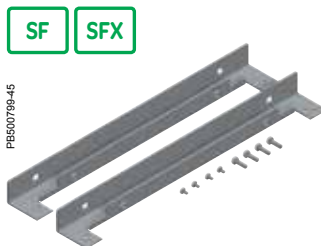

### Characteristics

#### Side entry rails for the mounting plate

- Side entry device for the mounting plates when coupling **Spacial SF** enclosures or **Spacial SFX**.
- The mounting plates can be coupled with one another, and are fixed to the side entry guide by pressure.

Material	Zinc-coated steel
Supply	Two rails and fixing elements

Dimensions (mm)		References
Width (B)	Depth (C)	
600	-	<b>NSYSMPSE6</b>
800	-	<b>NSYSMPSE8</b>
1000	-	<b>NSYSMPSE10</b>
1200	-	<b>NSYSMPSE12</b>
-	300	-
-	400	-
-	500	-
-	600	-
-	800	-



### ★ Examples of combination

Length of joined Spacial SF enclosures (mm)	Example of Spacial SF enclosure combination width (mm) (B)	Example of combining mounting plates by width (mm)	Useful length (mm)
1200	1200	600 + 800	1192
1400	600 + 800	600 + 1000	1392
1600	2 x 800	800 + 1000	1592
1800	3 x 600	800 + 1200	1792
2000	2 x 1000	1000 + 1200	1992
2200	600 + 2 x 800	1200 + 1200	2192
2400	3 x 800	1600 + 1000	2392
		3 x 600 + 1000	2384
2600	2 x 1000 + 600	1600 + 1200	2592
		3 x 600 + 1200	2584
2800	2 x 1000 + 800	4 x 800	2784
3000	3 x 1000	3 x 800 + 1000	2984
3200	2 x 1000 + 1200	3 x 800 + 1200	3184
3400	3 x 800 + 1000	800 + 3 x 1000	3384
3600	3 x 1200	4 x 1000	3584
3800	800 + 3 x 1000	600 + 3 x 1200	3784
4000	4 x 1000	800 + 3 x 1200	3984



# Mounting

## Mounting rails for floor-standing enclosures

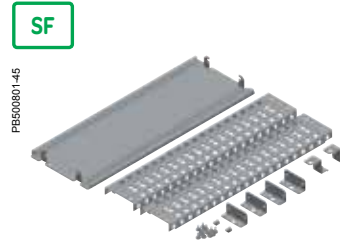
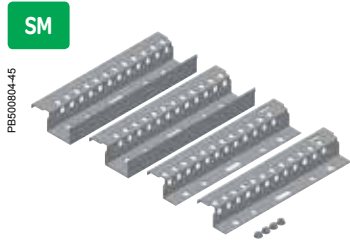

SM	SF
<b>Top/bottom adjustment rails</b>	<b>Kit for adapting two-door enclosures</b>
<ul style="list-style-type: none"> <li>■ Allows the installation of two mounting plates or vertical uprights in enclosures with a width of 1200 mm, as if in two independent enclosures.</li> <li>■ A set of mounting plate mounting brackets ref. <b>NSYSMPB</b> is required for this.</li> <li>■ Optional installation of an intermediate mounting plate.</li> </ul>	<ul style="list-style-type: none"> <li>■ Allows the installation of two mounting plates as if in two independent enclosures.</li> <li>■ A set of brackets for fixing mounting plates ref. <b>NSYSMPB</b> is required for this.</li> <li>■ Option of installing an intermediate mounting plate.</li> <li>■ Valid for enclosures with widths of 1200 and 1600 mm.</li> <li>■ In the event of installing a cable-gland plate for a width of 1200 mm, it is necessary to install two with a width of 600 mm, and for widths of 1600 mm, two with a width of 800 mm.</li> </ul>
-	-
2 rails, top and bottom, and fixing elements	Two 90 mm cross rails, cable-gland plate support, 2 brackets for central fixing of the roof and fixing elements
<b>References</b>	<b>References</b>
-	-
-	-
-	-
-	-
<b>NSYSTBR3</b>	-
<b>NSYSTBR4</b>	<b>NSYSMP2D4</b>
<b>NSYSTBR5</b>	<b>NSYSMP2D5</b>
<b>NSYSTBR6</b>	<b>NSYSMP2D6</b>
-	<b>NSYSMP2D8</b>

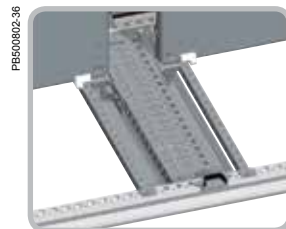
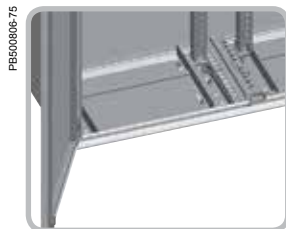

# Mounting Uprights for floor-standing enclosures



- SM
- SF
- SD
- SMX
- SFX
- SDX
- PLA

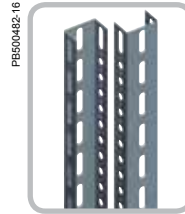

- SM
- SF
- SMX
- SFX

Characteristics	Technical uprights	Standard uprights																																																
	<ul style="list-style-type: none"> <li>■ Vertical uprights for mounting plates and rails.</li> <li>■ They can be fixed on the mounting plate mounting brackets or on the upright mounting bracket, ref. <b>NSYMFB</b>.</li> <li>■ Adjustable height with a pitch of 2.5 mm (with quarter-turn nuts, ref. <b>NSYSNM6</b> or <b>NSYSNM8</b>) or 25 mm (with cage nuts, ref. <b>NSYCNM6</b> or <b>NSYCNM8</b>).</li> </ul>	<ul style="list-style-type: none"> <li>■ Vertical uprights for mounting plates and rails.</li> <li>■ They can be fixed on the mounting plate mounting brackets or on the upright mounting bracket, ref. <b>NSYMFB</b>.</li> <li>■ Adjustable height with a pitch of 25 or 50 mm.</li> </ul>																																																
Material	Galvanised steel	Galvanised steel																																																
Thickness	20/10° mm	20/10° mm																																																
Supply	2 standard uprights	2 standard vertical uprights																																																
<b>Enclosure dimensions (mm)</b>	<b>Dimensions (mm)</b>	<b>Dimensions (mm)</b>																																																
<b>Height</b>	<b>A</b>	<b>A</b>																																																
750	625	-																																																
1000*	675	-																																																
1000	875	-																																																
1200	1075	-																																																
1250	1125	-																																																
1400	1275	-																																																
1500	1375	-																																																
1600	1475	-																																																
1800	1675	1800																																																
2000	1875	2000																																																
2200	2075	2200																																																
	<b>References</b>	<b>References</b>																																																
	<ul style="list-style-type: none"> <li>NSYTVR7</li> <li>NSYTVR8</li> <li>NSYTVR10</li> <li>NSYTVR12</li> <li>NSYTVR125</li> <li>NSYTVR14</li> <li>NSYTVR15</li> <li>NSYTVR16</li> <li>NSYTVR18</li> <li>NSYTVR20</li> <li>NSYTVR22</li> </ul>	<ul style="list-style-type: none"> <li>NSYVR18</li> <li>NSYVR20</li> <li>NSYVR22</li> </ul>																																																
	<b>Nuts and screws for technical uprights</b>	<b>Nuts and screws for standard uprights</b>																																																
	<table border="1" style="width: 100%; border-collapse: collapse;"> <thead> <tr> <th>Model</th> <th>Supply (units)</th> <th>References</th> </tr> </thead> <tbody> <tr> <td>M6 quarter-turn sliding nut (1)</td> <td>10</td> <td>NSYSNM6</td> </tr> <tr> <td>M8 quarter-turn sliding nut (1)</td> <td>10</td> <td>NSYSNM8</td> </tr> <tr> <td>M6 quarter-turn serrated sliding nut (2)</td> <td>10</td> <td>NSYSNSM6</td> </tr> <tr> <td>M8 quarter-turn serrated sliding nut (2)</td> <td>10</td> <td>NSYSNSM8</td> </tr> <tr> <td>M6 removable nut (3)</td> <td>50</td> <td>NSYCNM6</td> </tr> <tr> <td>M8 removable nut (3)</td> <td>50</td> <td>NSYCNM8</td> </tr> <tr> <td>M6 x 12 screw</td> <td>100</td> <td>AF1VA612</td> </tr> <tr> <td>M6 x 18 screw</td> <td>100</td> <td>AF1VA618</td> </tr> <tr> <td>M8 x 20 screw</td> <td>100</td> <td>AF1VC820</td> </tr> </tbody> </table>	Model	Supply (units)	References	M6 quarter-turn sliding nut (1)	10	NSYSNM6	M8 quarter-turn sliding nut (1)	10	NSYSNM8	M6 quarter-turn serrated sliding nut (2)	10	NSYSNSM6	M8 quarter-turn serrated sliding nut (2)	10	NSYSNSM8	M6 removable nut (3)	50	NSYCNM6	M8 removable nut (3)	50	NSYCNM8	M6 x 12 screw	100	AF1VA612	M6 x 18 screw	100	AF1VA618	M8 x 20 screw	100	AF1VC820	<table border="1" style="width: 100%; border-collapse: collapse;"> <thead> <tr> <th>Model</th> <th>Supply (units)</th> <th>References</th> </tr> </thead> <tbody> <tr> <td>M6 flat nut</td> <td>50</td> <td>NSYFNM6</td> </tr> <tr> <td>M8 flat nut</td> <td>50</td> <td>NSYFNM8</td> </tr> <tr> <td>M6 x 12 screw</td> <td>100</td> <td>AF1VA612</td> </tr> <tr> <td>M6 x 18 screw</td> <td>100</td> <td>AF1VA618</td> </tr> <tr> <td>M8 x 20 screw</td> <td>100</td> <td>AF1VC820</td> </tr> </tbody> </table>	Model	Supply (units)	References	M6 flat nut	50	NSYFNM6	M8 flat nut	50	NSYFNM8	M6 x 12 screw	100	AF1VA612	M6 x 18 screw	100	AF1VA618	M8 x 20 screw	100	AF1VC820
Model	Supply (units)	References																																																
M6 quarter-turn sliding nut (1)	10	NSYSNM6																																																
M8 quarter-turn sliding nut (1)	10	NSYSNM8																																																
M6 quarter-turn serrated sliding nut (2)	10	NSYSNSM6																																																
M8 quarter-turn serrated sliding nut (2)	10	NSYSNSM8																																																
M6 removable nut (3)	50	NSYCNM6																																																
M8 removable nut (3)	50	NSYCNM8																																																
M6 x 12 screw	100	AF1VA612																																																
M6 x 18 screw	100	AF1VA618																																																
M8 x 20 screw	100	AF1VC820																																																
Model	Supply (units)	References																																																
M6 flat nut	50	NSYFNM6																																																
M8 flat nut	50	NSYFNM8																																																
M6 x 12 screw	100	AF1VA612																																																
M6 x 18 screw	100	AF1VA618																																																
M8 x 20 screw	100	AF1VC820																																																

\* Control desk.  
 (1) M6 quarter-turn sliding nut  
 (2) M6 quarter-turn serrated sliding nut  
 (3) M6 removable nut

### Bracket for mounting uprights

PB500823-27

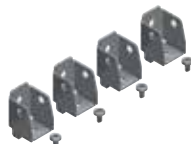

- Brackets for mounting the uprights, standard or technical, at the same level as the structure, obtaining a greater working surface inside the enclosure.
- They allow two pairs of uprights to be fixed back to back, doubling the working surface.
- The brackets are fixed to the structure by means of M6 self-tapping screws.
- Adjustable depth with a pitch of 25 mm.
- **Material:** zinc-coated steel.
- **Supply:** four brackets for mounting uprights and mounting elements.

**Reference**  
**NSYMFB**

# Mounting

## Other support brackets



Characteristics	Rail support bracket	Combined support bracket	Terminal-block support bracket	Mounting brackets for the earthing strip	Combined support bracket (vertical)
	Bracket for mounting rails at an angle of 45°.	Allow the installation of a DIN rail and an earthing strip on different planes, to minimise the cable radiuses.	<ul style="list-style-type: none"> <li>They allow the mounting of a DIN rail.</li> <li>Tilted to 45°.</li> </ul>	<ul style="list-style-type: none"> <li>They allow the mounting of an earth-collector rail and a DIN rail.</li> <li>Tilted to 30°.</li> <li>Earthing strip, ref. <b>NSYECB1M153</b>. See page 302.</li> </ul>	Allow the installation of a DIN rail and an earthing strip on different planes, to minimise the cable radiuses.
Material	Zinc-coated steel	Zinc-coated steel	Treated steel	-	Zinc-coated steel
Installation	<ul style="list-style-type: none"> <li><b>Spacial SF</b>: mounted on the structure and/or mounting plates</li> <li><b>Spacial SM</b>: mounted on the bottom mounting rail and/or mounting plates</li> </ul>	<ul style="list-style-type: none"> <li><b>Spacial SF</b>: directly on the structure and/or using mounting plates</li> <li><b>Spacial SM</b>: on the bottom adjustment rails and/or on mounting plates</li> </ul>	-	To be fixed on mounting plate.	<b>Spacial SF/SM</b> : directly on the vertical structure and/or using mounting plates
Supply	Ten units and mounting elements. Reference by unit. Order by multiples of 10 (10, 20, 30...)	Ten combined support brackets & mount elements. Reference by unit. Order multiples of 10 (10, 20, 30...)	2 lugs and mountings	2 mounting brackets and mounting elements	10 brackets
<b>References</b>	<b>NSYFB45</b>	<b>NSYETF</b>	<b>NSYEDCO</b>	<b>NSYEDCOC</b>	<b>DZ5MS10</b>

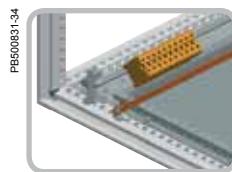
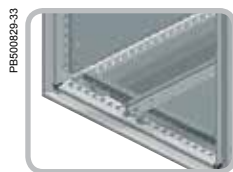

Characteristics	Clicked support plate	Bracket for fixing control units (Ø 22)
	For screw mounted equipment. For mounting on 35 mm symmetric and double profile DIN rails or Telequick mounting plate.	To mount any 22 mm diameter device directly on mounting plates.
Material	Zinc-plate coated	-
Installation	-	-
Supply	Ten units and mounting elements. Reference by unit. Order by multiples of 10 (10, 20, 30...)	Ten units & mount elements. Reference by unit. Order multiples of 10 (10, 20, 30...)
<b>References</b>	<b>A (mm)</b>	
	44 x 65 - 9 screws	<b>AX2DL01</b>
	49 x 65 - 4 screws	<b>AX2DL02</b>
		<b>DX1AP52</b>

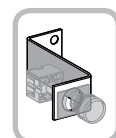
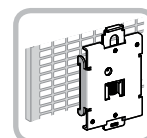

# Mounting

## Cross rails and profiles for floor-standing enclosures



In the **Spacial SF**, **SM**, **SFX** and **SMX** enclosures, it is possible to create a mounting at any point of the inner volume, providing mounting planes with different widths, heights and depths.

In the case of the **Spacial SM**, it may be necessary to install vertical/horizontal adaptation profiles and 40-mm universal cross rails (1 row).

For the formation of structures inside the enclosure, it is possible to combine three types of cross rails:

- Universal cross rails of 40 (1 row), 65 (2 rows) and 90 mm (3 rows).
- Quick-mounting cross rails of 40 (1 row), 65 (2 rows) and 90 mm (3 rows).
- Light cross rails.
- Mounting plate sliding rails, see page 247.

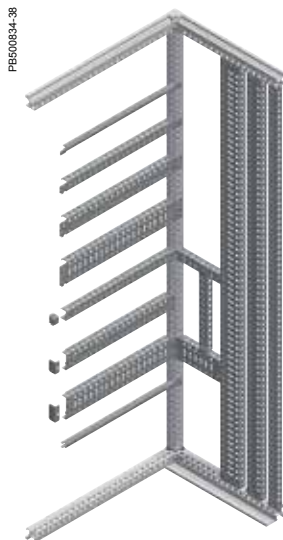
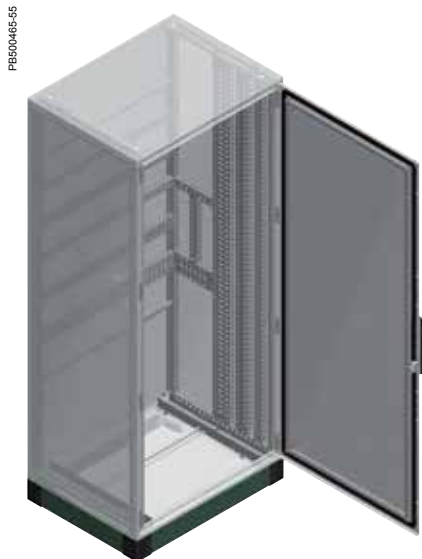

### ★ Combination examples

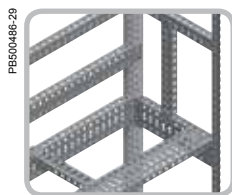

**Spacial SF and SFX:** the cross rails can be fixed to the structure and among each other, offering multiple possibilities.

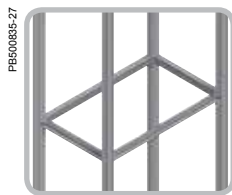

The universal cross rails allow installations at the same level, around the entire perimeter of the enclosure. To perform this type of installation in a **Spacial SM** enclosure, the vertical adaptation profile and the vertical 40-mm universal cross rail (1 row) are required, mounted in the back of the enclosure.



**Spacial SF:** the universal cross rails can be installed in vertical position.

# Mounting

## Cross rails and profiles for floor-standing enclosures



### Combination examples

PB500838-26

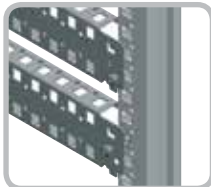

The quick-mounting cross rails can be fixed directly to the structure, quickly and easily.

■ **Spacial SF and SFX\*:**

□ They clip onto the structure and are fixed by M6 self-tapping screws, or optionally with M6 caged nuts.

■ **Spacial SM:**

- Possibility of clipping onto the adaptation profile or another cross rail.
- Mounting by means of M6 self-tapping screws.
- Mounting by means of M6 caged nuts.

\* In enclosures Spacial SFX is not possible to mount it in depth.

PB500839-30



The quick-mounting cross rails can be used as a support for equipment in the back of the enclosure or offset with a pitch of 25 mm, using two universal cross rails in vertical position.

PB500841-24



The 40 mm universal cross rails (1 row) used as depth-adjustable uprights with a pitch of 25 mm allow the installation of a multitude of supports for installing switchgears. The height may be adjusted with a pitch of 25 mm.

PB500842-30



The main mounting point to the quick-mounting cross rails is the 5.2 mm drill hole for M6 self-tapping screw, although they can also receive M6 and M8 caged nuts.

# Mounting

## Cross rails for floor-standing enclosures

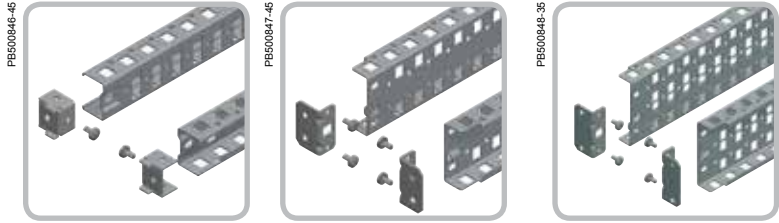

### Characteristics

Characteristics	Universal cross rails
Material	Zinc-coated steel
Thickness	15/10° mm
Supply	Two universal cross rails, four supports for universal cross rails and mounting elements

References		40 mm (1 row)	65 mm (2 rows)	90 mm (3 rows)
300	70	<b>NSYSUCR4030</b>	-	-
	110	-	<b>NSYSUCR6530</b>	-
	130	-	-	<b>NSYSUCR9030</b>
400	60	<b>NSYSUCR4040</b>	-	-
	100	-	<b>NSYSUCR6540</b>	-
	120	-	-	<b>NSYSUCR9040</b>
500	60	<b>NSYSUCR4050</b>	-	-
	90	-	<b>NSYSUCR6550</b>	-
	120	-	-	<b>NSYSUCR9050</b>
600	50	<b>NSYSUCR4060</b>	-	-
	80	-	<b>NSYSUCR6560</b>	-
	110	-	-	<b>NSYSUCR9060</b>
800	40	<b>NSYSUCR4080</b>	-	-
	70	-	<b>NSYSUCR6580</b>	-
	100	-	-	<b>NSYSUCR9080</b>
1000	30	<b>NSYSUCR40100</b>	-	-
	50	-	<b>NSYSUCR65100</b>	-
	70	-	-	<b>NSYSUCR90100</b>
1200	20	<b>NSYSUCR40120</b>	-	-
	50	-	<b>NSYSUCR65120</b>	-
	70	-	-	<b>NSYSUCR90120</b>
1400	(1)	<b>NSYSUCR40140</b>	<b>NSYSUCR65140</b>	<b>NSYSUCR90140</b>
1600	(1)	<b>NSYSUCR40160</b>	<b>NSYSUCR65160</b>	<b>NSYSUCR90160</b>
1800	(1)	<b>NSYSUCR40180</b>	<b>NSYSUCR65180</b>	<b>NSYSUCR90180</b>
2000	(1)	<b>NSYSUCR40200</b>	<b>NSYSUCR65200</b>	<b>NSYSUCR90200</b>
2200	(1)	<b>NSYSUCR40220</b>	<b>NSYSUCR65220</b>	<b>NSYSUCR90220</b>

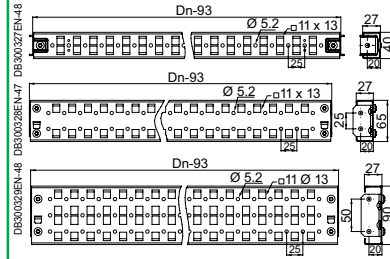

(1) For vertical assembly only.

**+** The universal cross rails allow any type of installation to be performed.

### Other dimensions

- For assembly in other positions, and between cross rails.
- **Material:** zinc-coated steel.
- **Thickness:** 15/10° mm.
- **Supply:** 2 universal cross rails, 4 supports for universal cross rails and mounting elements.

H or W or D (mm)	Maximum load (kg) by rail	References	90 mm (3 rows)
700	50	<b>NSYSUCR4070</b>	-
	110	-	<b>NSYSUCR9070</b>
900	40	<b>NSYSUCR4090</b>	-
	100	-	<b>NSYSUCR9090</b>
1100	30	<b>NSYSUCR40110</b>	-
	70	-	<b>NSYSUCR90110</b>

(2) Cross rails only for mounting cables.



# Mounting

## Cross rails for floor-standing enclosures

SM SF SFX

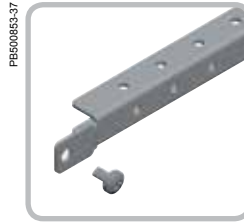

PB500833-7

Characteristics	Light cross rails
-----------------	-------------------

- |                         |   |
|-------------------------|---|
| Material                | Zinc-coated steel                           |
| Thickness               | -   |
| Supply                  | Two light cross rails and mounting elements |
| <b>Width/Depth (mm)</b> | <b>References</b>                           |
| 400                     | <b>NSYSLCR40</b>                            |
| 500                     | <b>NSYSLCR50</b>                            |
| 600                     | <b>NSYSLCR60</b>                            |
| 800                     | <b>NSYSLCR80</b>                            |
| <b>Depth (mm)</b>       |   |
| 400                     | -   |
| 500                     | -   |
| 600                     | -   |
| 800                     | -   |

■ **Spacial SF and SFX:** direct mounting to the structure or between cross rails.  
 ■ **Spacial SM:** mounting by means of adaptation profiles and 40 mm universal cross rails (1 row), or between cross rails in any other position.  
 ■ Adjustable with a pitch of 25 mm.  
 ■ The light cross rails are equipped with a row of drill holes with a diameter of 5.2 mm and a pitch of 25 mm, which allows mounting with an M6 self-tapping screw, ref. **NSYST30M6S**.

Material Zinc-coated steel

Thickness -

Supply Two light cross rails and mounting elements

**Width/Depth (mm)** **References**

400 **NSYSLCR40**

500 **NSYSLCR50**

600 **NSYSLCR60**

800 **NSYSLCR80**

**Depth (mm)**

400 -

500 -

600 -

800 -

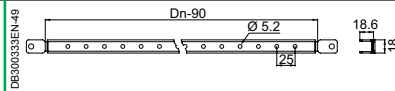

DE300338EN-49

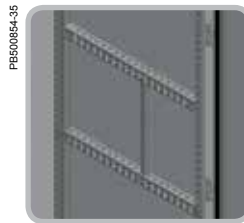

PB500854-35



# Mounting

## Cross rails for floor-standing enclosures

SF



SF

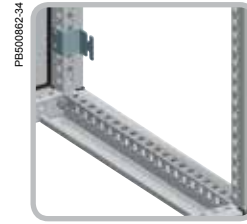
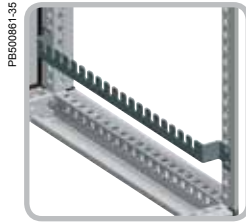

Rails for heavy loads		Cross rail for Lütze chassis	Support for Lütze chassis
<ul style="list-style-type: none"> <li>They can be mounted with a cable-gland plate or with a previously mounted mounting plate.</li> <li>Laterally adjustable with a pitch of 25 mm.</li> <li>Elongated holes, for adjusting the centre-to-centre distance of the switchgear.</li> </ul>		Cross rail for mounting and adjusting the depth of the Lütze chassis.	Support for installing Lütze chassis in the back of the enclosure.
Galvanised steel		Galvanised steel	Galvanised steel
40/10° mm		25/10° mm	25/10° mm
2 rails for heavy loads and mounting elements		6 cross rails for Lütze chassis & mounting elements	6 supports and mounting elements
-	-	-	-
-	-	-	-
-	-	-	-
-	-	-	-
<b>Maximum load (kg)</b>	<b>References</b>	<b>References</b>	<b>Reference</b>
575	NSYHLCR40	NSYLCR40	NSYLSUP
525	NSYHLCR50	NSYLCR50	
500	NSYHLCR60	NSYLCR60	
475	NSYHLCR80		



# Mounting Trays

SM

SF



Tray installed on the structure.



Telescopic rails fixed to the structure.

Characteristics		Fixed tray		Telescopic rails	
		<ul style="list-style-type: none"> <li>Options for mounting the tray to the enclosure:                             <ul style="list-style-type: none"> <li>If the tray has the same dimensions as the enclosure:                                     <ul style="list-style-type: none"> <li><b>Spacial SF</b>: direct mounting to the structure.</li> <li><b>Spacial SFX</b>: installation possible only with universal cross rails, see on page 254.</li> <li><b>Spacial SM</b>: mounting by means of adaptation profiles and 40-mm universal cross rails (1 row) in vertical position.   <ul style="list-style-type: none"> <li>If the tray is smaller than the dimensions of the enclosure: mounting on depth cross rails.</li> <li>Depth-adjustable tray with a pitch of 25 mm.</li> </ul> </li> </ul> </li> <li>Provided with cut-outs for improving air circulation inside.</li> </ul> </li></ul>		<ul style="list-style-type: none"> <li><b>Spacial SF</b>: installation directly on the structure of the enclosure or on universal cross rails.</li> <li><b>Spacial SFX</b>: installation possible only with universal cross rails, see on page 254.</li> <li><b>Spacial SM</b>: installation by means of adaptation profiles and 40-mm universal cross rails (1 row) in vertical position, or on horizontal universal cross rails.</li> <li>The installation of a telescopic tray consists of the following:                             <ul style="list-style-type: none"> <li>1 fixed tray.</li> <li>2 telescopic rails.</li> <li>End-of-travel stop of the rails in open and closed position.</li> </ul> </li> </ul>	
Material		Steel		Zinc-coated steel	
Finish		Painted with epoxy-polyester resin		-	
Colour		RAL 7035 grey		-	
Maximum load		150 kg evenly distributed		50 kg evenly distributed	
Supply		One fixed tray and mounting elements		Two telescopic rails and mounting elements	
Depth	Width	Tray dimensions (mm)	References	References	
400	600	482 x 290 x 30	NSYFXT6040	NSYTTG40	
	800	682 x 290 x 30	NSYFXT8040		
500	600	482 x 390 x 30	NSYFXT6050	NSYTTG50	
	800	682 x 390 x 30	NSYFXT8050		
600	600	482 x 490 x 30	NSYFXT6060	NSYTTG60	
	800	682 x 490 x 30	NSYFXT8060		
<div style="background-color: #333; color: white; padding: 5px;"> <b>Handle for telescopic trays</b> </div> <div style="display: flex; align-items: center; margin-top: 5px;"> <div> <ul style="list-style-type: none"> <li>Designed for easy extraction of the sliding trays.</li> <li><b>Material</b>: polyamide 6 (black).</li> <li><b>Supply</b>: 2 units &amp; mounting elements.</li> </ul> </div> </div> <div style="margin-top: 5px;"> <p><b>Reference</b></p> <p>NSY1TH</p> </div>					

+ Withstands loads of up to 150 kg.

SM

SF

SMX

SFX

## Tray cross rails



Tray installed on cross rails.



■ Allow the installation of fixed trays and telescopic rails. Quick and universal cross rails, see page 254.

Dimensions (mm)	Universal cross rail	Quick-mounting cross rail
<b>Depth</b>	40 mm (1 row)	40 mm (1 row)
400	NSYSUCR4040	NSYSQCR4040
500	NSYSUCR4050	NSYSQCR4050
600	NSYSUCR4060	NSYSQCR4060
800	NSYSUCR4080	NSYSQCR4080

# Mounting Rails



Characteristics	Symmetric mounting rail for the wall-mounting enclosures	Symmetric DIN rails for floor-standing enclosures	Asymmetric DIN rails for the floor-standing enclosures	Double-profile DIN rails				
	2 types: ■ Type A: 35 x 15 mm. ■ Type B: 35 x 7.5 mm.	Ensure horizontal continuity in case of enclosure assembly. Rail type: ■ Type A: 35 x 15 mm.	Ensure horizontal continuity in the case of enclosure assembly.	■ They combine the advantages of symmetric and asymmetric rails. ■ Quick installation of terminals according to standard DIN 46277/1.				
Material	Zinc-coated steel	Zinc-coated steel	Zinc-coated steel	Zinc-coated steel				
Standards	IEC 715	IEC 715	IEC 715	-				
Thickness	■ Type A: 15/10° mm ■ Type B: 10/10° mm	15/10° mm	15/10° mm	15/10° mm				
Mounting	Fixed to mounting plates or another mounting elements, uprights not included in the supply	Fixed to the standard or technical uprights (see page 250) or directly to the structure	Fixed to the standard or technical uprights (see page 250) or directly to the structure	Fixed to the standard or technical uprights (see page 250) or directly to the structure				
Supply	10 rails and mountings for direct assembling to the structure. References by unit. Order by multiples of 10 units (10, 20, etc.)	10 rails and mountings for direct assembling to the structure. References by unit. Order by multiples of 10 units (10, 20, etc.)	10 rails and mountings for direct assembling to the structure. References by unit. Order by multiples of 10 units (10, 20, etc.)	10 rails and mountings for direct assembling to the structure. References by unit. Order by multiples of 10 units (10, 20, etc.)				
Dimensions (mm)	Type	References	References	References	Type	References		
Enclosure Rail length (B)								
300	250	B	NSYSDR30B	-	-	W*	NSYDPR25	
400	350	B	NSYSDR40B	-	-	W*	NSYDPR35	
500	450	A	NSYSDR50A	-	-	W*	NSYDPR45	
600	550	A	NSYSDR60A	-	-	W*	NSYDPR55	
	588	-	-	NSYSDR60	NSYADR60	F**	NSYDPR60	
700	650	-	-	-	-	W*	NSYDPR65	
800	750	A	NSYSDR80A	-	-	W*	NSYDPR75	
	788	-	-	NSYSDR80	NSYADR80	F**	NSYDPR80	
1000	950	A	NSYSDR100A	-	-	-	-	
	988	-	-	NSYSDR100	NSYADR100	F**	NSYDPR100	
1200	1188	-	-	NSYSDR120	NSYADR120	F**	NSYDPR120	

\* For wall-mounting enclosure. \*\* For floor-standing enclosure. (1) Not perforated.

# Mounting Rails

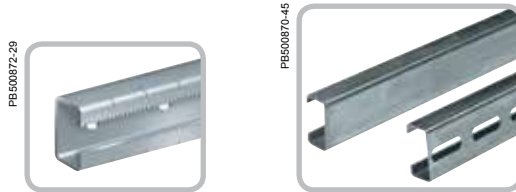

Characteristics	Serrated C-shaped rail for heavy loads	Symmetric C-shaped rails										
	Marked in steps of 25 mm to facilitate switchgear positioning.	Rails for supporting and mounting switchgear on panels and enclosures, formation of chassis, racks and panel reinforcements.										
Material	Zinc-coated steel	Galvanised steel										
Standards	-	-										
Thickness	20/10 <sup>e</sup> mm	-										
Mounting	-	They are fixed to the structure and to one another by means of mounting elements										
Supply	2 rails with a length of 2 m	References by unit. Order by multiples of the units specified in the supply										
Dimensions (mm)	References	Type	Dimensions (mm)								Supply	References
Rail length (B)			A	J	C	D	E	F	G	H		
1500	<b>AM1EC115</b>	-	-	-	-	-	-	-	-	-	-	-
2000	<b>AM1EC200</b>	C20 (1)	21	11	10	1.5	5.5	-	-	-	20	<b>NSYCN20</b>
		C20	21	11	10	1.5	5.5	5	6.2	15	20	<b>NSYCN20</b>
		C40 (1)	40	20	24	1.5	8	-	-	-	20	<b>NSYCN40</b>
		C40	40	20	24	1.5	8	10	8.5	30	20	<b>NSYCN40</b>

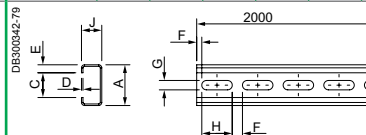
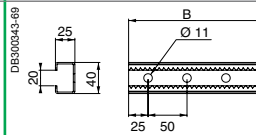

\* For wall-mounting enclosure. \*\* For floor-standing enclosure. (1) Not perforated.

## Nuts for symmetric C-shaped rails

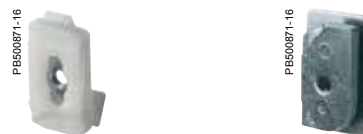

Characteristics		Combiplas nut		Metal sliding nut	
Rail type	Nuts type	Supply	References	Supply	References
C20	M3	-	-	-	-
	M4	100	<b>NSYBN204</b>	100	<b>NSYB204</b>
	M6	100	<b>NSYBN206</b>	-	-
C40	M4	50	<b>NSYBN404</b>	100	<b>NSYB404</b>
	M6	50	<b>NSYBN406</b>	-	-
	M8	50	<b>NSYBN408</b>	-	-
C60	M6	20	<b>NSYBN606</b>	100	<b>NSYB406</b>
	M8	20	<b>NSYBN608</b>	-	-
	M10	20	<b>NSYBN610</b>	-	-

# Mounting 2000 mm rails



Characteristics		Symmetric rails				Asymmetric DIN rails	Double-profile DIN rails
Material		Galvanized steel, zinc-coated steel or aluminium				Galvanized steel	Galvanized steel
Thickness		-				-	15/10° mm
Supply		-				20 rails with a length of 2 m. References by unit. Order by multiples of 20 units (20, 40, etc.)	20 rails with a length of 2 m. References by unit. Order by multiples of 20 units (20, 40, etc.)
Length (mm)	Perforations	Material	Type	Supply	References	References	References
2000	Perforated	Galvanized steel	A	20	<b>NSYSDR200D</b>	<b>NSYADR200D</b>	<b>NSYDPR200D</b> <b>NSYDPR200T*</b>
			B	20	<b>NSYSDR200BD</b>		
	Not perforated	Galvanized steel	A	20	<b>NSYSDR200</b>	<b>NSYADR200</b>	<b>NSYDPR200</b>
			B	20	<b>NSYSDR200B</b>		
		Zinc-coated steel	C	6	<b>AM1DL201</b>		
		Aluminium	D	10	<b>AM1EA200</b>		

\* 10/10° mm thickness.

# Mounting Rail accessories



Characteristics	Nuts				
	For symmetric rails	For symmetric rails 2000 mm version	For asymmetric DIN rails, 2000 mm version	For double-profile DIN rails	For serrated C-shaped rails
	Clip-on nut.	Clip-on nut. Only for types A and B.	Quarter-turn sliding nut.	Quarter-turn sliding nut.	Quarter-turn sliding nuts.
Supply	100	100	100	100	10
Type	References				
M3	-	-	-	AF1CF34	-
M4	AF1GC4	AF1GC4	DZ5ME5	AF1CF34	-
M5	AF1GC5	AF1GC5	DZ5ME8	AF1CF56	-
M6	AF1GC6	AF1GC6	DZ5ME9	AF1CF56	NSYSNM6 NSYSNSM6
M8	-	-	-	-	NSYSNM8 NSYSNSM8

# Mounting

## Connectors for symmetric C-shaped rails



### Examples

#### Combinations with connectors for symmetric C-shaped rails



- The connectors enable the formation of chassis or frames and structures for mounting switchgear, in any position inside the enclosures, allowing the mounting of DIN rails or other elements.
- See symmetric C-shaped rails.

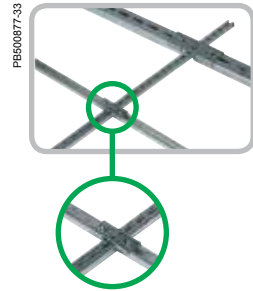
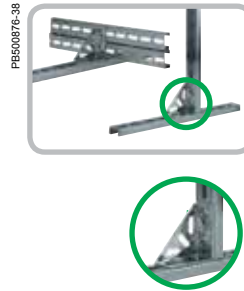
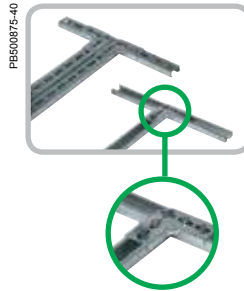

Characteristics	EMA connectors	EVA connectors	UCA connectors
-----------------	----------------	----------------	----------------

	To joint two symmetric C-shaped rails, C20 and C40 types, at right angles; they can also be used to obtain a T-shaped assembly.	To join two symmetric C-shaped rails, C20 and C40 types, forming an overlapping assembly with plane change, or also at right angles for the formation of spacers supports at a different level.	To join symmetric C-shaped rails, types C20 and C40, forming a cross-shaped assembly of three rails located on the same plane, for example inside a frame.
--	---	---	--

Material	Zinc-coated steel		
Thickness	20/10 <sup>e</sup> mm		
Supply	20 units. References by unit. Order by multiples of 20 units (20, 40, 60, etc.)	20 units. References by unit. Order by multiples of 20 units (20, 40, 60, etc.)	20 units. References by unit. Order by multiples of 20 units (20, 40, 60, etc.)

Dimensions (mm)									References		
A	B	C	D	E	F	G	H				

60	21.3	6	6.2	15	-	-	-	-	<b>NSYEMA20</b>	-	-
100	40.3	10	8.5	25	-	-	-	-	<b>NSYEMA40</b>	-	-
43	19	2	6.2	15	-	-	-	-	<b>NSYEVA20</b>	-	-
78	36	2.5	8.5	25	-	-	-	-	<b>NSYEVA40</b>	-	-
21.3	60	21.3	6	2	6.2	15	-	-	-	<b>NSYUCA22</b>	-
40.3	116	40.3	10	2.5	8.5	25	-	-	-	<b>NSYUCA44</b>	-
21.3	21.5	53.5	8	2	6.2	15	-	-	-	-	-
21.3	40.5	72.5	8	2	6.2	15	-	-	-	-	-
40.3	40.5	81	10	2.5	8.5	25	-	-	-	-	-
21.3	21.5	8	2	6.2	15	6.2	15	-	-	-	-
21.3	40.5	8	2	6.2	15	6.2	13	-	-	-	-
40.3	40.5	10	2.5	8.5	25	8.5	25	-	-	-	-
60	18	2	20	15	5	-	-	-	-	-	-
130	36	3	40	30	10	-	-	-	-	-	-
130	55	3	40	30	10	-	-	-	-	-	-
54	54	2	20	20	5	-	-	-	-	-	-
60	80	2	20	25	8	-	-	-	-	-	-
80	110	2	20	29	10	-	-	-	-	-	-

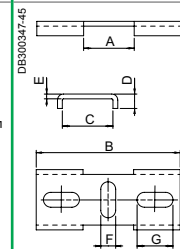
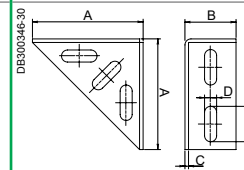
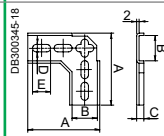



# Mounting

## Connectors for symmetric C-shaped rails

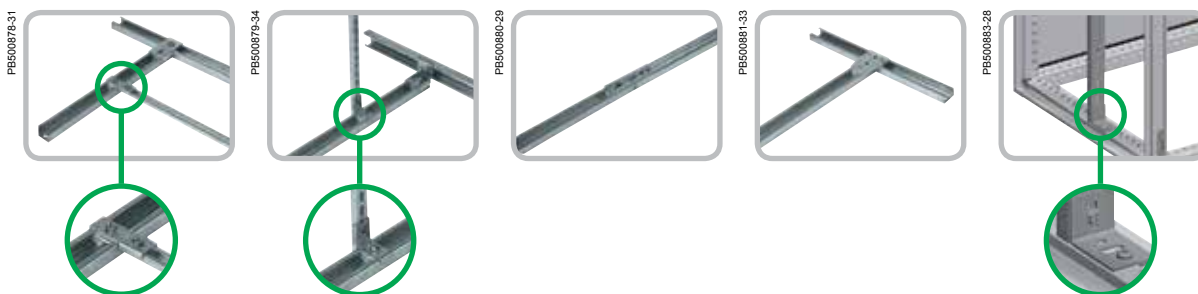

UTA connectors	ECA connectors	UR connectors	UT connectors	EN connectors
<ul style="list-style-type: none"> <li>To create a T-shaped assembly between two symmetric C-shaped rails, C20 and C40 types, especially recommended for forming crossbars on chassis and frames.</li> <li>The UTA42 connectors type allows C20 rails to be joined with C40 rails.</li> </ul>	<ul style="list-style-type: none"> <li>To form a cross-shaped assembly with two symmetric C-shaped rails, C20 and C40 types, located perpendicularly on different planes.</li> <li>The ECA42 connector type makes it possible to join C20 rails with C40 rails.</li> </ul>	<ul style="list-style-type: none"> <li>For rectilinear joining of symmetric C-shaped rails.</li> <li>Recommended when the standard length is not sufficient or for maximising fractions.</li> </ul>	<ul style="list-style-type: none"> <li>To form T-shaped assemblies between symmetric C-shaped rails. They are used to form crossbars on frames and structures.</li> </ul>	<ul style="list-style-type: none"> <li>To create L-shaped assemblies with plane change in the symmetric C-shaped rails, between them or with any other section.</li> </ul>

-	-	-	-	-
20 units. References by unit. Order by multiples of 20 units (20, 40, 60, etc.)	20 units. References by unit. Order by multiples of 20 units (20, 40, 60, etc.)	20 units. References by unit. Order by multiples of 20 units (20, 40, 60, etc.)	20 units. References by unit. Order by multiples of 20 units (20, 40, 60, etc.)	20 units. References by unit. Order by multiples of 20 units (20, 40, 60, etc.)

					NSYEN20	NSYEN40	NSYEN60
-	-	-	-	-	-	-	-
-	-	-	-	-	-	-	-
-	-	-	-	-	-	-	-
-	-	-	-	-	-	-	-
NSYUTA22	-	-	-	-	-	-	-
NSYUTA42	-	-	-	-	-	-	-
NSYUTA44	-	-	-	-	-	-	-
-	NSYECA22	-	-	-	-	-	-
-	NSYECA42	-	-	-	-	-	-
-	NSYECA44	-	-	-	-	-	-
-	-	NSYUR20	-	-	-	-	-
-	-	NSYUR40	-	-	-	-	-
-	-	NSYUR60	-	-	-	-	-
-	-	-	NSYUT20	-	-	-	-
-	-	-	NSYUT40	-	-	-	-
-	-	-	NSYUT60	-	-	-	-
DB300348-48	DB300349-36	DB300350-28	DB300351-24	DB300352EN-24	DB300353EN-22	DB300354EN-25	

# Mounting Spacers



Characteristics	Hexagonal spacers	ETU modular spacers
	<ul style="list-style-type: none"> <li>Hexagonal spacers for raising switchgear, mounting plates, etc. They can be linked together to achieve variable heights with gradual elevation.</li> <li>Their assembly requires M6 or M8 caged nuts.</li> </ul>	Modular spacers for installing devices or rails at a different level from that achieved with the basic chassis or mounting plate.
Material	-	Zinc-coated steel
Installation	If used to raise a mounting plate, the maximum load of the mounting plate is decreased	-
Supply	100 hexagonal connectors. References by unit. Order by multiples of 100 units (100, 200, 300, etc.)	20 units. References by unit. Order by multiples of 20 units (20, 40, 60, etc.)

References						
	Thread type (R)	Spacer height (mm) (A)		A (mm)	B (mm)	
	M5	10	NSYE1025	48	25	NSYETU48
	M5	15	NSYE1525	58	25	NSYETU58
	M5	20	NSYE2025	79	55	NSYETU79
	M6	10	NSYEX106	118	55	NSYETU118
	M6	12	NSYEX126			
	M6	14	NSYEX146			
	M6	16	NSYEX166			
	M6	18	NSYEX186			
	M6	20	NSYEX206			
	M6	30	NSYEX306			
	M6	40	NSYEX406			
	M6	50	NSYEX506			
	M6	100	NSYEX1006			
	M8	15	NSYEX158			
	M8	20	NSYEX208			
	M8	30	NSYEX308			
	M8	40	NSYEX408			
	M8	50	NSYEX508			
	M8	60	NSYEX608			
	M8	100	NSYEX1008			

Combination of spacers	Minimum height (mm)	Maximum height (mm)
NSYETU48 + NSYETU48	53	64
NSYETU48 + NSYETU58	63	74
NSYETU48 + NSYETU79	85	95
NSYETU48 + NSYETU118	124	134
NSYETU58 + NSYETU58	73	84
NSYETU58 + NSYETU79	94	104
NSYETU58 + NSYETU118	134	144
NSYETU79 + NSYETU79	84	125
NSYETU79 + NSYETU118	124	164
NSYETU118 + NSYETU118	164	204

  

Thread type (R)	Spacer height (mm) (A)	
M5	10	NSYE1025
M5	15	NSYE1525
M5	20	NSYE2025
M6	10	NSYEX106
M6	12	NSYEX126
M6	14	NSYEX146
M6	16	NSYEX166
M6	18	NSYEX186
M6	20	NSYEX206
M6	30	NSYEX306
M6	40	NSYEX406
M6	50	NSYEX506
M6	100	NSYEX1006
M8	15	NSYEX158
M8	20	NSYEX208
M8	30	NSYEX308
M8	40	NSYEX408
M8	50	NSYEX508
M8	60	NSYEX608
M8	100	NSYEX1008

# Mounting 19" Chassis

S3D

S3X

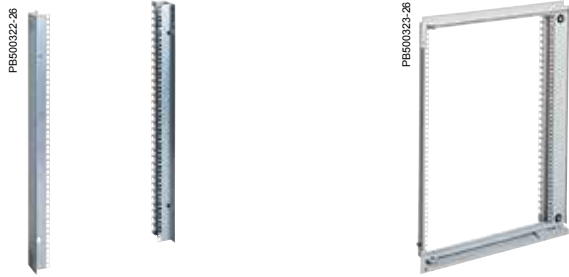

Characteristics		19" fixed chassis for wall-mounting enclosure		19" swing chassis for wall-mounting enclosure	
		<ul style="list-style-type: none"> <li>■ 19" fixed chassis comprising 2 19" uprights with mounting.</li> <li>■ Adjustable in depth by mounting on the step slides in accessories.</li> </ul>		19" swing chassis opening to 120° with closure by 3 mm double bar insert.	
Material		Galvanized steel		Steel	
Finish		-		Textured epoxy-polyester powder paint	
Colour		-		RAL 7035 grey	
Thickness		20/10 <sup>o</sup> mm		-	
Maximum load		3 kg per unit		3 kg per unit	
Enclosure (mm)		Unit number	References	Unit number	References
Height	Width				
400	600	8	NSYVDM8UF	7	NSYVDM7UP
600	600	12	NSYVDM12UF	11	NSYVDM11UP
800	600	17	NSYVDM17UF	16	NSYVDM16UP
1000	600	21	NSYVDM21UF	20	NSYVDM20UP
	800	-	-	20	NSYVDM20U8P
1200	800	-	-	25	NSYVDM25U8P

## Mountings for 19" rack

PB500189-50



- They allow 19" accessories to be mounted.
- Caged nut compatible with 8.5 x 8.5 mm and 9.5 x 9.5 mm holes.

Name	Batch of	References
M6 screws + washers + nuts	30	NSYGFR95M63
M6 x 16 screws and washers	50	NSYGFR166P
M6 caged nuts	100	NSYCN9M625
M6 screws + washers + nuts	50	NSYGFR95M65
M5 screws + washers + nuts	50	NSYGFR95M55

# Mounting

## Nuts and screws overview



Characteristics	Clip-on nuts		Combiplas slide nut				Screws with captive washer Hexagonal head			
Usage	For Telequick mounting plates		C - shaped rail - 20/40/60 mm				All nuts			
Type	Supply	References	Rail type	Combiplas nut		Metal sliding nut		Models	Supply	References
				Supply	References	Supply	References			
M3	100	AF1EA3	-	-	-	-	-	-	-	-
M4	100	AF1EA4	C20	100	NSYBN204	100	NSYB204	M4 x 10 mm	100	AF1VA410
			C40	100	NSYBN404	100	NSYB404	M4 x 16 mm	100	AF1VA416
M5	100	AF1EA5	-	-	-	-	-	M5 x 12 mm	100	AF1VA512
M6	100	AF1EA6	C20	100	NSYBN206	-	-	M6 x 12 mm	100	AF1VA612
			C40	100	NSYBN406	-	-	M6 x 18 mm	100	AF1VA618
			C60	100	NSYBN606	100	NSYB406	M6 x 18 mm	100	AF1VA618
M8	-	-	C40	100	NSYBN408	-	-	M8 x 20 mm	100	AF1VC820
			C60	100	NSYBN608	-	-			
M10	-	-	C60	100	NSYBN610	-	-	-	-	-

References by unit. Order by multiples of the units specified in the supply.

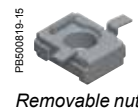
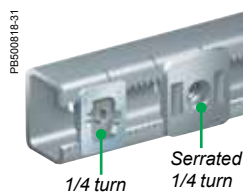

Characteristics	Mountings and nuts for serrated uprights									
Usage	2 x serrated mounting uprights for floor-standing enclosures									
Type	Mounting brackets		Supply	1/4 turn	Serrated 1/4 turn	Removable nut		Cage nut		
	Supply	Ref.	Supply	Ref.	Ref.	Supply	Ref.	Supply	Ref.	
M4	4	NSYMFB	-	-	-	-	-	-	-	
M5			-	-	-	-	-	-	-	
M6			10	NSYSNM6	NSYSNSM6	50	NSYCNM6	50	NSYCNFM6	
M8			10	NSYSNM8	NSYSNSM8	50	NSYCNM8	50	NSYCNFM8	
-	-	-	-	-	-	-	-	-	-	

References by unit. Order by multiples of the units specified in the supply.

# Mounting

## Nuts and screws overview



Torx screws			Self-tapping screw			Mountings and nuts for aluminium uprights			
Nuts and 6 mm Spacial enclosures holes						Mounting uprights for wall-mounting enclosures			
Models	Supply	References	Models	Supply	References	Sliding nuts		Brass nuts to fix the upright to the enclosures	
-	-	-	-	-	-	Supply	References	Supply	Reference
-	-	-	-	-	-	100	NSYNM4	4	NSYAMCSF
-	-	-	M5 x 13 mm	100	NSYS13M5HS	100	NSYNM5		
-	-	-	M5 x 16 mm	100	NSYS16M5HS				
T30 M6 x 16 mm	100	NSYST30M6	M6 x 16 mm	100	NSYS16M6HS	100	NSYNM6		
T30 M6 x 12 mm self-tapping	100	NSYST30M6S	-	-	-				
T40 M8 x 16 mm	100	NSYST40M8	-	-	-				
-	-	-	-	-	-				

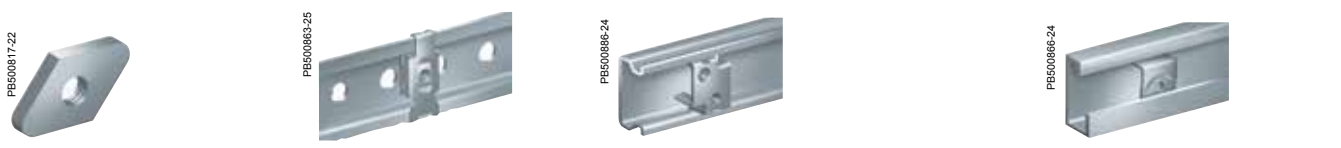

Flat nuts for standard uprights		Clip nut for symmetric DIN rail		Quarter turn nut for double profile DIN rail			Quarter turn nut for asymmetric DIN rail	
2 x standard mounting uprights for floor-standing enclosures		35 x 15 mm symmetric DIN rail		35 mm double profile DIN rail			35 mm asymmetric DIN rail	
Supply	Ref.	Supply	Ref.	Models	Supply	Ref.	Supply	Ref.
-	-	100	AF1CG4	-	-	-	100	DZ5ME5
-	-	100	AF1CG5	-	-	-	100	DZ5ME8
50	NSYFNM6	100	AF1CG6	-	-	-	100	DZ5ME9
50	NSYFNM8	-	-	-	-	-	-	-
-	-	-	-	M3 + M4	100	AF1CF34	-	-
-	-	-	-	M5 + M6	100	AF1CF56	-	-

### Multiple cable entries



Characteristics	Flexicable	Multi-A	Multi-C	Multi-R
	Full membrane cable gland plate.	FL13 & FL21 type membranes.	Circular connector-free entries.	Rectangular connector-free entries.
Material	-	TPE, SBS, SEBS and PP co-polymer - halogen free	-	-
Colour	-	RAL 7035	-	-
Cable entry material	Soft membrane cable entries	Combined	Soft membrane cable entries	
Cable glands to be fitted	No	Optional: specific cable clamp ref. <b>NSYAECPFLACA●●</b> to be used	No	No
Installation possibilities	Replaces cable gland plate (S3D) or directly on enclosure	On cable gland plate adapter or directly on enclosure	On modified cable gland plate or directly on enclosure	On cable gland plate with special cut-out or directly on enclosure
Flexibility of the installation	Full	Medium	Medium	Medium
Reversibility	Medium	Medium	Full	Full
Ingress protection rating	IP55	IP65	IP65	IP65
Cable retention	Low	High with cable clamp, (up to 18 daN)	Medium	Medium
Cable diameter (mm)	From 10 to 26	From 13 to 30	From 3 to 15.9	From 4.3 to 15.9
Cable Installation time	Fast	Medium	Fast	Fast
Quantity of cables to be fitted for a given surface	+++	++	++	++
Cable entries for cables with connectors	No	No	No	No
Cut-out dimensions (mm)	178 x 63 to 478 x 63	FL13 and FL21	Ø 50.5 Ø 63.5	112 x 36
External dimensions (mm)	From 245 x 130 to 495 x 220 or 545 x 130	216 x 84	Ø 58 to 71	146 x 14 x 58
Certificates	Tested on short-circuit effect 250 A, 25 kA following IEC 61439-1	Cable anchorage pull test: EN 50262. Long term UV-resistance: ASTM G 154-06	■ UL 94 - plastics flammability Fire resistance: V0	■ UL 94 - plastics flammability Fire resistance: V0
Flame resistance	650°C	750°C	650°C	650°C
Temperature range	-	-40 to +85°C	-	-
<b>References*</b>				
See page	278	278	279	279

\* For details, type the reference in the search engine of [www.schneider-electric.com](http://www.schneider-electric.com).  
(1) "Pop-out" membranes only.

# Cable management

## Cable entries overview

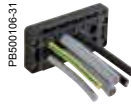

Multi-T	Multi-F	Multi-CR	Multi-H
FL21-type membranes.	FL13 & FL21 pre-configured flanges.	Cable entries with dies for cables equipped with connectors.	FL21 insulated flange with ISO knockouts.
Insulating material	Fibreglass-reinforced polypropylene and TPE - Halogen Free	-	Polycarbonate, glass-fiber reinforced
RAL 7035	RAL 7035	-	RAL 7035
No	No	Hard plastic	Yes
On cable gland plate adapter or directly on enclosure	On cable gland plate adapter or directly on enclosure	Yes, cable die <b>NSYDCE●●●</b> and <b>NSYDCE●●●●</b>	On cable gland plate adapter or directly on enclosure
Medium	Medium	Low	Low
Medium	Medium	Medium	Medium
IP66	IP65	IP54	IP65
Low	Low	High (with fastener)	High (with cable clamp)
From 6 to 60	From 16 to 50	From 3 to 31	From 12 to 25
Fast	Fast	Slow	Slow
++	++	++	++
No	No	Yes	No
FL21	From 134 x 52 to 214 x 90	36 x 112	FL21
214 x 88	From 134 x 52 to 214 x 90	146 x 58	215 x 85
UL 94 - plastics flammability Fire resistance V0	<ul style="list-style-type: none"> <li>UL 94 - plastics flammability Fire resistance HB</li> <li>Test standard EN 60529:1991 + A1</li> <li>EN 60670-1:2005,</li> <li>EN 50262:1998 EMKO-TUI (03-SEC)FI001/84.</li> <li>Semko report 816003</li> </ul>	-	UL 94 - plastics flammability Fire resistance V1
650°C	-	650°C	750°C
-	-20°C to +125°C (1)	-	<ul style="list-style-type: none"> <li>For normal operation: -40°C to +80°C</li> <li>For a short time: -40°C to +120°C</li> </ul>
280	281	281	280

# Cable management

## Cable entries overview

### Simple cable entries



Characteristics	Simple-1	Simple-2	Simple-3	Simple-4	Simple-5
	Mixed membrane entries for enclosure thickness 20/10° - 32/10° mm.	PVC adjustable cone-shaped entries for enclosure thickness 30/10° - 32/10° mm.	Quick cable entries for enclosure thickness 10/10° - 40/10° mm (5/10° - 20/10° mm for ref. <b>IMT36179</b> ).	PVC adjustable cone-shaped entries for PG tubes or for enclosure thickness 12/10° - 15/10° mm.	ISO cable gland.
Material	SBS	-	EPDM plastic	-	PA6, neoprene gasket
Colour	RAL 7035 light grey or RAL 9010 white	-	-	-	RAL 7035 grey
Cable entry material	Soft membrane		Combined		
Cable glands to be fitted	Not applicable				
Installation possibilities	On cable gland plate or directly on enclosure				
Flexibility of the installation	Low				
Reversibility	Medium				
Ingress protection rating	IP55	IP55	IP67	IP55	IP68
Cable retention	Low	Low	Medium	Low	High
Cable diameter (mm)	From 20 to 40	From 18 to 87	From 12 to 50	From 16 to 44	From 12 to 40
Cable Installation time	Fast	Fast	Fast	Fast	Slow
Quantity of cables to be fitted for a given surface	+	+	+	+	+
Cable entries for cables with connectors	No	No	No	No	No
Cut-out dimensions (mm)	Various circular hole diameters according to cable diameter				
External dimensions (mm)	-	From Ø 25 to 98	-	From Ø 25 to 52	From Ø 15 to 46
Certificates	-	-	-	-	Glow wire resistance: 960°C
Standard	-	-	-	-	Compliance with VDE, UL and CSA
Flame resistance	750°C	-	750°C	-	750°C
<b>References*</b>					
See page	284	284	285	285	284

\* For details, type the reference in the search engine of [www.schneider-electric.com](http://www.schneider-electric.com).



# Cable management

## Cable entries overview



Characteristics	Multi-cable disc	Cable-gland gasket	Blanking plug	Transport plug	
	It is possible to pass several cables through a single cable-gland using the multi-cable bushing.	-	It is screwed into the cable-gland's place.	It is installed to block the cable-gland during transport or during maintenance operations.	
Material	-	-	-	-	
Colour	-	-	-	-	
Ingress protection rating	-	-	-	-	
Standards	-	-	-	-	
Other characteristics	-	-	-	-	
Supply	-	Batch of 100 (M12 to M25), 50 (M32), 25 (M40)	Pack of 20 plugs (M12 to M15), 10 plugs (M32), 5 plugs (M40)	Pack of 20 plugs (M16 to M25), pack of 10 (M32), pack of 5 (M40)	
Ø	Number / Ø (mm)	References	References	References	
M12	-	-	IMT36151	IMT36161	-
M16	2 x Ø 4	IMT36157	IMT36152	IMT36162	IMT36167
M20	3 x Ø 4	IMT36158	IMT36153	IMT36163	IMT36168
M25	4 x Ø 5	IMT36159	IMT36154	IMT36164	IMT36169
M32	6 x Ø 5	IMT36160	IMT36155	IMT36165	IMT36170
M40	-	-	IMT36156	IMT36166	IMT36171

# Cable management

## Cable entries

### Key features when selecting a cable entry

#### 1 - Multiple cable entries or single cable entries

Your choice depends on:

- The amount of cables going through the cable entry: generally for 3 or more cables, choose a multiple cable entry. It will make your installation faster and more economical.

In other words, your final bill will not necessarily be lower with single cable entries!

- Flexibility of installation: for high flexibility, the multiple cable entry is the right choice.



Multiple



Single

#### 2 - Entry cable material

- **Soft membranes** allow cables to be easily pushed through, but still offer a good IP rating, protecting from moisture as well as physical intrusions. Cable retention force, however, is lower than with other alternatives.



Push the membrane into a standard hole.



Make a small hole in the membrane.



Push the cable or tube through the guide hole.



Pull the cable or tube back some 20 mm to lock it.

- **Hard plastic** needs specific tools to create the opening (drill or knife) but, thanks to the cable gland, offers a very high retention force. Another use of this solution is for public places, since the hard surface prevents objects being pushed in.

- **Combined:** the material of the cable entry plate is hard plastic, but the cable is pushed through a soft membrane. In this case you have the advantages both of soft membranes (easy and fast installation, flexibility) and hard plastic membranes (high retention force, when using specific cable clamps).



#### 3 - Cable glands to be fitted

- Some multiple cable entries require a cable gland to be able to retain the cables and ensure the degree of protection.



### 4 - Installation possibilities

There are 4 ways to install your cable entries on the enclosure:

■ **By replacing the cable gland plate:** the standard cable gland plate of your S3D wall-mounting enclosure is unscrewed and replaced by the cable entry. A gasket between enclosure and cable entry will provide full water and dust tightness.







■ **On modified cable gland plate:** the standard cable gland plate is unscrewed and machined. A cut-out is created in it.

■ **On cable gland plate adapter:** this plate, which has the outer dimensions of a standard cable gland plate, has one or more pre-cut cut-outs of standard dimensions (FL13 and FL21).

On steel wall-mounting enclosures, the plate can replace the standard cable gland plate once the cable entry is fitted into it. On polyester enclosures, a cut-out must be created. Schneider Electric provides this service: a precise laser cut-out is factory-created upon request.

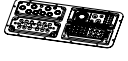
On steel floor-standing enclosures, you may either use the specific cable gland roof or create a cut-out (see expert's tip 1, page 277).

#### Cable gland plate adapters

Enclosure range	1 membrane	2 membranes	3 membranes	4 membranes
Spacial S3D	PB500604-16  NSYTL•FL	PB500604-15  NSYTL•2FL	-	DB300718-15  NSYTLG4FL
Spacial SF	PB502708-10  NSYSFLR●● NSYSFLR●●●	PB502709-12  NSYSFLR●● NSYSFLR●●●	PB500597-15  NSYSFLR●●●	-

■ **Directly on the enclosure:** a cut-out is created on the enclosure's side according to the cable entry's dimensions (see expert's tip 1, page 277).

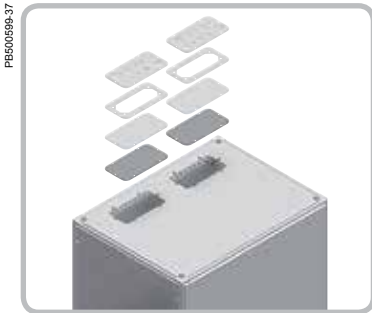
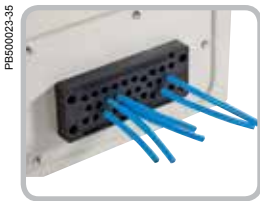

#### Zoom on...

FL13 and FL21 are standard cut-out dimensions frequently used in northern European countries and also used by our enclosures for several years now.

# Cable management

## Cable entries

PE602710-32



Full flexibility

PE600946-35



Medium flexibility

### 5 - Flexibility of the installation

■ **Full flexibility:** this means that cables can be added/removed easily, changing:

- quantity
- diameter
- position

(see expert's tip 2, page 277)

■ **Medium flexibility:**

- the amount, diameter or position of cables can be changed to a limited extent.

■ **Low flexibility:**

- it is not possible to change the above parameters.

### 6 - Reversibility

■ **Full reversibility:** this means that cables can be added/ removed easily without losing their initial characteristics, such as water tightness.

■ **Medium reversibility:** for soft membranes, once the cable has been removed, there may be a loss of IP depending on the size of the cable and the cut. For hard plastic entries or combined material entries, initial characteristics are regained by adding plugs.

■ **Low reversibility:** the cable entry must be completely replaced in order to regain the initial characteristics.

### 7 - Degree of protection (IP)

If an enclosure is to be used in a clean, dry and well insulated environment, lower levels of IP may be acceptable (IP54 or IP55).

In a dusty environment you may require higher IP levels, such as IP65 or IP68 (see expert's tip 4, page 277).

### 8 - Cable retention

Choose the right level of cable retention according to your needs. For locations accessible to the public, preferably choose a high level of cable retention.

### 9 - Cable diameter

Choose the cable entry seal according to the cable diameter.

Take into account cable diameter tolerances.

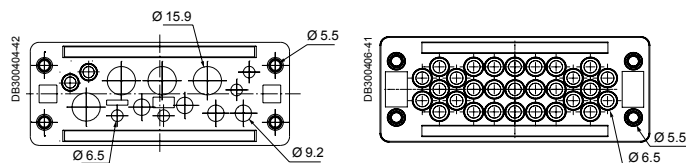

### 10 - Cable installation time

Each cable entry has different installation characteristics. Some can be installed easily and quickly thanks to the soft membrane. Take this into account depending on labour costs in your region.

DB300413-53

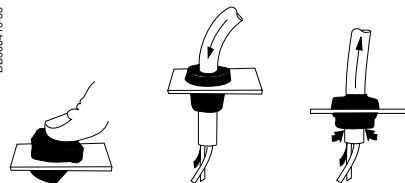

# Cable management

## Cable entries



PB502711-30

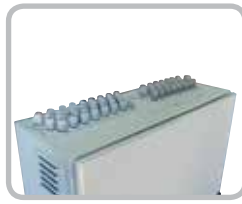

PB502712-31

### 11 - Quantity of cables to be fitted for a given surface

For some installations, a large quantity of cables must go through the cable entry. Some cable entries can receive a high density of cables, which can result in more economical installation (fewer cable entries to be bought).

For small enclosures, it may simply be impossible to install too many cable entries due to the available space on the enclosure's wall (see expert's tip 3, page 277).



PB502713-34

### 12 - Cable entries for cables with connectors

Some cables have large connectors which cannot be pushed through tight cable clamps or cable seals.

These cable entries have the unique advantage of not requiring the cable to be cut, thanks to the snap-fitting system.

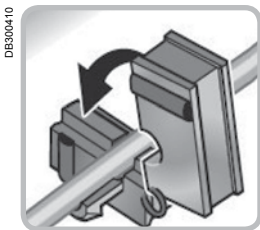

DB300410

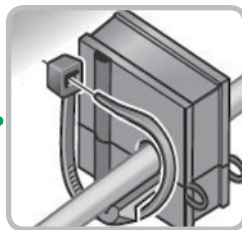

DB300410

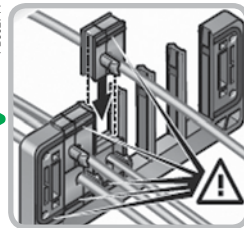

PB502714

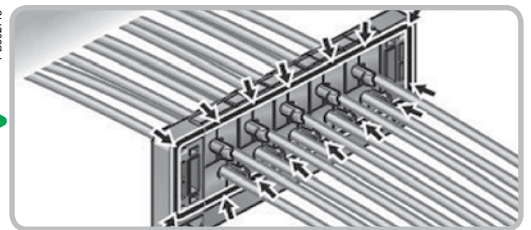

PB502715

A high cable retention force is provided thanks to the integrated cable fastener.

## Expert's tip

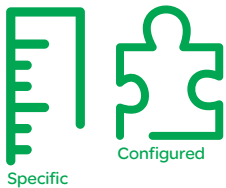

Specific

Configured

❶ Some cable entries require cut-outs to be machined on the enclosure or cable gland plate. Our customized offer provides this service. The quality of your enclosure will therefore be guaranteed since the painting operation is performed after creating the cut-outs.

❷ When the cable entry has been defined, the next step is cable management inside the enclosure. For correct thermal management, all wires must be fitted and attached so as not to create an obstacle for correct air flow. Consult our Universal Enclosures catalogue for cable management accessories (such as cable ducts) and consumables (such as cable ties).

❸ Installing a cable entry with full flexibility is the solution when a large series of enclosures is being prepared for different types of installations. By using one combination of enclosure-cable entry, you can cover a large variety of installations!

❹ When your environment requires a high level of IP for your installation, make sure you have an appropriate thermal management system to avoid condensation or overheating problems. Consult our Thermal Management offer in our Universal Enclosures catalogue and our Control Panel Technical Guide related to this issue.



PB502716-53

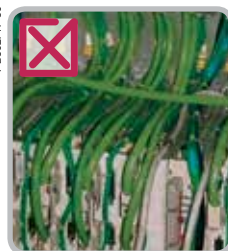

PB502717-50

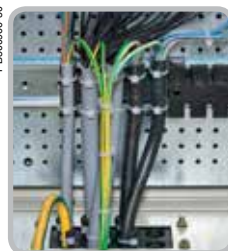

PB500868-50



PB500865-44

### Dimensions



FL 13



FL 21

Characteristics	FlexiCable cable entries	Multi-A																																																																																																																												
See page	270	270																																																																																																																												
Supply	<ul style="list-style-type: none"> <li>1 metallic frame with pre-mounted membrane</li> <li>1 gasket</li> <li>Hardware</li> </ul>	-																																																																																																																												
	<table border="1"> <thead> <tr> <th rowspan="2">Type</th> <th colspan="2">Plate dimensions (mm)</th> <th rowspan="2">Effective cable entrance dimensions (mm)</th> <th rowspan="2">References</th> </tr> <tr> <th>Width (A)</th> <th>Depth (B)</th> </tr> </thead> <tbody> <tr> <td>C</td> <td>245</td> <td>130</td> <td>178 x 63</td> <td>NSYTLCEME</td> </tr> <tr> <td>D</td> <td>345</td> <td>130</td> <td>278 x 63</td> <td>NSYTLDEME</td> </tr> <tr> <td>E</td> <td>445</td> <td>130</td> <td>378 x 63</td> <td>NSYTLDEME</td> </tr> <tr> <td>F</td> <td>545</td> <td>130</td> <td>478 x 63</td> <td>NSYTLFME</td> </tr> <tr> <td>G</td> <td>495</td> <td>220</td> <td>428 x 153</td> <td>NSYTLGME</td> </tr> <tr> <td>D (1)</td> <td>345</td> <td>130</td> <td>-</td> <td>2 x NSYTLDEME</td> </tr> <tr> <td>E (1)</td> <td>445</td> <td>130</td> <td>-</td> <td>2 x NSYTLDEME</td> </tr> </tbody> </table>	Type	Plate dimensions (mm)		Effective cable entrance dimensions (mm)	References	Width (A)	Depth (B)	C	245	130	178 x 63	NSYTLCEME	D	345	130	278 x 63	NSYTLDEME	E	445	130	378 x 63	NSYTLDEME	F	545	130	478 x 63	NSYTLFME	G	495	220	428 x 153	NSYTLGME	D (1)	345	130	-	2 x NSYTLDEME	E (1)	445	130	-	2 x NSYTLDEME	<table border="1"> <thead> <tr> <th rowspan="2">Dimensions (mm)</th> <th rowspan="2">No. of cable entries</th> <th colspan="8">Diameter of the cable entry (Ø mm)</th> <th rowspan="2">References</th> </tr> <tr> <th>13</th> <th>14</th> <th>15</th> <th>16</th> <th>18</th> <th>21</th> <th>30</th> </tr> </thead> <tbody> <tr> <td colspan="11"><b>Type FL13</b></td> </tr> <tr> <td rowspan="2">20</td> <td rowspan="2">135</td> <td rowspan="2">47</td> <td>7</td> <td>-</td> <td>-</td> <td>4</td> <td>-</td> <td>-</td> <td>3</td> <td>-</td> <td>NSYAECPPFLA7</td> </tr> <tr> <td>10</td> <td>6</td> <td>-</td> <td>-</td> <td>4</td> <td>-</td> <td>-</td> <td>-</td> <td>NSYAECPPFLA10</td> </tr> <tr> <td colspan="11"><b>Type FL21</b></td> </tr> <tr> <td rowspan="2">25</td> <td rowspan="2">215</td> <td rowspan="2">86</td> <td>25</td> <td>-</td> <td>16</td> <td>-</td> <td>-</td> <td>6</td> <td>-</td> <td>3</td> <td>NSYAECPPFLA25</td> </tr> <tr> <td>33</td> <td>-</td> <td>24</td> <td>-</td> <td>-</td> <td>9</td> <td>-</td> <td>-</td> <td>NSYAECPPFLA33</td> </tr> </tbody> </table>	Dimensions (mm)	No. of cable entries	Diameter of the cable entry (Ø mm)								References	13	14	15	16	18	21	30	<b>Type FL13</b>											20	135	47	7	-	-	4	-	-	3	-	NSYAECPPFLA7	10	6	-	-	4	-	-	-	NSYAECPPFLA10	<b>Type FL21</b>											25	215	86	25	-	16	-	-	6	-	3	NSYAECPPFLA25	33	-	24	-	-	9	-	-	NSYAECPPFLA33
Type	Plate dimensions (mm)		Effective cable entrance dimensions (mm)	References																																																																																																																										
	Width (A)	Depth (B)																																																																																																																												
C	245	130	178 x 63	NSYTLCEME																																																																																																																										
D	345	130	278 x 63	NSYTLDEME																																																																																																																										
E	445	130	378 x 63	NSYTLDEME																																																																																																																										
F	545	130	478 x 63	NSYTLFME																																																																																																																										
G	495	220	428 x 153	NSYTLGME																																																																																																																										
D (1)	345	130	-	2 x NSYTLDEME																																																																																																																										
E (1)	445	130	-	2 x NSYTLDEME																																																																																																																										
Dimensions (mm)	No. of cable entries	Diameter of the cable entry (Ø mm)								References																																																																																																																				
		13	14	15	16	18	21	30																																																																																																																						
<b>Type FL13</b>																																																																																																																														
20	135	47	7	-	-	4	-	-	3	-	NSYAECPPFLA7																																																																																																																			
			10	6	-	-	4	-	-	-	NSYAECPPFLA10																																																																																																																			
<b>Type FL21</b>																																																																																																																														
25	215	86	25	-	16	-	-	6	-	3	NSYAECPPFLA25																																																																																																																			
			33	-	24	-	-	9	-	-	NSYAECPPFLA33																																																																																																																			
	<p>Mount FlexiCable on your S3D enclosure.</p> <p>Create a hole with a screw driver.</p> <p>Push the cable through FlexiCable and finish-off your installation.</p>	<p>NSYAECPPFLA7</p> <p>NSYAECPPFLA10</p> <p>NSYAECPPFLA25</p> <p>NSYAECPPFLA33</p>																																																																																																																												

(1) Enclosure with 2 cable-gland plates.

### Dimensions

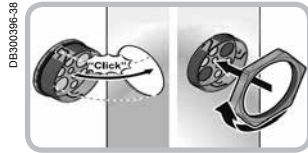

Multi-C									Multi-R								
270									270								
10 units. Reference by unit. Order by multiples of 10 (10, 20, 30...)									1 unit								
No. of openings	Dimensions/ cut-out Ø	Diameter of the cable entry (Ø mm)						References	No. of openings	Dimensions/ cut-out Ø	Diameter of the cable entry (Ø mm)						References
		3-5.5	3-6.5	3.6-6.5	5-9.2	6-10	9.6-15.9				4.3-8.1	3-6.5	5-9.2	8-12.5	9.6-15.9		
4	50.5	-	-	-	-	3	1	NSYTSAM504SE	14	112 x 36	-	6	4	-	-	NSYSA2414SE	
8	50.5	-	-	7	-	1	-	NSYTSAM508SE	17	112 x 36	-	-	17	-	-	NSYSA2417SE	
8	63.5	-	2	-	4	-	2	NSYTSAM638SE	22	112 x 36	-	16	4	2	-	NSYSA2422SE	
13	63.5	6	-	6	-	1	-	NSYTSAM6313SE	23	112 x 36	23	-	-	-	-	NSYSA2423SE	
									29	112 x 36	-	29	-	-	-	NSYSA2429SE	

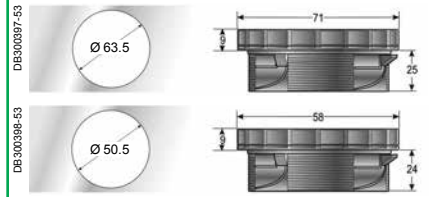

Position of the holes on the circular cable entries with diameters 50 and 63 mm

- DB300400-12  
 NSYTSAM504SE
- DB300401-12  
 NSYTSAM508SE
- DB300402-12  
 NSYTSAM638SE
- DB300403-12  
 NSYTSAM6313SE

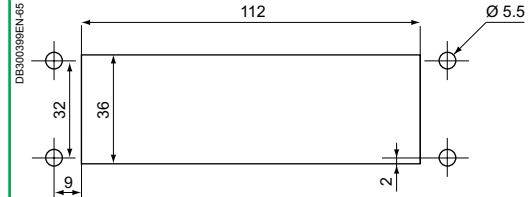

Diagrams of dimensions and positions of the holes on a rectangular cable entry

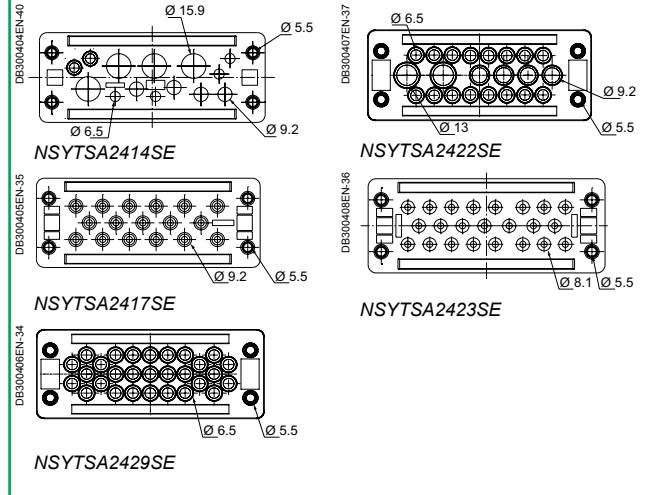

# Cable management

## Cable entries

### Dimensions



Characteristics	Multi-T	Multi-H
See page	271	271
Supply	-	-
	<b>No. of cable entries</b>	<b>Dimensions (mm)</b>
	<b>Diameter of the cable entry (Ø mm)</b>	<b>Reference</b>
	5-7   6-10   8-12   8-16   10-14   12-18   14-20   17-32   20-26   24-54   30-60	L1   L2   H
	<b>Type FL21</b>	<b>Type FL21</b>
	0   7   27   37	215   85   10
	-   -   -   -   -   -   -   -   -   -   -	NSYSAKFL
	-   -   4   -   4   13   4   -   2   -   -	NSYAECFL25
	-   4   14   -   16   2   -   1   -   -	NSYAECFL35
	 NSYAECFLBP	 NSYAECFL7
	 NSYAECFL25	 NSYAECFL35
		 ⊕ M16 or M25 ● M12 ⊕ M12 or M20

\* Metallic plate.



### Dimensions

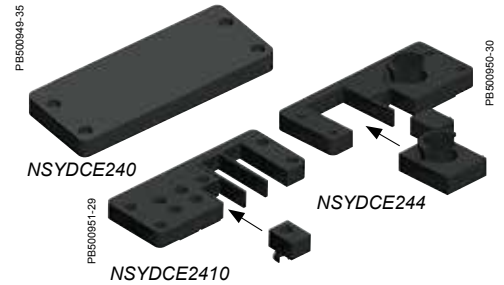

Multi-F										Multi-CR		
271										271		
-										1 die and mounting elements		
Dimensions (mm)				Diameter of the cable entry (Ø mm)				References		Connector cut-out type	Number of cable entries	References
L1	L2	H	H2	4-10 mm (1)	M16 (5-10 mm) (2)	M20 (6-13 mm) (2)	M25 (8-17 mm) (2)	M32 or M40 or M50 (3)				
<b>Type FL13</b>												
134	52	6.5	~ 35	10	-	1	-	-	NSYAECPKFL11	16	8	NSYDCE168
<b>Type FL21</b>												
214	90	9	~ 35	-	2	2	2	1	NSYAECPKFL7A	24	0	NSYDCE240
214	90	9	~ 35	-	-	6	-	1	NSYAECPKFL7B	24	4	NSYDCE244 (4)
214	90	9	~ 35	-	4	2	4	-	NSYAECPKFL10	24	10	NSYDCE2410

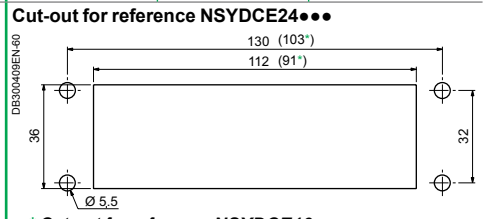
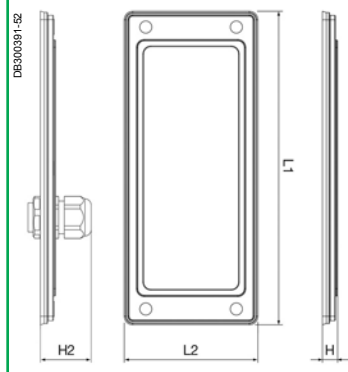

\* Cut-out for reference NSYDCE16●●●.

#### Split seals for cable entries equipped with connectors

- Split seals suited to the diameter of the cable to be mounted on the cable-entry dies for the connectors. Ref. NSYDCE●●●.
- **Supply:** 10 units. Reference per unit. To be ordered in multiples of 10 (10, 20, 30, etc.).

For cables Ø (mm)**	References
0	NSYCEJD
3-4	NSYCEJD3
5-6	NSYCEJD5
7-8	NSYCEJD7
9-10	NSYCEJD9
11-12	NSYCEJD11
13-14	NSYCEJD13
16-17	NSYCEJD16**
18-19	NSYCEJD18**
20-21	NSYCEJD20**
22-23	NSYCEJD22**
24-25	NSYCEJD24**
26-27	NSYCEJD26**
28-29	NSYCEJD28**
30-31	NSYCEJD30**

\*\* Large seal, 24/4 die only.

(1) "Pop-out" membranes only.  
 (2) "Pop-out" membranes or cable gland installation.  
 (3) Knock out system.  
 (4) NSYDCE244 accepts 4 entries: 2 large seals and 2 small seals.

# Cable management

## Cable entries

### Dimensions

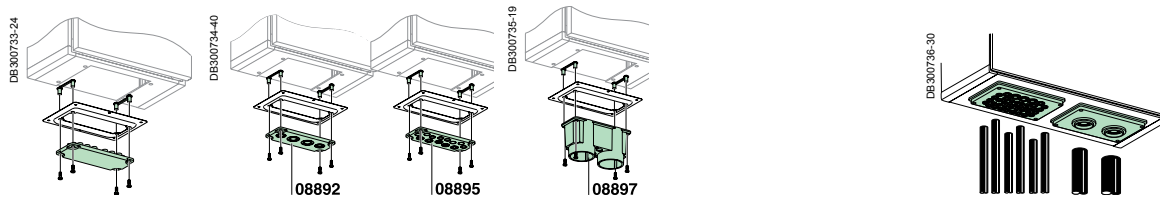

Characteristics		Prisma								
Type	FL21				225 x 137 mm opening					
	Plain	Pre-drilled	Membrane		Pre-drilled					
	Solid cable-gland plates.	Suitable for receiving cable glands with metric pitch.	Membrane to be drilled according to the required diameter.		Suitable for receiving cable glands with metric pitch.					
See page	271									
	Reference	References	No. entries	Amount of entries per Ø	Cable diameter comprised between	Ref.	References			
	08881	2 x M20 or M32 + 2 x M25 or M40	08892	2	2	28	60	08897	With 39 entries from 7 to 26	08898*
		5 x M16 or M25 + 8 x M20	08895						With 2 entries from 33 to 72	08899

\* Reference 08898 is made up of:  
 3 cables with diameters from 14 to 26.  
 4 cables with diameters from 10 to 20.  
 32 cables with diameters from 7 to 16.

### Accessories for Multi-A



2 x 30 + 3 x 18 + 5 x 14 mm.

Characteristics	Cable clamp for improved cable retention	Blanking plugs																									
	Installation on FL 21 membrane type "A" for cable entrance to block cables when installed. It can be easily removed.	<ul style="list-style-type: none"> <li>Installation on FL 21 membrane type "A" for cable entrance to fill the opening used.</li> <li>Set of 2 plugs for diameter 30 mm, 3 plugs for diameter 18 mm and 5 plugs for diameter 14 mm.</li> </ul>																									
Material	PA6 - halogen free	LDPE - halogen free																									
Installation	<ol style="list-style-type: none"> <li>Push the cable through the membrane entrance to the desired position</li> <li>Put the cable clamp around the cable and slide it into the cable entry</li> <li>Push the cable clamp fully into the membrane entrance and the cable will be fixed</li> </ol>	-																									
Other characteristics	Temperature range: -40 to +85°C	Temperature range: -30 to +50°C																									
	<table border="1"> <thead> <tr> <th>Cable clamp outer diameter (mm)</th> <th>Membrane entrance diameter (mm)</th> <th>Cable diameter range (mm)</th> <th>Supply</th> <th>References</th> </tr> </thead> <tbody> <tr> <td>15</td> <td>14</td> <td>7-9</td> <td>Set of 8</td> <td>NSYAECPLACA14</td> </tr> <tr> <td>18</td> <td>18</td> <td>9-11</td> <td>Set of 6</td> <td>NSYAECPLACA18</td> </tr> <tr> <td>20</td> <td>18</td> <td>10-12</td> <td>Set of 6</td> <td>NSYAECPLACA20</td> </tr> <tr> <td>30</td> <td>30</td> <td>20-23</td> <td>Set of 3</td> <td>NSYAECPLACA30</td> </tr> </tbody> </table>	Cable clamp outer diameter (mm)	Membrane entrance diameter (mm)	Cable diameter range (mm)	Supply	References	15	14	7-9	Set of 8	NSYAECPLACA14	18	18	9-11	Set of 6	NSYAECPLACA18	20	18	10-12	Set of 6	NSYAECPLACA20	30	30	20-23	Set of 3	NSYAECPLACA30	Reference NSYAECPLAP
Cable clamp outer diameter (mm)	Membrane entrance diameter (mm)	Cable diameter range (mm)	Supply	References																							
15	14	7-9	Set of 8	NSYAECPLACA14																							
18	18	9-11	Set of 6	NSYAECPLACA18																							
20	18	10-12	Set of 6	NSYAECPLACA20																							
30	30	20-23	Set of 3	NSYAECPLACA30																							

\* Secure your installation with an easy solution for cable anchorage.

### Dimensions

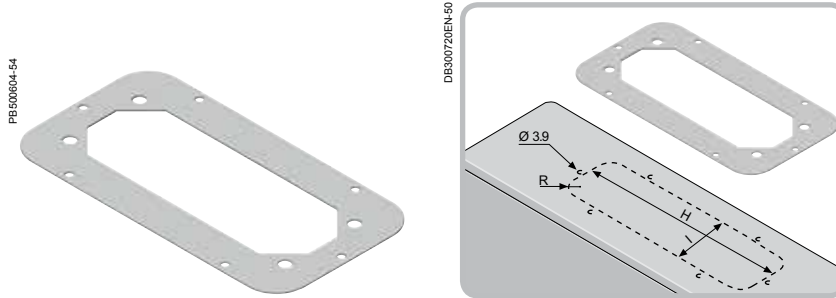

Characteristics		Steel adapter plate for FL13 and FL21 membranes				
		Allows the mounting of FL13 and FL21 membranes on every type of enclosure.				
Ingress protection rating		IP55				
Supply		Delivered with mounting screws and gasket				
Type		Plate dimensions (mm)		Cut-out dimensions (mm)		References
FL13	B	A	B	H	I	NSYTLBFL (1)
FL21	C	245	80	212	47	NSYTLCFL (1)
	D	245	130	212	97	NSYTLDFL (1)
	E	345	130	312	97	NSYTLDFL (1)
	F	445	130	412	97	NSYTLDFL (1)
	G	545	130	512	97	NSYTLFFL (1)
		495	220	462	187	NSYTLF2FL (2)
						NSYTLGFL (1)
						NSYTLG2FL (2)
						NSYTLG4FL (3)

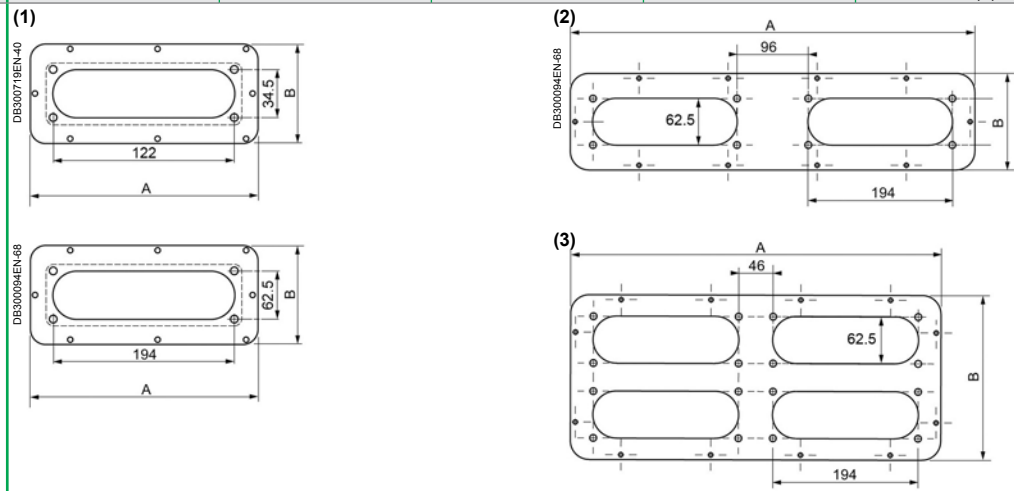

Our membrane can be easily adapted to fit onto all our metallic enclosures using the adapter plate.

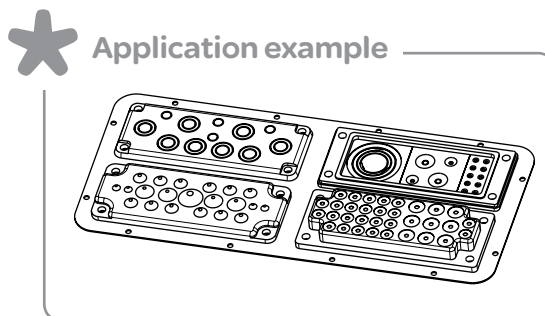

### Dimensions



Characteristics	Mixed membrane entries for IP55 direct cable entries	PVC adjustable cone-shaped entries																																																																																							
See page	272	272																																																																																							
Supply	Minor packaging of 10 pieces	-																																																																																							
	<table border="1"> <thead> <tr> <th rowspan="2">Ø (mm)</th> <th rowspan="2">Cable / conduit</th> <th colspan="2">References</th> </tr> <tr> <th>RAL 9010</th> <th>RAL 7035</th> </tr> </thead> <tbody> <tr> <td>23</td> <td>4 - 20</td> <td>IMT36172</td> <td>ISM71071</td> </tr> <tr> <td>29</td> <td>4 - 25</td> <td>IMT36173</td> <td>ISM71072</td> </tr> <tr> <td>36</td> <td>4 - 32</td> <td>-</td> <td>ISM71073</td> </tr> <tr> <td>44</td> <td>4 - 40</td> <td>-</td> <td>ISM71074</td> </tr> </tbody> </table>	Ø (mm)	Cable / conduit	References		RAL 9010	RAL 7035	23	4 - 20	IMT36172	ISM71071	29	4 - 25	IMT36173	ISM71072	36	4 - 32	-	ISM71073	44	4 - 40	-	ISM71074	<table border="1"> <thead> <tr> <th rowspan="2">Fig.</th> <th rowspan="2">Ø A</th> <th rowspan="2">Ø B*</th> <th rowspan="2">Ø C</th> <th rowspan="2">Ø D</th> <th rowspan="2">E</th> <th rowspan="2">F</th> <th colspan="2">Capacity</th> <th rowspan="2">Supply</th> <th rowspan="2">References</th> </tr> <tr> <th>Cable Ø</th> <th>Tube</th> </tr> </thead> <tbody> <tr> <td rowspan="3">1</td> <td>25</td> <td>21.5</td> <td>18</td> <td>5</td> <td>3.2</td> <td>13</td> <td>5 to 18</td> <td>PG 9 to 11</td> <td>50</td> <td>NSYECPC3</td> </tr> <tr> <td>33</td> <td>29.5</td> <td>26</td> <td>5</td> <td>3.2</td> <td>20</td> <td>5 to 26</td> <td>PG 9 to 16</td> <td>25</td> <td>NSYECPC5</td> </tr> <tr> <td>43</td> <td>38.5</td> <td>36</td> <td>5</td> <td>3.2</td> <td>22</td> <td>5 to 36</td> <td>PG 9 to 21</td> <td>25</td> <td>NSYECPC6</td> </tr> <tr> <td rowspan="2">2</td> <td>70</td> <td>63</td> <td>60</td> <td>28</td> <td>3</td> <td>20</td> <td>28 to 60</td> <td>PG 21 to 48</td> <td>10</td> <td>NSYECPC9</td> </tr> <tr> <td>98</td> <td>90</td> <td>87</td> <td>28</td> <td>3</td> <td>23</td> <td>28 to 87</td> <td>PG 21 to 48</td> <td>10</td> <td>NSYECPC15</td> </tr> </tbody> </table>	Fig.	Ø A	Ø B*	Ø C	Ø D	E	F	Capacity		Supply	References	Cable Ø	Tube	1	25	21.5	18	5	3.2	13	5 to 18	PG 9 to 11	50	NSYECPC3	33	29.5	26	5	3.2	20	5 to 26	PG 9 to 16	25	NSYECPC5	43	38.5	36	5	3.2	22	5 to 36	PG 9 to 21	25	NSYECPC6	2	70	63	60	28	3	20	28 to 60	PG 21 to 48	10	NSYECPC9	98	90	87	28	3	23	28 to 87	PG 21 to 48	10	NSYECPC15
Ø (mm)	Cable / conduit			References																																																																																					
		RAL 9010	RAL 7035																																																																																						
23	4 - 20	IMT36172	ISM71071																																																																																						
29	4 - 25	IMT36173	ISM71072																																																																																						
36	4 - 32	-	ISM71073																																																																																						
44	4 - 40	-	ISM71074																																																																																						
Fig.	Ø A	Ø B*	Ø C	Ø D	E	F	Capacity		Supply	References																																																																															
							Cable Ø	Tube																																																																																	
1	25	21.5	18	5	3.2	13	5 to 18	PG 9 to 11	50	NSYECPC3																																																																															
	33	29.5	26	5	3.2	20	5 to 26	PG 9 to 16	25	NSYECPC5																																																																															
	43	38.5	36	5	3.2	22	5 to 36	PG 9 to 21	25	NSYECPC6																																																																															
2	70	63	60	28	3	20	28 to 60	PG 21 to 48	10	NSYECPC9																																																																															
	98	90	87	28	3	23	28 to 87	PG 21 to 48	10	NSYECPC15																																																																															
	<p>DB300411-119 IMT36172 IMT36173 ISM71073 ISM71074 ISM71071 ISM71072 DB300412-88</p>	<p>DB300426-55 Fig. 1 Fig. 2</p>																																																																																							

\* Drill-hole for mounting.



Characteristics	ISO cable-gland					
See page	The cable-gland (ref. <b>IMT36150</b> ) is especially recommended for security circuits.					
Supply	<ul style="list-style-type: none"> <li>The cable-glands are supplied with nuts</li> <li>Pack of 20 (M12 to M20), 10 (M25 and M32), 5 (M40)</li> </ul>					
Ø	Ø min / max (mm)	drill Ø (2)	TD	TL		References
M12	3 / 6.5	12.2 (0 + 0.2)	12	6	15	ISM71501
M16	4 / 8	16.2 (0 + 0.2)	16	8	19	ISM71502
M20	6 / 12	20.2 (0 + 0.2)	20	10	24	ISM71503
M20 (1)	6 / 12	20.2 (0 + 0.2)	20	10	24	IMT36150
M25	11 / 17	25.2 (0 + 0.2)	25	8	29	ISM71504
M32	15 / 21	32.2 (0 + 0.3)	32	10	36	ISM71505
M40	19 / 28	40.5 (0 + 0.3)	40	10	46	ISM71506
	<p>DB300414-16</p>					

(1) Cable-gland with high resistance to fire.

(2) In brackets: tolerance.

### Dimensions



IP67 quick cable entries						PVC adjustable cone-shaped entries									
272						272									
-						-									
ISO	Ø (mm)		Supply	References		Ø A	Ø B*	Ø C	Ø D	E	F	Capacity		Supply	References
	Drill hole	Cable										Cable Ø	Tube		
M12	12.5	3 - 5	50	<b>IMT36179</b>	25	19.5	16	3	1.2	21	3 to 16	PG 9	50	<b>NSYEC1</b>	
M16	16	5 - 7	50	<b>IMT36180</b>				6	1.2	21	6 to 16	PG 11	50	<b>NSYEC2</b>	
M20	20.3	7 - 10	50	<b>IMT36181</b>	27	21.5	18	7	1.2	23	7 to 18	PG 13.5	50	<b>NSYEC3</b>	
M25	25.3	10 - 14	50	<b>IMT36182</b>	29.5	23.5	20	8	1.2	26	8 to 20	PG 16	25	<b>NSYEC4</b>	
M32	32.4	14 - 20	50	<b>IMT36183</b>	35	29.5	26	10	1.2	27	10 to 26	PG 21	25	<b>NSYEC5</b>	
M40	40.7	20 - 26	25	<b>IMT36184</b>	42	38.5	35	12	1.5	30	12 to 35	PG 29	25	<b>NSYEC6</b>	
M50	50.7	26 - 35	25	<b>IMT36185</b>	52	48.5	44	13	1.5	30	13 to 44	PG 36	25	<b>NSYEC7</b>	

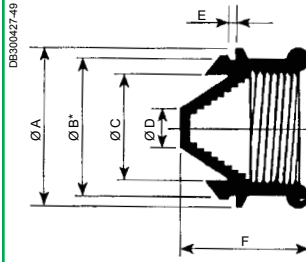
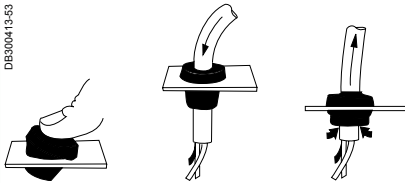

\* Drill-hole for mounting.

# Cable management

## Cable holding

**SM SF SMX SFX**

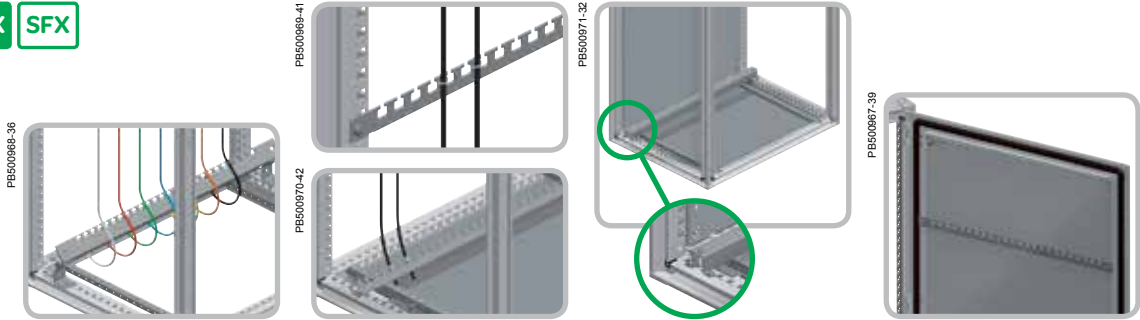

Characteristics	Lower cable-guide cross-rail	Cable-guide cross-rails for framework	L-rail for mounting cables	Door cable-guide cross-rail
	<ul style="list-style-type: none"> <li>It allows quick mounting of cables entering and exiting the enclosure.</li> <li>Depth adjustable every 25 mm.</li> </ul>	Support types: <ul style="list-style-type: none"> <li>Angle support at 90°: for vertical cable mounting.</li> <li>Angle support at 120°: for mounting cables near the cable entry.</li> </ul>	<ul style="list-style-type: none"> <li>Rail for mounting cables entering from the bottom.</li> <li>Adjustable depth with a pitch of 25 mm.</li> <li>It is not possible to mount it on a plinth cross rail.</li> </ul>	<ul style="list-style-type: none"> <li>Recommended for mounting cables in the internal equipment of the door.</li> <li>Height adjustable every 25 mm.</li> </ul>
Material	Galvanised steel	Zinc-coated steel	Zinc-coated steel	Zinc-coated steel
Mounting	<ul style="list-style-type: none"> <li><b>Spacial SF</b>: for suitable enclosures with widths of 1200 and 1600 mm, use the adaptation kit for 2-door suitable enclosures, see page 249</li> <li><b>Spacial SM</b>: for floor-standing enclosures with a width of 1200 mm, a top/bottom mounting rail installed in central position is required</li> <li><b>Spacial SFX</b>: no adaptation piece is required for the 1200 mm suitable enclosures</li> <li><b>Spacial SMX</b>: no adaptation piece is required for the 1600 mm floor-standing enclosures</li> </ul>	<ul style="list-style-type: none"> <li><b>Spacial SF and SFX</b>: support for direct mounting on the framework, cross-rails or rails</li> <li><b>Spacial SM</b>: mounting on the bottom mounting rail, or on the floor-standing enclosure by means of adaptation rails and 40 mm universal cross-rails (1 row) in vertical position</li> <li><b>Spacial SMX</b>: mounting on the bottom mounting rail and 40 mm universal cross-rails (1 row) in vertical position</li> </ul>	<ul style="list-style-type: none"> <li><b>Spacial SF and SFX</b>: mounting to the bottom frame, above the cable entry, or else to the plinth, using the plinth cross rails, see page 103</li> <li><b>Spacial SM and SMX</b>: mounting to the bottom adjustment rails, above the cable entry, or else to the plinth, using the plinth cross rails, see page 103</li> <li>The cables are fixed to the rail by means of metal clamps</li> </ul>	<ul style="list-style-type: none"> <li>Direct mounting on the reinforcement frame</li> </ul>
Supply	1 cable-guide cross-rail and mounting elements	2 supports and mounting elements	One rail, two mounting supports and mounting elements	2 cable-guide cross-rails and mounting elements
<b>Dimensions (mm)</b>	<b>References</b>			
<b>Width (B)</b>		<b>Support angle</b>		
500	-	-	-	<b>NSYSDGCR5</b>
600	<b>NSYCFP60</b>	90° 120°	<b>NSYCF596</b> <b>NSYCF5126</b>	<b>NSYFCG60</b> <b>NSYSDGCR6</b>
800	<b>NSYCFP80</b>	90° 120°	<b>NSYCF598</b> <b>NSYCF5128</b>	<b>NSYFCG80</b> <b>NSYSDGCR8</b>
1000	<b>NSYCFP100</b>	-	-	<b>NSYFCG100</b> <b>NSYSDGCR10</b>
1200	2 x <b>NSYCFP60</b>	-	-	<b>NSYFCG120</b>
1600	2 x <b>NSYCFP80</b>	-	-	<b>NSYFCG160</b>

# Cable management

## Cable holding

S3D S3X



PB50086-48



PB50033-37

Characteristics	Plastic cable support			Door cable-guide cross-rails for wall-mounting enclosures	
	It clips or screws onto 35 mm symmetric rails or a C-shaped rail.			<ul style="list-style-type: none"> <li>They are installed on wall-mounting enclosures with heights from 400 mm for Spacial S3D and 500 mm for Spacial S3X.</li> <li>They make it easy to equip the inside of the door.</li> <li>Installation cable ties, see page 288.</li> </ul>	
Mounting	Quick and easy mounting of cables using cable ties			<ul style="list-style-type: none"> <li>They are fixed to the door reinforcement frame by 2 self-tapping screws. The angle can be directed towards the body of the enclosure or towards the door</li> </ul>	
Supply	10 units. Reference by unit. Order by multiples of 10 (10, 20, 30...)			2 cable-guide cross-rails and mounting elements	
Dimensions (mm)	Support dimensions (mm)	Maximum no. of cables	References	Door dimensions (mm)	References
	Width			Width	
	75	5	NSYSCCDINLG75	400	NSYTFPCR4
	140	9	NSYSCCDINLG140	500	NSYTFPCR5
				600	NSYTFPCR6
				800	NSYTFPCR8
				1000	NSYTFPCR10

DB300418EN-59

DB300420-25

# Cable management

## Cable ties

### Cintura cable ties

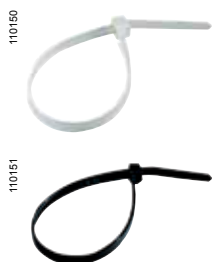

Cable tie for safe and fast clamping of cables, conduits and tubing. Delivered in a sealed packaging to ensure performance, irrespective of storage conditions.

■ **Material:** PA 6.6.

Max. clamping (mm)	Colour	Length (mm)	Qty per package	References
<b>Cable tie width 2.5 mm</b>				
Ø 18	Clear	100	1000	ENN46902
	Black			ENN46952
Ø 30	Clear	120	1000	ENN46904
	Black			ENN46954
Ø 50	Clear	200	1000	ENN46906
	Black			ENN46956
<b>Cable tie width 3.6 mm</b>				
Ø 33	Clear	140	1000	ENN46908
	Black			ENN46958
Ø 50	Clear	200	1000	ENN46939
	Black			ENN46960
Ø 76	Clear	295	100	ENN46910
	Black			ENN46960
Ø 102	Clear	370	100	ENN46942
<b>Cable tie width 4.8 mm</b>				
Ø 43	Clear	188	1000	ENN46914
	Black			ENN46964
Ø 50	Clear	200	1000	ENN46916
	Black			ENN46966
Ø 60	Clear	250	100	ENN46918
	Black			ENN46968
Ø 76	Clear	300	100	ENN46919
	Black			ENN46969
Ø 102	Clear	300	100	ENN46920
	Black			ENN46970
<b>Cable tie width 7.6 mm</b>				
Ø 76	Black	297	100	ENN46974
Ø 102	Clear	368	100	ENN46925
	Black			ENN46975
<b>Cable tie width 9.0 mm</b>				
Ø 120	Black	430	100	ENN46976
Ø 140	Clear	530	100	ENN46927
	Black			ENN46977
Ø 228	Black	775	100	ENN46978

### Identification ties

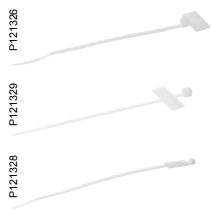

Identification tie with marker for safe and fast clamping of cables, conduits and tubing. Delivered in a sealed packaging to ensure performance, irrespective of storage conditions.

■ **Material:** PA 6.6.

Max. clamping (mm)	Colour	Length (mm)	Qty per package	References
<b>Marker size 20 x 9 mm, width 2.5 mm</b>				
Ø 18	Clear	110	100	ENN46220
<b>Marker size 25 x 8 mm, width 2.5 mm</b>				
Ø 18	Clear	100	100	ENN46220
<b>Marker size 23 x 13 mm, width 4.8 mm</b>				
Ø 43	Clear	220	100	ENN46225

### Accessories



For max. tie width (mm)	Colour	Dimensions H x W x D (mm)	Qty per package	References
<b>Self-adhesive bases</b>				
Self-adhesive base for the mounting of cable ties. The base for max. tie width 4.8 mm is both self-adhesive and has an additional screw-fix option.				
■ <b>Material:</b> PA 6.6.				
3.6	Clear	19 x 19 x 6	100	ENN46104
4.8	Clear	26.5 x 26.5 x 8	100	ENN46105
<b>Cradle</b>				
Cradle for the mounting of cable ties. Fixed with screw or rivet.				
■ <b>Material:</b> PA 6.6.				
7.8	Clear	22.2 x 15.9 x 9.7	100	ENN46109
<b>Cable tie pincers</b>				
Pincers intended to facilitate tightening and cutting of 6 and 9 mm installation ties.				
■ <b>Material:</b> steel.				
6 to 9	-	-	1	ENN46150



# Cable management Ducts



Characteristics	Corrugated cable tube	Spiral cable duct	Lyre-shaped clamps	Steel wired cable tray																																																	
	<ul style="list-style-type: none"> <li>■ Corrugated tube allowing cable entry between the structure and the door.</li> <li>■ Free from halogens and heavy metals.</li> <li>■ UV protection.</li> </ul>	<ul style="list-style-type: none"> <li>■ Spiral strip for bundling cables.</li> <li>■ Allows cables to enter between the body and the door.</li> </ul>	Clip-on clamps designed for direct installation on the 19" racks, Telequick mounting plates and symmetric DIN rails.	Mounting on the cable supports. Dimensions (2 types): <ul style="list-style-type: none"> <li>■ 1845 x 200 x 35 mm.</li> <li>■ 1845 x 200 x 54 mm.</li> </ul>																																																	
Material	Low-density polyethylene (LDPE)	-	-	Zinc-coated steel wire																																																	
Colour	Black	Colourless	Black	-																																																	
Supply	One 25 m reel	One 50 m reel	10 units. Reference by unit. Order by multiples of 10 (10, 20, 30...)	1 vertical steel wired cable tray and mounting elements																																																	
	<table border="1"> <thead> <tr> <th colspan="3">Ø (mm)</th> <th>References</th> </tr> <tr> <th>Nominal</th> <th>Inner</th> <th>Outer</th> <th></th> </tr> </thead> <tbody> <tr> <td>17</td> <td>16.6</td> <td>21.2</td> <td>NSYCPT17</td> </tr> <tr> <td>29</td> <td>29</td> <td>34.5</td> <td>NSYCPT29</td> </tr> <tr> <td>37</td> <td>36</td> <td>42.4</td> <td>NSYCPT37</td> </tr> <tr> <td>50</td> <td>47.7</td> <td>54.5</td> <td>NSYCPT50</td> </tr> </tbody> </table>	Ø (mm)			References	Nominal	Inner	Outer		17	16.6	21.2	NSYCPT17	29	29	34.5	NSYCPT29	37	36	42.4	NSYCPT37	50	47.7	54.5	NSYCPT50	<table border="1"> <thead> <tr> <th rowspan="2">Tightening range (mm)</th> <th colspan="2">Ø (mm)</th> <th rowspan="2">References</th> </tr> <tr> <th>Inner</th> <th>Outer</th> </tr> </thead> <tbody> <tr> <td>12 to 100</td> <td>9</td> <td>12</td> <td>NSYTC12100</td> </tr> </tbody> </table>	Tightening range (mm)	Ø (mm)		References	Inner	Outer	12 to 100	9	12	NSYTC12100	<table border="1"> <thead> <tr> <th>Use</th> <th>References</th> <th rowspan="2">Necessary depth (mm)</th> <th rowspan="2">References</th> </tr> </thead> <tbody> <tr> <td>For Telequick mounting plates and 19" racks</td> <td>AK2LA39</td> <td>35</td> <td>NSYBPC3</td> </tr> <tr> <td>For symmetric DIN rail 90 x 2.5 mm cables</td> <td>AK2LD01</td> <td>54</td> <td>NSYBPC5</td> </tr> <tr> <td>For symmetric DIN rail 75 x 2.5 mm cables</td> <td>AK2LD02</td> <td></td> <td></td> </tr> </tbody> </table>	Use	References	Necessary depth (mm)	References	For Telequick mounting plates and 19" racks	AK2LA39	35	NSYBPC3	For symmetric DIN rail 90 x 2.5 mm cables	AK2LD01	54	NSYBPC5	For symmetric DIN rail 75 x 2.5 mm cables	AK2LD02		
Ø (mm)			References																																																		
Nominal	Inner	Outer																																																			
17	16.6	21.2	NSYCPT17																																																		
29	29	34.5	NSYCPT29																																																		
37	36	42.4	NSYCPT37																																																		
50	47.7	54.5	NSYCPT50																																																		
Tightening range (mm)	Ø (mm)		References																																																		
	Inner	Outer																																																			
12 to 100	9	12	NSYTC12100																																																		
Use	References	Necessary depth (mm)	References																																																		
For Telequick mounting plates and 19" racks	AK2LA39			35	NSYBPC3																																																
For symmetric DIN rail 90 x 2.5 mm cables	AK2LD01	54	NSYBPC5																																																		
For symmetric DIN rail 75 x 2.5 mm cables	AK2LD02																																																				
	<h3>Mounting support for corrugated tube</h3> <p> <ul style="list-style-type: none"> <li>■ Mounting options:                             <ul style="list-style-type: none"> <li>□ directly on the enclosure,</li> <li>□ on a 19" swing rack and/or on cross-rails, with a mounting point.</li> </ul> </li> <li>■ The supports can be assembled with one another to form sets of tubes that allow a better arrangement of the cables.</li> <li>■ It allows the rotation of the tube once it is fixed on the support and prevents the corrugated tube from coming loose if subject to pulling movements.</li> <li>■ <b>Material:</b> polyamide (PA), black.</li> <li>■ <b>Supply:</b> 10 units and mounting elements. The support is supplied with its cover.</li> </ul> <table border="1"> <thead> <tr> <th>Model (n. Ø)</th> <th>References</th> </tr> </thead> <tbody> <tr> <td>17</td> <td>NSYCPTS17</td> </tr> <tr> <td>29</td> <td>NSYCPTS29</td> </tr> <tr> <td>37</td> <td>NSYCPTS37</td> </tr> <tr> <td>50</td> <td>NSYCPTS50</td> </tr> </tbody> </table> </p>				Model (n. Ø)	References	17	NSYCPTS17	29	NSYCPTS29	37	NSYCPTS37	50	NSYCPTS50																																							
Model (n. Ø)	References																																																				
17	NSYCPTS17																																																				
29	NSYCPTS29																																																				
37	NSYCPTS37																																																				
50	NSYCPTS50																																																				
	<p>n. Ø = nominal diameter.</p>																																																				

# Cable management

## Ducts

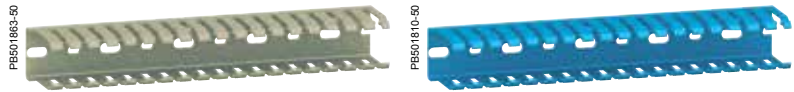

Characteristics			Cable-duct
			With lateral through slots and rear perforations.
Material			Rigid PVC
Colour			RAL 7030 grey or RAL 5000 blue
Standards			Compliance with standards VDE 0660/506 and DIN 43659
Other characteristics			<ul style="list-style-type: none"> <li>Temperature resistance: -5 ... +60°C</li> <li>Behaviour in fire: material V0 according to UL 94</li> <li>Fire resistance: 960°C according to IEC 60695-2-1/1</li> <li>Maximum capacity of H07.V.K 1.5 mm<sup>2</sup> flexible wire (filling factor: 0.6)</li> </ul>
Supply			8 units. Supplied in lengths of 2 m
Width (mm)	Height (mm)	Color	References
25	25	Grey	<b>AK2GD2525</b>
	50	Grey	<b>AK2GD2550</b>
30	35	Blue	<b>AK2GA33</b>
	55	Blue	<b>AK2GA35</b>
	90	Blue	<b>AKEGA39</b>
	144	Blue	<b>AK2GA315</b>
37.5	50	Grey	<b>AK2GD3750</b>
	75	Grey	<b>AK2GD3775</b>
50	50	Grey	<b>AK2GD5050</b>
	75	Grey	<b>AK2GD5075</b>
60	55	Blue	<b>AK2GA65</b>
	90	Blue	<b>AK2GA69</b>
	144	Blue	<b>AK2GA615</b>
75	50	Grey	<b>AK2GD7550</b>
	75	Grey	<b>AK2GD7575</b>
100	75	Grey	<b>AK2GD10075</b>
125	75	Grey	<b>AK2GD12575</b>

## Cable-duct accessories

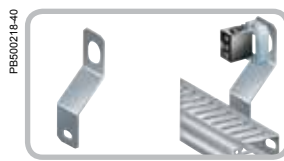

Characteristics	Retention bars	Ø 22 mm cable-duct support	Cable-duct support on technical upright
	<ul style="list-style-type: none"> <li>Fixed between 2 cable-duct slats by a hinged screw, preventing cable dropout.</li> <li>They can be cut to length to adapt to the width of the ducting.</li> </ul>	Installed on the door of the wall-mounting or floor-standing enclosure associated with Ø 22 mm elements.	Allows cable ducts to be installed on technical uprights, while increasing the usable surface of the equipment (up to 20 % according to the width of the cable duct).
Material	Flameproof high-impact polystyrene	Treated steel	Galvanised steel
Supply	50 units. Reference by unit. Order by multiples of 50 (50, 100, 150...)	10 units. Reference by unit. Order by multiples of 10 (10, 20, 30...)	10 units. Reference by unit. Order by multiples of 10 (10, 20, 30...)
References	<b>NSYCDRB</b>	<b>NSYSPCP</b>	<b>NSYCDSD</b>



Covers for cable-duct	
Replacement covers.	
Rigid PVC	
RAL 7030 grey or RAL 5000 blue	
Compliance with standards VDE 0660/506 and DIN 43659	
<ul style="list-style-type: none"> <li>■ Temperature resistance: -5 ... +60°C</li> <li>■ Behaviour in fire: material V0 according to UL 94</li> <li>■ Fire resistance: 960°C according to IEC 60695-2-1/1</li> <li>■ Maximum capacity of H07.V.K 1.5 mm<sup>2</sup> flexible wire (filling factor: 0.6)</li> </ul>	
8 unit. Supplied in lengths of 2 m	
<b>AK2CD25</b>	
<b>AK2CA3</b>	
<b>AK2CD37</b>	
<b>AK2CD50</b>	
<b>AK2CA6</b>	
<b>AK2CD75</b>	
<b>AK2CD100</b>	
<b>AK2CD125</b>	

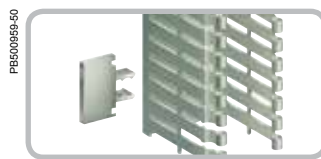

Plastic cable-duct support	Label frame	Insulated-head screw
<ul style="list-style-type: none"> <li>■ Clips onto the Telequick mounting plate or the 35 mm DIN rail.</li> <li>■ Includes a bolt for mounting the cable ducts through the 6.5 x 14 mm drill holes made in the back.</li> <li>■ The 2 functions, clipping and bolting, provide considerable time savings.</li> <li>■ Respects electrical insulation.</li> </ul>	In transparent plastic, clipping onto the slats of the cable ducts.	<ul style="list-style-type: none"> <li>■ M5 x 10 mm slotted hexagonal head.</li> <li>■ Respects electrical insulation.</li> </ul>
Black polyamide. Behaviour in fire: V0 according to UL 94	Polycarbonate	-
20 units. Reference by unit. Order by multiples of 20 (20, 40, 60...)	<ul style="list-style-type: none"> <li>■ 50 units. Reference by unit.</li> <li>Order by multiples of 50 (50, 100, 150...)</li> <li>■ Paper labels supplied</li> </ul>	100 units. Reference by unit. Order by multiples of 100 (100, 200, 300...)

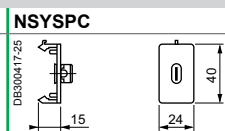

**NSYCDL**

**NSYSM10M5HP**

# Lighting and power sockets

## Power distribution rails



Characteristics				UTE - 16 A / 230 V~ with pin-earthed outlets
				<ul style="list-style-type: none"> <li>■ Sockets set at 35° with child protection.</li> <li>■ Aluminium profile silver - height 1 U.</li> <li>■ Equipped with power cord (3G 1.5 mm<sup>2</sup>) type H05 VVF, equipped with a mould right angle plug with earthing contact system.</li> <li>■ Could be used in: France, Belgium, Poland, Monaco, Slovakia, Czech Republic.</li> </ul>
Material				Fibreglass polyamide plastic with fire resistance to 850°C
Standards				According to NFC61314, IEC 60884 and NBNC61112-1 standards
Number of sockets	Width (mm)	Depth (mm)	Type*	References
<b>10" Adapted</b>				
3 sockets outlets	10"	44	A	<b>NSYAPU10F3</b>
3 sockets outlets with recessed green led switch	10"	44	B	<b>NSYAPU10F3S</b>
<b>19" Adapted</b>				
9 sockets outlets	19"	44	A	<b>NSYAPU19F9</b>
8 sockets outlets with recessed green led switch	19"	44	B	<b>NSYAPU19F8S</b>
6 sockets outlets with overvoltage protection 16 A	19"	76	C	<b>NSYAPU19F6CB</b>
7 sockets outlets with overvoltage protection 16 A + frequency filters	19"	44	D	<b>NSYAPU19F7FA</b>
7 sockets outlets	19"	44	A	-
6 sockets outlets with recessed green led switch	19"	44	B	-
<b>Vertical - 0U</b>				
10 sockets outlets with recessed green led switch (D. 968 mm)	968	44	B	<b>NSYAPUF10S</b>
12 sockets outlets with overvoltage protection 16 A (D. 1232 mm)	1232	76	C	<b>NSYAPUF12CB</b>

\*A: Rail of sockets without protection.

B: Rail of sockets with recessed green LED switch.

C: Rail of sockets with bi-polar magnetothermal circuit-breaker C16 type C60N 16 A curve C.

D: Suppression filter for interferences of up to 30 MHz, nominal frequency 400 Hz, attenuation 20 dB per decade.

# Lighting and power sockets

## Power distribution rails



VDE - 16 A / 230 V~ with side-earthed outlets	UK - 13 A / 240 V~ with BS standard outlets
<ul style="list-style-type: none"> <li>■ Sockets set at 35° with child protection.</li> <li>■ Aluminium profile silver - heigh 1 U.</li> <li>■ Equipped with power cord (3G 1.5 mm<sup>2</sup>) type H05 VVF, equipped with a mould right angle plug with earthing contact system.</li> <li>■ Could be used in: Germany, Austria, Netherlands, Italy (partial), Spain, Portugal, Sweden, Norway, Finland, Slovenia, Romania, Hungary, Afghanistan, Andorra, Vatican City, San Marino, Estonia, South Korea, Indonesia, Iceland, Chile, Bulgaria.</li> </ul>	<ul style="list-style-type: none"> <li>■ Sockets set at 90° with child protection.</li> <li>■ Aluminium profile silver - heigh 1 U.</li> <li>■ Equipped with power cord (3G 1.5 mm<sup>2</sup>) type H05 VVF, equipped with a mould right angle plug with earthing contact system.</li> </ul>
Fibreglass polyamide plastic with fire resistance to 850°C	Fibreglass polyamide plastic with fire resistance to 850°C
According to DIN49 440, VDE0620-1, IEC 60884 and UNE20315 standards	-
NSYAPU10S3	-
NSYAPU10S3S	-
NSYAPU19S9	-
NSYAPU19S8S	-
NSYAPU19S6CB	-
NSYAPU19S7FA	-
-	NSYAPU19UK7
-	NSYAPU19UK6S
NSYAPUS10S	-
NSYAPUS12CB	-

PRE500985-35



PRE500984-32



Characteristics	Mounting brackets	
	Mounting to the ends of the rail	Mounting with an orientation of 90°
	For vertical assembly of distribution rails.	
Material	Treated steel	
Thickness	10/10° mm	
Supply	Batch of 2 brackets, adaptable to all rails, with mountings	
References	NSYAPUBV	NSYAPUB



Characteristics		Multi-mounting lamp					
		This lamp is designed to optimise the space and accessibility of the enclosure, as well as having 4 mounting options as standard in each model.					
Colour	RAL 7035						
Ingress protection rating	IP20						
Standards	<ul style="list-style-type: none"> <li>■ IEC 61000-6-4</li> <li>■ UL 94 - plastics flammability</li> </ul>						
Other characteristics	<ul style="list-style-type: none"> <li>■ Fluorescent base: 2G7</li> <li>■ Built-in switch</li> <li>■ Power consumption: 11 W</li> <li>■ Frequency: 50/60 Hz</li> <li>■ Luminosity: 900 Lm</li> <li>■ Light temperature: 4500 K</li> <li>■ Fluorescent tube service life: 8000 h</li> <li>■ Connection: max. 2.5-mm<sup>2</sup> terminals, with cable tie</li> <li>■ Casing: Fire resistance V0</li> <li>■ Degree of insulation:                             <ul style="list-style-type: none"> <li><input type="checkbox"/> class I - lamps with socket</li> <li><input type="checkbox"/> class II - lamps without socket</li> </ul> </li> <li>■ Compliant with RoHS and Reach</li> <li>■ Operating/storage temperature:                             <ul style="list-style-type: none"> <li><input type="checkbox"/> -16°C to +65°C (-3°F to +149°F)</li> <li><input type="checkbox"/> -40°C to +70°C (-40°F to +158°F)</li> </ul> </li> </ul>						
Supply	1 lamp and mounting elements						
	With socket			Without socket		With presence detection and without socket	
<b>Voltage (V)</b>	<b>Socket</b>	<b>References</b>	<b>Certification</b>	<b>References</b>	<b>Certification</b>	<b>References</b>	<b>Certification</b>
230	Schuko UTE British	<b>NSYLAMCS</b>  <b>NSYLAMCF</b>  <b>NSYLAMCB</b>	VDE EN 60598-1: 2009	<b>NSYLAMC</b>	VDE EN 60598-1: 2009	<b>NSYLAMCD</b>	VDE EN 60598-1: 2009
120	UL-CSA	<b>NSYLAMCU</b>	UL 508A C22.2 No. 14-10	<b>NSYLAMC120</b>	UL 508A C22.2 No. 14-10	-	-

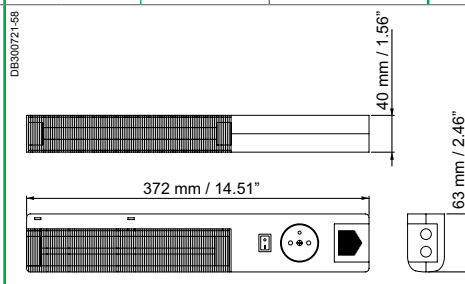

### ★ 4 fixing options

Fixing by sliding brackets.

Fixing to DIN rail.

Magnetic fixing.

Fixing by screws.



#### Rack for VDI

- 1 U, 19" rack. For lamp installation in VDI enclosures.
- **Supply:** supplied with mounting elements.

**Reference**  
**NSYLAM1U**

# Lighting and power sockets

## Lamps



PB501716-85



PB501723-13

Characteristics	Cost-effective lamp				Portable lamp
	These lamps offer excellent value for money and can adapt to any installation. The lamps can be interconnected and use a single power source: ■ 8 W lamps: max. 10 lamps interconnected. ■ 14 W lamps: max. 5 lamps interconnected.				■ Double function: <input type="checkbox"/> as an internal enclosure lamp, <input type="checkbox"/> as a maintenance lamp. ■ Compact 4-pin fluorescent lamp.
Colour	RAL 9002				RAL 7035
Ingress protection rating	IP20				IP20
Standards	■ IEC 60598-1 ■ UL 94 - plastics flammability				■ IEC 60598-1 ■ UL 94 - plastics flammability
Other characteristics	■ Fluorescent: T5 ■ Built-in switch ■ Light temperature: 4500 K ■ Fluorescent tube service life: 8000 h ■ Power cable: 3 m with connector and no plug at the end ■ Interconnection cable: 1 m with connectors ■ Casing: plastic, UL94-V0 ■ Degree of insulation: class II ■ Compliant with RoHS and Reach ■ Operating/storage temperature: <input type="checkbox"/> -16°C to +65°C (-3°F to +149°F) <input type="checkbox"/> -40°C to +70°C (-40°F to +158°F)				■ Compact fluorescent base: E27 ■ Built-in recessed switch ■ Light temperature: 4500 K ■ Fluorescent tube service life: 8000 h ■ Power cable: 3 m with connector and male plug at the end ■ Casing: plastic, UL94-V0 ■ Degree of insulation: class II ■ Compliant with RoHS and Reach ■ Operating/storage temperature: <input type="checkbox"/> -20°C to +50°C (-4°F to +122°F) <input type="checkbox"/> -45°C to +70°C (-40°F to +158°F)
Supply	1 lamp and mounting elements				1 lamp, 3 m cable and mounting elements
Voltage (V)	Power (W)	Frequency (Hz)	Lumens* (lm)	References	Reference
230	8	50-60	400	NSYLAM8T5	-
	14	50-60	650	NSYLAM14T5	-
	-	-	-	-	NSYLAMPOR

\* Approximate values.

**★ 2 fixing options**

PB501722-33

Fixing by adapter brackets.

PB501717-18

Magnetic fixing.

**★ 2 fixing options**

PB501724-34

Fixing by adhesive or by screws.

PB501725-26

# Floor accessories

## Casters and feet for floor-standing enclosures



Characteristics	Transport casters*	Enclosure casters
	<ul style="list-style-type: none"> <li>Quick installation on plinths with heights of 100 and 200 mm, except the plinth for enclosure sets.</li> <li>They can be installed in front or side position.</li> <li>Clipping and mounting to corner by screws.</li> <li>For use on flat surfaces.</li> <li>Height: 110 mm.</li> </ul>	<ul style="list-style-type: none"> <li>Double casters.</li> <li>Height: 92 mm.</li> <li>Diameter: 64 mm.</li> </ul>
Maximum load	50 kg per castor	100 kg per castor
Supply	4 transport casters (2 with a blocking system) and mounting elements	4 casters and mounting elements
References		
	<b>NSYSTW</b> 	<b>NSYSW</b>

\* Only for Spacial SM, SF and SD.



Characteristics	Levelling feet		Hygienic stainless-steel feet
	Fixed	Adjustable	
	Height: 42 mm.	Height: 22 mm.	Hygienic feet specific for harsh environments. Adjustable: 140 to 200 mm.
Material	Steel	-	316L stainless steel
Maximum load	100 kg per foot		100 kg per foot
Supply	Set of 4 floor feet		Set of 4 hygienic feet
References			
	<b>NSYSPSJ</b>	<b>NSYSPRJ</b>	<b>NSYPHX200</b>



# Door accessories

## Switches and pockets

### Switches

S3D S3X



SM SF SFX



Characteristics	Door switch for wall-mounting enclosures	Door switch for floor-standing enclosures	
	<ul style="list-style-type: none"> <li>Switch/commutator unit equipped with support and mountings for direct mounting to the enclosure.</li> <li>Can be used to control lighting, air-conditioning units, etc.</li> <li>It is not compatible with installing the 19" swing rack and the internal door.</li> <li>NC + NO contact, 10 A/500 V.</li> </ul>	<ul style="list-style-type: none"> <li>The switch is fixed to the structure of the enclosure.</li> <li>Drilled M20 cable entry for cable gland.</li> <li>NC + NO contact, 10 A/500 V.</li> </ul>	
Supply	1 door switch and mounting elements	1 door switch and mounting elements	
	<b>Reference</b> <b>NSYINLCRN</b>	<b>For ranges</b> SF & SFX SM	<b>References</b> <b>NSYDCM20</b> <b>NSYMDCM20</b>

### Pockets



SM SF SMX SFX



Characteristics	Plastic document pocket	Metal document pocket		
	Mounting by adhesive tape.	Direct mounting on door reinforcement frame. Height adjustable in steps of 25 mm.		
Material	Polystyrene (PS)	Steel		
Finish	-	Painted with polyester-epoxy resin		
Colour	RAL 7035 grey (NSYDPA4: RAL 9001)	RAL 7035 grey		
Maximum load	-	-		
Supply	1 plastic document pocket	1 metal document pocket & mount elements		
<b>Dimensions (mm)</b>	<b>References</b>			
<b>Doc. format</b>	<b>A</b>	<b>B</b>	<b>C</b>	
A5	174	188	22	<b>NSYDPA5</b>
A4	230	247	23	<b>NSYDPA4</b>
A4	234	278	40	<b>NSYDPA44 (1)</b>
A3	285	476	35	<b>NSYDPA3</b>
<b>Width (D)</b>				
600	-			
800	-			

(1) Not compatible with 19" chassis or modular distribution.

# Door accessories

## Door accessories for floor-standing enclosures

SM SF SMX SFX



SM SF

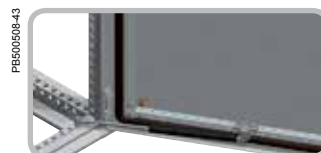

Characteristics	Folding support tray	Door cross rails	Floor-standing door retainer		
	<ul style="list-style-type: none"> <li>Adjustable horizontal support for laptop computers, documents or any other elements.</li> <li>Mounting on the door reinforcement frame.</li> <li>It can also be mounted on door cross-rails.</li> <li>Height adjustable in steps of 25 mm.</li> <li>In 1000-mm-wide enclosures, any size can be mounted using door cross-rail ref. <b>NSYSDCR10</b>.</li> <li>4 positions: 45°, 60°, 75° and 90°.</li> </ul>	<ul style="list-style-type: none"> <li>Direct mounting cross rails on the profiles of the reinforcement frame of the door.</li> <li>Adjustable height with a pitch of 25 mm.</li> </ul>	<ul style="list-style-type: none"> <li>Door blocker at the opening limit.</li> <li>It is fixed directly to the front frame of the enclosure and to the reinforcement frame of the door.</li> <li>It can be installed on doors that open both to the right and to the left.</li> </ul>		
Material	Steel	Galvanised steel	-		
Finish	Painted with epoxy-polyester resin	-	-		
Colour	RAL 7035 grey	-	-		
Thickness	15/10° mm	20/10° mm	-		
Maximum load	30 kg	-	-		
Supply	1 folding support tray and mounting elements	2 cross rails and bag of mountings	Door stop and mounting elements		
<b>Dimensions (mm)</b>	<b>References</b>				
<b>Width (B)</b>					
400	-	<b>NSYSDCR4</b>	-		
500	<b>NSYSDT5</b>	<b>NSYSDCR5</b>	-		
600	<b>NSYSDT6</b>	<b>NSYSDCR6</b>	-		
800	<b>NSYSDT8</b>	<b>NSYSDCR8</b>	-		
1000	-	<b>NSYSDCR10</b>	-		
<b>Door stop model</b>			<b>For enclosures</b>	<b>Limit</b>	<b>References</b>
Mechanical	-	-	Spacial SF	90° and 120°	<b>NSYSFMDR</b>
	-	-	Spacial SM	90°	<b>NSYSMDR</b>
Pneumatic	-	-	Spacial SF	120°	<b>NSYSFNDR</b>
	-	-	Spacial SM	90° and 120°	<b>NSYSMNDR</b>

# Door accessories

## Door accessories for wall-mounting enclosures



Characteristics	Wall-mounting door retainer	
	<p><b>Steel</b></p> <p>To block the door in the open position.</p> <ul style="list-style-type: none"> <li>■ It is installed on enclosures with heights from 400 mm and widths from 300 mm.</li> <li>■ Earthing connection of the enclosure by means of the reinforcement rail.</li> <li>■ Earthing accessories supplied with the enclosure (earth-connection wire to be ordered separately), see page 302.</li> <li>■ Note: cannot be installed on 19" mounting plates or on enclosures equipped with internal door.</li> </ul>	<p><b>Polyamide</b></p> <p>To block the door in the open position.</p> <ul style="list-style-type: none"> <li>■ It is installed on the perforated rails of the enclosure doors at the required height.</li> <li>■ It is only installed on enclosures with a height of less than 400 mm (no perforated rails).</li> </ul>
Material	Steel	Polyamide 6 (PA6)
References	NSYAEDRSCST	NSYAEDRS3DPA6

# Door accessories

## Windows



Characteristics	Window for modular equipment	Plastic window																																																																														
	They provide viewing and access to the inside of the enclosure while keeping the IP65 protection degree.	Plastic window with hinged cover for installation on front panel. <ul style="list-style-type: none"> <li>External dimensions: 213 x 133 mm.</li> <li>Internal dimensions of the window: 180 x 78 mm.</li> </ul>																																																																														
Material	Transparent polycarbonate	<ul style="list-style-type: none"> <li>Cover: polycarbonate</li> <li>Body: PVC</li> </ul>																																																																														
Ingress protection rating	IP65	IP55																																																																														
Supply	1 window	1 plastic window delivered with a drilling template																																																																														
	<table border="1"> <thead> <tr> <th rowspan="2">N.° of modules</th> <th rowspan="2">Fig. n.°</th> <th rowspan="2">A</th> <th rowspan="2">B</th> <th colspan="2">C</th> <th colspan="2">References</th> <th rowspan="2">Reference</th> </tr> <tr> <th>Low cover</th> <th>High cover</th> <th>Low cover</th> <th>High cover</th> </tr> </thead> <tbody> <tr> <td>2</td> <td>1</td> <td>78</td> <td>60</td> <td>15</td> <td>25</td> <td>NSYVA272M</td> <td>NSYVA272MA</td> <td rowspan="8">NSYMW10M</td> </tr> <tr> <td>4</td> <td>1</td> <td>78</td> <td>95</td> <td>15</td> <td>25</td> <td>NSYVA274M</td> <td>NSYVA274MA</td> </tr> <tr> <td>6</td> <td>1</td> <td>78</td> <td>130</td> <td>15</td> <td>25</td> <td>NSYVA276M</td> <td>NSYVA276MA</td> </tr> <tr> <td>8</td> <td>1</td> <td>78</td> <td>165</td> <td>15</td> <td>25</td> <td>NSYVA278M</td> <td>NSYVA278MA</td> </tr> <tr> <td>10</td> <td>1</td> <td>78</td> <td>200</td> <td>15</td> <td>25</td> <td>NSYVA2710M</td> <td>NSYVA2710MA</td> </tr> <tr> <td>12</td> <td>1</td> <td>78</td> <td>235</td> <td>15</td> <td>25</td> <td>NSYVA2712M</td> <td>NSYVA2712MA</td> </tr> <tr> <td>16</td> <td>2</td> <td>195</td> <td>165</td> <td>13</td> <td>-</td> <td>NSYVA2716M</td> <td>-</td> </tr> <tr> <td>24*</td> <td>2</td> <td>196</td> <td>235</td> <td>13</td> <td>-</td> <td>NSYVA2724M</td> <td>-</td> </tr> </tbody> </table>	N.° of modules	Fig. n.°	A	B	C		References		Reference	Low cover	High cover	Low cover	High cover	2	1	78	60	15	25	NSYVA272M	NSYVA272MA	NSYMW10M	4	1	78	95	15	25	NSYVA274M	NSYVA274MA	6	1	78	130	15	25	NSYVA276M	NSYVA276MA	8	1	78	165	15	25	NSYVA278M	NSYVA278MA	10	1	78	200	15	25	NSYVA2710M	NSYVA2710MA	12	1	78	235	15	25	NSYVA2712M	NSYVA2712MA	16	2	195	165	13	-	NSYVA2716M	-	24*	2	196	235	13	-	NSYVA2724M	-	
N.° of modules	Fig. n.°					A	B	C			References		Reference																																																																			
		Low cover	High cover	Low cover	High cover																																																																											
2	1	78	60	15	25	NSYVA272M	NSYVA272MA	NSYMW10M																																																																								
4	1	78	95	15	25	NSYVA274M	NSYVA274MA																																																																									
6	1	78	130	15	25	NSYVA276M	NSYVA276MA																																																																									
8	1	78	165	15	25	NSYVA278M	NSYVA278MA																																																																									
10	1	78	200	15	25	NSYVA2710M	NSYVA2710MA																																																																									
12	1	78	235	15	25	NSYVA2712M	NSYVA2712MA																																																																									
16	2	195	165	13	-	NSYVA2716M	-																																																																									
24*	2	196	235	13	-	NSYVA2724M	-																																																																									
	<p>Fig. 1</p> <p>Fig. 2</p>																																																																															

\* In rows of 12 modules mounted vertically.  
 \*\* In rows of 17 modules mounted horizontally.

# Door accessories

## Windows



Plastic window for modular equipment		Control window		
Frame with transparent hinged cover for mounting modular switchgear on the front panel. Opening: 46 x 180 mm (10 modules).		<ul style="list-style-type: none"> <li>■ To prevent accidental handling of the control units by any unauthorised person.</li> <li>■ Allows all the displayed information to be read without opening the door.</li> <li>■ Equipped with hinges for opening (180°).</li> <li>■ Closure by a n° 2233X lock.</li> <li>■ Indoor and outdoor installation.</li> </ul>		
-		Aluminium frame and 3-mm acrylic window		
IP55		IP55		
1 modular front panel		1 window, mountings and instruction sheet		
Reference		Dimensions (mm)		References
NSYMW10MK		<b>A</b>	<b>B</b>	
		300	300	NSYCW33
		400	400	NSYCW44
			500	NSYCW45
			600	NSYCW46
		500	400	NSYCW54
			500	NSYCW55
			600	NSYCW56
600	500	NSYCW65		
	600	NSYCW66		
800	600	NSYCW86		
<p><b>Kit for mounting the switchgear</b></p> <ul style="list-style-type: none"> <li>■ The unit is delivered assembled.</li> <li>■ <b>Supply:</b> 1 DIN rail and two supports.</li> </ul> <p><b>Reference</b> NSYMW10MR</p>		<p style="text-align: center;">SECTION A-A</p> <p style="text-align: right;">Y(0.500)</p>		
<p><i>Note: there are 2 mounting screws for the reference NSYCW86 with 1 without locking</i></p>				



### Mounting example



NSYMW10MK + NSYMW10MR.

# Other accessories

## Earthing accessories

PB500948-38

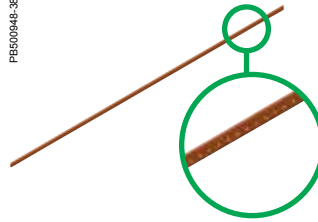

SM SF SD SMX SFX SDX

PB500999-18



Characteristics	Earthing strip	Central earthing point
	<ul style="list-style-type: none"> <li>■ Perforated brass bar, 15 x 3 mm.</li> <li>■ 1 m long.</li> <li>■ 87 connection points, M5 drill holes.</li> </ul>	<ul style="list-style-type: none"> <li>■ Connects earthing braids and cables to the structure of the enclosure.</li> <li>■ The earth connection is made by means of the M8 x 18 mm bolt.</li> </ul>
Mounting	-	Mounting to the structure by means of self-tapping screws
Supply	1 earthing strip and mounting elements	1 central earthing point, elements for mounting to the structure, and mountings for mounting to the bolt

### References

NSYECB1M153

S3D S3X

PB501000-42



#### Earthing strip mounting bracket

- They allow the mounting of an earth-collector rail or a DIN rail at the top and bottom of an enclosure.
- Mounting incompatible with certain accessories. Please consult us.
- **Mounting:** on holes made in the gutter of the enclosure.
- **Supply:** 2 lugs and mountings.

#### Reference

NSYEDCOS

DB300445-43

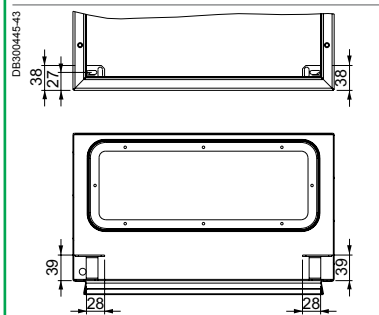

NSYCEP

# Other accessories

## Earthing and paint accessories

PB500084-42



PB500217-32

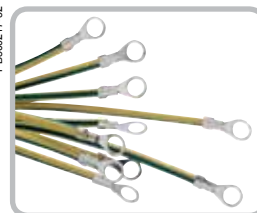

Characteristics				Earth braids	Earth cables
				Guarantee the earth connection for high frequencies, avoiding the disturbing electric currents that are produced.	Make it easier to install a safe earth connection, with a perfect contact, with optimised length.
Material				Tinned copper	Brass and copper alloy terminal, green and yellow PVC insulating sheath
Supply				10 earth braids (nuts and washers not included). Reference by unit. Order by multiples of 10 (10, 20, 30...)	10 earth cables (nuts and washers not included). Reference by unit. Order by multiples of 10 (10, 20, 30...)
Length (mm)	Width (mm)	Section (mm <sup>2</sup> )	Terminal Ø (mm)	References	
130	-	6	6.4	-	NSYEL136D6
150	12	6	6.5	NSYEB156D6	-
	17	10	6.5	NSYEB1510D6	-
155	17	16	8.5	NSYEB1516D8	-
160	-	6	6.4	-	NSYEL166D6
	-	6	8.3	-	NSYEL166D8
170	-	10	6.4	-	NSYEL1710D6
200	27	25	8.5	NSYEB2025D8	-
	33	50	8.5	NSYEB2050D8	-
220	-	6	6.4	-	NSYEL226D6
	-	25	8.3	-	NSYEL2225D8
250	-	10	6.4	-	NSYEL2510D6
350	-	25	8.3	-	NSYEL3525D8

PB500221-19



PB501003-37



Characteristics	Aerosol paint can	Paint touch-up
	<ul style="list-style-type: none"> <li>■ Air-drying paint.</li> <li>■ Content: 150 g.</li> </ul>	<ul style="list-style-type: none"> <li>■ Paint for touching up with a brush.</li> <li>■ Air-drying paint.</li> </ul>
Colour	References	
RAL 7032	NSYBPA7032	NSYTUP7032
RAL 7035	NSYBPA7035	NSYTUP7035

# Applicative and customised solutions



# Applicative and customised solutions

## Contents

---

<b>New</b>	<b>306</b>
<b>Outdoor Heavy Duty enclosures</b>	
<b>New</b>	<b>320</b>
<b>Seismic and nuclear enclosures</b>	
<b>Electromagnetic protected steel enclosures (EMC)</b>	<b>338</b>
<b>Enclosures for explosive atmospheres (ATEX)</b>	<b>348</b>
<b>Human-Machine Interface Control enclosure, PC rack and control desks</b>	<b>356</b>
<b>New</b>	<b>390</b>
<b>Variable speed drive flush-mounting kits</b>	
<b>Automobile applications</b>	<b>394</b>
<b>The customised solutions</b>	<b>396</b>

**New**

- Thalassa PHD is suitable for outdoor public areas thanks to its multiple virtues:
- pressure and shock resistant (IEC 61439-5: 2010),
  - anti-posting thanks to its special ribbed-surface door,
  - insulated (ready to be Class II according to IEC 61439-1: 2011).



- Spacial S3HD and SFHD are designed for outdoor private areas. They are engineered to resist aggressive environments (anti-corrosion certification class C4H, ISO 12944:1999).



PB502611-34



### Tough

PHD: Heavy Duty polyester reinforced with a double layer of fiberglass. Ultra-resistant, anti-vandalism.

PB502673-29

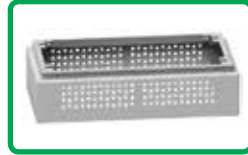

### Heavy Duty accessories

Dedicated accessories to resist outdoor, harsh environments: the all-new, slim fanbox (see page 310 and 312).

PB502648-11



### Simplicity

Installation simplified: easy to be lifted with up to 1000 kg-loaded equipment. HD lifting accessories also available.

DB300824-120

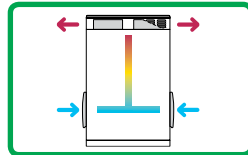

### Thermal management solutions

3 ventilation architectures studied to help protect the equipment installed inside from overheating and humidity.

PB502662-30



### Fully equipped

Standard, pre-installed equipment includes:

- a curved canopy to avoid water stagnation
- a door retainer to keep the door open even with strong wind or when a vehicle passes by
- an aluminium cable gland plate to easily drill holes and avoid corrosion
- a document pocket to stock your documents in a practical place.

PB502670-29



### Upper ventilation module

The newly engineered roof ventilation accessory helps to prevent creation of condensation (one of the causes of corrosion).

PB502674-25

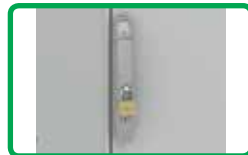

### Anti-vandalism

PHD and SFHD: the handle with keylock and additional padlock hole (padlock not included) helps to secure the equipment inside. It is standard equipment.

**This range can be configured according to your needs**

**4 different services available:**



Assemble to order



Mounting of standard accessories



Painting



Machining

See page 396 for details or consult our web site [www.schneider-electric.com](http://www.schneider-electric.com)

New



Characteristics	Polyester outdoor Heavy Duty enclosures		Steel outdoor Heavy Duty enclosures	
	Wall-mounting enclosure	Floor-standing enclosure	Wall-mounting enclosure	Floor-standing enclosure
	Outdoor Heavy Duty (HD) enclosures made of polyester insulating material. Suitable to be installed in public areas thanks to its features: <ul style="list-style-type: none"> <li>■ anti-pressure and shock resistant</li> <li>■ anti-posting</li> <li>■ insulated.</li> </ul>		Outdoor Heavy Duty (HD) enclosures made of coated steel. Suitable to be installed in private areas with harsh environments thanks to its capacity to resist: <ul style="list-style-type: none"> <li>■ corrosion (up to C4H level according ISO 12944:1999)</li> <li>■ UV.</li> </ul>	
Material	HD Polyester reinforced with a double layer of fiberglass		HD steel with anti-corrosive coating	
Finish	-		Structured finish, 100 % polyester powder	
Colour	RAL 7035 grey		RAL 7035 grey	
Conditions of use	Outdoor and/or harsh environments		Outdoor and/or harsh environments	
Ingress protection rating	IP65	IP55	IP66	IP55
Mechanical protection rating	IK10		IK10	
Standards	IEC 61439-5: 2010, IEC 62208: 2011, IEC 61439-1: 2011, IEC 61969-3: 2011, IEC 60297-3-100: 2009		IEC 61439-5: 2010, IEC 62208: 2011, IEC 61969-3: 2011, IEC 60297-3-100: 2009, ISO 12.944: 1999 (C4H)	
Certifications	See table page 318		See table page 318	
Mounting	On wall by means of optional wall mounting accessory	2 options for installation on floor: <ul style="list-style-type: none"> <li>■ with floor mounting kit <b>NSYMF2PLAZ4</b> or <b>NSYMF2PLAZ6</b> for integrated plinth (50 mm)</li> <li>■ with additional ZZ plinths (ventilated or non-ventilated) available as accessory (200 mm) (see page 311)</li> </ul>	<ul style="list-style-type: none"> <li>■ On wall by means of optional stainless steel wall mounting brackets</li> <li>■ On post by means of optional HD post-mounting device</li> </ul>	<ul style="list-style-type: none"> <li>■ Directly on floor by means of optional plinth (see page 313)</li> </ul>
Maximum transportable load	500 kg		200 kg	1000 kg
Other characteristics	<ul style="list-style-type: none"> <li>■ Fire resistant (EN 1794-2:2011)</li> <li>■ Lifting possible from top with eyebolt accessory</li> <li>■ New dedicated ventilation solutions to be integrated in roof, lateral or plinth. 3 ventilation architectures proposed (see page 316 et 317)</li> </ul>		New dedicated ventilation solutions to be integrated in roof, side or plinth	
Options	Plain door or ribbed door		-	
Supply	<ul style="list-style-type: none"> <li>■ Curved canopy</li> <li>■ Handle with keylock (1242E type) and padlock</li> <li>■ Door retainer</li> <li>■ Plastic document pocket (A4 size)</li> </ul>	<ul style="list-style-type: none"> <li>■ Curved canopy</li> <li>■ Integrated plinth</li> <li>■ Handle with keylock (1242E type) and padlock</li> <li>■ Aluminium cable gland plate</li> <li>■ Door retainer</li> <li>■ Plastic document pocket (A4 size)</li> </ul>	<ul style="list-style-type: none"> <li>■ Curved canopy</li> <li>■ 3-mm double-bar lock</li> <li>■ Plastic document pocket (A4 size)</li> <li>■ Door retainer</li> <li>■ Aluminium cable gland plate</li> </ul>	<ul style="list-style-type: none"> <li>■ Curved canopy</li> <li>■ Rear panel</li> <li>■ Handle with keylock (1242E type) and padlock</li> <li>■ Aluminium cable gland plate</li> <li>■ Door retainer</li> <li>■ Plastic document pocket (A4 size)</li> </ul>

New

## Enclosure with ventilated canopy

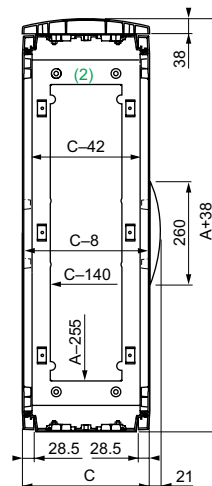
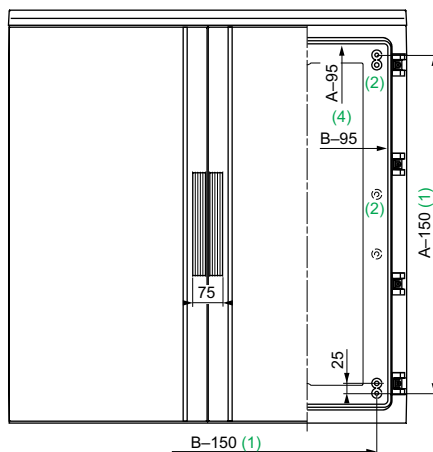
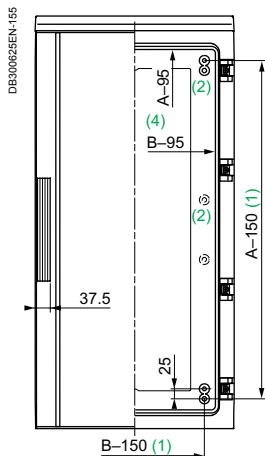

## Common top views

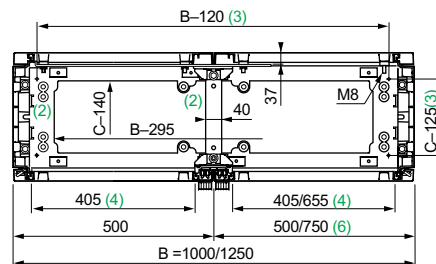
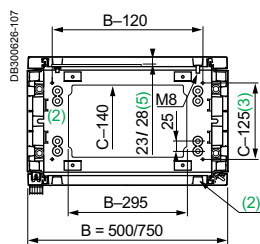

New

## Enclosure with ventilated canopy and plinth-type open bottom part

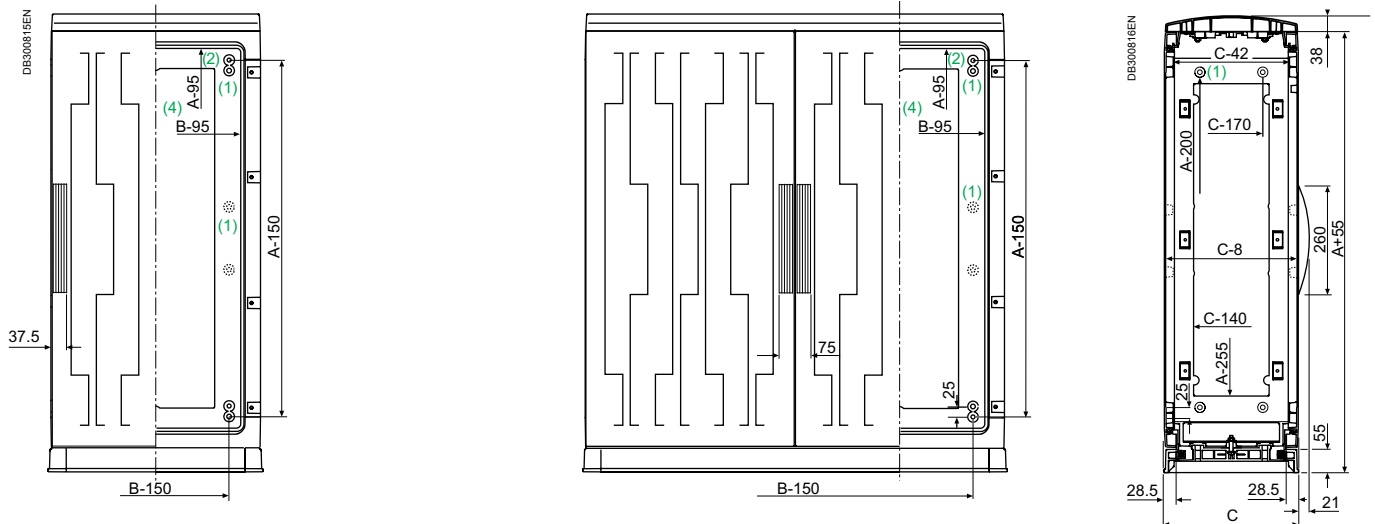

## Common top views

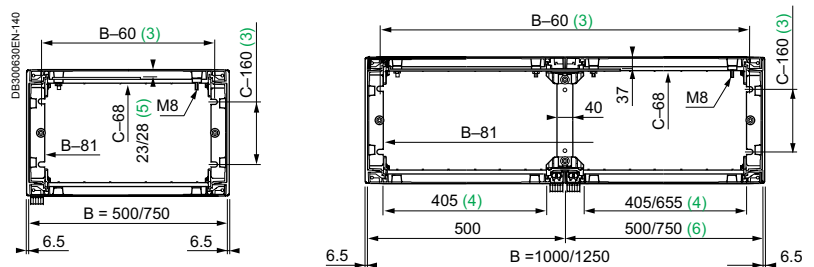

- (1) 4 bosses with M8 inserts and studs for direct mounting of mounting plates.
- (2) Bosses designed to accommodate M8 inserts, ref. **NSYTEX8**. They are placed:
  - On the back of the enclosure, from the height of 1000 mm. They allow the mounting of partial mounting plates and assorted equipment.
  - On the top and bottom parts of the enclosure. They are used for mounting the step slides, an internal door, 19" chassis, etc.
- (3) Dimensions for mounting on the floor or on a plinth.
- (4) Entry dimensions, door open.
- (5) Dimension of 28 mm for enclosures with heights of more than 1000 mm (height after the installation of the plain mounting plates with reinforcement foldings).
- (6) With a width of 1250 mm in standard supply, 500-mm door on the left and 750-mm door on the right.

New



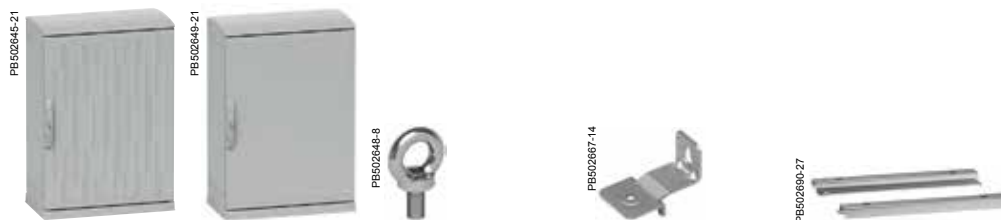

### Polyester outdoor HD enclosures



Characteristics					Polyester enclosure		Eyebolts	Wall mounting accessory	Floor mounting kit
					Anti-posting door	Plain door			
							Top lifting accessory for polyester outdoor Heavy Duty enclosure. ■ Maximum load: 500 kg.	Wall mounting support for polyester outdoor Heavy Duty enclosure. No change in ingress protection rate. ■ Maximum load: 180 kg.	To fix the enclosure on the floor in a correct way. ■ Certification: □ Class II insulation following IEC 61439-1 □ IP55 following IEC 50529 □ Infrastructure standard following IEC 61439-5.
Material							Galvanised cast steel	Steel	Steel
Finish							-	Anti-corrosive coating	Insulating coating
Colour							-	-	-
Installation							-	-	On dry concrete
Supply							4	4	1
Height (mm)	Width (mm)	Depth (mm)	No. of doors	References					
<b>Wall-mounting enclosure</b>									
538	500	320	1	NSYPHDT553	NSYPHDT553P	-	NSYFMPHD	-	
788	500	320	1	NSYPHDT753	NSYPHDT753P	-	NSYFMPHD	-	
<b>Floor-standing enclosure</b>									
843	750	420	1	NSYPHDZT774	NSYPHDZT774P	NSYPLHD	-	NSYMF2PLAZ4	
		620	1	NSYPHDZT776	NSYPHDZT776P	NSYPLHD	-	NSYMF2PLAZ6	
1093	500	420	1	NSYPHDZT1054	NSYPHDZT1054P	NSYPLHD	-	NSYMF2PLAZ4	
		750	1	NSYPHDZT1074	NSYPHDZT1074P	NSYPLHD	-	NSYMF2PLAZ4	
1343	500	420	1	NSYPHDZT1254	NSYPHDZT1254P	NSYPLHD	-	NSYMF2PLAZ4	
		750	1	NSYPHDZT1274	NSYPHDZT1274P	NSYPLHD	-	NSYMF2PLAZ4	
		620	1	NSYPHDZT1276	NSYPHDZT1276P	NSYPLHD	-	NSYMF2PLAZ6	
	1250	420	2	NSYPHDZT12124	NSYPHDZT12124P	NSYPLHD	-	NSYMF2PLAZ4	
		620	2	NSYPHDZT12126	NSYPHDZT12126P	NSYPLHD	-	NSYMF2PLAZ6	
		620	2	NSYPHDZT12126	NSYPHDZT12126P	NSYPLHD	-	NSYMF2PLAZ6	
1593	750	420	1	NSYPHDZT1574	NSYPHDZT1574P	NSYPLHD	-	NSYMF2PLAZ4	
		620	1	NSYPHDZT1576	NSYPHDZT1576P	NSYPLHD	-	NSYMF2PLAZ6	
	1250	420	2	NSYPHDZT15124	NSYPHDZT15124P	NSYPLHD	-	NSYMF2PLAZ4	
		620	2	NSYPHDZT15126	NSYPHDZT15126P	NSYPLHD	-	NSYMF2PLAZ6	
2093	750	420	2*	NSYPHDZT2074	NSYPHDZT2074P	NSYPLHD	-	NSYMF2PLAZ4	

\* Vertical doors.



Ventilated ZZ plinths 200 mm**	ZZ plinth 200 mm**	Plain mounting plate	Roof ventilation module	Anti-burglary accessory
Height: 200 mm. The front parts cannot be removed. Includes a polyester anti-insect filter.	Height: 200 mm. The front parts cannot be removed. It is provided with one or two reinforcement cross-rails, adjustable to adapt to the position of the cables.	The enclosures with height of $\geq 1000$ mm have intermediate impressions for installing mounting plates of a lesser height (M8 inserts, ref. <b>NSYTEX8</b> , to be ordered separately).	Ventilation module to enable airing from the top of the enclosure (H = 95 mm) with insect protection.	Anti-burglary accessory for polyester outdoor Heavy Duty in accordance with ENV 1627-1630:2011 class 2. It keeps the Insulation Class II according to IEC 61439-1:2011.
Ultra-reinforced polyester	Ultra-reinforced polyester	Galvanised sheet-steel	Steel with anti-corrosive coating	Steel with anti-corrosive coating
-	-	-	Structured finish, 100 % polyester powder	Structured finish, 100 % polyester powder
RAL 7035 grey	RAL 7035 grey	-	RAL 7035 grey	RAL 7035 grey
-	-	<ul style="list-style-type: none"> <li>Direct installation on M8 inserts at the rear of the enclosure or on step slides for depth adjustment (see page 202)</li> <li>In the 2-door enclosures, it is possible to install 1 complete mounting plate or 2 individual mounting plates</li> </ul>	-	Easy installation on the outside of the enclosure
1	1	1	1	1
-	-	<b>NSYPMM55</b>	-	-
-	-	<b>NSYPMM75</b>	-	-
<b>NSYZZ274VHD</b>	<b>NSYZZ274G</b>	<b>NSYPMM77</b>	<b>NSYPCVR74HD</b>	<b>NSYBGN774HD</b>
<b>NSYZZ276VHD</b>	<b>NSYZZ276G</b>	<b>NSYPMM77</b>	<b>NSYPCVR76HD</b>	<b>NSYBGN776HD</b>
<b>NSYZZ254VHD</b>	<b>NSYZZ254G</b>	<b>NSYPMM105</b>	<b>NSYPCVR54HD</b>	<b>NSYBGN1054HD</b>
<b>NSYZZ274VHD</b>	<b>NSYZZ274G</b>	<b>NSYPMM107</b>	<b>NSYPCVR74HD</b>	<b>NSYBGN1074HD</b>
<b>NSYZZ254VHD</b>	<b>NSYZZ254G</b>	<b>NSYPMM125</b>	<b>NSYPCVR54HD</b>	<b>NSYBGN1254HD</b>
<b>NSYZZ274VHD</b>	<b>NSYZZ274G</b>	<b>NSYPMM127</b>	<b>NSYPCVR74HD</b>	<b>NSYBGN1274HD</b>
<b>NSYZZ276VHD</b>	<b>NSYZZ276G</b>	<b>NSYPMM127</b>	<b>NSYPCVR76HD</b>	<b>NSYBGN1276HD</b>
<b>NSYZZ2124VHD</b>	<b>NSYZZ2124G</b>	<b>NSYPMM1212</b>	<b>NSYPCVR124HD</b>	<b>NSYBGN12124HD</b>
<b>NSYZZ2126VHD</b>	<b>NSYZZ2126G</b>	<b>NSYPMM1212</b>	<b>NSYPCVR126HD</b>	<b>NSYBGN12126HD</b>
<b>NSYZZ274VHD</b>	<b>NSYZZ274G</b>	<b>NSYPMM157</b>	<b>NSYPCVR74HD</b>	<b>NSYBGN1574HD</b>
<b>NSYZZ276VHD</b>	<b>NSYZZ276G</b>	<b>NSYPMM157</b>	<b>NSYPCVR76HD</b>	<b>NSYBGN1576HD</b>
<b>NSYZZ2124VHD</b>	<b>NSYZZ2124G</b>	<b>NSYPMM1512</b>	<b>NSYPCVR124HD</b>	<b>NSYBGN15124HD</b>
<b>NSYZZ2126VHD</b>	<b>NSYZZ2126G</b>	<b>NSYPMM1512</b>	<b>NSYPCVR126HD</b>	<b>NSYBGN15126HD</b>
<b>NSYZZ274VHD</b>	<b>NSYZZ274G</b>	<b>NSYPMM207</b> or <b>2 x NSYPMM107</b>	<b>NSYPCVR74HD</b>	<b>NSYBGN2074HD</b>
				

\*\* The coupling kit NSYMUPLA\*\*\* is not applicable for enclosures using ZZ or ZH type plinths.

New

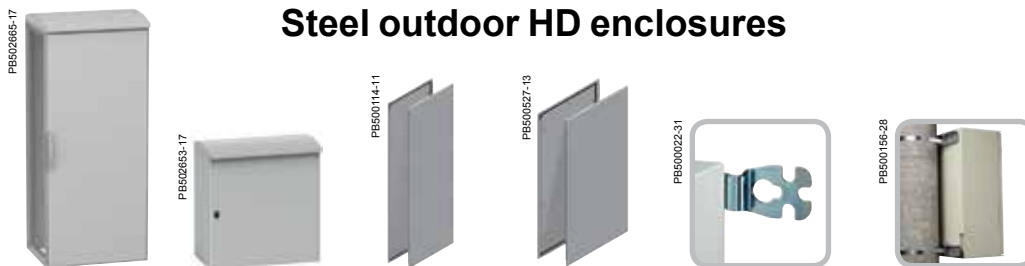

### Steel outdoor HD enclosures

Characteristics			Steel enclosure	Side panels		Stainless steel wall mounting brackets	Heavy duty post-mounting device
				For floor-standing enclosures		For wall-mounting enclosures	
				Side panel mounting for SFHD.		Horizontal position only. Do not use for dynamic loads. It brings 10 mm separations between enclosure and wall.	Rail fixed on the inserts in the rear of the enclosure with 8-mm screws.
Material				Steel with anti-corrosive coating		Stainless-steel AISI 304L	Steel
Finish				Structured finish, 100 % polyester powder		-	Anti-corrosive coating
Colour				RAL 7035 grey		-	-
Installation				-		Mounted directly on the rear of the enclosure, in horizontal position	On posts with a max. circumference of 675 mm (minimum diameter 150 mm and maximum diameter 215 mm)
Maximum load				-		150 kg	100 kg
Supply				2 side panels with mounting elements and sealing gasket		Set of 4 wall-mounting brackets with mountings and gasket	1
Height (mm)	Width (mm)	Depth (mm)		External mounting	Internal mounting		
<b>Wall-mounting enclosure</b>							
343	200	180	NSYS3HD3215	-	-	NSYAEFPFXSC	-
448	300	230	NSYS3HD4320	-	-	NSYAEFPFXSC	NSYSFPSC30HD
548	400	230	NSYS3HD5420	-	-	NSYAEFPFXSC	NSYSFPSC40HD
653	400	280	NSYS3HD6425	-	-	NSYAEFPFXSC	NSYSFPSC40HD
658	600	330	NSYS3HD6630	-	-	NSYAEFPFXSC	NSYSFPSC60HD
753	500	280	NSYS3HD7525	-	-	NSYAEFPFXSC	NSYSFPSC50HD
858	600	330	NSYS3HD8630	-	-	NSYAEFPFXSC	NSYSFPSC60HD
862	800	430	NSYS3HD8840	-	-	NSYAEFPFXSC	NSYSFPSC80HD
1062	600	430	NSYS3HD10640	-	-	NSYAEFPFXSC	NSYSFPSC60HD
	800	430	NSYS3HD10840	-	-	NSYAEFPFXSC	NSYSFPSC80HD
<b>Floor-standing enclosure</b>							
1262	600	430	NSYSFHD12640	NSY2SPHD124	NSY2SPIHD124	-	-
	800	430	NSYSFHD12840	NSY2SPHD124	NSY2SPIHD124	-	-
	1200	430	NSYSFHD1212402D	NSY2SPHD124	NSY2SPIHD124	-	-
1281	600	630	NSYSFHD12660	NSY2SPHD126	NSY2SPIHD126	-	-
	800	630	NSYSFHD12860	NSY2SPHD126	NSY2SPIHD126	-	-
	1200	630	NSYSFHD1212602D	NSY2SPHD126	NSY2SPIHD126	-	-
1662	800	430	NSYSFHD16840	NSY2SPHD164	NSY2SPIHD164	-	-
	1200	430	NSYSFHD1612402D	NSY2SPHD164	NSY2SPIHD164	-	-
1681	600	630	NSYSFHD16660	NSY2SPHD166	NSY2SPIHD166	-	-
	800	630	NSYSFHD16860	NSY2SPHD166	NSY2SPIHD166	-	-
	1200	630	NSYSFHD1612602D	NSY2SPHD166	NSY2SPIHD166	-	-
2062	800	430	NSYSFHD20840	NSY2SPHD204	NSY2SPIHD204	-	-



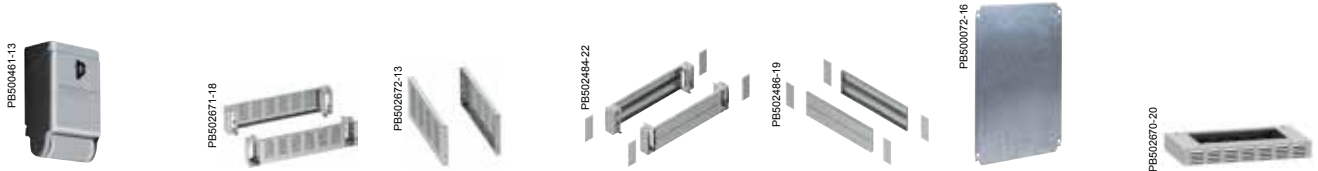



	Heavy Duty padlockable double lock	Stainless-steel plinths 200 mm				Plain mounting plate	Roof ventilation module	
		Ventilated plinths		Standard plinths				
	For wall-mounting enclosures	Front and rear kit	Lateral kit	Front and rear kit	Lateral kit			
	Easy mounting instead of the standard lock.	The front and rear of the plinth consists of 4 corners with 2 panels.	They are fixed to the corner of the plinth by mounting screws.	The front and rear of the plinth consists of 4 corners with 2 panels.	They are fixed to the corner of the plinth by mounting screws.	-	Ventilation module to enable airing from the top of the enclosure (H = 95 mm) with insect protection.	
	Zamack	Stainless-steel AISI 304L	Stainless-steel AISI 304L	Stainless-steel AISI 304L	Stainless-steel AISI 304L	Galvanised steel	Steel with anti-corrosive coating	
	Anti-corrosive coating	Scotch-Brite® brushing				-	Structured finish, 100 % polyester powder	
	-	-	-	-	-	-	RAL 7035 grey	
	-	<ul style="list-style-type: none"> <li>■ For wall-mounting enclosure: it is necessary to order separately the plinth mounting kit (ref. <b>NSYAPFXWM</b>) composed by mounting hardware and drilling jig</li> <li>■ For floor-standing enclosure: mounting in the holes for mounting the enclosures to the floor</li> </ul>					-	-
	Delivered with 3 mm double-bar metal key	1 kit	1 kit	1 kit	1 kit	1 mounting plate and mounting elements	1	
	<b>NSYAEDLPADS3DHD</b>	-	-	-	-	<b>NSYMM32</b>	-	
	<b>NSYAEDLPADS3DHD</b>	-	-	-	-	-	-	
	<b>NSYAEDLPADS3DHD</b>	-	-	-	-	<b>NSYMM54</b>	-	
	<b>NSYAEDLPADS3DHD</b>	-	-	-	-	<b>NSYMM64</b>	-	
	<b>NSYAEDLPADS3DHD</b>	<b>NSYSFVX6200</b>	<b>NSYSPLVX3200</b>	<b>NSYSFVX6200</b>	<b>NSYSPSX3200</b>	<b>NSYMM66</b>	-	
	<b>NSYAEDLPADS3DHD</b>	-	-	-	-	<b>NSYMM75</b>	-	
	<b>NSYAEDLPADS3DHD</b>	<b>NSYSFVX6200</b>	<b>NSYSPLVX3200</b>	<b>NSYSFVX6200</b>	<b>NSYSPSX3200</b>	<b>NSYMM86*</b>	-	
	<b>NSYAEDLPADS3DHD</b>	<b>NSYSFVX8200</b>	<b>NSYSPLVX4200</b>	<b>NSYSFVX8200</b>	<b>NSYSPSX4200</b>	<b>NSYMM88</b>	<b>NSYS3CVR84HD</b>	
	<b>NSYAEDLPADS3DHD</b>	<b>NSYSFVX6200</b>	<b>NSYSPLVX4200</b>	<b>NSYSFVX6200</b>	<b>NSYSPSX4200</b>	<b>NSYMM106</b>	<b>NSYS3CVR64HD</b>	
	<b>NSYAEDLPADS3DHD</b>	<b>NSYSFVX8200</b>	<b>NSYSPLVX4200</b>	<b>NSYSFVX8200</b>	<b>NSYSPSX4200</b>	<b>NSYMM108*</b>	<b>NSYS3CVR84HD</b>	
	-	-	-	<b>NSYSFVX6200</b>	<b>NSYSPSX4200SF</b>	<b>NSYMP126</b>	<b>NSYSFCVR64HD</b>	
	-	<b>NSYSFVX8200</b>	<b>NSYSPLVX4200SF</b>	<b>NSYSFVX8200</b>	<b>NSYSPSX4200SF</b>	<b>NSYMP128</b>	<b>NSYSFCVR84HD</b>	
	-	<b>NSYSFVX12200</b>	<b>NSYSPLVX4200SF</b>	<b>NSYSFVX12200</b>	<b>NSYSPSX4200SF</b>	<b>NSYMP1212</b>	<b>NSYSFCVR124HD</b>	
	-	<b>NSYSFVX6200</b>	<b>NSYSPLVX6200SF</b>	<b>NSYSFVX6200</b>	<b>NSYSPSX6200SF</b>	<b>NSYMP126</b>	<b>NSYSFCVR66HD</b>	
	-	<b>NSYSFVX8200</b>	<b>NSYSPLVX6200SF</b>	<b>NSYSFVX8200</b>	<b>NSYSPSX6200SF</b>	<b>NSYMP128</b>	<b>NSYSFCVR86HD</b>	
	-	<b>NSYSFVX12200</b>	<b>NSYSPLVX6200SF</b>	<b>NSYSFVX12200</b>	<b>NSYSPSX6200SF</b>	<b>NSYMP1212</b>	<b>NSYSFCVR126HD</b>	
	-	<b>NSYSFVX8200</b>	<b>NSYSPLVX4200SF</b>	<b>NSYSFVX8200</b>	<b>NSYSPSX4200SF</b>	<b>NSYMP168</b>	<b>NSYSFCVR84HD</b>	
	-	<b>NSYSFVX12200</b>	<b>NSYSPLVX4200SF</b>	<b>NSYSFVX12200</b>	<b>NSYSPSX4200SF</b>	<b>NSYMP1612</b>	<b>NSYSFCVR124HD</b>	
	-	<b>NSYSFVX6200</b>	<b>NSYSPLVX6200SF</b>	<b>NSYSFVX6200</b>	<b>NSYSPSX6200SF</b>	<b>NSYMP166</b>	<b>NSYSFCVR66HD</b>	
	-	<b>NSYSFVX8200</b>	<b>NSYSPLVX6200SF</b>	<b>NSYSFVX8200</b>	<b>NSYSPSX6200SF</b>	<b>NSYMP168</b>	<b>NSYSFCVR86HD</b>	
	-	<b>NSYSFVX12200</b>	<b>NSYSPLVX6200SF</b>	<b>NSYSFVX12200</b>	<b>NSYSPSX6200SF</b>	<b>NSYMP1612</b>	<b>NSYSFCVR126HD</b>	
	-	<b>NSYSFVX8200</b>	<b>NSYSPLVX4200SF</b>	<b>NSYSFVX8200</b>	<b>NSYSPSX4200SF</b>	<b>NSYMP208</b>	<b>NSYSFCVR84HD</b>	

### Anti-vandalism kit for plinths

Mountings that help to prevent to open the plinths from the outside with standard tools.

- **Material:** stainless-steel.

**References**

	16 anti-vandalism screws for stainless-steel plinth	<b>NSYSKAV</b>
	Key for anti-vandalism screws for stainless-steel plinth	<b>NSYKSKAV</b>

\* Plate with reversible dimensions; it can be installed in enclosures with inverted dimensions. Example: Plate ref. **NSYMM64** can be used for the following enclosures: H 600 x W 400 mm or H 400 x W 600 mm.  
For plain and silkscreened mounting plates: In wall-mounting enclosures with widths of 1000 and 1200 mm, it is possible to install 2 mounting plates at different depths using an additional central step slide **NSYDRSDCR** (more information on page 218).

### Installation accessories

#### Mounting acc.



**Polyester:** Page 238  
**Steel:** Page 220

#### Telequick system

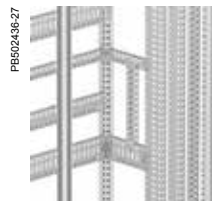

**Polyester:** Page 228  
**Steel:** Page 219

#### 19" accessories



**Steel:** Page 326

New



Characteristics	Fanbox	Filter	Roof filter for fanbox	IP55 HD Metal Grille	Anti-vandalism kit for HD metal grille								
	<ul style="list-style-type: none"> <li>Free flow rate: 550 m<sup>3</sup>/h (50/60 Hz).</li> <li>Minimal depth inside the enclosure (90 mm).</li> <li>Allows multiple cooling architectures (see page 316 et 317).</li> </ul>	Replacement G3 M1 type synthetic filter for HD metal grille. <b>Dimensions:</b> 223 x 223 mm.	Roof G2 round synthetic filter designed to cover the fanbox. Covers completely the fanbox and helps to protect it from dust and humidity. Mandatory for fanbox installation in the Roof ventilation module for IP55 configurations.	Slim grille (35 mm external depth). Includes a G3 M1 filter.	Mountings that help to prevent to open the grille from the outside with standard tools (EN 1627-1630:2011 Class 2).								
Material	Plastic	-	-	Steel with anti-corrosive coating	Steel with anti-corrosive coating								
Finish	-	-	-	Structured finish, 100 % polyester powder	-								
Colour	RAL 7016 dark grey	-	-	RAL 7035 grey	-								
Ingress protection rating	-	-	-	IP55	-								
Mechanical protection rating	-	-	-	IK10	-								
Supply	1 (grille not included)	5	1	1 grille delivered with G3 M1 type synthetic filter (223 x 223mm) and mountings	1 kit								
	<table border="1"> <thead> <tr> <th>Voltage</th> <th>References</th> </tr> </thead> <tbody> <tr> <td>24 V DC</td> <td>NSYCVF550M24FB</td> </tr> <tr> <td>115 V AC</td> <td>NSYCVF550M115FB</td> </tr> <tr> <td>230 V AC</td> <td>NSYCVF550M230FB</td> </tr> </tbody> </table>	Voltage	References	24 V DC	NSYCVF550M24FB	115 V AC	NSYCVF550M115FB	230 V AC	NSYCVF550M230FB	Reference	Reference	Reference	Reference
Voltage	References												
24 V DC	NSYCVF550M24FB												
115 V AC	NSYCVF550M115FB												
230 V AC	NSYCVF550M230FB												
		NSYCAF223T	NSYCAF190	NSYCAG223LFHD	NSYCAAPVHD								

New

- ① IP55 metal grille
- ② Fanbox
- ③ Roof ventilated module
- ④ Ventilated plinths
- ⑤ IP54 grille



	S-Line				T-Line			
Architecture benefits	<ul style="list-style-type: none"> <li>■ Most common and competitive architecture</li> <li>■ Maximum heat dissipation to extract 800 W-1000 W</li> <li>■ <math>\Delta T^\circ</math> of 5°C</li> <li>■ Easy access to mount-dismount fanbox</li> <li>■ Air flow in horizontal axis</li> </ul>				<ul style="list-style-type: none"> <li>■ High capacity of extraction calories up to 1500 W</li> <li>■ Noise level with 1 fan: 55 dB when installed inside the upper ventilation module</li> <li>■ <math>\Delta T^\circ</math> of 5°C</li> <li>■ Air flow in vertical axis</li> </ul>			
	IP55 metal grille		Fanbox		IP55 metal grille		Fanbox	Roof ventilation module
	Door	Side	Door	Side	Door	Side	(1 filter NSYCAF190 for each Fanbox)	

Polyester outdoor HD enclosure

References	Amount to be installed				Amount to be installed				References
NSYPHDT553	-	-	-	-	-	-	-	-	-
NSYPHDT553P	-	-	-	-	-	-	-	-	-
NSYPHDT753	-	-	-	-	-	-	-	-	-
NSYPHDT753P	1 to 2	-	1 to 2	-	1 to 2	-	-	-	-
NSYPHDZT774	-	1 to 2	-	1 to 2	-	1 to 2	1 to 2	1	NSYPCVR74HD
NSYPHDZT774P	1 to 2	1 to 2	1 to 2	1 to 2	1 to 2	1 to 2	1 to 2	1	NSYPCVR74HD
NSYPHDZT776	-	1 to 2	-	1 to 2	-	1 to 2	1 to 2	1	NSYPCVR76HD
NSYPHDZT776P	1 to 2	1 to 2	1 to 2	1 to 2	1 to 2	1 to 2	1 to 2	1	NSYPCVR76HD
NSYPHDZT1054	-	1	-	1	-	1	1	1	NSYPCVR54HD
NSYPHDZT1054P	1 to 2	1	1 to 2	1	1 to 2	1	1	1	NSYPCVR54HD
NSYPHDZT1074	-	1 to 2	-	1 to 2	-	1 to 2	1 to 2	1	NSYPCVR74HD
NSYPHDZT1074P	1 to 4	1 to 2	1 to 4	1 to 2	1 to 4	1 to 2	1 to 2	1	NSYPCVR74HD
NSYPHDZT12124	-	1 to 3	-	1 to 3	-	1 to 3	1 to 3	1	NSYPCVR124HD
NSYPHDZT12124P	1 to 4	1 to 3	1 to 4	1 to 3	1 to 4	1 to 3	1 to 3	1	NSYPCVR124HD
NSYPHDZT12126	-	1 to 3	-	1 to 3	-	1 to 3	1 to 3	1	NSYPCVR126HD
NSYPHDZT12126P	1 to 4	1 to 3	1 to 4	1 to 3	1 to 4	1 to 3	1 to 3	1	NSYPCVR126HD
NSYPHDZT1254	-	1	-	1	-	1	1	1	NSYPCVR54HD
NSYPHDZT1254P	1 to 3	1	1 to 3	1	1 to 3	1	1	1	NSYPCVR54HD
NSYPHDZT1274	-	1 to 2	-	1 to 2	-	1 to 2	1 to 2	1	NSYPCVR74HD
NSYPHDZT1274P	1 to 4	1 to 2	1 to 4	1 to 2	1 to 4	1 to 2	1 to 2	1	NSYPCVR74HD
NSYPHDZT1276	-	1 to 2	-	1 to 2	-	1 to 2	1 to 2	1	NSYPCVR76HD
NSYPHDZT1276P	1 to 4	1 to 2	1 to 4	1 to 2	1 to 4	1 to 2	1 to 2	1	NSYPCVR76HD
NSYPHDZT15124	-	1 to 3	-	1 to 3	-	1 to 3	1 to 3	1	NSYPCVR124HD
NSYPHDZT15124P	1 to 4	1 to 3	1 to 4	1 to 3	1 to 4	1 to 3	1 to 3	1	NSYPCVR124HD
NSYPHDZT15126	-	1 to 3	-	1 to 3	-	1 to 3	1 to 3	1	NSYPCVR126HD
NSYPHDZT15126P	1 to 4	1 to 3	1 to 4	1 to 3	1 to 4	1 to 3	1 to 3	1	NSYPCVR126HD
NSYPHDZT1574	-	1 to 2	-	1 to 2	-	1 to 2	1 to 2	1	NSYPCVR74HD
NSYPHDZT1574P	1 to 4	1 to 2	1 to 4	1 to 2	1 to 4	1 to 2	1 to 2	1	NSYPCVR74HD
NSYPHDZT1576	-	1 to 2	-	1 to 2	-	1 to 2	1 to 2	1	NSYPCVR76HD
NSYPHDZT1576P	1 to 4	1 to 2	1 to 4	1 to 2	1 to 4	1 to 2	1 to 2	1	NSYPCVR76HD
NSYPHDZT2074	-	1 to 2	-	1 to 2	-	1 to 2	1 to 2	1	NSYPCVR74HD
NSYPHDZT2074P	1 to 4	1 to 2	1 to 4	1 to 2	1 to 4	1 to 2	1 to 2	1	NSYPCVR74HD

Steel outdoor HD enclosure

References	Amount to be installed				Amount to be installed				References
NSYS3HD8630	1 to 2	-	1 to 2	-	1 to 2	-	-	-	-
NSYS3HD8840	1 to 2	1 to 2	1 to 2	1 to 2	1 to 2	1 to 2	1 to 2	1	NSYS3CVR84HD
NSYS3HD10640	1 to 2	1 to 2	1 to 2	1 to 2	1 to 2	1 to 2	1	1	NSYS3CVR64HD
NSYS3HD10840	1 to 4	1 to 2	1 to 4	1 to 2	1 to 4	1 to 2	1 to 2	1	NSYS3CVR84HD
NSYSFHD12640	1 to 3	1 to 3	1 to 3	1 to 3	1 to 3	1 to 3	1	1	NSYSFCVR64HD
NSYSFHD12660	1 to 3	1 to 3	1 to 3	1 to 3	1 to 3	1 to 3	1	1	NSYSFCVR66HD
NSYSFHD12840	1 to 4	1 to 3	1 to 4	1 to 3	1 to 4	1 to 3	1 to 2	1	NSYS3CVR84HD
NSYSFHD12860	1 to 4	1 to 3	1 to 4	1 to 3	1 to 4	1 to 3	1 to 2	1	NSYSFECA66HD
NSYSFHD16660	1 to 4	1 to 4	1 to 4	1 to 4	1 to 4	1 to 4	1	1	NSYSFCVR66HD
NSYSFHD16840	1 to 4	1 to 4	1 to 4	1 to 3	1 to 4	1 to 3	1 to 2	1	NSYS3CVR84HD
NSYSFHD16860	1 to 4	1 to 4	1 to 4	1 to 4	1 to 4	1 to 4	1 to 2	1	NSYSFECA66HD
NSYSFHD20840	1 to 4	1 to 4	1 to 4	1 to 4	1 to 4	1 to 4	1 to 2	1	NSYS3CVR84HD
NSYSFHD1212402D	1 to 4	1 to 3	1 to 4	1 to 2	1 to 4	1 to 2	1 to 3	1	NSYSFCVR124HD
NSYSFHD1212602D	1 to 4	1 to 3	1 to 4	1 to 3	1 to 4	1 to 2	1 to 3	1	NSYSFCVR126HD
NSYSFHD1612402D	1 to 4	1 to 4	1 to 4	1 to 3	1 to 4	1 to 3	1 to 3	1	NSYSFCVR124HD
NSYSFHD1612602D	1 to 4	1 to 4	1 to 4	1 to 3	1 to 4	1 to 3	1 to 3	1	NSYSFCVR126HD

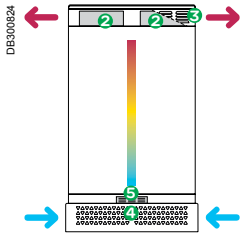

This table helps to configure thermal architectures, but it is highly recommended to use ProClima Software to ensure the right thermal solution according to the selected architecture.

## I-Line

- Integrated architecture particularly suitable for public areas
- High capacity of extraction calories up to 1500 W
- Noise level with 1 fan: 55 dB when installed inside the upper ventilation module
- Good extraction flow rate power
- Air flow in vertical axis

**IP54 outlet grille**  
(NSYCAC223LPF +  
G3 filter NSYCAF223T)

**Ventilated plinths**

**Fanbox**  
(1 filter NSYCAF190  
for each Fanbox)

**Roof ventilation module**

Amount to be installed		References		Amount to be installed		References	
-	-	-	-	-	-	-	-
-	-	-	-	-	-	-	-
-	-	-	-	-	-	-	-
-	-	-	-	-	-	-	-
1 to 2	1	NSYZZ274VHD	-	1 to 2	1	NSYPCVR74HD	-
1 to 2	1	NSYZZ274VHD	-	1 to 2	1	NSYPCVR74HD	-
1 to 2	1	NSYZZ276VHD	-	1 to 2	1	NSYPCVR76HD	-
1 to 2	1	NSYZZ276VHD	-	1 to 2	1	NSYPCVR76HD	-
1	1	NSYZZ254VHD	-	1	1	NSYPCVR54HD	-
1	1	NSYZZ254VHD	-	1	1	NSYPCVR54HD	-
1 to 2	1	NSYZZ274VHD	-	1 to 2	1	NSYPCVR74HD	-
1 to 2	1	NSYZZ274VHD	-	1 to 2	1	NSYPCVR74HD	-
1 to 3	1	NSYZZ2124VHD	-	1 to 3	1	NSYPCVR124HD	-
1 to 3	1	NSYZZ2124VHD	-	1 to 3	1	NSYPCVR124HD	-
1 to 3	1	NSYZZ2126VHD	-	1 to 3	1	NSYPCVR126HD	-
1 to 3	1	NSYZZ2126VHD	-	1 to 3	1	NSYPCVR126HD	-
1	1	NSYZZ254VHD	-	1	1	NSYPCVR54HD	-
1	1	NSYZZ254VHD	-	1	1	NSYPCVR54HD	-
1 to 2	1	NSYZZ274VHD	-	1 to 2	1	NSYPCVR74HD	-
1 to 2	1	NSYZZ274VHD	-	1 to 2	1	NSYPCVR74HD	-
1 to 2	1	NSYZZ276VHD	-	1 to 2	1	NSYPCVR76HD	-
1 to 2	1	NSYZZ276VHD	-	1 to 2	1	NSYPCVR76HD	-
1 to 3	1	NSYZZ2124VHD	-	1 to 3	1	NSYPCVR124HD	-
1 to 3	1	NSYZZ2124VHD	-	1 to 3	1	NSYPCVR124HD	-
1 to 3	1	NSYZZ2126VHD	-	1 to 3	1	NSYPCVR126HD	-
1 to 3	1	NSYZZ2126VHD	-	1 to 3	1	NSYPCVR126HD	-
1 to 2	1	NSYZZ274VHD	-	1 to 2	1	NSYPCVR74HD	-
1 to 2	1	NSYZZ274VHD	-	1 to 2	1	NSYPCVR74HD	-
1 to 2	1	NSYZZ276VHD	-	1 to 2	1	NSYPCVR76HD	-
1 to 2	1	NSYZZ276VHD	-	1 to 2	1	NSYPCVR76HD	-
1 to 2	1	NSYZZ274VHD	-	1 to 2	1	NSYPCVR74HD	-
1 to 2	1	NSYZZ274VHD	-	1 to 2	1	NSYPCVR74HD	-

Amount to be installed		References		Amount to be installed		References	
1	1	NSYSPFVX6200	NSYSPLVX4200	-	-	-	-
1 to 2	1	NSYSPFVX8200	NSYSPLVX4200	1 to 2	1	NSYS3CVR84HD	-
1	1	NSYSPFVX6200	NSYSPLVX4200	1	1	NSYS3CVR64HD	-
1	1	NSYSPFVX8200	NSYSPLVX4200	1 to 2	1	NSYS3CVR84HD	-
1	1	NSYSPFVX6200	NSYSPLVX4200	1	1	NSYSFCVR64HD	-
1	1	NSYSPFVX6200	NSYSPLVX6200	1	1	NSYSFCVR66HD	-
1 to 2	1	NSYSPFVX8200	NSYSPLVX4200	1 to 2	1	NSYS3CVR84HD	-
1 to 2	1	NSYSPFVX8200	NSYSPLVX6200	1 to 2	1	NSYSFECA66HD	-
1	1	NSYSPFVX6200	NSYSPLVX6200	1	1	NSYSFCVR66HD	-
1 to 2	1	NSYSPFVX8200	NSYSPLVX4200	1 to 2	1	NSYS3CVR84HD	-
1 to 2	1	NSYSPFVX8200	NSYSPLVX6200	1 to 2	1	NSYSFECA66HD	-
1 to 2	1	NSYSPFVX8200	NSYSPLVX4200	1 to 2	1	NSYS3CVR84HD	-
1 to 3	1	NSYSPFVX12200	NSYSPLVX4200	1 to 3	1	NSYSFCVR124HD	-
1 to 3	1	NSYSPFVX12200	NSYSPLVX6200	1 to 3	1	NSYSFCVR126HD	-
1 to 3	1	NSYSPFVX12200	NSYSPLVX4200	1 to 3	1	NSYSFCVR124HD	-
1 to 3	1	NSYSPFVX12200	NSYSPLVX6200	1 to 3	1	NSYSFCVR126HD	-

Test description	Standard	Standard title	Certification	Declaration
<b>POLYESTER</b>				
<b>Thalassa PHD</b>				
IP55, IK10, lifting: 500 kg max. (IP65 for wall-mounting)	IEC 62208: 2011	Empty enclosures for low-voltage switchgear and controlgear assemblies - General requirements	●	-
Class II Insulation	IEC 61439-1: 2011	Low-voltage switchgear and controlgear assemblies Part 1: general rules	-	✓
Strength of materials and parts	IEC 61439-5: 2010	Low-voltage switchgear and controlgear assemblies Part 5: assemblies for power distribution in public networks	●	-
Corrosion resistance C4H	ISO 12.944: 1999	Paints and varnishes-corrosion protection of steel structures by protective paint systems Part 6: laboratory performance testing methods	-	✓
Climatic test, Biological Test, Resistance against chemically and mechanical active substances. Mechanical test, Lifting and stiffness test	IEC 61969-3: 2011	Electronic "Mechanical structures for electronic equipment - Outdoor enclosures" Part 3: environmental requirements, tests and safety aspects	●	-
Space for electronics	IEC 60297-3-100: 2009	Mechanical structures for electronic equipment Dimensions of mechanical structures of the 482.6 mm (19 in) series - Part 3-100: basic dimensions of front panels, subracks, chassis, racks and cabinets	-	✓
Dimensional	EIA-310-E	Cabinets, Racks, Panels, and associated equipment	-	✓
Fire resistance	EN 1794-2:2011	Vandalism: fire resistance	-	✓
Posting	Internal test	Door antiposting internal test	-	✓
Single door: 1, 2, 3, 3R, 4, 4X, 5, 12 & 13 Double door: 1, 2, 3, 3R, 5, 12 & 13	UL 508A	Standard for Industrial Control Panels	●	-
<b>STEEL</b>				
<b>Spacial SFHD (floor-standing enclosures)</b>				
IP55, IK10, lifting: 1000 kg max.	IEC 62208: 2011	Empty enclosures for low-voltage switchgear and controlgear assemblies - General requirements	●	-
Strength of materials and parts	IEC 61.439-5: 2010	Low-voltage switchgear and controlgear assemblies Part 5: Assemblies for power distribution in public networks	●	-
Corrosion resistance C4H	ISO 12.944: 1999	Paints and varnishes-corrosion protection of steel structures by protective paint systems Part 6: laboratory performance testing methods	●	-
Climatic test, Biological Test, Resistance against chemically and mechanical active substances. Mechanical test, Lifting and stiffness test	IEC 61969-3: 2011	Electronic "Mechanical structures for electronic equipment - Outdoor enclosures" Part 3: environmental requirements, tests and safety aspects	●	-
Space for electronics	IEC 60297-3-100: 2009	Mechanical structures for electronic equipment Dimensions of mechanical structures of the 482.6 mm (19 in) series - Part 3-100: basic dimensions of front panels, subracks, chassis, racks and cabinets	-	✓
Dimensional	EIA-310-E	Cabinets, Racks, Panels, and associated equipment	-	✓
Single door: Type 1, 3R, 12, 12K Double door: Type 1, 3R, 12, 12K	UL 508A: 2007	Standard for Industrial Control Panels	●	-
<b>Spacial S3HD (wall-mounting enclosures)</b>				
IP66, IK10, lifting: 200 kg max.	IEC 62208: 2011	Empty enclosures for low-voltage switchgear and controlgear assemblies - General requirements	●	-
Strength of materials and parts	IEC 61.439-5: 2010	Low-voltage switchgear and controlgear assemblies Part 5: Assemblies for power distribution in public networks	●	-
Corrosion resistance C4H	ISO 12.944: 1999	Paints and varnishes-corrosion protection of steel structures by protective paint systems Part 6: laboratory performance testing methods	●	-
Climatic test, Biological Test, Resistance against chemically and mechanical active substances. Mechanical test, Lifting and stiffness test	IEC 61969-3: 2011	Electronic "Mechanical structures for electronic equipment - Outdoor enclosures" Part 3: environmental requirements, tests and safety aspects	●	-
Space for electronics	IEC 60297-3-100: 2009	Mechanical structures for electronic equipment Dimensions of mechanical structures of the 482.6 mm (19 in) series - Part 3-100: basic dimensions of front panels, subracks, chassis, racks and cabinets	-	✓
Dimensional	EIA-310-E	Cabinets, Racks, Panels, and associated equipment	-	✓
Single door: Type 1, 2, 3, 3R, 4, 4X, 5, 12 & 13	UL 508A	Standard for Industrial Control Panels	●	-

Test description	Standard	Standard title	Certification	Declaration
<b>HD ACCESSORIES</b>				
<b>HD THERMAL MANAGEMENT</b>				
<b>Fanbox</b>				
NSYCVF Series are intended for mounting on the flat surface of a Type 12 or 12K enclosure	UL 508A CAN/CSA-C22.2 No. 14, CAN/CSA C22.2 No. 94-M91 CAN/CSA C22.2 No. 73	Industrial Control Panels Industrial Control Equipment Special Purpose Enclosures Electrically Equipped Machine Tools	●	-
<b>IP55 HD Metal grille (NSYCAG223LFHD)</b>				
IP55 (in conditions of use)	IEC 60529: 2013	Degrees of protection provided by enclosures (IP Code)	-	✓
Corrosion resistance C4H	ISO 12.944: 1999	Paints and varnishes-corrosion protection of steel structures by protective paint systems - part 6: laboratory performance testing methods	●	-
<b>Anti-vandalism kit for HD metal grille (NSYCAAPVHD)</b>				
Resistance Class 2	ENV 1627:2011	Burglar resistance - Requirements and classification	●	-
<b>Upper ventilation module (PHD / SFHD / S3HD)</b>				
IP55 (in conditions of use)	IEC 60529: 2013	Degrees of protection provided by enclosures (IP Code)	-	✓
Corrosion resistance at level C4H	ISO 12.944: 1999	Paints and varnishes-corrosion protection of steel structures by protective paint systems Part 6: laboratory performance testing methods	●	-
<b>HD POLYESTER ENCLOSURES</b>				
<b>Anti-burglary accessory (NSYBGN***HD)</b>				
Resistance Class 2	ENV 1627:2011	Burglar resistance - Requirements and classification	●	-
Corrosion resistance at level C4H	ISO 12.944: 1999	Paints and varnishes-corrosion protection of steel structures by protective paint systems Part 6: laboratory performance testing methods	●	-
<b>ZZ plinths (NSYZZ*** &amp; NSYZZ***VHD)</b>				
ZZ Plinth: IP44 (in conditions of use) Ventilated ZZ Plinth: IP43 (in conditions of use)	IEC 60.529:2013	Degrees of protection provided by enclosures (IP Code)	-	✓
<b>Eyebolts (NSYPLHD)</b>				
Maximum load 500Kg	IEC 62208: 2011	Empty enclosures for low-voltage switchgear and controlgear assemblies - General requirements	-	✓
<b>HD STEEL ENCLOSURES</b>				
<b>Stainless steel plinths (NSYSPFVX*** / NSYSPLVX*** / NSYSPSX*** / NSYSPSX***)</b>				
Ventilated plinth: IP20 (in conditions of use) Standard plinth: IP30 (in conditions of use)	IEC 60.529:2013	Degrees of protection provided by enclosures (IP Code)	-	✓

New

SF

S3D

### General overview

#### ■ Introduction

Schneider Electric's Spacial range offers enclosures (SF cubicles and S3D boxes) certified for installation in seismic risk zones of various intensities. The zones used to classify the enclosures are those defined by the Uniform Building Code (UBC).

#### ■ UBC zones

The UBC has defined 6 zones (0, 1, 2A, 2B, 3, 4, 5) according to ground acceleration. The illustration below, taken from IEC 60721-2-6 (Figure 5), uses the zones defined by the UBC, combining, for greater clarity, zones 2A and 2B in zone 2.

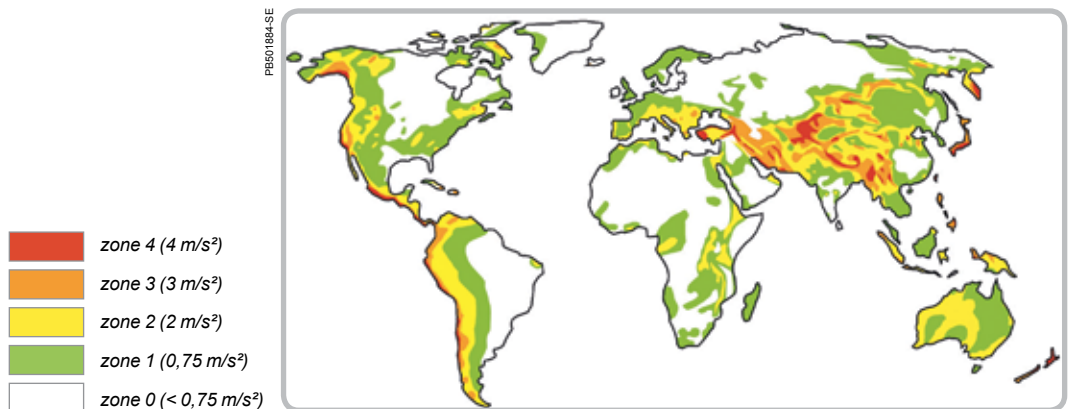

#### ■ Certification of Spacial enclosures

The tests used for certification are those specified by the international standard and adapted for the requirements of nuclear industry. The reference documents are as follows:

- M12D0168610 (EDF): Earthquake resistance tests specified for the nuclear industry. This document is the update of document CRT 91-C-112-00 produced following the Fukushima accident
- IEC 60068-3-3 (first edition): international standard.

### Certification of Spacial enclosures

#### ■ Enclosures for weak to medium earthquakes:

The standard offer of SF cubicles and S3D\* boxes is certified to withstand all seismic risks up to UBC zone 3 for the following applications:

- SF cubicle applications:
  - Control and automation;
  - Industrial electronics (19" frame);
  - LV power distribution (Spacial SFP).
- S3D box applications:
  - Control and automation.

#### ■ Enclosures for medium to strong earthquakes:

The Spacial SF 5G cubicle is certified to withstand any seismic risk up to UBC zone 4 thanks to its reinforced structure, its special panel mounting system and its locking system. It has been tested for the following applications:

- Control and automation;
- Industrial electronics (19" frame);
- LV power distribution (Spacial SFP 5G).

#### ■ Enclosures for very strong earthquakes:

The Spacial SF S3D 6G cubicle is certified to withstand any seismic risk up to UBC zone 4 thanks to its panel thickness, its locking system, its wall mounting brackets and its reinforced chassis mounting. It has been tested for the following application:

- Control and automation.

\*Except larger enclosures. Consult us.



New

SF

S3D

### Technical information

#### Definitions

**Ground acceleration:**

Ground acceleration resulting from a given earthquake.

Note: In practice, ground acceleration can be broken down into horizontal and vertical components.

**Floor acceleration:**

Acceleration of a particular floor in a building (at the location of an equipment item) resulting from a given earthquake.

Note: In practice, floor acceleration can be broken down into horizontal and vertical components.

#### Test results

Spatial SF and S3D offer				Earthquake characteristics			Floor acceleration (m/s <sup>2</sup> ) (2)							
Standard		5G (5)	6G (5)	IEC 60068-3-3 (Table 3)		Ground acceleration a <sub>g</sub>	Required response spectra (RRS)			Test response spectra (TRS)				
S3D	SF, SF 19", SFP	SF 5G, SFP 5G	S3D 6G	Seismic zones	Intensity scales		IEC 60068-3-3	EDF		Specification	Horiz.	Vertic.		
				UBC (3)	Richter	MSK (4)	m/s <sup>2</sup>	Horiz.	Vertic.	Horiz.	Vertic.	Specification	Horiz.	Vertic.
				0	< 5.5	< VIII				N/A				
				1-2			2	6	3					
				3	≥ 5.5 and ≤ 7	VIII to IX	3	9	4.5	6	4.8	HN 20-E-53	9	9
				4	> 7	> IX	5	15	7.5	10	8	CRT 91-C-112-00	15	12
							(1)	(1)	(1)	20	24	M12D0168610	29.6	40

- (1) The IEC 60068-3-3, 1991-02 standard has not yet been updated since the events at FUKUSHIMA.
- (2) Floor acceleration = a<sub>g</sub> x K x D (§8.2.7), where:  
 K = amplification factor = 3 (Table 4 of IEC 60068-3-3)  
 D = direction factor = 1 for the horizontal direction, = 0.5 for the vertical direction (Table 5 of IEC 60068-3-3).
- (3) Approximate Uniform Building Code values for the zone.
- (4) MSK (Medvedev-Sponheuer-Kamik, corresponding to the modified Mercalli intensity scale).
- (5) The 5G and 6G designations refer to the amplified maximum acceleration value read respectively on the horizontal RRS of the EDF standard CRT91C11200 and on vertical RRS of the EDF MRI standard for large equipment.
- (6) Except larger enclosures. Consult us.

**Comment:** g = acceleration due to gravity rounded off to the nearest whole number (1g = 10 m/s<sup>2</sup>).

#### Test Response Spectra (TRS)

Spectra for SF 3G cubicles

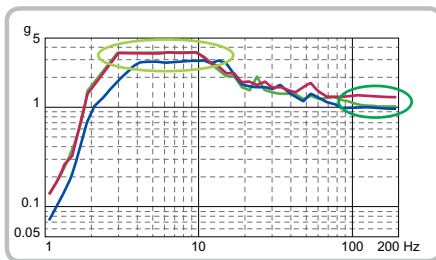

Spectra for SF 5G cubicles

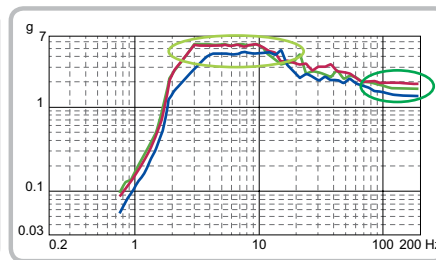

Spectra for S3D 6G boxes

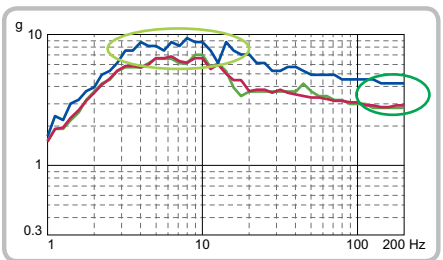

— TRS<sub>x</sub>    — TRS<sub>y</sub>    — TRS<sub>z</sub>  
 x = front-rear horizontal axis  
 y = left-right horizontal axis  
 z = vertical axis

○ Amplified maximum acceleration: acceleration expected at the center of gravity of the equipment  
 ○ Maximum floor acceleration: unamplified acceleration

New

SF

> **Spacial SF 5G** cubicles (for control and automation) and **Spacial SFP 5G** cubicles (for LV power distribution) have been designed to withstand earthquakes up to UBC zone 4.



### Reinforced crosspieces

- Two reinforced crosspieces ensure the structure's mechanical strength.



### Panel mounting

- Mounting systems prevent loosening of the screws.



### Security locking system

- Seismic locking system.
- Special bars and handle to prevent any accidental door opening under severe vibration conditions.



### Reinforced plinths

- New reinforced monobloc plinths.

New

SF

### Spacial SF 5G solutions for seismic risks



Characteristics	Nominal dimensions (mm)			Load tested (kg)	Plain door	Plain door	100 mm plinth	Mounting plate*	19" rack*
	Two configurations were tested: ■ Control and automation configuration. 250 kg load uniformly distributed over the plain mounting plate at the rear. ■ Configuration with fixed 19" rack. 250 kg load distributed in accordance with a standard (FPR).								
	H	W	D		Without rack				
<b>Spacial SF 5G</b>									
A&C configuration	2000	800	600	250	NSYSF5G20860	NSY5G2SP206	NSYS5GPC86	NSYMP208	-
19" configuration	2000	600	800	250	NSYSF5G20680	NSY5G2SP208	NSYS5GPC86	-	NSYRCK42

\* For plain mounting plate and 19" rack, see information on cubicle reinforcement.  
**NB:** The customer must ensure good cubicle/base connection.

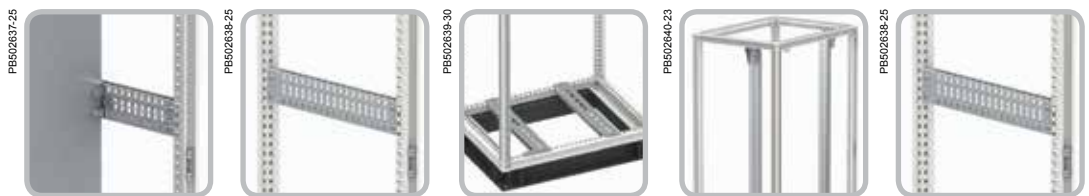

Characteristics	Spacial SF 5G cubicle reinforcement					
	If the following mounting parts are used in SF 5G cubicles: ■ Plain mounting plates; ■ Fixed 19" rack; then it is mandatory to mount the corresponding reinforcing brackets, universal cross rails and heavy-load cross rails in order to ensure the safety and optimal performance of the cubicle and the equipment it contains.					
	<b>A&amp;C configuration (H 2000 mm x W 800 mm x D 600 mm):</b> Mandatory components for reinforcing Spacial SF 5G cubicles with plain mounting plate			<b>19" configuration (H 2000 mm x W 600 mm x D 800 mm):</b> Mandatory components for reinforcing Spacial SF 5G cubicles with fixed 19" rack		
Depth (mm)	Reinforcing bracket for plain mounting plate	Universal cross rails	Heavy-load cross rails	Reinforcing bracket for fixed 19" rack	Universal cross rails	
600	NSY5GSPK	NSYSUCR9060	NSYHLCR60	-	-	
800	-	-	-	NSY5GRCK42	NSYSUCR9080	

New

SF

### Compliance with local standards

#### Level and specifications of the standard

Tested configurations	Spacial SF 5G	Standard Spacial SF (3G)
A&C configuration	NSYSF5G20860 + NSYS5GPC86 + NSY5G2SP206 + NSYMP208 + NSY5GSPK + NSYSUCR9060 + NSYHLCR60	NSYSF20860 + NSYSFPF8100 + NSYS6100 + NSY2SP206 + NSYMP208
19" configuration	NSYSF5G20680 + NSYS5GPC86 + NSY5G2SP208 + NSY5GRCK42 + NSYSUCR9080	NSYSF20680 + NSYSFPF6100 + NSYS6100 + NSY2SP208 + NSYRCK42
<b>Standard</b>		
EDF standard CRT91C11200	Required response spectrum: <ul style="list-style-type: none"> <li>■ Horizontal: <ul style="list-style-type: none"> <li>□ Floor acceleration = 1 g</li> <li>□ Amplified max. acceleration at center of gravity = 5 g</li> </ul> </li> <li>■ Vertical: <ul style="list-style-type: none"> <li>□ Floor acceleration = 0,8 g</li> <li>□ Amplified max. acceleration at center of gravity = 4 g</li> </ul> </li> </ul>	Required response spectrum: <ul style="list-style-type: none"> <li>■ Horizontal: <ul style="list-style-type: none"> <li>□ Floor acceleration = 0,6 g</li> <li>□ Amplified max. acceleration at center of gravity = 3 g</li> </ul> </li> <li>■ Vertical: <ul style="list-style-type: none"> <li>□ Floor acceleration = 0,48 g</li> <li>□ Amplified max. acceleration at center of gravity = 2,4 g</li> </ul> </li> </ul>
AS1170 Australia	All types of soil class / floor zero	Soil type: Ee / Floor zero
EAK 2000 Greece	All types of soil class (delta) Seismic importance factor: $\gamma_i = 1.3$ Ground acceleration factor: $\alpha = 0.36$ Foundation factor: $q = 1$ Quality factor = 1.35 Spectral amplification factor: $\beta_0 = 2.5$	Soil type: D (delta) Seismic importance factor: $\gamma_i = 0.85$ Ground acceleration factor: $\alpha = 0.12$ Foundation factor: $q = 1$ Quality factor = 1.35 Spectral amplification factor: $\beta_0 = 2.5$
ENDESA 1986	All seismic categories Ground acceleration = 0.5 g	Seismic category A 5 % damping Ground acceleration = 0.5 g
RPA 99 2003 Algeria	All types of soil class Ground acceleration factor A = 0.36 Behavior factor R = 2 Quality factor Q = 1.35	Soil type: S4 5 % damping Ground acceleration factor A = 0.15 Behavior factor z = 2 Quality factor z = 1.35
Core GR 63	Zone 4 with a factor of 0.8 for the severity of the vertical component relative to the severity of the horizontal component	5 % damping Zone 3
Turkish Seismic Code 2009	All types of site class Importance factor = 1.5 Ground acceleration factor: A0 = 0.4	Site class: Z4 5 % damping Importance factor = 1.5 Ground acceleration factor: A0 = 0.4
GOST 17516.1-90 Russia	Civil market: MSK (Mercalli) intensity 9, level 2. Nuclear market: MSK (Mercalli) intensity 9, level 0. MSK (Mercalli) intensity 8, level 2.	Standard for the civil market MSK (Mercalli) intensity 9, level 2: enclosure spectrum CRT91C11200
IEEE 693	High level	-

New

SF

### Spacial SFP 5G solutions for seismic risks



Characteristics		Nominal dimensions (mm)			Additional load tested (kg)	Plain door	Side panels	100 mm plinth
		Two configurations of the Spacial SFP 5G cubicle were tested. Functional systems were installed on the cubicle and inspected at the end of the test to check that there was no damage. The two test configurations were as follows:						
		<ul style="list-style-type: none"> <li>■ 1600 A configuration;</li> <li>■ 3200 A configuration.</li> </ul>						
		H	W	D				
Spacial SFP 5G								
1600 A configuration	Spacial SFP	2000	700	500	350	NSYSFP5G20750	NSY5G2SP205	NSYS5GPC75
	Busbar duct	2000	300	500	350	NSYSF5G20350	NSY5G2SP205	NSYS5GPC35
3200 A configuration	Spacial SFP	2000	700	800	450	NSYSFP5G20780	NSY5G2SP208	NSYS5GPC78
	Busbar duct	2000	300	800	450	NSYSF5G20380	NSY5G2SP208	NSYS5GPC38

**NB:** - The width (300 mm) of the Spacial SFP 5G cubicle for the busbar duct is not compatible with the Spacial SF 5G cubicle.  
 - The customer must ensure good cubicle/base connection.







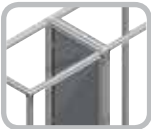

## Compliance with local standards

Level and specifications of the standard		
Tested configurations	Spacial SFP 5G	Spacial SFP Standard
1600 A configuration	2 x NSYSFP5G20750 + NSYS5GPC75 + NSYSFP5G20350 + NSYS5GPC35 + NSY5G2SP205 + 2 x NSYSFBK	2 x NSYSFP20750 + NSYSFP20350 + NSY2SP205 + 2 x NSYSFBK
3200 A configuration	2 x NSYSFP5G20780 + NSYS5GPC78 + NSYSFP5G20380 + NSYS5GPC38 + NSY5G2SP208 + 2 x NSYSFBK	2 x NSYSFP20780 + NSYSFP20380 + NSY2SP208 + 2 x NSYSFBK
Standard		
EDF standard CRT91C11200	Required response spectrum: ■ Horizontal: <input type="checkbox"/> Floor acceleration = 1 g <input type="checkbox"/> Amplified max. acceleration at center of gravity = 5 g ■ Vertical: <input type="checkbox"/> Floor acceleration = 0,8 g <input type="checkbox"/> Amplified max. acceleration at center of gravity = 4 g	Required response spectrum: ■ Horizontal: <input type="checkbox"/> Floor acceleration = 0,71g <input type="checkbox"/> Amplified max. acceleration at center of gravity = 3,5 g ■ Vertical: <input type="checkbox"/> Floor acceleration = 0,56 g <input type="checkbox"/> Amplified max. acceleration at center of gravity = 2,8 g
AS1170 Australia	All types of soil class / floor zero	Soil type: Ee / Floor zero
EAK 2000 Greece	All types of soil class (delta) Seismic importance factor: $\gamma_i = 1.3$ Ground acceleration factor: $\alpha = 0.36$ Foundation factor: $q = 1$ Quality factor = 1.35 Spectral amplification factor: $\beta_0 = 2.5$	Soil type: D (delta) Seismic importance factor: $\gamma_i = 0.85$ Ground acceleration factor: $\alpha = 0.12$ Foundation factor: $q = 1$ Quality factor = 1.35 Spectral amplification factor: $\beta_0 = 2.5$
ENDESA 1986	All seismic categories Ground acceleration = 0.5 g	Seismic category A 5 % damping Ground acceleration = 0.5 g
RPA 99 2003 Algeria	All types of soil class Ground acceleration factor A = 0.36 Behavior factor R = 2 Quality factor Q = 1.35	Soil type: S4 5 % damping Ground acceleration factor A = 0.15 Behavior factor = 2 Quality factor Q = 1.35
Core GR 63	Zone 4 with a factor of 0.8 for the severity of the vertical component relative to the severity of the horizontal component	5 % damping Zone 3
Turkish Seismic Code 2009	All types of site class Importance factor = 1.5 Ground acceleration factor: $A_0 = 0.4$	Site class: Z4 5 % damping Importance factor = 1.5 Ground acceleration factor: $A_0 = 0.4$
GOST 17516.1-90 Russia	Civil market: MSK (Mercalli) intensity 9, level 2. Nuclear market: MSK (Mercalli) intensity 9, level 0. MSK (Mercalli) intensity 8, level 2.	Standard for the civil market MSK (Mercalli) intensity 9, level 2: enclosure spectrum CRT91C11200
IEEE 693	High level	-

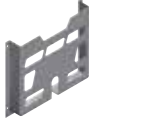
New

SF

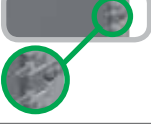
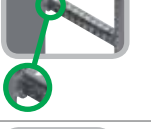
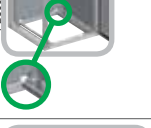
## Compatibility of accessories in seismic cubicles

Accessories	Compatibility	Comments	Trade references impacted
 <p>PB500528-20</p>	Limited	Not compatible with 19" racks or uprights	NSYPPS●●●
 <p>PB500611-16</p>	Not compatible with SFP 5G	-	NSYSDT●
 <p>PB500485-13</p>	Not compatible	-	NSYSDP●M
 <p>PB500464-12</p>	Limited	NSYDPA5, NSYDPA4 and NASYDPA44 are compatible with 500, 600 and 800 mm doors NSYDPA3 is only compatible with 800 mm doors Not compatible with Prisma doors	NSYDPA●●
 <p>PB500613-16</p>	Not compatible with SFP 5G Limited with SF5G	SF 5G not compatible in standard position	NSYSDRC
 <p>PB500477-6</p>	Limited with SF/SFP 5G	Not compatible at the back of the enclosure	NSYMP●●●
 <p>PB500794-21</p>	Not compatible	-	NSYIMP●●
 <p>PB500765</p>	Not compatible	-	NSYSMPFB
 <p>PB500787</p>	Not compatible	-	NSYMPFA
 <p>PB500791</p>	Not compatible	-	NSYSMPSB
 <p>PB500800-21</p>	Not compatible	-	NSYSMPE●

**NB:** None of the accessories is certified 5G.

New

S3D

> **Spacial S3D 6G** cubicles are designed to withstand earthquakes up to UBC zone 4.



### Strength

- Panel thickness:
- Casing + door: 20/10 mm;
- Entry flange: 15/10 mm.



### Security locking system

- EDF 1600 security locking system with captive key.



### Reinforced mounting plate

- Mounting plate reinforcement.
- Increased number of attachment points.



### Wall mounting

- Reinforced bracket for wall mounting.

New

S3D

### Spacial S3D 6G solutions for seismic risks



Characteristics	Spacial S3D 6G
	Seismic applications up to UBC zone 4.
Material	Steel
Supply	<ul style="list-style-type: none"> <li>■ Monobloc casing (cross structure)</li> <li>■ Gutter-shaped front profile</li> <li>■ Flat back</li> <li>■ Plain door with EDF 1600 captive key lock</li> <li>■ &lt; H 600: 1 fastening point</li> <li>■ ≥ H 600: 3 fastening points with connecting rods</li> <li>■ 120° door opening</li> <li>■ Mounting plate galvanized before mounting</li> <li>■ Entry flange</li> <li>■ Two wall mounting brackets</li> <li>■ M6 x 16 earthing screws for equipotential connection between the cubicle door and casing</li> <li>■ Non-reversible door (for reversibility, please contact us)</li> </ul>
Finish	<ul style="list-style-type: none"> <li>■ Structured finish, epoxy-polyester powder</li> <li>■ Two coats of paint</li> <li>■ Paint 87 % decontaminatable by fission products (in accordance with NF T 30-501)</li> </ul>
Colour	RAL 7035
Panel thickness	<ul style="list-style-type: none"> <li>■ Casing &amp; door: 20/10 mm</li> <li>■ Entry flange: 15/10 mm</li> </ul>
Ingress protection rating	IP65
Mechanical protection rating	IK10
Standards	IEC 62208 (enclosure) - 60529 (IP) - 60262 (IK) - 60068
Certifications	6G certification as per CRT 91-C-112-00 (EDF)
<b>Dimensions H x W x D (mm)</b>	<b>References</b>
300 x 250 x 150	<b>NSYS3D6G32515P</b>
400 x 300 x 200	<b>NSYS3D6G4320P</b>
600 x 500 x 250	<b>NSYS3D6G6525P</b>
700 x 500 x 250	<b>NSYS3D6G7525P</b>
800 x 600 x 300	<b>NSYS3D6G8630P</b>
1200 x 800 x 400	<b>NSYS3D6G12840P</b>

**NB:** The customer must ensure good cubicle/base connection.



Characteristics	Locks for cubicle		Padlocking lug
	≤ H 600	> H 600	
	With captive key.	With captive key.	Securing of cubicle access.
Material	Zamak lock and metal cam	Polyamide handle, metal connecting rods and cam	White galvanized steel
Supply	1- or 3-point lock with 1 lock button and 1 cremone bolt	3-point lock with 1 lock button and 1 cremone bolt	-
<b>References</b>			
-	-	-	<b>NSYAEDLPADS3DK3</b>
EDF 900	<b>NSYAEDLEDF9K31</b>	<b>NSYAEDLEDF9K33</b>	-
EDF 1300	<b>NSYAEDLEDF13K31</b>	<b>NSYAEDLEDF13K33</b>	-
EDF 1400	<b>NSYAEDLEDF14K31</b>	<b>NSYAEDLEDF14K33</b>	-
1242E	<b>NSYAEDL1242K31</b>	<b>NSYAEDL1242K33</b>	-
405E	<b>NSYAEDL405K31</b>	<b>NSYAEDL405K33</b>	-
455E	<b>NSYAEDL455K31</b>	<b>NSYAEDL455K33</b>	-



New

S3D

### Compliance with local standards









#### Level and specifications of the standard

Standard	
EDF standard M12D0168610	"Large equipment" MRI RRS: <ul style="list-style-type: none"> <li>■ Horizontal:                             <ul style="list-style-type: none"> <li>□ Floor acceleration = 2 g (1.8 g on the TRS)</li> <li>□ Amplified max. acceleration at center of gravity = 5 g</li> </ul> </li> <li>■ Vertical:                             <ul style="list-style-type: none"> <li>□ Floor acceleration = 2.4 g (2 g on the TRS)</li> <li>□ Amplified max. acceleration at center of gravity = 6 g</li> </ul> </li> </ul>
AS1170 Australia	All types of soil class / floor zero
EAK 2000 Greece	All types of soil class (delta) Seismic importance factor: $\gamma_i = 1.3$ Ground acceleration factor: $\alpha = 0.36$ Foundation factor: $q = 1$ Quality factor = 1.35 Spectral amplification factor: $\beta_0 = 2.5$
ENDESA 1986	All seismic categories Ground acceleration = 0.5 g
RPA 99 2003 Algeria	All types of soil class Ground acceleration factor $A = 0.36$ Behavior factor $R = 2$ Quality factor $Q = 1.35$
Core GR 63	Zone 4 with a factor of 0.8 for the severity of the vertical component relative to the severity of the horizontal component
Turkish Seismic Code 2009	All types of site class Importance factor = 1.5 Ground acceleration factor: $A_0 = 0.4$
GOST 17516.1-90 Russia	Civil market: MSK (Mercalli) intensity 9, level 2. Nuclear market: MSK (Mercalli) intensity 9, level 0. MSK (Mercalli) intensity 8, level 2.
IEEE 693	High level

New

S3D

## Table of Compatibility of accessories in 6G seismic S3D cubicles

Accessories	Compatibility	Comments	Trade references impacted
<small>PB500333-19</small>  Door crosspiece	No	Door provided with a wire guide	<b>NSYTFPCRN●</b>
<small>PB500329-25</small>  Canopy	No	Not compatible due to brackets	<b>NSYTJ●●●</b>
<small>PB500322-11</small>  19" rack	Limited	Conditions: Drilling by customization department to be provided for	<b>NSYVDM●●●●</b>
<small>PB500328-14</small>  Interior door	Limited	Conditions: Drilling by customization department to be provided for	<b>NSYPIN●●</b>
<small>PB500223-25</small>  Door stop	No	-	<b>NSYAEDRSCST</b>
<small>ISPA01_010-43</small>  Door switch	Limited	Conditions: Drilling by customization department to be provided for	<b>NSYINLCRN</b>
<small>PB500083-29</small>  Diagram holder	Yes	-	<b>NSYDPA●●</b>
<small>PB500338-24</small>  Lifting rings	Limited	Conditions: Drilling by customization department to be provided for	<b>NSYAELYTCRG8</b>

**Comment:** None of the accessories is certified 6G.

**New**

➤ The **Spacial S3D 6G K3** cubicle meets K3 requirements in accordance with RCCE 2012.



### Strength

- Panel thickness:
  - Casing + door: 20/10 mm;
  - Entry flange: 15/10 mm.



### Decontaminatable smooth paint, PID 100 series

- In compliance with CCTR 91.C.031.06 Two coats of paint (minimum thickness: 60 μ).
- Epoxy-polyester powder, PID 100 series.
- PIA-PIC 100 on request.



### Security locking system

- EDF 1600 security locking system with captive key.



### Reinforced mounting plate

- Mounting plate reinforcement.
- Increased number of attachment points.



### Earth continuity

Earth continuity between the interior and exterior of the cubicle is provided by 2 opposite welded studs (external earth screw principle).



### Wall mounting

- Reinforced bracket for wall mounting.

New

PE502761SE-46



### Spacial S3D 6G K3 solutions for nuclear applications

Characteristics	Spacial S3D 6G K3
	Seismic application for nuclear power station.
Material	Steel
Supply	<ul style="list-style-type: none"> <li>■ Monobloc casing (cross structure)</li> <li>■ Gutter-shaped front profile</li> <li>■ Flat back</li> <li>■ Plain door with EDF 1600 captive key lock</li> <li>■ &lt; 600: 1 fastening point</li> <li>■ ≥ 600: 3 fastening points</li> <li>■ 120° door opening</li> <li>■ Mounting plate galvanized before mounting</li> <li>■ Entry flange</li> <li>■ Two wall mounting brackets</li> <li>■ M6 x 16 earthing screws and earth strap for equipotential connection between the cubicle door and casing</li> <li>■ Earth continuity between the interior and exterior of the cubicle is provided by 2 opposite welded studs (external earth screw principle)</li> <li>■ Non-reversible door (for reversibility, please contact us)</li> </ul>
Finish	<ul style="list-style-type: none"> <li>■ Epoxy-polyester powder</li> <li>■ Decontaminatable paint: PID 100 series</li> <li>■ On request: PIA 100 series and PIC 100 series</li> </ul>
Colour	<ul style="list-style-type: none"> <li>■ RAL 7035</li> <li>■ Other shades in PIA-PID 100 series, PIC 100 series. Please contact us</li> </ul>
Ingress protection rating	IP65
Mechanical protection rating	IK10
Standards	IEC 62208, IEC 60529, IEC 62262, IEC 60068
Certifications	<ul style="list-style-type: none"> <li>■ 6G certification</li> <li>■ Meets K3 requirements in accordance with RCCE 2012</li> <li>■ EDF reference documents:                             <ul style="list-style-type: none"> <li><input type="checkbox"/> CCTR paint and FNP file;</li> <li><input type="checkbox"/> RCC-E: Electrical equipment construction code;</li> <li><input type="checkbox"/> Packaging technical specification;</li> <li><input type="checkbox"/> "PMUC" (products and materials used in nuclear generating stations)</li> </ul> </li> </ul>
<b>Dimensions H x W x D (mm)</b>	<b>References</b>
300 x 250 x 150	<b>NSYS3D32515PK3</b>
400 x 300 x 200	<b>NSYS3D4320PK3</b>
600 x 500 x 250	<b>NSYS3D6525PK3</b>
700 x 500 x 250	<b>NSYS3D7525PK3</b>
800 x 600 x 300	<b>NSYS3D8630PK3</b>
1200 x 800 x 400	<b>NSYS3D12840PK3</b>

PE502763-10



PE502764-6











PE502765

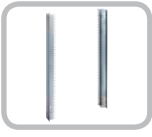

Characteristics	Locks for cubicle		Padlocking lug
	≤ H 600	> H 600	
Material	With captive key. Zamak lock and metal cam	With captive key. Polyamide handle, metal connecting rods and cam	Securing of cubicle access. White galvanized steel
Supply	1- or 3-point lock with 1 lock button and 1 cremone bolt	3-point lock with 1 lock button and 1 cremone bolt	-
<b>References</b>			<b>NSYAEDLPADS3DK3</b>
-	-	-	-
EDF 900	<b>NSYAEDLEDF9K31</b>	<b>NSYAEDLEDF9K33</b>	-
EDF 1300	<b>NSYAEDLEDF13K31</b>	<b>NSYAEDLEDF13K33</b>	-
EDF 1400	<b>NSYAEDLEDF14K31</b>	<b>NSYAEDLEDF14K33</b>	-
1242E	<b>NSYAEDL1242K31</b>	<b>NSYAEDL1242K33</b>	-
405E	<b>NSYAEDL405K31</b>	<b>NSYAEDL405K33</b>	-
455E	<b>NSYAEDL455K31</b>	<b>NSYAEDL455K33</b>	-

New

## Table of Compatibility of accessories in 6G K3 seismic S3D cubicles

Accessories	Compatibility	Comments	Trade references impacted
 <p>PB50033-19</p>	No	Door provided with a wire guide	NSYTFPCRN●
 <p>PB500329-26</p>	No	Not compatible due to brackets	NSYTJ●●●
 <p>PB50032-11</p>	Limited	Conditions: Drilling by customization department to be provided for	NSYVDM●●●●
 <p>PB500328-14</p>	Limited	Conditions: Drilling by customization department to be provided for	NSYPIN●●
 <p>PB50023-26</p>	No	-	NSYAEDRSCST
 <p>ISPA01_010-43</p>	Limited	Conditions: Drilling by customization department to be provided for	NSYINLCRN
 <p>PB500083-29</p>	Yes	-	NSYDPA●●
 <p>PB500398-24</p>	Limited	Conditions: Drilling by customization department to be provided for	NSYAELYTCRG8

**Comment:** None of the accessories is certified 6G K3.

New

### 1 > Special dimensions

We meet the K3 requirements as per RCCE 2012 for the special dimensions mentioned below. These dimensions appear in the Reference File.

Height	Available depths				Width							
1200					200/250/300/400		200/250/300					
1000					200/250/300/400		200/250/300/400					
800					200/250/300		200/250/300		200/250/400		200/250/300/400	
700					200/250/300		200/300		200/250/300/400			
600					200/250/300		200/300		200/250/300/400			
500	150/200		150/200/250		200/250/300		200/250/300					
400	150/200		150/250									
300	200		150/200/250									
	250		300		400		500		600		800	

### 2 > Cut-outs

We meet the K3 requirements as per RCCE 2012 for the cut-outs mentioned below. These cut-outs appear in the Reference File.

#### Customization areas ensuring K3 certification

Door

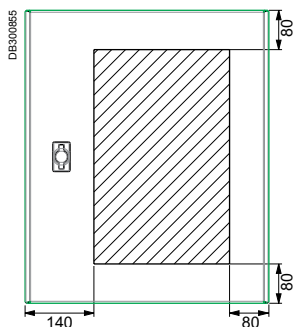

Entry flange

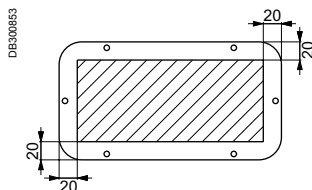

Casing

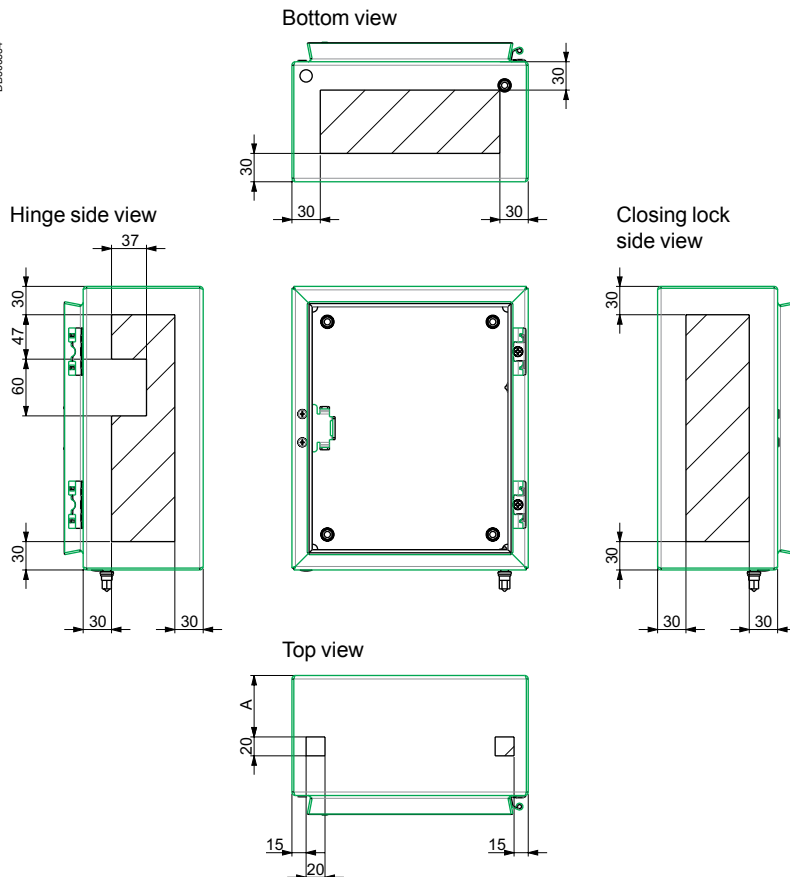

Depth	A
150	65
200	82
250	98
300	115
400	148

New

### 3 > Paints

Referencing of the following paints in the FNP (national paint file):

AFNOR / RAL	Colors of PIA-PID 100 series
AFNOR	1550
	1570
	2550
	2570
RAL	1003
	5005
	5024
	7036

AFNOR / RAL	Colors of PIC 100 series
AFNOR	1550
	1570
	2550
	2570
RAL	1003
	5005
	5024
	7036

Others colors available: consult us.

### 4 > Packaging

We can produce a special corrosion protection packaging (Gardac type).



# Seismic and nuclear enclosures

## A demanding nuclear market

New

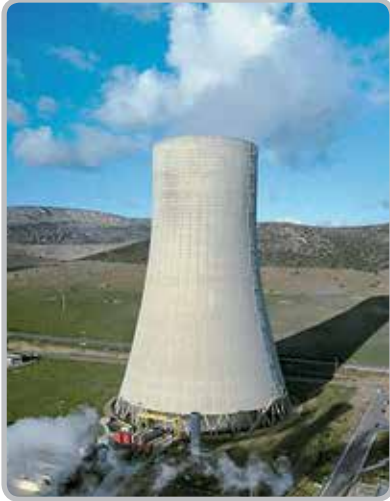

Our range of **Spacial 3D nuclear** cubicles meets the K3 requirements of RCCE 2012. The Schneider Electric cubicle production plant has established processes to ensure K3 certification.

➤ Establishment of a line architecture adapted to the requirements mentioned in RCCE 2012, implying:

- Hold points;
- Check points;
- Control of "AIP" activities that are important for protection

➤ Manufacturing completion report with:

- Declaration of conformity.
- Monitoring document.
- Report and test report.

➤ Establishment of a Particular Quality Assurance Plan (PQAP)

➤ Reference documents for the nuclear industry: RCC-E, CCTR, FNP, packaging technical specification, "PMUC" (products and materials used in nuclear generating stations), SGAQ-2013-03, Arrêté INB 2012



New

### Nuclear safety has 3 objectives

Control reactivity

Cool the fuel

Confine radioactive products

### Technical choices and safety rules

The technical choices and safety rules are stipulated by the operator with full responsibility relative to the French nuclear safety authority (ASN) (representing the state) depending on the location in the installation and whether or not they form part of the safety circuits. The products undergo tests to ensure their operation in accidental conditions.



A safety circuit consists of several equipment items. Their certification depends on their location. Equipment interfacing between the core and the other buildings is always K1 (risk of radioactive leakage).

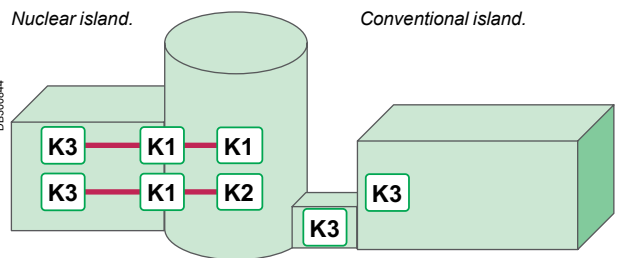

### Certifications necessary to work in the nuclear industry

2 certifications are necessary to work in the nuclear industry

- Product and equipment certifications imply demanding performances validated by technical documents and by tests. In the event of a change in the product, it must be **explained and justified** that the initial certification is maintained.
- Certifications of industrial organizations and services related to products and equipment.

The products equipping French nuclear facilities in this catalogue comply with the RCC-E 2012 standard.

### Terminology of equipment classifications used in nuclear power stations

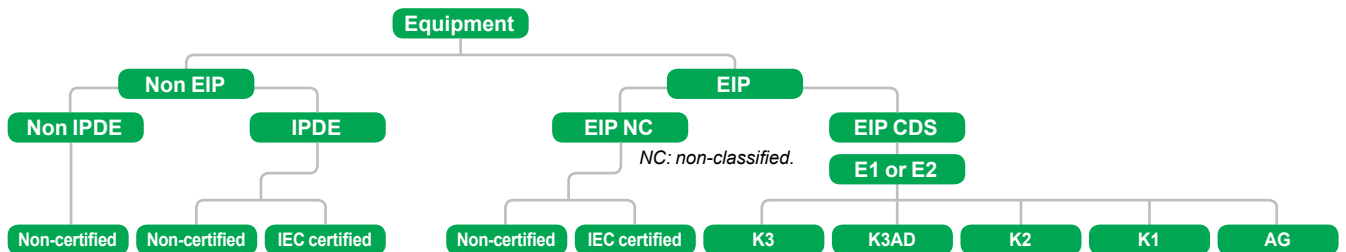

EIP: Equipment Important for Protection.  
 IPDE: Important for operating availability.  
 CDS: safety-classified.  
 Schneider is concerned only by E1 (elec. classification).

### Tests corresponding to specific classifications for EIP equipment

- K3 > ref. tests + functional operating limits + ageing + earthquake
- K3AD > K3 + environmental resistance (irradiation, heat, spraying)
- K2 > K3 + resistance to ageing irradiation (250 Kgy)
- K1 > K2 + resistance to accidental irradiation (600 Kgy) + ADR
- AG > K1 reinforced only for EPR power stations

# Electromagnetic protected steel enclosures

## Introduction

### General

The increasing presence of electromagnetic interference in industrial environments, together with the use of equipment susceptible to such interference requires the use of suitably protected enclosures.

In order to suppress electromagnetic interference, S3HF enclosures, due to the type of sheet metal and special gaskets used, fulfil two functions:

- Provision of adequate screening, with the effectiveness of a Faraday cage.
- Ability to provide effective protection of sensitive equipment by using galvanised sheet metal chassis, and by following recommended installation procedures.

### Electromagnetic interference

Electromagnetic disruptions comprises an electrical field E generated by a differing potentials, and a magnetic field M, caused by current circulation, which combine to form electromagnetic field.

The electromagnetic interference or "noise" is a disruptive electrical signal which affects the useful signal and it likely to cause a malfunction.

Interference can be carried through the conductors or emitted through the environment.

### Main sources of electrical interference and equipment sensitive to it

- Programmable controllers.
- Electronic circuits or boards.
- Regulators.
- Input signal cables (detectors, sensors, measurement probes).
- Analogue signal cables.

#### Main sources of electrical interference

Material	Frequency range
Motors	10 kHz... 100 MHz
Transformers/rectifiers	10 kHz... 100 MHz
Inductive load switching	50 kHz... 10 MHz
Spot welders	10 kHz... 50 MHz
Fluorescent lamps	100 kHz... 3 MHz
Relays, contactors	10 kHz... 200 MHz
Switching power sources	10 kHz... 30 MHz
Computers (internal clock)	50 kHz... 200 MHz
Variable speed drives	10 kHz... 100 MHz
Induction furnaces	0... 10 kHz
Power cables, etc.	0... 10 kHz

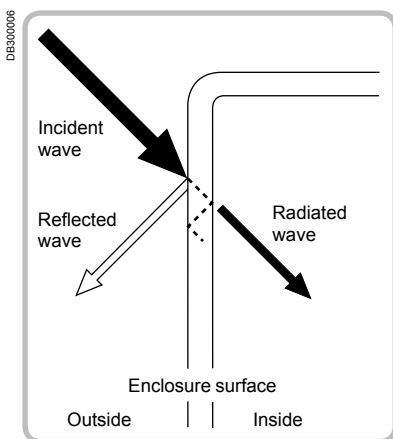

### Attenuation level of EMC fields

The waves of electrical or magnetic fields are reflected when they meet the sheet metal of the enclosure.

The effective rate of the screening or dampening "a" of the incident wave is measured in decibels (dB) using the following formulae:

$$a = 20 \log \frac{E_0}{E_1} \text{ (dB) for electrical fields,}$$

$$a = 20 \log \frac{H_0}{H_1} \text{ (dB) for magnetic fields,}$$

- $E_0$  and  $E_1$  are the current values of the electrical field, before entering and after entering the enclosure respectively.
- $H_0$  and  $H_1$  are the magnetic field values.

# Electromagnetic protected steel enclosures

## Introduction

### Installation

According to the type of interference generated by the devices:

- Low frequencies, "conducted interference" (up to 30 MHz),
  - High frequencies, "radiated interference" (higher than 1 MHz),
- the rules to be taken into account relate to the choice of components that provide the most economical solution to complete the installation.

#### Low-frequency interference

- Importance of the protection systems:
  - filters, overvoltage suppressor, isolating transformer for the power supply,
  - cable length.

#### High-frequency interference

- Importance of the installation method:
  - earth connections, cable length and section,
  - cable selection and rules, cable runs, connections,
  - enclosures and installation.

### Specifics

#### Screen connections

It is recommended to earth screens at both ends. In addition, it is advisable to increase the number of intermediate earth connections.

If the screen is only earthed at one end, there can be a considerable difference in potential between the two ends. In addition, this screen will be ineffective against external high-frequency interference.

#### Transformers

The transformer chassis must be mounted, metal to metal, on the reference potential plate, that is, on a plain chassis supporting the equipment.

#### Cable runs

The metal ducts and conduits, when correctly connected, provide an extremely effective second screen for the cables.

Cable ends must be screwed to the metal enclosures in order to provide an effective connection.

#### Enclosures

The interfering and sensitive components, cables etc. should be installed in separate enclosures or located at some distance from each other.

*Note: For further information, consult your local sales office or our educational leaflet entitled "Electromagnetic compatibility".*

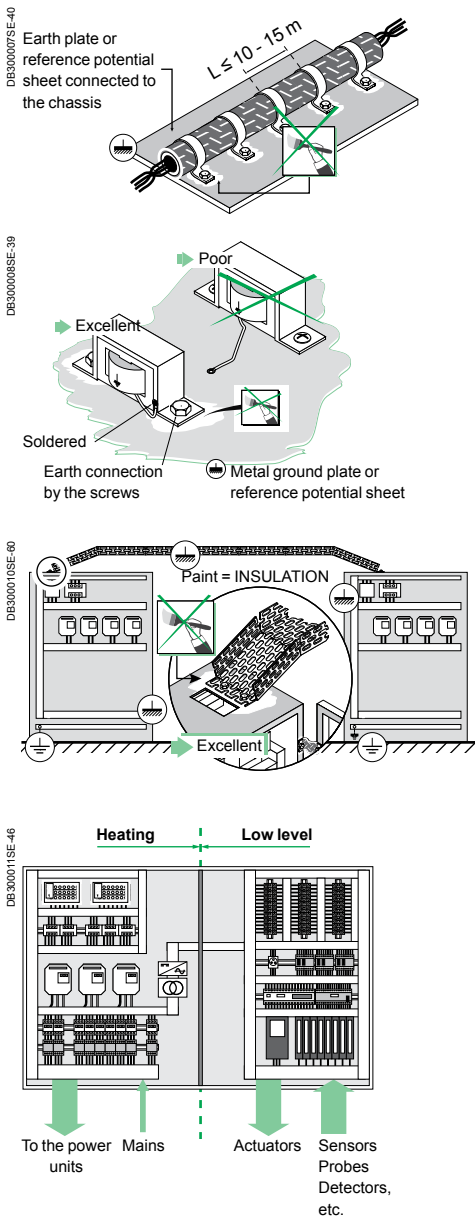

# Electromagnetic protected steel enclosures

## Introduction

PE50205-46



EMC box, IP55.

### Spacial S3HF wall-mounting enclosure IP55 IK10

From H 400 x W 300 x D 200 to H 1200 x W 800 x D 300 mm

- Metal monobloc enclosures constructed from special ALU-ZINC 150 sheet. Body constructed from single folded and welded sheet.
- The enclosure surface, comprising 55 % aluminium ensures good reflection of radiated electromagnetic interference.
- Textured epoxy polyester external paint finish, colour grey RAL 7035.
- Integral, galvanised, sheet steel, plain chassis (reference potential plate). The low resistivity of this plate facilitates earth continuity. Special body/door gasket (IP + EMC) providing both environment protection and continuity between the door and body of the enclosure. Body completely sealed, without any cable entries or apertures. Integral earth braid between enclosure body and door, ensuring good earthing and, in consequence, good electromagnetic compatibility. Metal closing points with earth continuity, thus improving overall screening.

PE501663-46



EMC enclosure, IP55.

### Spacial SMHF floor-standing enclosure IP55 IK10

From H 1800 x W 800 x D 400 to H 2000 x W 800 x D 600 mm

- Metal monobloc enclosure constructed from special ALU-ZINC 150 sheet. The enclosure surface, comprising 55 % aluminium ensures good reflection of radiated electromagnetic interference.
- Exterior painted with an epoxy polyester external powder paint finish, colour grey RAL 7035.
- Integral galvanised sheet steel plain chassis (sheet potential reference). The earth continuity is much easier thanks to its weak resistance.
- Special body-door seal (IP + EMC), providing not only water tightness, but also electrical continuity between the door and the body, necessary for those assemblies. Cable gland plate with special built-in seal (IP + EMC).

PE501662-46



EMC floor-standing enclosure, IP55.

### Spacial SFHF suitable enclosure IP55 IK10

From H 1800 x W 600 x D 600 to H 2200 x W 800 x D 800 mm

- Metal, extendable enclosure constructed thanks to a closed triangular profile, door and panel from special ALU-ZINC 150 sheet. The enclosure surface, comprising 55 % aluminium ensures good reflection of radiated electromagnetic interference.
- Exterior painted with an epoxy polyester external powder paint finish, colour grey RAL 7035.
- Integral galvanised sheet steel plain chassis (sheet potential reference). The earth continuity is much easier thanks to its weak resistance.
- Special body/door gasket (IP + EMC) providing both environmental protection and electrical continuity between the door and body of the enclosure.
- Integral earth braid between enclosure body and door, ensuring good earthing and, in consequence, good electromagnetic compatibility.
- The suite joining set is also available for the EMC enclosures, IP55.

This range can be configured according to your needs

4 different services available:



Assemble to order



Mounting of standard accessories



Painting



Machining

See page 396 for details or consult our web site [www.schneider-electric.com](http://www.schneider-electric.com)

# Electromagnetic protected steel enclosures

## Introduction

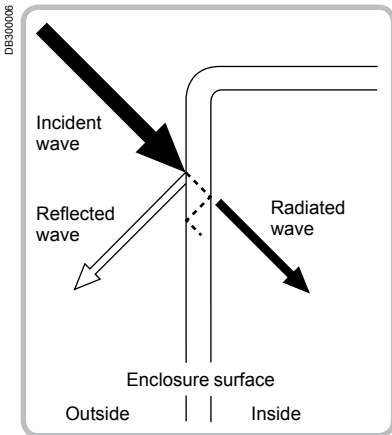

The presence of 55 % aluminium on the surface of the sheet metal ensures good reflection of electromagnetic waves.

The next illustrations indicates the attenuation (dB) curves related to the frequency (MHz).

### Attenuation of the Spacial S3HF enclosure

General information on Electromagnetic Compatibility, see pages 338 and 339.

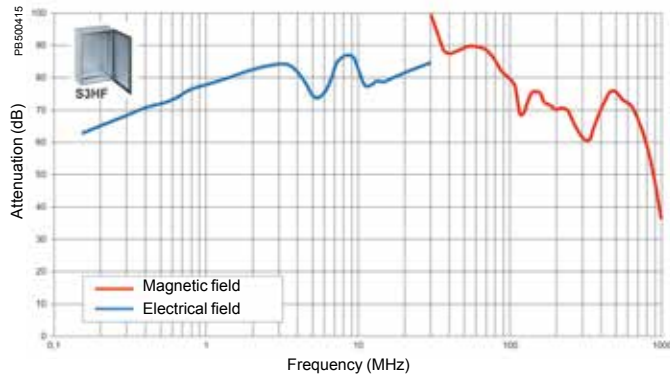

### Floor-standing compact enclosure

The enclosure is tested with earth braids mounted on all claddings (test performed following IEC 61587-3).

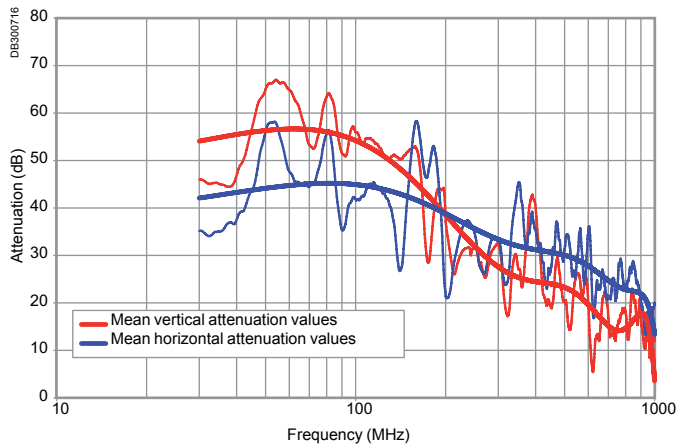

### Floor-standing suitable enclosure

Enclosure is tested with its sides panels and earth braids mounted on all claddings (Test performed following IEC 61587-3).

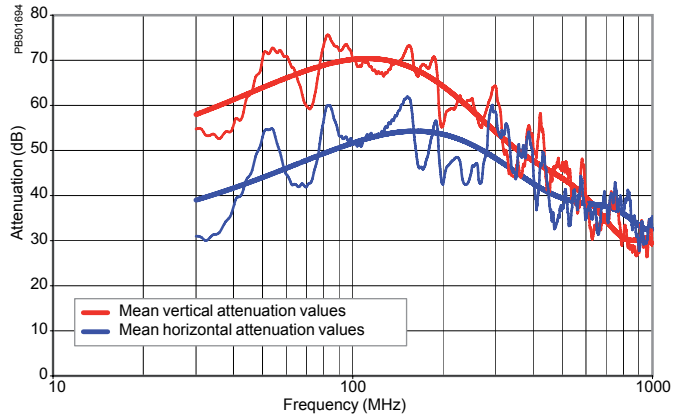

# Electromagnetic protected steel enclosures

## Characteristics



Characteristics			Spacial S3HF		
			Single-piece metal enclosures made from special sheets of ALUZINC 150. The presence of 55 % aluminium on the surface of the sheet metal ensures good reflection of electromagnetic waves.		
			<b>■ Body</b> <input type="checkbox"/> single-piece body, folded and welded, <input type="checkbox"/> entirely sealed body with no cable entry and no opening.		
			<b>■ Equipped with four shouldered backstuds allowing direct mounting of the mounting plate</b> <input type="checkbox"/> built-in plain mounting plate made from galvanised sheet steel (potential reference sheet), <input type="checkbox"/> its low resistivity promotes earth continuity, <input type="checkbox"/> direct mounting or using wall-mounting brackets, ref. <b>NSYPFCR</b> (to be ordered separately).		
			<b>■ Door</b> <input type="checkbox"/> the special body-door gasket (IP + EMC) provides, in addition to water and dust tightness, electric continuity between the door and the body of the enclosure, <input type="checkbox"/> the metal lock with earth continuity helps improve the general shielding, <input type="checkbox"/> an earthing braid added to the enclosure between the body and the door guarantees a good earth connection and, consequently, good electromagnetic compatibility, <input type="checkbox"/> 3 mm double-bar lock as standard delivery (if a 405 key is needed it is possible to mount ref. <b>NSYCLL405CRN</b> ).		
			<b>■ Enclosure delivered with solid mounting plate.</b> Other sizes: consult us.		
Finish			Painted on the outside with epoxy-polyester resin		
Colour			RAL 7035 grey		
Ingress protection rating			IP55		
Mechanical protection rating			IK10		
Certifications			-		
Mounting			Mounting brackets, ref. <b>NSYPFCR</b> to be ordered separately (1 set of 4 lugs)		
Height (mm)	Width (mm)	Depth (mm)	Fig.	Weight (kg)	References
400	300	200	1	7.5	<b>NSYS3HF4320P</b>
	600	200	1	13.0	<b>NSYS3HF4620P</b>
500	400	200	2	11.5	<b>NSYS3HF5420P</b>
600	400	200	2	13.0	<b>NSYS3HF6420P</b>
	600	250	2	20.5	<b>NSYS3HF6625P</b>
700	500	250	2	19.0	<b>NSYS3HF7525P</b>
800	600	300	2	32.8	<b>NSYS3HF8630P</b>
1000	800	300	2	53.2	<b>NSYS3HF10830P</b>
1200	800	300	2	59.0	<b>NSYS3HF12830P</b>
		600	-	-	-
		800	-	-	-
1800	600	600	-	-	-
		400	-	-	-
		600	-	-	-
	800	400	-	-	-
		600	-	-	-
		800	-	-	-
		1000	-	-	-
2000	600	400	-	-	-
		600	-	-	-
		800	-	-	-
2200	800	400	-	-	-
		600	-	-	-
		800	-	-	-
		800	-	-	-



# Electromagnetic protected steel enclosures

## Dimensions

### Spacial S3HF

A: Height.  
B: Width.  
C: Depth.

Fig. 1

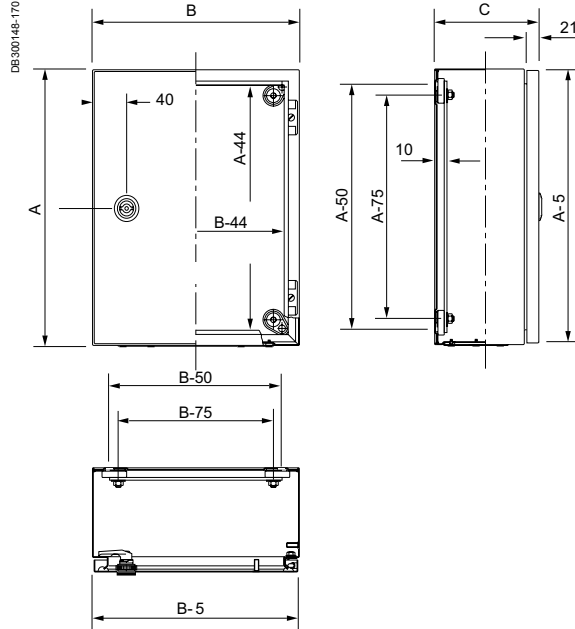
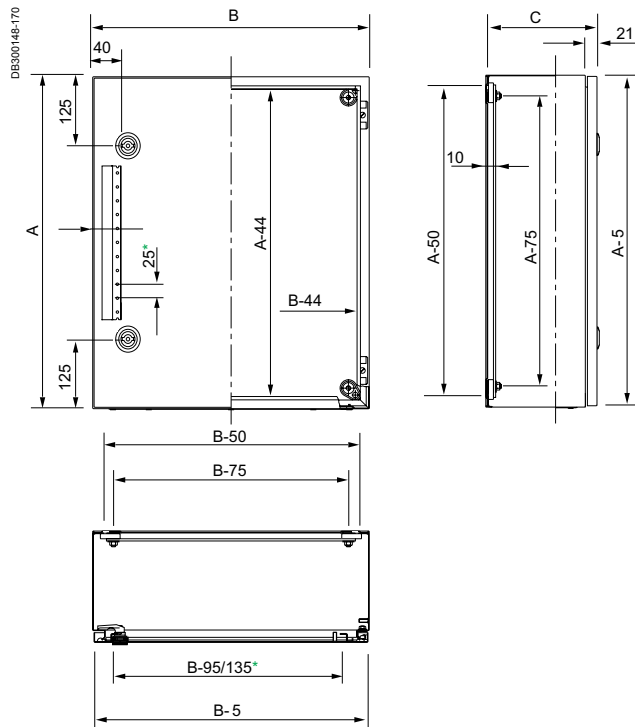

Fig. 2



\* Model 1200 x 800.



# Electromagnetic protected steel enclosures

## Dimensions

### Spacial SMHF

A: Height.  
B: Width.  
C: Depth.

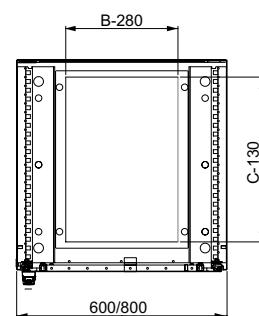
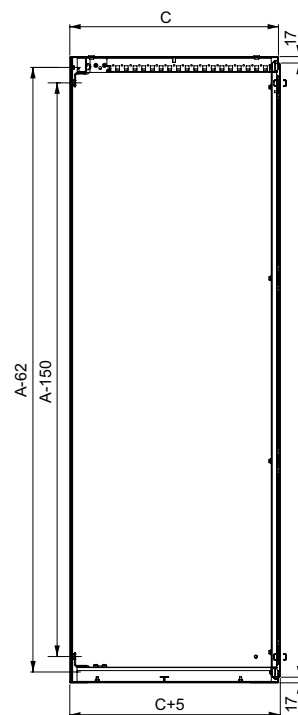
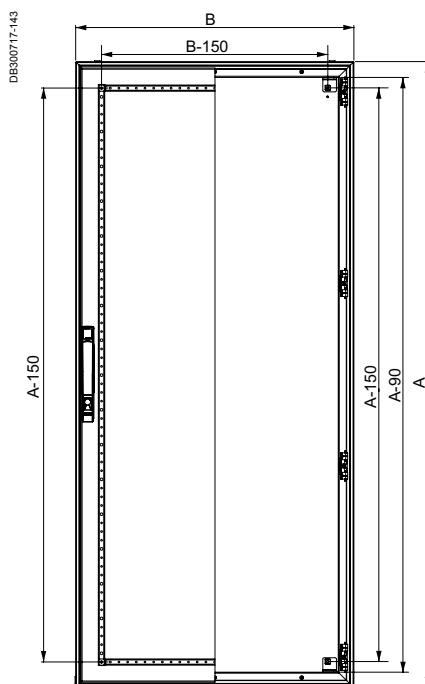

# Electromagnetic protected steel enclosures

## Dimensions

### Spacial SFHF

A: Height.  
B: Width.  
C: Depth.

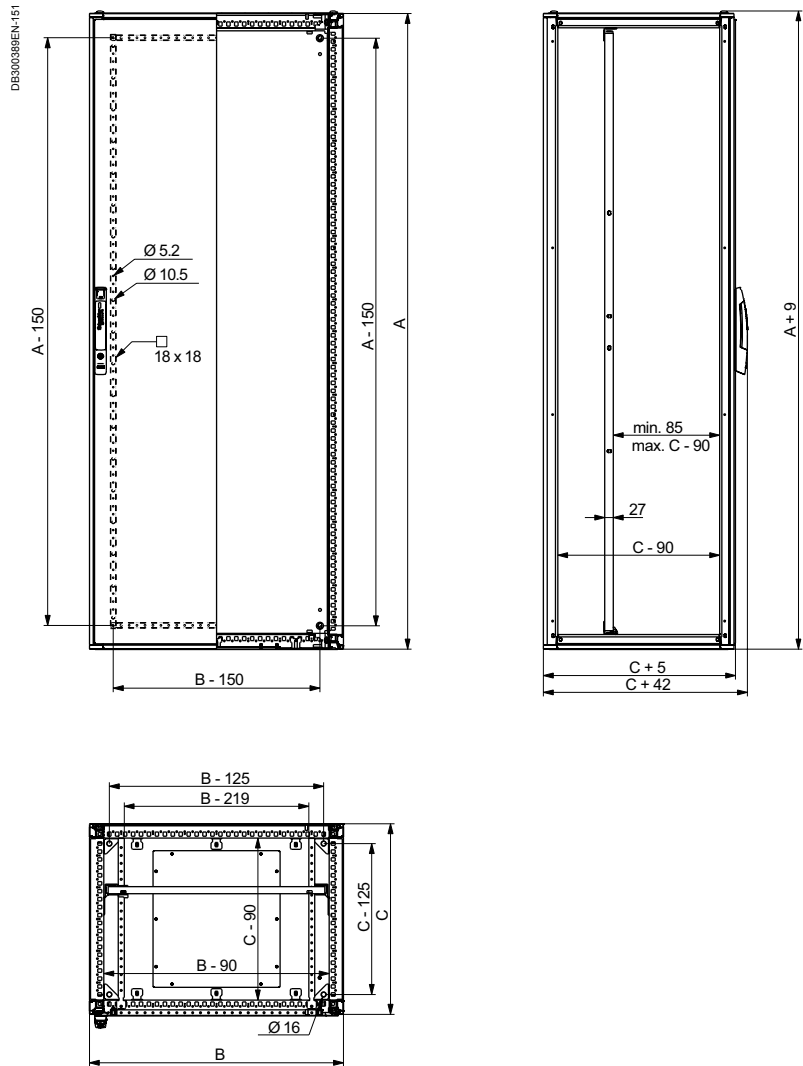

# Electromagnetic protected steel enclosures

## Accessories



### All mounting accessories are compatible with the SF and SM standard range.

- Mounting plate (see page 220).
- Rails (see page 230).
- 19" frame (fixed and swinging) (see page 326).

PE500084-49



### Earth braids

- They guarantee the earth connection for high frequencies, avoiding the disturbing electric currents that are produced.
- **Material:** tinned copper.
- **Supply:** 10 earth braids (nuts and washers not included).

Length (mm)	Width (mm)	Section (mm <sup>2</sup> )	Terminal Ø (mm)	References
150	12	6	6.5	<b>NSYEB156D6</b>
	17	10	6.5	<b>NSYEB1510D6</b>
155	17	16	6.5	<b>NSYEB1516D8</b>
	200	27	25	6.5
		33	50	6.5

PE5000513-49



### EMC coupling kit

- Used to join enclosures side-by-side or depthwise. Special gasket for EMC solution. Attenuation level is decreased by 5 db when enclosures are joined (please consult us).
- **Ingress protection rating:** IP55.

Height (mm)	Depth (mm)	Ref. SM EMC
1800	400	<b>NSYSFHFBK184</b>
	600	<b>NSYSFHFBK186</b>
2000	400	<b>NSYSFHFBK204</b>
	600	<b>NSYSFHFBK206</b>
	800	<b>NSYSFHFBK208</b>
	1000	<b>NSYSFHFBK2010</b>
2200	600	<b>NSYSFHFBK226</b>
	800	<b>NSYSFHFBK228</b>

# Enclosures for explosive atmospheres

## Introduction

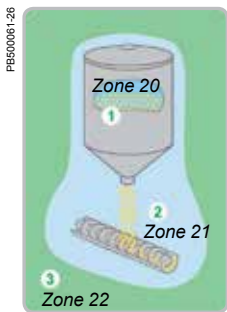
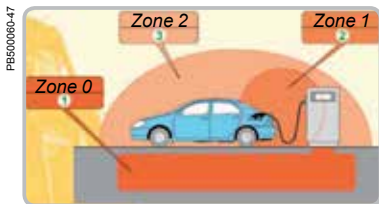
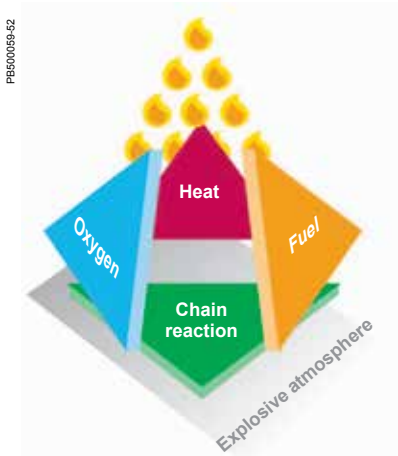

### Potentially explosive atmospheres: important information

#### > What is ATEX?

- It is a term commonly used to describe potentially EXplosive ATmospheres and standards for protection systems and equipment.
- Two European directives, ATEX 99/92/CE and ATEX 94/9/CE, and international standards IEC 60079 and IEC 61241, harmonized with EN European standards, apply to this field.

#### > How is a potentially explosive atmosphere defined according to ATEX?

- An potentially explosive atmosphere is defined as a mix of flammable substances in the form of gas, vapour, dust (cloud or deposit) which, in air and under normal atmospheric conditions, can completely or partially catch fire in the form of an explosion when exposed to a source of ignition.

#### > Classification of an explosive atmosphere

- They are classified into groups and zones according to directive 99/92/CE and IEC standards as follows:

Destination	Categories/presence of potentially explosive atmosphere	Hazardous zones	Atmosphere
Group I Mines	M1 and M2	Gas and dust (G & D)	
Group II surface Industries	1 Permanent or frequent	Zone 0: gas and vapour	G
		Zone 20: mist and dust	D
	2 Occasional	Zone 1: gas and vapour	G
		Zone 21: mist and dust	D
	3 Rare	Zone 2: gas and vapour	G
		Zone 22: mist and dust	D

### Equipment for potentially explosive atmospheres

- Since 1st July 2003, European directive ATEX 94/9/CE has made it compulsory to use certified electric or non-electric equipment when it must be installed in zones with explosive atmospheres (gas or dust).
- Certification must be provided by a body which is notified according to the same directive.
- The body notifies its assessment of the quality of the production and certifies that the product complies with the health and safety demands defined in the directive and the international standards.
- The certificate shows the category of the product by marking, and thus the zone and atmosphere in which it can be used.
- The standards define the following types of protection for electric equipment:

Electrical equipment				
CENELEC	IEC	Gas: symbol of the types wof protection	CENELEC/IEC	Powder: symbol of the types of protection
EN 60079-0	IEC 60079-0	General rules	IEC/EN 61241-0	General rules
EN 50015	IEC 60079-6	0-oil immersion	IEC/EN 61241-1	tD-protection by enclosures
EN 50016	IEC 60079-2	p-pressurised enclosures	IEC/EN 61241-4	pD-protection by pressurisation
EN 50017	IEC 60079-5	q-powder filling	IEC/EN 61241-11	iD-protection by intrinsic safety
EN 60079-1	IEC 60079-1	d-flameproof enclosures	IEC/EN 61241-18	mD-protection by encapsulation
EN 60079-7	IEC 60079-7	e-increased safety		
EN 50020	IEC 60079-11	i-intrinsic safety		
EN 60079-15	IEC 60079-15	n-type of protection "n"		

- Enclosures are certified as components. They will be assembled with other ATEX electrical, pneumatic and hydraulic components, among others to form a final solution which, in turn, must be ATEX-certified and subject to a declaration of conformity.



#### Definition



Product directive 94/9/CE: defines the manufacturers' obligations.



Personal protection directive 99/92/CE: defines the users' obligations.

#### Degree of protection:

In hazardous areas, equipment is required to offer a minimum degree of protection of IP54, but it can be tested or certified with a higher degree of protection.

# Enclosures for explosive atmospheres

## Introduction



### Fields of application of Schneider Electric ATEX enclosures

## > 3 Material solutions for wall-mounting enclosures

Steel

Stainless-steel

Polyester

#### Three types of enclosures

- All the wall-mounting enclosures presented in this brochure comply with standards for protection against the increased risk of explosion in atmospheres charged with gas (G) and/or dust (D).
- The Schneider Electric offer, designed to be used in group II, is classified as category 2.

Destination	Categories/presence of potentially explosive atmosphere	Hazardous zones	Atmosphere
Group I Mines	M1 and M2	Gas and dust (G & D)	
Group II surface Industries	1 Permanent or frequent	Zone 0: gas and vapour	G
		Zone 20: mist and dust	D
	2 Occasional	Zone 1: gas and vapour	G
		Zone 21: mist and dust	D
	3 Rare	Zone 2: gas and vapour	G
		Zone 22: mist and dust	D

*Zone of application of Schneider Electric ATEX wall-mounting enclosures.*

- Category 2 products can be used as category 3.
- Our products are qualified for increased safety "e" (Ex e) but not for explosionproof safety "d" (Ex d).
- The marking of the wall-mounting enclosures is shown page 488.
- The wall-mounting enclosures offer a degree of protection IP66 according to EN 60529, exceeding the recommendations of the ATEX directive.
- Certification of our production sites and inspection procedures guarantees observance and consistency of the quality level.

# Enclosures for explosive atmospheres

## Introduction

PE601817-54



### > Industrial environments, equipment rooms

#### Spacial S3DEX steel enclosure

- The **Spacial S3DEX steel enclosure** is certified by the LCIE with no. LCIE 02ATEX0037U (component certification).
- Ten sizes: from 300 x 200 x 150 mm to 1000 x 800 x 300 mm.
- Degree of protection: IP66.
- Ambient temperature limits:  $-20^{\circ}\text{C} \leq T_a \leq +40^{\circ}\text{C}$ .
- Resistance to external mechanical impacts: IK10.
- Structured finish, epoxy-polyester powder paint, RAL 7035 grey colour.

PE601818-56



### > Laboratories, agri-business industry, specific hygiene and corrosion demands

#### Spacial S3XEX stainless-steel enclosure

- The **Spacial S3XEX stainless-steel enclosure** is certified by the LOM with no. LOM 09ATEX3068U (component certification).
- Seven sizes: from 300 x 200 x 150 mm to 1000 x 800 x 300 mm.
- Degree of protection: IP66.
- Ambient temperature limits:  $-20^{\circ}\text{C} \leq T_a \leq +60^{\circ}\text{C}$ .
- Resistance to external mechanical impacts: IK10.
- Scotch-Brite® brushed finish.

PE601819-58



### > Seaside, petrochemical, severely corrosive environments

#### Thalassa PLMEX polyester enclosure

- The **Thalassa PLMEX polyester enclosure** is certified by the LOM with no. LOM 10ATEX3051U (component certification).
- Seven sizes: from 307 x 255 x 164 mm to 1056 x 852 x 350 mm.
- Degree of protection: IP66.
- Ambient temperature limits:  $-20^{\circ}\text{C} \leq T_a \leq +60^{\circ}\text{C}$ .
- Resistance to external mechanical impacts: IK10.
- Black colour.

### [!] In accordance with the ATEX directive

- The enclosures bear the marking shown page 488.
- The enclosures offer a degree of protection of IP66 according to EN 60629, reaching the highest dust protection according to ATEX standards.
- The certification of our production sites and inspection procedures guarantees the observance and regularity of the quality level.

Protective of all applications in ATEX II2 or II3 areas –surface installations with occasional or rare risks– thanks to ATEX-certified steel, stainless-steel and polyester enclosures.

# Enclosures for explosive atmospheres

## Introduction

PB500411-32



**Personnel safety**  
Blind nut for external earth connection.

PB500407-32



Earthing studs welded to the door and inside the body.

PB502596-32



**Robust**  
The chassis is mounted on four 10-mm shouldered backstuds.

PB500413-32



The 4 mounting holes are blocked by 4 crimped blind nuts.

DB300871

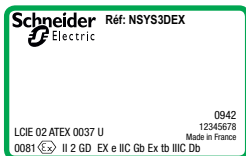

**Label**  
Example of specific ATEX marking (description: page 488).

DB300073-Z7

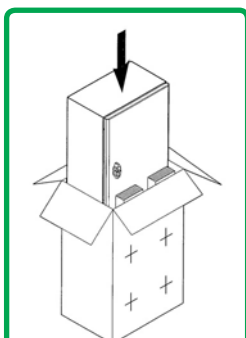

Delivered in reusable cardboard with assembly instructions enclosed.

# Enclosures for explosive atmospheres

## Characteristics, accessories



Characteristics	Spacial S3DEX	Spacial S3XEX
	<p>The enclosures have the following marks:                      Ⓢ II 2 GD Ex e IIC Gb Ex tb IIIC Db IP6X according to ATEX directive 94/9/EC and standards EN 60079-0, EN 60079-7, EN 60079-31.</p> <p>Compared with the universal Spacial wall-mounting enclosure, the Spacial S3DEX enclosure has:</p> <ul style="list-style-type: none"> <li>■ The four mounting holes blocked by four crimped blind nuts.</li> <li>■ One crimped M8 blind nut for an external earth connection (braid not supplied).</li> </ul> <p><b>Enclosure body</b></p> <ul style="list-style-type: none"> <li>■ 4 M8 x 25 shouldered backstuds for mounting the mounting plate and the step slides leaving a space of 10 mm behind them.</li> <li>■ Welded earthing stud for equipotential connection between the door and the body.</li> </ul> <p><b>Door</b></p> <ul style="list-style-type: none"> <li>■ Standard enclosure supplied with a double-bar lock.</li> <li>■ Equipotential connection between the door and the body by means of the M6 x 16 earthing screws.</li> <li>■ Removable and reversible door, opening to 120°.</li> <li>■ Simple reversal of linkage.</li> <li>■ Maximum load: 50 kg/m<sup>2</sup>.</li> <li>■ Perforated rails on the door: 2 vertical rails from H = 400 mm, 2 vertical rails and 2 horizontal rails from W = 800 mm.</li> <li>■ Ambient temperature limits: -20°C ≤ Ta ≤ +40°C.</li> </ul>	<p>The enclosures have the following marks:                      Ⓢ II 2 GD Ex e II tD A21 IP6X according to ATEX directive 94/9/EC and standards EN 60079-0, EN 60079-7, EN 61241-0 and EN 61241-1.</p> <ul style="list-style-type: none"> <li>■ Single-piece body (cross-shaped structure). Gutter-shaped front profile.</li> <li>■ 2 perforated vertical profiles on the door (from a height of 600 mm), with drill holes with a diameter of 4.25 mm and a pitch of 25 mm for installing accessories.</li> <li>■ Door reinforcement frame (from a height of 1000 mm), cross-section of 20 mm x 15 mm, with drill holes with a diameter of 5 mm and a pitch of 25 mm.</li> <li>■ Standard closure with 3-mm double-bar lock (chrome-plated zamak).</li> <li>■ 2 closure points for heights of more than 500 mm.</li> <li>■ Stainless-steel hinges screwed onto the body of the enclosure, making it easier to remove and invert the door. Opening angle: 120°.</li> <li>■ M6 x 16 screws on the door and on the body, allowing equipotential connection.</li> <li>■ The wall-mounting brackets are compulsory; they are blocked by sealing plugs. The 4 mounting holes are blocked by 4 crimped blind nuts.</li> </ul> <p>□ 304 stainless-steel: reference <b>NSYPFCX</b>.</p> <p>□ 316L stainless-steel: reference <b>NSYPFC2X</b>.</p> <ul style="list-style-type: none"> <li>■ One crimped M6 blind nut for an external earth connection (braid not supplied).</li> <li>■ Authorised ambient temperature limits: -20°C ≤ Ta ≤ +60°C.</li> </ul>
Material	Steel	Stainless-steel material AISI 304L (316L on request)
Finish	Structured finish, epoxy-polyester powder paint	Scotch-Brite® brushed finish
Colour	RAL 7035 grey	-
Ingress protection rating	IP66 (enclosures with single door)	IP66
Mechanical protection rating	IK10	IK10



The accessories of the Spacial standard wall-mounting enclosures can be installed in the Spacial S3DEX wall-mounting enclosures. However, plastic accessories should not be used, due to the risk of a static charge.



The accessories of the Spacial S3X enclosure can be installed in the Spacial S3XEX enclosure. However, plastic accessories should not be used, due to the risk of a static charge.



Characteristics			Spacial S3DEX	Spacial S3XEX	Thalassa PLMEX	Accessories	
Dimensions (mm)						Mounting plates	
Height	Width	Depth	References			Plain	Silkscreened
300	200	150	NSYS3DEX3215	NSYS3XEX3215	-	NSYMM32	-
	300	200	NSYS3DEX3320	-	-	NSYMM33	-
308	255	160	-	-	NSYPLMEX3025	NSYMM3025	-
400	300	200	NSYS3DEX4320	NSYS3XEX4320	-	NSYMM43	NSYMS43
	400	200	NSYS3DEX4420	-	-	NSYMM44	NSYMS44
430	330	200	-	-	NSYPLMEX43	NSYMM43	NSYMS43
500	400	200	NSYS3DEX5420	NSYS3XEX5420	-	NSYMM54	NSYMS54
530	430	200	-	-	NSYPLMEX54	NSYMM54	NSYMS54
600	400	200	-	NSYS3XEX6420	-	NSYMM64	NSYMS64
		250	NSYS3DEX6425	-	-	NSYMM64	NSYMS46
	250	NSYS3DEX6625	-	-	-	NSYMM66	NSYMS66
647	436	250	-	-	NSYPLMEX64	NSYMM64	NSYMS64
700	500	250	NSYS3DEX7525	NSYS3XEX7525	-	NSYMM75	NSYMS75
747	536	300	-	-	NSYPLMEX75	NSYMM75	NSYMS75
800	600	250	-	NSYS3XEX8625	-	NSYMM86	NSYMS86
		300	NSYS3DEX8630	-	-	NSYMM86	NSYMS86
847	636	300	-	-	NSYPLMEX86	NSYMM86	NSYMS86
1000	800	300	NSYS3DEX10830	NSYS3XEX10830	-	NSYMM108	-
1056	852	350	-	-	NSYPLMEX108	NSYMM108	-





Characteristics	Thalassa PLMEX		
	The enclosures have the following marks: Ⓢ II 2 GD Ex e II Ex tD A21 IP66 according to ATEX directive 94/9/EC and standards EN 60079-0, EN 60079-7, EN 61241-0 and EN 61241-1. <b>Specific ATEX characteristics</b> ■ The surface resistance is < 109 Ω. ■ Ambient temperature limits: -20°C ≤ Ta ≤ +60°C. ■ The enclosures must be fixed by 4 stainless-steel lugs, which are mounted in inserts to be placed on the rear of the enclosure, in horizontal or vertical position. Ref.: <b>NSYPFXPLM</b> .		
Colour	RAL 9004 black		
Ingress protection rating	IP66		
Mechanical protection rating	IK10		
<b>References</b>	<b>NSYPLMEX3025</b>	<b>NSYPLMEX43/54/64/75/86</b>	<b>NSYPLMEX108</b>
Built-in canopy	No	Yes	Yes
Opening	120°	180°	180°
Pins	Stainless-steel	Polyamide	Stainless-steel
Locking system	2 double-bar lock	2 double-bar lock	1 lock with doublebar insert and 4-point closure
Lock outside sealed zone	No	Yes	Yes
Notch system for DIN rails every 25 mm	No	Yes	Yes
Mounting plate assembly	Installed studs	Inserts and studs	Inserts and studs



Accessories for Thalassa PLM enclosures can be installed in Thalassa PLMEX enclosures. However, plastic accessories should not be used, due to the risk of a static charge.

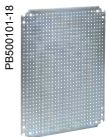

	Microperforated		Telequick	Mixed symmetrical chassis	Wall-mounting brackets		Step slides	Padlocking
					Steel	Stainless-steel		
	-		NSYMR32	-	NSYAEFPFSC	NSYAEFPFXSC	-	-
	NSYMF33		NSYMR33	NSYMD33	NSYAEFPFSC	NSYAEFPFXSC	NSYSDCR200	-
	-		NSYMR3025	-	-	NSYPFXPLM	-	-
	NSYMF43		NSYMR43	NSYMD43	NSYAEFPFSC	NSYAEFPFXSC	NSYSDCR200	-
	NSYMF44		-	-	NSYAEFPFSC	NSYAEFPFXSC	NSYSDCR200	-
	NSYMF43		NSYMR43	-	-	NSYPFXPLM	NSYDPLM200	NSYKPLM
	NSYMF54		NSYMR54	NSYMD54	NSYAEFPFSC	NSYAEFPFXSC	NSYSDCR200	-
	NSYMF54		NSYMR54	-	-	NSYPFXPLM	NSYDPLM200	NSYKPLM
	NSYMF64		NSYMR64	NSYMD64	-	NSYPFXPLM	NSYSDCR200	-
	NSYMF64		NSYMR64	NSYMD64	NSYAEFPFSC	NSYAEFPFXSC	NSYSDCR250	-
	NSYMF66		NSYMR66	NSYMD66	NSYAEFPFSC	NSYAEFPFXSC	NSYSDCR250	-
	NSYMF64		NSYMR64	-	-	NSYPFXPLM	NSYDPLM250	NSYKPLM
	NSYMF75		NSYMR75	NSYMD75	NSYAEFPFSC	NSYAEFPFXSC	NSYSDCR250	-
	NSYMF75		NSYMR75	-	-	NSYPFXPLM	NSYDPLM300	NSYKPLM
	NSYMF86		NSYMR86	NSYMD86	-	NSYPFXPLM	NSYSDCR250	-
	NSYMF86		NSYMR86	NSYMD86	NSYAEFPFSC	NSYAEFPFXSC	NSYSDCR300	-
	NSYMF86		NSYMR86	-	-	NSYPFXPLM	NSYDPLM300	NSYKPLM
	NSYMF108		NSYMR108	NSYMD108	NSYAEFPFSC	NSYAEFPFXSC	NSYSDCR300	-
	NSYMF108		NSYMR108	-	-	NSYPFXPLM	NSYDPLM350	NSYBCPL

# Enclosures for explosive atmospheres

## Dimensions

### Spacial S3DEX

#### 1-door enclosure

A: Height  
B: Width  
C: Depth

- (1) 4 M8 x 25 mm backstuds.
- (2) 2 M6 x 17.5 mm earthing studs.
- (3) Stud centre-to-centre distance.
- (4) Crimped blind nut centre-to-centre distance.
- (5) Blind nut for external earth.

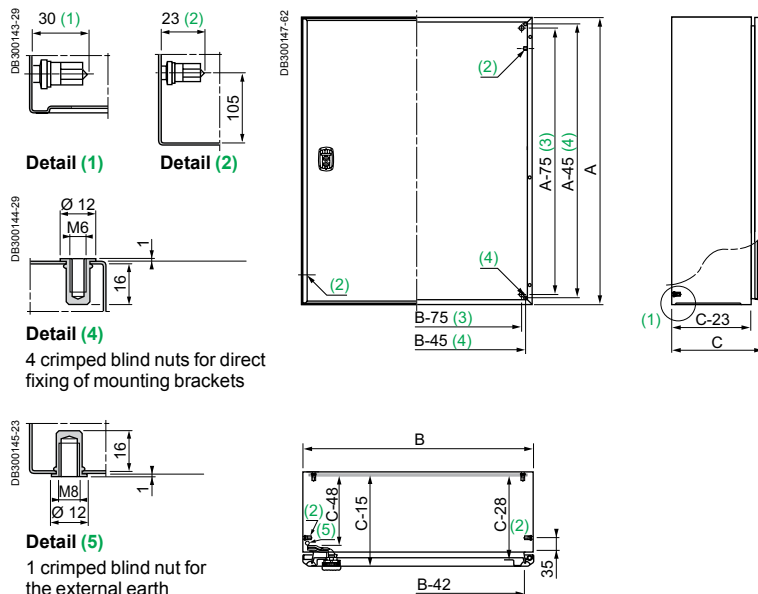

#### Perforated rails on the door

Enclosure (8)		Perforated rails on the door (mm)			
Height (A) (mm)	Width (B) (mm)	Vertical		Horizontal	
		F	D	E	C
400	300	320	237	-	-
	400	320	337	-	-
600	400	370	337	-	-
	600	370	537	-	-
700	500	470	437	-	-
800	600	570	537	-	-
1000	800	770	737	620	949

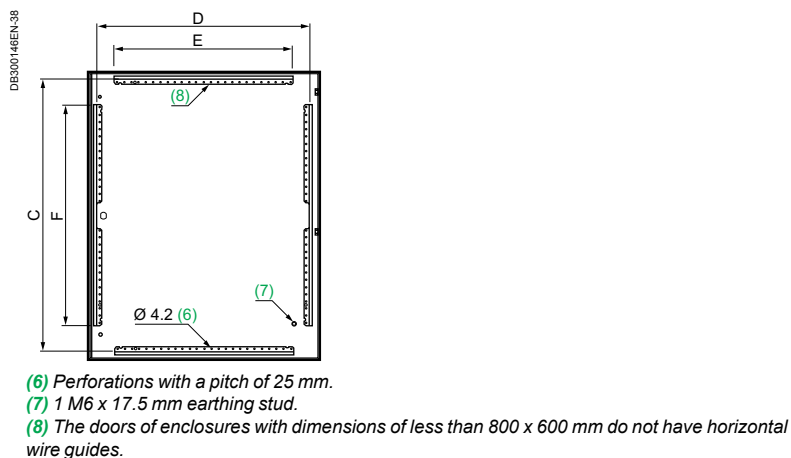

### Spacial S3XEX

Fig. 1

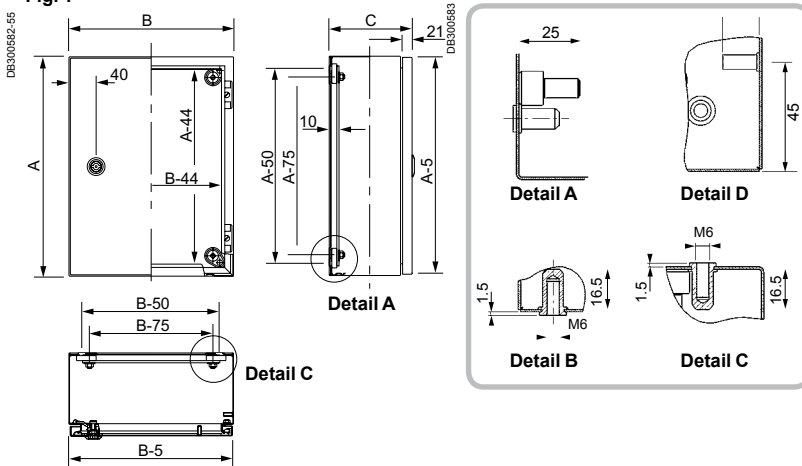

# Enclosures for explosive atmospheres

## Dimensions

### Spacial S3XEX

External dimensions (mm)			
Height (A)	Width (B)	Depth (C)	Fig.
300	200	150	1
400	300	200	1
500	400	200	2**
600	400	200	2
700	500	250	2
800	600	250	2
1000	800	300	3

\*\* Without door reinforcement.

Fig. 2

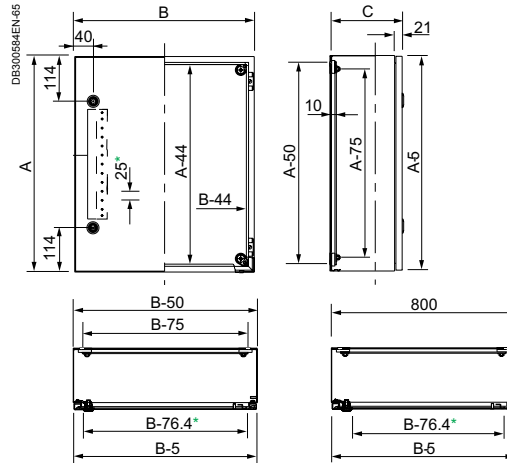

\* Door reinforcement.

Fig. 3

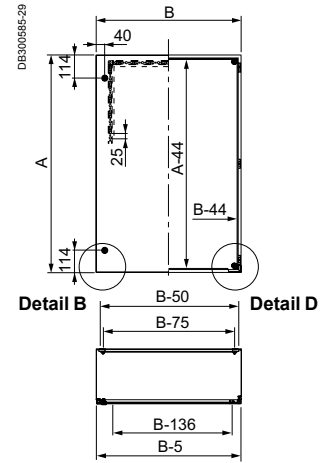

### Thalassa PLMEX

NSYPLMEX3025

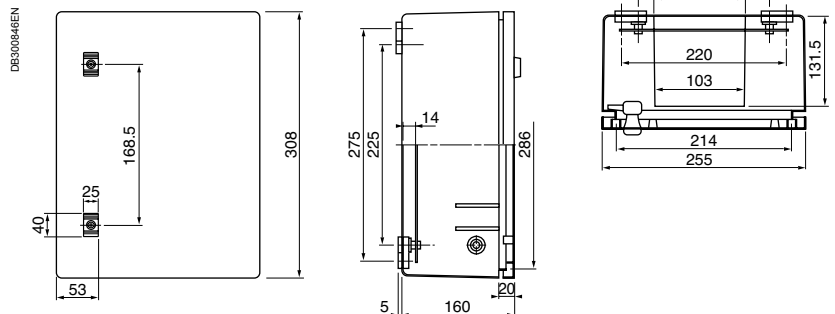

NSYPLMEX43/54/64/75/86/108

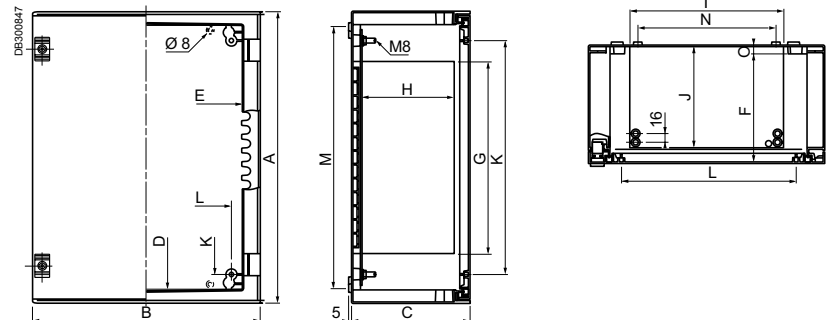

Dimensions (mm)											Bottom screw and door bosses	Fixing	References
A	B	C	D	E	F	G	H	I	J	K	L	O	
430	330	200	380	260	181	247	150	179	168	325	225	13	NSYPLMEX43
530	430	200	480	360	181	347	150	279	168	425	325	13	NSYPLMEX54
647	436	250	580	360	228	388	192	279	212	525	325	13	NSYPLMEX64
747	536	300	680	460	278	487	241	379	261	625	425	15	NSYPLMEX75
847	636	300	780	560	278	587	241	479	261	725	525	15	NSYPLMEX86
1056	852	350	980	760	327	775	280	680	300	925	725	15	NSYPLMEX108

## Human-Machine Interface Solutions

Steel

> Indoor non-clean industrial environment

Control enclosure with suspension system



Control Desks



PC racks



Stainless-steel

> Demanding industrial environment

Control Desks



PC racks



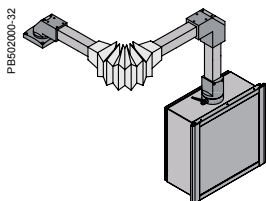

PB502000-32

### Spacial S3CM Control enclosure with suspension system

The Spacial S3CM offer for human-machine interface combines **robustness** with **aesthetics** and **ergonomics**. Consist of:

- **control enclosure,**
- **a keyboard-box,**
- **a suspension system** of arms and joints, for a fixed or rotating solutions,
- **and support accessories.**

> See page 358



PB500086-61

### Spacial SD Control desks

The range of Spacial SD control desks provides all the functions required of a workstation intended for industrial and infrastructure applications.

Spacial SD offers two clearly differentiated solutions:

- **the SD Compact control desk,**
- **the SD Control desk with console.**

The range has protection ratings of IP55 and IK10, which guarantee the safety and the protection of the installed devices.

> See page 368



PB502208-16

### Spacial SF suitable PC rack

The Spacial SF PC rack is designed to protect and control computer equipment in an industrial environments.

Access to the various functions and working heights, guaranteeing optimum comfort. The roof and panels, fixed from the inside, prevent access by unauthorised personnel.

> See page 384



PB501287-30

### Spacial SDX Control desks

The Spacial SDX range of control desks offers all the functions required to set up a control station that meets the industrial or infrastructural needs of applications in harsh environments or in the food and beverage sector.

Easy to implement, compatible with dialogue components, guaranteeing the security and protection of control devices, these control desks, with their range of dimensions, meet the strictest needs of their users.

> See page 369



PB501223-55

### Spacial SMX monobloc PC rack

The stainless-steel monobloc PC racks have been especially designed to protect computer equipment installed in corrosive or specially environments that require washing or exposure to sprays of liquid.

Access to the various functions and working heights, guaranteeing optimum comfort.

> See page 388

➤ The **Spacial S3CM offer** for human-machine dialogue consists of:

- control enclosures
- a box-keyboard
- a system of arms and joints fixed or rotating
- accessories.

The global dialogue system combines robustness with aesthetics and ergonomics.



## Human-Machine Interface Solutions

PB500433-33



### Robust

- 2 tube sizes in extruded steel, 50 and 80 mm square, thickness 40/10° mm.
- Top wall reinforced by a plate with a thickness of 30/10° mm.

PB500418-29



### Aesthetics

- Extruded aluminium rail frame.
- RAL 7040 paint: frame.
- RAL 7035 paint: enclosure.
- Customisation to your image or the aesthetics of your machine: consult us.

PB500446-37



### Ergonomics

Frame designed for handling the enclosure and facilitating the usage by the operator.

PB500439-21



### Easy

Easy access to the equipment by a rear door, opening to 120°.

- Direct installation of accessories on the enclosure frame rail:
  - vertical document support,
  - keyboard support,
  - laptop computer support.
- A box-keyboard is installed directly on the enclosure.

PB500300



### Flexibility

Rotation through 170°; complete range of joints, fixed or rotating.

This range can be configured according to your needs

4 different services available:



Assemble to order



Mounting of standard accessories



Painting



Machining

See page 396 for details or consult our web site [www.schneider-electric.com](http://www.schneider-electric.com)

# Human-Machine Interface Introduction

Every model is suitable for tubes with a square section of:

- 50 mm for medium loads,
- 80 mm for heavy loads

(see selection table on page 366).

## Steps to choose the suspension system (medium or heavy loads)

- 1 - Define the total load of the system\*: a + b + enclosure + installed equipment (Y axis).
- 2 - Define the length of arm L (X axe).
- 3 - Define the configuration:

■ Suspension system **without** intermediate joint.

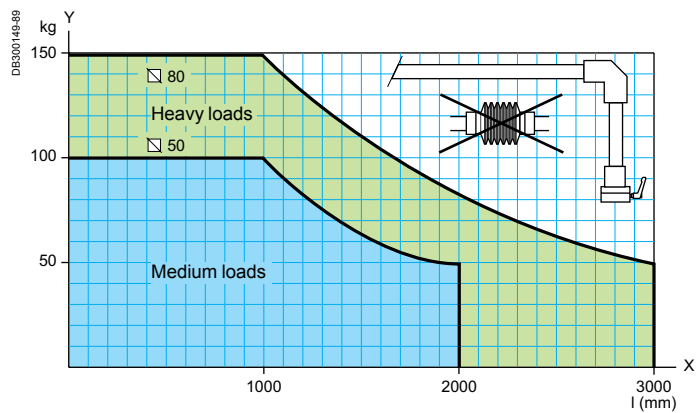
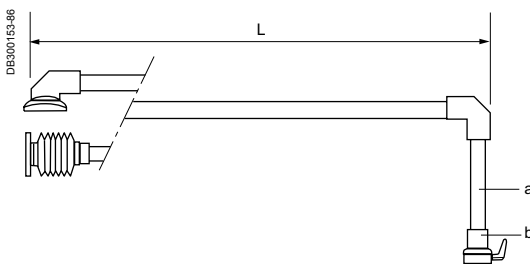

■ Suspension system **with** intermediate joint.

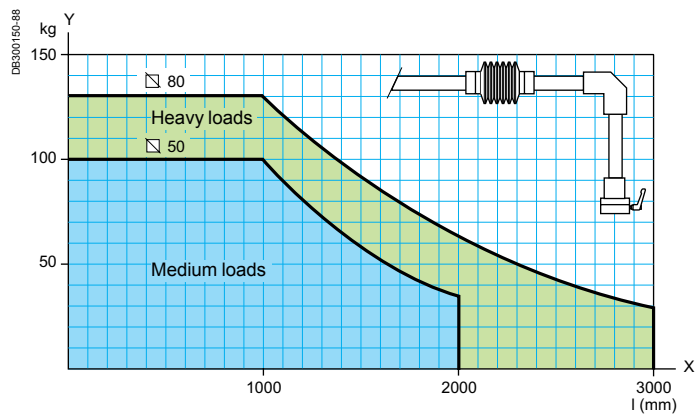
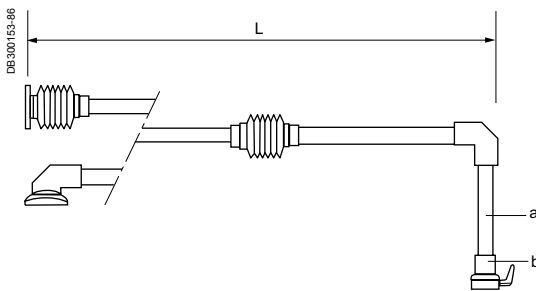

\* The load (a + b + enclosure + installed equipment) must be less than the maximum load.

## ★ Example

- 1 - Total load (kg) = 80 kg.
- 2 - Length (L) = 1200 mm.
- 3 - Suspension system without intermediate joint.

Recommended system  
> Medium loads □ 50.

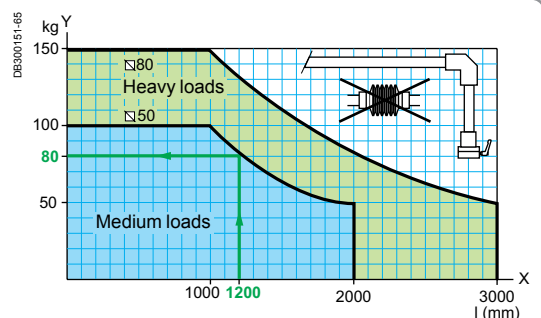

# Human-Machine Interface Characteristics



Perforated rails installed on lateral studs.



Rear door with double-bar lock.



Detail of the reinforcement plate.



Mounting of the trim frame by screws.



Characteristics	Spacial S3CM
-----------------	--------------

The control enclosures consist of:

- A steel body equipped with:
  - reinforcement plate: the top wall is reinforced by a plate (3 mm) and pierced with a hole Ø 54 or 87 mm (according to the reference) to allow hanging installation of the enclosure,
  - 4 welded studs on the 2 inner vertical walls, for mounting rails,
  - 2 rails (with drill holes) for installing equipment,
  - a rear door, opening to 120° and closing with double-bar lock.
- An aluminium front face (2.5 mm thick):
  - this surface is protected on both sides by a plastic film, allowing the installation of the dialogue elements,
  - a trim frame made from 4 extruded-aluminium rails: the frame and the front face are delivered assembled.

Structured finish, epoxy-polyester powder, RAL 7040 grey colour (other colours on demand).

- The design of these rails takes into account the accessory mounting functions (lamp, document support, keyboard support, laptop support, etc.), the ergonomics for handling the enclosure and its overall aesthetics.

Finish	Structured finish, epoxy-polyester powder				
Colour	RAL 7035 grey				
Ingress protection rating	IP54				
Mechanical protection rating	IK10				
Enclosure dimensions (mm)			Enclosure load (kg)	Tube section (mm)	References
Height	Width	Depth			
300	300	200	8.6	50	NSYS3CM303020
	400	200	9.5	50	NSYS3CM304020
400	400	200	11.4	50	NSYS3CM404020
	600	250	17.9	50	NSYS3CM406025*
500	500	250	20.2	50	NSYS3CM505025
600	600	200	26.5	50	NSYS3CM606020*
	800	300	34.9	80	NSYS3CM608030
800	600	300	33.6	80	NSYS3CM806030*

\* Enclosure equipped with a cable-gland plate.



# Human-Machine Interface Dimensions

Enclosure dimensions (mm)								Cable-gland plate	Ø Top hole (mm)	Fig.	Enclosure
Height (A)	Width (B)	Depth (C)	D	F	G	H	J				References
300	300	200	162	262	262	100	45	-	54	1	NSYS3CM303020
	400	200	162	362	262	100	45	-	54	1	NSYS3CM304020
400	400	200	262	362	362	100	45	-	54	1	NSYS3CM404020
	600	250	262	562	362	125	75	■	54	1	NSYS3CM406025*
500	500	250	362	462	462	125	75	-	54	1	NSYS3CM505025
600	600	200	462	562	562	100	45	■	54	1	NSYS3CM606020*
	800	300	462	762	562	150	100	-	87	2	NSYS3CM608030
800	600	300	662	562	762	150	100	■	87	2	NSYS3CM806030*

\* Enclosure equipped with a cable-gland plate.

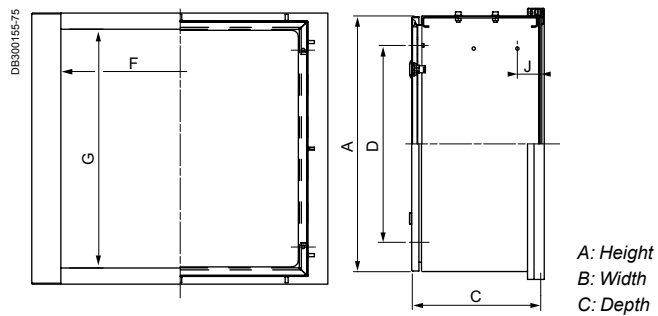
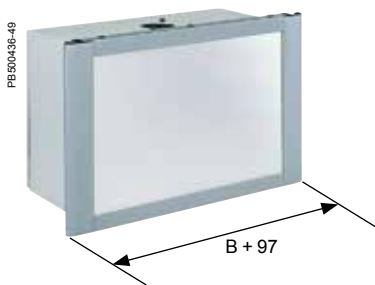

### W600 enclosure + box-keyboard installation

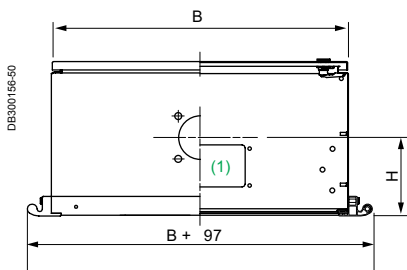

(1) Cable-gland plate.

**Figure 1**  
Enclosure depth from 200 to 250

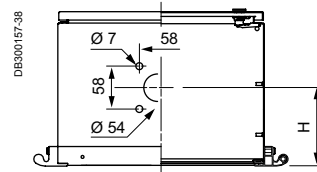

**Figure 2**  
Enclosure depth 300

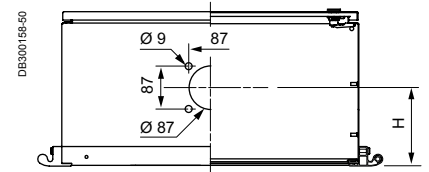

### Box-keyboard for control enclosure



Detail from the installation of the box-keyboard on the control enclosure.

Characteristics		Box-keyboard for control enclosure	
<p>The box is installed on the control enclosures with a width of 600 mm. It then has an angle of 120° with its front face. All the accessories required for installation are delivered with 2 brackets and 1 trim rail, 1 hose for cable entry. The box for the keyboard consists of:</p> <ul style="list-style-type: none"> <li>■ a steel body, structured finish, epoxy-polyester powder, RAL 7035 grey colour, with a screwed cover,</li> <li>■ an aluminium front face (2.5 mm thick) for installing a keyboard,</li> <li>■ a trim frame made from 2 extruded-aluminium rails guaranteeing ergonomic handling of the box and the aesthetics of the unit. The frame and the front face are delivered assembled. Structured finish, epoxy-polyester powder, RAL 7040 grey colour.</li> </ul>			
Ingress protection rating	IP54		
Mechanical protection rating	IK10		
Weight	8 kg		
Reference			
Height (mm)	Width (mm)	Depth (mm)	
250	600	116	<b>NSYCMT2560110</b>

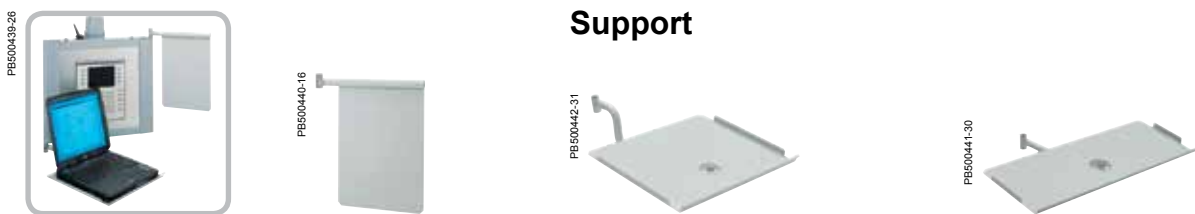

### Support

Characteristics		Support		
		Vertical	Laptop computer	Keyboard
		Installation on the left or right rail of the frame of the control enclosure.		
Material	Sheet steel			
Finish	Structured finish, epoxy-polyester powder			
Colour	RAL 7035 grey			
Thickness	12/10° mm	20/10° mm	20/10° mm	
Weight	1.15	2.04	2.16	
References				
Height (mm)	Width (mm)	Depth (mm)		
315	230	-	<b>NSYCMSP</b>	-
-	350	310	-	<b>NSYCMBPC</b>
-	500	200	-	<b>NSYCMBPT</b>

### Suspension system

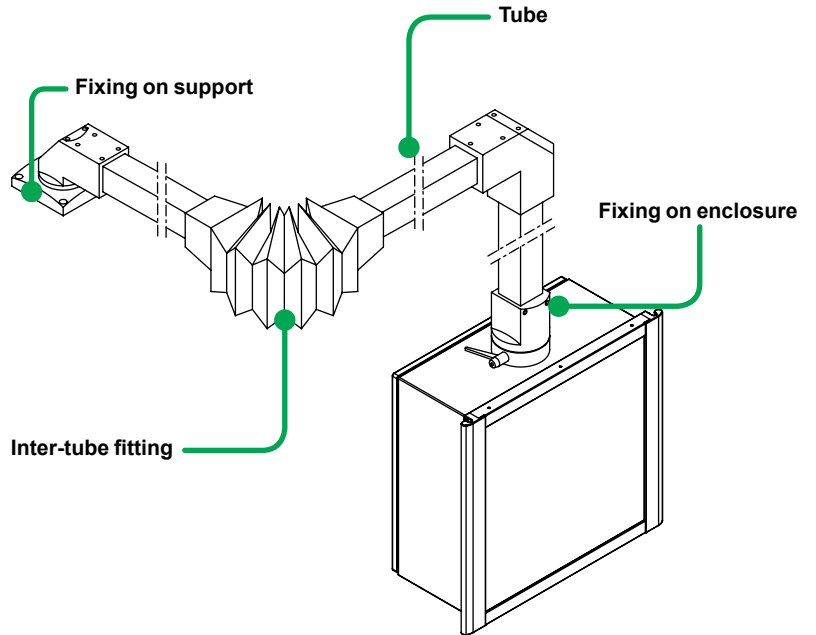

P850042

### Tube

- The tubes are available in:
  - 2 sizes: square of 50 and 80 mm,
  - 4 lengths: 0.5, 1, 1.5 and 2 m.
- **Material:** extruded steel.
- **Finish:** structured finish, powder.
- **Colour:** RAL 7035 grey.
- **Thickness:** 40/10° mm.
- **Weights:**
  - 50 x 80: 6.5 kg/m,
  - 80 x 80: 10.5 kg/m.

Length (m)	50 mm square	80 mm square
0.5	NSYCMT5005	NSYCMT8005
1	NSYCMT5010	NSYCMT8010
1.5	NSYCMT5015	NSYCMT8015
2	NSYCMT5020	NSYCMT8020

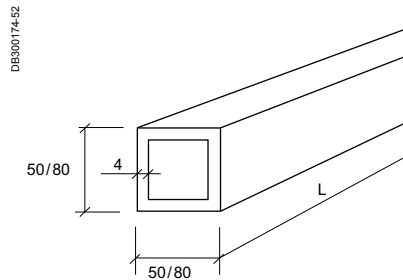

DB300174-52

## Suspension system

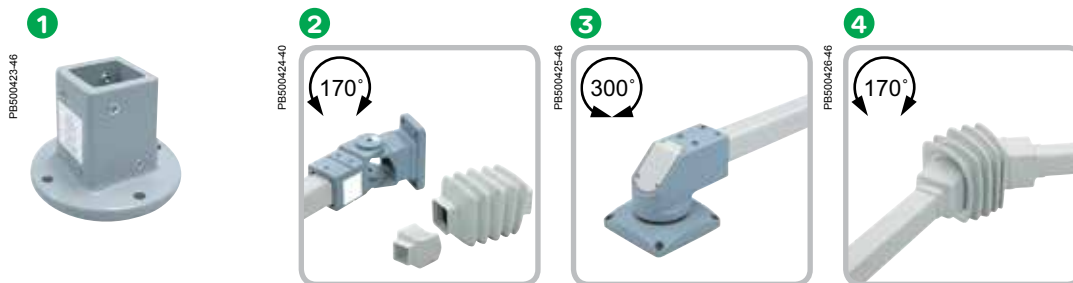

Characteristics	Fixed base		Wall mounting with joint		Rotating straight fitting		Horizontal inter-tube joint	
	Support foot for direct horizontal or vertical connection.		Device allowing rotation through 170° of a horizontal tube, with a square section of 50 or 80 mm, and its mounting on a vertical surface. Protection by bellows, RAL 7035 grey colour. Possibility of passing cables through the inside of the joint.		Device allowing the mounting and rotation through 295° of tubes, with a square section of 50 or 80 mm, in horizontal position. Without blocking the chosen position. Mounting by 4 screws, not included.		Device allowing the linking and rotation through 170° of 2 horizontal tubes, with a square section of 50 or 80 mm. Protection by bellows, RAL 7035 grey colour. Possibility of passing cables through the inside of the joint.	
Material	Moulded steel		Moulded steel		Moulded steel		Moulded steel	
Colour	RAL 7040 grey		RAL 7040 grey		RAL 7040 grey		RAL 7040 grey	
Weight (kg)	3.25	7	4.35	9.45	5.4	15.7	4.25	10
<b>Dimensions (mm)</b>								
∅ A	<b>50 mm square</b>	<b>80 mm square</b>	<b>50 mm square</b>	<b>80 mm square</b>	<b>50 mm square</b>	<b>80 mm square</b>	<b>50 mm square</b>	<b>80 mm square</b>
B	42	72	92	115	50	74	42	72
C	105	134	118	160	68	98	236	320
D	11	11	42	72	42	72	67	94
E	125	173	85	130	30	45	148	190
F	152	201	11	11	96	144	-	-
G	-	-	148	190	96	141.5	-	-
H	72	111	80	115	134	195.5	-	-
I	97	126	130	175	140	210	-	-
J	-	-	55	90	120	180	-	-
K	-	-	68	103	9	13	-	-
L	110	140	105	150	55	84	-	-
S	15	16	-	-	-	-	-	-

**References**

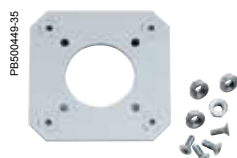
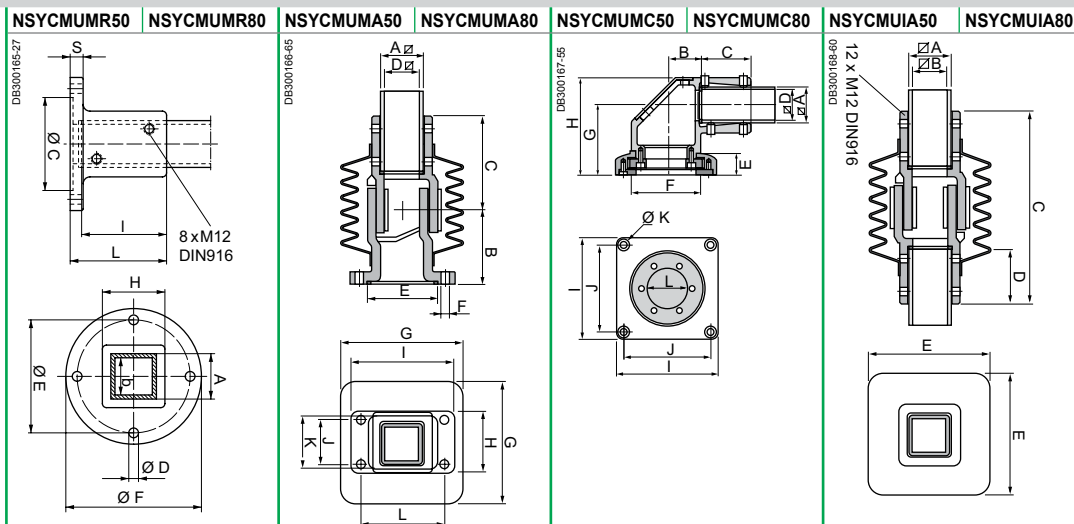

**Adapter part for enclosure D300 / Ø 80 mm**

Reference

**NSYCMUCPAD87**

## Suspension system

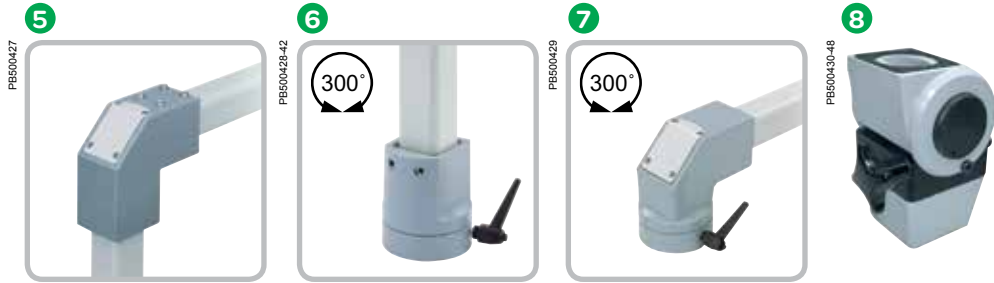

Characteristics	Fixed bracket	Rotating mounting on enclosure	Rotating mounting in bracket on enclosure	Tilting mounting on enclosure
	Our system of tubes and joints, fixed or rotating, enables all the solutions to respond to the installation needs of the control enclosures for human-machine dialogue. Device allowing the combination and mounting of a horizontal tube with a vertical tube.	Device allowing the mounting and rotation through 310° of tubes, with a square section of 50 or 80 mm, in vertical position. System for blocking in the chosen position. Mounting through the support surface by 4 screws.	Devices allowing the mounting and rotation through 310° of tubes, with a square section of 50 or 80 mm, in horizontal position. System for blocking in the chosen position. Mounting through the support surface by 4 screws.	This mounting allows the enclosures to be tilted up to 30°. System for blocking in the chosen position. It is installed on enclosures with depths of 200 and 250 mm. The installation on enclosures with a depth of 300 mm requires an adapter plate.
Material	Aluminium	Aluminium	Aluminium	-
Colour	RAL 7040 grey	RAL 7040 grey	RAL 7040 grey	-
Weight (kg)	1.35    2.4	1.25    3.1	2        6.55	2.98    3.10

Dimensions (mm)										
∅ A	50 mm square		80 mm square		50 mm square		80 mm square		50 mm square	
B	46	56	42	72	46	56	55	55	55	55
C	60	83	115	145	60	83	100	100	100	100
D	60	83	96	139	147	190	44	44	44	44
E	46	56	52.3	85	96	139	121	121	121	121
F	42	70	58	87	42	72	182	182	182	182
G	144	193	-	-	154	208.5	50	50	50	50
H	-	-	-	-	42	70	100	100	100	100
I	-	-	-	-	58	87	50	50	50	50
M	-	-	M6	M8	M6	M8	-	-	-	-

### References

NSYCMUTC50	NSYCMUTC80	NSYCMUCR50	NSYCMUCR80	NSYCMUCC50	NSYCMUCC80	NSYCMUCP50	NSYCMUCP80
------------	------------	------------	------------	------------	------------	------------	------------

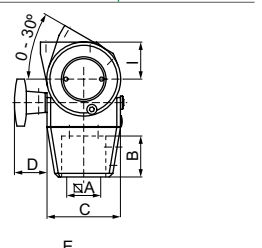
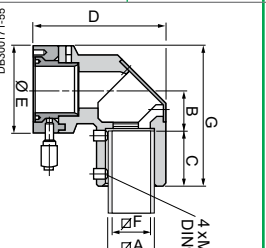
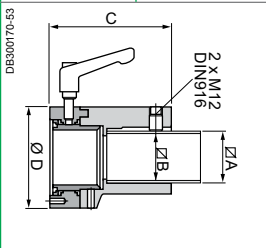
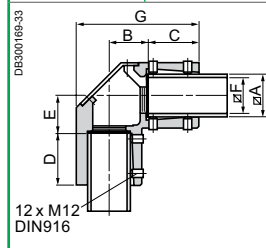

### Adapter for signalling beacon

- It is installed on fixed brackets ref. **NSYCMUTC50** and **NSYCMUTC80**.
- **Material:** aluminium.
- **Finish:** structured finish, powder.
- **Colour:** RAL 7040 grey.





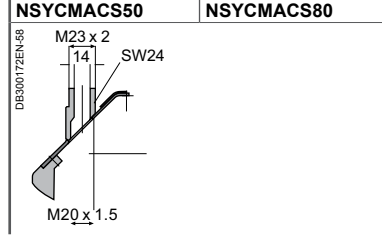





Weight	0.025 kg	0.08 kg
∅ A	50 mm square	80 mm square

### References



# Human-Machine Interface

## Selection guide

Enclosure		References	
	H x W x D (mm) top wall	Tube section ∅ 50 mm	∅ 80 mm
	300 x 300 x 200	NSYS3CM303020	-
	300 x 400 x 200	NSYS3CM304020	-
	400 x 400 x 200	NSYS3CM404020	-
	400 x 600 x 250	NSYS3CM406025*	-
	500 x 500 x 250	NSYS3CM505025	-
	600 x 600 x 200	NSYS3CM606020*	-
	600 x 800 x 300	-	NSYS3CM608030
800 x 600 x 300	-	NSYS3CM806030*	
Tube		References	
	Length (m)	Tube section ∅ 50 mm	∅ 80 mm
	0.5	NSYCMT5005	NSYCMT8005
	1	NSYCMT5010	NSYCMT8010
	1.5	NSYCMT5015	NSYCMT8015
	2	NSYCMT5020	NSYCMT8020
Mounting on support (steel material)		References	
	<b>1</b> Fixed base	Tube section ∅ 50 mm	∅ 80 mm
		NSYCMUMR50	NSYCMUMR80
			<b>2</b> Wall mounting with joint
	<b>3</b> Rotating straight fitting		
		Inter-tube fitting (aluminium material)	
	<b>4</b> Horizontal inter-tube joint	Tube section ∅ 50 mm	∅ 80 mm
		NSYCMUIA50	NSYCMUIA80
	<b>5</b> Fixed bracket	NSYCMUTC50	NSYCMUTC80
Mounting on enclosure (aluminium material)		References	
	<b>6</b> Rotating mounting on enclosure	Tube section ∅ 50 mm	∅ 80 mm
		NSYCMUCR50	NSYCMUCR80
			<b>7</b> Rotating mounting in bracket on enclosure
	<b>8</b> Tilting mounting on enclosure		

\* Enclosure equipped with a cable-gland plate.

(1) Installation on an enclosure D300 requires plate ref. NSYCMUCPAD87 (see page 364).

# Human-Machine Interface Examples

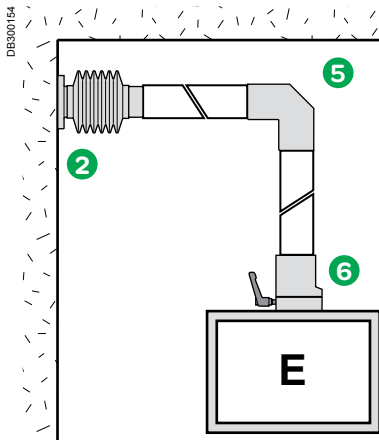

**Mounting on support**

2 See page 364

**Inter-tube fitting**

5 See page 365

**Mounting on enclosure**

6 See page 365

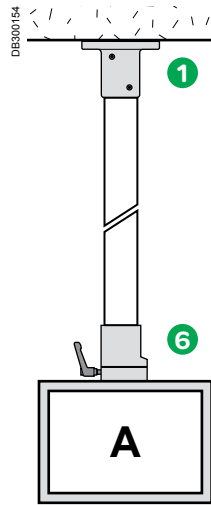

**Mounting on support**

1 See page 364

**Inter-tube fitting**

-

**Mounting on enclosure**

6 See page 365

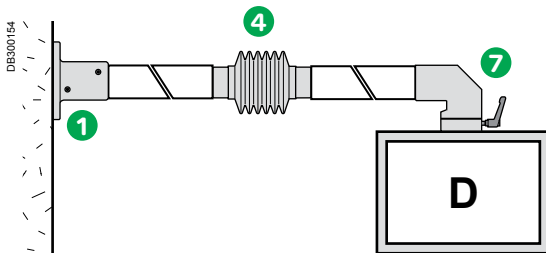

**Mounting on support**

1 See page 364

**Inter-tube fitting**

4 See page 364

**Mounting on enclosure**

7 See page 365

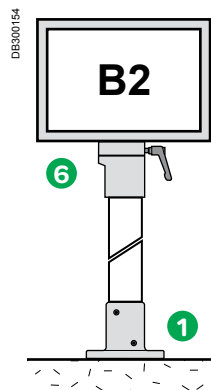

**Mounting on support**

1 See page 364

**Inter-tube fitting**

-

**Mounting on enclosure**

6 See page 365

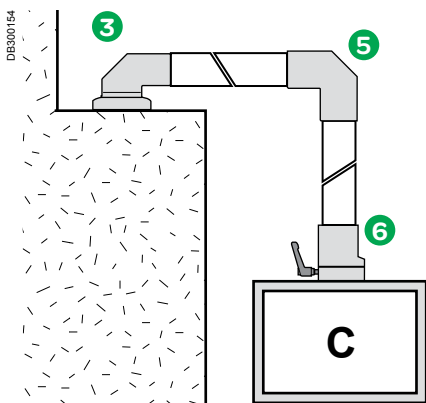

**Mounting on support**

3 See page 364

**Inter-tube fitting**

5 See page 365

**Mounting on enclosure**

6 See page 365

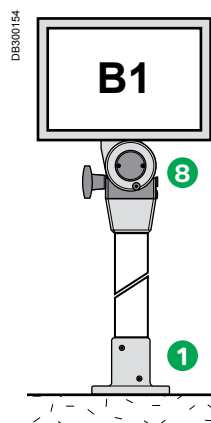

**Mounting on support**

1 See page 364

**Inter-tube fitting**

-

**Mounting on enclosure**

8 See page 365

**SD**

> The range of **Spacial SD** control desks provides all the functions required of a workstation intended for industrial and infrastructure applications.



### Steel control desks



#### Accessibility

There are two versions of the Compact control desk:

- Front accessibility: designed for straightforward solutions.
- Front and rear accessibility through a removable panel: enables the installation of two adjoining plates and to work at the rear.

The control desk with console offers full accessibility, since it is fully accessible from the rear thanks to the 3-point closure door it includes.

For Spacial SD, the accessibility which allows quick and easy work is one of its main priorities.

For this reason, its design excludes the central upright.



#### Easy

The console opens easily and safely thanks to the installed pneumatic opening lid stays.

Cable entry is optimised because all the models of the range include a cable-gland plate with two adjustable parts.



#### Convenience

The possibility of connecting the modular control desk to the modular consoles affords multiple combinations.

The opening direction of the door can be changed quickly thanks to the included hinges.



#### Compatibility

Furthermore, the Spacial SD control desk is compatible with most of the accessories of the Spacial SF and SM ranges.

**This range can be configured according to your needs**

4 different services available:



Assemble to order



Mounting of standard accessories



Painting



Machining

See page 396 for details or consult our web site [www.schneider-electric.com](http://www.schneider-electric.com)



### SDX

➤ The association of a monobloc control desk with one or more consoles enables all combinations. Complete accessibility to the inside of the control desk thanks to its design without intermediate crossbars.



### Stainless-steel control desks

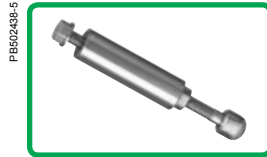

#### Hygiene

The high quality of the standard finish enables very easy maintenance while avoiding contamination. The hygienic feet made from 316L stainless-steel, adjustable between 140 mm and 200 mm height, make it easier to clean under the enclosures.



#### Resistance to corrosion

High resistance to corrosion. 304L and 316L stainless-steels provide the best solutions for applications in extremely demanding environments.



#### Compatibility with the other ranges

- Stainless-steel accessories:
  - plinths, locks.
- Accessories of the steel control desks offer:
  - mounting plate, pneumatic opening stay, etc.



#### Convenient

The desk lid and the console are equipped with pneumatic opening stays (opening to 75°) allowing complete access to the inside and preventing sudden falls of the console or the hinged cover. Equipped with adjustment rails for adjusting the depth of the mounting plate. Removable rear panel.

### ★ Examples of associations

#### Consoles and control desks

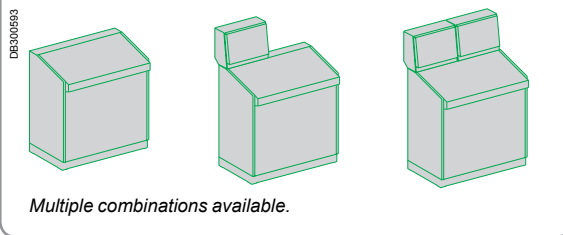

This range can be configured according to your needs

4 different services available:



Assemble to order



Mounting of standard accessories



Painting



Machining

See page 396 for details or consult our web site [www.schneider-electric.com](http://www.schneider-electric.com)

# Human-Machine Interface Characteristics



Characteristics	Compact control desk	Control desk with console
	<b>Sheet steel</b> This range is available in 4 widths with fixed rear panel. Full accessibility is provided from the front (no central upright). Easy removable and reversible door opening to 120°. Locking by 3-mm doublebar lock (other inserts or cylinders also available, to be ordered separately, see page 380). Desk lid equipped with a pneumatic opening stay. Opens to 75°. Perforated reinforcement rails with a pitch of 25 mm. Control desk equipped with adjustment rails with a pitch of 25 mm and brackets allowing adjustment of the mounting plate depth. Cable-gland plate with 2 adjustable parts, with polyurethane gasket. M8 x 18-mm earthing bolt for equipotential connection between the door and the body.	<b>Sheet steel</b> Full accessibility is provided from the front and rear. Easy removable and reversible front door, opening to 120°. Locking by two-point locks with 3-mm double-bar insert. Desk lid equipped with a pneumatic opening stay. Opens to 75°. Perforated reinforcement rails with a pitch of 25 mm for quick installation of cables and cable ducts. Locking by two-point locks with 3-mm double-bar insert. Hinged console cover equipped with a pneumatic opening stay. Opens to 75°. Locking by two-point locks with 3-mm double-bar insert. Easy removable and reversible rear door, opening to 120°. Locking by three-point lock with flat escutcheon, 5-mm double-bar insert. One entry cable-gland plate, with polyurethane gasket. Control desk equipped with adjustment rails with a pitch of 25 mm and brackets allowing adjustment of the mounting plate depth. M8 x 18-mm earthing bolt for equipotential connection between the door and the body.
Material	Welded folded sheet steel	Welded folded sheet steel
Finish	Structured finish, epoxy-polyester powder paint	Structured finish, epoxy-polyester powder paint
Colour	RAL 7035 grey	RAL 7035 grey
Thickness	15/10 <sup>6</sup> mm	15/10 <sup>6</sup> mm
Ingress protection rating	IP55	IP55
Mechanical protection rating	IK10	IK10
Options	It can also be equipped with a mounting plate, see page 382	Plinth options see page 378. It can also be equipped with a mounting plate, see options page 382. Locking system: other inserts or cylinders also available, see page 380. The console can support the installation of a 14" screen with an optional PC support plate, see page 382.

References								
Dimensions (mm)			Door number		No. Front doors	No. Rear doors	No. cable gland plates	
Width (B)	Height	Depth	1	2				
600	1000	469	NSYSD6	-	-	-	-	-
		500	-	-	-	-	-	-
		600	-	-	-	-	-	-
800	1000	469	NSYSD8	-	-	-	-	-
		500	-	-	-	-	-	-
		600	-	-	-	-	-	-
	1400	845	-	-	1	1	1	NSYSDF88
		1045	-	-	1	1	1	NSYSDF810
1000	1000	469	-	NSYSD10	-	-	-	-
		500	-	-	-	-	-	-
		600	-	-	-	-	-	-
	1400	845	-	-	2	2	1	NSYSDF108
		1045	-	-	2	2	1	NSYSDF1010
1200	1000	469	-	NSYSD12	-	-	-	-
		500	-	-	-	-	-	-
		600	-	-	-	-	-	-
	1400	845	-	-	2	2	1	NSYSDF128
		1045	-	-	2	2	1	NSYSDF1210
1600	1400	845	-	-	2	2	2	NSYSDF168
		1045	-	-	2	2	2	NSYSDF1610

# Human-Machine Interface Characteristics

**SD**



**SDX**



**Compact control desk with rear panel**

Sheet steel	Stainless-steel sheet
Removable rear panel. It enables the installation of two racks back-to-back, allowing the installation of a large number of devices, while ensuring full accessibility from the front and the rear.	
At the top, these control desks are equipped with cable-entry cut-outs, that allows the installation of one or more modular consoles.	
Easy removable and reversible door, opening to 120°. Locking by 3-mm doublebar lock (other inserts or cylinders also available, to be ordered separately, see page 380).	
Desk lid equipped with a pneumatic opening stay. Opens to 75°. Perforated reinforcement rails with a pitch of 25 mm.	
Top cable-entry cut-outs covered by a entire blanking cover.	
Control desk equipped with adjustment rails with a pitch of 25 mm and brackets allowing adjustment of the mounting plate depth.	
Cable-gland plate with 2 adjustable parts, with polyurethane gasket.	
M8 x 18-mm earthing screw for equipotential connection between the door and the body.	
Welded folded sheet steel	304L stainless-steel sheet
Structured finish, epoxy-polyester powder paint	Scotch-Brite® brushed finish
RAL 7035 grey	-
15/10° mm	15/10° mm
IP55	IP55
IK10	IK10
Modular consoles to be installed on top of compact control desk. See details and combinations page 376. It can also be equipped with a mounting plate, see page 382.	Stainless-steel modular consoles to be installed on top of compact control desk. See details and combinations page 376. It can also be equipped with a mounting plate.

Door number		Door number	
1	2	1	2
-	-	-	-
-	-	<b>NSYSDX6</b>	-
<b>NSYSD6R</b>	-	-	-
-	-	-	-
-	-	<b>NSYSDX8</b>	-
<b>NSYSD8R</b>	-	-	-
-	-	-	-
-	-	-	-
-	-	-	<b>NSYSDX10</b>
-	<b>NSYSD10R</b>	-	-
-	-	-	-
-	-	-	-
-	-	-	-
-	-	-	<b>NSYSDX12</b>
-	<b>NSYSD12R</b>	-	-
-	-	-	-
-	-	-	-
-	-	-	-
-	-	-	-

**SD**

## Compact control desk

1 door

2 doors

DB30055REN-102

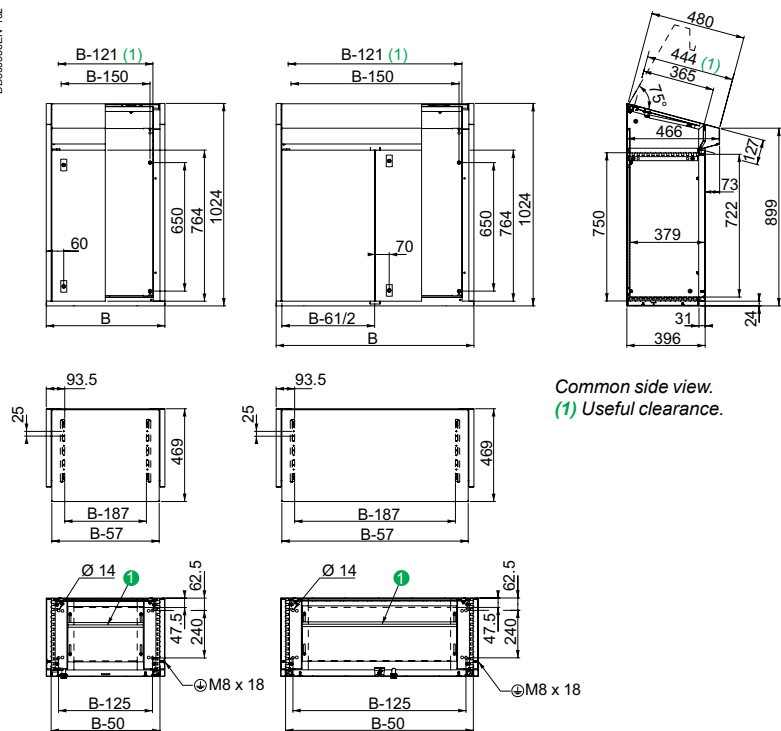

Common side view.  
(1) Useful clearance.

### Cable-gland plate clearance dimensions (mm)

Width	Maximum opening
B-280	56

**SD**

## Compact control desks with rear panel

1 door

2 doors

DB300557EN-108

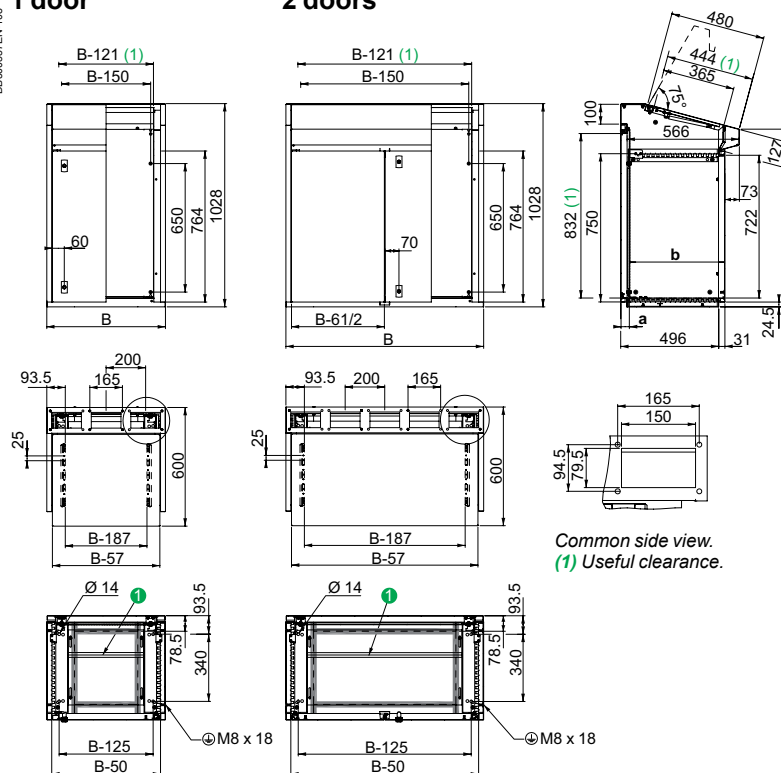

Common side view.  
(1) Useful clearance.

### Cable-gland plate clearance dimensions (mm)

Width	Maximum opening
B-280	56

### Adjustment of the depth of the mounting plate (mm)

Depth	Min.	Max.
a	42	392
b	129	479

**SDX**

### Compact control desks with rear panel

1 door

2 doors

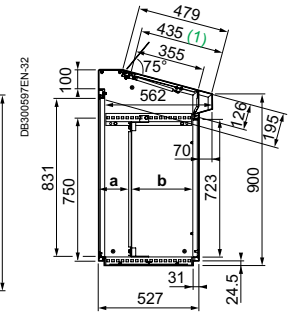
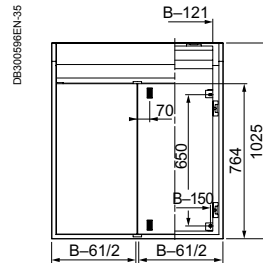
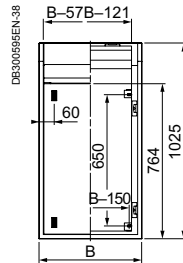

Common side view.  
(1) Useful clearance.

**Cable-gland plate clearance dimensions (mm)**

Width	Maximum opening
B-280	370

**Adjustment of the depth of the mounting plate (mm)**

Depth	Min.	Max.
a	45	395
b	126	476

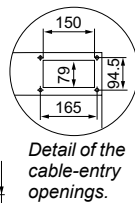
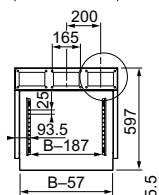

Detail of the cable-entry openings.

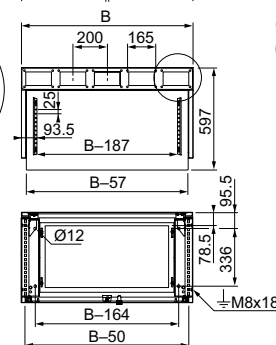
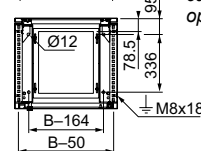

**SD**

### Control desk with console

1 door

2 doors

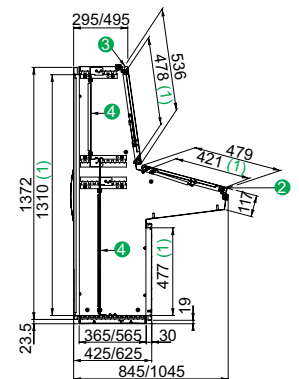
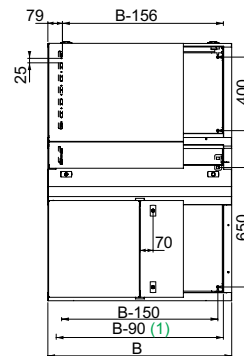
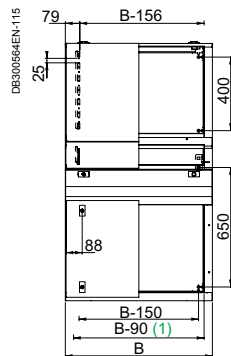

Common side view.  
(1) Useful clearance.

**Cable-gland plate clearance dimensions (mm)**

Width	Maximum opening
B-280	56

**Notes**

- 1 1 entry cable-gland plate
- 2 Maximum opening of the hinged desk lid: 75°
- 3 Maximum opening of the hinged console cover: 75°
- 4 Optional mounting plate installation, see page 382

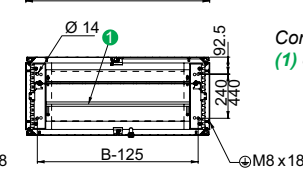
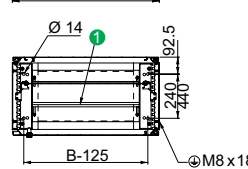

**SD**

**SDX**

### Modular console

Depth 200 mm

Depth 300 mm

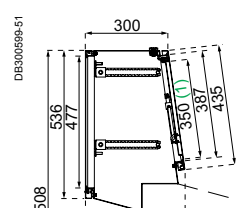
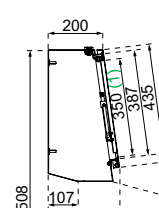
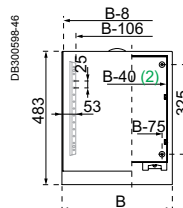

(1) Useful clearance.  
(2) Same dimensions for the rear panel.

PB501614-77



### Composition accessories

#### Modular consoles



Page 376

#### Floor



Page 378

#### Door



Page 379

#### Locking system



Page 380

#### Windows



Page 298

### Installation accessories

#### Mounting acc.



Page 382

### Cable management

PB502439-65



#### Cable holding

PB500986-40



Page 270

#### Cable ducting

PB500959-22

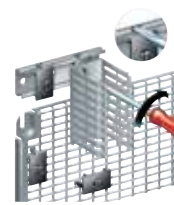

Page 289

### Thermal management

#### Heaters

PB502050-29



Page 452

#### Ventilation

PB501044-26



Page 406

### Others

#### Earthing

PB500948-88  
PB500217-18  
PB500084-24



Page 302

## Modular consoles





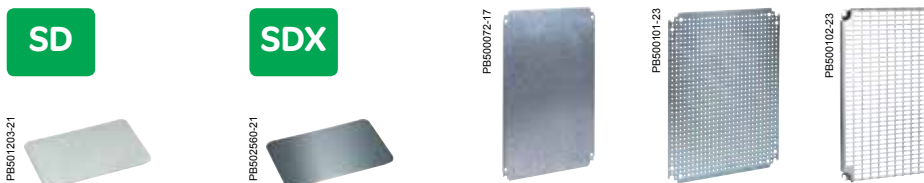















Characteristics		Modular consoles				
		Sheet steel		Stainless-steel sheet		
		Hinged modular console cover equipped with a pneumatic opening stay. Opens to 75°. Locking of the hinged modular console cover by two 3-mm double-bar locks (other inserts or barrels also available, to be ordered separately, see page 380). Screw fixed rear panel equipped with step slides in the version with a depth of 300 mm.				
Material		Welded folded sheet steel		304L stainless-steel sheet		
Finish		Structured finish, epoxy-polyester powder paint		Scotch-Brite® brushed finish		
Colour		RAL 7035 grey		-		
Thickness		15/10 <sup>e</sup> mm		15/10 <sup>e</sup> mm		
Ingress protection rating		IP55		IP55		
Mechanical protection rating		IK10		IK10		
Options		The link between the control desk and the modular console requires, in certain cases, the addition of one or several blanking covers (to be ordered separately). Optional galvanised mounting plate.				
References						
Dimensions (mm)			No. of cable entry cut-outs			
Width (B)	Height	Depth	2	3	2	3
400	483	200	NSYSDC42	-	NSYSDCX42	-
		300	NSYSDC43	-	NSYSDCX43	-
600	483	200	-	NSYSDC62	-	NSYSDCX62
		300	-	NSYSDC63	-	NSYSDCX63



Characteristics		Blanking cover		Mounting plates for modular consoles			
		To conceal the free space of the control desk when the width of the console or consoles is less than the width of the control desk. In any case, it is necessary to previously remove the top plate delivered with the control desk.		Steel mounting plates can be installed at the back of modular consoles (F). See more information about the mounting plates pages 214.			
Material		Sheet steel	304L stainless-steel	Steel			
Finish		Structured finish, epoxy-polyester powder paint,	-	-			
Colour		RAL 7035 grey	-	-			
Thickness		15/10 <sup>e</sup> mm	15/10 <sup>e</sup> mm	-			
Mounting		Mounting by screws	Mounting by screws	-			
References							
Blanking cover length (mm)							
200			NSYRP2	NSYRPX2	-	-	
Modular console width (mm)	Mounting centre-to-centre distance (mm)				Plain mounting plate	Microperforated mounting plate	Telequick mounting plate
	Height	Width					
400	325	325	-	-	NSYMM44	NSYMF44	NSYMR44
600	625	325	-	-	NSYMM64	NSYMF64	NSYMR64
			<p>Example installation of a mounting plate in a console depth 200 mm.</p> <p>Example installation of a mounting plate in a console depth 300 mm.</p>				



## Modular consoles

Combination examples of modular consoles installation	Compact control desk		Modular console		Blanking cover		
	Spacial SD	Spacial SDX	Spacial SD	Spacial SDX	Spacial SD	Spacial SDX	
<b>600</b>							
		NSYSD6R	NSYSDX6	NSYSDC42 / NSYSDC43	NSYSDCX42 / NSYSDCX43	NSYRP2	NSYRPX2
		NSYSD6R	NSYSDX6	NSYSDC62 / NSYSDC63	NSYSDCX62 / NSYSDCX63	-	-
<b>800</b>							
		NSYSD8R	NSYSDX8	NSYSDC42 / NSYSDC43	NSYSDCX42 / NSYSDCX43	2 x NSYRP2	2 x NSYRPX2
		NSYSD8R	NSYSDX8	2 x NSYSDC42 / 2 x NSYSDC43	2 x NSYSDCX42 / 2 x NSYSDCX43	-	-
		NSYSD8R	NSYSDX8	NSYSDC62 / NSYSDC63	NSYSDCX62 / NSYSDCX63	NSYRP2	NSYRPX2
<b>1000</b>							
		NSYSD10R	NSYSDX10	NSYSDC42 / NSYSDC43	NSYSDCX42 / NSYSDCX43	3 x NSYRP2	3 x NSYRPX2
		NSYSD10R	NSYSDX10	NSYSDC62 / NSYSDC63	NSYSDCX62 / NSYSDCX63	2 x NSYRP2	2 x NSYRPX2
		NSYSD10R	NSYSDX10	NSYSDC62 / NSYSDC63	NSYSDCX62 / NSYSDCX63	2 x NSYRP2	2 x NSYRPX2
		NSYSD10R	NSYSDX10	NSYSDC42 + NSYSDC62 / NSYSDC43 + NSYSDC63	NSYSDCX42 + NSYSDCX62 / NSYSDCX43 + NSYSDCX63	-	-
<b>1200</b>							
		NSYSD12R	NSYSDX12	NSYSDC42 / NSYSDC43	NSYSDCX42 / NSYSDCX43	4 x NSYRP2	4 x NSYRPX2
		NSYSD12R	NSYSDX12	NSYSDC62 / NSYSDC63	NSYSDCX62 / NSYSDCX63	3 x NSYRP2	3 x NSYRPX2
		NSYSD12R	NSYSDX12	NSYSDC62 / NSYSDC63	NSYSDCX62 / NSYSDCX63	3 x NSYRP2	3 x NSYRPX2
		NSYSD12R	NSYSDX12	2 x NSYSDC62 / 2 x NSYSDC63	2 x NSYSDCX62 / 2 x NSYSDCX63	-	-
		NSYSD12R	NSYSDX12	NSYSDC42 + NSYSDC62 / NSYSDC43 + NSYSDC63	NSYSDCX42 + NSYSDCX62 / NSYSDCX43 + NSYSDCX63	NSYRP2	NSYRPX2

**SD SDX**

## Floor

For more information, see page 100.



Characteristics		Front and rear plinth				Plinth side panels			
		The front and rear of the plinth consists of 4 corners with 2 or 4 panels.				They are fixed to the corner of the plinth by 2 mounting screws.			
Material		Folded sheet steel, corner with a thickness of 25/10 <sup>o</sup> mm		316L stainless-steel*		Folded sheet steel		316L stainless-steel*	
Finish		Painted with epoxy-polyester resin		-		Painted with epoxy-polyester resin		-	
Colour		RAL 7022 grey		-		RAL 7022 grey		-	
Ingress protection rating		IP30		IP30		IP30		IP30	
Mechanical protection rating		IK10		IK10		IK10		IK10	
Supply		<ul style="list-style-type: none"> <li>■ Height 100 mm: 4 corners, 2 panels (front and rear), 4 corner covers and mounting elements</li> <li>■ Height 200 mm: 4 corners, 4 panels (2 front and 2 rear), 4 corner covers and mounting elements</li> </ul>				<ul style="list-style-type: none"> <li>■ Height 100 mm: 2 side panels, 4 corner covers and mounting elements</li> <li>■ Height 200 mm: 4 side panels (height of 100 mm, 2 for each side), 4 corner covers and mounting elements</li> </ul>			
<b>Control desk references</b>		<b>Plinths references</b>							
<b>Compact control desks with fixed rear panel</b>		<b>100 mm</b>	<b>200 mm</b>	<b>100 mm</b>	<b>200 mm</b>	<b>100 mm</b>	<b>200 mm</b>	<b>100 mm</b>	<b>200 mm</b>
	NSYS D6	NSYS PF6100	NSYS PF6200	NSYS PF6100H	NSYS PF6200H	NSYS PS4100SD	NSYS PS4200SD	NSYS PSX5100H	2 x NSYS PSX5100H
	NSYS D8	NSYS PF8100	NSYS PF8200	NSYS PF8100H	NSYS PF8200H	NSYS PS4100SD	NSYS PS4200SD	NSYS PSX5100H	2 x NSYS PSX5100H
	NSYS D10	NSYS PF10100	NSYS PF10200	NSYS PF10100H	NSYS PF10200H	NSYS PS4100SD	NSYS PS4200SD	NSYS PSX5100H	2 x NSYS PSX5100H
	NSYS D12	NSYS PF12100	NSYS PF12200	NSYS PF12100H	NSYS PF12200H	NSYS PS4100SD	NSYS PS4200SD	NSYS PSX5100H	2 x NSYS PSX5100H
<b>Compact control desks with removable rear panel Sheet steel</b>									
	NSYS D6R	NSYS PF6100	NSYS PF6200	NSYS PF6100H	NSYS PF6200H	NSYS PS5100SD	NSYS PS5200SD	NSYS PSX5100H	2 x NSYS PSX5100H
	NSYS D8R	NSYS PF8100	NSYS PF8200	NSYS PF8100H	NSYS PF8200H	NSYS PS5100SD	NSYS PS5200SD	NSYS PSX5100H	2 x NSYS PSX5100H
	NSYS D10R	NSYS PF10100	NSYS PF10200	NSYS PF10100H	NSYS PF10200H	NSYS PS5100SD	NSYS PS5200SD	NSYS PSX5100H	2 x NSYS PSX5100H
	NSYS D12R	NSYS PF12100	NSYS PF12200	NSYS PF12100H	NSYS PF12200H	NSYS PS5100SD	NSYS PS5200SD	NSYS PSX5100H	2 x NSYS PSX5100H
<b>Compact control desks with removable rear panel Stainless-steel</b>									
	NSYS DX6	-	-	NSYS PF6100H	NSYS PF6200H	-	-	NSYS PSX5100H	2 x NSYS PSX5100H
	NSYS DX8	-	-	NSYS PF8100H	NSYS PF8200H	-	-	NSYS PSX5100H	2 x NSYS PSX5100H
	NSYS DX10	-	-	NSYS PF10100H	NSYS PF10200H	-	-	NSYS PSX5100H	2 x NSYS PSX5100H
	NSYS DX12	-	-	NSYS PF12100H	NSYS PF12200H	-	-	NSYS PSX5100H	2 x NSYS PSX5100H
<b>Control desk with console</b>									
	NSYS DF88	NSYS PF8100	NSYS PF8200	-	-	NSYS PS4100SD	NSYS PS4200SD	-	-
	NSYS DF108	NSYS PF10100	NSYS PF10200	-	-	NSYS PS4100SD	NSYS PS4200SD	-	-
	NSYS DF128	NSYS PF12100	NSYS PF12200	-	-	NSYS PS4100SD	NSYS PS4200SD	-	-
	NSYS DF168	NSYS PF16100	NSYS PF16200	-	-	NSYS PS4100SD	NSYS PS4200SD	-	-
	NSYS DF810	NSYS PF8100	NSYS PF8200	-	-	NSYS PS6100SD	NSYS PS6200SD	-	-
	NSYS DF1010	NSYS PF10100	NSYS PF10200	-	-	NSYS PS6100SD	NSYS PS6200SD	-	-
	NSYS DF1210	NSYS PF12100	NSYS PF12200	-	-	NSYS PS6100SD	NSYS PS6200SD	-	-
	NSYS DF1610	NSYS PF16100	NSYS PF16200	-	-	NSYS PS6100SD	NSYS PS6200SD	-	-

\* 304L stainless-steel available (remove H suffix from references).

## Door



PB501213-42

### Pneumatic opening stay

- Holds the desk lid in open position at an angle of 75°.
- **Supply:** delivered with mountings.

Nominal load per stay (N)	Max. load on lid (kg)	Control desk references				Standard supply stay
		With fixed rear panel	With removable rear panel		With console	
			Sheet steel	Stainless-steel		
244	13	NSYSD6	NSYSD6R	NSYSDX6	NSYSDF88	NSYPLS24
		NSYSD8	NSYSD8R	NSYSDX8	NSYSDF810	NSYPLS24
300	11	-	-	-	NSYSDF168	NSYPLS30
		-	-	-	NSYSDF1610	NSYPLS30
	15	NSYSD12	NSYSD12R	NSYSDX12	NSYSDF128	NSYPLS30
		-	-	-	NSYSDF1210	NSYPLS30
	17	NSYSD10	NSYSD10R	NSYSDX10	NSYSDF108	NSYPLS30
		-	-	-	NSYSDF1010	NSYPLS30

PB501214



### Document lip

- Retaining bar to be fixed on the front of the inclined control desk lid. Prevents documents and equipment from falling.
- **Material:** PVC, RAL 7011 grey.
- **Mounting:** mounting by adhesive.

Control desk width (mm)	References
600	NSYDL6
800	NSYDL8
1000	NSYDL10
1200	NSYDL12
1600	NSYDL16

## Locking system



The Control desks are supplied with 3 mm double-bar escutcheon locks as standard.

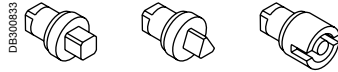

Characteristics	Shape inserts	Escutcheon with key lock
	Possibility to replace the standard shape insert: <ul style="list-style-type: none"> <li>■ 8-mm triangular insert,</li> <li>■ 8-mm male square insert,</li> <li>■ 7-mm male square insert.</li> </ul>	Insert breakage torque: 15 daN.
Material	-	Polyamide PA 6 material charged with 30 % fibreglass
Colour	-	RAL 7011 grey
Mechanical protection rating	-	IK10
Fire resistance	-	650°C
<b>References</b>		
8-mm triangular insert	<b>NSYTT8CRN</b>	-
8-mm male square insert	<b>NSYTC8CRN</b>	-
7-mm male square insert	<b>NSYTC7CRN</b>	-
405E key	-	<b>NSYML405SD</b>
Without insert	-	-

## Locking system



PB501217-38

### Pivoting handle

To be installed on the rear door of Control desk with console, replacing the flat escutcheon supplied as standard.  
Ergonomic locking system with pivoting handle (delivered without insert).  
Broad range of inserts for covering the greatest variety of needs (shape inserts, DIN cylinders, KABA, ASSA).  
Changing the opening direction to right / left thanks to the symmetric design of the lock unit (no linkages to be removed).  
Lock unit supported by 2 screws.  
PA 6 charged with 30 % fibreglass  
RAL 7011 grey  
IK10  
650°C

### NSYSDH

### Accessories

Shape inserts	References
6-mm square insert	<b>NSYINS61</b>
6-mm female square insert	<b>NSYINS6G1</b>
7-mm square insert	<b>NSYINS71</b>
8-mm square insert	<b>NSYINS81</b>
8-mm female square insert	<b>NSYINS8G1</b>
8-mm square insert with slot	<b>NSYINS8H1</b>
6.5-mm triangular insert	<b>NSYINT61</b>
7-mm triangular insert	<b>NSYINT71</b>
8-mm triangular insert	<b>NSYINT81</b>
9-mm triangular insert	<b>NSYINT91</b>
10-mm triangular insert	<b>NSYINT101</b>
10-mm keyless hexagonal insert	<b>NSYINH31</b>
3-mm double-bar insert	<b>NSYINDB31</b>
5-mm double-bar insert	<b>NSYINDB51</b>
Daimler Benz insert	<b>NSYINBENZ1</b>
Fiat insert	<b>NSYINFIAT1</b>
USA keyless slot insert	<b>NSYINUSA1</b>
2 x 4 keyless slot insert	<b>NSYIN241</b>
Crown insert	<b>NSYINCW1</b>
<b>Push button</b>	<b>Reference</b>
Push button	<b>NSYINPULSD</b>

PB500614-19

Shape inserts

PB501218

Push button

PB500616-18

Cylindrical barrels

Cylindrical barrels	References
Lock with 405E key	<b>NSYIN405E1</b>
Lock with 421E key	<b>NSYIN421E1</b>
Lock with 455 key	<b>NSYIN4551</b>
Lock with 1242E key	<b>NSYIN1242E1</b>
Lock with 1332E key	<b>NSYIN1332E1</b>
Lock with 2124E key	<b>NSYIN2124E1</b>
Lock with 2131A key	<b>NSYIN2131A1</b>
Lock with 2132A key	<b>NSYIN2132A1</b>
Lock with 2331A key	<b>NSYIN2331A1</b>
Lock with 2433A key	<b>NSYIN2433A1</b>
Lock with 2452E key	<b>NSYIN2452E1</b>
Lock with 3113A key	<b>NSYIN3113A1</b>
Lock with 3122E key	<b>NSYIN3122E1</b>
Lock with 3123A key	<b>NSYIN3123A1</b>
Lock with 3131A1 key	<b>NSYIN3131A1</b> <span style="color: red; font-weight: bold;">New</span>
Lock with 3133A key	<b>NSYIN3133A1</b>
Lock with 3422E key	<b>NSYIN3422E1</b>
Lock with 3432E key	<b>NSYIN3432E1</b>
Lock with 6101 key	<b>NSYIN6101</b> <span style="color: red; font-weight: bold;">New</span>
Lock with EDF 1300 key	<b>NSYINF1301</b>
Lock with EDF 1400 key	<b>NSYINF1401</b>
Michelin 8079 keyless lock	<b>NSYINICHEL8791</b>
Michelin 8133 keyless lock	<b>NSYINICHEL8131</b>
Michelin 8376 keyless lock	<b>NSYINICHEL8371</b>
E1 keyless lock	<b>NSYINE11</b>

PB501219-37

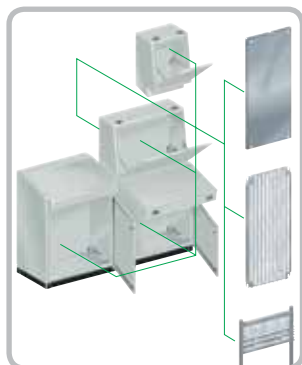

## Mounting accessories

	Compact control desks				Control desk with console							
Installation type												
Control desk	Mounting plates (1)											
Width (B) (mm)	Plain		Telequick		Plain		Telequick		Plain		Telequick	
	Surface (dm <sup>2</sup> )	References	Surface (dm <sup>2</sup> )	References	Surface (dm <sup>2</sup> )	References	Surface (dm <sup>2</sup> )	References	Surface (dm <sup>2</sup> )	References	Surface (dm <sup>2</sup> )	References
600	35	NSYPMP8560	34	NSYTMP6760	-	-	-	-	-	-	-	-
800	49	NSYPMP8580	48	NSYTMP6780	31	NSYPMP4580	30	NSYTMP4280	49	NSYPMP8580	48	NSYTMP6780
1000	63	NSYPMP85100	61	NSYTMP67100	40	NSYPMP45100	39	NSYTMP42100	63	NSYPMP85100	61	NSYTMP67100
1200	77	NSYPMP85120	75	NSYTMP67120	77	NSYPMP45120	39	NSYTMP42120	77	NSYPMP85120	75	NSYTMP67120
1600	-	-	-	-	67	NSYPMP45160	-	-	105	NSYPMP85160	-	-

	Control desk with console							
Installation type								
Control desk	Mounting plates							
Width (B) (mm)	Plain (1)		Telequick (2)		Plain		Telequick	
	Surface (dm <sup>2</sup> )	References	Surface (dm <sup>2</sup> )	References	Surface (dm <sup>2</sup> )	References	Surface (dm <sup>2</sup> )	References
600	-	-	-	-	-	-	-	-
800	90	NSYMP148	84	2 x NSYSTMP6080	28	NSYSPMP4080	-	-
1000	116	NSYMP1410	108	2 x NSYSTMP60100	36	NSYSPMP40100	-	-
1200	142	NSYMP1412	132	2 x NSYSTMP60120	44	NSYSPMP40120	-	-
1600	-	-	-	-	60	NSYSPMP40160	-	-

(1) For this installation, order a set of 4 adjustment rails and mounting brackets (see page 383).

(2) For this installation, order a set of 2 uprights ref. NSYTVR14 and set of 4 adjustment rails and 4 mounting brackets.

## Mounting accessories



Characteristics	Mounting brackets	Adjustment rails and mounting brackets	Technical uprights	PC screen support
	Set of 4 mounting brackets. Depth adjustment on 25 mm pitch. Included as standard with desk (all versions). To be ordered separately when required for installation of two back to back mounting plates in control desks with rear access.	Set of 4 rails and 4 mounting brackets. To install a plain mounting plate or a Telequick mounting plate, either at the top or across the height of the monobloc control desk with console. For positioning 2 plates (back to back), order mounting brackets ref. <b>NSYMPBSD</b> .	Set of 2 equipment uprights. Support for mounting Telequick mounting plates and rails.	For a control desk with monobloc console with a depth of 600 mm. This support is a galvanised mounting plate, in horizontal position, fixed to the adjustment rails of the console.
Material	Galvanised steel	-	Zinc-coated	-
Thickness	40/10° mm	-	20/10° mm	-
Maximum load	250 kg	-	-	50 kg/m <sup>2</sup>
Supply	-	-	-	Delivered with mountings
<b>References</b>				
<b>For desk width (mm)</b>				
600	<b>NSYMPBSD</b>	-	-	-
800	<b>NSYMPBSD</b>	-	-	<b>NSYPCS8</b>
1000	<b>NSYMPBSD</b>	-	-	<b>NSYPCS10</b>
1200	<b>NSYMPBSD</b>	-	-	<b>NSYPCS12</b>
1600	<b>NSYMPBSD</b>	-	-	<b>NSYPCS16</b>
<b>For control desks with console</b>				
<b>Depth (mm)</b>				
400	-	<b>NSYMPB4SD</b>	-	-
600	-	<b>NSYMPB6SD</b>	-	-
<b>For control desk height</b>				
<b>Centre-to-centre distance (mm)</b>				
1000	650	-	<b>NSYTVR8</b>	-
1400	1250	-	<b>NSYTVR14</b>	-

➤ The **Spacial SF PC rack** is designed to protect and control computer equipment in an industrial environments.

PB500901-54



### Steel PC racks

PB500684-28



#### Convenience

- Anti-glare glazed door designed for viewing until 25,5" screens.
- Cable entry made easier by a cable-land plate in 2 pieces.

PB500685-28



#### Ergonomics

- Access to the various functions and working heights, guaranteeing optimum comfort.
- Partial doors delimit the access to each function with a 3 mm double-bar lock.
- Built-in screen and CPU support.
- Built-in keyboard and mouse support.

PB500490-35



#### Robust

- Spacial SF structure formed from a single 1.5 mm galvanised-steel section, with a high moment of inertia.
- Vertical uprights joined with top and bottom frames, screwed together with connections of sintered steel.
- Panels built into the structure.

PB500495-21

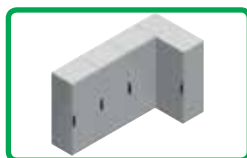

#### Simple

The Spacial SF design allows enclosures to be coupled in any direction, adapting to all installation surfaces.

PB500667-35



#### Locking system

Locking system with flat escutcheon, made from polyamide 6 with 30 % fibreglass, RAL 9005 black, with 5 mm double-bar insert for the plain rear door, and small flat escutcheon with 3 mm double-bar insert for the partial front doors.

Detail of 5 mm DB lock on rear door.

This range can be configured according to your needs

4 different services available:



Assemble to order



Mounting of standard accessories



Painting



Machining

See page 396 for details or consult our web site [www.schneider-electric.com](http://www.schneider-electric.com)



# Human-Machine Interface Characteristics



Characteristics			Spacial SF PC rack	
			<ul style="list-style-type: none"> <li>■ Partial door for PC screen, with Securit® anti-glare glass.</li> <li>■ Plain partial door for CPU (enclosures with height of 1800 mm).</li> <li>■ Hinged plain door for keyboard.</li> <li>■ Plain partial door for optional installation of A4 printer support.</li> <li>■ Partial front doors opening to the right.</li> <li>■ Plain rear door, reversible opening direction (right or left).</li> <li>■ Roof and side panels fixed from the inside.</li> <li>■ Cable-gland plate with 1 entry.</li> </ul>	
Finish			Structured finish, epoxy-polyester powder paint	
Colour			RAL 7035 grey	
Ingress protection rating			IP55, or IP40 with hinged keyboard	
Mechanical protection rating			IK10	
Certifications			UL*, CUL	
Height (mm)	Width (mm)	Depth (mm)	No. of compartments	References
1600	600	600	3	NSYSF16660PC
		800	3	NSYSF16680PC
1800	600	600	4	NSYSF18660PC
		800	4	NSYSF18680PC

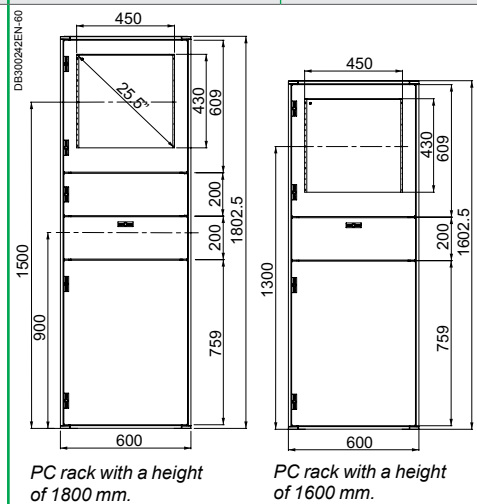

\*1, 12, 12 K.

## Plinth



Characteristics	Front plinth	Plinth side panels			
	The front and rear of the plinth consists of 4 corners with 2 or 4 panels.	They are fixed to the corner of the plinth by 2 mounting screws.			
Material	Folded sheet steel, corner with a thickness of 25/10° mm	Folded sheet steel			
Finish	Painted with epoxy-polyester resin	Painted with epoxy-polyester resin			
Colour	RAL 7022 grey	RAL 7022 grey			
Ingress protection rating	IP30	IP30			
Mechanical protection rating	IK10	IK10			
Installation	-	-			
Supply	<ul style="list-style-type: none"> <li>■ Height 100 mm: 4 corners, 2 panels (front and rear), 4 corner covers and mounting elements</li> <li>■ Height 200 mm: 4 corners, 4 panels (2 front and 2 rear), 4 corner covers and mounting elements</li> </ul>	<ul style="list-style-type: none"> <li>■ Height 100 mm: 2 side panels, 4 corner covers and mounting elements</li> <li>■ Height 200 mm: 4 side panels (height of 100 mm, 2 for each side), 4 corner covers and mounting elements</li> </ul>			
<b>References</b>					
<b>Width (mm)</b>	<b>100 mm</b>	<b>200 mm</b>	<b>100 mm</b>	<b>200 mm</b>	
<b>Depth (mm)</b>					
600	600	NSYSPF6100	NSYSPF6200	NSYSPS6100	NSYSPS6200
	800			NSYSPS8100	NSYSPS8200

## Locking system

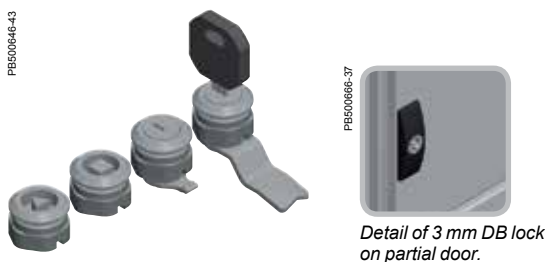

Characteristics	Locks for partial doors			
	Locks to replace the 3 mm double-bar lock supplied with the partial doors. Models: <ul style="list-style-type: none"> <li>■ Transformation of lock with shape inserts, triangular 6.5 mm and square 6 mm.</li> <li>■ Lock with 2233X key for partial doors.</li> <li>■ Lock with 2233X key, exclusive for hinged keyboard door.</li> </ul>			
Supply	<ul style="list-style-type: none"> <li>■ Lock with shape inserts, triangular 6.5 mm and square 6 mm: metal body, shape insert and safety washer.</li> <li>■ Lock with 2233X key for partial doors: metal body, insert, bolt, safety washer and key.</li> <li>■ Lock with 2233X key, exclusive for hinged keyboard door: metal body, insert, special bolt, safety washer and key.</li> </ul>			
<b>References</b>	<b>With 6.5 mm triangular insert for partial and hinged door</b>	<b>With 6 mm square insert for partial and hinged door</b>	<b>With 2233X key for partial door</b>	<b>With 2233X key for hinged keyboard door</b>
	NSYMLT6	NSYMLS6	NSYML23	NSYMLCD23

## Trays

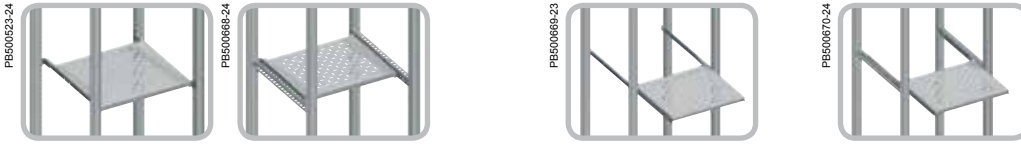

Fixed Trays				Telescopic Trays					
<ul style="list-style-type: none"> <li>Optional installation of a supplement fixed or telescopic tray directly on structure or on cross rails.</li> <li>Acceptable load: 150 kg for fixed trays and 50 kg for telescopic rails, both evenly distributed.</li> <li>See more details and other options on Mounting: trays, page 237.</li> </ul>									
-	-	-	-	-	-	-	-		
-	-	-	-	-	-	-	-		
-	-	-	-	-	-	-	-		
-	-	-	-	-	-	-	-		
On structure	On cross rails			On structure	On cross rails				
-	-			-	-				
Tray	Tray	Universal cross rail 40 mm (1 row)	Quick cross rail 40 mm (1 row)	Tray	Telescopic rails	Tray	Telescopic rails	Universal cross rail 40 mm (1 row)	Quick cross rail 40 mm (1 row)
NSYFXT6060	NSYFXT6060	NSYSUCR4060	NSYSQCR4060	NSYFXT6060	NSYTTG60	NSYFXT6060	NSYTTG60	NSYSUCR4060	NSYSQCR4060
-	NSYFXT6060	NSYSUCR4080	NSYSQCR4080	-	-	NSYFXT6060	NSYTTG60	NSYSUCR4080	NSYSQCR4080

## Other accessories



Characteristics	Handle for telescopic trays
	Handle designed for easy extraction of the sliding trays.
Material	Polyamide 6 (black)
Supply	2 units and mounting elements
Reference	NSY1TH

> The **stainless-steel monobloc PC racks** have been especially designed to protect computer equipment installed in corrosive or specially environments that require washing or exposure to sprays of liquid.



### Stainless-steel monobloc PC racks

PB501223-69



#### Convenience

- Anti-glare glazed door designed for viewing 14" and 17" screens by removing part of the silkscreen printing.
- Cable entry made easier by a cable-gland plate (at the rear) in 2 pieces.

PB501223-108



#### Sealing

- IP55, even with the keyboard drawer open, thanks to the pivoting Plexiglas shutter.

PB501223



#### Optional accessories

- Shelf mounted on telescopic rails.

PB501266-32



#### Ergonomic

- Partial doors delimit the access to each function with a 3-mm double-bar lock.
- Access to the various functions and working heights, guaranteeing optimum comfort.
- Built-in screen and CPU support.
- Built-in mouse support.

PB501223-107



#### Hygiene

- The high quality of the standard finish enables very easy maintenance while avoiding contamination.
  - The hygienic feet made from 316L stainless-steel, adjustable between 140 mm and 200 mm height, make it easier to clean under the enclosures, ref. **NSYPHX200**.
- More information on page 167 and 296.

PB501233-32



#### Resistance to corrosion

- High resistance to corrosion. 304L and 316L stainless-steels provide the best solutions for applications in extremely demanding environments.

This range can be configured according to your needs

4 different services available:



Assemble to order



Mounting of standard accessories



Painting



Machining

See page 396 for details or consult our web site [www.schneider-electric.com](http://www.schneider-electric.com)

# Human-Machine Interface

## Characteristics, accessories



Characteristics			304L stainless-steel PC racks	Front plinth	Plinth side panels							
			<p><b>Composition</b></p> <ul style="list-style-type: none"> <li>■ Top and bottom partial doors on the front side.</li> <li>■ Pivoting panel for the keyboard.</li> <li>■ Plain rear door.</li> </ul> <p><b>Monitor-screen compartment</b></p> <ul style="list-style-type: none"> <li>■ The anti-glare glazed door is designed for viewing screens:                             <ul style="list-style-type: none"> <li>□ 14" as standard,</li> <li>□ 17" by removing a part of the silkscreen printing.</li> </ul> </li> <li>■ The height of the monitor support can be adjusted.</li> <li>■ The monitor shelf can withstand a maximum weight of 50 kg.</li> </ul> <p><b>CPU / keyboard compartment</b></p> <ul style="list-style-type: none"> <li>■ The keyboard fixed to the inside becomes operational by tilting the central panel.</li> <li>■ The CPU is placed on a height-adjustable shelf, visible and accessible through a pivoting, transparent shutter.</li> </ul> <p><b>Optional accessories</b></p> <ul style="list-style-type: none"> <li>■ Hygienic feet H 200 mm: <b>NSYPHX200</b>.</li> <li>■ Shelf installed on a sliding rail, with adjustable height.</li> <li>■ Telescopic tray: <b>NSYTTG60</b>.</li> </ul>	<p>The front and rear of the plinth consists of 4 corners with 2 or 4 panels.</p>	<p>They are fixed to the corner of the plinth by 2 mounting screws.</p>							
Material			Monobloc structure in 304L stainless-steel sheet, micro-beaded finish. Can be made in 316L stainless-steel on request	316L stainless-steel	316L stainless-steel							
Ingress protection rating			IP55, even with the keyboard drawer open	IP30	IP30							
Mechanical protection rating			IK10	IK10	IK10							
Supply			-	<ul style="list-style-type: none"> <li>■ Height 100 mm: 4 corners, 2 panels (front and rear), 4 corner covers and mounting elements</li> <li>■ Height 200 mm: 4 corners, 4 panels (2 front and 2 rear), 4 corner covers &amp; mount elements</li> </ul>	<ul style="list-style-type: none"> <li>■ Height 100 mm: 2 side panels, 4 corner covers &amp; mount elements</li> <li>■ Height 200 mm: 4 side panels (height of 100 mm, 2 for each side), 4 corner covers and mounting elements</li> </ul>							
Height (mm) (A)	Width (mm) (B)	Depth (mm) (C)	References	100 mm	200 mm	100 mm	200 mm					
1600	600	600	NSYSMX16660PC	NSYSPFX6100H	NSYSPFX6200H	NSYSPSX6100H	2 x NSYSPSX6100H					
1800	600	600	NSYSMX18660PC	NSYSPFX6100H	NSYSPFX6200H	NSYSPSX6100H	2 x NSYSPSX6100H					
<p>The technical drawing shows the front and side views of the PC rack. The front view shows a total height of 1280 mm and a width of 600 mm. The side view shows a depth of 600 mm. A table below the drawing lists dimensions A and D for heights 1600 mm and 1800 mm. Labels (1) and (2) indicate the adjustable shelf and the sealed keyboard case respectively.</p> <table border="1"> <thead> <tr> <th>A</th> <th>D</th> </tr> </thead> <tbody> <tr> <td>1600</td> <td>690</td> </tr> <tr> <td>1800</td> <td>890</td> </tr> </tbody> </table> <p>(1) Screwed shelf, adjustable height. (2) Sealed case for keyboard.</p>			A	D	1600	690	1800	890				
A	D											
1600	690											
1800	890											

# Variable speed drive flush-mounting kits

## Introduction

**New**

> The variable speed drive flush-mounting kits have been designed to isolate the power part, which is an important source of heat. They are mounted in the Spacial range of steel enclosures (floor-standing and wall-mounting enclosures) and have been approved for Altivar Process variable speed drives in the ATV630 and ATV930 ranges (power range: 0.75 to 45 kW at 200/240 V, 0.75 to 90 kW at 380/480 V).

> The kits are available in five sizes and offer two methods of mounting variable speed drives:

- slide-rail mounting for sizes 1, 2 and 3
- bracket mounting for sizes 4 and 5.

> The kits can be installed:

- at the back of the enclosure. This installation provides full thermal insulation



**Tightness**  
IP55 to IEC 60529 with polyurethane seal provided.



**Ease of installation**  
Set of slide-rails allowing the variable speed drive to be mounted quickly and efficiently.



**Strength**  
The rigidity of the kit allows it to be installed on Spacial S3D, SF and SM enclosures.



**Earth continuity**  
Earth continuity is ensured by tightening the M6 nuts associated with pin washers.

**Maintenance of the variable speed drive fan (kit sizes 4 and 5)**  
Easy front-panel maintenance for fan servicing.



**Configured offer**

**Services**  
Possibility of cutouts (enclosure and frame) by Schneider Electric: no risk of corrosion and cuts (cutout made before painting).

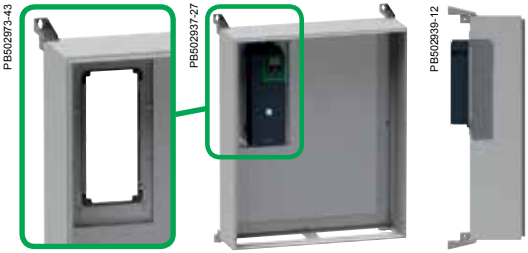

- inside the enclosure on a mounting plate. This installation may require the addition of a thermal control.

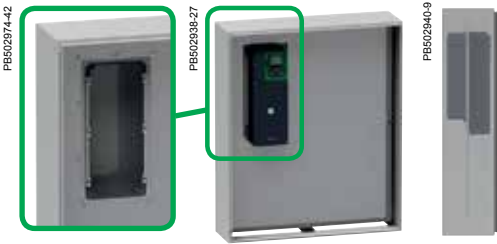

# Variable speed drive flush-mounting kits

## Characteristics

New

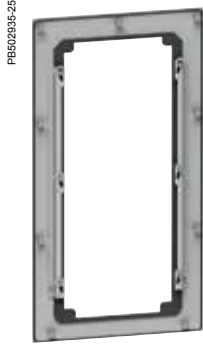

Sizes 1, 2 and 3.



Sizes 4 and 5.

Characteristics	Mounting kits
	Variable speed drive installation kits allowing the hot part to be isolated.
Material	Steel
Finish	<ul style="list-style-type: none"> <li>Painted with epoxy-polyester resin</li> <li>Salt spray resistance: 336 h</li> </ul>
Colour	RAL 7035 grey
Ingress protection rating	IP55
Mechanical protection rating	-
Certifications	IEC 62208, UL 508A under development
Supply	<p><b>Sizes 1, 2 and 3:</b></p> <ul style="list-style-type: none"> <li>Painted steel plate with cutout fitted with two slide-rails + adhesive seal + 7 to 9 M6 studs for kit mounting</li> <li>Protection seal profile supplied for frame cutout</li> <li>Enclosure drilling template</li> </ul> <p><b>Sizes 4 and 5:</b></p> <ul style="list-style-type: none"> <li>Painted steel plates with cutout fitted with painted mounting brackets + screws and nuts for mounting the brackets and the kit</li> <li>Protection seal supplied for frame cutout</li> <li>Enclosure drilling template</li> <li>Fan support for ease of maintenance</li> <li>Protective cover</li> </ul>

Dimensions (mm)			Sizes	Compatibilities	References																					
H	L	P				Kits																				
<table border="1"> <thead> <tr> <th rowspan="2">Enclosures</th> <th colspan="2">Variable speed drives</th> <th colspan="2">ATV930</th> <th rowspan="2">References</th> </tr> <tr> <th>200/240 V</th> <th>380/480 V</th> <th>200/240 V</th> <th>380/480 V</th> </tr> </thead> </table>					Enclosures	Variable speed drives		ATV930		References	200/240 V	380/480 V	200/240 V	380/480 V												
Enclosures	Variable speed drives		ATV930			References																				
	200/240 V	380/480 V	200/240 V	380/480 V																						
360	235	22	1	S3D, SF, SM	<table border="1"> <tbody> <tr> <td>ATV630U07M3</td> <td>ATV630U07N4</td> <td>ATV930U07M3</td> <td>ATV930U07N4</td> <td rowspan="5">NSYPTDS1</td> </tr> <tr> <td>ATV630U15M3</td> <td>ATV630U15N4</td> <td>ATV930U15M3</td> <td>ATV930U15N4</td> </tr> <tr> <td>ATV630U22M3</td> <td>ATV630U22N4</td> <td>ATV930U22M3</td> <td>ATV930U22N4</td> </tr> <tr> <td>ATV630U30M3</td> <td>ATV630U30N4</td> <td>ATV930U30M3</td> <td>ATV930U30N4</td> </tr> <tr> <td>ATV630U40M3</td> <td>ATV630U40N4</td> <td>ATV930U40M3</td> <td>ATV930U40N4</td> </tr> </tbody> </table>	ATV630U07M3	ATV630U07N4	ATV930U07M3	ATV930U07N4	NSYPTDS1	ATV630U15M3	ATV630U15N4	ATV930U15M3	ATV930U15N4	ATV630U22M3	ATV630U22N4	ATV930U22M3	ATV930U22N4	ATV630U30M3	ATV630U30N4	ATV930U30M3	ATV930U30N4	ATV630U40M3	ATV630U40N4	ATV930U40M3	ATV930U40N4
ATV630U07M3	ATV630U07N4	ATV930U07M3	ATV930U07N4	NSYPTDS1																						
ATV630U15M3	ATV630U15N4	ATV930U15M3	ATV930U15N4																							
ATV630U22M3	ATV630U22N4	ATV930U22M3	ATV930U22N4																							
ATV630U30M3	ATV630U30N4	ATV930U30M3	ATV930U30N4																							
ATV630U40M3	ATV630U40N4	ATV930U40M3	ATV930U40N4																							
420	265	22	2	S3D, SF, SM	<table border="1"> <tbody> <tr> <td>ATV630U55M3</td> <td>ATV630U75N4</td> <td>ATV930U55M3</td> <td>ATV930U75N4</td> <td rowspan="2">NSYPTDS2</td> </tr> <tr> <td></td> <td>ATV630D11N4</td> <td></td> <td>ATV930D11N4</td> </tr> </tbody> </table>	ATV630U55M3	ATV630U75N4	ATV930U55M3	ATV930U75N4	NSYPTDS2		ATV630D11N4		ATV930D11N4												
ATV630U55M3	ATV630U75N4	ATV930U55M3	ATV930U75N4	NSYPTDS2																						
	ATV630D11N4		ATV930D11N4																							
555	295	22	3	S3D, SF, SM	<table border="1"> <tbody> <tr> <td>ATV630U75M3</td> <td>ATV630D15N4</td> <td>ATV930U75M3</td> <td>ATV930D15N4</td> <td rowspan="3">NSYPTDS3</td> </tr> <tr> <td>ATV630D11M3</td> <td>ATV630D18N4</td> <td>ATV930D11M3</td> <td>ATV930D18N4</td> </tr> <tr> <td></td> <td>ATV630D22N4</td> <td></td> <td>ATV930D22N4</td> </tr> </tbody> </table>	ATV630U75M3	ATV630D15N4	ATV930U75M3	ATV930D15N4	NSYPTDS3	ATV630D11M3	ATV630D18N4	ATV930D11M3	ATV930D18N4		ATV630D22N4		ATV930D22N4								
ATV630U75M3	ATV630D15N4	ATV930U75M3	ATV930D15N4	NSYPTDS3																						
ATV630D11M3	ATV630D18N4	ATV930D11M3	ATV930D18N4																							
	ATV630D22N4		ATV930D22N4																							
800	385	151,5	4	SF, SM	<table border="1"> <tbody> <tr> <td>ATV630D15M3</td> <td>ATV630D30N4</td> <td>ATV930D15M3</td> <td>ATV930D30N4</td> <td rowspan="3">NSYPTDS4</td> </tr> <tr> <td>ATV630D18M3</td> <td>ATV630D37N4</td> <td>ATV930D18M3</td> <td>ATV930D37N4</td> </tr> <tr> <td>ATV630D22M3</td> <td>ATV630D45N4</td> <td>ATV930D22M3</td> <td>ATV930D45N4</td> </tr> </tbody> </table>	ATV630D15M3	ATV630D30N4	ATV930D15M3	ATV930D30N4	NSYPTDS4	ATV630D18M3	ATV630D37N4	ATV930D18M3	ATV930D37N4	ATV630D22M3	ATV630D45N4	ATV930D22M3	ATV930D45N4								
ATV630D15M3	ATV630D30N4	ATV930D15M3	ATV930D30N4	NSYPTDS4																						
ATV630D18M3	ATV630D37N4	ATV930D18M3	ATV930D37N4																							
ATV630D22M3	ATV630D45N4	ATV930D22M3	ATV930D45N4																							
975	427	205,5	5	SF, SM	<table border="1"> <tbody> <tr> <td>ATV630D30M3</td> <td>ATV630D55N4</td> <td>ATV930D30M3</td> <td>ATV930D55N4</td> <td rowspan="3">NSYPTDS5</td> </tr> <tr> <td>ATV630D37M3</td> <td>ATV630D75N4</td> <td>ATV930D37M3</td> <td>ATV930D75N4</td> </tr> <tr> <td>ATV630D45M3</td> <td>ATV630D90N4</td> <td>ATV930D45M3</td> <td>ATV930D90N4</td> </tr> </tbody> </table>	ATV630D30M3	ATV630D55N4	ATV930D30M3	ATV930D55N4	NSYPTDS5	ATV630D37M3	ATV630D75N4	ATV930D37M3	ATV930D75N4	ATV630D45M3	ATV630D90N4	ATV930D45M3	ATV930D90N4								
ATV630D30M3	ATV630D55N4	ATV930D30M3	ATV930D55N4	NSYPTDS5																						
ATV630D37M3	ATV630D75N4	ATV930D37M3	ATV930D75N4																							
ATV630D45M3	ATV630D90N4	ATV930D45M3	ATV930D90N4																							

# Variable speed drive flush-mounting kits

## Dimensions

New

**NSYPTDS1**

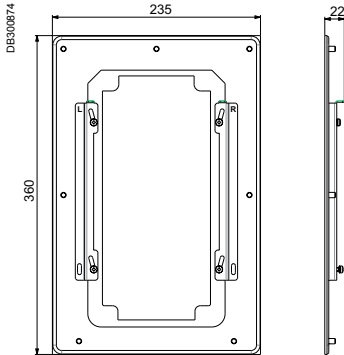

**NSYPTDS2**

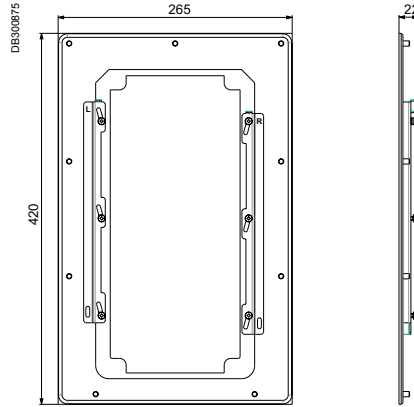

**NSYPTDS3**

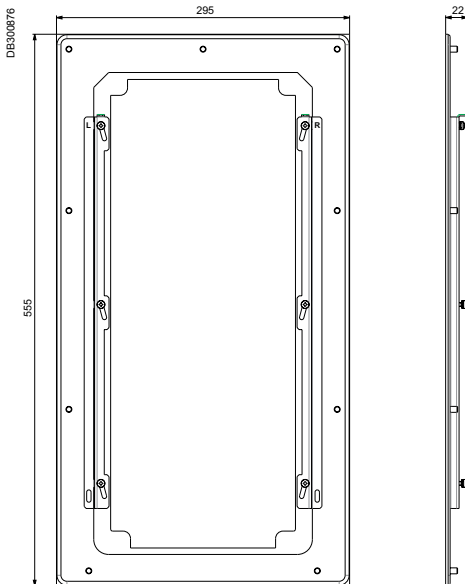

**NSYPTDS4**

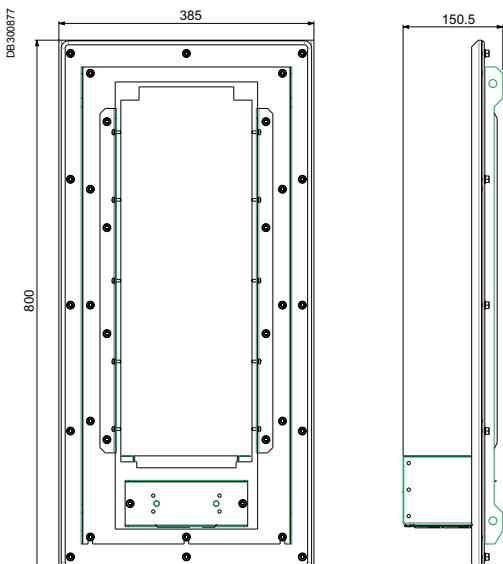

**NSYPTDS5**

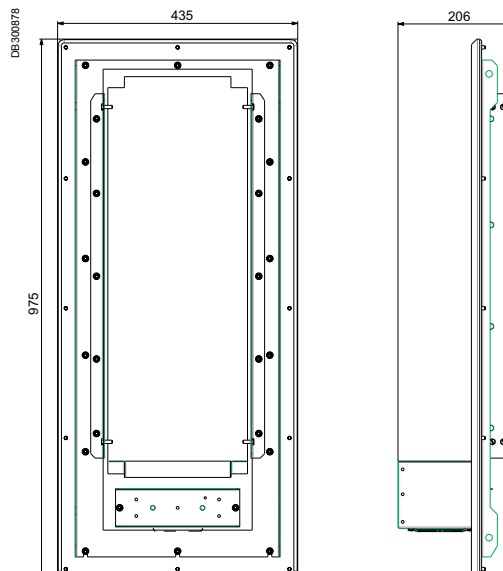



# Variable speed drive flush-mounting kits

## Mounting accessory

New



Characteristics		Wall-mounting enclosure mounting lug	
Maximum load		105 kg	
Material		Painted steel RAL 7035	
Supply		Set of 4 lugs and brackets + fasteners	
Wall-mounting enclosure Dimensions (mm)		References	
Height	Width	Variable speed drive flush-mounting kits	Mounting lug
≥ 400	≥ 300	NSYPTDS1	NSYAEFPFPTD
≥ 500	≥ 300	NSYPTDS2	
≥ 600	≥ 400	NSYPTDS3	

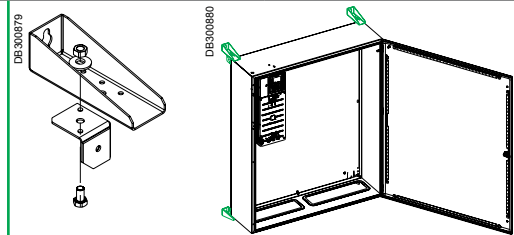

➤ The door of the "incoming" enclosure is interlocked by the control of the main switch or circuit breaker. A built-in interlocking system with runner rods prevents the opening of the "outgoing" enclosure doors. Access is only allowed when the main switch or circuit breaker is in "O" position and the main door is open. Manual activation of the rods unlocks the other doors and allows access.

➤ Designed to be associated with certain circuit breakers or switches:

- Square D (9422 A1).
- Schneider Electric.

➤ The system is limited for configurations up to 4 columns.



### Secure

The built-in secure interlocking system for the door (on demand) of the "incoming"/"outgoing" enclosures allows Spacial SF enclosures to be adapted to the requirements of the American car industry.

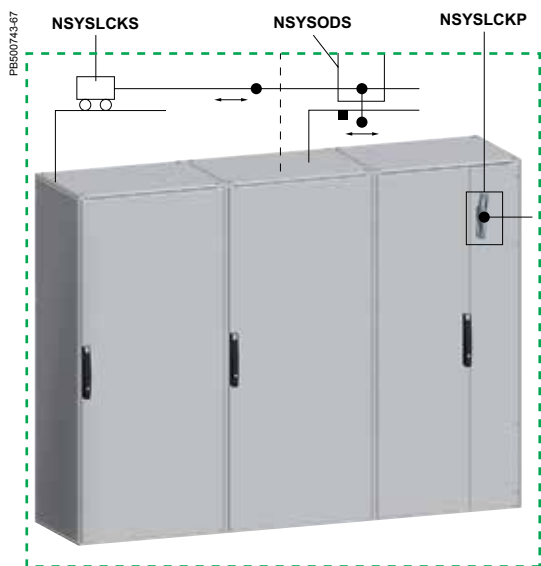

# Automobile application

## Characteristics

PB500744-31

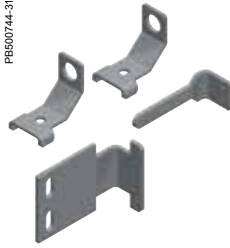

PB500746-43



PB500747-35



Characteristics	Interlocking for main door	Activation for secondary doors	Interlocking for secondary doors								
	<ul style="list-style-type: none"> <li>■ System for unlocking the main door adapted to the switches:                             <ul style="list-style-type: none"> <li>□ Allen Bradley (1494 VH11).</li> <li>□ Square D (9422 A1).</li> <li>□ Siemens (FH0H).</li> <li>□ Schneider Electric.</li> </ul> </li> <li>■ Unlocks the main door when the switch is in the open position "O".</li> <li>■ The main door interlocking system requires the ordering of both references:                             <ul style="list-style-type: none"> <li>□ ① Activation for secondary doors.</li> <li>□ ② Interlocking for secondary doors.</li> </ul> </li> </ul>	<p>System installed in the main enclosure. Activated by manual operation, preventing the opening of the secondary enclosures connected to one another by runner rods.</p> <p>It has a secure function which consists of a part that forces the system into the position in which the secondary enclosures are locked in order to lock the main door.</p>	<p>System for interlocking the outgoing enclosures connected to one another by runner rods that lock their doors.</p>								
Material	Steel	<ul style="list-style-type: none"> <li>■ Mechanism: zinc-coated steel</li> <li>■ Activation handle: black plastic</li> </ul>	Steel								
Finish	Zinc-coated	-	Zinc-coated								
Mounting	-	-	Mounting to the structure of the enclosures by screws								
Supply	2 brackets for mounting the configured panel, interlocking elements, switch and mountings. Configured panel and handle not included.	Elements for activating the main door and mountings. For the complete function, both activation ① and interlocking systems ② need to be ordered.	Elements for interlocking the secondary doors and mountings. For the complete function, both activation ① and interlocking systems ② need to be ordered.								
<b>References</b>	<b>NSYSLCKP</b>	<b>NSYSODS</b>	<table border="1"> <thead> <tr> <th>Width (mm)</th> <th>References</th> </tr> </thead> <tbody> <tr> <td>600</td> <td>NSYSLCKS6</td> </tr> <tr> <td>800</td> <td>NSYSLCKS8</td> </tr> <tr> <td>1000</td> <td>NSYSLCKS10</td> </tr> </tbody> </table>	Width (mm)	References	600	NSYSLCKS6	800	NSYSLCKS8	1000	NSYSLCKS10
Width (mm)	References										
600	NSYSLCKS6										
800	NSYSLCKS8										
1000	NSYSLCKS10										

PB500745-22



The fixed panel in this example must be ordered through our customised service.

# The customised solutions

## Configured offer

## Introduction



Configured

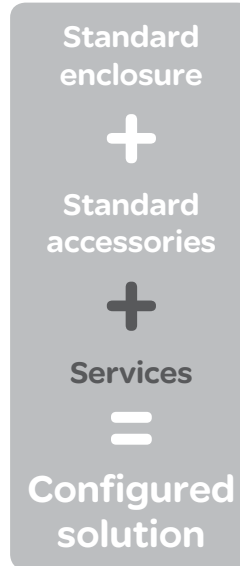

The **configured offer** is a standard offer enriched by **4 services**



### Assemble to order

- Change the cladding composition (panels, doors...)
- Merge and assemble several enclosures (only for Spacial SF and Thalassa PLA)
- + Enclosure composition stick 100 % to customer needs
- + No need to have qualified personnel to merge enclosures



### Painting

- Change the colour of the complete enclosure (choice of 36 colours)
- Modify the coating of the raw material (ex.: zinc, etc.)
- + Industrial painting ensures the best protection
- + Totally customized



### Machining

- Make square and circle cut-outs **before** painting the enclosure (body, cable gland plate, sides) and mounting plates
- + Ensures safety and the best protection against rust
- + The enclosure is ready to be equipped



### Mounting of standard accessories

- Pre-installation of accessories inside or out-side of the enclosure (ex.: mounting plate, plinth, canopy, etc.)
- + Enclosure ready to be equipped

*Minimum order: 1 to 5, depends on type of enclosure.  
Manufacturing time: 3 to 10 days, depends on offer type.  
Delivery time: varies with destination, please consult us for more information.*

# Spacial.conf configuration tool

**Spacial.conf** is the configuration tool to be used to place your order. It gives you several benefits:

## > Consistency & error free

- One configurator for 14 countries & all configurable offers
- Compatibility between enclosure & accessories

## > Time saving & flexibility

- Users can indicate machining requests directly on our DXF drawing
- Decreasing price (depends on quantity)
- Manufacturing time adapted to each offer

## > Autonomy & facility

- Availability of both on-line & off-line versions
- Illustrated products help you in your choice
- FAQ information for faster understanding

## > Information back-up

- All data are provided to registered users (quotation, technical datasheet, etc.)
- Reusable smart code

## Your order in 5 steps with Spacial.conf:

### 1 - Select country & language

- 14 countries
- 4 languages



### 2 - Select enclosure

- Select product range
- Select material
- Select enclosure type

### 3 - Select accessories

- Composition accessories
- Mounting accessories
- Thermal accessories

### 4 - Select services

- Mounting
- Machining
- Painting
- Assembly

### 5 - Validation & send offer

- Order summary
- Send order to get quotation confirmation from local sales representative

Have a smartphone or a tablet? Scan this >



# The customised solutions

## Specific offer

## Introduction



Specific



# 20

experts

specialized on  
different materials  
and different  
products



The **specific offer** allows you to have a tailor-made product

- > Special dimensions, special needs for thermal system, special components adaptation, etc. All possibilities are open.
- > You can choose to modify any of our standard products (boxes or enclosures, wall-mounting or floor-standing) or start from a newly designed solution.
- > Co-engineer your solution with our design and engineering team (20 experts entirely dedicated to your specific needs).

### ★ Examples of Specific solution



- Special dimension
- Cut-outs on the body and the doors



- Cable-entry & door adaptation
- Special door shape

## What to take into account

This page will help you define your needs for enclosure and streamline your design process. You will then need to contact your sales representative.

### Step 1

#### Environment in which you'll install the enclosure(s)

- > Airborne debris; temperature variations; UV rays?
  - > Indoor or outdoor use?
  - > In wash down environment?
  - > In high traffic environment?
- 

### Step 2

#### Application(s) needs of your enclosure(s)

- > Access control; building automation; motor & motion control?
  - > Need to protect against electromagnetic disturbances?
  - > Use in potentially explosive atmospheres?
- 

### Step 3

#### Enclosure(s) description

- > Type of enclosure's installation?
  - > Total weight of equipments in the enclosure?
  - > Design: color / coating / finish / dimension?
  - > Body components' adaptations: cable entry / mounting plate?
  - > Thermal management adaptations?
  - > Other accessories adaptations?
  - > Additional information: labeling / packaging / logistic?
- 







### Step 4

#### Business profile

- > Total quantity of enclosures needed and quantity per batch?
  - > Frequency of your order: single order / repeat order?
  - > Delivery time and method demand?
  - > Stock needs?
  - > Other comments?
-

# Thermal management system



	<b>ClimaSys</b>	<b>402</b>
	Overview	402
	<b>ClimaSys CV</b> Ventilation systems	<b>406</b>
	<b>New</b> <b>ClimaSys CE</b> Exchangers	<b>424</b>
	<b>New</b> <b>ClimaSys CU</b> Cooling Units	<b>435</b>
	<b>ClimaSys CRS</b> Ultra thin resistance heaters	<b>452</b>
	<b>ClimaSys CR</b> Resistance Heaters	<b>454</b>
	<b>New</b> <b>ClimaSys CC</b> Thermal Control	<b>459</b>
	<b>Thermal balance</b>	<b>465</b>
	<b>Software</b>	<b>469</b>
	<b>Calculation and selection</b>	<b>471</b>



## What is thermal control?

### Technological evolution

The miniaturisation of components, the generalisation of electronics and the appearance of new electronically powered products have made temperature management into a growing need which must necessarily be considered when designing electrical and/or industrial control panels.

### What are the advantages of efficient thermal management?

Thermal management of industrial control panels is a major factor for industrial maintenance.

Many risks are incurred by not having a suitable thermal solution, which can affect the service life of the components and the performance of the facilities to the extent of causing a halt in production.

The service life of the components also depends on the temperature and humidity conditions inside the enclosure. The ideal values range from +25 to +35°C for the temperature and 40 to 60 % for the relative humidity (RH).

### Cooling, heating, controlling

For the same reasons as the IP/IK protection ratings, equipment installed in enclosures requires suitable thermal protection.





Various solutions to these problems have been put forward. They will be chosen according to environmental conditions, the type of components in the industrial control panel, etc.

In certain cases, it is sufficient to oversize the enclosure, use fans or air-air exchangers, etc. In other cases, where the ambient temperature is higher, it becomes necessary to install air-water exchangers or cooling units.

### A solution for each need

We provide a complete Thermal offer to secure your installations.

#### Cooling

- 
> **Forced ventilation systems**
- 
> **Air-air exchangers**
- 
> **Air-water exchangers**
- 
> **Cooling units**

#### Heating

- 
> **Resistance heaters**

#### Controlling

- 
> **Thermal control accessories**

#### Thermal software

- 

### Risks associated with the lack of thermal control

#### Random breakdowns and production halts result in heavy losses

Thermal control of enclosures extends the service life of the components and reduces their breakdown rate.

#### Reduction of the service life of the components

The service life of the components is considerably reduced if the temperature and humidity in enclosures are not controlled. Repeated sudden variations speed up the aging process.



#### Example

##### Batteries – Accumulators

Manufacturers recommend installing batteries in environments where the controlled temperature is 15°C... 25°C. Cold slows down the battery charging and discharging cycles. Heat increases the evaporation of water in the electrolyte and speeds up the oxidation of the plates. Using batteries at temperatures above the recommended value therefore reduces their service life.

PB60/016-59



#### Sudden production halt

The appearance of hot spots increases the breakdown rate and endangers the production process.



#### Example

##### Electronic equipment

Most electronic industrial control systems are equipped with axial fans for their own thermal control. A failure of the fan can lead to a production halt.

Reduced service life of the fan is one consequence of the enclosure heating up. 24 V DC axial fan.

- Temperature range: -20... +70°C.
- Service life at 20°C (L10 at 20°C): 50000 h.
- Service life at 60°C (L10 at 20°C): 20000 h.

The service life of the equipment can drop from 50000 h to only 20000 h.

PB60/017-88



PB60/018-51



#### The internal temperature increases with a high degree of IP

In aggressive atmospheres: dust, humidity, chemical agents, high temperatures, etc., the equipment is installed in industrial enclosures (IP54) in order to protect it from the external environment. Nevertheless, it causes a reheating phenomenon which, if left unchecked, will be responsible in the short term for a halt in the operation of the components.



#### Example

##### Variable speed drives

A variable speed drive controlling a 45 kW (60 HP) motor is programmed to work at temperatures ranging up to 50°C or 60°C.

The power dissipated by this variable speed drive inside the enclosure can reach 1360 W. This contribution of heat inside the enclosure will cause the top temperature to rise to 60°C and probably cause a halt in production.

PB60/019-58



#### Our solution





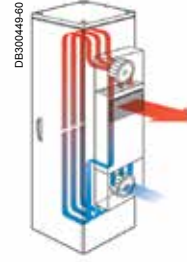
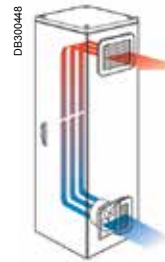
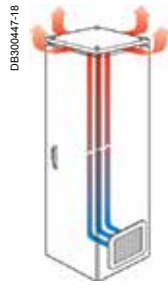

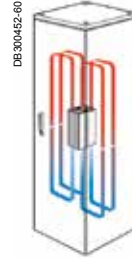
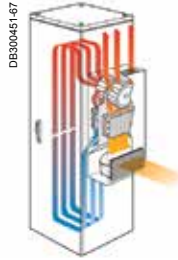

Our new thermal offer includes a large range of solutions, suitable for all situations, from installing a ventilation system to exchangers or even a cooling unit. Do not hesitate to contact us to find out the best thermal solution for your installation.

# Thermal management system Overview

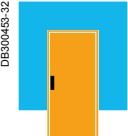

System	Airing	Ventilating	Air-air exchanger
	Natural convection causes the temperature to drop inside the enclosure. Simple solutions for this case include installing grilles (without filter) or lifting the top.	Fans with filters are designed to evacuate a large amount of heat economically.	Air-air exchangers are equipped with an aluminium exchange cassette which separates the internal and external air circuits and prevents the entry of dust.
When should it be used?	This solution can only be used when the power to be dissipated is low, in an environment with small amounts of dust.	When larger amounts of heat need to be evacuated in a polluted environment.	The air-air exchangers are used in highly polluted environments or when it is necessary to evacuate large amounts of heat while guaranteeing the independence of the internal and external air circuits. It is important to have a difference of temperature of at least 10°C.
Ta: Ambient temperature Td: Desired temperature	 <b>Ta &lt; Td</b>	 <b>Ta &lt; Td</b>	 <b>Ta &lt; Td</b>
The internal and external air circuits must be independent	 <b>No</b>	 <b>No</b>	 <b>Yes</b>
Advantages	<ul style="list-style-type: none"> <li>■ Economic solution.</li> <li>■ No maintenance.</li> <li>■ Quick and easy installation.</li> </ul>	<ul style="list-style-type: none"> <li>■ Economic solution.</li> <li>■ Easy maintenance.</li> <li>■ Quick and easy installation.</li> <li>■ Even temperature inside the enclosure.</li> <li>■ High protection rating: IP54 or IP55.</li> </ul>	<ul style="list-style-type: none"> <li>■ The internal and external air circuits are independent.</li> <li>■ Easy maintenance.</li> <li>■ High protection rating: IP55.</li> </ul>
Disadvantages	<ul style="list-style-type: none"> <li>■ Small amount of heat evacuated.</li> <li>■ Reduction of the IP protection rating.</li> <li>■ Risk of entry of dust particles.</li> </ul>	<ul style="list-style-type: none"> <li>■ The temperature inside the enclosure is always higher than the external temperature.</li> <li>■ The internal and external air circuits are in contact.</li> <li>■ Maintenance required: filter replacement.</li> </ul>	<ul style="list-style-type: none"> <li>■ The temperature inside the enclosure is always higher than the external temperature.</li> </ul>
Solutions	 Ventilation devices	 Fans and outlet grilles	 Air-air exchangers



	Air-water exchanger	Cooling	Heating
	<p>Air-water exchangers reduce the temperature inside the enclosure by means of a water-cooled exchange cassette. Temperature control inside the enclosure is performed by a thermostat which opens and closes an electro-valve.</p>	<p>Air-conditioning device providing efficient cooling of the enclosure, regardless of the outside air, and prevention against hot spots.</p>	<p>The resistance heaters prevent the formation of condensation and guarantee the ideal temperature for the correct operation of the electronic components.</p>
	<p>The air-water exchangers are used to evacuate large amounts of heat. They require a cold-water circuit with stable temperature and flow rate. They are specially recommended in difficult, highly polluted environments where there is no external air circuit.</p>	<p>The cooling units can be used in the harshest environments, where the temperature can reach up to 55°C. These devices control the temperature inside the enclosure and include an alarm function for signalling operational anomalies.</p>	<p>The resistance heaters are used to reheat the industrial control panel when the ambient temperature is too low or to prevent the formation of condensation.</p>
	 <p><b>Ta &gt; Td</b></p>	 <p><b>Ta &gt; Td</b></p>	 <p><b>Ta &lt; Td</b></p>
	 <p><b>Yes</b></p>	 <p><b>Yes</b></p>	
	<ul style="list-style-type: none"> <li>■ The temperature inside the enclosure does not depend on the external temperature.</li> <li>■ The internal and external air circuits are independent.</li> <li>■ Security device against possible leaks.</li> <li>■ High protection rating: IP55 or IP54 according to model.</li> </ul>	<ul style="list-style-type: none"> <li>■ Even temperature inside the enclosure.</li> <li>■ High protection rating: IP55 or IP54 according to model.</li> <li>■ Use of an environmentally friendly gas.</li> </ul>	<ul style="list-style-type: none"> <li>■ Small dimensions.</li> <li>■ Available in 3 versions:                             <ul style="list-style-type: none"> <li><input type="checkbox"/> insulated with low surface temperature,</li> <li><input type="checkbox"/> in aluminium when the surface temperature is limited to 75°C,</li> <li><input type="checkbox"/> ultra thin heaters.</li> </ul> </li> <li>■ The fan-equipped resistances guarantee an even temperature inside the enclosure.</li> </ul>
	<ul style="list-style-type: none"> <li>■ A cold-water supply source is required.</li> <li>■ Specific pumping installation.</li> </ul>	<ul style="list-style-type: none"> <li>■ Installation of a drain is recommended.</li> <li>■ Maintenance required: filter replacement.</li> </ul>	
	 <p>Air-water exchangers</p>	 <p>Cooling units</p>	 <p>Resistance heaters</p>

**> Large range of fans:**

flow rate efficiency, high protection rating, quick installation and easier maintenance to secure all the applications.

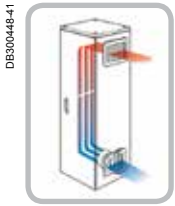

DB50048-41



FB501021-80

## Ventilation Systems



FB501038-22

FB501040-42

### Easy installation

#### Quick installation

- Safe, reliable mounting with the assisted mounting device and system of multi-thickness mounting-clips.
- Mounting also possible using screws.
- Easy to invert.
- To operate as extractors, all the motors can be inverted by simply removing four screws.

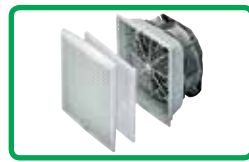

FB501041-27

### Easy maintenance

#### Quick filter replacement

Quick, easy and safe replacement of the filter installed in the fan, even during operation.



FB501042-28

### Quality of the components

#### Selection of the motors

- Improved flow rate and longer service life.
- Large range of input voltages available on all the motors delivered as standard, with alternating 50/60 Hz or direct current.



DB123816-26

### Ventilation offer

With homologation UL available.



FB501032-38

### Optimised flow rate: average increase of 50 %

- Maximum use of surface.
- Minimum loss of pressure.

### High protection rating: IP54 as standard

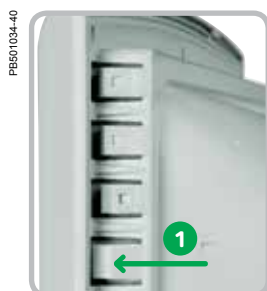

#### 1 - Mounting guide

- To centre the body of the fan on the wall of enclosure.
- To correct machining faults.
- To facilitate the correct operation of the mounting "clips".

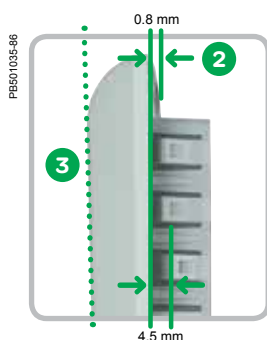

#### 2 - Multi-thickness mounting clips

- For easy and reliable mounting of the ventilation system.
- With a thickness of 0.8 to 4.5 mm, with no fixings.

#### 3 - Inclined profile of the grille

- To protect the filter against vertical spraying:
  - each slat is protected by the slat above it,
  - the external dimensions remain small.

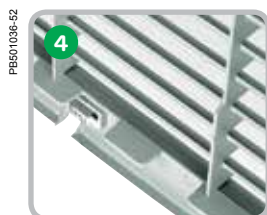

#### 4 - IP54-55

A patented system allows the evacuation of water absorbed by the filter, in particular during high-pressure spraying.



#### 5 - Hot-fitted sealing gasket

The polyurethane gasket, hot cast, guarantees a long-lasting seal.



#### 6 - Effective system for retaining the filter

The system for holding the synthetic filter in the cavity of the filter holder guarantees a protection rating of IP54, in the most difficult conditions.

### Ventilation Systems

#### Forced ventilation

#### Characteristics

Material

Colour

Conditions of use

Ingress protection rating

Installation

Options

Free flow rate with standard filter (m <sup>3</sup> /h)	Flow rate with outlet grille(s) (m <sup>3</sup> /h)		Voltage range (nominal voltage)	Absorbed power (max. intensity)	Noise level	External dimensions (cut-out)	Weight	Operating temperature	Max. static pressure
	1	2							
38 (50 Hz) 39 (60 Hz)	25 (50 Hz) 26 (60 Hz)	33 (50 Hz)	150 V...250 V (230 V)	4.5/4.8 W (0.16/0.17 A)	40/41 dB (A)	137 x 117 x 49 (92 x 92)	0.220 kg	-10...+70°C	29 Pa
38 (50 Hz) 39 (60 Hz)	27 (50 Hz) 28 (60 Hz)	35 (50 Hz)	75 V...125 V (115 V)	3.3/3.5 W (0.16/0.16 A)	40/41 dB (A)	137 x 117 x 49 (92 x 92)	0.220 kg	-10...+70°C	29 Pa
58	39	47 (50 Hz)	10 V...27.6 V (24 V DC)	3.6 W (0.18 A)	40/41 dB (A)	137 x 117 x 49 (92 x 92)	0.230 kg	-10...+70°C	29 Pa
44	34	41 (50 Hz)	36 V...56 V (48 V DC)	3.6 W (70 mA)	40/41 dB (A)	137 x 117 x 49 (92 x 92)	0.230 kg	-10...+70°C	29 Pa
85 (50 Hz) 98 (60 Hz)	63 (50 Hz) 72 (60 Hz)	71 (50 Hz)	175 V...253 V (230 V)	17/15 W (0.121/0.097 A)	46/49 dB (A)	170 x 150 x 62 (125)	0.780 kg	-20...+60°C	50 Pa
79 (50 Hz) 92 (60 Hz)	65 (50 Hz) 74 (60 Hz)	73 (50 Hz)	75 V...126 V (115 V)	16/15 W (0.207/0.179 A)	46/49 dB (A)	170 x 150 x 62 (125)	0.780 kg	-20...+60°C	50 Pa
80	57	77 (50 Hz)	10 V...27.6 V (24 V DC)	7.6 W (0.30 A)	46/49 dB (A)	170 x 150 x 62 (125)	0.480 kg	-10...+70°C	50 Pa
79	59	68 (50 Hz)	25 V...55.2 V (48 V DC)	8 W (0.173 A)	46/49 dB (A)	170 x 150 x 62 (125)	0.480 kg	-10...+70°C	50 Pa
165 (50 Hz) 193 (60 Hz)	153 (50 Hz) 171 (60 Hz)	161 (50 Hz) 175 (60 Hz)	175 V...253 V (230 V)	16.3/14.3 W (0.12/0.94 A)	50/51 dB (A)	268 x 248 x 104 (223 x 223)	1.140 kg	-20...+60°C	50 Pa
164 (50 Hz) 193 (60 Hz)	153 (50 Hz) 171 (60 Hz)	161 (50 Hz) 179 (60 Hz)	75 V...126 V (115 V)	15.5/14.4 W (0.20/0.18 A)	50/51 dB (A)	268 x 248 x 104 (223 x 223)	1.140 kg	-20...+60°C	50 Pa
188	171	179	10 V...27.6 V (24 V DC)	8 W (0.3 A)	50/51 dB (A)	268 x 248 x 104 (223 x 223)	0.810 kg	-10...+70°C	50 Pa
193	171	179	25 V...55.2 V (48 V DC)	8.7 W (0.18 A)	50/51 dB (A)	268 x 248 x 104 (223 x 223)	0.810 kg	-10...+70°C	50 Pa
302 (50 Hz) 350 (60 Hz)	260 (50 Hz) 307 (60 Hz)	268 (50 Hz)	145 V...253 V (230 V)	36/37 W (0.17/0.16 A)	55/56 dB (A)	268 x 248 x 116 (223 x 223)	1.3 kg	-10...+70°C	158 Pa
302 (50 Hz) 350 (60 Hz)	263 (50 Hz) 307 (60 Hz)	271 (50 Hz)	75 V...126 V (115 V)	36/36 W (0.35/0.32 A)	55/56 dB (A)	268 x 248 x 116 (223 x 223)	1.3 kg	-10...+70°C	158 Pa
262	221	229 (50 Hz)	12 V...30 V (24 V DC)	13 W (0.53 A)	55/56 dB (A)	268 x 248 x 103.4 (223 x 223)	1.1 kg	-10...+70°C	158 Pa
247	210	218 (50 Hz)	25 V...60 V (48 V DC)	11 W (0.24 A)	55/56 dB (A)	268 x 248 x 103.4 (223 x 223)	1.1 kg	-10...+70°C	158 Pa
562 (50 Hz) 586 (60 Hz)	473 (50 Hz) 477 (60 Hz)	481 (50 Hz)	207 V...244 V (230 V)	68/85 W (0.52/0.370 A)	59/59 dB (A)	336 x 316 x 161 (291 x 291)	3.2 kg	-15...+60°C	140 Pa
582 (50 Hz) 586 (60 Hz)	485 (50 Hz) 477 (60 Hz)	494 (50 Hz)	103 V...122 V (115 V)	65/83 W (0.60/0.72 A)	59/59 dB (A)	336 x 316 x 161 (291 x 291)	3.2 kg	-15...+60°C	140 Pa
838 (50 Hz) 803 (60 Hz)	718 (50 Hz) 568 (60 Hz)	728 (50 Hz)	207 V...244 V (230 V)	150/195 W (0.65/0.85 A)	76/75 dB (A)	336 x 316 x 162 (291 x 291)	4.1 kg	-15...+60°C	170 Pa
983 (50 Hz) 944 (60 Hz)	843 (50 Hz) 642 (60 Hz)	854 (50 Hz)	103 V...122 V (115 V)	145/182 W (1.279/1.6 A)	78/77 dB (A)	336 x 316 x 162 (291 x 291)	4.1 kg	-15...+60°C	170 Pa
931 (50 Hz) 803 (60 Hz)	798 (50 Hz) 568 (60 Hz)	809 (50 Hz)	396 V...466 V (400 V)	126/126 W (0.226/0.232 A)	77/75 dB (A)	336 x 316 x 162 (291 x 291)	4.1 kg	-15...+60°C	170 Pa



# Thermal management system

## Characteristics



Forced ventilation fan 38 m³/h	Forced ventilation fan 85 m³/h	Forced ventilation fan 165 m³/h	Forced ventilation fan 300 m³/h	Forced ventilation fan 560-850 m³/h
-----------------------------------	-----------------------------------	------------------------------------	------------------------------------	--

The fans comprise an axial motor, a protective housing on the front and rear surfaces and a filter designed to retain dust particles. This filter can be replaced during operation without risk of contact with the rotating element.

Injected thermoplastic (ASA PC), self-extinguishing according to UL 94 V-0

RAL 7035 as standard, with the option of RAL 7032

- The outside temperature (Te) must be 5°C lower than the desired temperature (Ts) inside the enclosure
- The filters that equip the fans must be cleaned and replaced regularly
- The surrounding environment must be relatively clean and overfrequent filter replacement should be avoided
- Bear in mind the pressure losses caused by the outlet element (grille with filter, ventilation louvre or simple opening) when determining the fan flow rate
- Storage Temperature: -40...+ 70°C

IP54

The cut-out template supplied with the device avoids the need for marking and protects the surface of the enclosure during handling

The device can be equipped with a filter that provides even more efficient protection for your sensitive facilities against dust particles

### References

NSYCVF38M230PF*	-	-	-	-
NSYCVF38M115PF*	-	-	-	-
NSYCVF38M24DPF	-	-	-	-
NSYCVF38M48DPF	-	-	-	-
-	NSYCVF85M230PF	-	-	-
-	NSYCVF85M115PF	-	-	-
-	NSYCVF85M24DPF	-	-	-
-	NSYCVF85M48DPF	-	-	-
-	-	NSYCVF165M230PF	-	-
-	-	NSYCVF165M115PF	-	-
-	-	NSYCVF165M24DPF	-	-
-	-	NSYCVF165M48DPF	-	-
-	-	-	NSYCVF300M230PF	-
-	-	-	NSYCVF300M115PF	-
-	-	-	NSYCVF300M24DPF	-
-	-	-	NSYCVF300M48DPF	-
-	-	-	-	NSYCVF560M230PF
-	-	-	-	NSYCVF560M115PF
-	-	-	-	NSYCVF850M230PF
-	-	-	-	NSYCVF850M115PF
-	-	-	-	NSYCVF850M400PF

\* Warning: the fan NSYCVF38M230PF & NSYCVF38M115PF MUST NOT be connected to a power conversion module, an inverter or UPS type of power supply!

### Flow curves

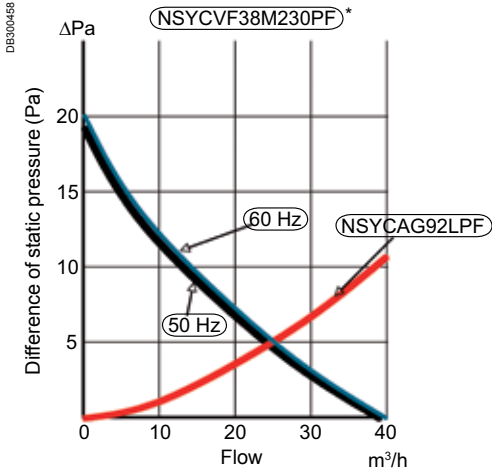

\* Warning: the fan NSYCVF38M230PF MUST NOT be connected to a power conversion module, an inverter or UPS type of power supply!

### Fan 38 m³/h

### Dimensions

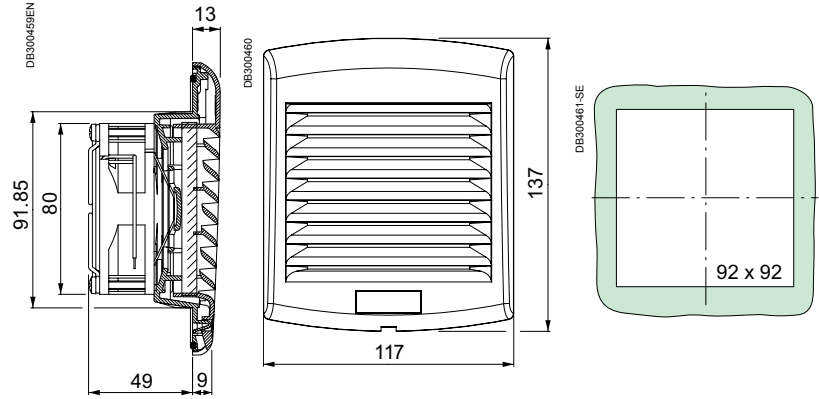

### Flow curves

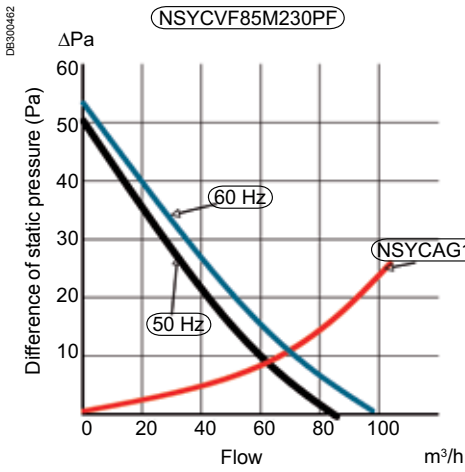

### Fan 85 m³/h

### Dimensions

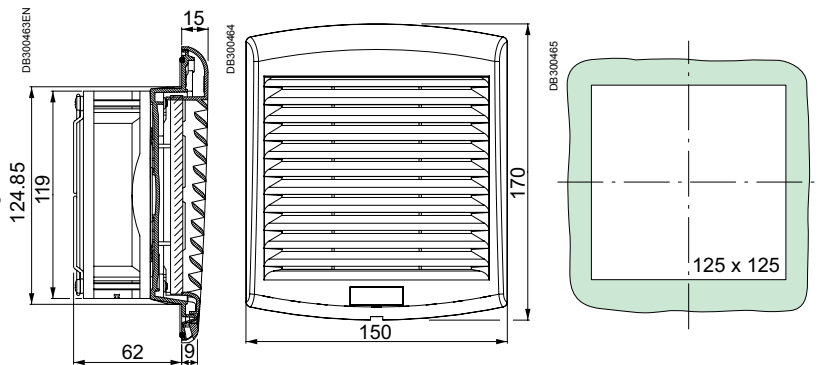

### Flow curves

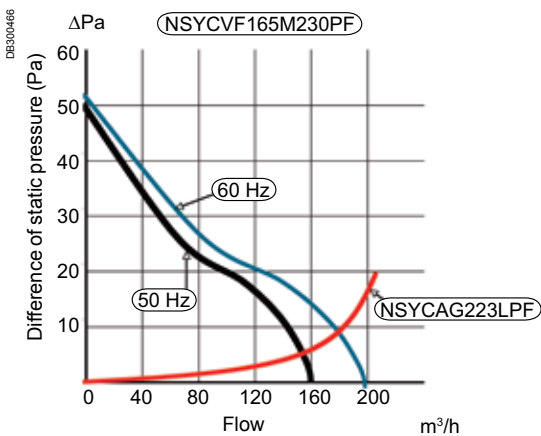

### Fan 165 m³/h

### Dimensions

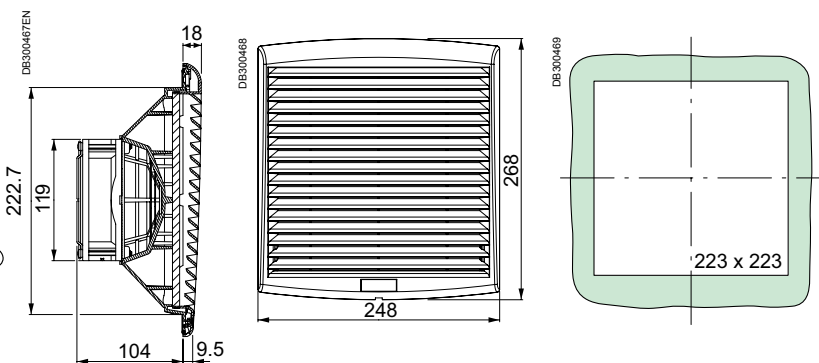

### Flow curves

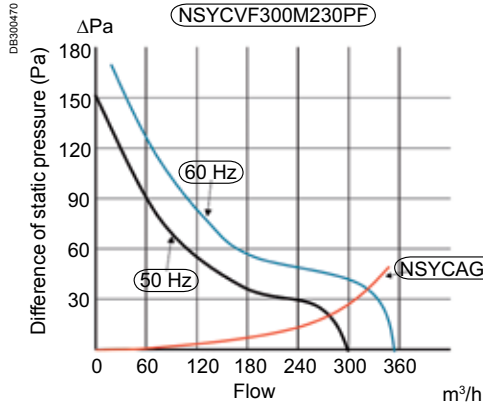

### Fan 300 m³/h

### Dimensions

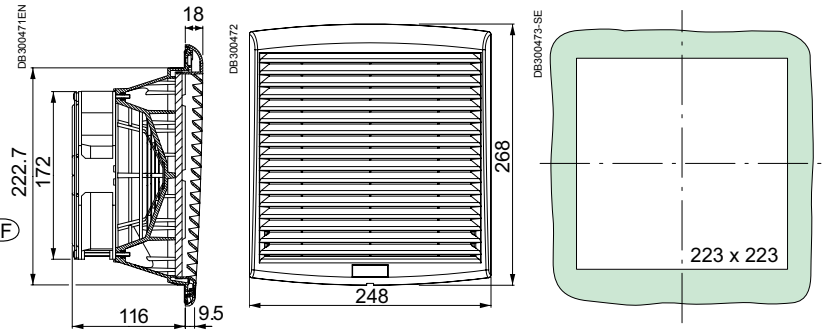

### Flow curves

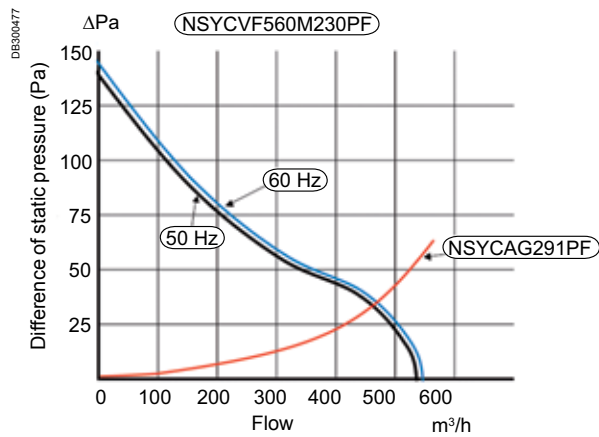

### Fan 560-850 m³/h

### Dimensions

A	B	References
225	160.5	NSYCVF560M230PF NSYCVF560M115PF
280	162	NSYCVF850M230PF NSYCVF850M115PF

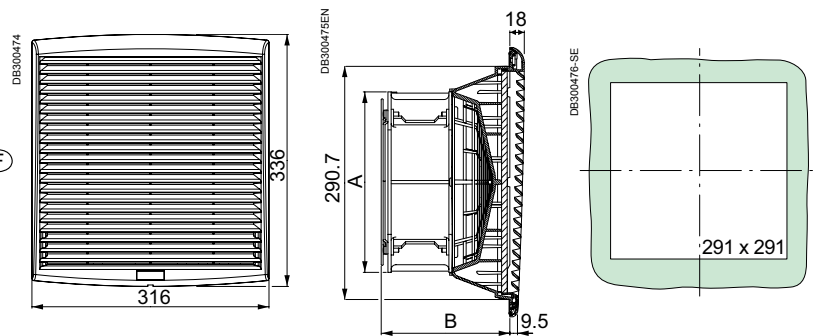
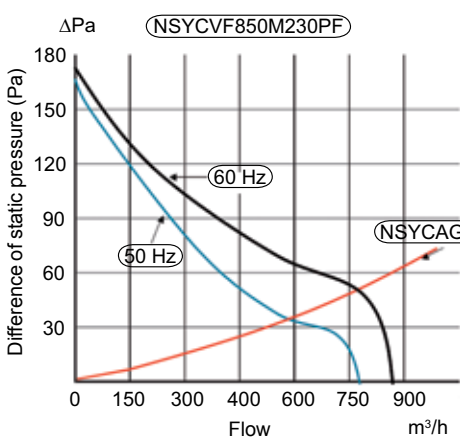

### Ventilation Systems



RAL 7035



RAL 7032

Characteristics				IP54 outlet grilles	
				Delivered with G2 M1 synthetic standard filter.	External part of the grille (for fan or outlet grille) for changing the colour to RAL 7032.
Material				Injected thermoplastic (ASA PC), self-extinguishing according to UL 94	Injected thermoplastic (ASA PC), self-extinguishing according to UL 94
Colour				RAL 7035	RAL 7032
Ingress protection rating				IP54	IP54
Height (mm)	Width (mm)	Depth (mm)	Cut-out (mm)	References	
137	117	13	92 x 92	NSYCAG92LPP	NSYCAG92LPC
170	150	15	125 x 125	NSYCAG125LPP	NSYCAG125LPC
268	248	18	223 x 223	NSYCAG223LPP	NSYCAG223LPC
336	316	18	291 x 291	NSYCAG291LPP	NSYCAG291LPC

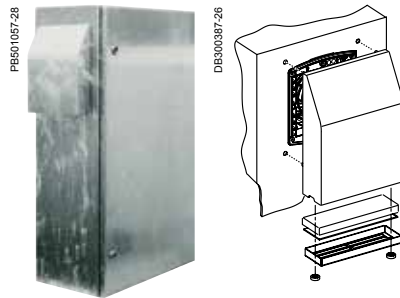

Characteristics				Covers IP55	Spare filter for cover	Fan	Grille	
				This solution protects the fan or the grille from any direct sprays. The cover is the preferred solution to guarantee the following: <ul style="list-style-type: none"> <li>□ an efficient air flow for cooling,</li> <li>□ IP55 rating.</li> </ul>	-	-	-	
Material				2 materials available: <ul style="list-style-type: none"> <li>□ sheet-steel painted with epoxy-polyester resin (RAL 7035) for outdoor applications</li> <li>□ stainless-steel 304L for food and beverage applications</li> </ul>	-	-	-	
Ingress protection rating				IP55	-	-	-	
Mechanical protection rating				IK10	-	-	-	
Certifications				UL508A	-	-	-	
Installation				Double insulation maintained if installed in an insulated enclosure. The cover is placed over the fan or the grille with a filter located at the bottom of the cover to prevent the entry of particles. Easy access to the filter: only two screws needed. When mounting: remove the external part of the fan or the grille as well as the filter.	-	-	-	
Supply				It is necessary to order 1 fan + 1 grille + 2 covers to have a complete system	-	-	-	
Flow rate (m³/h)* with cover		Dimensions (mm)		References				
Free	With 1 outlet grille	External	Cut-out	Sheet-steel painted for outdoor applications RAL 7035	Stainless-steel 304	Emb. mineur 5 p	RAL 7035	RAL 7035
74	53	240 x 180 x 60	125 x 125	NSYCAP125LZF	NSYCAP125LXF	NSYCAF125L55	NSYCVF85M230PF	NSYCAG125LPP
110	82	350 x 305 x 80	223 x 223	NSYCAP223LZF	NSYCAP223LXF	NSYCAF223L55	NSYCVF165M230PF	NSYCAG223LPP
165	123	350 x 305 x 80	223 x 223	NSYCAP223LZF	NSYCAP223LXF	NSYCAF223L55	NSYCVF300M230PF	NSYCAG223LPP
316	265	430 x 373 x 105	291 x 291	NSYCAP291LZF	NSYCAP291LXF	NSYCAF291L55	NSYCVF560M230PF	NSYCAG291LPP
502	430	430 x 373 x 105	291 x 291	NSYCAP291LZF	NSYCAP291LXF	NSYCAF291L55	NSYCVF850M230PF	NSYCAG291LPP

\* The impact on the flow rates of the fans supplied with the other voltages is similar to those provided by the 230 V fans.



Filters							
G2 M1 synthetic standard filters		Filters for greasy environments G2 M1		G3 M1 synthetic fine filters		Stainless-steel anti-insect filters	
For fans and grilles.							
-							
-							
-							
Pack.	References	Pack.	References	Pack.	References	Pack.	References
5	NSYCAF92	-	-	-	-	1	NSYCAF92M
5	NSYCAF125	5	NSYCAF125O	5	NSYCAF125T	1	NSYCAF125M
5	NSYCAF223	5	NSYCAF223O	5	NSYCAF223T	1	NSYCAF223M
5	NSYCAF291	5	NSYCAF291O	5	NSYCAF291T	1	NSYCAF291M

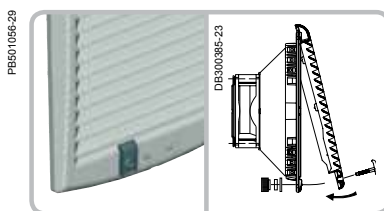

Characteristics	Anti-vandalism kit
	Prevents the grille from being opened from the outside. The unlocking thumbwheel is accessed from the inside of the wall-mounting enclosure.
Colour	RAL 7011 (same material as the grille: ASA PC)
Minor packaging	Reference
2	NSYCAAPV

## HD Ventilation Systems



Characteristics	Fanbox	Filter	Roof filter for fanbox	IP55 HD Metal Grille	Anti-vandalism kit for HD metal grille
See page	315	315	315	315	315
	<b>Voltage</b>	<b>Reference</b>	<b>Reference</b>	<b>Reference</b>	<b>Reference</b>
	24 V DC	NSYCVF550M24FB	NSYCAF223T	NSYCAF190	NSYCAAPVHD
	115 V AC	NSYCVF550M115FB		NSYCAAG223LFHD	
	230 V AC	NSYCVF550M230FB			

### EMC ventilation Systems



Characteristics				EMC IP54 fan
Ingress protection rating				IP54
References				To effectively protect the equipment against electromagnetic disruptions, the EMC fan is equipped with: <ul style="list-style-type: none"> <li>□ a steel frame covering the plastic elements (self-extinguishing ABS according to standard UL 94 Fire resistance V0),</li> <li>□ a metal grille attached to the frame,</li> <li>□ a beryllium gasket guaranteeing conductivity between the perimeter of the fan unit and the enclosure.</li> </ul>
<b>External dimensions (mm)</b>	<b>Cut-out (mm)</b>	<b>Flow rate (m³/h)</b>	<b>Voltage (V)</b>	
150 x 150 x 36	125 x 125	56	230	<b>NSY17990</b>
250 x 250 x 36	223 x 223	130	230	<b>NSY17991</b>
325 x 325 x 36	291 x 291	460	230	<b>NSY17992</b>

--	--	--

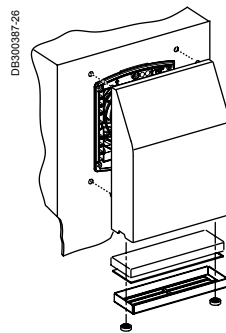

Characteristics				EMC IP55 cover
Colour				RAL 7035 grey
Ingress protection rating				IP55
Mechanical protection rating				IK10
Certifications				Absorption curve according to standard IEEE 299 1997 (UNE 50147-1)
<b>Flow rate (m³/h)* with cover</b>		<b>Dimensions (mm)</b>		<b>References</b>
<b>Free</b>	<b>With 1 outlet grille</b>	<b>External</b>	<b>Cut-out</b>	<b>Sheet-steel painted for outdoor applications RAL 7035</b>
74	53	240 x 180 x 60	125 x 125	<b>NSYCAP125LE</b>
110	82	350 x 305 x 80	223 x 223	<b>NSYCAP223LE</b>
165	123	350 x 305 x 80	223 x 223	<b>NSYCAP223LE</b>
316	265	430 x 373 x 105	291 x 291	<b>NSYCAP291LE</b>
502	430	430 x 373 x 105	291 x 291	<b>NSYCAP291LE</b>

\* The impact on the flow rates of the fans with different voltages is similar to the impact of the 230 V fans.



### EMC IP54 outlet grille

Grille equipped with:

- a steel frame covering the plastic elements (self-extinguishing ABS according to standard UL 94 Fire resistance V0),
- a metal grille attached to the frame,
- a beryllium gasket guaranteeing conductivity between the perimeter of the grille and the enclosure.

IP54

NSY17996

NSY17997

NSY17998

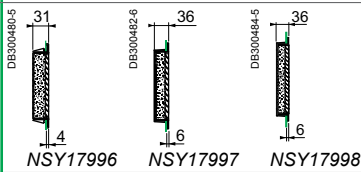

### Dimensions of IP54 and EMC covers

Spare filter for cover	Fan	Grille
Minor pack. 5 p	RAL 7035	RAL 7035
NSYCAF125L55	NSYCVF85M230PF	NSYCAG125LPF
NSYCAF223L55	NSYCVF165M230PF	NSYCAG223LPF
NSYCAF223L55	NSYCVF300M230PF	NSYCAG223LPF
NSYCAF291L55	NSYCVF560M230PF	NSYCAG291LPF
NSYCAF291L55	NSYCVF850M230PF	NSYCAG291LPF

Dimensions (mm)								Cover references		
A	B	C	D	E	F	G	No. of fixing points	IP55		EMC
180	240	49	60	125	157	182	4	NSYCAP125LZF	NSYCAP125LXF	NSYCAP125LE
305	350	61	80	223	283	280	8	NSYCAP223LZF	NSYCAP223LXF	NSYCAP223LE
373	430	73	105	291	351	348	8	NSYCAP291LZF	NSYCAP291LXF	NSYCAP291LE

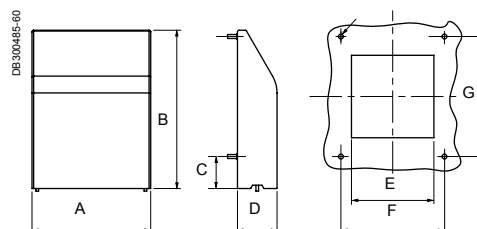

### Fans by components



#### Fans

Free flow without filter or grille: 170 m<sup>3</sup>/h.  
Two models according to the input voltage: 230 and 115 V, 50-60 Hz.

- **Ingress protection rating:** IP20.
- **Options:** IP20 outlet grille (ABS, black) and filter (black polyurethane foam).

Voltage (V)	Flow rate (m <sup>3</sup> /h)	References
115	65	NSYCVF65M115PF
230	65	NSYCVF65M230PF

Accessories		
Dimensions (mm)	Description	References
124 x 124 x 11 mm	Outlet grille	NSYACAG108LP
-	Filter	NSYCAF108

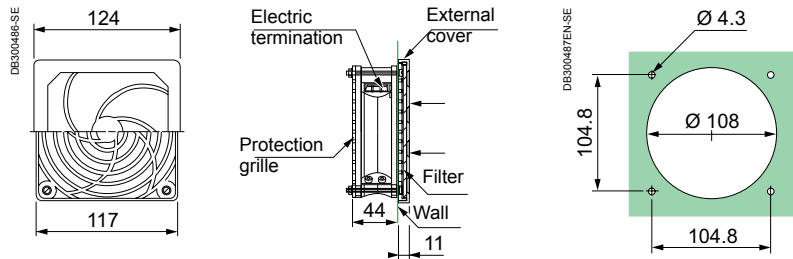

#### Ventilation kit

- **Ingress protection rating:** IP33.
- **Mechanical protection rating:** IK10.
- **Overall flow rate:** 54 m<sup>3</sup>/h.
- **Supply:**
  - one 120 x 120 x 38 mm fan, 230 V - 50/60 Hz, free flow rate 170 m<sup>3</sup>/h, IP33/IK10,
  - two 120 x 120 mm metal louvers, RAL 7035,
  - two 115 x 98 mm anti-insect grilles, stainless-steel 304L wire Ø 0.32 mm braided, 1.07-mm meshes,
  - a power cord,
  - the mountings required for installation.

Voltage (V)	Flow rate (m <sup>3</sup> /h)	Reference
230	54	NSYCVF54M230MM2

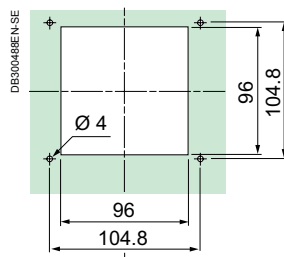

#### Top hood with fan

Fan with hood, for floor-standing enclosures. A flow rate of 350 m<sup>3</sup>/h is obtained with an outlet grille ref. **NSYACAG291LPF**, (cut-out 291 x 291 mm).

- **Ingress protection rating:** IP54
- **Installation:** installation and removal from the outside.
- **Electric power:** 85 W.
- **Noise level:** 64 dB (A).
- **Supply:** delivered with mountings and connection terminal block.

Voltage (V)	Flow rate* (m <sup>3</sup> /h)	Weight (kg)	References
115	570	5.8	NSYCVF570M115MF
230	575	5.8	NSYCVF575M230MF

\* Flow rate measured without counter-pressure.



### Fans by components



Characteristics					Fan motor	Outlet grille	Rear protective grille
					Turbine-type fan motor for ventilation/extraction.	Outlet filter kit for enclosure ventilation. For coupling to fans <b>NSYCVF156M●●●</b> and <b>NSYCVF35M●●●</b> .	Protective grille for enclosure fan motor. For coupling to fans <b>NSYCVF156M●●●</b> and <b>NSYCVF35M●●●</b> .
Flow rate (m³/h)	Voltage (V)	Absorbed power (W)	Noise level (dB)	External dimensions (mm)	References		
156	230/50-60	17/15	42	120 x 120 x 38	<b>NSYCVF156M230</b>	<b>NSYCAG114LPF</b>	<b>NSYCVA114M</b>
	120/50-60	17/15	42	120 x 120 x 38	<b>NSYCVF156M115</b>	<b>NSYCAG114LPF</b>	<b>NSYCVA114M</b>
35	230/50-60	16/14	32	80 x 80 x 25	<b>NSYCVF35M230</b>	<b>NSYCAG78LPF</b>	<b>NSYCVA78M</b>
	120/50-60	16/14	32	80 x 80 x 25	<b>NSYCVF35M115</b>	<b>NSYCAG78LPF</b>	-

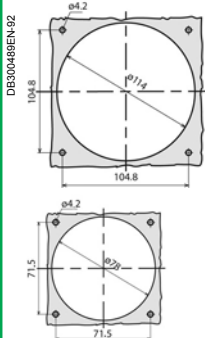

### Fan connection cable

For coupling to the connection terminal of the fan motors.

#### Reference

**NSYCVAC100**

### Circulating for internal forced convection



PBE01067-63

#### Characteristics

#### Circulation fan

User protection according to DIN 31001.

Dimensions:

- Fan: 119 x 119 x 38 mm.
- Collar: length: 140 mm; mounting centre-to-centre distance: 130 mm.
- Installation on ball-bearing.

Supply

Flow rate (m <sup>3</sup> /h)	Voltage (V)	No.	Weight (kg)	P (W)	I (mA)	dB (A)	Depth (mm)
170 (1)	115	-	0.82	17	-	41	-
	230	-	0.82	17	-	41	-
300 (2)	230 (50-60 Hz)	-	-	37	-	-	-
486 (2)	230	3	3.3	45	300	43	208
972 (2)	230	6	5.5	90	600	44	330
1458 (2)	230	9	7.8	135	900	45	452
552 (2)	48 (3)	3	3.3	21.3	330	43	208

-

#### References

NSYCVF170M115

NSYCVF170M230

(1) Free flow.

(2) Flow rate measured without counter-pressure.

(3) Direct current.

### Circulating

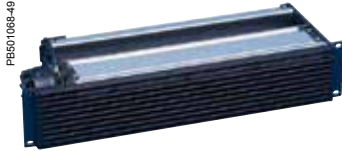

Tangential fan, 19" 2 U	Circulation fan, 19" 1 U
Air is sucked in from the front, filtered and forced vertically through the equipment.	Increases the speed of upward air circulation, in particular between trays with cards. Frontal operation LED. It is advisable to install slides, ref. <b>NSYGB140</b> to guarantee optimal support of the fan.
Delivered without connection cord	Delivered without connection cord
-	-
-	-
<b>NSYAVG2U300</b>	-
-	<b>NSYAVD1U480</b>
-	<b>NSYAVD1U970</b>
-	<b>NSYAVD1U1450</b>
-	<b>NSYAVD1U550M48</b>

### Natural airing



Characteristics												Metal louvre plate, rectangular	
Material												Steel	
Finish												Painted with epoxy-polyester resin, textured RAL 7035 grey	
Ingress protection rating												IP20	
Installation												On the sides of the enclosure. Mounting by screws	
Supply												1 metal louvre and mounting elements	
Dimensions (mm)	A (mm)	B (mm)	C (mm)	D (mm)	E (mm)	F (mm)	G (mm)	H (mm)	R (mm)	Slot width (mm)	No. of slots	References	
-	144	62	36	110	-	-	110	46	10	-	-	NSYCAG110X46M	
-	208	90	72	94	190	-	180	62	18	-	-	NSYCAG180X62M	
-	244	90	72	130	226	-	216	62	18	-	-	NSYCAG216X62M	
-	345	118	100	231	327	115.5	317	90.5	30	-	-	NSYCAG317X91M	
-	345	148	130	231	327	115.5	317	120	30	-	-	NSYCAG317X120M	
-	445	148	130	267	427	148.5	417	120	30	-	-	NSYCAG417X120M	
120 x 120	95	104	104.8	-	-	-	-	-	90	-	5	-	
160 x 160	110	130	140	-	-	-	-	-	-	100	5	-	
220 x 220	190	170	200	-	-	-	-	-	-	180	5	-	

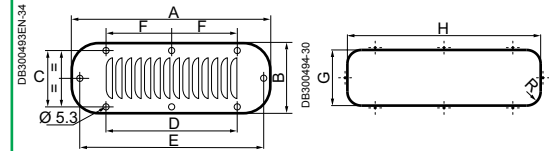

### Roof accessories for natural airing



Characteristics		Roof elevators	Hood for natural airing
		Allow the roof to be raised, providing natural airing.	Natural airing device for coupling to the top of metal floor-standing enclosures. Solution for combining with the ventilation slots.
Material		Zinc-coated steel	Steel
Finish		-	Painted with epoxy-polyester resin, textured RAL 7035 grey
Ingress protection rating		-	IP54
Installation		They are screwed onto the structure, at the roof mounting point	Mounting to the top by means of caged nuts and special screws
Supply		4 elevators	1 hood for natural airing and mounting elements
Top elevation (mm) (H)	Weight (kg)	References	
26	-	NSYRE26	
60	-	NSYRE60	
-	4.6	-	
		NSYCAC228RMF	

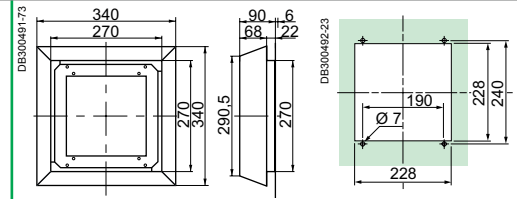
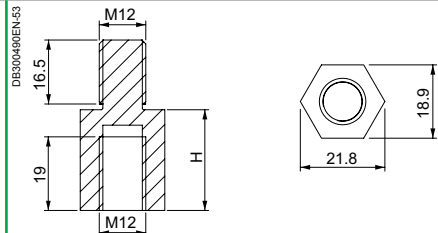

Spare filter
Reference
NSYCAF228R



### Natural airing



Metal louvre plate, square		Anti-insect filters for metal louvre plate, square		
-	-	Stainless-steel 304L Ø 0.32 mm wire mesh, of 1.07 mm, thickness 0.6 mm		
-	-	-		
IP23	-	IP33		
-	-	Between the enclosure and the metal louvre		
One metal louvre	-	One anti-insect filter		
		External dimensions (mm)	Weight (kg/m <sup>2</sup> )	References
-	-	-	-	-
-	-	-	-	-
-	-	-	-	-
-	-	-	-	-
-	-	-	-	-
-	-	-	-	-
-	-	-	-	-
NSYCAG104X95LM	-	98 x 115	0.8	NSYCAF104X95X
NSYCAG130X110LM	-	133 x 158	0.8	NSYCAF130X110X
NSYCAG170X190LM	-	197 x 215	0.8	NSYCAF170X190X

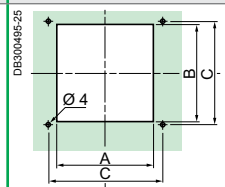

### Other accessories for natural airing



Characteristics				Plastic ventilation louvres					Sealed anti-condensation valve
				Four models available according to IP rating, in vertical position.					Controls the pressure to avoid condensation following an internal temperature increase.
Material				-					PA6-V2, acrylic co-polymer membrane, water and oil repellent
Ingress protection rating				IP22	IP30/44 (1)	IP45	IP44	IP45	IP68
Temperature of use				-					-40... +105°C
Supply				References by unit. Order by multiples of 2 units (2, 4, 6, etc.)					-
Cut-out Ø (mm)	Permeability (1)	Pressure difference (2)	Minor pack.	References					
45.5	-	-	-	NSYCAG45LP	-	-	-	-	-
35	-	-	-	-	NSYCAG35LP	-	-	-	-
38	-	-	-	-	-	NSYCAG38LP	-	-	-
33	-	-	-	-	-	-	NSYCAG33LP	-	-
19	-	-	-	-	-	-	-	NSYCAG19LP	-
M12	16 litres/h	ΔP < 1 bar	10	-	-	-	-	-	NSYCAG12LPH1
	120 litres/h	ΔP < 0.1 bar	10	-	-	-	-	-	NSYCAG12LPH2

### Ventilation systems with filters

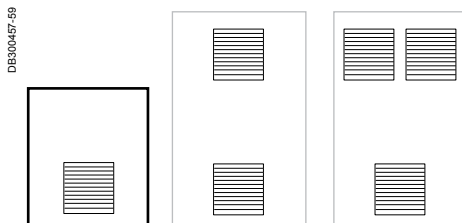

	Fan flow rate (m³/h)			Voltage	Type of connection C = by cable F = by faston (1) B = by terminal block
	Free with filter	With 1 fan + 1 outlet grille	With 1 fan + 2 outlet grille		
	50 Hz	50 Hz	50 Hz		
PB50105C-27 	38	25	33	230 V	C
	38	27	35	115 V	C
	58	39	47	24 V DC	C
	44	34	41	48 V DC	C
PB301051-34 	85	63	71	230 V	F
	79	65	73	115 V	F
	80	57	77	24 V DC	F
	79	59	68	48 V DC	F
PB501052-23 	165	153	161	230 V	F
	164	153	161	115 V	F
	188	171	179	24 V DC	F
	193	171	179	48 V DC	F
	302	260	268	230 V	F
	302	263	271	115 V	F
	262	221	229	24 V DC	F
	247	210	218	48 V DC	F
PB501053-30 	562	473	481	230 V	B
	582	485	494	115 V	B
	838	718	728	230 V	B
	983	843	854	115 V	B
	931	798	809	400/440 V	B

(1) Fan models with connection type (F) are delivered with the connection cord included (2 metres).

Dimensions (mm)		References						
Total (external)	Cut-out	Fan with filter	Outlet grille	RAL 7032 replacement grille	Sealing cover IP55		EMC cover IP55	
		RAL 7035	RAL 7035	RAL 7032	Sheet-steel painted with epoxy-polyester resin	Stainless-steel 304L		
137 x 117	92 x 92	NSYCVF38M230PF*	NSYCAG92LPF	NSYCAG92LPC	-	-	-	
		NSYCVF38M115PF*						
		NSYCVF38M24DPF						
		NSYCVF38M48DPF						
170 x 150	125 x 125	NSYCVF85M230PF	NSYCAG125LPF	NSYCAG125LPC	NSYCAP125LZF	NSYCAP125LXF	NSYCAP125LE	
		NSYCVF85M115PF						
		NSYCVF85M24DPF						
		NSYCVF85M48DPF						
268 x 248	223 x 223	NSYCVF165M230PF	NSYCAG223LPF	NSYCAG223LPC	NSYCAP223LZF	NSYCAP223LXF	NSYCAP223LE	
		NSYCVF165M115PF						
		NSYCVF165M24DPF						
		NSYCVF165M48DPF						
		NSYCVF300M230PF						
		NSYCVF300M115PF						
		NSYCVF300M24DPF						
		NSYCVF300M48DPF						
336 x 316	291 x 291	NSYCVF560M230PF	NSYCAG291LPF	NSYCAG291LPC	NSYCAP291LZF	NSYCAP291LXF	NSYCAP291LE	
		NSYCVF560M115PF						
		NSYCVF850M230PF						
		NSYCVF850M115PF						
		NSYCVF850M400PF						

\* Warning: the fan **NSYCVF38M230PF** & **NSYCVF38M115PF** MUST NOT be connected to a power conversion module, an inverter or UPS type of power supply!

New

> Choose **air-air exchangers** to take advantage of cooler ambient temperatures, such as food and beverage plants, to evacuate large amounts of heat while guaranteeing the independence of the internal and external air circuits.



### A new range of energy efficient exchangers

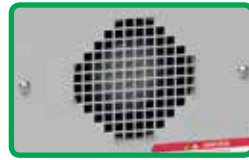

#### Higher efficiency through improved design

With an updated external grill design, and by positioning cooling closer to critical equipment, such as speed drives, ClimaSys now provides **better flow, better cooling, and higher energy efficiency.**



#### Simplicity saves you time

Our free ProClima thermal calculation software **makes specification simple and fast.** A new thermal solutions module integrates calculation for cooling and control devices, helping you maximize the energy efficiency of your systems.



#### Faster installation

A number of design improvements reduce installation time. Mounting requires single cutouts and a minimum of screws. Wiring is accomplished with smart interconnects.



#### Protection

All side-mounted models are IP55 internally according to EN 60529.



New

### Air-air exchangers



Characteristics		Side-mounting models			
		The air-air exchanger is used in highly polluted environments in cases of cooler ambient temperature.			
Material	Painted zinc-coated steel				
Colour	RAL 7035 grey				
Certifications	CE declaration				
Installation	Indoor				
<b>Cooling characteristics</b>					
Specific power	14 W/K	36 W/K	50 W/K	80 W/K	
Air flow of the internal circuit (enclosure)	280 m³/h	570 m³/h	600 m³/h	1050 m³/h	
Air flow of the external circuit (ambient)	280 m³/h	570 m³/h	600 m³/h	1050 m³/h	
Thermostat type	-	Mechanical	Mechanical	Mechanical	
Temperature setting range	-	+5 ... +60°C	+5 ... +60°C	+5 ... +60°C	
Temperature range external circuit (ambient)	-5 ... +55°C	-5 ... +55°C	-5 ... +55°C	-5 ... +55°C	
Type of fluid	Air	Air	Air	Air	
<b>Electric characteristics</b>					
Input voltage	1 x 230 V / 50-60 Hz	1 x 230 V / 50-60 Hz	1 x 230 V / 50-60 Hz	1 x 230 V / 50-60 Hz	
Rated Intensity	0.62 A	0.7 A	0.7 A	1.1 A	
Power consumption absorbed	88 W	160 W	160 W	240 W	
Thermal protection recommended (fuse)	T1 A	T1 A	T1 A	T2 A	
<b>Physical characteristics</b>					
External dimensions (H x W x D)	363 x 188 x 165 mm	771 x 316 x 93 mm	771 x 316 x 93 mm	1260 x 317 x 108 mm	
Protection degree IP internal /external	IP55 / IP22	IP55 / IP22	IP55 / IP22	IP55 / IP22	
Noise level	60 dB	62 dB	62 dB	64 dB	
Weight of unit	7 kg	10 kg	10 kg	17 kg	
<b>References</b>					
	NSYCEA14E	NSYCEA36	NSYCEA50	NSYCEA80	

New

### Air-air exchangers

#### Side-mounting models

##### NSYCEA14E

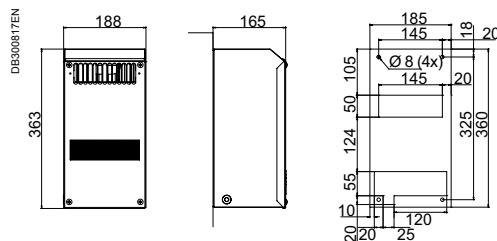

##### NSYCEA36 / NSYCEA50

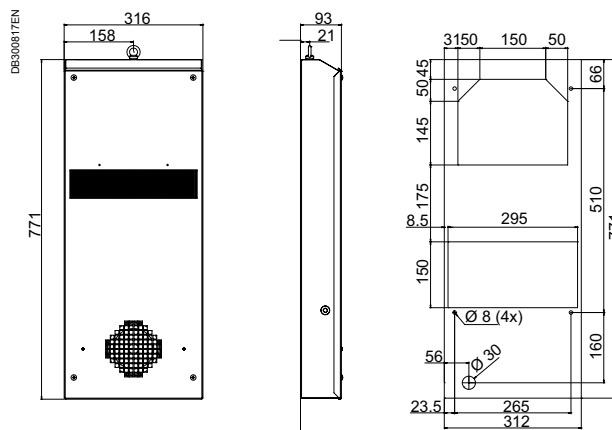

##### NSYCEA80

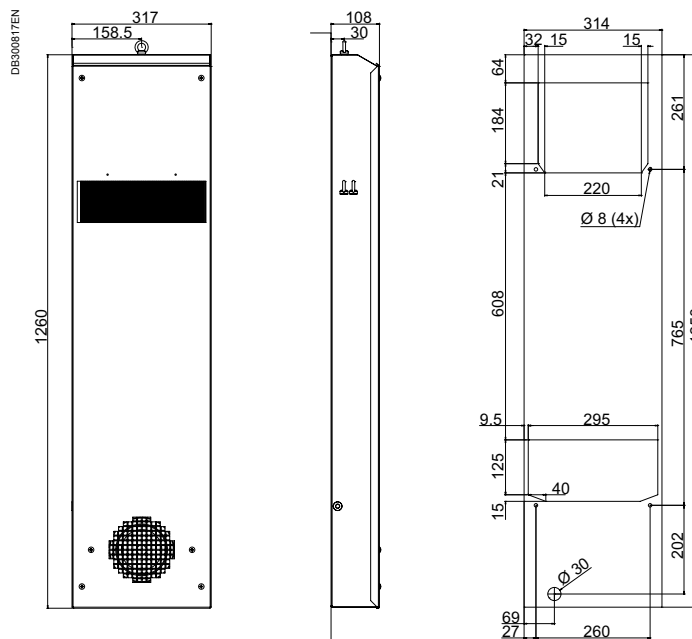

Units of measurement are mm.

**New**

> Choose **air-water exchangers** for especially difficult environments where there is no external air circuit available but a stable cold-water circuit can be supplied.



### Exchangers that tackle highly polluted environments

PB502606-30



#### Many mounting options give you the right fit

Air-water exchangers offer roof and side mounting options.



#### Extended ratings to meet any challenge

Provide options for up to 15 kW of cooling power, among the world's highest power ratings for air-water exchangers.

PB502655-32



#### New material options adapt to any application

Air-water exchangers can be provided in the same material as electrical enclosures for (for example stainless steel) a homogeneous appearance and thermal performance.

DE123116-26



#### New certifications and declarations

- UL,
- CE.

PB502607-13



#### Protection

All side-mounting models are IP55 type protected internally and externally according EN 60529. Top-mounting models are IP54.

New

### Air-water exchangers



Characteristics	Side-mounting models					
	Available in two installation versions: Top-mounting model and side-mounting model. Main components: thermostat adjustment system, Exchange cassette, fans for internal circuits of the enclosure, protection device against possible leaks. Eyebolts included in all models.					
Material	RAL 7035 grey painted zinc-coated steel or stainless steel					
Certifications	<ul style="list-style-type: none"> <li>■ CE declaration</li> <li>■ UL (only references ending with UL)</li> </ul>					
Installation	Indoor					
<b>Cooling characteristics</b>						
Cooling power W10A35	1000 W	1750 W	2500 W	3500 W	4500 W	
Hydraulic circuit maximum pressure	5 bar	5 bar	5 bar	5 bar	5 bar	
Air flow of the external circuit (ambient)	330 m³/h	570 m³/h	860 m³/h	1050 m³/h	1450 m³/h	
Thermostat type	Mechanical	Mechanical	Mechanical	Mechanical	Mechanical	
Temperature setting range	+20 ... +46°C	+20 ... +46°C	+20 ... +46°C	+20 ... +46°C	+20 ... +46°C	
Temperature range external circuit (ambient)	+1 ... +70°C	+1 ... +70°C	+1 ... +70°C	+1 ... +70°C	+1 ... +70°C	
Type of fluid	Filtered water or glycolised water	Filtered water or glycolised water	Filtered water or glycolised water	Filtered water or glycolised water	Filtered water or glycolised water	
Water flow	150 l/h	150 l/h	500 l/h	500 l/h	500 l/h	
Pressure drop	0.1 bar	0.1 bar	0.3 bar	0.2 bar	0.2 bar	
Hydraulic connection	1/2" G	3/4" G	3/4" G	3/4" G	3/4" G	
<b>Electric characteristics</b>						
Input voltage	1 x 230 V / 50-60 Hz*	1 x 230 V / 50-60 Hz*	1 x 230 V / 50-60 Hz*	1 x 230 V / 50-60 Hz*	1 x 230 V / 50-60 Hz*	
Rated Intensity	0.17 A	0.36 A	0.33 A	0.55 A	0.71 A	
Power consumption absorbed W10A35	29 W	75 W	80 W	130 W	160 W	
Thermal protection recommended (fuse)	T2 A	T2 A	T2 A	T2 A	T2 A	
<b>Physical characteristics</b>						
External dimensions (H x W x D)	450 x 310 x 115 mm	901 x 398 x 137 mm	901 x 398 x 137 mm	1148 x 398 x 163 mm	1148 x 398 x 163 mm	
Protection degree IP internal / external	IP55 / IP55	IP55 / IP55	IP55 / IP55	IP55 / IP55	IP55 / IP55	
Noise level	55 dB (A)	58 dB (A)	58 dB (A)	64 dB (A)	69 dB (A)	
Weight of unit	12 kg	18 kg	19 kg	29 kg	30 kg	
<b>References</b>						
Steel	NSYCEW1K	NSYCEW1K8	NSYCEW2K5	NSYCEW3K5	NSYCEW4K5	
Stainless steel	NSYCEWX1K	NSYCEWX1K8	NSYCEWX2K5	NSYCEWX3K5	NSYCEWX4K5	
Steel UL	NSYCEW1KUL	NSYCEW1K8UL	NSYCEW2K5UL	NSYCEW3K5UL	NSYCEW4K5UL	
Stainless steel UL	NSYCEWX1KUL	NSYCEWX1K8UL	NSYCEWX2K5UL	NSYCEWX3K5UL	NSYCEWX4K5UL	

\* 60 Hz only for UL versions.



**Top-mounting model**

6000 W	6000 W	10000 W	10000 W	15000 W	15000 W	2500 W
5 bar	8 bar	8 bar	8 bar	8 bar	8 bar	5 bar
1450 m³/h	1450 m³/h	2420 m³/h	2420 m³/h	2900 m³/h	2900 m³/h	750 m³/h
Mechanical	Mechanical	Mechanical	Mechanical	Mechanical	Mechanical	Mechanical
+20 ... +46°C	+20 ... +46°C	+20 ... +46°C	+20 ... +46°C	+20 ... +46°C	+20 ... +46°C	+20 ... +46°C
+1 ... +70°C	+1 ... +70°C	+1 ... +70°C	+1 ... +70°C	+1 ... +70°C	+1 ... +70°C	+1 ... +70°C
Filtered water or glycolised water	Filtered water or glycolised water	Filtered water or glycolised water	Filtered water or glycolised water	Filtered water or glycolised water	Filtered water or glycolised water	Filtered water or glycolised water
800 l/h	800 l/h	2000 l/h	2000 l/h	2000 l/h	2000 l/h	500 l/h
0.5 bar	0.5 bar	3.5 bar	3.5 bar	4.8 bar	4.8 bar	0.3 bar
3/4" G	3/4" G	3/4" G	3/4" G	3/4" G	3/4" G	1/2" G
1 x 230 V / 50-60 Hz*	2 x 400-440V / 50-60 Hz	1 x 230 V / 50-60 Hz	2 x 400-440V / 50-60 Hz	1 x 230 V / 50-60 Hz	2 x 400-440V / 50-60 Hz	1 x 230 V / 50-60 Hz
0.71 A	0.4 A	1.2 A	0.75 A	1.4 A	0.9 A	0.30 A
160 W	170 W	260 W	280 W	320 W	420 W	65 W
T2 A	T1 A	T2 A	T2 A	T4 A	T2 A	T2 A
1500 x 450 x 163 mm	1500 x 450 x 163 mm	1932 x 797 x 206 mm	1932 x 797 x 206 mm	1932 x 797 x 206 mm	1932 x 797 x 206 mm	270 x 400 x 542 mm
IP55 / IP55	IP55 / IP55	IP55 / IP55	IP55 / IP55	IP55 / IP55	IP55 / IP55	IP54 / IP55
69 dB (A)	69 dB (A)	70 dB (A)	70 dB (A)	72 dB (A)	70 dB (A)	58 dB (A)
40 kg	42 kg	90 kg	90 kg	92 kg	92 kg	19 kg
<b>NSYCEW6K</b>	<b>NSYCEW6K2P4</b>	<b>NSYCEW10K**</b>	<b>NSYCEW10K2P4**</b>	<b>NSYCEW15K**</b>	<b>NSYCEW15K2P4**</b>	<b>NSYCEW2K5R</b>
<b>NSYCEWX6K</b>	<b>NSYCEWX6K2P4</b>	<b>NSYCEWX10K**</b>	<b>NSYCEWX10K2P4**</b>	<b>NSYCEWX15K**</b>	<b>NSYCEWX15K2P4**</b>	-
<b>NSYCEW6KUL</b>	-	-	-	-	-	-
<b>NSYCEWX6KUL</b>	-	-	-	-	-	-

\* Available from 2016.

New

### Air-water exchangers

#### Side-mounting models

##### NSYCEW••1K••

#### Performance curves

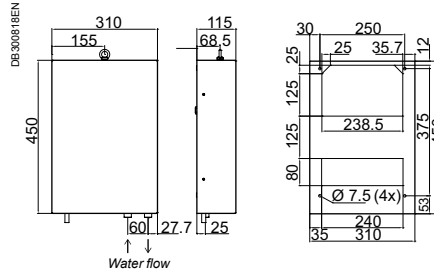
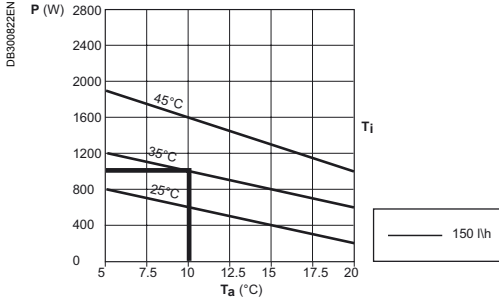

#### Performance curves

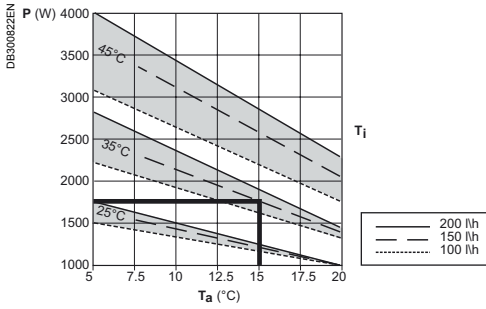

##### NSYCEW••1K8•• – NSYCEW••2K5••

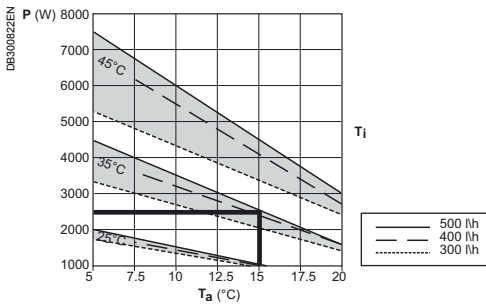
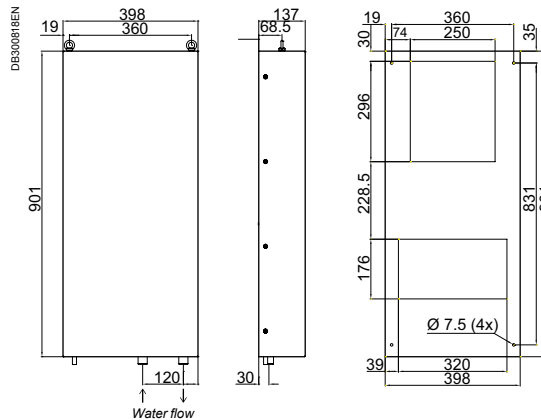

Ta= Inlet water temperature  
Ti= Desired internal temperature of the enclosure

Units of measurement are mm.

New

### Performance curves

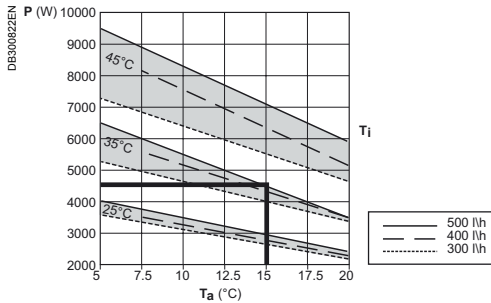
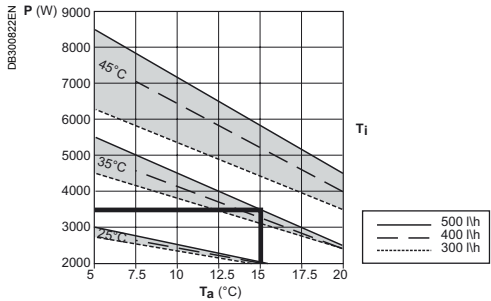

### NSYCEW••3K5•• – NSYCEW••4K5••

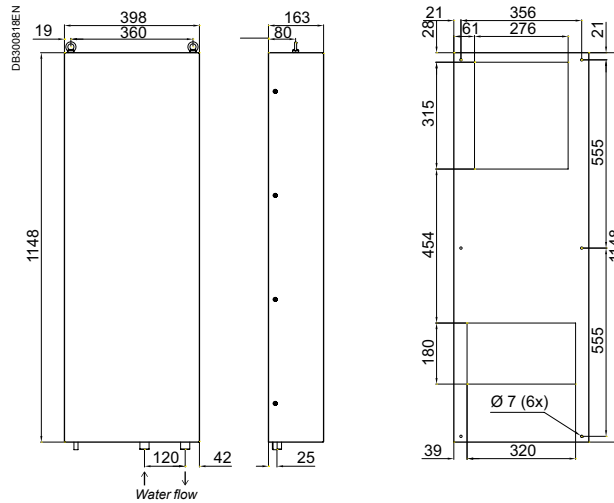

### Performance curves

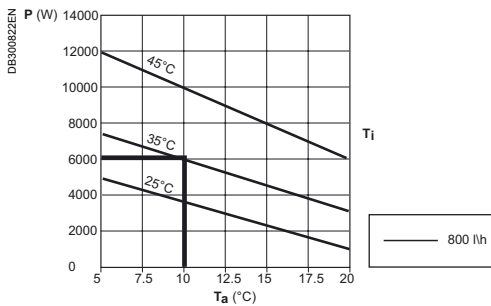

### NSYCEW••6K••

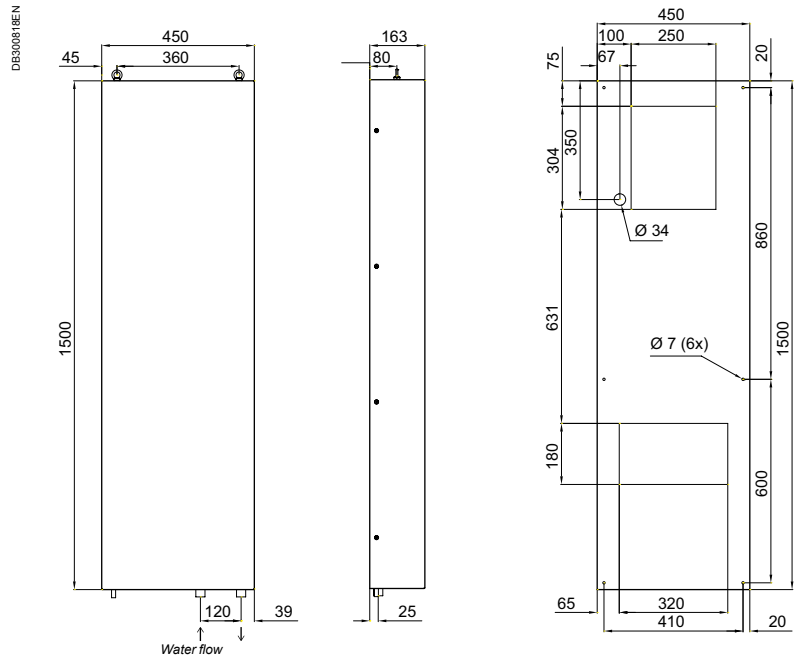

Ta= Inlet water temperature  
Ti= Desired internal temperature of the enclosure

Units of measurement are mm.

New

### NSYCEW••10K•• – NSYCEW••15K••

#### Performance curves

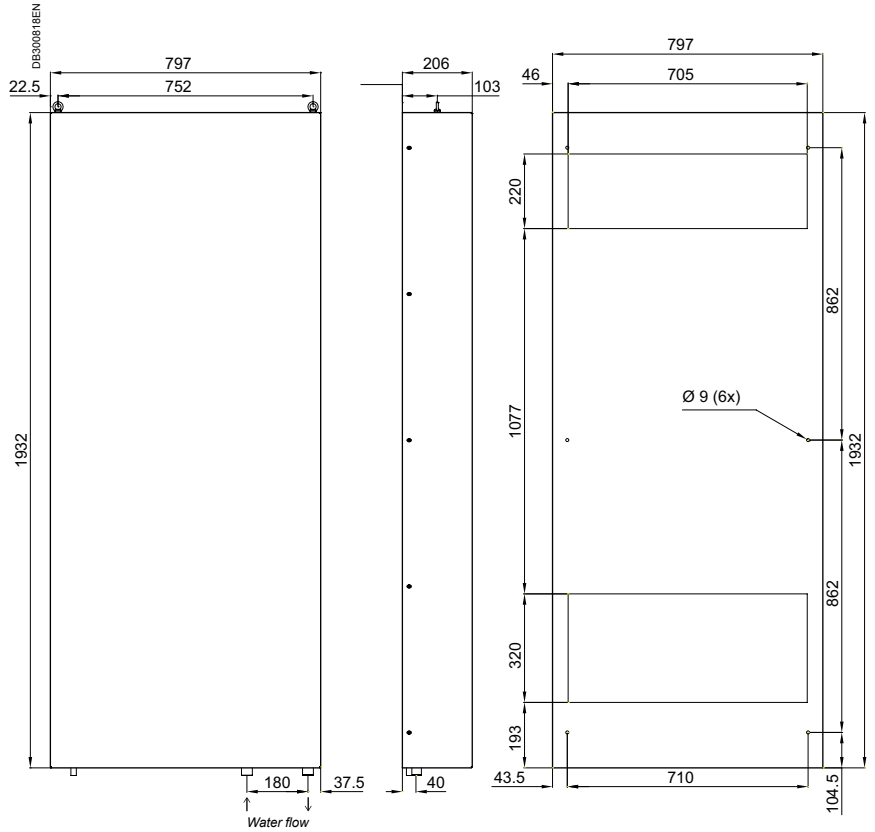
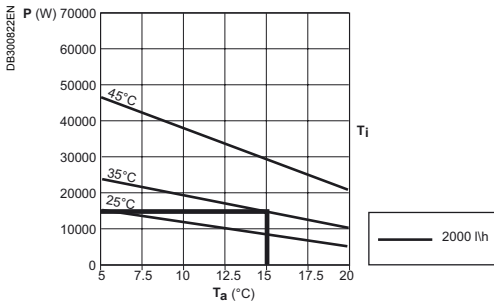
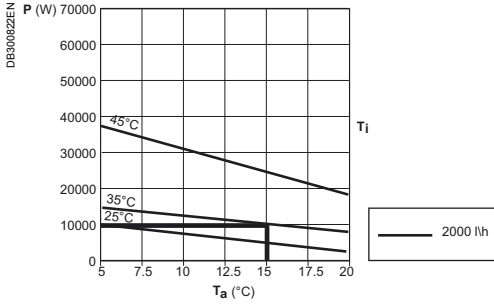

### Top-mounting models

#### NSYCEW2K5R

#### Performance curves

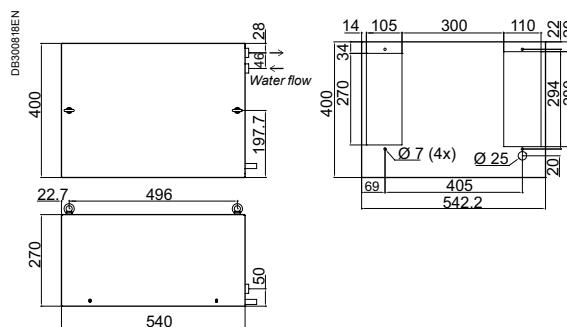
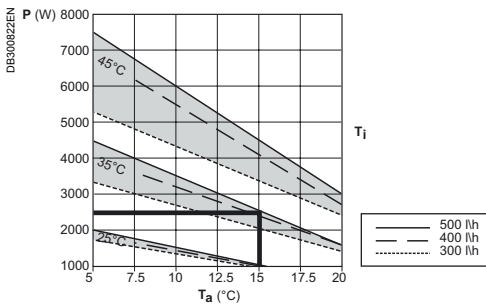

Ta= Inlet water temperature  
Ti= Desired internal temperature of the enclosure

Units of measurement are mm.



New

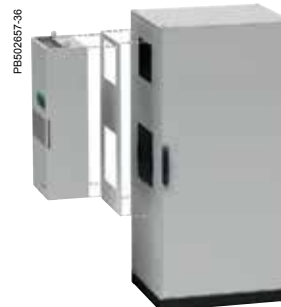

Characteristics	Air-air and air-water exchangers				Retrofit panel	
	CE		UL / CE			
	Steel	Stainless steel	Steel	Stainless steel		
					Panel that enable to mount a new ClimaSys CE or CU units by replacement of old Schneider Electric cooling systems.	
Material					Metal painted	
Colour					RAL 7035	
Supply					1 unit	
References					Retrofit panel	Old Schneider Electric cooling system
<b>Air- air exchangers</b>						
Side-mounting models	NSYCEA14E	-	-	-	NSYCEARTFIT14	NSYCEA15W230VL
	NSYCEA36	-	-	-	NSYCEARTFIT36	NSYCEA35W230VL NSYCEA35W230VLE
	NSYCEA50	-	-	-	-	-
	NSYCEA80	-	-	-	NSYCEARTFIT80	NSYCEA70W230VL
<b>Air-water exchangers</b>						
Side-mounting models	NSYCEW1K	NSYCEWX1K	NSYCEW1KUL	NSYCEWX1KUL	-	-
	NSYCEW1K8	NSYCEWX1K8	NSYCEW1K8UL	NSYCEWX1K8UL	-	-
	NSYCEW2K5	NSYCEWX2K5	NSYCEW2K5UL	NSYCEWX2K5UL	NSYCEWRTFIT2K5	NSYCEW2100W230VL
	NSYCEW3K5	NSYCEWX3K5	NSYCEW3K5UL	NSYCEWX3K5UL	NSYCEWRTFIT3K5	NSYCEW3150W230VL
	NSYCEW4K5	NSYCEWX4K5	NSYCEW4K5UL	NSYCEWX4K5UL	-	-
	NSYCEW6K	NSYCEWX6K	NSYCEW6KUL	NSYCEWX6KUL	-	-
	NSYCEW6K2P4	NSYCEWX6K2P4	NSYCEW10K	NSYCEWX10K	-	-
	NSYCEW10K2P4	NSYCEWX10K2P4	-	-	-	-
	NSYCEW15K	NSYCEWX15K	-	-	-	-
	NSYCEW15K2P4	NSYCEWX15K2P4	-	-	-	-
	Top-mounting model	NSYCEW2K5R	-	-	-	-



New

➤ Choose **cooling units** for harsh environments, where ambient temperatures can reach up to 55°C. The unit's integrated alarm system will signal you in the event of any operational anomaly.



### Cooling units for extremely hot environments



#### Many mounting options give you the right fit

Cooling units range offer roof and side mounting options as well as slim models for efficient and space-saving installation on control panel doors.



#### Extended ratings to meet any challenge

Provide options for up to 15 kW of cooling power.



#### Protection through improved design

A new internal grill design protects components and personnel during operation, while also making ClimaSys products **easier to clean and maintain**.



#### Fast access to settings and status

A new HMI screen enables quick viewing to all configuration parameters and sensor readings within the enclosures (not on outdoor Heavy Duty models).



#### New material options adapt to any application

ClimaSys cooling units offer new outdoor and stainless steel versions, ideal for clean, hygienic environments such as food and beverage plants.



#### Accurate thermal control

To keep motor drives and controls running within safe thermal boundaries, all ClimaSys cooling units offer a precise **electronic thermostat control**. This ensures high cooling precision (+/- 1.5°C).



#### Extended ratings to meet any challenge

ClimaSys CU outdoor Heavy Duty version can withstand extreme environments, with **operating temperature** ratings from -20° to +55°C.



#### New certifications and declarations

- UL,
- CE.



#### Simplicity

No tools needed to replace the filter. It just takes a few seconds.

New

### Cooling units



Characteristics	Side-mounting models			
	Cooling units for electrical control panels. <ul style="list-style-type: none"> <li>■ Respect for the environment by using environmentally friendly gas R134a (HFC).</li> <li>■ Electronic thermostats in all models.</li> <li>■ Alarm signal for door contact included in all models.</li> <li>■ Eyebolts included.</li> <li>■ Among best in class components.</li> <li>■ The external filter, not included as standard, is strongly recommended for harsh environments.</li> <li>■ HMI screen.</li> </ul>			
Material	RAL 7035 grey painted zinc-coated steel or stainless steel			
Certifications	<ul style="list-style-type: none"> <li>■ CE declaration</li> <li>■ UL (only references ending with UL)</li> </ul>			
Installation	Indoor			
<b>Cooling characteristics</b>				
Cooling power L35-L35	300 W (1024 Btu/h)	380 W (1297 Btu/h)	640 W (2184 Btu/h)	820 W (2798 Btu/h)
Cooling power L35-L50	150 W (512 Btu/h)	240 W (819 Btu/h)	470 W (1604 Btu/h)	680 W (2320 Btu/h)
Air flow of the internal circuit (enclosure)	280 m³/h	280 m³/h	330 m³/h	330 m³/h
Air flow of the external circuit (ambient)	280 m³/h	280 m³/h	570 m³/h	570 m³/h
Thermostat type	Electronic	Electronic	Electronic	Electronic
Temperature setting range	+20 ... +46°C	+20 ... +46°C	+20 ... +46°C	+20 ... +46°C
Maximum outside temperature	+55°C	+55°C (+50°C)**	+55°C (+50°C)**	+55°C (+50°C)**
Temperature range external circuit (ambient)	+20 ... +55°C*	+20 ... +55°C* (+20 ... +50°C)**	+20 ... +55°C* (+20 ... +50°C)**	+20 ... +55°C* (+20 ... +50°C)**
Type of cooling gas	R134a	R134a	R134a	R134a
Cooling gas weight	0.13 kg	0.16 kg	0.23 kg	0.23 kg
Maximum pressure cooling circuit	25 bar	26 bar (28 bar)**	25 bar (28 bar)**	25 bar (28 bar)**
External filter	Optional, see page 451	Optional, see page 451	Optional, see page 451	Optional, see page 451
<b>Electric characteristics</b>				
Input voltage	1 x 230 V / 50-60 Hz	1 x 230 V / 50-60 Hz**	1 x 230 V / 50-60 Hz**	1 x 230 V / 50-60 Hz**
Starting / Rated Intensity	4.2 A / 1.5 A	6.0 A / 1.6 A	8.1 A / 2.1 A	10.8 A / 2.6 A
Power consumption absorbed L35-L35	270 W	280 W	400 W	440 W
Power consumption absorbed L35-L50	310 W	330 W	470 W	490 W
Energy efficiency ratio (EER) L35-L35	1.1	1.4	1.6	1.9
Thermal protection recommended (fuse)	T4 A	T4 A	T6 A	T6 A
<b>Physical characteristics</b>				
External dimensions (H x W x D)	340 x 525 x 135 mm	460 x 285 x 180 mm	606 x 316 x 212 mm	783 x 348 x 215 mm
Protection degree IP internal /external	IP55 / IP34	IP55 / IP34	IP55 / IP34	IP55 / IP34
Noise level	61 dB	60 dB	65 dB	65 dB
Weight of unit	17 kg	17 kg	21 kg	27 kg
<b>References</b>				
Steel	<b>NSYCU300H</b>	<b>NSYCU400</b>	<b>NSYCU600</b>	<b>NSYCU800</b>
Stainless steel	-	<b>NSYCUX400</b>	<b>NSYCUX600</b>	<b>NSYCUX800</b>
Steel UL	-	<b>NSYCU400UL</b>	<b>NSYCU600UL</b>	<b>NSYCU800UL</b>
Stainless steel UL	-	-	<b>NSYCUX600UL</b>	<b>NSYCUX800UL</b>

\* 50°C at 60 Hz.

\*\* Certification UL only 60 Hz.

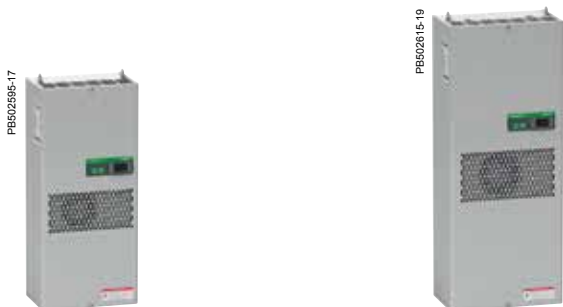

	1000 W (3412 Btu/h)	1000 W (3412 Btu/h)	1250 W (4265 Btu/h)	1250 W (4265 Btu/h)	1600 W (5459 Btu/h)	1600 W (5459 Btu/h)	2000 W (6824 Btu/h)
	790 W (2696 Btu/h)	790 W (2696 Btu/h)	910 W (3105 Btu/h)	910 W (3105 Btu/h)	1230 W (4197 Btu/h)	1230 W (4197 Btu/h)	1510 W (5152 Btu/h)
	330 m³/h	330 m³/h	570 m³/h	570 m³/h	570 m³/h	570 m³/h	860 m³/h
	570 m³/h	570 m³/h	860 m³/h	860 m³/h	1050 m³/h	1050 m³/h	1050 m³/h
	Electronic	Electronic	Electronic	Electronic	Electronic	Electronic	Electronic
	+20 ... +46°C	+20 ... +46°C	+20 ... +46°C	+20 ... +46°C	+20 ... +46°C	+20 ... +46°C	+20 ... +46°C
	+55°C (+50°C)**	+55°C (+50°C)**	+55°C (+50°C)**	+55°C	+55°C (+50°C)**	+55°C (+50°C)**	+55°C (+50°C)**
	+20 ... +55°C* (+20 ... +50°C)**	+20 ... +50°C (+20 ... +50°C)**	+20 ... +55°C* (+20 ... +50°C)**	+20 ... +50°C	+20 ... +55°C* (+20 ... +50°C)**	+20 ... +50°C	+20 ... +55°C* (+20 ... +50°C)**
	R134a	R134a	R134a	R134a	R134a	R134a	R134a
	0.23 kg	0.23 kg	0.38 kg	0.38 kg	0.45 kg	0.45 kg	0.54 kg
	25 bar (28 bar)**	25 bar (28 bar)**	25 bar (28 bar)**	25 bar	25 bar (28 bar)**	25 bar (28 bar)**	25 bar (28 bar)**
	Optional, see page 451	Optional, see page 451	Optional, see page 451	Optional, see page 451	Optional, see page 451	Optional, see page 451	Optional, see page 451
	1 x 230 V / 50-60 Hz**	2 x 400-440 V / 50-60 Hz**	1 x 230 V / 50-60 Hz**	2 x 400-440 V / 50-60 Hz	1 x 230 V / 50-60 Hz**	2 x 400-440 V / 50-60 Hz**	1 x 230 V / 50-60 Hz**
	10.5 A / 3 A	8 A / 2 A	11 A / 3.8 A	8.5 A / 2.8 A	18 A / 5.4 A	11 A / 2.9 A	24 A / 6.5 A
	570 W	590 W	650 W	660 W	850 W	840 W	1080 W
	650 W	670 W	760 W	770 W	970 W	960 W	1290 W
	1.8	1.7	1.9	1.9	1.9	1.9	1.9
	T6 A	T4 A	T6 A	T4 A	T10 A	T6 A	T10 A
	783 x 348 x 215 mm	783 x 348 x 215 (+58) mm	999 x 405 x 237 mm	999 x 405 x 237 mm	999 x 405 x 237 mm	999 x 405 x 237 mm	999 x 405 x 237 mm
	IP55 / IP34	IP55 / IP34	IP55 / IP34	IP55 / IP34	IP55 / IP34	IP55 / IP34	IP55 / IP34
	65 dB	65 dB	65 dB	65 dB	65 dB	65 dB	65 dB
	28 kg	29 kg	38 kg	40 kg	40 kg	42 kg	52 kg
	<b>NSYCU1K</b>	<b>NSYCU1K2P4</b>	<b>NSYCU1K2</b>	<b>NSYCU1K22P4</b>	<b>NSYCU1K6</b>	<b>NSYCU1K62P4</b>	<b>NSYCU2K</b>
	<b>NSYCU1KUL</b>	<b>NSYCU1K2P4UL</b>	<b>NSYCU1K2UL</b>	<b>NSYCU1K22P4UL</b>	<b>NSYCU1K6UL</b>	<b>NSYCU1K62P4UL</b>	<b>NSYCU2KUL</b>
	<b>NSYCUX1K</b>	<b>NSYCUX1K2P4</b>	<b>NSYCUX1K2</b>	<b>NSYCUX1K22P4</b>	<b>NSYCUX1K6</b>	<b>NSYCUX1K62P4</b>	<b>NSYCUX2K</b>
	<b>NSYCUX1KUL</b>	<b>NSYCUX1K2P4UL</b>	<b>NSYCUX1K2UL</b>	<b>NSYCUX1K22P4UL</b>	<b>NSYCUX1K6UL</b>	<b>NSYCUX1K62P4UL</b>	<b>NSYCUX2KUL</b>
	<b>NSYCUX1KUL</b>	<b>NSYCUX1K2P4UL</b>	<b>NSYCUX1K2UL</b>	-	<b>NSYCUX1K6UL</b>	<b>NSYCUX1K62P4UL</b>	<b>NSYCUX2KUL</b>

New

### Cooling units



Characteristics	Side-mounting models	Floor-standing models
	Cooling units for electrical control panels. <ul style="list-style-type: none"> <li>Alarm signal for door contact included in all models.</li> <li>Eyebolts included.</li> <li>Among best in class components.</li> <li>The external filter, not included as standard, is strongly recommended for harsh environments.</li> </ul>	
Material	RAL 7035 grey painted zinc-coated steel or stainless steel	
Certifications	<ul style="list-style-type: none"> <li>CE declaration</li> <li>UL (only references ending with UL)</li> </ul>	
Installation	Indoor	<ul style="list-style-type: none"> <li>Indoor</li> <li>Cannot be installed with enclosures with plinths</li> </ul>

Cooling characteristics				
Cooling power L35-L35	2000 W (6824 Btu/h)	2900 W (9895 Btu/h)	3850 W (13137 Btu/h)	5800 W (19790 Btu/h)
Cooling power L35-L50	1510 W (5152 Btu/h)	2250 W (7677 Btu/h)	2870 W (9793 Btu/h)	4350 W (14843 Btu/h)
Air flow of the internal circuit (enclosure)	860 m³/h	1450 m³/h	1450 m³/h	1450 m³/h
Air flow of the external circuit (ambient)	1050 m³/h	1450 m³/h	1450 m³/h	2900 m³/h
Thermostat type	Electronic	Electronic	Electronic	Electronic
Temperature setting range	+20 ... +46°C	+20 ... +46°C	+20 ... +46°C	+20 ... +46°C
Maximum outside temperature	+55°C (+45°C)	+55°C (+45°C)	+55°C (+45°C)	+50°C
Temperature range external circuit (ambient)	+20 ... +50°C (+20 ... +45°C)*	+20 ... +50°C (+20 ... +45°C)*	+20 ... +50°C (+20 ... +45°C)*	+20 ... +50°C
Type of cooling gas	R134a	R134a	R134a	R407c
Cooling gas weight	0.59 kg	0.84 kg	1.14 kg	1.8 kg
Maximum pressure cooling circuit	25 bar (28 bar)*	25 bar (28 bar)*	25 bar (28 bar)*	27 bar
External filter	Optional, see page 451	Optional, see page 451	Optional, see page 451	Polyurethane filter standard
Electric characteristics				
Input voltage	3 x 400-460 V / 50-60 Hz*	3 x 400-460 V / 50-60 Hz*	3 x 400-460 V / 50-60 Hz*	3 x 400 V / 50 Hz
Starting / Rated Intensity	10 A / 2.5 A	14 A / 2.6 A	18 A / 3.6 A	21.7 A / 5.9 A
Power consumption absorbed L35-L35	970 W	1220 W	1780 W	2340 W
Power consumption absorbed L35-L50	1150 W	1440 W	2050 W	3880 W
Energy efficiency ratio (EER) L35-L35	2.1	2.4	2.2	2.5
Thermal protection recommended (fuse)	T6 A	T6 A	T8 A	T8 A
Physical characteristics				
External dimensions (H x W x D)	999 x 405 x 237 mm	1270 x 500 x 336 mm	1270 x 500 x 336 mm	2000 x 600 x 380 mm
Protection degree IP internal /external	IP55 / IP34	IP55 / IP34	IP55 / IP34	IP54 / IP34
Noise level	65 dB	70 dB	70 dB	72 dB
Weight of unit	54 kg	84 kg	85 kg	150 kg
References				
Steel	NSYCU2K3P4	NSYCU3K3P4	NSYCU4K3P4	NSYCU6K3P4**
Stainless steel	NSYCUX2K3P4	NSYCUX3K3P4	NSYCUX4K3P4	-
Steel UL	NSYCU2K3P4UL	NSYCU3K3P4UL	NSYCU4K3P4UL	-
Stainless steel UL	NSYCUX2K3P4UL	NSYCUX3K3P4UL	NSYCUX4K3P4UL	-

\* Certification UL only 60 Hz.

\*\* Available from 2016.



- Indoor
- Cannot be installed with enclosures with plinths

6050 W (20643 Btu/h)	7600 W (25932 Btu/h)	7950 W (27126 Btu/h)	9400 W (32074 Btu/h)	9850 W (33610 Btu/h)	14800 W (50500 Btu/h)	15150 W (51694 Btu/h)
4350 W (14843 Btu/h)	5700 W (19449 Btu/h)	5930 W (20234 Btu/h)	7000 W (23885 Btu/h)	7350 W (25079 Btu/h)	11300 W (38557 Btu/h)	11600 W (39581 Btu/h)
1450 m³/h	2900 m³/h	2900 m³/h	2900 m³/h	2900 m³/h	4300 m³/h	4300 m³/h
2900 m³/h	2900 m³/h	2900 m³/h	2900 m³/h	2900 m³/h	5800 m³/h	5800 m³/h
Electronic	Electronic	Electronic	Electronic	Electronic	Electronic	Electronic
+20 ... +46°C	+20 ... +46°C	+20 ... +46°C	+20 ... +46°C	+20 ... +46°C	+20 ... +46°C	+20 ... +46°C
+50°C	+50°C	+50°C	+50°C	+50°C	+55°C	+55°C
+20 ... +50°C	+20 ... +50°C	+20 ... +50°C	+20 ... +45°C	+20 ... +45°C	+20 ... +50°C	+20 ... +50°C
R407c	R134a	R134a	R134a	R134a	R410a	R410a
1.8 kg	2.8 kg	2.8 kg	2.3 kg	2.3 kg	3.5 kg	3.5 kg
27 bar	27 bar	27 bar	27 bar	27 bar	39 bar	39 bar
Polyurethane filter standard	Polyurethane filter standard	Polyurethane filter standard	Polyurethane filter standard	Polyurethane filter standard	Polyurethane filter standard	Polyurethane filter standard
3 x 460 V / 60 Hz	3 x 400 V / 50 Hz	3 x 460 V / 60 Hz	3 x 400 V / 50 Hz	3 x 460 V / 60 Hz	3 x 400 V / 50 Hz	3 x 460 V / 60 Hz
23.5 A / 6.8 A	43.8 A / 7.2 A	44.5 A / 7.9 A	30.7 A / 9.1 A	32.5 A / 10.3 A	49 A / 11 A	51 A / 11.8 A
2920 W	3530 W	4210 W	3850 W	4380 W	5750 W	6580 W
4520 W	4270 W	5340 W	5400 W	6340 W	6900 W	7760 W
2.1	2.2	1.9	2.4	2.2	2.6	2.3
T8 A	T10 A	T10 A	T18 A	T18 A	T20 A	T20 A
2000 x 600 x 380 mm	2000 x 800 x 380 mm	2000 x 800 x 380 mm	2000 x 800 x 380 mm	2000 x 800 x 380 mm	2000 x 800 x 550 mm	2000 x 800 x 550 mm
IP54 / IP34	IP54 / IP34	IP54 / IP34	IP54 / IP34	IP54 / IP34	IP54 / IP34	IP54 / IP34
72 dB	72 dB	72 dB	77 dB	77 dB	67 dB	67 dB
150 kg	160 kg	160 kg	180 kg	180 kg	240 kg	240 kg
<b>NSYCU6K3P460**</b>	<b>NSYCU8K3P4**</b>	<b>NSYCU8K3P460**</b>	<b>NSYCU10K3P4**</b>	<b>NSYCU10K3P460**</b>	<b>NSYCU15K3P4**</b>	<b>NSYCU15K3P460**</b>
-	-	-	-	-	-	-
-	-	-	-	-	-	-
-	-	-	-	-	-	-

New

### Cooling units



Characteristics	Top-mounting models		
	Cooling units for electrical control panels.		
	<ul style="list-style-type: none"> <li>■ Respect for the environment by using environmentally friendly gas R134a (HFC).</li> <li>■ Alarm signal for door contact included in all models.</li> <li>■ Eyebolts included.</li> <li>■ Among best in class components.</li> <li>■ The external filter, not included as standard, is strongly recommended for harsh environments.</li> </ul>		
Material	RAL 7035 grey painted zinc-coated steel or stainless steel		
Certifications	<ul style="list-style-type: none"> <li>■ CE declaration</li> <li>■ UL (only references ending with UL)</li> </ul>		
Installation	Indoor		
<b>Cooling characteristics</b>			
Cooling power L35-L35	410 W (1399 Btu/h)	820 W (2798 Btu/h)	1150 W (3924 Btu/h)
Cooling power L35-L50	240 W (819 Btu/h)	680 W (2320 Btu/h)	900 W (3071 Btu/h)
Air flow of the internal circuit (enclosure)	235 m³/h	570 m³/h	570 m³/h
Air flow of the external circuit (ambient)	330 m³/h	860 m³/h	1010 m³/h
Thermostat type	Electronic	Electronic	Electronic
Temperature setting range	+20 ... +46°C	+20 ... +46°C	+20 ... +46°C
Maximum outside temperature	+55°C	+55°C	+55°C
Temperature range external circuit (ambient)	+20 ... +55°C* (+20 ... +50°C)**	+20 ... +55°C* (+20 ... +50°C)**	+20 ... +55°C* (+20 ... +50°C)**
Type of cooling gas	R134a	R134a	R134a
Cooling gas weight	0.17 kg	0.31 kg	0.63 kg
Maximum pressure cooling circuit	28 bar	25 bar (28 bar)**	25 bar (28 bar)**
External filter	Optional, see page 451	Optional, see page 451	Optional, see page 451
<b>Electric characteristics</b>			
Input voltage	1 x 230 V / 50-60 Hz**	1 x 230 V / 50-60 Hz**	1 x 230 V / 50-60 Hz**
Starting / Rated Intensity	4 A / 1.5 A	12 A / 2.9 A	11 A / 3.2 A
Power consumption absorbed L35-L35	230 W	510 W	550 W
Power consumption absorbed L35-L50	290 W	560 W	660 W
Energy efficiency ratio (EER) L35-L35	1.8	1.6	2.1
Thermal protection recommended (fuse)	T4 A	T6 A	T6 A
<b>Physical characteristics</b>			
External dimensions (H x W x D)	264 x 486 x 259 mm	340 x 600 x 340 mm	415 x 567 x 401 mm
Protection degree IP internal /external	IP54 / IP34	IP54 / IP34	IP54 / IP34
Noise level	65 dB	65 dB	65 dB
Weight of unit	18 kg	23 kg	40 kg
<b>References</b>			
Steel	<b>NSYCU400R</b>	<b>NSYCU800R</b>	<b>NSYCU1K2R</b>
Stainless steel	<b>NSYCUX400R</b>	<b>NSYCUX800R</b>	<b>NSYCUX1K2R</b>
Steel UL	<b>NSYCU400RUL</b>	<b>NSYCU800RUL</b>	<b>NSYCU1K2RUL</b>

\* 50°C at 60 Hz.

\*\* Certification UL only 60 Hz.





	1550 W (5289 Btu/h)	2050 W (6995 Btu/h)	2050 W (6995 Btu/h)	2900 W (9895 Btu/h)	3850 W (13137 Btu/h)
	1200 W (4095 Btu/h)	1560 W (5323 Btu/h)	1560 W (5323 Btu/h)	2250 W (7677 Btu/h)	2870 W (9793 Btu/h)
	860 m³/h	1050 m³/h	1050 m³/h	860 m³/h	1450 m³/h
	1820 m³/h	1820 m³/h	1820 m³/h	3410 m³/h	3410 m³/h
	Electronic	Electronic	Electronic	Electronic	Electronic
	+20 ... +46°C	+20 ... +46°C	+20 ... +46°C	+20 ... +46°C	+20 ... +46°C
	+55°C	+55°C (+50°C)**	+50°C (+45°C)**	+50°C (+45°C)**	+50°C (+45°C)**
	+20 ... +55°C* (+20 ... +50°C)**	+20 ... +55°C*	+20 ... +50°C (+20 ... +45°C)**	+20 ... +50°C (+20 ... +45°C)**	+20 ... +50°C (+20 ... +45°C)**
	R134a	R134a	R134a	R134a	R134a
	0.54 kg	0.55 kg	0.55 kg	1.20 kg	1.60 kg
	25 bar (28 bar)**	25 bar	25 bar (28 bar)**	25 bar (28 bar)**	25 bar (28 bar)**
	Optional, see page 451	Optional, see page 451	Optional, see page 451	Optional, see page 451	Optional, see page 451
	1 x 230 V / 50-60 Hz**	1 x 230 V / 50-60 Hz	3 x 400-460 V / 50-60 Hz**	3 x 400-460 V / 50-60 Hz**	3 x 400-460 V / 50-60 Hz**
	18 A / 4.5 A	24 A / 6 A	10 A / 1.9 A	15.7 A / 2.5 A	17 A / 3.6 A
	810 W	1150 W	990 W	1210 W	1790 W
	930 W	1250 W	1190 W	1450 W	2010 W
	1.9	1.8	2.1	2.4	2.2
	T10 A	T10 A	T6 A	T6 A	T6 A
	415 x 567 x 401 mm	415 x 567 x 401 mm	415 x 567 x 401 mm	496 x 797 x 492 mm	496 x 797 x 492 mm
	IP54 / IP34	IP54 / IP34	IP54 / IP34	IP54 / IP34	IP54 / IP34
	65 dB	65 dB	65 dB	75 dB	75 dB
	44 kg	50 kg	52 kg	83 kg***	86 kg***
	<b>NSYCU1K5R</b>	<b>NSYCU2KR</b>	<b>NSYCU2K3P4R</b>	<b>NSYCU3K3P4R</b>	<b>NSYCU4K3P4R</b>
	<b>NSYCUX1K5R</b>	<b>NSYCUX2KR</b>	<b>NSYCUX2K3P4R</b>	<b>NSYCUX3K3P4R</b>	<b>NSYCUX4K3P4R</b>
	<b>NSYCU1K5RUL</b>	-	<b>NSYCU2K3P4RUL</b>	<b>NSYCU3K3P4RUL</b>	<b>NSYCU4K3P4RUL</b>

\*\*\* To mount on roof of Spacial SF, it is mandatory to order the roof mounting support (see table below).

### Roof mounting support

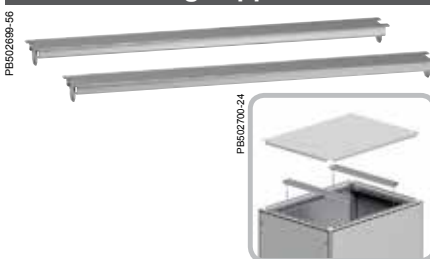

To install heavy top-mounting models on Spacial SF (cooling units with weight > 65 kg).

- Material: steel.
- Colour: RAL 7035.
- Supply: 2 units.

Depth 600 mm	Depth 800 mm
<b>NSYSUCR4060</b>	<b>NSYSUCR4080</b>

New

### Outdoor Heavy Duty cooling units



Characteristics	Side-mounting models		
	Cooling units to be installed outdoors, in private areas, on electrical control panels. <ul style="list-style-type: none"> <li>■ Respect for the environment by using environmentally friendly gas R134a (HFC).</li> <li>■ Mechanical thermostats in all models.</li> <li>■ Alarm signal for door contact included in all models.</li> <li>■ Eyebolts included.</li> <li>■ Among best in class components.</li> <li>■ The external filter, not included as standard. The metallic filter is strongly recommended.</li> <li>■ Metallic canopy as standard.</li> <li>■ Anti-corrosive protection (class C3H).</li> <li>■ Inside components, including the condenser, coated with anti-corrosive protection.</li> </ul>		
Material	RAL 7035 grey painted zinc-coated steel		
Certifications	CE declaration		
Installation	Indoor or outdoor		
<b>Cooling characteristics</b>			
Cooling power L35-L35	380 W (1297 Btu/h)	640 W (2184 Btu/h)	820 W (2798 Btu/h)
Cooling power L35-L50	240 W (819 Btu/h)	470 W (1604 Btu/h)	680 W (2320 Btu/h)
Air flow of the internal circuit (enclosure)	280 m³/h	330 m³/h	330 m³/h
Air flow of the external circuit (ambient)	280 m³/h	570 m³/h	570 m³/h
Thermostat type	Mechanic	Mechanic	Mechanic
Temperature setting range	+20 ... +46°C	+20 ... +46°C	+20 ... +46°C
Maximum outside temperature	+55°C	+55°C	+55°C
Temperature range external circuit (ambient)	-20 ... +55°C	-20 ... +55°C	-20 ... +55°C
Type of cooling gas	R134a	R134a	R134a
Cooling gas weight	0.16 kg	0.23 kg	0.23 kg
Maximum pressure cooling circuit	26 bar	25 bar	25 bar
External filter	Optional, see metallic filter on page 451	Optional, see metallic filter on page 451	Optional, see metallic filter on page 451
<b>Electric characteristics</b>			
Input voltage	1 x 230 V / 50-60 Hz	1 x 230 V / 50-60 Hz	1 x 230 V / 50-60 Hz
Starting / Rated Intensity	6.0 A / 1.6 A	8.1 A / 2.1 A	10.8 A / 2.6 A
Power consumption absorbed L35-L35	280 W	400 W	440 W
Power consumption absorbed L35-L50	330 W	470 W	490 W
Energy efficiency ratio (EER) L35-L35	1.4	1.6	1.9
Thermal protection recommended (fuse)	T4 A	T6 A	T6 A
<b>Physical characteristics</b>			
External dimensions (H x W x D)	460 x 285 x 180 mm	606 x 316 x 212 mm	783 x 348 x 215 mm
Protection degree IP internal /external	IP55 / IP34	IP55 / IP34	IP55 / IP34
Noise level	60 dB	65 dB	65 dB
Weight of unit	17 kg	21 kg	27 kg
<b>References</b>	<b>NSYCUHD400</b>	<b>NSYCUHD600</b>	<b>NSYCUHD800</b>

# Thermal management system

## Characteristics



	1000 W (3412 Btu/h)	1000 W (3412 Btu/h)	1600 W (5459 Btu/h)	1600 W (5459 Btu/h)	2000 W (6824 Btu/h)	2900 W (9895 Btu/h)	3850 W (13137 Btu/h)
	790 W (2696 Btu/h)	790 W (2696 Btu/h)	1230 W (4197 Btu/h)	1230 W (4197 Btu/h)	1510 W (5152 Btu/h)	2250 W (7677 Btu/h)	2870 W (9793 Btu/h)
	330 m³/h	330 m³/h	570 m³/h	570 m³/h	860 m³/h	1450 m³/h	1450 m³/h
	570 m³/h	570 m³/h	1050 m³/h	1050 m³/h	1050 m³/h	1450 m³/h	1450 m³/h
	Mechanic	Mechanic	Mechanic	Mechanic	Mechanic	Mechanic	Mechanic
	+20 ... +46°C	+20 ... +46°C	+20 ... +46°C	+20 ... +46°C	+20 ... +46°C	+20 ... +46°C	+20 ... +46°C
	+55°C	+55°C	+55°C	+55°C	+55°C	+55°C	+55°C
	-20 ... +55°C	-20 ... +50°C	-20 ... +55°C	-20 ... +50°C	-20 ... +55°C	-20 ... +50°C	-20 ... +50°C
	R134a	R134a	R134a	R134a	R134a	R134a	R134a
	0.23 kg	0.23 kg	0.45 kg	0.45 kg	0.59 kg	0.84 kg	1.14 kg
	25 bar	25 bar	25 bar	25 bar	25 bar	25 bar	25 bar
	Optional, see metallic filter on page 451	Optional, see metallic filter on page 451	Optional, see metallic filter on page 451	Optional, see metallic filter on page 451	Optional, see metallic filter on page 451	Optional, see metallic filter on page 451	Optional, see metallic filter on page 451
	1 x 230 V / 50-60 Hz	2 x 400-440V / 50-60 Hz	1 x 230 V / 50-60 Hz	2 x 400-440V / 50-60 Hz	3 x 400 V / 50-60 Hz	3 x 400 V / 50-60 Hz	3 x 400 V / 50-60 Hz
	10.5 A / 3 A	8 A / 2 A	18 A / 5.4 A	11 A / 2.9 A	10 A / 2.5 A	14 A / 2.6 A	18 A / 3.6 A
	570 W	590 W	850 W	840 W	970 W	1220 W	1780 W
	650 W	670 W	970 W	960 W	1150 W	1440 W	2050 W
	1.8	1.7	1.9	1.9	2.1	2.4	2.2
	T6 A	T4 A	T10 A	T6 A	T6 A	T6 A	T8 A
	783 x 348 x 215 mm	783 x 348 x 215 (+58) mm	999 x 405 x 237 mm	999 x 405 x 237 mm	999 x 405 x 237 mm	1270 x 500 x 336 mm	1270 x 500 x 336 mm
	IP55 / IP34	IP55 / IP34	IP55 / IP34	IP55 / IP34	IP55 / IP34	IP55 / IP34	IP55 / IP34
	65 dB	65 dB	65 dB	65 dB	65 dB	70 dB	70 dB
	28 kg	29 kg	40 kg	42 kg	54 kg	84 kg	85 kg
	<b>NSYCUHD1K</b>	<b>NSYCUHD1K2P4</b>	<b>NSYCUHD1K6</b>	<b>NSYCUHD1K62P4</b>	<b>NSYCUHD2K3P4</b>	<b>NSYCUHD3K3P4</b>	<b>NSYCUHD4K3P4</b>

New

### Slim cooling units



Characteristics		Side-mounting models			
		Cooling Units designed for control panels and switchboards.			
		<ul style="list-style-type: none"> <li>■ Respect for the environment by using environmentally friendly gas R134a (HFC).</li> <li>■ Electronical thermostat included.</li> <li>■ 3 mounting positions (surface, half-flush and flush).</li> <li>■ Alarm Signal for contact door.</li> <li>■ Eyebolts included.</li> </ul>			
Material		RAL 7035 grey painted zinc-coated steel			
Certifications		<ul style="list-style-type: none"> <li>■ CE declaration</li> <li>■ UL</li> </ul>			
Installation		<ul style="list-style-type: none"> <li>■ Indoor</li> <li>■ There is one unique cutout for all mounting positions and all slim models</li> </ul>			
<b>Cooling characteristics</b>					
Cooling power L35-L35	1100 W (3753 Btu/h)	1100 W (3753 Btu/h)	1500 W (5118 Btu/h)	1500 W (5118 Btu/h)	
Cooling power L35-L50	860 W (2934 Btu/h)	860 W (2934 Btu/h)	1150 W (3924 Btu/h)	1150 W (3924 Btu/h)	
Air flow of the internal circuit (enclosure)	860 m³/h	860 m³/h	860 m³/h	860 m³/h	
Air flow of the external circuit (ambient)	860 m³/h	860 m³/h	860 m³/h	860 m³/h	
Thermostat type	Electronic	Electronic	Electronic	Electronic	
Temperature setting range	+20 ... +46°C	+20 ... +46°C	+20 ... +46°C	+20 ... +46°C	
Maximum outside temperature	+55°C* (+50°C)**	+50°C	+55°C* (+50°C)**	+50°C	
Temperature range external circuit (ambient)	+20 ... +55°C* (+20 ... +50°C)**	+20 ... +50°C	+20 ... +55°C* (+20 ... +50°C)**	+20 ... +50°C	
Type of cooling gas	R134a	R134a	R134a	R134a	
Cooling gas weight	0.5 kg	0.5 kg	0.46 kg	0.46 kg	
Maximum pressure cooling circuit	28 bar	28 bar	28 bar	28 bar	
External circuit filter	Optional, see page 451	Optional, see page 451	Optional, see page 451	Optional, see page 451	
<b>Electric characteristics</b>					
Input voltage	1 x 230 V / 50-60 Hz**	2 x 400-460 V / 50-60 Hz**	1 x 230 V / 50-60 Hz**	2 x 400-460 V / 50-60 Hz**	
Starting / Rated Intensity	11 A / 4.8 A	8.5 A / 2.7 A	18 A / 5.7 A	11 A / 3.2 A	
Power consumption absorbed L35-L35	660 W	660 W	840 W	840 W	
Power consumption absorbed L35-L50	790 W	790 W	970 W	970 W	
Energy efficiency ratio (EER) L35-L35	1.7	1.7	1.8	1.8	
Thermal protection recommended (fuse)	T6 A	T4 A	T10 A	T6 A	
<b>Physical characteristics</b>					
External dimensions (H x W x D)	495 x 1696 x 195 mm	495 x 1696 x 195 mm	495 x 1696 x 195 mm	495 x 1696 x 195 mm	
Protection degree IP internal /external	IP55 / IP34	IP55 / IP34	IP55 / IP34	IP55 / IP34	
Noise level	64 dB	64 dB	66 dB	66 dB	
Weight of unit	50 kg	52 kg	55 kg	57 kg	
<b>References</b>					
Steel UL	NSYCUS1K1UL	NSYCUS1K12P4UL	NSYCUS1K5UL	NSYCUS1K52P4UL	
Stainless steel UL	NSYCUSX1K1UL	NSYCUSX1K12P4UL	NSYCUSX1K5UL	NSYCUSX1K52P4UL	

\* 50°C at 60 Hz.

\*\* Certification UL only 60 Hz.



PB002632-17

	2000 W (6824 Btu/h)	2000 W (6824 Btu/h)	2500 W (8530 Btu/h)	2500 W (8530 Btu/h)	3200 W (10919 Btu/h)	3200 W (10919 Btu/h)
	1550 W (5289 Btu/h)	1550 W (5289 Btu/h)	1850 W (6312 Btu/h)	1850 W (6312 Btu/h)	2500 W (8530 Btu/h)	2500 W (8530 Btu/h)
	860 m³/h	860 m³/h	1450 m³/h	1450 m³/h	1450 m³/h	1450 m³/h
	1050 m³/h	1050 m³/h	1450 m³/h	1450 m³/h	1450 m³/h	1450 m³/h
	Electronic	Electronic	Electronic	Electronic	Electronic	Electronic
	+20 ... +46°C	+20 ... +46°C	+20 ... +46°C	+20 ... +46°C	+20 ... +46°C	+20 ... +46°C
	+50°C	+55°C* (+50°C)**	+50°C	+55°C* (+50°C)**	+50°C	+55°C* (+50°C)**
	+20 ... +50°C	+20 ... +55°C* (+20 ... +50°C)**	+20 ... +50°C	+20 ... +55°C* (+20 ... +50°C)**	+20 ... +50°C	+20 ... +55°C* (+20 ... +50°C)**
	R134a	R134a	R134a	R134a	R134a	R134a
	0.51 kg	0.59 kg	1.2 kg	1.2 kg	0.85 kg	1.25 kg
	28 bar	28 bar	28 bar	28 bar	28 bar	28 bar
	Optional, see page 451	Optional, see page 451	Optional, see page 451	Optional, see page 451	Optional, see page 451	Optional, see page 451
	1 x 230 V / 60 Hz	3 x 400 V / 50 Hz (3 x 460 V / 60 Hz)*	1 x 230 V / 60 Hz	3 x 400 V / 50 Hz (3 x 460 V / 60 Hz)*	1 x 230 V / 60 Hz	3 x 400 V / 50 Hz (3 x 460 V / 60 Hz)*
	24 A / 6.5 A	10 A / 2.4 A (10 A / 2.1 A)*	35 A / 10.5 A	14 A / 3.3 A (14 A / 2.9 A)*	37 A / 10.5 A	18 A / 3.5 A (18 A / 3.1 A)*
	1020 W	1060 W	1340 W	1270 W	1720 W	1650 W
	1160 W	1270 W	1580 W	1510 W	2000 W	1980 W
	2.0	1.9	1.9	2.0	1.9	1.9
	T10 A	T6 A	T16 A	T6 A	T16 A	T6 A
	495 x 1696 x 195 mm	495 x 1696 x 195 mm	495 x 1696 x 235 mm	495 x 1696 x 235 mm	495 x 1696 x 235 mm	495 x 1696 x 235 mm
	IP55 / IP34	IP55 / IP34	IP55 / IP34	IP55 / IP34	IP55 / IP34	IP55 / IP34
	67 dB	67 dB	69 dB	69 dB	69 dB	69 dB
	63 kg	65 kg	78 kg	80 kg	78 kg	80 kg
	<b>NSYCUS2KUL</b>	<b>NSYCUS2K3P460UL</b>	<b>NSYCUS2K5UL</b>	<b>NSYCUS2K53P4UL</b>	<b>NSYCUS3K2UL</b>	<b>NSYCUS3K23P4UL</b>
	<b>NSYCUSX2KUL</b>	<b>NSYCUSX2K3P4UL</b>	<b>NSYCUSX2K5UL</b>	<b>NSYCUSX2K53P4UL</b>	<b>NSYCUSX3K2UL</b>	<b>NSYCUSX3K23P4UL</b>

New

### Cooling units

#### Side-mounting models: dimensions and cut-outs

##### NSYCU300H

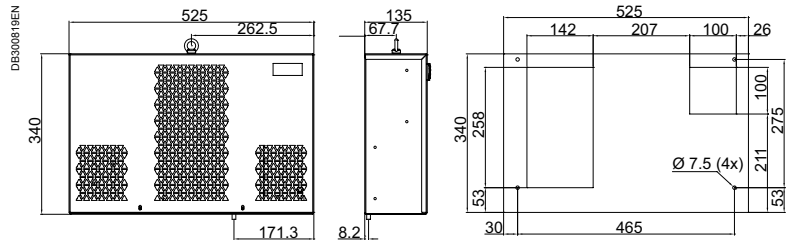

##### NSYCU•400•

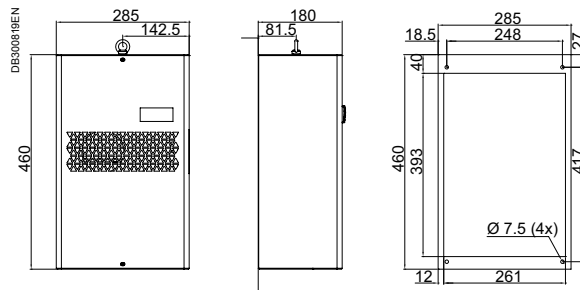

##### NSYCU•600•

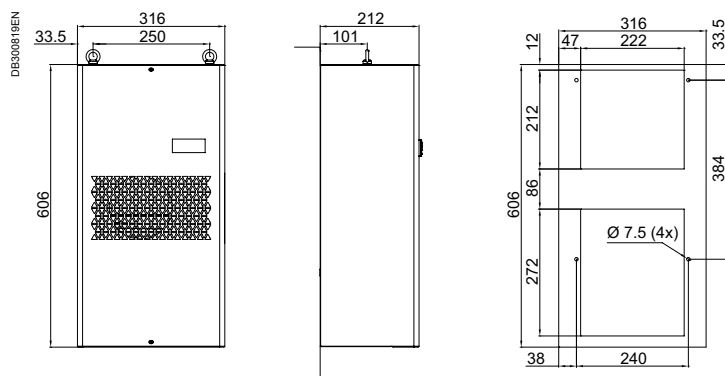

##### NSYCU•800• - NSYCU•1K•

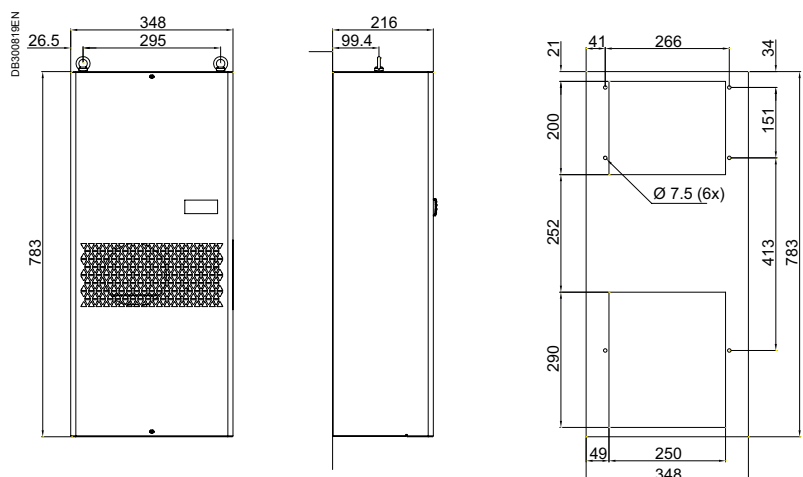

Units of measurement are mm.



New

### Cooling units

#### Top-mounting models: dimensions and cut-outs

##### NSYCU••400R••

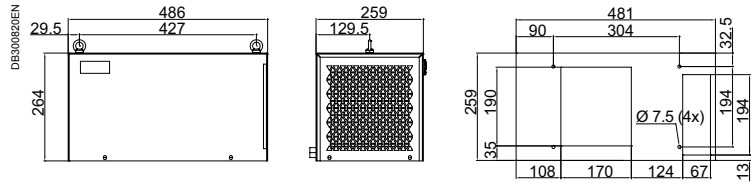

##### NSYCU••800R••

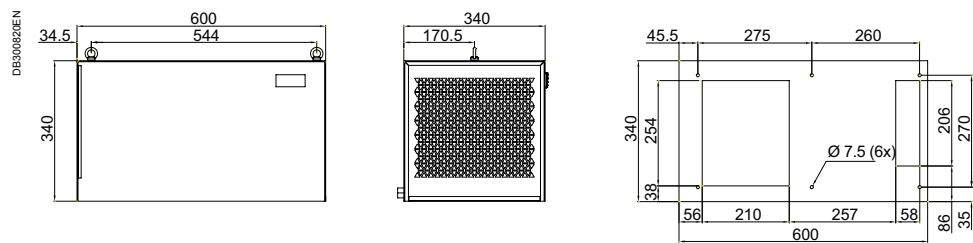

##### NSYCU••1K2R•• - NSYCU••1K5R•• - NSYCU••2K••R••

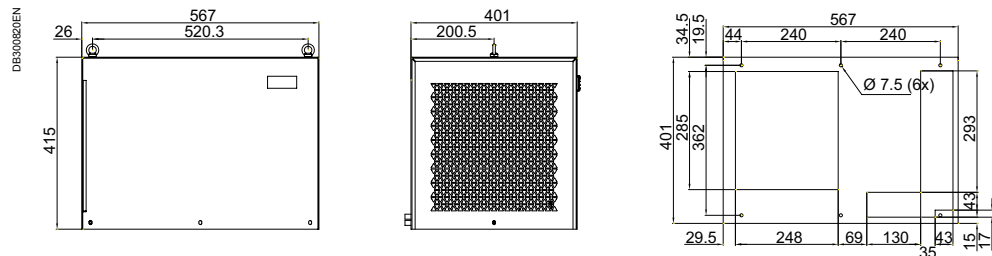

##### NSYCU••3K3P4R•• - NSYCU••4K3P4R••

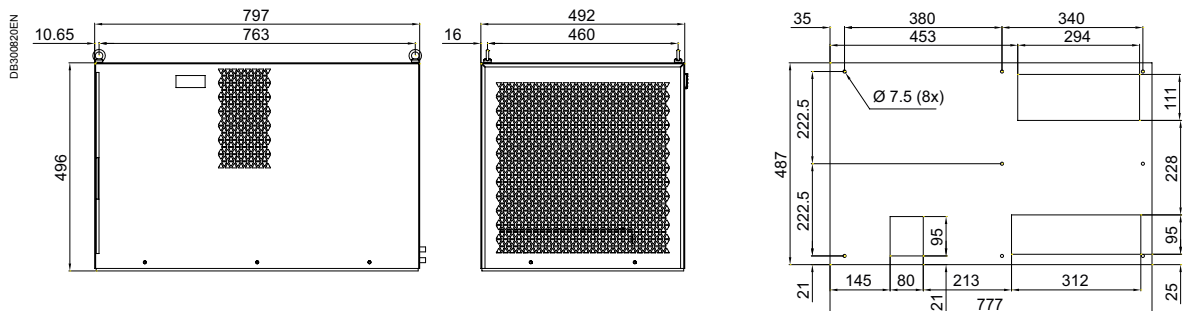

Units of measurement are mm.



New

### Slim cooling units

#### NSYCUS•1K1• - NSYCUS•1K5• - NSYCUS•2K•

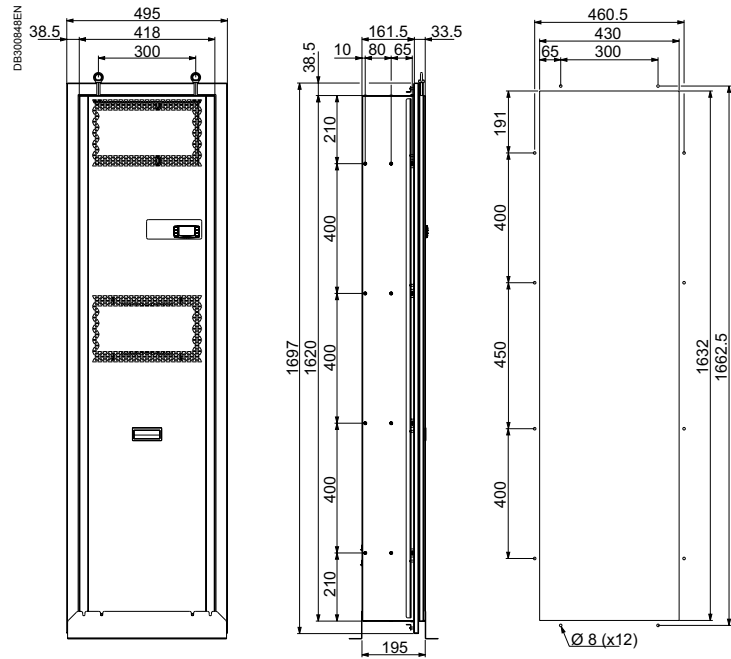

#### NSYCUS•2K5• - NSYCUS•3K2•

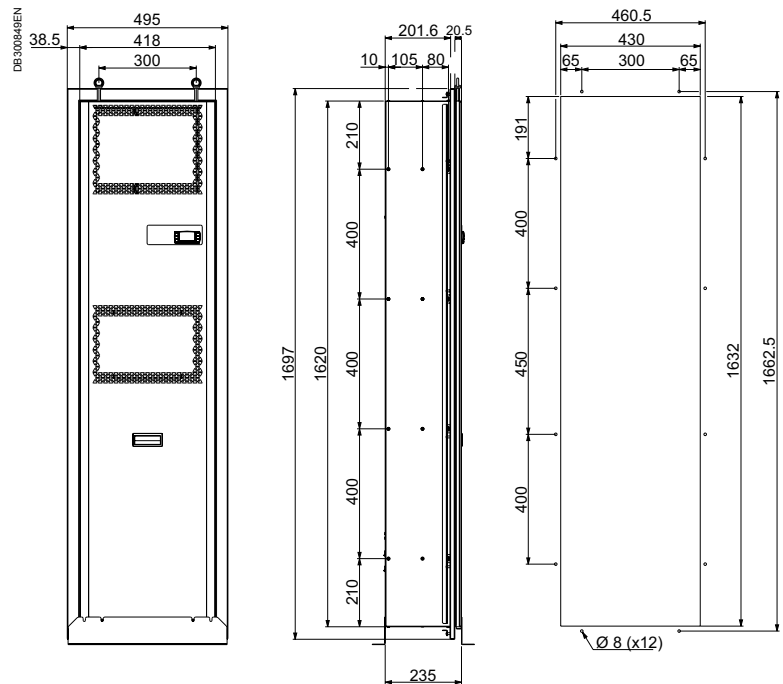

Units of measurement are mm.

New



PBE502616-22

Characteristics	Cooling units					
	IEC			UL		
	Steel	Stainless steel	Outdoor	Steel	Stainless steel	
Material						
Colour						
Installation						
Supply						
<b>References</b>						
<b>Cooling units</b>						
Side-mounting models	NSYCU300H	-	-	-	-	
	NSYCU400	NSYCUX400	NSYCUHD400	NSYCU400UL	-	
	NSYCU600	NSYCUX600	NSYCUHD600	NSYCU600UL	NSYCUX600UL	
	NSYCU800	NSYCUX800	NSYCUHD800	NSYCU800UL	NSYCUX800UL	
	NSYCU1K	NSYCUX1K	NSYCUHD1K	NSYCU1KUL	NSYCUX1KUL	
	NSYCU1K2P4	NSYCUX1K2P4	NSYCUHD1K2P4	NSYCU1K2P4UL	NSYCUX1K2P4UL	
	NSYCU1K2	NSYCUX1K2	-	NSYCU1K2UL	NSYCUX1K2UL	
	NSYCU1K22P4	NSYCUX1K22P4	-	-	-	
	NSYCU1K6	NSYCUX1K6	NSYCUHD1K6	NSYCU1K6UL	NSYCUX1K6UL	
	NSYCU1K62P4	NSYCUX1K62P4	NSYCUHD1K62P4	NSYCU1K62P4UL	NSYCUX1K62P4UL	
	NSYCU2K	NSYCUX2K	-	NSYCU2KUL	NSYCUX2KUL	
	NSYCU2K3P4	NSYCUX2K3P4	NSYCUHD2K3P4	NSYCU2K3P4UL	NSYCUX2K3P4UL	
	NSYCU3K3P4	NSYCUX3K3P4	NSYCUHD3K3P4	NSYCU3K3P4UL	NSYCUX3K3P4UL	
	NSYCU4K3P4	NSYCUX4K3P4	NSYCUHD4K3P4	NSYCU4K3P4UL	NSYCUX4K3P4UL	
	Floor-standing models	NSYCU6K3P4	-	-	-	-
		NSYCU6K3P460	-	-	-	-
		NSYCU8K3P4	-	-	-	-
		NSYCU8K3P460	-	-	-	-
		NSYCU10K3P4	-	-	-	-
NSYCU10K3P460		-	-	-	-	
NSYCU15K3P4		-	-	-	-	
NSYCU15K3P460	-	-	-	-		
Top-mounting model	NSYCU400R	NSYCUX400R	-	NSYCU400RUL	-	
	NSYCU800R	NSYCUX800R	-	NSYCU800RUL	-	
	NSYCU1K2R	NSYCUX1K2R	-	NSYCU1K2RUL	-	
	NSYCU1K5R	NSYCUX1K5R	-	NSYCU1K5RUL	-	
	NSYCU2K3P4R	NSYCUX2K3P4R	-	NSYCU2K3P4RUL	-	
	NSYCU2KR	NSYCUX2KR	-	-	-	
	NSYCU3K3P4R	NSYCUX3K3P4R	-	NSYCU3K3P4RUL	-	
	NSYCU4K3P4R	NSYCUX4K3P4R	-	NSYCU4K3P4RUL	-	
	Slim model	-	-	-	NSYCUS1K1UL	NSYCUSX1K1UL
		-	-	-	NSYCUS1K12P4UL	NSYCUSX1K12P4UL
-		-	-	NSYCUS1K5UL	NSYCUSX1K5UL	
-		-	-	NSYCUS1K52P4UL	NSYCUSX1K52P4UL	
-		-	-	NSYCUS2KUL	NSYCUSX2KUL	
-		-	-	NSYCUS2K3P460UL	NSYCUSX2K3P4UL	
-		-	-	NSYCUS2K5UL	NSYCUSX2K5UL	
-		-	-	NSYCUS2K53P4UL	NSYCUSX2K53P4UL	
-		-	-	NSYCUS3K2UL	NSYCUSX3K2UL	
-		-	-	NSYCUS3K23P4UL	NSYCUSX3K23P4UL	

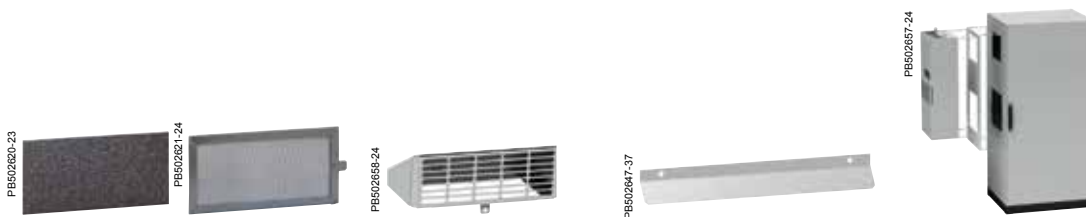

Filters		Canopy for ClimaSys CU		Internal deflector		Retrofit panel	
Plastic filter for ClimaSys Cu offer. Not recommended for outdoor models.		Metallic filter for ClimaSys Cu offer. Recommended for outdoor models.		Deflects the air inside the enclosure.		Panel that enable to mount a new ClimaSys CE or CU units by replacement of old Schneider Electric cooling systems.	
Polyurethane		Micro-stretched aluminium		Zinc coated		Metal painted	
Black		-		RAL 7035		RAL 7035	
Indoor		Indoor or outdoor		Indoor or outdoor		Indoor	
5 units		1 unit		1 unit with mounting elements		1 unit	
						Old Schneider Electric cooling system	
-	-	-	-	-	-	-	-
NSYCUF400	NSYCUFX400	NSYCUCN400HD	NSYCU400	NSYCURFT400	NSYCU240W230VL	NSYCU370W230VL	
NSYCUF600	NSYCUFX600	NSYCUCN600HD	NSYCU600	-	-	-	
NSYCUF800T1K	NSYCUFX800T1K	NSYCUCN800T1KHD	NSYCU800T1K	NSYCURFT800T1K	NSYCU760W230VL	NSYCU1100W230L	
NSYCUF800T1K	NSYCUFX800T1K	NSYCUCN800T1KHD	NSYCU800T1K	NSYCURFT800T1K	NSYCU1050W230VL	-	
NSYCUF800T1K	NSYCUFX800T1K	NSYCUCN800T1KHD	NSYCU1K2T2K	NSYCURFT800T1K	-	-	
NSYCUF1K2T2K	NSYCUFX1K2T2K	NSYCUCN1K2T2KHD	NSYCU1K2T2K	-	-	-	
NSYCUF1K2T2K	NSYCUFX1K2T2K	NSYCUCN1K2T2KHD	NSYCU1K2T2K	-	-	-	
NSYCUF1K2T2K	NSYCUFX1K2T2K	NSYCUCN1K2T2KHD	NSYCU1K2T2K	NSYCURFT1K6T2K	NSYCU1400W230L	NSYCU1650W230VL	
NSYCUF1K2T2K	NSYCUFX1K2T2K	NSYCUCN1K2T2KHD	NSYCU1K2T2K	NSYCURFT1K6T2K	NSYCU1400W400L	-	
NSYCUF1K2T2K	NSYCUFX1K2T2K	NSYCUCN1K2T2KHD	NSYCU1K2T2K	-	-	-	
NSYCUF1K2T2K	NSYCUFX1K2T2K	NSYCUCN1K2T2KHD	NSYCU1K2T2K	NSYCURFT1K6T2K	NSYCU1800W400VL	NSYCU1800W400L	
NSYCUF3KT4K	NSYCUFX3KT4K	NSYCUCN3KT4KHD	NSYCU3KT4K	NSYCURFT3KT4K	NSYCU2500W400VL	NSYCU4000W400VL	
NSYCUF3KT4K	NSYCUFX3KT4K	NSYCUCN3KT4KHD	NSYCU3KT4K	NSYCURFT3KT4K	NSYCU4000W400VL	-	
NSYCUF6K	NSYCUFX6K	-	-	-	-	-	
NSYCUF6K	NSYCUFX6K	-	-	-	-	-	
NSYCUF8KT10K	NSYCUFX8KT10K	-	-	-	-	-	
NSYCUF8KT10K	NSYCUFX8KT10K	-	-	-	-	-	
NSYCUF8KT10K	NSYCUFX8KT10K	-	-	-	-	-	
NSYCUF8KT10K	NSYCUFX8KT10K	-	-	-	-	-	
NSYCUF15K	NSYCUFX15K	-	-	-	-	-	
NSYCUF15K	NSYCUFX15K	-	-	-	-	-	
NSYCUF400R	NSYCUFX400R	-	-	-	-	-	
NSYCUF800R	NSYCUFX800R	-	-	-	NSYCURFT800R	NSYCU760W230VR	
NSYCUF1K2T2KR	NSYCUFX1K2T2KR	-	-	-	NSYCURFT1K2T2K	NSYCU1050W230VR	
NSYCUF1K2T2KR	NSYCUFX1K2T2KR	-	-	-	NSYCURFT1K2T2K	NSYCU1400W230R	
NSYCUF1K2T2KR	NSYCUFX1K2T2KR	-	-	-	NSYCURFT1K2T2K	NSYCU1460W230VR	
NSYCUF1K2T2KR	NSYCUFX1K2T2KR	-	-	-	NSYCURFT1K2T2K	NSYCU1650W230VR	
NSYCUF1K2T2KR	NSYCUFX1K2T2KR	-	-	-	NSYCURFT1K2T2K	NSYCU1800W400R	
NSYCUF1K2T2KR	NSYCUFX1K2T2KR	-	-	-	NSYCURFT1K2T2K	NSYCU2000W400VR	
NSYCUF3KT4KR	NSYCUFX3KT4KR	-	-	-	NSYCURFT3K	NSYCU2450W400VR	
NSYCUF3KT4KR	NSYCUFX3KT4KR	-	-	-	NSYCURFT3K	NSYCU3100W400VR	
NSYCUF1K1T2KS	NSYCUFX1K1T2KS	-	NSYCU1K1T1K5	-	-	NSYCU1100W230S	
NSYCUF1K1T2KS	NSYCUFX1K1T2KS	-	NSYCU1K1T1K5	-	-	NSYCU1100W400S	
NSYCUF1K1T2KS	NSYCUFX1K1T2KS	-	NSYCU1K1T1K5	-	-	NSYCU1500W230S	
NSYCUF1K1T2KS	NSYCUFX1K1T2KS	-	NSYCU1K1T1K5	-	-	NSYCU1500W400S	
NSYCUF1K1T2KS	NSYCUFX1K1T2KS	-	NSYCU1K1T1K5	-	-	NSYCU2200W230S	
NSYCUF1K1T2KS	NSYCUFX1K1T2KS	-	NSYCU1K1T1K5	-	-	NSYCU2200W400S	
NSYCUF2K5T3K2S	NSYCUFX2K5T3K2S	-	NSYCU1K1T1K5	-	-	NSYCU2700W230S	
NSYCUF2K5T3K2S	NSYCUFX2K5T3K2S	-	NSYCU1K1T1K5	-	-	NSYCU2700W400S	
NSYCUF2K5T3K2S	NSYCUFX2K5T3K2S	-	NSYCU1K1T1K5	-	-	NSYCU2700W230S	
NSYCUF2K5T3K2S	NSYCUFX2K5T3K2S	-	NSYCU1K1T1K5	-	-	NSYCU2700W400S	

➤ Ultra thin resistance heaters have been designed to resolve condensation problems in the most complex installations. Is your enclosure short of space? Does your mounting plate make it impossible to install a conventional resistor? Do you not want to take out the equipment? Discover the benefits of this new offer and its numerous mounting solutions.



PF502437-32

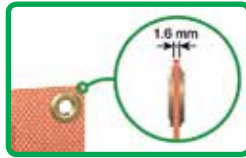

### Minimum thickness

They are extremely slim: 1.6 mm. As a result the usable space in the cabinet has been optimised for installing equipment. This can increase the usable space by up to 30 %!

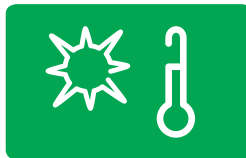

### Heat and safety

The heat is distributed over the whole surface and does not exceed 70°C. This temperature allows devices next to the heater to be handled safely.

PF502046-22



### Multiple options for mounting

Innovative quick-mounting system using Velcro pads (no need for a tool!) or with basic mounting accessories (screw + spacer). These systems make it easy to move the heater if necessary.

PF502522-16



### Numerous positions for installation

These heaters are so slim and flexible they can be installed in a variety of positions:

- Vertically on side panels
- On the mounting plate.



### Low starting current: Energy Efficiency

Ultra thin resistance heaters are ohmic: they therefore have a low starting current.





### No interference emissions

These resistors can be installed near electronic equipment to guarantee optimum heat without the risk of electromagnetic interference.

# Thermal management system

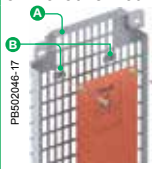
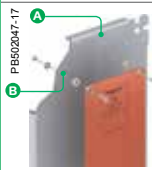
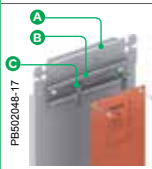
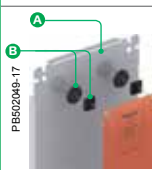
## Characteristics and selection guide

Ultra thin resistance heaters	
Description	Flexible, ultra thin resistance heaters to be installed inside the enclosure
Material	Silicon reinforced with fibreglass
Colour	Red (heaters), black (wires)
Certifications	VDE, LR
Installation	<p>5 innovative mounting solutions:</p> <div style="display: flex; justify-content: space-between;"> <div style="width: 45%;">  <p>PB502046-17</p> </div> <div style="width: 45%;"> <p><b>1 - On a Telequick mounting plate</b>  <b>A:</b> Telequick mounting plate, ref. NSYMR●●●●  <b>B:</b> Telequick nuts, ref. AF1EA●, supplied with the mounting kit</p> </div> </div> <div style="display: flex; justify-content: space-between;"> <div style="width: 45%;">  <p>PB502047-17</p> </div> <div style="width: 45%;"> <p><b>2 - On plain or micro-perforated mounting plate with mounting hardware</b>  <b>A:</b> Mounting plate, ref. NSYMM●●●●  <b>B:</b> Mounting hardware included in the mounting kit</p> </div> </div> <div style="display: flex; justify-content: space-between;"> <div style="width: 45%;">  <p>PB502048-17</p> </div> <div style="width: 45%;"> <p><b>3 - On DIN rail</b>  <b>A:</b> Mounting plate, ref. NSYMM●●●●  <b>B:</b> Symmetrical DIN rail, ref. NSYSDR●●●●  <b>C:</b> Clip-on nuts, ref. AF1CG●, supplied with the mounting kit</p> </div> </div> <div style="display: flex; justify-content: space-between;"> <div style="width: 45%;">  <p>PB502049-17</p> </div> <div style="width: 45%;"> <p><b>4 - On plain mounting plate with self-adhesive Velcro pads</b>  <b>A:</b> Mounting plate, ref. NSYMM●●●●  <b>B:</b> Self-adhesive Velcro pad and plastic mountings supplied with the mounting kit</p> </div> </div> <div style="display: flex; justify-content: space-between;"> <div style="width: 45%;">  <p>PB502022-35</p> </div> <div style="width: 45%;"> <p><b>5 - On wall with self-adhesive Velcro pads</b>  <b>A:</b> Self-adhesive Velcro pads and plastic mountings supplied in the mounting kit</p> </div> </div>

Ultra thin resistance heaters*						
Power (W)	Voltage (V)	Inrush current (A)	Height (mm)	Width (mm)	Depth (mm)	References
10	120	0.08	130	250	1.6	NSYCRS10W120V
	240	0.04	130	250	1.6	NSYCRS10W240V
25	120	0.21	130	250	1.6	NSYCRS25W120V
	240	0.10	130	250	1.6	NSYCRS25W240V
50	120	0.42	200	320	1.6	NSYCRS50W120V
	240	0.21	200	320	1.6	NSYCRS50W240V
100	120	0.83	280	450	1.6	NSYCRS100W120V
	240	0.42	280	450	1.6	NSYCRS100W240V
200	120	1.67	400	650	1.6	NSYCRS200W120V
	240	0.83	400	650	1.6	NSYCRS200W240V

\* Ultra thin resistance heaters can be manufactured with different dimensions and power ratings than those indicated above. Please contact us.

➤ The resistance heaters prevent the formation of condensation and guarantee the ideal temperature for the correct operation of the electronic components in the enclosure.



### Insulated PTC heaters



#### Large range of power levels

- 2 versions: by natural convection and with fan.
- AC or DC power supply.
- 7 power levels, from 10 W to 550 W.



#### Innovating design

Covered with plastic to prevent direct contact with the aluminium radiator.



#### Easy installation and connection

- Reduced dimensions.
- Quick electric connection by terminal board.
- No maintenance required.
- Direct clipping onto a 35 mm DIN rail.



#### Safety

- The protection prevents direct contact with the aluminium radiator.
- Electric protection device with terminal block cover.
- Equipped with a PTC-type heater.
- Surface temperature lower than 70°C.

#### High thermal efficiency

- The configuration of the aluminium profile produces a "chimney" effect: high natural convection.
- Low power consumption thanks to self-control of the PTC-type heater.



#### Models with fan

- The heaters equipped with a fan ensure circulation of the air and a uniform temperature inside the enclosure.
- High-flow, silent fan.

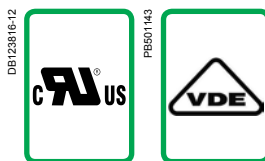

#### Certifications

- CE marking.
- Range compliant with UL and VDE.

PB501146-67



### Aluminium PTC heaters

PB501146-28



#### Resistance heaters equipped with a PTC-type sensor

The resistance heaters for electrical and electronic enclosures are equipped with PTC-type heating devices (Positive Temperature Coefficient).

Thanks to these heaters:

- The surface temperature stabilises at 75°C when the ambient temperature is -5°C.
- Power consumption is reduced.

#### Improved convection

The design of the profile of the resistance heaters produces a "chimney" effect, leading to increased natural convection and maintaining an even temperature inside the enclosure.

PB501147-111



#### Quick mounting

The resistance heaters are fixed by means of mounting clips to a 35 mm DIN rail.

PB501146-21



#### Connection cables

The 10 and 20 W heaters are equipped with a 2 x 0.75 x 300 mm power cord.

PB501149-28



#### Connection terminal boards

Heaters with a power of more than 20 W are equipped with a connection terminal board.

#### Large range of power levels

8 power levels, from 10 W to 400 W.

PB501025-28



#### Models with fan

Models of 250 to 400 W with fan.

### Insulated PTC resistance heaters

#### Characteristics

Material

Conditions of use

Ingress protection rating

Certifications

Power at 0°C	Voltage	Surface temperature	Electric connection	Mounting
10 W	110-250 V AC	<70°C, except for the top protection grille	2 poles, 2.5 mm <sup>2</sup>	Quick by clip on a 35-mm DIN rail
10 W	12-24 V DC			
20 W	110-250 V AC	<70°C, except for the top protection grille	4 poles, 2.5 mm <sup>2</sup>	By clip on a 35-mm DIN rail
20 W	12-24 V DC			
55 W	110-250 V AC	<70°C, except for the top protection grille	4 poles, 2.5 mm <sup>2</sup>	By clip on a 35-mm DIN rail
55 W	12-24 V DC			
55 W	270-420 V AC	<70°C, except for the top protection grille	4 poles, 2.5 mm <sup>2</sup>	By clip on a 35-mm DIN rail
100 W	110-250 V AC			
100 W	12-24 V DC	<70°C, except for the top protection grille	4 poles, 2.5 mm <sup>2</sup>	By clip on a 35-mm DIN rail
100 W	270-420 V AC			
147 W	110-250 V AC	<70°C, except for the top protection grille	4 poles, 2.5 mm <sup>2</sup>	By clip on a 35-mm DIN rail
147 W	12-24 V DC			
177 W	230 V AC / 50-60 HZ	Max. 50°C in the enclosure, 100°C on the top protection grille, (for an ambient temperature of 20°C / 68°F)	2 poles, 2.5 mm <sup>2</sup>	By clip on a 35-mm DIN rail





Insulated PTC heater	Insulated ventilated PTC heaters
----------------------	----------------------------------

- |  |  |
|--|--|
| <ul style="list-style-type: none"> <li>■ Compact resistance heater preventing the formation of condensation or frost.</li> <li>■ Designed to ensure good natural convection and high thermal efficiency.</li> </ul> <p>Extruded aluminium body</p> <ul style="list-style-type: none"> <li>■ The heaters must be installed with a thermal controller (see selection table on pages 460 and 461) to control the temperature or the humidity inside the enclosure</li> <li>■ The enclosure must be sealed to prevent the entry of air from the outside</li> <li>■ An electrical protection device must be installed on the supply side of the unit</li> <li>■ <b>Operating position:</b> vertical</li> <li>■ <b>Operating temperature:</b> -40...+70°C; -10...+158°F</li> </ul> |  |
|--|--|

IP20	
VDE and UL	
Class II (double insulated)	

References		
NSYCR10WU2C	-	-
NSYCR10WU1C	-	-
NSYCR20WU2C	-	-
NSYCR20WU1C	-	-
-	NSYCR50WU2C	-
-	NSYCR50WU1C	-
-	NSYCR50WU3C	-
-	NSYCR100WU2C	-
-	NSYCR100WU1C	-
-	NSYCR100WU3C	-
-	NSYCR150WU2C	-
-	NSYCR150WU1C	-
-	-	NSYCR170W230VVC

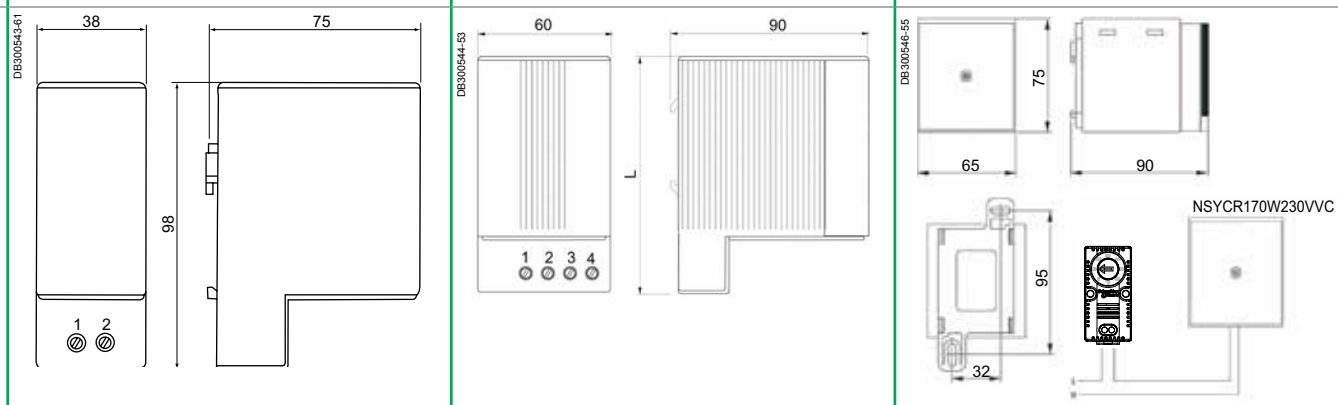

# Thermal management system

## Characteristics, selection guide

### Aluminium PTC heaters



Characteristics		Aluminium PTC heaters	Resistive heaters with fan
		<ul style="list-style-type: none"> <li>Extruded aluminium body.</li> <li>Surface temperature limited to 75°C when the ambient temperature is -5°C.</li> <li>Heaters equipped with a power cable with a length of 500 mm with silicon insulation, or with a connection terminal block.</li> </ul>	
Conditions of use		<ul style="list-style-type: none"> <li>The heaters must be installed with a thermal controller to control the temperature or the humidity inside the enclosure</li> <li>The enclosure must be sealed to prevent the entry of air from the outside</li> <li>An electrical protection device must be installed on the supply side of the unit</li> </ul>	
Power (W)	Voltage (V)	References	
Power cord			
10	12-24 DC	NSYCR10WU1	-
	110-250 AC	NSYCR10WU2	-
20	12-24 DC	NSYCR20WU1	-
	110-250 AC	NSYCR20WU2	-
Terminal block			
20	270-420 AC	NSYCR20WU3	-
55	12-24 DC	NSYCR55WU1	-
	110-250 AC	NSYCR55WU2	-
	270-420 AC	NSYCR55WU3	-
90	12-24 DC	NSYCR100WU1	-
	110-250 AC	NSYCR100WU2	-
	270-420 AC	NSYCR100WU3	-
150	12-24 DC	NSYCR150WU1	-
	110-250 AC	NSYCR150WU2	-
	270-420 AC	NSYCR150WU3	-
250	115 AC	-	NSYCR250W115VV
	230 AC	-	NSYCR250W230VV
400	115 AC	-	NSYCR400W115VV
	230 AC	-	NSYCR400W230VV
200	115 AC	-	NSYCRS200W115V
	230 AC	-	NSYCRS200W230V

### Thermofan



Characteristics		Thermofan
		<ul style="list-style-type: none"> <li>Combination of a resistance heater and an axial motor to ensure uniform heating of the enclosure.</li> <li>Mounting by clip on a DIN rail.</li> <li>Thermostat adjustable from 0...+60°C.</li> <li>Visual operation indicator.</li> </ul>
Power (W)	Voltage (V)	References
Terminal block		
400/550	120 AC	NSYCRP1W120VTVC
	230 AC	NSYCRP1W230VTVC

### Mounting accessories

Description	Supply	References
	Set of 5 studs	NSYCRAF
	Set of 5 studs and DIN rail	NSYCRAFD

### Thermal control

#### > Mechanical thermostats

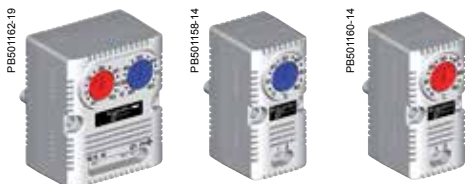

#### Mechanical and electronic thermostats

- Large range of temperature control.
- Small dimensions.
- Easily accessible terminals.

#### > Electronic thermostats



**New**

**LED screen**  
Screen visible even in the dark.



**New**

**New operational temperature range**  
-40°C ... +80°C.

### Mechanical and electronic thermostats



#### The new quick-mounting systems

- On 35 mm DIN rail.

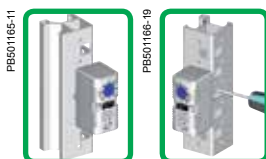

- On Spacial upright.



- On cross-rail.



- On mounting plate.



#### Certifications and declarations

- UL,
- CE.

### Mechanical thermostats

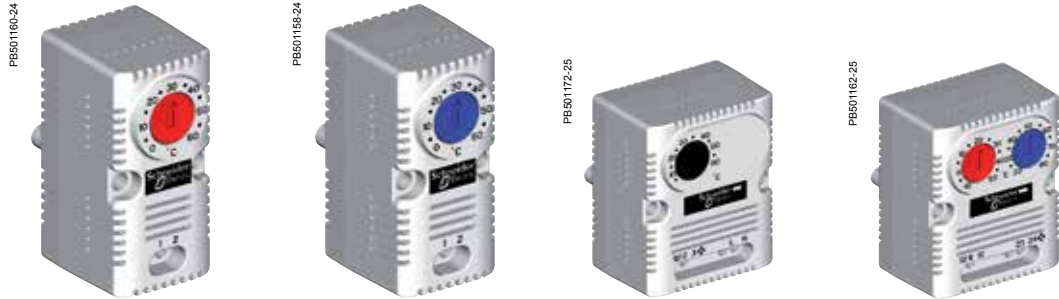

Characteristics	Thermostat With NC contact	Thermostat With NO contact	Thermostat With NO/NC contact	Double Thermostat
	<b>Thermostat with NC Contact:</b> ■ to control the stopping of a resistance heater when the temperature exceeds the displayed value. <b>Thermostat with NO Contact:</b> ■ to control the starting up of a fan when the temperature exceeds the displayed maximum value, ■ to control the temperature inside the enclosure by only starting up the fan when necessary, thus increasing the service life of the fan and reducing the clogging of the filter.			
Colour button	Red	Blue	Black	Red and blue
Ingress protection rating	IP20	IP20	IP20	IP20
Sensor element	Bimetal	Bimetal	Bimetal	Bimetal
Contact	NC, forced rupture	NO, forced rupture	Inverse, forced rupture	NO / NC, forced rupture
Contact resistance	< 10 mΩ	< 10 mΩ	< 10 mΩ	< 10 mΩ
Service life	> 100,000 cycles	> 100,000 cycles	> 100,000 cycles	> 100,000 cycles
Switching capacity	250 V AC; 10 A (resistive load) 120 V AC; 15 A (resistive load) 250 V AC/120 V AC 2 A (inductive load cos φ = 0.6) 30 W DC		250 V AC; 10 A (resistive load)	250 V AC; 10 A (resistive load) 120 V AC; 15 A (resistive load) 250 V AC/120 V AC 2 A (inductive load cos φ = 0.6) 30 W DC
Max interrupting capacity with direct current	NA	NA	250 V AC 4 A (inductive load cos φ = 0.6) 30 W DC	NA
Connection	Two 2.5 mm <sup>2</sup> terminals	Two 2.5 mm <sup>2</sup> terminals	Four 2.5 mm <sup>2</sup> terminals	Six 2.5 mm <sup>2</sup> terminals
Mounting	By clip on 35 mm DIN rail	By clip on 35 mm DIN rail	By clip on 35 mm DIN rail	Clip on 35 mm DIN rail
Enclosure	UL 94 V-0 plastic, light grey	UL 94 V-0 plastic, light grey	UL 94 V-0 plastic, light grey	UL 94 V-0 plastic, light grey
Dimensions	60 x 33 x 43 mm	60 x 33 x 43 mm	67 x 50 x 44 mm	60 x 33 x 43 mm
Weight	40 g	40 g	100 g	40 g
Mounting position	Indifferent	Indifferent	Indifferent	Indifferent
Operating temperature	-20...+80°C (-4...+176°F)	-20...+80°C (-4...+176°F)	-20...+80°C (-4...+176°F)	-20...+80°C (-4...+176°F)
Hysteresis	7°K	7°K	7°K	7°K
Temperature setting range	0...+60°C	0...+60°C	+5...+60°C	0...+60°C
Display	°C      °F	°C      °F	°C      °F	°C      °F
Max. command intensity	10 A 250 V		(NO) 5 A (NC) 10 A	(NO) 5 A (NC) 10 A

References	NSYCCOTHC	NSYCCOTHCF	NSYCCOTH0	NSYCCOTH0F	NSYCCOTH1	NSYCCOTH1F	NSYCCOTH2	NSYCCOTH2F
	<p>Load = resistance</p>	<p>Load = fan</p>	<p>Load = fan</p>	<p>Load = fan</p>	<p>Load (2): resistance Load (3): fan</p>	<p>Load (2): resistance Load (3): fan</p>	<p>Load (2): resistance Load (3): fan</p>	<p>Load (2): resistance Load (3): fan</p>

New

### Electronic thermostats



Characteristics	Electronic thermostat	Electronic hygrotherm	Electronic hygostat
	<b>With LED screen</b> Electronic temperature controller.	<b>With LED screen</b> Electronic temperature and humidity controller.	<b>With LED screen</b> Electronic humidity controller.
Ingress protection rating	IP20	IP20	IP20
Certification	UL / UR	UL / UR	UL / UR
Internal sensor element	Temperature sensor	Temperature sensor and humidity sensor	Humidity sensor
Contact	Free with zero potential	Free with zero potential	Free with zero potential
Connection	2 x 2.5 mm <sup>2</sup> (input voltage) + 2 relays (2 x 2.5 mm <sup>2</sup> + 2 x 2.5 mm <sup>2</sup> )	2 x 2.5 mm <sup>2</sup> (input voltage) + 2 relays (2 x 2.5 mm <sup>2</sup> + 2 x 2.5 mm <sup>2</sup> )	2 x 2.5 mm <sup>2</sup> (input voltage) + 1 relay (2 x 2.5 mm <sup>2</sup> )
Mounting	4 different methods: by DIN rail, Spacial SF profile, on VDI cross-rail or on mounting plate	4 different methods: by DIN rail, Spacial SF profile, on VDI cross-rail or on mounting plate	4 different methods: by DIN rail, Spacial SF profile, on VDI cross-rail or on mounting plate
Enclosure	UL 94 V-0 plastic, light grey	UL 94 V-0 plastic, light grey	UL 94 V-0 plastic, light grey
Operating temperature	-40°C...+80°C	-40°C...+80°C	-40°C...+80°C
Hysteresis	Programmed 2°K	3 %	3 %
Temperature setting range	-40°C...+80°C	-40°C...+80°C	-
Humidity setting range	-	20 %...80 %	20 %...80 %
Display	°C or °F	°C or °F or % RH	% RH
Max. command intensity	8 (5) A 230 V AC / 5 A 30 V DC	8 (5) A 230 V AC / 5 A 30 V DC	8 (5) A 230 V AC / 5 A 30 V DC
<b>Voltage (type of current)</b>	<b>References</b>		
9-30 V (AC/DC)	<b>NSYCCOTH30VID</b>	<b>NSYCCOHT30VID</b>	<b>NSYCCOHY30VID</b>
110-127 V (AC)	<b>NSYCCOTH120VID</b>	<b>NSYCCOHT120VID</b>	<b>NSYCCOHY120VID</b>
220-240 V (AC)	<b>NSYCCOTH230VID</b>	<b>NSYCCOHT230VID</b>	<b>NSYCCOHY230VID</b>

## Sensors



Characteristics		Smoke detector	Vibration sensor	Movement sensor
		Visible smoke detector with VdS approval for rapid fire detection, even with light smoke. ■ Usable in temperature range: from -20 to +60°C.	Detects movements and vibrations of varying intensity. Adjustable sensitivity.	Indicates movements in the area by infrared system. Adjustable sensitivity. Anti-sabotage protection.
Ingress protection rating		-	-	-
Mounting		-	-	-
Supply		With mountings	With mountings	With mountings
Length of cable supplied (m)	Maximum cable length (m)	References		
3	-	-	-	-
4	20	<b>NSY11954</b>	<b>NSY11956</b>	<b>NSY11958</b>
5	-	-	-	-
10	-	-	-	-
15	-	-	-	-
20	-	-	-	-

### Sensors



	Extension cables	Temperature sensor	Humidity sensor	Combined temperature/humidity sensor	External temperature sensor (double insulation)
	4 strand cable for sensors. ■ Four lengths available: 5, 10, 15 and 20 metres. ■ Connections: RJ11.	■ Temperature value range: 0°... +60°. ■ Measurement accuracy: ± 1°C.	■ Humidity value range: 10... 90 % relative humidity between 0° and +60°. ■ Measurement accuracy: ± 3 % relative humidity.	Combines temperature and air humidity sensor functions. ■ Temperature value range: 0°... +60°. ■ Measurement accuracy: ± 1°C. ■ Humidity value range: 10... 90 % relative humidity between 0° and +60°. ■ Measurement accuracy: ± 3 % relative humidity.	■ Sensor operation or reading range: -40°C...+150°C. <b>Thermostat installation tips:</b> the thermostat should be installed at the top of the enclosure (the hottest place). See the various operating modes of each thermostat to choose the one that best meets your needs. <b>Hygrostat installation tips:</b> the hygrostat should be installed at the bottom of the enclosure. 60% RH is the optimum value in the enclosure.
	-	-	-	-	IP67
	-	-	-	-	Several types of mountings (on DIN rail, on Spacial SF profile, on VDI cross-rail, on mounting plate)
	-	With mountings	With mountings	With mountings	-
	-	-	-	-	<b>NSYCCASTE</b>
	-	<b>NSY11951</b>	<b>NSY11952</b>	<b>NSY11953</b>	-
	<b>NSY11959</b>	-	-	-	-
	<b>NSY11960</b>	-	-	-	-
	<b>NSY11961</b>	-	-	-	-
	<b>NSY11962</b>	-	-	-	-

PE801177



### Thermal control

#### Enclosures Monitor

- The enclosure monitor checks and protects all the equipment in the distribution, network and server racks as well as their environment.
- Ambient parameters and operating states can be measured using various sensors and several inputs.
- Signalling and display: on the unit, serial interface, Ethernet network.
- Digital inputs and switching outputs enable permanent monitoring and adapted actions.

#### Reference

**NSY11950**

Possibilities for connection to the enclosure monitor:

- 4 sensors ref. **NSY11951**, **NSY11952** and/or **NSY11953**.
- 4 sensors ref. **NSY11954** or **NSY11956**.
- 8 insulated digital inputs (free potential).
- 2 digital inputs.
- 1 series input used for monitoring devices with a communication protocol.

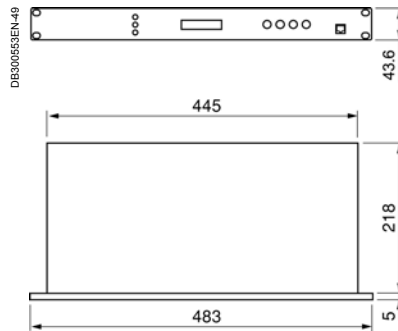

#### Connections and cabling diagram

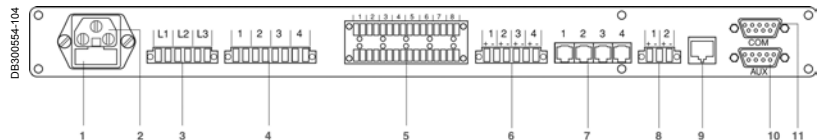

- 1 Contact pin circuit breaker.
- 2 Connection to the network.
- 3 Connection of phase surveillance.
- 4 Digital switching outputs.
- 5 Digital inputs (ref. **NSY11955** and **NSY11958**).
- 6 Alarm inputs (ref. **NSY11954** and **NSY11956**).
- 7 Connection of a sensor, references **NSY11951**, **NSY11952** and **NSY11953**.
- 8 Connection of uninterruptible power supply.
- 9 Connection to Ethernet network RJ45.
- 10 Series interface for external devices.
- 11 Series interface for connection to a terminal.

PE801178

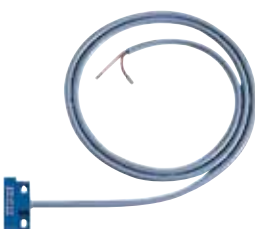

#### Door contact

Monitors door access by means of a magnetic sensor that reacts to any material conducting magnetic flow.

- **Length of cable supplied:** 4 m.
- **Maximum cable length:** 20 m.
- **Supply:** with mountings.

#### Reference

**NSY11955**



The miniaturisation of components, the generalisation of electronics and the appearance of new electronically powered products have made temperature management into a need which must necessarily be considered when designing electrical and/or electronic switchboards, in the same way as the protection rating. Reliability and the search for lower breakdown rates are two determining factors in process industries, where the cost per hour is extremely high. The smallest failure can instantly result in considerable losses. The service life of the components also depends on the temperature and humidity conditions inside the enclosure. The ideal values are +25...+35°C for the temperature and 60 % for the relative humidity (RH).

Various solutions to these problems have been put forward. They will be chosen according to environmental conditions, the type of components in the industrial control panel, and their cost.

In certain cases, all it takes it to oversize the enclosures or use fans. In other cases, when the temperature is higher, it becomes necessary to install air-water exchangers or air coolers operating according to the principle of refrigeration (cooling units). We offer you a range of solutions that adapt to every possible scenario: from the enclosure itself to ventilation systems, resistances or exchangers, and even cooling units.

### Natural dissipation

#### Through the walls of the enclosure

The use of a larger enclosure can, in certain cases, solve your heating problem.

### Airing

#### Natural ventilation

The addition of fresh air from the outside through ventilation louvres improves the dissipation of heat by natural convection. However, this solution can only be used to dissipate small power levels and in environments with a small amount of dust.

### Ventilating

#### Circulation

Air circulation inside the enclosure with the help of a fan makes it possible to guarantee an even temperature, avoiding hot spots that can damage certain components.

#### Forced ventilation

The fans are designed to evacuate a considerable amount of heat coming from the components of the industrial control panels. The service life of the latter is considerably extended, thus guaranteeing the long life and correct operation of the installation.

The fans can only be used if the ambient temperature is at least 5°C lower than the desired temperature inside the enclosure.

They offer an efficient solution, one that is easy to implement and maintain, which is also inexpensive, to the problem of temperature increases in the industrial control panels. Thanks to their standard IP54 (IP55 with accessories) they are suitable for use in industrial and tertiary sectors.

### Heating

#### Resistance heaters

Resistance heaters can be used for two reasons:

- To reheat the industrial control panel when the ambient temperature is too low for the correct operation of the components.
- To prevent the formation of condensation.

The second phenomenon can cause short-circuits, premature oxidation of the contacts, corrosion of metal parts and, in particular, of the enclosure, a considerable reduction in the service life of the electrical and electronic components.

Condensation occurs when the temperature suddenly drops below the dew point temperature. To avoid this, it is simply necessary to maintain the temperature inside the enclosure at a few degrees above the ambient temperature of the environment. Thanks to their design, the heaters encourage natural convection and guarantee quick and even heating within the enclosure.

DB300447-20



DB300453-18



DB300448-68



DB300453-18



DB300452-68



DB300453-18



### Cooling

#### Air-air exchangers

Air-air exchangers are devices that combine efficiency and simplicity. The hot air flows of the enclosure and the cold of the surrounding environment, created by two fans, circulate on either side of hermetic separation walls, preventing the penetration of dust or moisture in the enclosure. The hot air from the switchboard reheats these walls, which in turn are cooled by the fresh air from outside. The transfer always takes place from the hotter side to the cooler side. This is why these devices can only be used if the ambient temperature is at least 5°C lower than the desired temperature inside the enclosure.

The aluminium exchange cassette forms the core of the system. This element can be cleaned easily by simply removing it. In addition, the permanent operation of the internal fan prevents the appearance of hot spots in the industrial control panel. The temperature regulation system integrated in the unit turns the external circuit fan on and off.

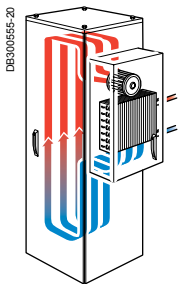
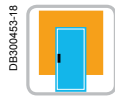
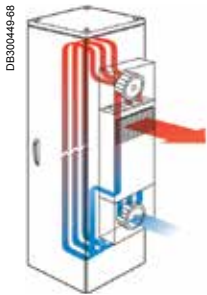

#### Air-water exchangers

Air-water exchangers operate on the same principle as air-air exchangers. Fresh air from the outside is replaced with cold water supplied by a network installed on the industrial site. This change of fluid makes it possible to evacuate much larger amounts of heat and, possibly, to reduce the temperature in the enclosure below the temperature of the ambient air.

Temperature control in the enclosure is carried out by modulating the water flow. The water circuit is protected by a shut-off device: your electrical installation is safe.

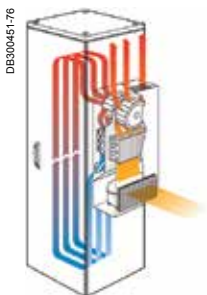



#### Cooling units

Cooling units can be used in the harshest environments, where the temperature can reach 55°C. These devices are especially recommended when the desired temperature inside the enclosure must be lower than the ambient temperature or when a large amount of heat needs to be evacuated. As in the case of the exchangers, they do not affect the IP of the switchboard.

The filter, placed at the inlet of the external air circuit, allows it to operate even when the ambient air is charged with dust or oil particles. Easily replaceable and quite inexpensive, this device guarantees the efficiency of the device throughout its service life. These devices control the temperature inside the enclosure and include an alarm function for signalling operational anomalies.



 The ambient temperature is higher than the desired temperature inside the enclosure.

 The ambient temperature is lower than the desired temperature inside the enclosure.

The ProClima calculation software, available on our website, is an indispensable tool for the selection of a thermal auxiliary.

### Method of determining the thermal solution

The heat balance, which consists of comparing the power released by the devices with the power exchanged spontaneously through the wall of the enclosure, allows us to calculate the internal temperature obtained in the enclosure, with no thermal accessories, and thus to determine whether it is necessary to install any, bearing in mind the desired internal and external temperatures.

Below we have presented a simple method for implementing this choice.

#### 1 - Characteristics of the enclosure

Position of the enclosure	Location according to IEC 890 ratio	Formula for calculating S (m <sup>2</sup> )
	Accessible from every side	$S = 1.8 \times H \times (W + D) + 1.4 \times W \times D$
	Placed against a wall	$S = 1.4 \times W \times (H + D) + 1.8 \times D \times H$
	On the end when suited	$S = 1.4 \times D \times (H + W) + 1.8 \times W \times H$
	On the end when suited, placed against a wall	$S = 1.4 \times H \times (W + D) + 1.4 \times W \times D$
	In the middle when suited	$S = 1.8 \times W \times H + 1.4 \times W \times D + D \times H$
	In the middle when suited, placed against a wall	$S = 1.4 \times W \times (H + D) + D \times H$
	In the middle when suited, placed against a wall with the top covered	$S = 1.4 \times W \times H + 0.7 \times W \times D + D \times H$
		<b>S =</b> <input type="text" value=""/> <b>m<sup>2</sup></b>

H = Height - W = Width - D = Depth

**Example**  
 Spatial reference NSYSF20840  
 H = 2000  
 W = 800  
 D = 400  
 Installation method:  
 Suitable enclosure placed against a wall.

**S = 4.43 m<sup>2</sup>**

#### 2 - Thermal power dissipated by the operational components

Calculated as the sum of the power dissipated by each of the installed components. If these are not known, use the ProClima software and page 472, which shows the average values.

**Pd =**  **W**

Assume that the switchgear dissipates 800 W.

**Pd = 800 W**

#### 3 - Characteristics of the environment air

Maximum ambient temperature. **Te<sub>max</sub> =**  **°C**  
 Minimum ambient temperature. **Te<sub>min</sub> =**  **°C**  
 Average relative humidity. **RH =**  **%**  
 Dew point temperature. Useful to avoid condensation and to calculate resistance heater power. **Dp =**  **°C**

The temperature conditions are as follows:

**Te<sub>max</sub> = 35°C**  
**Te<sub>min</sub> = 15°C**  
**RH = 70 %**  
**Dp = 29°C**

#### 4 - Average desired internal temperatures

They are defined by the nature of the components and the characteristics of the environment air

Maximum internal temperature **Tid<sub>max</sub> =**  **°C**  
 Minimum internal temperature (maximum value between the dew point temperature and the minimum operating temperature of the devices) **Tid<sub>min</sub> =**  **°C**

**Tid<sub>max</sub> = 40°C**  
**Tid<sub>min</sub> = 29°C**

#### 5 - Final temperature inside the enclosure with no thermal system

Max. internal temperature:  $T_{fi_{max}} = \frac{Pd}{K \times S} + Te_{max}$  **Tfi<sub>max</sub> =**  **°C**  
 Min. internal temperature:  $T_{fi_{min}} = \frac{Pd}{K \times S} + Te_{min}$  **Tfi<sub>min</sub> =**  **°C**  
 or K = 5.5 W/m<sup>2</sup>/°C for an enclosure made of painted sheet steel  
 K = 3.5 W/m<sup>2</sup>/°C for a polyester enclosure  
 K = 3.7 W/m<sup>2</sup>/°C for a stainless-steel enclosure  
 K = 12 W/m<sup>2</sup>/°C for an aluminium enclosure

**Tfi<sub>max</sub> = 70°C**  
**Tfi<sub>min</sub> = 50°C**

### 6 - Determining the type of thermal device and its power: Psyst

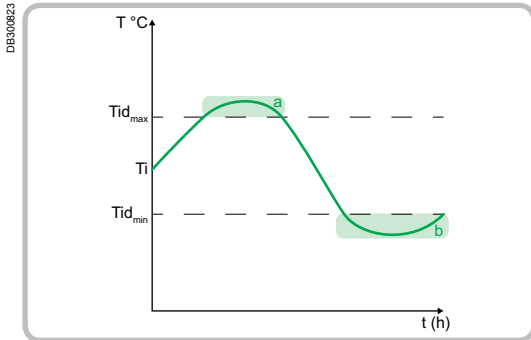

- a:**  
 $Tid_{max} < Ti_{max}$   
 $\Delta T_{min} = (Tid_{max} - Te_{max})$   
 ■  $\Delta T_{min} = +5^{\circ}C$ : Ventilation  
 ■  $\Delta T_{min} = +10^{\circ}C$ : Exchanger air-air  
 ■  $\Delta T_{min} = -5^{\circ}C$ : Cooling unit  
 ■ Not depending on  $(\Delta T_{min})$ : Exchanger air-water
- b:**  
 $Tid_{min} > Ti_{min}$ : Heaters

If $Tid_{min} < Tfl_{min}$	If $Tid_{min} > Tfl_{min}$	If $Tid_{max} < Tfl_{max}$	If $Tid_{max} > Tfl_{max}$
▼	▼	▼	▼
No need for a thermal system; a circulation fan may be used to even out the temperature.	Need for a thermal system: resistance heater 1- Permanent operation of the switchboard <b><math>Psyst = K \times S (Tid_{min} - Te_{min}) - Pd</math></b> 2- Discontinuous operation <b><math>Psyst = K \times S (Tid_{min} - Te_{min})</math></b>	Need for a thermal system: ventilation, fan, exchanger, cooling unit. <b><math>Psyst = Pd - K \times S (Tid_{max} - Te_{max})</math></b> <b><math>Psyst = 800 - 5.5 \times 4.13 \times (40 - 35) \sim 690 W</math></b>	No need for a thermal system; a circulation fan may be used to even out the temperature.

Temperature conditions	Solution	Advantages	Constraints
<b>Circulating</b>			
Avoid hot spots.	Install circulation fans in the enclosure.	Highly economical solution requiring no maintenance, easy to install; Installation IP conserved.	The amount of heat evacuated is relatively low.
<b>Cooling</b>			
Final temperature $Tid_{max}$ desired in the enclosure at least $5^{\circ}C$ higher than the ambient temperature $Te_{max}$ . <b><math>Tid_{max} \geq Te_{max} + 5^{\circ}C</math></b>	Oversize the enclosure or the wall-mounting enclosure. Install ventilation louvres. Install fans for introducing fresh air. $\varnothing = \frac{Psyst}{(Tid_{max} - Te_{max})} \times 3.1 \text{ (m}^3\text{/h)}$ Use an air-air exchanger. $\varnothing = \frac{Psyst}{(Tid_{max} - Te_{max})} \text{ (W/K)}$	Economical solution requiring no maintenance, easy to install; Installation IP conserved. Highly economical solution requiring no maintenance, easy to install. Economical solution, easy to install; large amount of heat evacuated; possible temperature control. Easy to install; IP conserved during installation; temperature control as standard; easy maintenance.	The amount of heat evacuated is relatively low, larger dimensions. The amount of heat evacuated is low, it depends on the layout of the components, reduced IP (entry of dust). Regular filter maintenance. IP slightly reduced.
Final temperature $Tid_{max}$ desired in the enclosure lower than the ambient temperature $Te_{max} + 5^{\circ}C$ . <b><math>Tid_{max} \geq Te_{max} + 5^{\circ}C</math></b>	Use a cooling unit. Use an air-water exchanger.	Easy to install; allows the evacuation of large amounts of heat, even when the ambient temperature is high, IP conserved during installation, temperature control. Easy to install; allows the evacuation of large amounts of heat, even when the ambient temperature is high, IP conserved during installation, temperature control, no filter to maintain.	Regular filter maintenance, cannot be used beyond an ambient temperature of $55^{\circ}C$ . Needs a water circuit; consumption if supplied by the water mains.
<b>Heating</b>			
Outside temperature lower than the lowest acceptable ambient temperature for the switchgear. Risk of condensation.	Heat using a resistance heater. Heat using a resistance heater in order to maintain the temperature beyond the dew point temperature.	Economical, reliable; see temperature in the table. Economical, reliable; the humidity in the switchboard can be regulated.	Energy consumption; space taken up in the enclosure. Energy consumption; space taken up in the enclosure.

## ProClima

### New ProClima software

- Software package for calculating and selecting the thermal accessories required for enclosures containing electrical and electronic equipment.
- Performs the calculations as well as the corrected surfaces, according to the dimensions of the enclosure and its position in relation to the walls.
- Available for download on our homepage.

### Data entry

The following steps must be followed to conduct this study:

PB50001-56



PB501164



**1** - Enter the project and customer data (optional).

PB501165

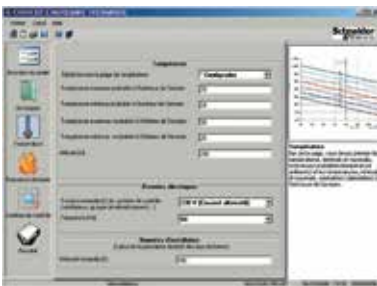

**2** - Enter the internal and external temperature data for the enclosure (compulsory).

PB501186



**3** - Enter the electrical data for the installation (voltage, rating, etc.) (compulsory).

PB501167



**4** - Determine the power dissipated by the electrical equipment inside the enclosure (compulsory).

If this value is not known, the software can calculate it:

- Based on the electrical or electronic switchgear that make up the switchboard (type and number),
- Based on a temperature reading.

## ProClima

### Results

#### Summary of the heat balance

The software offers to print the project summary containing the calculation values, the results obtained and the thermal accessories recommended for maintaining the internal temperature of the enclosure in the specified conditions. In addition, the summary specifies the power, characteristics and reference of the device, as well as any related accessories.



**5** - Select the enclosure and the installation method (compulsory).



**6** - Select the thermal management system (fans, exchangers, etc.) (compulsory).



**7** - View and print the project summary.

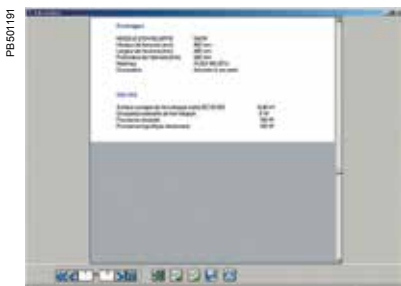

### Data

■ **Enclosure data**

- Height: 2000 mm
- Width: 800 mm
- Depth: 500 mm

■ **Location:** placed on the wall

■ **Material:** painted sheet-steel enclosure

■ **Thermal power dissipated by the operational components** Pd: 950 W

■ **Information on temperature and the environment:**

Maximum desired temperature inside the enclosure  $T_{e_{max}}$ : 25°C

Minimum desired temperature inside the enclosure  $T_{e_{min}}$ : 25°C

Maximum temperature dissipated in the enclosure  $T_{e_{max}}$ : 35°C

Minimum temperature dissipated in the enclosure  $T_{e_{min}}$ : 25°C

■ **Environment:** low pollution and low dust level

### Selection and calculation

The desired maximum temperature inside ( $T_{s_{max}}$ ) the enclosure is 10°C higher than the maximum value expected for the outside ( $T_{i_{max}}$ ).

It is possible to cool the enclosure using the filtered ventilation systems.

### Calculation of the required fan (1)

Usage formulas:

$$P_{syst} = Pd - K \times S \times (T_{s_{max}} - T_{e_{max}})$$

$$Flow = f \times P_{syst} / (T_{s_{max}} - T_{e_{max}})$$

**In order to make the calculation, it is necessary to know the height above sea level of the installation location:**

Height above sea level: 800 m

(1)  $P_d$  = Thermal power dissipated by the operational components

$$S = 1.4 \times W \times (H + D) + 1.8 \times D \times H = 4.6 \text{ m}^2.$$

According to standard IEC 890

**K** = Constant defined by the material used to manufacture the enclosure

$K = 5.5 \text{ W/m}^2 \times \text{°C}$  for a solid sheet-steel enclosure

$K = 3.5 \text{ W/m}^2 \times \text{°C}$  for a polyester enclosure

$K = 3.7 \text{ W/m}^2 \times \text{°C}$  for a stainless-steel enclosure

**f** = Coefficient relating to the height above sea level (value)

0 to 100 m:  $f = 3.1$

100 to 250 m:  $f = 3.2$

250 to 500 m:  $f = 3.3$

500 to 750 m:  $f = 3.4$

750 to 1000 m:  $f = 3.5$

...



### Our example

$$P_{syst} = 950 - 5.5 \times 4.6 \times (35 - 25) = 697 \text{ W}$$

$$Flow \text{ rate} = 3.5 \times 697 / (35 - 25) = 244 \text{ m}^3/\text{h}$$

**Selection from the fan quick-selection table:**

**1 fan with standard filter ref. NSYCVF300M230PF**

**+ 1 grille with standard filter ref. NSYCAG223LPPF**

**+ 1 thermostat ref. NSYCCOTHO enable a flow rate of 302 m<sup>3</sup>/h**

The minimum outside temperature is lower than the desired minimum temperature inside the enclosure.

**It is necessary to install resistance heaters:**

**Calculation of the useful resistance heater**

Usage formula:  $W = K \times S \times (T_{s_{min}} - T_{e_{min}})$

**Our example:  $W = 5.5 \times 4.6 (15 - 10) = 127 \text{ W}$**

**Selection from the selection guide of the resistance heaters:**

**1 resistance heater ref. NSYCR150WU2C**

**+ 1 thermostat ref. NSYCCOTHC**

### Spacial wall-mounting enclosures

Installation mode										
H (mm)	W (mm)	D (mm)	1	2	3	4	5	6	7	
300	200	150	0.23	0.21	0.21	0.19	0.20	0.17	0.15	
		150	0.28	0.24	0.25	0.22	0.23	0.20	0.18	
	300	150	0.31	0.27	0.29	0.25	0.27	0.23	0.20	
		200	0.35	0.32	0.33	0.29	0.31	0.27	0.23	
	400	150	0.38	0.33	0.36	0.32	0.35	0.30	0.26	
		200	0.41	0.39	0.41	0.36	0.39	0.34	0.28	
400	300	150	0.39	0.34	0.36	0.32	0.34	0.29	0.26	
		200	0.44	0.40	0.41	0.36	0.38	0.33	0.29	
	400	200	0.54	0.48	0.51	0.45	0.48	0.42	0.36	
		200	0.74	0.65	0.71	0.62	0.68	0.58	0.50	
	250		0.82	0.73	0.78	0.69	0.74	0.65	0.54	
			0.85	0.75	0.80	0.70	0.75	0.65	0.56	
500	300	200	0.53	0.47	0.49	0.43	0.45	0.39	0.35	
		200	0.65	0.57	0.61	0.53	0.57	0.49	0.44	
	250		0.73	0.65	0.68	0.60	0.63	0.55	0.48	
			0.77	0.67	0.73	0.63	0.69	0.59	0.52	
	250		0.85	0.75	0.80	0.70	0.75	0.65	0.56	
			0.85	0.75	0.80	0.70	0.75	0.65	0.56	
600	400	200	0.76	0.66	0.71	0.62	0.66	0.57	0.51	
		250	0.84	0.75	0.78	0.69	0.72	0.63	0.56	
	500	250	1.02	0.87	0.93	0.81	0.87	0.75	0.66	
		200	1.03	0.89	0.98	0.84	0.94	0.79	0.71	
	250		1.13	0.98	1.07	0.92	1.01	0.86	0.76	
			1.22	1.08	1.15	1.01	1.08	0.94	0.81	
	400		1.42	1.27	1.32	1.18	1.22	1.08	0.91	
			1.52	1.33	1.45	1.26	1.38	1.19	1.02	
	800		1.12	0.98	1.05	0.91	0.98	0.84	0.75	
			1.12	0.98	1.05	0.91	0.98	0.84	0.75	
800	600	200	1.32	1.13	1.26	1.06	1.19	1.00	0.92	
		250	1.43	1.24	1.35	1.16	1.27	1.08	0.98	
		300	1.55	1.36	1.45	1.26	1.36	1.16	1.04	
		400	1.78	1.58	1.65	1.46	1.52	1.33	1.16	
	800	250	1.79	1.54	1.71	1.46	1.63	1.38	1.24	
		300	1.92	1.66	1.82	1.57	1.73	1.47	1.30	
	1000	300	2.29	1.97	2.20	1.88	2.10	1.78	1.57	
		300	2.50	2.28	2.57	2.18	2.47	2.09	1.84	
	1000	600	250	1.74	1.50	1.64	1.40	1.54	1.30	1.19
			300	2.04	1.63	1.75	1.51	1.63	1.39	1.27
400			2.14	1.90	1.98	1.74	1.82	1.58	1.41	
800		250	2.17	1.85	2.07	1.75	1.97	1.65	1.51	
		300	2.32	2.00	2.20	1.88	2.08	1.76	1.59	
400			2.61	2.29	2.45	2.13	2.29	1.97	1.74	
			2.76	2.36	2.64	2.24	2.52	2.12	1.91	
1000		300	3.20	2.72	3.08	2.60	2.96	2.48	2.23	
		400	3.44	3.07	3.39	2.91	3.23	2.75	2.42	
1200		600	300	2.45	1.91	2.05	1.76	1.91	1.62	1.49
	400		2.83	2.21	2.30	2.02	2.11	1.82	1.66	
	800	300	2.71	2.33	2.57	2.18	2.42	2.04	1.87	
		400	3.04	2.66	2.85	2.46	2.66	2.27	2.05	
	1000	300	3.23	2.75	3.08	2.60	2.94	2.46	2.25	
		400	3.70	3.10	3.39	2.91	3.20	2.72	2.44	
1200	300	3.74	3.17	3.60	3.02	3.46	2.88	2.63		
	300	3.86	3.14	3.53	2.97	3.36	2.80	2.59		



Use ProClima to save time and find the best solution!







**Installation mode**

- 1 Accessible from every side
- 2 Placed against a wall
- 3 On the end when suited
- 4 On the end when suited, placed against a wall
- 5 In the middle when suited
- 6 In the middle when suited, placed against a wall
- 7 In the middle when suited, placed against a wall with the top covered







The surfaces are given in m<sup>2</sup>.



### THALASSA wall-mounting enclosures

Installation mode									
H (mm)	W (mm)	D (mm)	1 	2 	3 	4 	5 	6 	7 
310	215	160	0.26	0.23	0.24	0.21	0.22	0.19	0.17
307	255	164	0.29	0.26	0.27	0.24	0.25	0.22	0.19
430	330	200	0.50	0.45	0.47	0.41	0.43	0.38	0.33
530	430	200	0.72	0.63	0.68	0.59	0.64	0.55	0.49
645	435	250	0.95	0.84	0.88	0.77	0.82	0.71	0.63
745	535	300	1.34	1.19	1.26	1.10	1.17	1.01	0.89
845	635	300	1.69	1.47	1.59	1.37	1.49	1.27	1.14
1055	850	350	2.70	2.34	2.55	2.19	2.40	2.04	1.83

### THALASSA floor-standing enclosures

Installation mode									
H (mm)	W (mm)	D (mm)	1 	2 	3 	4 	5 	6 	7 
500	500	320	0.96	0.86	0.90	0.80	0.83	0.73	0.62
		420	1.12	1.02	1.04	0.94	0.95	0.85	0.71
	750	320	1.30	1.15	1.24	1.09	1.17	1.02	0.85
		420	1.49	1.34	1.41	1.26	1.33	1.18	0.96
	1000	320	1.64	1.44	1.57	1.37	1.51	1.31	1.08
		420	1.87	1.67	1.78	1.58	1.70	1.50	1.20
750	500	320	1.97	1.72	1.91	1.66	1.85	1.60	1.32
		420	2.24	1.99	2.15	1.90	2.07	1.82	1.45
	750	320	1.33	1.18	1.24	1.09	1.14	0.99	0.88
		420	1.54	1.39	1.41	1.26	1.28	1.13	0.99
	1000	320	1.78	1.56	1.68	1.46	1.59	1.36	1.20
		420	2.02	1.80	1.89	1.67	1.77	1.54	1.32
1000	500	320	2.23	1.93	2.13	1.83	2.04	1.74	1.51
		420	2.51	2.21	2.38	2.08	2.25	1.95	1.66
	750	320	2.68	2.30	2.58	2.21	2.49	2.11	1.83
		420	2.99	2.61	2.86	2.49	2.74	2.36	2.00
	1000	320	1.70	1.50	1.57	1.37	1.44	1.24	1.13
		420	1.95	1.75	1.78	1.58	1.61	1.41	1.27
1250	500	320	2.26	1.96	2.13	1.83	2.01	1.71	1.54
		420	2.55	2.25	2.38	2.08	2.21	1.91	1.69
	750	320	2.82	2.42	2.70	2.30	2.57	2.17	1.94
		420	3.14	2.74	2.98	2.58	2.81	2.41	2.11
	1000	320	3.39	2.89	3.26	2.76	3.13	2.63	2.35
		420	3.74	3.24	3.57	3.07	3.41	2.91	2.54
1500	500	320	2.07	1.82	1.91	1.66	1.75	1.50	1.39
		420	2.36	2.11	2.15	1.90	1.94	1.69	1.55
	750	320	2.74	2.37	2.58	2.21	2.42	2.05	1.88
		420	3.07	2.70	2.86	2.49	2.65	2.28	2.06
	1000	320	3.42	2.92	3.26	2.76	3.10	2.60	2.37
		420	3.78	3.28	3.57	3.07	3.36	2.86	2.57
1750	500	320	4.09	3.47	3.93	3.31	3.77	3.15	2.87
		420	4.49	3.87	4.28	3.66	4.07	3.45	3.08
	750	320	2.44	2.14	2.25	1.95	2.05	1.75	1.64
		420	2.78	2.48	2.53	2.23	2.27	1.97	1.83
	1000	320	3.23	2.78	3.03	2.58	2.84	2.39	2.22
		420	3.60	3.15	3.35	2.90	3.10	2.65	2.43
1250	320	4.01	3.41	3.82	3.22	3.63	3.03	2.80	
	420	4.42	3.82	4.17	3.57	3.92	3.32	3.02	
1500	320	4.80	4.05	4.61	3.86	4.42	3.67	3.39	
	420	5.24	4.49	4.99	4.24	4.74	3.99	3.62	

### Spacial floor-standing enclosures

Installation mode										
H (mm)	W (mm)	D (mm)	1	2	3	4	5	6	7	
1200	800	300	2.71	2.33	2.57	2.18	2.42	2.04	1.87	
		1000	3.23	2.75	3.08	2.60	2.94	2.46	2.25	
	1200	400	4.13	3.55	3.94	3.36	3.74	3.17	2.83	
1400	600	300	2.52	2.18	2.35	2.02	2.18	1.85	1.72	
		400	2.86	2.52	2.63	2.30	2.41	2.07	1.90	
	800	300	3.11	2.66	2.94	2.49	2.77	2.32	2.16	
		400	3.47	3.02	3.25	2.80	3.02	2.58	2.35	
	1000	400	4.09	3.53	3.86	3.30	3.64	3.08	2.80	
	1200	400	4.70	4.03	4.48	3.81	4.26	3.58	3.25	
1600	600	300	2.84	2.46	2.65	2.27	2.46	2.08	1.95	
		400	3.22	2.83	2.96	2.58	2.70	2.32	2.15	
	800	300	3.50	2.99	3.31	2.80	3.12	2.61	2.44	
		400	3.90	3.39	3.65	3.14	3.39	2.88	2.66	
	1000	300	4.16	3.52	3.97	3.33	3.78	3.14	2.93	
	400	4.59	3.95	4.34	3.70	4.08	3.44	3.16		
	1200	300	4.82	4.06	4.63	3.86	4.44	3.67	3.42	
		400	5.28	4.51	5.02	4.26	4.77	4.00	3.66	
	1800	600	300	3.17	2.74	2.95	2.52	2.74	2.30	2.18
			400	3.58	3.14	3.29	2.86	3.00	2.57	2.40
			500	3.98	3.55	3.62	3.19	3.26	2.83	2.62
		800	300	3.90	3.32	3.68	3.11	3.47	2.89	2.72
400			4.34	3.76	4.05	3.47	3.76	3.18	2.96	
500			4.77	4.20	4.41	3.84	4.05	3.48	3.20	
1000		600	5.21	4.63	4.78	4.20	4.34	3.77	3.43	
		400	5.10	4.38	4.81	4.09	4.52	3.80	3.52	
1200		500	5.56	4.84	5.20	4.48	4.84	4.12	3.77	
		400	5.86	4.99	5.57	4.70	5.28	4.42	4.08	
1600		500	6.35	5.48	5.99	5.12	5.63	4.76	4.34	
		400	7.38	6.22	7.09	5.94	6.80	5.65	5.20	
2000	600	500	7.92	6.77	7.56	6.41	7.20	6.05	5.49	
		300	3.49	3.01	3.25	2.77	3.01	2.53	2.41	
400		3.94	3.46	3.62	3.14	3.30	2.82	2.65		
800	500	300	4.38	3.90	3.98	3.50	3.58	3.10	2.89	
		400	4.77	4.13	4.45	3.81	4.13	3.49	3.26	
		500	5.24	4.60	4.84	4.20	4.44	3.80	3.52	
	600	5.71	5.07	5.23	4.59	4.75	4.11	3.78		
		400	5.60	4.80	5.28	4.48	4.96	4.16	3.88	
	1000	500	6.10	5.30	5.70	4.90	5.30	4.50	4.15	
400		6.43	5.47	6.11	5.15	5.79	4.83	4.50		
1200	500	6.96	6.00	6.56	5.60	6.16	5.20	4.78		
	600	7.49	6.53	7.01	6.05	6.53	5.57	5.06		
	400	8.10	6.82	7.78	6.50	7.46	6.18	5.73		
1600	500	8.68	7.40	8.28	7.00	7.88	6.60	6.04		
	600	9.26	7.98	8.78	7.50	8.30	7.02	6.35		



Use ProClima to save time and find the best solution!

**Installation mode**

- 1 Accessible from every side
- 2 Placed against a wall
- 3 On the end when suited
- 4 On the end when suited, placed against a wall
- 5 In the middle when suited
- 6 In the middle when suited, placed against a wall
- 7 In the middle when suited, placed against a wall with the top covered

The surfaces are given in m<sup>2</sup>.

### Spacial suitable enclosures

Installation mode										
H (mm)	W (mm)	D (mm)	1	2	3	4	5	6	7	
1200	600	400	2.50	2.21	2.30	2.02	2.11	1.82	1.66	
		600	3.10	2.81	2.81	2.52	2.52	2.23	1.98	
	800	400	3.04	2.66	2.85	2.46	2.66	2.27	2.05	
		600	3.70	3.31	3.41	3.02	3.12	2.74	2.40	
1400	600	400	2.86	2.52	2.63	2.30	2.41	2.07	1.90	
	800	400	3.47	3.02	3.25	2.80	3.02	2.58	2.35	
1600	600	600	3.96	3.58	3.58	3.19	3.19	2.81	2.56	
		800	4.70	4.32	4.19	3.81	3.68	3.30	2.96	
	800	600	4.70	4.19	4.32	3.81	3.94	3.42	3.09	
1800	400	400	2.82	2.53	2.53	2.24	2.24	1.95	1.84	
		500	3.20	2.91	2.84	2.55	2.48	2.19	2.05	
		600	3.58	3.29	3.14	2.86	2.71	2.42	2.26	
	600	400	3.58	3.14	3.29	2.86	3.00	2.57	2.40	
		500	3.98	3.55	3.62	3.19	3.26	2.83	2.62	
		600	4.39	3.96	3.96	3.53	3.53	3.10	2.84	
		800	5.21	4.78	4.63	4.20	4.06	3.62	3.29	
	800	400	4.34	3.76	4.05	3.47	3.76	3.18	2.96	
		500	4.77	4.20	4.41	3.84	4.05	3.48	3.20	
		600	5.21	4.63	4.78	4.20	4.34	3.77	3.43	
	1000	400	5.10	4.38	4.81	4.09	4.52	3.80	3.52	
		500	5.56	4.84	5.20	4.48	4.84	4.12	3.77	
		600	6.02	5.30	5.59	4.87	5.16	4.44	4.02	
	1200	400	5.86	4.99	5.57	4.70	5.28	4.42	4.08	
		500	6.35	5.48	5.99	5.12	5.63	4.76	4.34	
		600	6.84	5.98	6.41	5.54	5.98	5.11	4.61	
2000	300	500	3.09	2.85	2.69	2.45	2.29	2.05	1.95	
		600	3.49	3.25	3.01	2.77	2.53	2.29	2.17	
	400	400	3.10	2.78	2.78	2.46	2.46	2.14	2.03	
		500	3.52	3.20	3.12	2.80	2.72	2.40	2.26	
		600	3.94	3.62	3.46	3.14	2.98	2.66	2.49	
		800	4.77	4.45	4.13	3.81	3.49	3.17	2.94	
	600	400	3.94	3.46	3.62	3.14	3.30	2.82	2.65	
		500	4.38	3.90	3.98	3.50	3.58	3.10	2.89	
		600	4.82	4.34	4.34	3.86	3.86	3.38	3.13	
		800	5.71	5.23	5.07	4.59	4.43	3.95	3.62	
	800	400	4.77	4.13	4.45	3.81	4.13	3.49	3.26	
		500	5.24	4.60	4.84	4.20	4.44	3.80	3.52	
		600	5.71	5.07	5.23	4.59	4.75	4.11	3.78	
		800	6.66	6.02	6.02	5.38	5.38	4.74	4.29	
	1000	400	5.60	4.80	5.28	4.48	4.96	4.16	3.88	
		500	6.10	5.30	5.70	4.90	5.30	4.50	4.15	
		600	6.60	5.80	6.12	5.32	5.64	4.84	4.42	
		800	7.60	6.80	6.96	6.16	6.32	5.52	4.96	
	1200	400	6.43	5.47	6.11	5.15	5.79	4.83	4.50	
		500	6.96	6.00	6.56	5.60	6.16	5.20	4.78	
		600	7.49	6.53	7.01	6.05	6.53	5.57	5.06	
		800	8.54	7.58	7.90	6.94	7.26	6.30	5.63	
	1600	400	8.10	6.82	7.78	6.50	7.46	6.18	5.73	
		500	8.68	7.40	8.28	7.00	7.88	6.60	6.04	
600		9.26	7.98	8.78	7.50	8.30	7.02	6.35		
2200	400	600	4.30	3.94	3.77	3.42	3.24	2.89	2.72	
		600	5.26	4.73	4.73	4.20	4.20	3.67	3.42	
	800	600	6.22	5.69	5.51	4.98	4.81	4.28	3.94	
		800	7.23	6.53	6.53	5.82	5.82	5.12	4.67	
	1000	600	7.18	6.30	6.65	5.77	6.12	5.24	4.82	
		1200	600	8.14	7.08	7.61	6.55	7.08	6.02	5.52
			800	9.26	8.21	8.56	7.50	7.86	6.80	6.13

# Technical guides and spare parts

<b>Enclosure certifications</b>	<b>478</b>
<b>International enclosure standard</b>	<b>479</b>
<b>Selection of enclosures</b>	<b>480</b>
<b>Degrees of protection provided by enclosures</b>	<b>481</b>
<b>Classification of electrical equipment enclosures according to NEMA and UL</b>	<b>482</b>
<b>Polyester base coating properties</b>	<b>484</b>
<b>Properties of the plastic materials</b>	<b>486</b>
<b>Description of the marking label affixed to ATEX certified wall-mounting enclosures</b>	<b>488</b>
<b>How to select your enclosures &amp; accessories?</b>	<b>489</b>
<b>Spare parts</b>	<b>490</b>











Product certifications are awarded for enclosures as components.

Aim of the certification						
Range	International standard for electric power enclosures	Standards for industrial equipment and UL classification	Marine environment classification or approval for protection and resistance to vibrations	ATEX	Outdoor Heavy Duty	Low-voltage switchgear and controlgear assemblies
	Standard/Directive IEC 62208	UL508A and CAN CSA C22-2 no. 14	Rules of certifying bodies	European directive no. 94/9/EC EN 60079-0 and -7 EN 61241-0 and -1	IEC 61439-5 ISO 12.944 IEC 61969-3	IEC 61439-1&2
<b>Spacial</b>						
SF	● ●	●	● ●			
SFHD	● ●				●	
SFP						●
SM	● ●	●	●			
S3D	● ●	●	● ● ● ●	● (1)		
S3HD	●				●	
SBM	●	●	● ● ● ●			
SFX						
SMX	●	●				
S3X	●	●	●	● (1)		
<b>Thalassa</b>						
PLA	● ●	●	●			
PLAT	● ●					
PLAZ	● ●					
PLATZ	● ●					
PLD	●					
PHD	●				●	
PLM	● ●	●	●	● (1)		
PLS	●	● (3)				
TBS/TBP	●	● (2)				
<b>ClimaSys</b>						
CV		●				
CU		●				
CE		●				
CR		●				
CC		●				

(1) ATEX certifications relate to an adapted part of the range. These ranges are distinguished by their EX endings.

(2) Only TBP.

(3) Transparent cover in process.

Official certification body										
Bureau Veritas	LCIE (Bureau Veritas)	Bureau Veritas Marine Division	TUV Rheiland Group	Underwriters Laboratories	Laboratorio Oficial J.M. Madariaga	Det Norske Veritas	Germanischer Lloyd	Lloyd's Register	Dekra	Asefa
										
●	●	●	●	●	●	●	●	●	●	●

PB60066-57



**Empty enclosures for low-voltage switchgear and controlgear assemblies. General rules.**

### Application

For empty enclosures before adding the user's switchgear, in the condition as supplied by the manufacturer.

### Field of application

Demands for testing the enclosures to be used as part of the switchgear assemblies for voltages of less than 1000 V alternating current and 1500 V direct current.

### Information supplied by the manufacturer

- Commercial trademark of the manufacturer: Schneider Electric.
- Mechanical characteristics, materials, conditions for use.
- Conditions for use:
  - Ambient air temperature for outdoor installations: -25 to +40°C.
  - Atmospheric conditions for outdoor installations: the humidity can temporarily reach 100% at a temperature of 25°C.
  - Transport and storage conditions: from -25 to +55°C; for limited periods not exceeding 24 h: up to +70°C.

*\* European standard EN 62208 is identical to IEC 62208. European countries publish this standard according to the body in each country (for example BS EN 62208 in the UK).*

PB60067-57



### Standard tests of standard IEC 62208

- Static loads: test 1.25 x maximum admissible load during 1 hour.
- Lifting: applicable to enclosures with lifting accessories.
- Axial loads of metal inserts: 500 N for 10 seconds for M8 inserts.
- IK code: test according to standard IEC 62262 with pendulum impact tester. After testing, the enclosure keeps its IP rating.
- IP rating: test according to standard IEC 60529. Degree of protection against access to dangerous parts and the penetration of solid bodies and against the penetration of water.
- Thermal stability at a temperature of 70 °C: 7 days.
- Resistance to heat: ball test at 70 °C (1).
- Resistance to abnormal heat and to fire: glow wire test according to IEC 60695-2-10 and IEC 60695-2-11 (1).
- Dielectric strength: 5000 V (1).
- Protection circuit continuity (2): resistance not to exceed 0.1 ohm.
- Weather resistance: duration 500 h (cycle: rain 5 minutes + UV lamp 25 minutes).
- Corrosion resistance:
  - For indoor enclosures:
    - 6 cycles of 24 hours of the damp heat test at 40 °C and relative humidity of 95%.
    - 2 cycles of 24 hours of the salt mist test at 35 °C.
  - For outdoor enclosures:
    - 12 cycles of 24 hours of the damp heat test at 40 °C and relative humidity of 95%.
    - 14 cycles of 24 hours of the salt mist test at 35 °C.

Our empty enclosures are marked CE according to the Low-Voltage Directive (LVD). It is the responsibility of the final equipment manufacturer to respect regulations in force.

(1) Information required for enclosures made from insulating material.  
 (2) For metal enclosures.

## Selection according to the IP protection degrees

The degrees of protection, explained on the next page, is an important element when selecting the enclosures.

The following table shows the protection degrees of the enclosures.

Name	Range	IP40	IP41	IP42	IP43	IP44	IP54	IP55	IP65	IP66
Metal industrial boxes	Spacial SBM							● (4)		● (4)
Metal derivation boxes	Spacial SDB							●		
Steel universal wall-mounting enclosures	Spacial S3D							● (1)		●
Steel modular distribution wall-mounting enclosures	Spacial S3DM									●
Terminal wall-mounting enclosures	Spacial S3DB									●
EMC steel wall-mounting enclosures	Spacial S3HF							●		
HMI steel wall-mounting enclosures	Spacial S3CM						●			
ATEX steel wall-mounting enclosures	Spacial S3DEX									●
Stainless-steel wall-mounting enclosures	Spacial S3X									●
ATEX stainless-steel wall-mounting enclosures	Spacial S3XEX									●
Steel floor-standing enclosures	Spacial SM							●		
Steel suitable enclosures	Spacial SF							●		
Stainless-steel floor-standing enclosures	Spacial SMX							●		
Stainless-steel suitable enclosures	Spacial SFX							●		
Steel control desks	Spacial SD							●		
Stainless-steel control desks	Spacial SDX							●		
Thermoplastic industrial boxes	Thalassa TBS-TBP									●
Polyester modular boxes	Thalassa PLS								●	
Polyester wall-mounting enclosures	Thalassa PLM									●
ATEX polyester wall-mounting enclosures	Thalassa PLMEX									●
Polyester floor-standing enclosures	Thalassa PLA (2)					●			●	
	Thalassa PLD				●		● (3)			

(1) Double door.

(2) Different IP depending on the version. See introduction in Thalassa PLA section.

(3) With gasket.

(4) Different IP depending on the version: Spacial SBM flat box: IP66 - Spacial SBMC FL21 entry box and Spacial SBMB Bus box: IP55.

## The universal offer

> **3** Material solutions

Steel

Stainless-steel

Plastic & Polyester

## Selection according to the environment

The location of the enclosures and the physical, chemical and climatic conditions to which they are exposed will determine the model to be used.

- Steel enclosures are particularly well suited to indoor use in industrial environments.
- Stainless-steel enclosures are particularly well suited to corrosive environments or areas where specific hygiene demands are applicable.
- Polyester enclosures are particularly well suited to severe corrosive atmospheres, indoors or outdoors.

Enclosures made from insulating materials guarantee total insulation, reducing electric hazards for persons.

The main characteristics of the plastic materials of our enclosures and their chemical strength are given on page 486.

















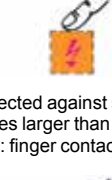

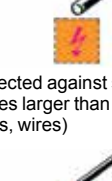

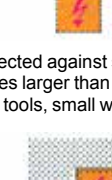

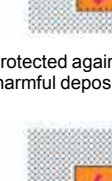
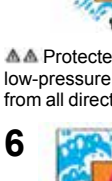
Further help for making the selection is given by the NEMA or UL classification of the enclosure, see page 483.

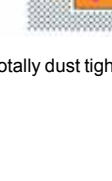
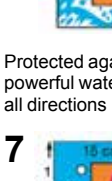

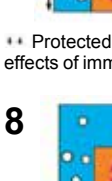
# Degrees of protection provided by enclosures

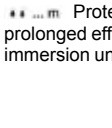
- The degrees of protection provided by the enclosures are defined by standards IEC 60529 (IP) and IEC 62262 (IK).
- Degrees of protection are indicated by the letters IP followed by two characteristic numerals. The numerals show the degree of protection offered by the enclosure against access to dangerous parts, the penetration of solid bodies (1st numeral), and against the penetration of liquids (2nd numeral).
- The protection against external mechanical impact is indicated by the letters IK followed by a characteristic group numeral.

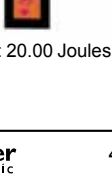
**Note:** Many EN European standards are harmonised with international IEC standards.  
 This is the case with enclosure protection standards:  
 - EN 60529 = IEC 60529.  
 - EN 62262 = IEC 62262.

	IP	IK
First numeral Protection against solid bodies	Second numeral Protection against liquids	Mechanical protection
<b>0</b> No protection 	<b>0</b> No protection 	<b>0</b> No protection 
<b>1</b> Protected against solid bodies larger than 50 mm (e.g.: incidental contact with the hand) 	<b>1</b> Protected against vertically falling water droplets (condensation) 	<b>1</b> Impact energy: 0.150 Joules 7.5 cm 
<b>2</b> Protected against solid bodies larger than 12 mm (e.g.: finger contact) 	<b>2</b> Protected against water droplets deflected at up to 15° from vertical 	<b>2</b> Impact energy: 0.200 Joules 10 cm 
<b>3</b> Protected against solid bodies larger than 2.5 mm (tools, wires) 	<b>3</b> Protected against rainwater at up to 60° from vertical 	<b>3</b> Impact energy: 0.350 Joules 17.5 cm 
<b>4</b> Protected against solid bodies larger than 1 mm (fine tools, small wires) 	<b>4</b> Protection against water spray from all directions 	<b>4</b> Impact energy: 0.500 Joules 25 cm 
<b>5</b> Protected against dust (no harmful deposits) 	<b>5</b> Protection against low-pressure water jets from all directions 	<b>5</b> Impact energy: 0.700 Joules 35 cm 
<b>6</b> Totally dust tight 	<b>6</b> Protection against powerful water jets from all directions 	<b>6</b> Impact energy: 1.00 Joules 20 cm 
	<b>7</b> Protection against the effects of immersion 	<b>7</b> Impact energy: 2.00 Joules 40 cm 
	<b>8</b> Protection against prolonged effects of immersion under pressure 	<b>8</b> Impact energy: 5.00 Joules 29.5 cm 
		<b>9</b> Impact energy: 10.00 Joules 20 cm 
		<b>10</b> Impact energy: 20.00 Joules 40 cm 

# Classification of electrical equipment enclosures according to NEMA and UL

NEMA and UL are standardisation bodies, commonly recognised in North America, which have issued classifications of enclosures according to the protection offered in various environments.

These classifications are similar.

The 1<sup>st</sup> table below summarises this classification, which does not include potentially explosive areas. The detailed recommendations of this classification are given on the next page.

The 2<sup>nd</sup> table indicates the classification of our enclosures.

These classifications appear in our UL certifications (see Certification technical annex on page 478).

Certification according to the UL classification guarantees the corresponding NEMA classification by equivalence.

Environment and protection	Classification												
	1	2	3	3R	3S	4	4X	5	6	6P	12	12K	13
Indoor use	●	●	●	●	●	●	●	●	●	●	●	●	●
Outdoor use			●	●	●	●	●		●				
Incidental contact with the equipment	●	●	●	●	●	●	●	●	●	●	●	●	●
Dirt	●	●	●	●	●	●	●	●	●	●	●	●	●
Drips and gentle splashes of non-corrosive liquids		●	●	●	●	●	●	●	●	●	●	●	●
Rain, frost* and snow			●	●	●	●	●		●	●			
Frost**					●								
Dust, fibres and particles in suspension			●		●	●	●		●	●	●	●	●
Built-up dust, fibres and particles in suspension			●		●	●	●	●	●	●	●	●	●
Clouds of dust			●		●	●	●		●	●			
Splashes and jets of water						●	●		●	●			
Gentle splashes and leaks of oil or non-corrosive coolants											●	●	●
Drips, splashing and spraying of oil or non-corrosive coolants													●
Corrosive agents								●		●			
Occasional temporary immersion									●	●			
Occasional prolonged immersion										●			

\* The operation of the external mechanisms is not required when the enclosure is covered with frost.

\*\* The operation of the external mechanisms is required when the enclosure is covered with frost.

Enclosures		Type of protection (1)												
Name	Range	1	2	3	3R	3S	4	4X	5	6	6P	12	12K	13
Steel wall-mounting enclosures	S3D (1)	●	●(3)	●(3)	●(3)		●(3)	●(3)	●			●	●(4)	●
	S3HF	●	●	●	●				●			●		●
Stainless-steel wall-mounting enclosures	S3X (2)	●	●(3)	●(3)	●(3)		●(3)	●(3)	●(3)			●	●(4)	●(3)
Steel floor-standing enclosures	SM	●	●(3)	●(3)	●(3)		●(3)		●(3)			●	●	●
Steel suitable enclosures	SF	●			●							●	●	
Stainless-steel floor-standing enclosures	SMX	●	●(3)	●(3)	●(3)		●(3)	●(3)	●(3)			●	●	●
Stainless-steel suitable enclosures	SFX	●										●	●	
Thermoplastic boxes	TBP	●		●		●	●	●				●		
Polyester modular boxes	PLS	●	●	●	●	●	●	●				●		●
Polyester wall-mounting enclosures	PLM	●	●	●	●	●	●	●	●			●	●	●
Polyester floor-standing enclosures	PLA	●	●	●(3)	●(3)	●(3)	●(3)	●(3)	●(3)			●		●

(1) Also S3DM, S3DEX, S57 and S3DC.

(2) Also S3XEX.

(3) 1 door.

(4) 2 doors.

Components		Type of protection (4)												
Name	Range	1	2	3	3R	3S	4	4X	5	6	6P	12	12K	13
Ventilation system	CV											●	●	
Thermal regulation system	CC											●	●	

(4) In some ranges the classification depends on the model and version. The detailed protection types are indicated in the UL certifications.

# Classification of electrical equipment enclosures according to NEMA and UL

PS600063-55



PS600064-55



The enclosures must protect the equipment against environmental conditions and protect the personnel against the risk of incidental contact with the equipment. The following classifications (Type) are required according to the required uses and prescriptions:

Type	Use	Prescription
1	Indoor use	The enclosure provides protection for the personnel against incidental contact with the internal equipment and protects said equipment against dirt.
2	Indoor use	It provides protection for the personnel against incidental contact with the internal equipment and protects said equipment against dirt, drips and gentle splashes of non-corrosive liquids.
3	Indoor and outdoor use	The enclosure provides protection for the personnel against incidental contact with the internal equipment and protects said equipment against dirt, rain, sleet, snow, windblown and resists the formation of ice on the outside.
3R	Indoor and outdoor use	The enclosure provides protection for the personnel against incidental contact with the internal equipment and protects said equipment against dirt, rain, sleet, snow and resists the formation of ice on the outside.
3S	Indoor and outdoor use	The enclosure provides protection for the personnel against incidental contact with the internal equipment and protects said equipment against dirt, rain, sleet, snow and windblown dust. The external mechanism must continue to work even when layers of ice are formed.
4	Indoor and outdoor use	The enclosure provides protection for the personnel against incidental contact with the internal equipment and protects said equipment against dirt, rain, sleet, snow, windblown dust, splashes and hose-directed water and resists the formation of frost on the outside.
4x	Indoor and outdoor use	The enclosure provides protection for the personnel against incidental contact with the internal equipment and protects said equipment against dirt, rain, sleet, snow, windblown dust, splashes, hose-directed water and resists corrosion and the formation of ice on the outside.
5	Indoor use	The enclosure provides protection for the personnel against incidental contact with the internal equipment and protects said equipment against dirt, settling airborne dust, lint, fibres, flyings, drips and gentle splashes of non-corrosive liquids.
6	Indoor and outdoor use	The enclosure provides protection for the personnel against incidental contact with the internal equipment and protects said equipment against dirt, rain, sleet, snow, hose-directed water, the entry of water during occasional temporary submersion to a limited depth and resists the formation of ice on the outside.
6P	Indoor and outdoor use	The enclosure provides protection for the personnel against incidental contact with the internal equipment and protects said equipment against dirt, rain, sleet, snow, hose-directed water, the entry of water during prolonged submersion to a limited depth and resists corrosion and the formation of ice on the outside.
12	Indoor use (without knockouts)	The enclosure provides protection for the personnel against incidental contact with the internal equipment and protects said equipment against dirt, dust, fluff, fibres, particles in suspension, drips and gentle splashes of non-corrosive liquids as well as gentle splashes or leaks of oil and non-corrosive coolants.
12K	Indoor use (enclosures with pre-routing)	The enclosure provides protection for the personnel against incidental contact with the internal equipment and protects said equipment against dirt, dust, lint, fibres flyings drips and gentle splashes of non-corrosive liquids as well as gentle splashes or leaks of oil and non-corrosive coolants.
13	Indoor use	The enclosure provides protection for the personnel against incidental contact with the internal equipment and protects said equipment against dirt, dust, lint, fibres flyings and the spraying, splashing, and seepage leaks of water, oil or non-corrosive coolants.

**Note:** The above recommendations aim to explain the NEMA and UL classifications, but are not the official texts of NEMA or UL. The exact definitions provided by the Organisations are those of standards NEMA 250 and UL 50E.

# Polyester base coating properties

PB50008-96



## Product type

Thermosetting polyester resins based powder coating modified by epoxy resins and designed for decoration and to prevent corrosion.

The performance of this coating is superior to conventional epoxy powders in terms of: colour stability, temperature resistance and weather resistance.

Grey RAL 7035; appearance: structured.

## Mechanical properties

Test conditions: steel samples with a thickness of 10/10<sup>e</sup> mm.

Degreasing using biodegradable surface-active agents.

Film thickness: 60 microns.

Bonding (scratching and adhesive tape)	ISO 2409	Class 1
Ericksen stamping	ISO 1520	≥ 7 mm
Direct impact resistance	ISO 6272	> 1 kg/70 cm
Indirect impact resistance	ISO 6272	> 1 kg/20 cm
Bending around conical mandrel	ISO 6860 - ASTM D 522-88	Maximum cracking of 70 mm, without the paint coming loose

## Chemical properties

Tests conducted at ambient temperature on phosphated samples covered with a 150 to 200 micron film:

■ Film intact.

■ Film attacked (blistering, yellowing, loss of gloss).

Number of months			2	4	6	8	10	12		
<b>Acid</b>	Acetic	20 %	[Blue bar]							
	Sulphuric	30 %	[Blue bar]							
	Nitric	30 %	[Blue bar]		[Red bar]					
	Phosphoric	30 %	[Blue bar]							
	Hydrochloric	30 %	[Blue bar]				[Red bar]			
	Lactic	10 %	[Blue bar]							
	Citric	10 %	[Blue bar]				[Red bar]			
	<b>Base</b>	Soda	10 %	[Blue bar]		[Red bar]				
Ammonia		10 %	[Blue bar]	[Red bar]						
<b>Water</b>	Distilled water		[Blue bar]				[Red bar]			
	Sea water		[Blue bar]							
	Tap water		[Blue bar]							
	Diluted chloride bleach		[Blue bar]	[Red bar]						
<b>Solvents</b>	Petrol		[Blue bar]		[Red bar]					
	Higher alcohols		[Blue bar]				[Red bar]			
	Aliphatics		[Blue bar]		[Red bar]					
	Aromatics		[Blue bar]				[Red bar]			
	Ketones-esters		[Red bar]							
	Tri-perchloroethylene		[Red bar]							

## Physical properties

Temperature resistance: -40°C and 100 hours at +150°C (colour: white).

Gloss retention: good.

## Resistance to corrosion

Compliance with standard IEC 62208 for outdoor installations: 288 h of humid heat and 336 h of salt mist.

# Polyester base coating properties

## Nuclear decontamination

Applicable to colours RAL 7035 and AFNOR A550.  
Standard NFT 30901. Percentage of decontamination for contamination by fission products. Please consult us for further details.

## Accelerated aging

Standard IEC 62208: 500 h UV according to ISO 4892 (method A) (adherence of the coating with minimum retention of 50% on the grid according to ISO 2409).

## Fire behaviour

Class M1 (self-extinguishing material).  
Class M0 (for coating on a metal base).

## Manufacturing process

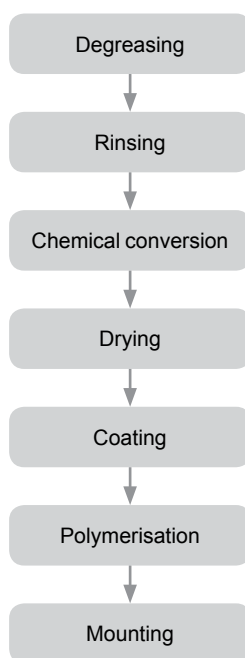

# Properties of the plastic materials

## Mechanical, electrical, physical and fire-resistance properties

Plastic materials generally used to manufacture our products:

- ABS.
- Polycarbonate.
- PVC (polyvinyl chloride).
- Bayblend® = PC + ABS.
- Polyester reinforced with fibreglass.
- Altuglas.
- Polypropylene.
- Polystyrene.
- Polyamide 6 and 12.
- SBS.

Specifications	Standards	Units	ABS	Polycarbonate	PVC	Bayblend®	Polyester	SBS
<b>Mechanical properties</b>								
Tensile strength	ISO 257	MPa	44	> 65	45	35	85	5
Tensile strain	ISO 527	%	12	> 110	120 to 150	40	0	600
Impact resistance	ISO 179	kJ/m <sup>2</sup>	125	No breakage	25	No breakage	60	No breakage
Notching resistance	ISO 179	kJ/m <sup>2</sup>	19	25	20	25	50	-
<b>Electrical properties</b>								
Stress point	IEC 60112	-	-	250-300	> 600	> 550	> 600	-
Surface strength	IEC 60093	ohm	1015	> 1015	> 1013	> 1014	≥1012	> 1013
Dielectric strength	IEC 60243	kV/mm	16.5	> 30	30	24	18-20	20
Specific resistivity	IEC 60093	ohm <sup>3</sup> cm	1015	> 1016	≥ 1015	1016	≥ 1012	> 1016
<b>Physical properties</b>								
Softening temperature (Vicat B)	ISO 306	°C	95	145-150	79-80	115	(1)	80
Temperature resistance	-	°C	-40...+90	-50...+125	-20...+65	-35...+90	-50...+150	-40...+120
Water absorption	ISO 62	%	0.2 - 0.45	0.15	< 0.1	0.2	0.2	-
Specific weight	ISO 1183	kg/dm <sup>3</sup>	1.04	1.21	1.4	1.12	1.85	0.3 in 24 h
<b>Fire resistance</b>								
Oxygen index	ISO 4589	%	19	26	45-50	22	24.4	18
Glow wire resistance, 2 mm	IEC 60695-2	°C	650	960	960	750	960	750° (1.5 mm)
Glow wire resistance, 3 mm	IEC 60695-2	°C	650	960	960	750	960	NA

(1) No softening of the polyester.

Specifications	Standards	Units	Altuglas	Polypropylene	Polystyrene	Polyamide 6	Polyamide 12
<b>Mechanical properties</b>							
Tensile strength	ISO 257	MPa	30	35	24	40	30
Tensile strain	ISO 527	%	5	400	36	200	300
Impact resistance	ISO 179	kJ/m <sup>2</sup>	20	20	63	No breakage	No breakage
Notching resistance	ISO 179	kJ/m <sup>2</sup>	3	5	50	31.2	15
<b>Electrical properties</b>							
Stress point	IEC 60112	-	-	-	KB175	KB175	KB180
Surface strength	IEC 60093	ohm	≥ 1014	-	> 1013	1012	5 x 1010
Dielectric strength	IEC 60243	kV/mm	13-15	20	≤ 40	23	55
Specific resistivity	IEC 60093	ohm <sup>3</sup> cm	> 1015	> 1016	> 1015	1011	3 x 1011
<b>Physical properties</b>							
Softening temperature (Vicat B)	ISO 306	°C	120-122	75 (vicat A)	79	230	140
Temperature resistance	-	°C	-20...+80	-10...+80	-15...+60	-20...+100	-50...+125
Water absorption	ISO 62	%	< 0.5	0.1 in 24 h	0.1 in 24 h	1.6	1.5
Specific weight	ISO 1183	kg/dm <sup>3</sup>	1.18	0.91	1.06	1.14	1.03
<b>Fire resistance</b>							
Oxygen index	ISO 4589	%	18.5	18	18	24	22
Glow wire resistance, 2 mm	IEC 60695-2	°C	-	650	650	750	650
Glow wire resistance, 3 mm	IEC 60695-2	°C	960	650	650	850	650

# Properties of the plastic materials

## Resistance to chemical agents

The table shows:

- The concentration of the chemical agent in %; sat = saturation.
- The resistance of the material:
  - +: Resistant.
  - O: Limited resistance.
  - : Not resistant.

Plastic materials generally used to manufacture our products:

- ABS.
- Polycarbonate.
- PVC (polyvinyl chloride).
- Bayblend® = PC + ABS.
- Polyester.
- Altuglas.
- Polypropylene.
- Polystyrene.
- Polyamide 6 and 12.
- SBS.

Resistance to	ABS	Polycarbonate	PVC	Bayblend®	Polyester	Altuglas	Polypropylene	Poly-styrene	Polyamide 6	Polyamide 12	SBS
Acetone	-	-	-	-	-	O	100 +	-	100 +	+	+
Hydrochloric acid	15 +	10 +	30 +	20 +	30 +	sat +	10 +	O	10 -	10 +	10 +
Citric acid		10 +	sat +	10 +	100 +	sat +	sat +	+	10 O	+	10 +
Lactic acid	80 +	10 +	90 +	10 -	100 +	20 +	90 +	O	50 O	+	sat +
									90 -	+	
Nitric acid	30 +	10 +	50 +	10 +	20 +	10 +	25/50	O	2 O	-	50 +
		100 -			+	100 -			10 -		
Phosphoric acid	85 +	100 +	sat +	+	100 +	10 +	sat +	O	2 O	50 +	+
						95 -			10 -		
Sulphuric acid	50 +	50 +	96 +	30 +	70 +	30 +	96 +	O	3 -	10 +	96 +
		100 -									
Alcohol	O	96 +	96 +	-	50 O	50 O	96 +	+	96 O	96 +	+
Pure aniline	O	-	100 -	-	O	-	100 +		100 O	100 O	
Benzene	+	100 -	-	+	-	O	100 O		100 +	+	-
Liquid bromine		100 -	-	-			100 -			100 -	-
Liquid chlorine		-	100 -	-	sat +	-	100 -		100 O	-	50 +
Sea water	+	100 +	100 +	+	100 +	100 +	-	100 +		100 +	sat +
Petrol	+	100 +	100 O	-	100 +	100 O	-	-	100 +	+	-
Ether	-	100 O	100 -	-	100 O	+			100 +	100 +	-
Hexane	O	+	O	O	-		100 +		100 +	100 +	-
Oil and greases	+	100 +	100 +	O	100 +	100 O	100 +	-	+	100 +	-
Aromatic hydrocarbon	O	-	-	-	-	+	-	-	-	+	-
Fuel oil	O	100 O	100 +	-	100 +	100 -	100 +		100 +	100 +	-
Naphthalene			100 O	-	100 +	100 -	100 +		100 +	100 +	
Nitrobenzene	-	-	100 -	-	-	-	100 O		-	O	-
Phenol	-	-	sat O	-	20 O	-	sat +		-	-	10 O
Mineral salts		+	+	+	+	+	+			+	+
Iodine solution		O	-	+		-			+		
Toluene	-	-	100 -	-	+	O	100 O	-	100 +	100 +	-
Trichloroethylene	-	-	100 -	-	-	-	100 O	-	100 -	100 O	-
Urea		sat +	sat +	+			sat +		10 +	sat +	sat O

For other chemical agents, please contact us.

All this information is taken from the best sources and provided for information purposes only, with no commitment on our behalf.

# Description of the marking label affixed to ATEX certified wall-mounting enclosures

## Spacial S3EX

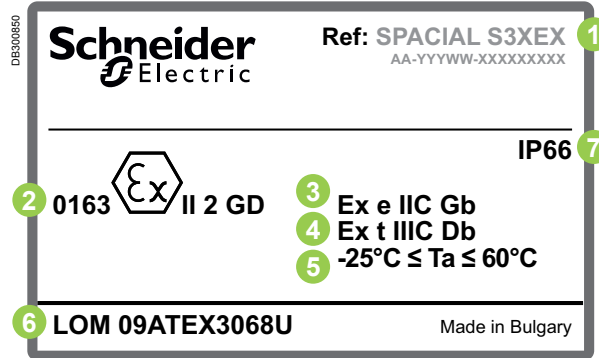

## Thalassa PLMEX

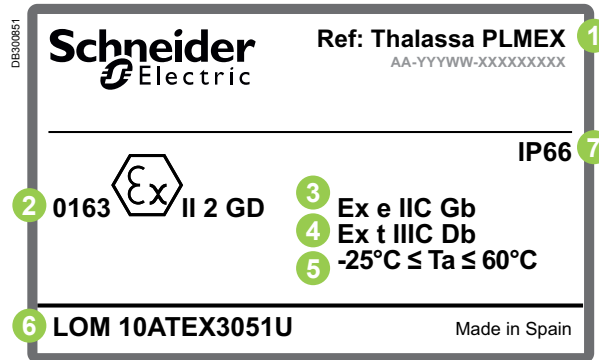

## Spacial S3DEX

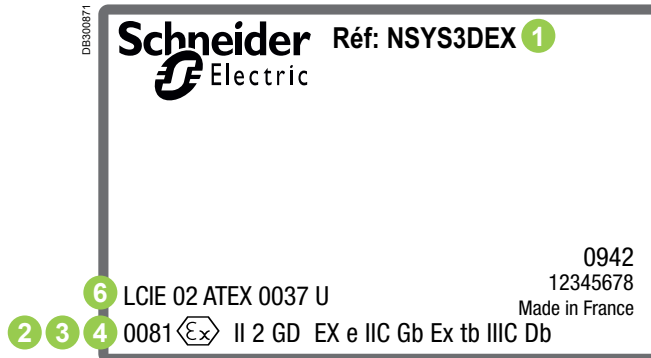

- 1 Product range
- 2 0163: No. of the body  
Ex: ATEX symbol according to the directive  
II: Surface industries  
2: Product category  
GD: Gas and dust
- 3 Ex: Product compliant with EN 60079-7 (gas)  
e: Increased safety  
II: Surface industries
- 4 Ex: Product compliant with EN 60079-31 (dust)  
t: Protection by t enclosure
- 5 Ta: Ambient temperature
- 6 No. of the CE certificate
- 7 IP66: Degree of protection



Download our ATEX certificates from our site.



# How to select your enclosures & accessories?

Environment	
In what type of environment will you be installing your products?	<ul style="list-style-type: none"> <li>■ Indoor industrial environments, use steel.</li> <li>■ Indoor corrosive environments or with specific hygienic demands, use stainless-steel.</li> <li>■ Severe corrosive environments, indoor or outdoor, use polyester enclosures.</li> <li>■ Always think about the thermal issue. We have the right solution.</li> </ul>
Is a canopy required?	A canopy is mandatory when liquid can fall on an enclosure. Our polyester enclosures (PLM and PLAT) are pre-equipped.
Technical requirements	
Are tightness and resistance to external mechanical impact needed in your case?	Each enclosure specifies its: <ul style="list-style-type: none"> <li>■ Tightness: IP.</li> <li>■ Resistance to external mechanical impact: IK.</li> </ul>
Have you any size-related installation constraints?	Check the dimensions of the enclosure: Height (H) x Width (W) x Depth (D) in mm.
What colours are available?	RAL 7035 is our standard on steel enclosures. Other colours are available on demand.
How do you install your enclosures?	Installation possible: <ul style="list-style-type: none"> <li>■ On a wall.</li> <li>■ On the floor.</li> <li>■ On a post.</li> </ul> Available accessories: <ul style="list-style-type: none"> <li>■ Mounting brackets.</li> <li>■ Plinths.</li> <li>■ Post mounting devices.</li> <li>■ Reinforcement for heavy load.</li> </ul>
Door	
Need to see inside the enclosure?	Choice of: <ul style="list-style-type: none"> <li>■ Glazed doors.</li> <li>■ Acrylic windows.</li> <li>■ Control protection frames.</li> </ul>
What type of lock do you want?	The type of lock is to be specified: <ul style="list-style-type: none"> <li>■ Inserts.</li> <li>■ Keys.</li> <li>■ Padlocks.</li> </ul>
Do you need an earth connection?	Electrical continuity by earthing braids or leads available as accessories.
How will you mount your raceways to the door? On the uprights? On the rails?	They can be fixed thanks to: <ul style="list-style-type: none"> <li>■ Cable-duct supports.</li> <li>■ Door cross-rails.</li> <li>■ Cable ties.</li> </ul>
Are doors opened for maintenance?	You may need: <ul style="list-style-type: none"> <li>■ Door stops.</li> <li>■ Door switches.</li> </ul>
Body or frame	
Where do the cables enter the enclosure from?	A large variety of cable entries available.
What functions should this cable-entry provide?	Our cable glands or membranes provide: <ul style="list-style-type: none"> <li>■ Tightness.</li> <li>■ Cable supports.</li> </ul>
Mounting accessories	
How will the equipment be installed inside your enclosure?	Several mounting plates according to your application: <ul style="list-style-type: none"> <li>■ Plain.</li> <li>■ Micro-perforated (Telequick System).</li> <li>■ Perforated (Telequick System).</li> <li>■ Modular.</li> <li>■ 19".</li> </ul>
Do you require cable accessories?	<ul style="list-style-type: none"> <li>■ Cable ducts.</li> <li>■ Cable cross rails.</li> <li>■ Cable supports...</li> </ul> ... are available, see our catalogue for more details.
Thermal	
Do you need to cool? Heat? Dry?	<ul style="list-style-type: none"> <li>■ Ventilation louvers.</li> <li>■ Ventilation grilles.</li> <li>■ Forced ventilations.</li> <li>■ Resistance heaters.</li> <li>■ Thermostats.</li> <li>■ Calculations with ClimaSys software.</li> </ul> Refer to our <b>Thermal Control</b> section.
Logistics and handling	
How do you handle the enclosures?	Thanks to eyebolts and lifting brackets.

# Spare parts

## Selection table

### Steel wall-mounting enclosures

FB500199-30



S3D			
Description	References	Description	References
<b>Doors</b>			
Plain door 300 x 200	NSYDS3D32	Glazed door 1000 x 800	NSYDS3D108T
Plain door 300 x 250	NSYDS3D325	Glazed door 1000 x 1000	NSYDS3D1010T
Plain door 300 x 300	NSYDS3D33	Glazed door 1200 x 600	NSYDS3D126T
Plain door 300 x 400	NSYDS3D34	Glazed door 1200 x 800	NSYDS3D128T
Plain door 400 x 300	NSYDS3D43	Glazed door 1200 x 1000	NSYDS3D1210T
Plain door 400 x 400	NSYDS3D44	Glazed door 1000 x 500 right	NSYDS3D105TR
Plain door 400 x 600	NSYDS3D46	Glazed door 1000 x 500 left	NSYDS3D105TL
Plain door 500 x 300	NSYDS3D53	Glazed door 1200 x 500 right	NSYDS3D125TR
Plain door 500 x 400	NSYDS3D54	Glazed door 1200 x 500 left	NSYDS3D125TL
Plain door 500 x 500	NSYDS3D55	<b>Door accessories</b>	
Plain door 600 x 400	NSYDS3D64	Gasket double door encl.	NSYGDD
Plain door 600 x 500	NSYDS3D65	Set of 5 taps and latches	NSYS3DTL
Plain door 600 x 600	NSYDS3D66	<b>Earthing accessories</b>	
Plain door 600 x 800	NSYDS3D68	Set of 500 earthing labels	NSYSWMEL
Plain door 700 x 500	NSYDS3D75	<b>Mounting hardware</b>	
Plain door 800 x 600	NSYDS3D86	100 screws cable gland plate	NSYS3DCGSB
Plain door 800 x 800	NSYDS3D88	Standard screw bag cable gland plate	NSYS3DCGPSTDSB
Plain door 800 x 1000	NSYDS3D810	<b>Locking accessories</b>	
Plain door 800 x 500 right	NSYDS3D85R	Set of 10 linkage guides	NSYS3DLG
Plain door 800 x 500 left	NSYDS3D85L	Standard key DB3	NSYAEDLS3DKDB3
Plain door 800 x 600 right	NSYDS3D86R	Lock + standard key DB3 neutral	NSYAEDLS3DRLN
Plain door 800 x 600 left	NSYDS3D86L	3 point lock linkage H 600 mm	NSYBTAS3D60
Plain door 1000 x 600	NSYDS3D106	3 point lock linkage H 700 mm	NSYBTAS3D70
Plain door 1000 x 800	NSYDS3D108	3 point lock linkage H 800 mm	NSYBTAS3D80
Plain door 1000 x 1000	NSYDS3D1010	3 point lock linkage H 1000 mm	NSYBTAS3D100
Plain door 1200 x 1000	NSYDS3D1210	3 point lock linkage H 1200 mm	NSYBTAS3D120
Plain door 1000 x 500 right	NSYDS3D105R	3 point lock linkage H 1400 mm	NSYBTAS3D140
Plain door 1000 x 500 left	NSYDS3D105L	2244E key handle	NSYAEDL2244S3D
Plain door 1000 x 600 right	NSYDS3D106R	4322A key handle	NSYAEDL4322S3D
Plain door 1000 x 600 left	NSYDS3D106L	1332E key handle	NSYAEDL1332S3D
Plain door 1200 x 600	NSYDS3D126	3132A key handle	NSYAEDL3132S3D
Plain door 1200 x 800	NSYDS3D128	2132A key handle	NSYAEDL2132S3D
Plain door 1200 x 500 right	NSYDS3D125R	2124E key handle	NSYAEDL2124S3D
Plain door 1200 x 500 left	NSYDS3D125L	2314E key handle	NSYAEDL2314S3D
Plain door 1200 x 600 right	NSYDS3D126R	2241A key handle	NSYAEDL2241S3D
Plain door 1200 x 600 left	NSYDS3D126L	2322A key handle	NSYAEDL2322S3D
Plain door 1400 x 500 right	NSYDS3D145R	3432E key handle	NSYAEDL3432S3D
Plain door 1400 x 500 left	NSYDS3D145L	520 key handle	NSYAEDL520S3D
Glazed door 300 x 250	NSYDS3D325T	4324E key handle	NSYAEDL4324S3D
Glazed door 300 x 300	NSYDS3D33T	3123E key handle	NSYAEDL3123S3D
Glazed door 300 x 400	NSYDS3D34T	2131A key handle	NSYAEDL2131S3D
Glazed door 300 x 600	NSYDS3D36T	610E key handle	NSYAEDL610S3D
Glazed door 400 x 300	NSYDS3D43T	1344E key handle	NSYAEDL1344S3D
Glazed door 400 x 400	NSYDS3D44T	601 key handle	NSYAEDL601S3D
Glazed door 400 x 600	NSYDS3D46T	705E key handle	NSYAEDL705S3D
Glazed door 500 x 300	NSYDS3D53T	2432E key handle	NSYAEDL2432S3D
Glazed door 500 x 400	NSYDS3D54T	2133A key handle	NSYAEDL2133S3D
Glazed door 500 x 500	NSYDS3D55T	5124A key handle	NSYAEDL5124S3D
Glazed door 500 x 600	NSYDS3D56T	<b>Panels</b>	
Glazed door 600 x 400	NSYDS3D64T	50 caps for holes of hinges WM	NSYSWMCH
Glazed door 600 x 500	NSYDS3D65T	Set of 50 back plugs WM	NSYSWMBP
Glazed door 600 x 600	NSYDS3D66T	<b>Mounting accessories</b>	
Glazed door 600 x 800	NSYDS3D68T	5 kits of 4 covers for wall-mounting brackets	NSYCAEFPF
Glazed door 700 x 500	NSYDS3D75T		
Glazed door 700 x 600	NSYDS3D76T		
Glazed door 800 x 600	NSYDS3D86T		
Glazed door 800 x 800	NSYDS3D88T		
Glazed door 1000 x 600	NSYDS3D106T		



To find out more about our spare parts offer, visit our website at [www.schneider-electric.com](http://www.schneider-electric.com)

# Spare parts Selection table

## Steel wall-mounting enclosures



PBS00097-29

S3DM			
Description	References	Description	References
<b>Doors</b>		<b>Locking accessories</b>	
Glazed door 400 x 300	NSYDS3D43T	Set of 10 linkage guides	NSYS3DLG
Glazed door 500 x 400	NSYDS3D54T	Standard key DB3	NSYAEDLS3DKDB3
Glazed door 600 x 400	NSYDS3D64T	3 point lock linkage H 600 mm	NSYBTAS3D60
Glazed door 600 x 600	NSYDS3D66T	3 point lock linkage H 700 mm	NSYBTAS3D70
Glazed door 700 x 500	NSYDS3D75T	3 point lock linkage H 800 mm	NSYBTAS3D80
Glazed door 800 x 600	NSYDS3D86T	3 point lock linkage H 1000 mm	NSYBTAS3D100
Glazed door 1000 x 600	NSYDS3D106T	<b>Panels</b>	
Glazed door 1000 x 800	NSYDS3D108T	50 caps for holes of hinges WM	NSYSWMCH
<b>Earthing accessories</b>		Set of 50 back plugs WM	NSYSWMBP
Set of 500 earthing labels	NSYSWMEL	<b>Mounting hardware</b>	
<b>Mounting hardware</b>		100 screws cable gland plate	NSYS3DCGSB
Standard screw bag cable gland plate	NSYS3DCGPSTDSB		

S3DC			
Description	References	Description	References
<b>Doors</b>		<b>Earthing accessories</b>	
Plain door 300 x 200	NSYDS3DC32	Set of 500 earthing labels	NSYSWMEL
Plain door 300 x 300	NSYDS3DC33	<b>Locking accessories</b>	
Plain door 400 x 300	NSYDS3DC43	Set of 10 linkage guides	NSYS3DLG
Plain door 400 x 400	NSYDS3DC44	Standard lock enclosures	NSYAEDLS3DC
Plain door 500 x 400	NSYDS3DC54	3 point lock linkage H 600 mm	NSYBTAS3D60
Plain door 500 x 500	NSYDS3DC55	3 point lock linkage H 700 mm	NSYBTAS3D70
Plain door 600 x 400	NSYDS3DC64	3 point lock linkage H 800 mm	NSYBTAS3D80
Plain door 600 x 600	NSYDS3DC66	3 point lock linkage H 1000 mm	NSYBTAS3D100
Plain door 700 x 500	NSYDS3DC75	3 point lock linkage H 1200 mm	NSYBTAS3D120
Plain door 800 x 600	NSYDS3DC86	<b>Panels</b>	
Plain door 800 x 800	NSYDS3DC88	50 caps for holes of hinges WM	NSYSWMCH
Plain door 1000 x 600	NSYDS3DC106	Set of 50 back plugs WM	NSYSWMBP
Plain door 1000 x 800	NSYDS3DC108		
Plain door 1000 x 1000	NSYDS3DC1010		
Plain door 1200 x 800	NSYDS3DC128		
Plain door 1200 x 1000	NSYDS3DC1210		

S3DCD			
Description	References	Description	References
<b>Doors</b>		<b>Locking accessories</b>	
Plain door 500 x 500	NSYDS3DCD55	Standard lock enclosures	NSYAEDLS3DC
Plain door 600 x 600	NSYDS3DCD66	3 point lock linkage H 700 mm	NSYBTAS3D70
Plain door 700 x 500	NSYDS3DCD75	3 point lock linkage H 800 mm	NSYBTAS3D80
Plain door 800 x 600	NSYDS3DCD86	3 point lock linkage H 1000 mm	NSYBTAS3D100
Plain door 1000 x 600	NSYDS3DCD106	3 point lock linkage H 1200 mm	NSYBTAS3D120
Plain door 1000 x 800	NSYDS3DCD108	<b>Panels</b>	
Plain door 1000 x 1000	NSYDS3DCD1010	50 caps for holes of hinges WM	NSYSWMCH
Plain door 1200 x 1000	NSYDS3DCD1210	Set of 50 back plugs WM	NSYSWMBP

S3DB			
Description	References	Description	References
<b>Doors</b>		<b>Earthing accessories</b>	
Plain door 250 x 300	NSYDS3DB2530	Set of 500 earthing labels	NSYSWMEL
Plain door 250 x 400	NSYDS3DB2540	<b>Locking accessories</b>	
Plain door 250 x 500	NSYDS3DB2550	Standard key DB3	NSYAEDLS3DKDB3
Plain door 300 x 300	NSYDS3DB33	<b>Panels</b>	
Plain door 300 x 400	NSYDS3DB34	50 caps for holes of hinges WM	NSYSWMCH
Plain door 300 x 500	NSYDS3DB35	Set of 50 back plugs WM	NSYSWMBP
Plain door 300 x 600	NSYDS3DB36		
Plain door 400 x 300	NSYDS3DB43		
Plain door 400 x 800	NSYDS3DB48		
Plain door 500 x 400	NSYDS3DB54		
Plain door 600 x 400	NSYDS3DB64		

# Spare parts

## Selection table

### Steel wall-mounting enclosures

PE50038B-31



CRN			
Description	References	Description	References
<b>Doors</b>			
Glazed door H 300 x W 250	NSYDCRN3025T	Plain door H 400 x W 300	NSYDCRN43
Glazed door H 300 x W 300	NSYDCRN33T	Plain door H 400 x W 400	NSYDCRN44
Glazed door H 300 x W 400	NSYDCRN34T	Plain door H 400 x W 600	NSYDCRN46
Glazed door H 400 x W 300	NSYDCRN43T	Plain door H 500 x W 400	NSYDCRN54
Glazed door H 400 x W 400	NSYDCRN44T	Plain door H 500 x W 500	NSYDCRN55
Glazed door H 400 x W 600	NSYDCRN46T	Plain door H 600 x W 400	NSYDCRN64
Glazed door H 500 x W 400	NSYDCRN54T	Plain door H 600 x W 500	NSYDCRN65
Glazed door H 500 x W 500	NSYDCRN55T	Plain door H 600 x W 600	NSYDCRN66
Glazed door H 600 x W 400	NSYDCRN64T	Plain door H 600 x W 800	NSYDCRN68
Glazed door H 600 x W 500	NSYDCRN65T	Plain door H 700 x W 500	NSYDCRN75
Glazed door H 600 x W 600	NSYDCRN66T	Plain door H 800 x W 600	NSYDCRN86
Glazed door H 600 x W 800	NSYDCRN68T	Plain door H 800 x W 800	NSYDCRN88
Glazed door H 700 x W 500	NSYDCRN75T	Plain door H 1000 x W 600	NSYDCRN106
Glazed door H 800 x W 600	NSYDCRN86T	Plain door H 1000 x W 800	NSYDCRN108
Glazed door H 800 x W 800	NSYDCRN88T	<b>Door accessories</b>	
Glazed door H 1000 x W 600	NSYDCRN106T	Standard Spacial hinge	NSYBICRN
Glazed door H 1000 x W 800	NSYDCRN108T	<b>Earthing accessories</b>	
Plain door H 200 x W 200	NSYDCRN22	Set of 500 earthing labels	NSYSWMEL
Plain door H 200 x W 300	NSYDCRN23	<b>Locking accessories</b>	
Plain door H 250 x W 200	NSYDCRN2520	TCRE1 Lock	NSYTCRE1
Plain door H 300 x W 250	NSYDCRN3025	TCRE12 Lock	NSYTCRE12
Plain door H 300 x W 300	NSYDCRN33	CRN Standard Lock, 3 mm DB	NSYCDB3
Plain door H 300 x W 400	NSYDCRN34	CRN Standard Key, 3 mm DB Lock	NSYDBP
Plain door H 300 x W 450	NSYDCRN3045	<b>Panels</b>	
		Set of 50 back plugs WM	NSYSWMBP

PE50037B-30



CRNG			
Description	References	Description	References
<b>Earthing accessories</b>			
Set of 500 earthing labels	NSYSWMEL	<b>Panels</b>	
<b>Mounting hardware</b>			
100 screws cable gland plate	NSYS3DCGSB	50 caps for holes of hinges WM	NSYSWMCH
Standard screw bag cable gland plate	NSYS3DCGPSTDSB	Set of 50 back plugs WM	NSYSWMBP

# Spare parts Selection table

## Steel floor-standing enclosures

PE602419-27



SF			
Description	References	Description	References
<b>Doors</b>		<b>Installation accessories</b>	
Spacial SFP plain door H 2000 x W 700 mm	NSYSFD207	Set of 2 quick cross-rails 120 x 400 mm	NSYSQCR12040
Spacial SFP transparent door H 2000 x W 700 mm	NSYSFD207T	Set of 2 quick cross-rails 120 x 500 mm	NSYSQCR12050
<b>Door accessories</b>		Set of 2 quick cross-rails 120 x 600 mm	NSYSQCR12060
Set of 4 Hinges & mounting elements	NSYDHSF	Set of 2 quick cross-rails 120 x 800 mm	NSYSQCR12080
<b>Mounting hardware</b>		<b>Panels</b>	
Captive screws for panels external mounting	NSYCSSF	Spacial SFP back panel H 2000 x W 700 mm	NSYBP207
<b>Locking accessories</b>		Standard roof W 1000 x D 400 mm	NSYRSF104
Locking system for enclosures 1 single door version 1200H (right side door for double door version)	NSYLCK12SF	Standard roof W 1000 x D 500 mm	NSYRSF105
Locking system for enclosures 1 single door version 1400H	NSYLCK14SF	Standard roof W 1000 x D 600 mm	NSYRSF106
Locking system for enclosures 1 single door version 1600H (right side door for double door version)	NSYLCK16SF	Standard roof W 1000 x D 800 mm	NSYRSF108
Locking system for enclosures 1 single door version 1800H (right side door for double door version)	NSYLCK18SF	Standard roof W 1200 x D 400 mm	NSYRSF124
Locking system for enclosures 1 single door version 2000H (right side door for double door version)	NSYLCK20SF	Standard roof W 1200 x D 500 mm	NSYRSF125
Locking system for enclosures 1 single door version 2200H (right side door for double door version)	NSYLCK22SF	Standard roof W 1200 x D 600 mm	NSYRSF126
Door locking system toothed washer	NSYLCKWSF	Standard roof W 1200 x D 800 mm	NSYRSF128
Handle neutral trim	NSYSFHNTRIM	Standard roof W 1600 x D 400 mm	NSYRSF164
<b>Plinth accessories</b>		Standard roof W 1600 x D 500 mm	NSYRSF165
H 100 mm Plastic covers for plinth corners	NSYPC100	Standard roof W 1600 x D 600 mm	NSYRSF166
H 200 mm Plastic covers for plinth corners	NSYPC200	Standard roof W 300 x D 500 mm	NSYRSF35
		Standard roof W 300 x D 600 mm	NSYRSF36
		Standard roof W 300 x D 800 mm	NSYRSF38
		Standard roof W 400 x D 400 mm	NSYRSF44
		Standard roof W 400 x D 500 mm	NSYRSF45
		Standard roof W 600 x D 400 mm	NSYRSF64
		Standard roof W 600 x D 500 mm	NSYRSF65
		Standard roof W 600 x D 600 mm	NSYRSF66
		Standard roof W 800 x D 400 mm	NSYRSF84
		Standard roof W 800 x D 500 mm	NSYRSF85
		Standard roof W 800 x D 600 mm	NSYRSF86
		Standard roof W 800 x D 800 mm	NSYRSF88
		<b>Framework</b>	
		8 gaskets framework uprights Spacial SF	NSYSFVG

PE602401-28



SM			
Description	References	Description	References
<b>Cable gland plates</b>		<b>Locking accessories</b>	
1 entry W 1000 x D 400 mm	NSYSMEC1041	Locking system for enclosures 1 single door version 1200H (right side door for double door version)	NSYLCK12SF
1 entry W 1000 x D 300 mm	NSYSMEC1031	Locking system for enclosures 1 single door version 1600H (right side door for double door version)	NSYLCK16SF
1 entry W 1000 x D 500 mm	NSYSMEC1051	Locking system for enclosures 1 single door version 1800H (right side door for double door version)	NSYLCK18SF
1 entry W 600 x D 300 mm	NSYSMEC631	Locking system for enclosures 1 single door version 2000H (right side door for double door version)	NSYLCK20SF
1 entry W 600 x D 400 mm	NSYSMEC641	Locking system for enclosures 1 single door version 2200H (right side door for double door version)	NSYLCK22SF
1 entry W 600 x D 500 mm	NSYSMEC651	Locking system for double door enclosures. Secondary door	NSYLCKSF
1 entry W 600 x D 600 mm	NSYSMEC661	Locking system for enclosures 1 single door version 1400H	NSYLCK14SF
1 entry W 800 x D 300 mm	NSYSMEC831	Door locking system toothed washer	NSYLCKWSF
1 entry W 800 x D 400 mm	NSYSMEC841	Handle neutral trim	NSYSFHNTRIM
1 entry W 800 x D 500 mm	NSYSMEC851	<b>Plinth accessories</b>	
1 entry W 800 x D 600 mm	NSYSMEC861	H 100 mm Plastic covers for plinth corners	NSYPC100
<b>Doors</b>		H 200 mm Plastic covers for plinth corners	NSYPC200
Double plain door H 1200 x W 1000 mm	NSYSMD12102D		
Double plain door H 1200 x W 1200 mm	NSYSMD12122D		
Double plain door H 1400 x W 1000 mm	NSYSMD14102D		
Double plain door H 1400 x W 1200 mm	NSYSMD14122D		
Double plain door H 1600 x W 1000 mm	NSYSMD16102D		
Double plain door H 1600 x W 1200 mm	NSYSMD16122D		
Double plain door H 1800 x W 1600 mm	NSYSMD18162D		
<b>Door accessories</b>			
Set of 4 hinges & mounting elements	NSYDHSF		
Spacial SM hinges & 2D door stop	NSYDHSM2D		

# Spare parts

## Selection table

### Steel floor-standing enclosures

OLN and S6000			
Description	References	Description	References
<b>Doors</b>		<b>Panels</b>	
Plain door H 1800 x W 600 mm	<b>OLPU186</b>	Roof trim neutral 600 mm	<b>NSYTRIM6S6</b>
Plain door H 1800 x W 800 mm	<b>OLPU188</b>	Roof trim neutral 800 mm	<b>NSYTRIM8S6</b>
Plain door H 2000 x W 600 mm	<b>OLPU206</b>	Roof trim neutral 1000 mm	<b>NSYTRIM10S6</b>
Plain door H 2000 x W 800 mm	<b>OLPU208</b>	Side panel H 1800 x W 500	<b>2PLOL185</b>
Plain door H 2000 x W 1000 mm	<b>OLPU2010</b>	Side panel H 1800 x W 600	<b>2PLOL186</b>
Transparent door H 1800 x W 800 mm	<b>OLPU188KT</b>	Side panel H 2000 x W 500	<b>2PLOL205</b>
Transparent door H 2000 x W 800 mm	<b>OLPU208KT</b>	Side panel H 2000 x W 600	<b>2PLOL206</b>
<b>Door accessories</b>		Side panel H 2000 x W 800	<b>2PLOL208</b>
Standard door hinges and pins, 4 units	<b>NSYDHS6</b>		
Standard gasket for gland plate, 2000 mm	<b>NSYGKTS6</b>		
<b>Locking accessories</b>			
Standard handle in RAL 7011	<b>NSYSDH</b>		
Flat escutcheon DB 5 mm insert	<b>NSYEMPOLN</b>		
Locking system for enclosures 1 single door version 1200H	<b>NSYLCK12S6</b>		
Locking system for enclosures 1 single door version 1600H	<b>NSYLCK16S6</b>		
Locking system for enclosures 1 single door version 1800H	<b>NSYLCK18S6</b>		
Locking system for enclosures 1 single door version 2000H	<b>NSYLCK20S6</b>		
Locking system for enclosures 1 single door version 2200H	<b>NSYLCK22S6</b>		

CMO and S18500			
Description	References	Description	References
<b>Doors</b>		<b>Locking accessories</b>	
Roof trim neutral 1000 mm	<b>NSYTRIM10S18</b>	Standard handle in RAL 7011	<b>NSYSDH</b>
Plain door H 1800 x W 600 mm	<b>OLPU186</b>	Flat escutcheon DB 5 mm insert	<b>NSYEMPOLN</b>
Plain door H 1800 x W 800 mm	<b>OLPU188</b>	Locking system for enclosures 1 single door version 1200H	<b>NSYLCK12S6</b>
Plain door H 2000 x W 600 mm	<b>OLPU206</b>	Locking system for enclosures 1 single door version 1600H	<b>NSYLCK16S6</b>
Plain door H 2000 x W 800 mm	<b>OLPU208</b>	Locking system for enclosures 1 single door version 1800H	<b>NSYLCK18S6</b>
Plain door H 2000 x W 1000 mm	<b>OLPU2010</b>	Locking system for enclosures 1 single door version 2000H	<b>NSYLCK20S6</b>
Transparent door H 1800 x W 800 mm	<b>OLPU188KT</b>	Locking system for enclosures 1 single door version 2200H	<b>NSYLCK22S6</b>
Transparent door H 2000 x W 800 mm	<b>OLPU208KT</b>		
<b>Door accessories</b>		<b>Panels</b>	
Standard door hinges and pins, 4 units	<b>NSYDHS18</b>	Roof trim neutral 600 mm	<b>NSYTRIM6S18</b>
Standard gasket for gland plate, 2000 mm	<b>NSYGKTS6</b>	Roof trim neutral 800 mm	<b>NSYTRIM8S18</b>

# Spare parts Selection table

## Stainless steel enclosures

PE500075-40



### S3X (wall-mounting)

Description	References	Description	References
<b>Doors</b>			
Left door 304L 1000 x 1000 mm	NSYDS3X1010L	Plain door 316L 400 x 600 mm	NSYDS3X46H
Left door 316L 1000 x 1000 mm	NSYDS3X1010LH	Plain door 304L 500 x 400 mm	NSYDS3X54
Right door 304L 1000 x 1000 mm	NSYDS3X1010R	Plain door 316L 500 x 400 mm	NSYDS3X54H
Right door 316L 1000 x 1000 mm	NSYDS3X1010RH	Plain door 304L 600 x 400 mm	NSYDS3X64
Plain door 304L 1000 x 800 mm	NSYDS3X108	Plain door 316L 600 x 400 mm	NSYDS3X64H
Plain door 316L 1000 x 800 mm	NSYDS3X108H	Plain door 304L 600 x 600 mm	NSYDS3X66
Left door 304L 1200 x 1000 mm	NSYDS3X1210L	Plain door 316L 600 x 600 mm	NSYDS3X66H
Left door 316L 1200 x 1000 mm	NSYDS3X1210LH	Plain door 304L 700 x 500 mm	NSYDS3X75
Right door 304L 1200 x 1000 mm	NSYDS3X1210R	Plain door 316L 700 x 500 mm	NSYDS3X75H
Right door 316L 1200 x 1000 mm	NSYDS3X1210RH	Plain door 304L 800 x 600 mm	NSYDS3X86
Plain door 304L 1200 x 800 mm	NSYDS3X128	Plain door 316L 800 x 600 mm	NSYDS3X86H
Plain door 316L 1200 x 800 mm	NSYDS3X128H	Plain door 304L 800 x 800 mm	NSYDS3X88
Plain door 304L 300 x 200 mm	NSYDS3X32	Plain door 316L 800 x 800 mm	NSYDS3X88H
Plain door 304L 300 x 250 mm	NSYDS3X325	Transp. door 304L 1000 x 800 mm	NSYDS3X108T
Plain door 316L 300 x 250 mm	NSYDS3X325H	Transp. door 304L 400 x 300 mm	NSYDS3X43T
Plain door 316L 300 x 200 mm	NSYDS3X32H	Transp. door 304L 500 x 400 mm	NSYDS3X54T
Plain door 304L 300 x 300 mm	NSYDS3X33	Transp. door 304L 600 x 400 mm	NSYDS3X64T
Plain door 316L 300 x 300 mm	NSYDS3X33H	Transp. door 304L 700 x 500 mm	NSYDS3X75T
Plain door 304L 400 x 300 mm	NSYDS3X43	Transp. door 304L 800 x 600 mm	NSYDS3X86T
Plain door 316L 400 x 300 mm	NSYDS3X43H	<b>Door accessories</b>	
Plain door 304L 400 x 400 mm	NSYDS3X44	Set of 2 hinges	NSYHS3X
Plain door 316L 400 x 400 mm	NSYDS3X44H	<b>Locking accessories</b>	
Plain door 304L 400 x 600 mm	NSYDS3X46	Locking system 1000 mm	NSYLSS3X10
		Locking system 1200 mm	NSYLSS3X12

PE500138-45



### SMX (floor-standing)

Description	References	Description	References
<b>Cable gland plates</b>			
Cable gland plate SMX64/SFX65	NSYCEX2	Door 304L 1800 x 800 mm	NSYDSFX188
Cable gland p. SDX85/SMX85/SFX86	NSYCEX7	Door 316L 1800 x 800 mm	NSYDSFX188H
Cable gland plate SMX103	NSYCEX10	Left door 304L 1800 x 1600 mm	NSYDSFX1816L
Cable gland plate SMX104	NSYCEX11	Left door 316L 1800 x 1600 mm	NSYDSFX1816LH
Cable gland plate SMX104 316L	NSYCEX12	Right door 304L 1800 x 1600 mm	NSYDSFX1816R
Cable gland plate SMX124	NSYCEX14	Right door 316L 1800 x 1600 mm	NSYDSFX1816RH
Cable gland plate SMX124 316L	NSYCEX15	Left door 2000 x 1000 mm	NSYDSFX2010L
Cable gland plate SMX125 316L	NSYCEX17	Left door 316L 2000 x 1000 mm	NSYDSFX2010LH
Cable gland plate SMX84/SMX164	NSYCEX5	Right door 2000 x 1000 mm	NSYDSFX2010R
Cable gland plate SMX166	NSYCEX8	Right door 316L 2000 x 1000 mm	NSYDSFX2010RH
Cable gland plate SMX166 316L	NSYCEX9	Door 1800 x 800 mm	NSYDSFX206
Cable gland plate SMX84/SMX164 316L	NSYCEX6	Left door 2000 x 1200 mm	NSYDSFX2012L
Cable gland plate SDX125/SMX125	NSYCEX16	Left door 316L 2000 x 1200 mm	NSYDSFX2012LH
<b>Doors</b>			
Left door 304L 1400 x 1000 mm	NSYDSFX1410L	Right door 2000 x 1200 mm	NSYDSFX2012R
Right door 304L 1400 x 1000 mm	NSYDSFX1410R	Right door 316L 2000 x 1200 mm	NSYDSFX2012RH
Door 304L 1600 x 800 mm	NSYDSFX168	Door 2000 x 800 mm	NSYDSFX208
Door 304L 1800 x 600 mm	NSYDSFX186	Left door 2000 x 1600 mm	NSYDSFX2016L
Left door 1800 x 1200 mm	NSYDSFX1812L	Left door 316L 2000 x 1600 mm	NSYDSFX2016LH
Left door 316L 1800 x 1200 mm	NSYDSFX1812LH	Right door 2000 x 1600 mm SMX	NSYDSFX2016R
Right door 1800 x 1200 mm	NSYDSFX1812R	Right door 316L 2000 x 1600 mm	NSYDSFX2016RH
Right door 316L 1800 x 1200 mm	NSYDSFX1812RH	<b>Door accessories</b>	
		Set of 3 hinges stainless 316L	NSYHSMXH

# Spare parts

## Selection table

### Stainless steel enclosures



SFX (floor-standing)			
Description	References	Description	References
<b>Cable gland plates</b>			
Cable gland plate SFX64	NSYCEX1	Right door 2000 x 1000 mm	NSYDSFX2010R
Cable gland plate SMX64/SFX65	NSYCEX2	Door 1800 x 800 mm	NSYDSFX206
Cable gland p. SDX85/SMX85/SFX86	NSYCEX7	Left door 2000 x 1200 mm	NSYDSFX2012L
Cable gland plate SFX84	NSYCEX4	Right door 2000 x 1200 mm	NSYDSFX2012R
Cable gland plate SDX105/SFX106	NSYCEX13	Door 2000 x 800 mm	NSYDSFX208
Cable gland plate SDX65/SFX126	NSYCEX3	Left door 2000 x 1600 mm	NSYDSFX2016L
Cable gland plate 800x400 mm SFX	NSYCEX84A	Right door 2000 x 1600 mm	NSYDSFX2016R
<b>Doors</b>			
Door 304L 1800 x 600 mm	NSYDSFX186	<b>Door accessories</b>	
Left door 1800 x 1200 mm	NSYDSFX1812L	Set of 3 hinges	NSYHSMX
Right door 1800 x 1200 mm	NSYDSFX1812R	<b>Locking accessories</b>	
Door 304L 1800 x 800 mm	NSYDSFX188	Locking system 1400 mm	NSYLSSF14
Left door 2000 x 1000 mm	NSYDSFX2010L	Locking system 1600 mm	NSYLSSF16
		Locking system 1800 mm	NSYLSSF18
		Locking system 2000 mm	NSYLSSF20

### Insulating materials



PLA (floor-standing)			
Description	References	Description	References
<b>Doors</b>			
Door 500 x 500	NSYDPLA55	<b>Mounting hardware</b>	
Door 500 x 750	NSYDPLA57	Acc. bag for 1 door h 500-1000	NSYASPLA001
Door 750 x 500	NSYDPLA75	Acc. bag for 2 door h 1250-1500	NSYASPLA002
Door 750 x 750	NSYDPLA77	Acc. bag for 2 door	NSYASPLA003
Door 1000 x 500	NSYDPLA105	<b>Locking accessories</b>	
Door 1000 x 750	NSYDPLA107	Locking and rods h 500	NSYVPLA5
Door 1250 x 500	NSYDPLA125	Locking and rods h 750	NSYVPLA7
Door 1250 x 750	NSYDPLA127	Locking and rods h 1000	NSYVPLA10
Door 1500 x 500	NSYDPLA155	Locking and rods h 1250	NSYVPLA12
Door 1500 x 750	NSYDPLA157	Locking and rods h 1500	NSYVPLA15
Door 500 x 500 with handle	NSYDPLA55H	Handle locking and rods h 500	NSYVPLA5M
Door 500 x 750 with handle	NSYDPLA57H	Handle locking and rods h 750	NSYVPLA7M
Door 750 x 500 with handle	NSYDPLA75H	Handle locking and rods h 1000	NSYVPLA10M
Door 750 x 750 with handle	NSYDPLA77H	Handle locking and rods h 1250	NSYVPLA12M
Door 1000 x 500 with handle	NSYDPLA105H	Handle locking and rods h 1500	NSYVPLA15M
Door 1000 x 750 with handle	NSYDPLA107H		
Door 1250 x 500 with handle	NSYDPLA125H		
Door 1250 x 750 with handle	NSYDPLA127H		
Door 1500 x 500 with handle	NSYDPLA155H		
Door 1500 x 750 with handle	NSYDPLA157H		
<b>Door accessories</b>			
Hinge PLA (120° opening)	NSYAEDPLA004		
Axes of door PLAZT (180° opening)	NSYAEDPLA005		
Rod guide inside the door PLA (set of 2)	NSYAEDPLA001		
Rod guide on 1 door PLA (set of 2)	NSYAEDPLA002		
Rod guide on 2 doors PLA (set of 2)	NSYAEDPLA003		

\* RAL 7035 from 2016.



# Spare parts

## Selection table

### Insulating materials



PS501325SE-32

PLM (wall-mounting)			
Description	References	Description	References
<b>Doors</b>			
Door without locking for PLM32	NSYDPLM32	Glazed door without locking for PLM86T	NSYDPLM86T
Door without locking for PLM3025	NSYDPLM3025	Glazed door without locking for PLM108T	NSYDPLM108T
Transp. door without locking for PLM32T	NSYDPLM32T	<b>Door accessories</b>	
Glazed door without locking for PLM3025T	NSYDPLM3025T	Door hinge for NSYPLM32	NSYAEDHPLM32
Door without locking for PLM43	NSYDPLM43	Door hinge for NSYPLM3025	NSYAEDHPLM3025
Door without locking for PLM54	NSYDPLM54	Door hinge for NSYPLM43 to 86	NSYAEDHPLM
Door without locking for PLM64	NSYDPLM64	Door hinge for NSYPLM108	NSYAEDHPLM108
Door without locking for PLM75	NSYDPLM75	<b>Mounting hardware</b>	
Door without locking for PLM86	NSYDPLM86	Acc. bag NSYPLM32	NSYASPLM32
Door without locking for PLM108	NSYDPLM108	Acc. bag NSYPLM43 to 86	NSYASPLM
Glazed door without locking for PLM43T	NSYDPLM43T	<b>Locking accessories</b>	
Glazed door without locking for PLM54T	NSYDPLM54T	Locking and rods for NSYPLM108	NSYVPLM108
Glazed door without locking for PLM64T	NSYDPLM64T		
Glazed door without locking for PLM75T	NSYDPLM75T		

\* RAL 7035 from 2016.

### Applicative and customised solutions: HMI



PS501202-36

SD			
Description	References	Description	References
<b>Cable gland plates</b>			
1 entry W 600 mm	NSYCESD6R	Cover W 600 mm for modular console	NSYMCCSD6
1 entry W 800 mm	NSYCESD8R	Frontal door W 600 mm	NSYDSD6
1 entry W 1000 mm	NSYCESD10R	Frontal door W 800 mm	NSYDSD8
1 entry W 1200 mm	NSYCESD12R	Frontal right door W 1000 mm	NSYDSD10R
1 entry W 600 x D 800 mm	NSYFCESD68	Frontal left door W 1000 mm	NSYDSD10L
1 entry W 800 x D 800 mm	NSYFCESD88	Frontal right door W 1200 mm	NSYDSD12R
1 entry W 1000 x D 800 mm	NSYFCESD108	Frontal left door W 1200 mm	NSYDSD12L
1 entry W 1200 x D 800 mm	NSYFCESD128	Frontal door w/console W 800 mm	NSYDSDF8
1 entry W 1600 x D 800 mm	NSYFCESD168	Front. R door w/console W 1000 mm	NSYDSDF10R
1 entry W 800 x D 1000 mm	NSYFCESD810	Front. L door w/console W 1000 mm	NSYDSDF10L
1 entry W 1000 x D 1000 mm	NSYFCESD1010	Front. R door w/console W 1200 mm	NSYDSDF12R
1 entry W 1200 x D 1000 mm	NSYFCESD1210	Front. L door w/console W 1200 mm	NSYDSDF12L
1 entry W 1600 x D 1000 mm	NSYFCESD1610	Front. R door w/console W 1600 mm	NSYDSDF16R
		Front. L door w/console W 1600 mm	NSYDSDF16L
<b>Doors</b>			
Desk lid W 600 mm	NSYDLSD6	<b>Door accessories</b>	
Desk lid W 800 mm	NSYDLSD8	Hinges compact control desk	NSYHSD
Desk lid W 1000 mm	NSYDLSD10	Hinges control desk w/console	NSYHSDF
Desk lid W 1200 mm	NSYDLSD12	<b>Locking accessories</b>	
Desk lid for w/console W 800 mm	NSYDLSDF8	Standard handle in RAL 7011	NSYSDH
Desk lid for w/console W 1000 mm	NSYDLSDF10	Flat escutcheon DB 5 mm insert	NSYEMPOLN
Desk lid for w/console W 1200 mm	NSYDLSDF12	Lock w/DB 3 mm for frontal doors	NSYFDLSD
Desk lid for w/console W 1600 mm	NSYDLSDF16	Lock w/DB 3 mm desk lids & covers	NSYDLLSDF
Folding console cover W 800 mm	NSYCCSDF8	Flat escutcheon with DB 5 mm	NSYSDFLOCKDB5
Folding console cover W 1000 mm	NSYCCSDF10	<b>Panels</b>	
Folding console cover W 1200 mm	NSYCCSDF12	Rear panel W 600 mm	NSYBPSD6
Folding console cover W 1600 mm	NSYCCSDF16	Rear panel W 800 mm	NSYBPSD8
Cover W 400 mm for modular console	NSYMCCSD4	Rear panel W 1000 mm	NSYBPSD10
		Rear panel W 1200 mm	NSYBPSD12

# Spare parts

## Selection table

### Applicative and customised solutions: HMI

PE501267-38



SDX			
Description	References	Description	References
<b>Cable gland plates</b>			
Cable gland pl. SDX85/SMX85/SFX86	NSYCEX7		
Cable gland plate SDX105/SFX106	NSYCEX13		
Cable gland plate SDX125/SMX125	NSYCEX16		
Cable gland plate SDX65/SFX126	NSYCEX3		
<b>Doors</b>			
Frontal door 600 mm	NSYDSDX6		
Frontal door 800 mm	NSYDSDX8		
Frontal right door 1000 mm	NSYDSDX10R		
Frontal right door 1200 mm	NSYDSDX12R		
Frontal left door 1000 mm	NSYDSDX10L		
Frontal left door 1200 mm	NSYDSDX12L		
Desk lid 1000 mm	NSYDLSDX10		
Desk lid 1200 mm	NSYDLSDX12		
Desk lid 600 mm	NSYDLSDX6		
Desk lid 800 mm	NSYDLSDX8		
<b>Locking accessories</b>			
Locking system	NSYLSSDX		
<b>Panels</b>			
Rear panel 1000 mm	NSYBPSDX10		
Rear panel 1200 mm	NSYBPSDX12		
Rear panel 600 mm	NSYBPSDX6		
Rear panel 800 mm	NSYBPSDX8		

PE500300-36



S3CM			
Description	References	Description	References
<b>Doors</b>			
Plain door H 200 x W 200	NSYDCRN22		
Plain door H 200 x W 300	NSYDCRN23		
Plain door H 250 x W 200	NSYDCRN2520		
Plain door H 300 x W 250	NSYDCRN3025		
Plain door H 300 x W 300	NSYDCRN33		
Plain door H 300 x W 400	NSYDCRN34		
Plain door H 300 x W 450	NSYDCRN3045		
Plain door H 400 x W 300	NSYDCRN43		
Plain door H 400 x W 400	NSYDCRN44		
Plain door H 400 x W 600	NSYDCRN46		
Plain door H 500 x W 500	NSYDCRN55		
Plain door H 600 x W 600	NSYDCRN66		
Plain door H 600 x W 800	NSYDCRN68		
Plain door H 800 x W 600	NSYDCRN86		
<b>Door accessories</b>			
Standard Spacial hinge	NSYBICRN		
<b>Earthing accessories</b>			
Set of 500 earthing labels	NSYSWMEL		
<b>Panels</b>			
Aluminium plate H 300 x W 300	NSYPAS3CM33		
Aluminium plate H 300 x W 400	NSYPAS3CM34		
Aluminium plate H 400 x W 400	NSYPAS3CM44		
Aluminium plate H 400 x W 600	NSYPAS3CM46		
Aluminium plate H 500 x W 500	NSYPAS3CM55		
Aluminium plate H 600 x W 600	NSYPAS3CM66		
Aluminium plate H 600 x W 800	NSYPAS3CM68		
Aluminium plate H 800 x W 600	NSYPAS3CM86		

### Applicative and customised solutions: EMC

PE500205-42



S3HF			
Description	References	Description	References
<b>Doors</b>			
Plain door H 400 x W 300	NSYDS3HF43		
Plain door H 400 x W 600	NSYDS3HF46		
Plain door H 500 x W 400	NSYDS3HF54		
Plain door H 600 x W 400	NSYDS3HF64		
Plain door H 600 x W 600	NSYDS3HF66		
Plain door H 700 x W 500	NSYDS3HF75		
Plain door H 800 x W 600	NSYDS3HF86		
Plain door H 1000 x W 800	NSYDS3HF108		
Plain door H 1200 x W 800	NSYDS3HF128		
<b>Earthing accessories</b>			
Set of 500 earthing labels	NSYSWMEL		
<b>Locking accessories</b>			
Standard Locking system	NSYAEDLS3HFDB3		

# Spare parts

## Selection table

### Applicative and customised solutions: ATEX

PB500096



S3DEX			
Description	References	Description	References
<b>Doors</b>		<b>Mounting hardware</b>	
Plain door 300 x 200	NSYDS3D32	100 screws cable gland plate	NSYS3DCGSB
Plain door 300 x 300	NSYDS3D33	Standard screw bag cable gland plate	NSYS3DCGPSTDSB
Plain door 400 x 300	NSYDS3D43	<b>Locking accessories</b>	
Plain door 400 x 400	NSYDS3D44	Set of 10 linkage guides	NSYS3DLG
Plain door 500 x 400	NSYDS3D54	Standard key DB3	NSYAEDLS3DKDB3
Plain door 600 x 400	NSYDS3D64	3 point lock linkage H 600 mm	NSYBTAS3D60
Plain door 600 x 600	NSYDS3D66	3 point lock linkage H 700 mm	NSYBTAS3D70
Plain door 700 x 500	NSYDS3D75	3 point lock linkage H 800 mm	NSYBTAS3D80
Plain door 800 x 600	NSYDS3D86	3 point lock linkage H 1000 mm	NSYBTAS3D100
Plain door 1000 x 800	NSYDS3D108	<b>Panels</b>	
<b>Earthing accessories</b>		50 caps for holes of hinges WM	NSYSWMCH
Set of 500 earthing labels	NSYSWMEL	Set of 50 back plugs WM	NSYSWMBP

### Outdoor Heavy Duty enclosures

PB502645-21



Thalassa PHD			
Description	References	Description	References
<b>Heavy duty cable-gland plate</b>		For enclosure H 1343 x W 1250 x D 620	
For enclosure H 843 x W 750 x D 420	NSYPPC74HD		NSYPPC56HD + NSYPPC76HD
For enclosure H 843 x W 750 x D 620	NSYPPC76HD	For enclosure H 1593 x W 750 x D 420	NSYPPC74HD
For enclosure H 1093 x W 500 x D 420	NSYPPC54HD	For enclosure H 1593 x W 750 x D 620	NSYPPC76HD
For enclosure H 1093 x W 750 x D 420	NSYPPC74HD	For enclosure H 1593 x W 1250 x D 420	NSYPPC54HD + NSYPPC74HD
For enclosure H 1343 x W 500 x D 420	NSYPPC54HD		
For enclosure H 1343 x W 750 x D 420	NSYPPC74HD	For enclosure H 1593 x W 1250 x D 620	NSYPPC56HD + NSYPPC76HD
For enclosure H 1343 x W 750 x D 620	NSYPPC76HD	For enclosure H 2093 x W 750 x D 420	NSYPPC74HD
For enclosure H 1343 x W 1250 x D 420	NSYPPC54HD + NSYPPC74HD		

PB502653-17



Spacial S3HD			
Description	References	Description	References
<b>Heavy duty cable-gland plate</b>		For enclosure H 753 x W 500 x D 280	
For enclosure H 343 x W 200 x D 180	NSYTLAUHD	For enclosure H 858 x W 600 x D 330	NSYTLGUHD
For enclosure H 448 x W 300 x D 230	NSYTLCUHD	For enclosure H 862 x W 800 x D 430	2 x NSYTLDUHD
For enclosure H 548 x W 400 x D 230	NSYTLDUHD	For enclosure H 1062 x W 600 x D 430	NSYTLGUHD
For enclosure H 653 x W 400 x D 280	NSYTLDUHD	For enclosure H 1062 x W 800 x D 430	2 x NSYTLDUHD
For enclosure H 658 x W 600 x D 330	NSYTLGUHD		

PB502653-17



Spacial SFHD			
Description	References	Description	References
<b>Heavy duty cable-gland plate</b>		For enclosure H 1662 x W 800 x D 430	
For enclosure H 1262 x W 600 x D 430	NSYSFECA64HD	For enclosure H 1662 x W 1200 x D 430	2 x NSYSFECA64HD
For enclosure H 1262 x W 800 x D 430	NSYSFECA64HD	For enclosure H 1681 x W 600 x D 630	NSYSFECA66HD
For enclosure H 1262 x W 1200 x D 430	2 x NSYSFECA64HD	For enclosure H 1681 x W 800 x D 630	NSYSFECA66HD
For enclosure H 1281 x W 600 x D 630	NSYSFECA66HD	For enclosure H 1681 x W 1200 x D 630	2 x NSYSFECA66HD
For enclosure H 1281 x W 800 x D 630	NSYSFECA66HD	For enclosure H 2062 x W 800 x D 430	NSYSFECA64HD
For enclosure H 1281 x W 1200 x D 630	2 x NSYSFECA66HD		

# Index of references

<b>Reference and Page</b>	<b>Reference and Page</b>	<b>Reference and Page</b>	<b>Reference and Page</b>	<b>Reference and Page</b>
<b>2PLOL...</b>	AK2GA69 290	ATV630D75N4 391	AZ1CA04 239	<b>IMT...</b>
2PLOL185 494	AK2GD10075 290	ATV630D90N4 391	<b>DX...</b>	IMT36150 284
2PLOL186 494	AK2GD12575 290	ATV630U07M3 391	DX1AP52 251	IMT36151 273
2PLOL205 494	AK2GD2525 290	ATV630U07N4 391	<b>DZ...</b>	IMT36152 273
2PLOL206 494	AK2GD2550 290	ATV630U15M3 391	DZ5ME5 263, 268	IMT36153 273
2PLOL208 494	AK2GD3750 290	ATV630U15N4 391	DZ5ME8 263, 268	IMT36154 273
<b>08...</b>	AK2GD3775 290	ATV630U22M3 391	DZ5ME9 263, 268	IMT36155 273
08881 282	AK2GD5050 290	ATV630U22N4 391	DZ5MF6 241	IMT36156 273
08892 282	AK2GD5075 290	ATV630U30M3 391	DZ5MF8 241	IMT36157 273
08895 282	AK2GD7550 290	ATV630U30N4 391	DZ5MS10 251	IMT36158 273
08897 282	AK2GD7575 290	ATV630U40M3 391	DZ6MZ121 241	IMT36159 273
08898 282	AK2LA39 289	ATV630U40N4 391	DZ6MZ151 241	IMT36160 273
80099 282	AK2LD01 289	ATV630U55M3 391	DZ6MZ181 241	IMT36161 273
<b>13...</b>	AK2LD02 289	ATV630U55N4 391	DZ6MZ211 241	IMT36162 273
13934 171	AKEGA39 290	ATV630U75M3 391	<b>EN...</b>	IMT36163 273
<b>AF...</b>	<b>AM...</b>	ATV630U75N4 391	ENN46104 288	IMT36164 273
AF1CF34 263, 268	AM1DL201 262	ATV930D11M3 391	ENN46105 288	IMT36165 273
AF1CF56 263, 268	AM1EA200 262	ATV930D11N4 391	ENN46109 288	IMT36166 273
AF1CG• 453	AM1EC115 261	ATV930D15M3 391	ENN46150 288	IMT36167 273
AF1CG4 268	AM1EC200 261	ATV930D15N4 391	ENN46220 288	IMT36168 273
AF1CG5 268	AM1PA0670 236	ATV930D18M3 391	ENN46225 288	IMT36169 273
AF1CG6 268	AM1PA1270 236	ATV930D18N4 391	ENN46902 288	IMT36170 273
AF1EA• 453	AM1PA3015 236	ATV930D22M3 391	ENN46904 288	IMT36171 273
AF1EA3 239, 268	AM1PA3020 236	ATV930D22N4 391	ENN46906 288	IMT36172 284
AF1EA4 239, 268	AM1PA3050 236	ATV930D30M3 391	ENN46908 288	IMT36173 284
AF1EA5 239, 268	AM1PA3070 236	ATV930D30N4 391	ENN46910 288	IMT36179 284
AF1EA6 239, 268	AM1PA4030 236	ATV930D37M3 391	ENN46914 288	IMT36180 284
AF1GC4 263	AM1PA6040 236	ATV930D37N4 391	ENN46916 288	IMT36181 284
AF1GC5 263	AM1PA6050 236	ATV930D45M3 391	ENN46918 288	IMT36182 284
AF1GC6 263	AM1PA6060 236	ATV930D45N4 391	ENN46919 288	IMT36183 284
AF1VA410 268	AM1PA6070 236	ATV930D55N4 391	ENN46920 288	IMT36184 284
AF1VA416 268	AM1PA7050 236	ATV930D75N4 391	ENN46925 288	IMT36185 284
AF1VA512 268	AM1PA8060 236	ATV930D90N4 391	ENN46927 288	<b>ISM...</b>
AF1VA518 268	AM1PA9050 236	ATV930U07M3 391	ENN46939 288	ISM71071 284
AF1VA612 250, 268	AM1PA9060 236	ATV930U07N4 391	ENN46942 288	ISM71072 284
AF1VA618 250, 268	AM1PA9070 236	ATV930U15M3 391	ENN46952 288	ISM71073 284
AF1VC820 250, 268	<b>ATV...</b>	ATV930U15N4 391	ENN46954 288	ISM71074 284
<b>AK...</b>	ATV630D11M3 391	ATV930U22M3 391	ENN46956 288	ISM71501 284
AK2CA6 290	ATV630D11N4 391	ATV930U22N4 391	ENN46958 288	ISM71502 284
AK2CD100 290	ATV630D15M3 391	ATV930U30M3 391	ENN46960 288	ISM71503 284
AK2CD125 290	ATV630D15N4 391	ATV930U30N4 391	ENN46964 288	ISM71504 284
AK2CD25 290	ATV630D18M3 391	ATV930U40M3 391	ENN46966 288	ISM71505 284
AK2CD37 290	ATV630D18N4 391	ATV930U40N4 391	ENN46968 288	ISM71506 284
AK2CD50 290	ATV630D22M3 391	ATV930U55M3 391	ENN46969 288	<b>NSY1...</b>
AK2CD75 290	ATV630D22N4 391	ATV930U55N4 391	ENN46970 288	NSY11950 464
AK2GA315 290	ATV630D30M3 391	ATV930U75M3 391	ENN46974 288	NSY11951 462, 464
AK2GA33 290	ATV630D30N4 391	ATV930U75N4 391	ENN46975 288	NSY11952 462, 464
AK2GA35 290	ATV630D37M3 391	<b>AX...</b>	ENN46976 288	NSY11953 462, 464
AK2GA615 290	ATV630D37N4 391	AX2DL01 251	ENN46977 288	NSY11954 462, 464
AK2GA65 290	ATV630D45M3 391	AX2DL02 251	ENN46978 288	NSY11955 464
	ATV630D45N4 391	<b>AZ...</b>		NSY11956 462, 464

Reference and Page	Reference and Page	Reference and Page	Reference and Page	Reference and Page
NSY11958 462, 464	NSY2SPHD204 312	NSYAC360 199	NSYAEDL2241S3D 490	NSYAEDLS3HFDB3 498
NSY11959 462	NSY2SPHF184 343	NSYAC360 222	NSYAEDL2244S3D 490	NSYAEDLS6S3D 72
NSY11960 462	NSY2SPHF186 343	NSYAC560 220	NSYAEDL2314S3D 490	NSYAEDLS7S3D 72
NSY11961 462	NSY2SPHF2010 343	NSYAC600 199, 222	NSYAEDL2322S3D 490	NSYAEDLS8S3D 72
NSY11962 462	NSY2SPHF204 343	NSYAC840 220, 222	NSYAEDL2331S3D 72	NSYAEDLS17, 51, 100
NSY17990 414	NSY2SPHF206 343	NSYADR100 260	NSYAEDL2432S3D 490	NSYAEDLS3D 72
NSY17991 414	NSY2SPHF208 343	NSYADR120 260	NSYAEDL2433S3D 72	NSYAEDLT6S3D 72
NSY17992 414	NSY2SPHF226 343	NSYADR200 262	NSYAEDL3113S3D 72	NSYAEDLT8S3D 72
NSY17996 414	NSY2SPHF228 343	NSYADR200D 262	NSYAEDL3123S3D 490	NSYAEDPLA001 496
NSY17997 414	NSY2SPI126 124	NSYADR60 260	NSYAEDL3132S3D 490	NSYAEDPLA002 496
NSY17998 414	NSY2SPI185 124	NSYADR80 260	NSYAEDL3432S3D 490	NSYAEDPLA003 496
NSY1TH 259, 387	NSY2SPI186 124	NSYAEBFZ 199	NSYAEDL3432S3D 490	NSYAEDPLA004 496
<b>NSY2...</b>	NSY2SPI188 124	NSYAEBFZ 220, 222	NSYAEDL405K31 328, 332	NSYAEDPLA005 496
NSY2SP124 116, 118, 124	NSY2SPI204 124	NSYAECFLA10 278	NSYAEDL405K33 328, 332	NSYAEDRS3DPA6 75, 299
NSY2SP125 22, 118, 124	NSY2SPI205 124	NSYAECFLA25 278	NSYAEDL405S3D 72	NSYAEDRSCST 61, 75, 83, 299, 330, 333
NSY2SP126 20, 22, 116, 118, 124	NSY2SPI206 124	NSYAECFLA33 278	NSYAEDL421S3D 72	NSYAEDS20TB 179
NSY2SP128 22, 118, 124	NSY2SPI208 124	NSYAECFLA7 278	NSYAEDL4322S3D 490	NSYAEDS40TB 179
NSY2SP144 20, 22, 116, 118, 124	NSY2SPI226 124	NSYAECFLACA14 282	NSYAEDL4324S3D 490	NSYAEDS60TB 179
NSY2SP145 22, 118, 124	NSY2SPI228 124	NSYAECFLACA18 282	NSYAEDL455K31 328, 332	NSYAEDSB320TB 179
NSY2SP146 22, 118, 124	NSY2SPIHD124 312	NSYAECFLACA20 282	NSYAEDL455K33 328, 332	NSYAEDSB520TB 179
NSY2SP148 22, 118, 124	NSY2SPIHD126 312	NSYAECFLACA30 282	NSYAEDL455S3D 72	NSYAEDSBSB 45
NSY2SP164 22, 118, 124	NSY2SPIHD164 312	NSYAECFLAP 282	NSYAEDL5124S3D 490	NSYAEDST620TB 179
NSY2SP165 22, 118, 124	NSY2SPIHD166 312	NSYAECFLBP 139, 280	NSYAEDL520S3D 490	NSYAEDST820TB 179
NSY2SP166 20, 22, 116, 118, 124	NSY2SPQ126 124	NSYAECFLT25 139, 280	NSYAEDL601S3D 490	NSYAEDSTSB 45
NSY2SP168 20, 22, 116, 118, 124	NSY2SPQ128 124	NSYAECFLT35 139, 280	NSYAEDL610S3D 490	NSYAFAHLBSC 60, 66, 82, 89, 94
NSY2SP184 20, 22, 116, 118, 124	NSY2SPQ146 124	NSYAECFLT7 139, 280	NSYAEDL705S3D 490	NSYAEPFPTD 393
NSY2SP185 20, 22, 116, 118, 124	NSY2SPQ148 124	NSYAECPKFL10 280	NSYAEDLB3S3D 72	NSYAEPF3D 100 67, 82
NSY2SP186 20, 22, 116, 118, 124	NSY2SPQ166 124	NSYAECPKFL11 280	NSYAEDLB5S3D 72	NSYAEPF3D 20 67, 82
NSY2SP188 20, 22, 116, 118, 124	NSY2SPQ168 124	NSYAECPKFL7A 280	NSYAEDLDINS3D 73	NSYAEPF3D 30 67, 82
NSY2SP204 20, 23, 116, 119, 124	NSY2SPQ186 124	NSYAECPKFL7B 280	NSYAEDLEDF13K31 328, 332	NSYAEPF3D 40 67, 82
NSY2SP205 20, 23, 116, 119, 124	NSY2SPQ188 124	NSYAEDH120S3D 73	NSYAEDLEDF13K33 328, 332	NSYAEPF3D 50 67, 82
NSY2SP206 20, 23, 116, 119, 124	NSY2SPQ206 124	NSYAEDH180S3D 73	NSYAEDLEDF13S3D 73	NSYAEPF3D 60 67, 82
NSY2SP208 20, 23, 116, 119, 124	NSY2SPQ208 124	NSYAEDH20TB 180	NSYAEDLEDF14K31 328, 332	NSYAEPF3D 70 67, 82
NSY2SP224 23, 119, 124	NSY2SPQ226 124	NSYAEDH40TB 180	NSYAEDLEDF14K33 328, 332	NSYAEPF3D 80 67, 82
NSY2SP225 23, 119, 124	NSY2SPQ228 124	NSYAEDHPLM 497	NSYAEDLEDF14S3D 73	NSYAEPF3D 90 67, 82
NSY2SP226 20, 23, 116, 119, 124	NSY2SPQ228 124	NSYAEDHPLM108 497	NSYAEDLEDF14S3D 73	NSYAEPF3D 100 67, 82
NSY2SP228 20, 23, 116, 119, 124	NSY2SPQ228 124	NSYAEDHPLM3025 497	NSYAEDLEDF14S3D 73	NSYAEPF3D 110 67, 82
NSY2SPHD124 312	NSY2SPX184 25, 167	NSYAEDHPLM32 497	NSYAEDLEDF14S3D 73	NSYAEPF3D 120 67, 82
NSY2SPHD126 312	NSY2SPX204 25, 167	NSYAEDHPLM32 497	NSYAEDLEDF14S3D 73	NSYAEPF3D 130 67, 82
NSY2SPHD164 312	NSY2SPX205 25, 167	NSYAEDHPLM32 497	NSYAEDLEDF14S3D 73	NSYAEPF3D 140 67, 82
NSY2SPHD166 312	NSY2SPX206 25, 167	NSYAEDHPLM32 497	NSYAEDLEDF14S3D 73	NSYAEPF3D 150 67, 82
	<b>NSY5...</b>	NSYAEDKTB 179	NSYAEDLEDF14S3D 73	NSYAEPF3D 160 67, 82
	NSY5G2SP205 325	NSYAEDL1242K31 328, 332	NSYAEDLEDF14S3D 73	NSYAEPF3D 170 67, 82
	NSY5G2SP206 323	NSYAEDL1242K33 328, 332	NSYAEDLEDF14S3D 73	NSYAEPF3D 180 67, 82
	NSY5G2SP208 323, 325	NSYAEDL1242S3D 72	NSYAEDLEDF14S3D 73	NSYAEPF3D 190 67, 82
	NSY5GRCK42 323	NSYAEDL1332S3D 490	NSYAEDLEDF14S3D 73	NSYAEPF3D 200 67, 82
	NSY5GSPK 323	NSYAEDL1344S3D 490	NSYAEDLEDF14S3D 73	NSYAEPF3D 210 67, 82
	<b>NSYA...</b>	NSYAEDL1424S3D 490	NSYAEDLEDF14S3D 73	NSYAEPF3D 220 67, 82
	NSYAC1080 220	NSYAEDL2124S3D 490	NSYAEDLEDF14S3D 73	NSYAEPF3D 230 67, 82
	NSYAC1120 222	NSYAEDL2131S3D 490	NSYAEDLEDF14S3D 73	NSYAEPF3D 240 67, 82
	NSYAC280 199	NSYAEDL2132S3D 490	NSYAEDLEDF14S3D 73	NSYAEPF3D 250 67, 82
	NSYAC320 220	NSYAEDL2133S3D 490	NSYAEDLEDF14S3D 73	NSYAEPF3D 260 67, 82
			NSYAEDLEDF14S3D 73	NSYAEPF3D 270 67, 82
			NSYAEDLEDF14S3D 73	NSYAEPF3D 280 67, 82
			NSYAEDLEDF14S3D 73	NSYAEPF3D 290 67, 82
			NSYAEDLEDF14S3D 73	NSYAEPF3D 300 67, 82
			NSYAEDLEDF14S3D 73	NSYAEPF3D 310 67, 82
			NSYAEDLEDF14S3D 73	NSYAEPF3D 320 67, 82
			NSYAEDLEDF14S3D 73	NSYAEPF3D 330 67, 82
			NSYAEDLEDF14S3D 73	NSYAEPF3D 340 67, 82
			NSYAEDLEDF14S3D 73	NSYAEPF3D 350 67, 82
			NSYAEDLEDF14S3D 73	NSYAEPF3D 360 67, 82
			NSYAEDLEDF14S3D 73	NSYAEPF3D 370 67, 82
			NSYAEDLEDF14S3D 73	NSYAEPF3D 380 67, 82
			NSYAEDLEDF14S3D 73	NSYAEPF3D 390 67, 82
			NSYAEDLEDF14S3D 73	NSYAEPF3D 400 67, 82
			NSYAEDLEDF14S3D 73	NSYAEPF3D 410 67, 82
			NSYAEDLEDF14S3D 73	NSYAEPF3D 420 67, 82
			NSYAEDLEDF14S3D 73	NSYAEPF3D 430 67, 82
			NSYAEDLEDF14S3D 73	NSYAEPF3D 440 67, 82
			NSYAEDLEDF14S3D 73	NSYAEPF3D 450 67, 82
			NSYAEDLEDF14S3D 73	NSYAEPF3D 460 67, 82
			NSYAEDLEDF14S3D 73	NSYAEPF3D 470 67, 82
			NSYAEDLEDF14S3D 73	NSYAEPF3D 480 67, 82
			NSYAEDLEDF14S3D 73	NSYAEPF3D 490 67, 82
			NSYAEDLEDF14S3D 73	NSYAEPF3D 500 67, 82
			NSYAEDLEDF14S3D 73	NSYAEPF3D 510 67, 82
			NSYAEDLEDF14S3D 73	NSYAEPF3D 520 67, 82
			NSYAEDLEDF14S3D 73	NSYAEPF3D 530 67, 82
			NSYAEDLEDF14S3D 73	NSYAEPF3D 540 67, 82
			NSYAEDLEDF14S3D 73	NSYAEPF3D 550 67, 82
			NSYAEDLEDF14S3D 73	NSYAEPF3D 560 67, 82
			NSYAEDLEDF14S3D 73	NSYAEPF3D 570 67, 82
			NSYAEDLEDF14S3D 73	NSYAEPF3D 580 67, 82
			NSYAEDLEDF14S3D 73	NSYAEPF3D 590 67, 82
			NSYAEDLEDF14S3D 73	NSYAEPF3D 600 67, 82
			NSYAEDLEDF14S3D 73	NSYAEPF3D 610 67, 82
			NSYAEDLEDF14S3D 73	NSYAEPF3D 620 67, 82
			NSYAEDLEDF14S3D 73	NSYAEPF3D 630 67, 82
			NSYAEDLEDF14S3D 73	NSYAEPF3D 640 67, 82
			NSYAEDLEDF14S3D 73	NSYAEPF3D 650 67, 82
			NSYAEDLEDF14S3D 73	NSYAEPF3D 660 67, 82
			NSYAEDLEDF14S3D 73	NSYAEPF3D 670 67, 82
			NSYAEDLEDF14S3D 73	NSYAEPF3D 680 67, 82
			NSYAEDLEDF14S3D 73	NSYAEPF3D 690 67, 82
			NSYAEDLEDF14S3D 73	NSYAEPF3D 700 67, 82
			NSYAEDLEDF14S3D 73	NSYAEPF3D 710 67, 82
			NSYAEDLEDF14S3D 73	NSYAEPF3D 720 67, 82
			NSYAEDLEDF14S3D 73	NSYAEPF3D 730 67, 82
			NSYAEDLEDF14S3D 73	NSYAEPF3D 740 67, 82
			NSYAEDLEDF14S3D 73	NSYAEPF3D 750 67, 82
			NSYAEDLEDF14S3D 73	NSYAEPF3D 760 67, 82
			NSYAEDLEDF14S3D 73	NSYAEPF3D 770 67, 82
			NSYAEDLEDF14S3D 73	NSYAEPF3D 780 67, 82
			NSYAEDLEDF14S3D 73	NSYAEPF3D 790 67, 82
			NSYAEDLEDF14S3D 73	NSYAEPF3D 800 67, 82
			NSYAEDLEDF14S3D 73	NSYAEPF3D 810 67, 82
			NSYAEDLEDF14S3D 73	NSYAEPF3D 820 67, 82
			NSYAEDLEDF14S3D 73	NSYAEPF3D 830 67, 82
			NSYAEDLEDF14S3D 73	NSYAEPF3D 840 67, 82
			NSYAEDLEDF14S3D 73	NSYAEPF3D 850 67, 82
			NSYAEDLEDF14S3D 73	NSYAEPF3D 860 67, 82
			NSYAEDLEDF14S3D 73	NSYAEPF3D 870 67, 82
			NSYAEDLEDF14S3D 73	NSYAEPF3D 880 67, 82
			NSYAEDLEDF14S3D 73	NSYAEPF3D 890 67, 82
			NSYAEDLEDF14S3D 73	NSYAEPF3D 900 67, 82
			NSYAEDLEDF14S3D 73	NSYAEPF3D 910 67, 82
			NSYAEDLEDF14S3D 73	NSYAEPF3D 920 67, 82
			NSYAEDLEDF14S3D 73	NSYAEPF3D 930 67, 82
			NSYAEDLEDF14S3D 73	NSYAEPF3D 940 67, 82
			NSYAEDLEDF14S3D 73	NSYAEPF3D 950 67, 82
			NSYAEDLEDF14S3D 73	NSYAEPF3D 960 67, 82
			NSYAEDLEDF14S3D 73	NSYAEPF3D 970 67, 82
			NSYAEDLEDF14S3D 73	NSYAEPF3D 980 67, 82
			NSYAEDLEDF14S3D 73	NSYAEPF3D 990 67, 82
			NSYAEDLEDF14S3D 73	NSYAEPF3D 1000 67, 82
			NSYAEDLEDF14S3D 73	NSYAEPF3D 1010 67, 82
			NSYAEDLEDF14S3D 73	NSYAEPF3D 1020 67, 82
			NSYAEDLEDF14S3D 73	NSYAEPF3D 1030 67, 82
			NSYAEDLEDF14S3D 73	NSYAEPF3D 1040 67, 82
			NSYAEDLEDF14S3D 73	NSYAEPF3D 1050 67, 82
			NSYAEDLEDF14S3D 73	NSYAEPF3D 1060 67, 82
			NSYAEDLEDF14S3D 73	NSYAEPF3D 1070 67, 82
			NSYAEDLEDF14S3D 73	NSYAEPF3D 1080 67, 82
			NSYAEDLEDF14S3D 73	NSYAEPF3D 1090 67, 82
			NSYAEDLEDF14S3D 73	NSYAEPF3D 1100 67, 82
			NSYAEDLEDF14S3D 73	NSYAEPF3D 1110 67, 82
			NSYAEDLEDF14S3D 73	NSYAEPF3D 1120 67, 82
			NSYAEDLEDF14S3D 73	NSYAEPF3D 1130 67, 82
			NSYAEDLEDF14S3D 73	NSYAEPF3D 1140 67, 82
			NSYAEDLEDF14S3D 73	NSYAEPF3D 1150 67, 82
			NSYAEDLEDF14S3D 73	NSYAEPF3D 1160 67, 82
			NSYAEDLEDF14S3D 73	NSYAEPF3D 1170 67, 82
			NSYAEDLEDF14S3D 73	NSYAEPF3D 1180 67, 82
			NSYAEDLEDF14S3D 73	NSYAEPF3D 1190 67, 82
			NSYAEDLEDF14S3D 73	NSYAEPF3D 1200 67, 82
			NSYAEDLEDF14S3D 73	NSYAEPF3D 1210 67, 82
			NSYAEDLEDF14S3D 73	NSYAEPF3D 1220 67, 82
			NSYAEDLEDF14S3D 73	NSYAEPF3D 1230 67, 82
			NSYAEDLEDF14S3D 73	NSYAEPF3D 1240 67, 82
			NSYAEDLEDF14S3D 73	NSYAEPF3D 1250 67, 82
			NSYAEDLEDF14S3D 73	NSYAEPF3D 1260 67, 82
			NSYAEDLEDF14S3D 73	NSYAEPF3D 1270 67, 82
			NSYAEDLEDF14S3D 73	NSYAEPF3D 1280 67, 82
			NSYAEDLEDF14S3D 73	NSYAEPF3D 1290 67, 82
			NSYAEDLEDF14S3D 73	NSYAEPF3D 1300 67, 82
			NSYAEDLEDF14S3D	

Reference and Page	Reference and Page	Reference and Page	Reference and Page	Reference and Page
NSYAES228SB 42	NSYAMRD29357TB 182	<b>NSYB...</b>	NSYBN606 261, 268	NSYBPSDX6 498
NSYAES238SB 42	NSYAMRD30357SB 42	NSYB204 261, 268	NSYBN608 261, 268	NSYBPSDX8 498
NSYAES248SB 42	NSYAMRD34155TB 182	NSYB404 261, 268	NSYBN610 261, 268	NSYBRF12PLA 233
NSYAES258SB 42	NSYAMRD343515TB 182	NSYB406 261, 268	NSYBP126 22, 118	NSYBRF17PLA 233
NSYAES268SB 42	NSYAMRD34357TB 182	NSYBANPLA53 231	NSYBP128 22, 118	NSYBRF21PLA 233
NSYAES338SB 42	NSYAMRD40357SB 42	NSYBANPLA54 231	NSYBP146 22, 118	NSYBRF26PLA 233
NSYAES348SB 42	NSYAMRD50357SB 42	NSYBANPLA56 231	NSYBP148 22, 118	NSYBRF35PLA 233
NSYAES358SB 42	NSYAMRD60357SB 42	NSYBANPLA73 231	NSYBP166 22, 118	NSYBRF8PLA 233
NSYAES368SB 42	NSYAMRD80357SB 42	NSYBANPLA74 231	NSYBP168 22, 118	NSYBRP11PLA 233
NSYAEUBU148 42	NSYAPFWM 89	NSYBANPLA76 231	NSYBP1810 22, 118	NSYBRP16PLA 233
NSYAEUBU41SC 98	NSYAPFXWM 97, 155, 312	NSYBCE10 135	NSYBP1812 22, 118	NSYBRP20PLA 233
NSYAEUBU61SC 98	NSYAPU10F3 293	NSYBCE12 135	NSYBP184 22, 118	NSYBRP25PLA 233
NSYAEUBUSC 98	NSYAPU10F3S 293	NSYBCE16 135	NSYBP186 22, 118	NSYBRP7PLA 233
NSYAMCSF 87, 236, 241, 268	NSYAPU10S3 293	NSYBCE3 135	NSYBP188 22, 118	NSYBTAS3D100 490, 491, 499
NSYAMFEP154TB 181, 182	NSYAPU10S3S 293	NSYBCE4 135	NSYBP2010 23, 119	NSYBTAS3D120 490, 491
NSYAMFEP204TB 181, 182	NSYAPU19F6CB 293	NSYBCE6 135	NSYBP2012 23, 119	NSYBTAS3D140 490
NSYAMFEP304TB 181, 182	NSYAPU19F7FA 293	NSYBCE8 135	NSYBP2016 23, 119	NSYBTAS3D60 490, 491, 499
NSYAMFESTB 181, 182	NSYAPU19F8S 293	NSYBCME 101, 166, 203	NSYBP202 23, 119	NSYBTAS3D70 490, 491, 499
NSYAMFET154TB 181, 182	NSYAPU19F9 293	NSYBCPL 26, 101, 203, 352	NSYBP204 23, 119	NSYBTAS3D80 490, 491, 499
NSYAMFET204TB 181, 182	NSYAPU19S6CB 293	NSYBCPLA 225	NSYBP206 23, 119	NSYBU108PLM 27, 201
NSYAMFET304TB 181, 182	NSYAPU19S7FA 293	NSYBE27 190, 191	NSYBP207 493	NSYBUPLM 27, 201
NSYAMFET304TB 181, 182	NSYAPU19S8S 293	NSYBEGN1054HD 226, 310	NSYBP208 23, 119	<b>NSYC...</b>
NSYAMFSTB 42, 45	NSYAPU19S9 293	NSYBEGN1074HD 226, 310	NSYBP210 23, 119	NSYCAAPV 413
NSYAMFSTB 171, 181, 182	NSYAPU19UK6S 293	NSYBEGN12124HD 226, 310	NSYBP212 23, 119	NSYCAAPVHD 315, 413
NSYAMPA1916TB 181	NSYAPU19UK7 293	NSYBEGN12126HD 226, 310	NSYBP224 23, 119	NSYCAC228RMF 420
NSYAMPA2419TB 181	NSYAPUB 293	NSYBEGN12124HD 226, 310	NSYBP226 23, 119	NSYCAEPPF 490
NSYAMPA2924TB 181	NSYAPUBV 293	NSYBEGN1254HD 226, 310	NSYBP228 23, 119	NSYCAF104X95X 420
NSYAMPA3429TB 181	NSYAPUF10S 293	NSYBEGN1274HD 226, 310	NSYBPA7032 303	NSYCAF108 416
NSYAMPM1916TB 181	NSYAPUF12CB 293	NSYBEGN1276HD 226, 310	NSYBPA7035 303	NSYCAF125 412
NSYAMPM2419TB 181	NSYAPUS10S 293	NSYBEGN1276HD 226, 310	NSYBPC3 289	NSYCAF125L55 412, 414
NSYAMPM2924TB 181	NSYAPUS12CB 293	NSYBEGN15124HD 226, 310	NSYBPC5 289	NSYCAF125M 412
NSYAMPM3429TB 181	NSYAS25 190	NSYBEGN15126HD 226, 310	NSYBPI126 124	NSYCAF125O 412
NSYAMRD11155TB 182	NSYASPLA001 496	NSYBEGN15124HD 226, 310	NSYBPI166 124	NSYCAF125T 412
NSYAMRD11357TB 182	NSYASPLA002 496	NSYBEGN15126HD 226, 310	NSYBPI168 124	NSYCAF130X110X 420
NSYAMRD15357SB 42	NSYASPLA003 496	NSYBEGN1574HD 226, 310	NSYBPI1810 124	NSYCAF170X190X 420
NSYAMRD16155TB 182	NSYASPLM 497	NSYBEGN1576HD 226, 310	NSYBPI186 124	NSYCAF190 315, 317, 413
NSYAMRD16357TB 182	NSYASPLM32 497	NSYBGN2074HD 310	NSYBPI188 124	NSYCAF223 412
NSYAMRD19155TB 182	NSYATM27 189	NSYBGN774HD 226, 310	NSYBPI2010 124	NSYCAF223L55 412, 414
NSYAMRD19357TB 182	NSYATP72G 88	NSYBGN776HD 226, 310	NSYBPI2012 124	NSYCAF223M 412
NSYAMRD20357SB 42	NSYATP72MS 155	NSYBICRN 492, 498	NSYBPI204 124	NSYCAF223O 412
NSYAMRD24155TB 182	NSYAUPG1 205, 219	NSYBL27 190	NSYBPI206 124	NSYCAF228R 420
NSYAMRD243515TB 182	NSYAUPG5 205, 219	NSYBLKH123 146	NSYBPI208 124	NSYCAF291 412
NSYAMRD24357TB 182	NSYAUPGS 205, 219	NSYBN204 261, 268	NSYBPI210 124	NSYCAF291L55 412, 414
NSYAMRD29155TB 182	NSYAVD1U1450 418	NSYBN206 261, 268	NSYBPI212 124	NSYCAF291L55 412, 414
NSYAMRD293515TB 182	NSYAVD1U480 418	NSYBN404 261, 268	NSYBPI226 124	
	NSYAVD1U550M48 418	NSYBN406 261, 268	NSYBPI228 124	
	NSYAVD1U970 418	NSYBN408 261, 268	NSYBPSD10 497	
	NSYAVG2U300 418		NSYBPSD12 497	
	NSYAZ3PLA 221		NSYBPSD6 497	
	NSYAZ4PLA 221		NSYBPSD8 497	
			NSYBPSDX10 498	
			NSYBPSDX12 498	





Reference and Page	Reference and Page	Reference and Page	Reference and Page	Reference and Page
NSYCPT17 289	NSYCRN108300 14, 86	NSYCRN64200 14, 86	NSYCRNG1012400D 14, 86	NSYCS400PLM 27, 204
NSYCPT29 289	NSYCRN108300P 14, 86	NSYCRN64200P 14, 86	NSYCRNG106400 14, 86	NSYCS500PLM 27, 204
NSYCPT37 289	NSYCRN108300T 14, 86	NSYCRN64200T 14, 86	NSYCRNG106400T 14, 86	NSYCS600PLM 27, 204
NSYCPT50 289	NSYCRN22150 14, 86	NSYCRN64250 14, 86	NSYCRNG108400 14, 86	NSYCS800PLM 27, 204
NSYCPTS17 289	NSYCRN23150 14, 86	NSYCRN64250P 14, 86	NSYCRNG108400T 14, 86	NSYCSP 125
NSYCPTS29 289	NSYCRN252150 14, 86	NSYCRN64250T 14, 86	NSYCRNG1210300D 14, 86	NSYCSSF 493
NSYCPTS37 289	NSYCRN252150P 14, 86	NSYCRN65150 14, 86	NSYCRNG1210400D 14, 86	NSYCTL300DLA 207
NSYCPTS50 289	NSYCRN325150 14, 86	NSYCRN65150P 14, 86	NSYCRNG1212300D 14, 86	NSYCTL300DLM 88
NSYCR100WU1 458	NSYCRN325150P 14, 86	NSYCRN65150T 14, 86	NSYCRNG1212400D 14, 86	NSYCTL400DLA 207
NSYCR100WU1C 456	NSYCRN325150T 14, 86	NSYCRN65200 14, 86	NSYCRNG12126300 14, 86	NSYCTL400DLM 88
NSYCR100WU2 458	NSYCRN325200 14, 86	NSYCRN65200P 14, 86	NSYCRNG126300T 14, 86	NSYCTL500DLA 207
NSYCR100WU2C 456	NSYCRN325200P 14, 86	NSYCRN65200T 14, 86	NSYCRNG126400 14, 86	NSYCTL500DLM 88
NSYCR100WU3 458	NSYCRN325200T 14, 86	NSYCRN65250 14, 86	NSYCRNG126400T 14, 86	NSYCTL500DLP 232
NSYCR100WU3C 456	NSYCRN33150 14, 86	NSYCRN65250P 14, 86	NSYCRNG126300 14, 86	NSYCTL600DLA 207
NSYCR10WU1 458	NSYCRN33150P 14, 86	NSYCRN65250T 14, 86	NSYCRNG126300T 14, 86	NSYCTL600DLM 88
NSYCR10WU1C 456	NSYCRN33150T 14, 86	NSYCRN66200 14, 86	NSYCRNG126400 14, 86	NSYCTL750DLP 232
NSYCR10WU2 458	NSYCRN33200 14, 86	NSYCRN66200T 14, 86	NSYCRNG126400T 14, 86	NSYCTL800DLA 207
NSYCR10WU2C 456	NSYCRN33200P 14, 86	NSYCRN66250 14, 86	NSYCRNG128300 14, 86	NSYCTL800DLM 88
NSYCR150WU1 458	NSYCRN33200T 14, 86	NSYCRN66250P 14, 86	NSYCRNG128300T 14, 86	NSYCYU1050W230VL 450
NSYCR150WU1C 456	NSYCRN34200 14, 86	NSYCRN66250T 14, 86	NSYCRNG128300T 14, 86	NSYCYU1050W230VR 450
NSYCR150WU2 458	NSYCRN34200T 14, 86	NSYCRN66300 14, 86	NSYCRNG128400 14, 86	NSYCYU10K3P4 438, 450
NSYCR150WU2C 456	NSYCRN345150 14, 86	NSYCRN66300P 14, 86	NSYCRNG128400T 14, 86	NSYCYU10K3P460 438, 450
NSYCR150WU3 458	NSYCRN43150 14, 86	NSYCRN66300T 14, 86	NSYCRNG1410300D 14, 86	NSYCYU1460W230VR 450
NSYCR170W230VVC 456	NSYCRN43150P 14, 86	NSYCRN68300 14, 86	NSYCRNG810300D 14, 86	NSYCYU15K3P4 438, 450
NSYCR20WU1 458	NSYCRN43150T 14, 86	NSYCRN68300T 14, 86	NSYCRNG812300D 14, 86	NSYCYU1650W230VL 450
NSYCR20WU1C 456	NSYCRN43200 14, 86	NSYCRN75200 14, 86	NSYCRNG86400 14, 86	NSYCYU1650W230VR 450
NSYCR20WU2 458	NSYCRN43200P 14, 86	NSYCRN75200P 14, 86	NSYCRNG86400T 14, 86	NSYCYU1800W400VL 450
NSYCR20WU2C 456	NSYCRN43200T 14, 86	NSYCRN75200T 14, 86	NSYCRNGSDR 15, 87, 237, 240	NSYCYU1K 436, 450
NSYCR20WU3 458	NSYCRN44200 14, 86	NSYCRN75250 14, 86	NSYCRP1W120VTVC 458	NSYCYU1K2 436, 450
NSYCR250W115VV 458	NSYCRN44200P 14, 86	NSYCRN75250P 14, 86	NSYCRP1W230VTVC 458	NSYCYU1K22P4 436, 450
NSYCR250W230VV 458	NSYCRN44200T 14, 86	NSYCRN75250T 14, 86	NSYCRS100W120V 453	NSYCYU1K22P4 436, 450
NSYCR400W115VV 458	NSYCRN46250 14, 86	NSYCRN86200 14, 86	NSYCRS100W240V 453	NSYCYU1K2P4UL 436, 450
NSYCR400W230VV 458	NSYCRN46250P 14, 86	NSYCRN86200P 14, 86	NSYCRS10W120V 453	NSYCYU1K2R 440, 450
NSYCR50WU1C 456	NSYCRN46250T 14, 86	NSYCRN86200T 14, 86	NSYCRS10W240V 453	NSYCYU1K2RUL 440, 450
NSYCR50WU2C 456	NSYCRN46300 14, 86	NSYCRN86250 14, 86	NSYCRS200W115V 458	NSYCYU1K2UL 436, 450
NSYCR50WU3C 456	NSYCRN46300T 14, 86	NSYCRN86250P 14, 86	NSYCRS200W120V 453	NSYCYU1K5R 440, 450
NSYCR55WU1 458	NSYCRN54150 14, 86	NSYCRN86250T 14, 86	NSYCRS200W230V 458	NSYCYU1K5RUL 440, 450
NSYCR55WU2 458	NSYCRN54150P 14, 86	NSYCRN86300 14, 86	NSYCRS200W240V 453	NSYCYU1K6 436, 450
NSYCR55WU3 458	NSYCRN54150T 14, 86	NSYCRN86300P 14, 86	NSYCRS200W240V 453	NSYCYU1K62P4 436, 450
NSYCRAF 458	NSYCRN54200 14, 86	NSYCRN86300T 14, 86	NSYCRS25W120V 453	NSYCYU1K62P4UL 436, 450
NSYCRAFD 458	NSYCRN54200P 14, 86	NSYCRN88200 14, 86	NSYCRS25W240V 453	NSYCYU1K6UL 436, 450
NSYCRN106250 14, 86	NSYCRN54200T 14, 86	NSYCRN88200P 14, 86	NSYCRS50W120V 453	NSYCYU1KUL 436, 450
NSYCRN106250P 14, 86	NSYCRN54250 14, 86	NSYCRN88200T 14, 86	NSYCRS50W240V 453	NSYCYU2000W400VR 450
NSYCRN106250T 14, 86	NSYCRN54250P 14, 86	NSYCRN88300 14, 86	NSYCRS100W120V 453	NSYCYU240W230VL 450
NSYCRN106300 14, 86	NSYCRN54250T 14, 86	NSYCRN88300P 14, 86	NSYCRS10W120V 453	
NSYCRN106300P 14, 86	NSYCRN55250 14, 86	NSYCRN88300T 14, 86	NSYCRS10W240V 453	
NSYCRN106300T 14, 86	NSYCRN55250P 14, 86	NSYCRNG1010300D 14, 86	NSYCRS200W115V 458	
NSYCRN108250 14, 86	NSYCRN55250T 14, 86	NSYCRNG1010300T 14, 86	NSYCRS200W120V 453	
NSYCRN108250P 14, 86	NSYCRN64150 14, 86	NSYCRNG1010300T 14, 86	NSYCRS200W230V 458	
NSYCRN108250T 14, 86	NSYCRN64150P 14, 86	NSYCRNG1012300D 14, 86	NSYCRS200W240V 453	
	NSYCRN64150T 14, 86		NSYCRS25W120V 453	
			NSYCRS25W240V 453	
			NSYCRS50W120V 453	
			NSYCRS50W240V 453	
			NSYCS200PLM 27, 195, 204	
			NSYCS300PLM 27, 204	



Reference and Page	Reference and Page	Reference and Page	Reference and Page	Reference and Page
NSYCW54 300	NSYDCRN22 492, 498	NSYDLA48P 27, 206, 207	NSYDLS12 497	NSYDPLM350 26, 27, 204, 352
NSYCW55 300	NSYDCRN23 492, 498	NSYDLA48PG 88	NSYDLS6 497	NSYDPLM43 497
NSYCW56 300	NSYDCRN2520 492, 498	NSYDLA66 27, 206, 207	NSYDLS8 497	NSYDPLM43T 497
NSYCW65 300	NSYDCRN3025 492, 498	NSYDLA66G 88	NSYDLSDF10 497	NSYDPLM54 497
NSYCW66 300	NSYDCRN3025T 492	NSYDLA84 27, 206, 207	NSYDLSDF12 497	NSYDPLM54T 497
NSYCW86 300	NSYDCRN3045 492, 498	NSYDLA84G 88	NSYDLSDF16 497	NSYDPLM64 497
<b>NSYD...</b>	NSYDCRN33 492, 498	NSYDLA88 27, 206, 207	NSYDLSDF8 497	NSYDPLM64T 497
NSYDA1510M 12, 34	NSYDCRN33T 492	NSYDLA88G 88	NSYDLSDX10 498	NSYDPLM75 497
NSYDA2015M 12, 34	NSYDCRN34 492, 498	NSYDLA110 88	NSYDLSDX12 498	NSYDPLM75T 497
NSYDA2520M 12, 34	NSYDCRN34T 492	NSYDLA135 88	NSYDLSDX6 498	NSYDPLM86 497
NSYDAN1510 12, 34	NSYDCRN43 492, 498	NSYDLA18 88	NSYDLSDX8 498	NSYDPLM86T 497
NSYDAN2015 12, 34	NSYDCRN43T 492	NSYDLA24 88	NSYDPA3 142, 297	NSYDPR100 260
NSYDAN2015D 12, 35	NSYDCRN44 492, 498	NSYDLA24 88	NSYDPA4 16, 50, 142, 297	NSYDPR120 260
NSYDAN2520 12, 34	NSYDCRN44T 492	NSYDLA36 88	NSYDPA44 16, 50, 142, 155, 297	NSYDPR200 262
NSYDAN2520D 12, 35	NSYDCRN46 492, 498	NSYDLA48 88	NSYDPA5 142, 297	NSYDPR200D 262
NSYDAN3025D 12, 35	NSYDCRN46T 492	NSYDLA64 88	NSYDPLA105 496	NSYDPR200T 262
NSYDAN3530D 12, 35	NSYDCRN54 492	NSYDLA88 88	NSYDPLA105H 496	NSYDPR25 260
NSYDB1010M 12, 34	NSYDCRN54T 492	NSYDLLSDF 497	NSYDPLA107 496	NSYDPR35 260
NSYDB1510M 12, 34	NSYDCRN55 492, 498	NSYDLM168 88	NSYDPLA107H 496	NSYDPR45 260
NSYDB2015M 12, 34	NSYDCRN55T 492	NSYDLM24 88, 155	NSYDPLA107H 496	NSYDPR55 260
NSYDB2520M 12, 34	NSYDCRN64 492	NSYDLM240 88, 155	NSYDPLA125 496	NSYDPR60 260
NSYDB3025M 12, 34	NSYDCRN64T 492	NSYDLM48 88, 155	NSYDPLA125H 496	NSYDPR65 260
NSYDB3530M 12, 34	NSYDCRN65 492	NSYDLM48P 88, 155	NSYDPLA127 496	NSYDPR75 260
NSYDB88M 12, 34	NSYDCRN65T 492	NSYDLM48P 88	NSYDPLA127H 496	NSYDPR80 260
NSYDBN1010 12, 34	NSYDCRN66 492, 498	NSYDLM66/NSYDLM88 88	NSYDPLA155 496	NSYDS3D1010 490
NSYDBN1510 12, 34	NSYDCRN66T 492	NSYDLM84 88, 155	NSYDPLA155H 496	NSYDS3D1010T 490
NSYDBN2015 12, 34	NSYDCRN68 492, 498	NSYDLM112 88	NSYDPLA157 496	NSYDS3D105L 490
NSYDBN2015D 12, 35	NSYDCRN68T 492	NSYDLM84P 88, 155	NSYDPLA157H 496	NSYDS3D105R 490
NSYDBN2520 12, 34	NSYDCRN75 492	NSYDLP114 228, 30	NSYDPLA3 230	NSYDS3D105TL 490
NSYDBN2520D 12, 35	NSYDCRN75T 492	NSYDLP114P 228, 30	NSYDPLA4 230	NSYDS3D105TR 490
NSYDBN3025 12, 34	NSYDCRN86 492, 498	NSYDLP132 228, 30	NSYDPLA55 496	NSYDS3D106 490
NSYDBN3025D 12, 35	NSYDCRN86T 492	NSYDLP133 228, 30	NSYDPLA55H 496	NSYDS3D106L 490
NSYDBN3530 12, 34	NSYDCRN88 492	NSYDLP152 228, 30	NSYDPLA57 496	NSYDS3D106R 490
NSYDBN3530D 12, 35	NSYDCRN88T 492	NSYDLP165 228, 30	NSYDPLA57H 496	NSYDS3D106T 490, 491
NSYDBN88 12, 34	NSYDHS18 494	NSYDLP171 228, 30	NSYDPLA6 230	NSYDS3D108 490, 499
NSYDBP 100, 202	NSYDHS6 494	NSYDLP198 228, 30	NSYDPLA75 496	NSYDS3D108T 490, 491
NSYDBP 492	NSYDHSF 493	NSYDLP198P 228, 30	NSYDPLA75H 496	NSYDS3D1210 490
NSYDCE10 134	NSYDHSM2D 493	NSYDLP231 228, 30	NSYDPLA77 496	NSYDS3D1210T 490
NSYDCE12 134	NSYDL10 379	NSYDLP264 228, 30	NSYDPLA77H 496	NSYDS3D125L 490
NSYDCE168 280	NSYDL12 379	NSYDLP297 228, 30	NSYDPLM108 497	NSYDS3D125R 490
NSYDCE240 280	NSYDL16 379	NSYDLP57 228, 30	NSYDPLM108T 497	NSYDS3D125TL 490
NSYDCE2410 280	NSYDL6 379	NSYDLP76 228, 30	NSYDPLM200 26, 27, 204, 352	NSYDS3D125TR 490
NSYDCE244 280	NSYDL8 379	NSYDLP95 228, 30	NSYDPLM250 26, 27, 204, 352	NSYDS3D126 490
NSYDCE6 134	NSYDLA112 27, 206, 207	NSYDLP99 228, 30	NSYDPLM300 26, 27, 204, 352	NSYDS3D126L 490
NSYDCE8 134	NSYDLA234 27, 206, 207	NSYDLPLM18 27, 207	NSYDPLM3025 497	NSYDS3D126R 490
NSYDCM20 143, 166, 297	NSYDLA234G 88	NSYDLS12 186	NSYDPLM3025T 497	NSYDS3D126T 490
NSYDCRN106 492	NSYDLA24 27, 206, 207	NSYDLS24 186	NSYDPLM32 497	NSYDS3D128 490
NSYDCRN106T 492	NSYDLA24G 88	NSYDLS242 186	NSYDPLM32T 497	NSYDS3D145L 490
NSYDCRN108 492	NSYDLA48 27, 206, 207	NSYDLS36 186		NSYDS3D145R 490
NSYDCRN108T 492	NSYDLA48G 88	NSYDLS48 186		
		NSYDLS10 497		

Reference and Page	Reference and Page	Reference and Page	Reference and Page	Reference and Page
NSYDS3D32 490, 499	NSYDS3DB64 491	NSYDS3X33 495	NSYDSFX1812RH 495	NSYEC1251 20, 116, 134
NSYDS3D325 490	NSYDS3DC1010 491	NSYDS3X33H 495	NSYDSFX1816L 495	NSYEC126 20, 116, 134
NSYDS3D325T 490	NSYDS3DC106 491	NSYDS3X43 495	NSYDSFX1816LH 495	NSYEC1261 20, 116, 134
NSYDS3D33 490, 499	NSYDS3DC108 491	NSYDS3X43H 495	NSYDSFX1816R 495	NSYEC1262 20, 116, 134
NSYDS3D33T 490	NSYDS3DC1210 491	NSYDS3X43T 495	NSYDSFX1816RH 495	NSYEC128 20, 116, 134
NSYDS3D34 490	NSYDS3DC128 491	NSYDS3X44 495	NSYDSFX186 495, 496	NSYEC1281 20, 116, 134
NSYDS3D34T 490	NSYDS3DC32 491	NSYDS3X44H 495	NSYDSFX188 495, 496	NSYEC1282 20, 116, 134
NSYDS3D36T 490	NSYDS3DC33 491	NSYDS3X46 495	NSYDSFX188H 495	NSYEC164 20, 116, 134
NSYDS3D43 490, 499	NSYDS3DC43 491	NSYDS3X46H 495	NSYDSFX2010L 495, 496	NSYEC1641 20, 116, 134
NSYDS3D43T 490, 491	NSYDS3DC44 491	NSYDS3X54 495	NSYDSFX2010LH 495	NSYEC165 20, 116, 134
NSYDS3D44 490, 499	NSYDS3DC54 491	NSYDS3X54H 495	NSYDSFX2010R 495, 496	NSYEC1651 20, 116, 134
NSYDS3D44T 490	NSYDS3DC55 491	NSYDS3X54T 495	NSYDSFX2010RH 495	NSYEC166 20, 116, 134
NSYDS3D46 490	NSYDS3DC64 491	NSYDS3X64 495	NSYDSFX2010RH 495	NSYEC1661 20, 116, 134
NSYDS3D46T 490	NSYDS3DC66 491	NSYDS3X64H 495	NSYDSFX2012L 495, 496	NSYEC1662 20, 116, 134
NSYDS3D53 490	NSYDS3DC75 491	NSYDS3X64T 495	NSYDSFX2012LH 495	NSYEC2 284
NSYDS3D53T 490	NSYDS3DC86 491	NSYDS3X66 495	NSYDSFX2012RH 495	NSYEC3 284
NSYDS3D54 490, 499	NSYDS3DC88 491	NSYDS3X66H 495	NSYDSFX2012R 495, 496	NSYEC35 20, 116, 134
NSYDS3D54T 490, 491	NSYDS3DCD1010 491	NSYDS3X75 495	NSYDSFX2012RH 495	NSYEC351 20, 116, 134
NSYDS3D55 490	NSYDS3DCD106 491	NSYDS3X75H 495	NSYDSFX2016L 495, 496	NSYEC36 20, 116, 134
NSYDS3D55T 490	NSYDS3DCD108 491	NSYDS3X75T 495	NSYDSFX2016LH 495	NSYEC361 20, 116, 134
NSYDS3D56T 490	NSYDS3DCD1210 491	NSYDS3X86 495	NSYDSFX2016RH 495	NSYEC381 20, 116
NSYDS3D64 490, 499	NSYDS3DCD55 491	NSYDS3X86H 495	NSYDSFX2016R 495, 496	NSYEC4 284
NSYDS3D64T 490, 491	NSYDS3DCD66 491	NSYDS3X86T 495	NSYDSFX2016RH 495	NSYEC44 20, 116, 134
NSYDS3D65 490	NSYDS3DCD75 491	NSYDS3X88 495	NSYDSFX206 495, 496	NSYEC441 20, 116, 134
NSYDS3D65T 490	NSYDS3DCD86 491	NSYDS3X88H 495	NSYDSFX208 495, 496	NSYEC45 20, 116, 134
NSYDS3D66 490, 499	NSYDS3HF108 498	NSYDSD10L 497	NSYDSD10L 497	NSYEC451 20, 116, 134
NSYDS3D66T 490, 491	NSYDS3HF128 498	NSYDSD10R 497	NSYDSD10R 497	NSYEC461 20, 116, 134
NSYDS3D68 490	NSYDS3HF43 498	NSYDSD12L 497	NSYDSD12L 497	NSYEC481 20, 116, 134
NSYDS3D68T 490	NSYDS3HF46 498	NSYDSD12R 497	NSYDSD12R 497	NSYEC481 20, 116, 134
NSYDS3D75 490, 499	NSYDS3HF54 498	NSYDSD6 497	NSYDSD6 497	NSYEC5 284
NSYDS3D75T 490, 491	NSYDS3HF64 498	NSYDSD8 497	NSYDSD8 497	NSYEC6 284
NSYDS3D76T 490	NSYDS3HF66 498	NSYDSD10L 497	NSYDSD10L 497	NSYEC64 20, 116, 134
NSYDS3D810 490	NSYDS3HF75 498	NSYDSD10R 497	NSYDSD10R 497	NSYEC641 20, 116, 134
NSYDS3D85L 490	NSYDS3HF86 498	NSYDSD12L 497	NSYDSD12L 497	NSYEC65 20, 116, 134
NSYDS3D85R 490	NSYDS3X1010L 495	NSYDSD12R 497	NSYDSD12R 497	NSYEC651 20, 116, 134
NSYDS3D86 490, 499	NSYDS3X1010LH 495	NSYDSD16L 497	NSYDSD16L 497	NSYEC66 20, 116, 134
NSYDS3D86L 490	NSYDS3X1010R 495	NSYDSD16R 497	NSYDSD16R 497	NSYEC661 20, 116, 134
NSYDS3D86R 490	NSYDS3X1010RH 495	NSYDSD8 497	NSYDSD8 497	NSYEC662 20, 116, 134
NSYDS3D86T 490, 491	NSYDS3X108 495	NSYDSD10L 498	NSYDSD10L 498	NSYEC68 20, 116, 134
NSYDS3D88 490	NSYDS3X108H 495	NSYDSD10R 498	NSYDSD10R 498	NSYEC681 20, 116, 134
NSYDS3D88T 490	NSYDS3X108T 495	NSYDSD12L 498	NSYDSD12L 498	NSYEC682 20, 116, 134
NSYDS3DB2530 491	NSYDS3X1210L 495	NSYDSD12R 498	NSYDSD12R 498	NSYEC7 284
NSYDS3DB2540 491	NSYDS3X1210LH 495	NSYDSD6 498	NSYDSD6 498	NSYEC84 20, 116, 134
NSYDS3DB2550 491	NSYDS3X1210R 495	NSYDSD8 498	NSYDSD8 498	NSYEC841 20, 116, 134
NSYDS3DB33 491	NSYDS3X1210RH 495	NSYDSFX1410L 495	NSYDSFX1410L 495	NSYEC85 20, 116, 134
NSYDS3DB34 491	NSYDS3X128 495	NSYDSFX1410R 495	NSYDSFX1410R 495	NSYEC851 20, 116, 134
NSYDS3DB35 491	NSYDS3X128H 495	NSYDSFX168 495	NSYDSFX168 495	NSYEC86 20, 116, 134
NSYDS3DB36 491	NSYDS3X32 495	NSYDSFX1812L 495, 496	NSYDSFX1812L 495, 496	NSYEC861 20, 116, 134
NSYDS3DB43 491	NSYDS3X325 495	NSYDSFX1812LH 495	NSYDSFX1812LH 495	NSYEC862 20, 116, 134
NSYDS3DB48 491	NSYDS3X325H 495	NSYDSFX1812R 495, 496	NSYDSFX1812R 495, 496	NSYEC88 20, 116, 134
NSYDS3DB54 491	NSYDS3X32H 495			NSYEC881 20, 116, 134
				NSYEC882 20, 116, 134

Reference and Page	Reference and Page	Reference and Page	Reference and Page	Reference and Page
NSYECA22 265	NSYEX146 266	NSYFXT6040 259	NSYIN3113A1 144, 225, 381	NSYINT91 144, 381
NSYECA42 265	NSYEX158 266	NSYFXT6050 259	NSYIN3122E1 144, 225, 381	NSYINUSA1 144, 381
NSYECA44 265	NSYEX166 266	NSYFXT6060 259, 386	NSYIN3123A1 144, 225, 381	<b>NSYK...</b>
NSYECB1M153 17, 51, 251, 302	NSYEX186 266	NSYFXT8040 259	NSYIN3131A1 144, 225, 381	NSYKNM3 242
NSYECPC15 284	NSYEX206 266	NSYFXT8050 259	NSYIN3133A1 144, 225, 381	NSYKNM6 155, 242
NSYECPC3 284	NSYEX208 266	NSYFXT8060 259	NSYIN3422E1 144, 225, 381	NSYKPLM 26, 100, 203, 352
NSYECPC5 284	NSYEX306 266	<b>NSYG...</b>	NSYIN3432E1 144, 225, 381	NSYKSKAV 313
NSYECPC6 284	NSYEX308 266	NSYGB140 418	NSYIN405E1 144, 225, 381	<b>NSYL...</b>
NSYECPC9 284	NSYEX406 266	NSYGDD 490	NSYIN421E1 144, 225, 381	NSYLAM14T5 295
NSYECPLAZ103 31, 219	NSYEX408 266	NSYGFR166P 267	NSYIN4551 144, 225, 381	NSYLAM1U 294
NSYECPLAZ104 31, 219	NSYEX506 266	NSYGFR95M55 267	NSYIN6101 144, 225	NSYLAM75 16, 50
NSYECPLAZ123 31, 219	NSYEX508 266	NSYGFR95M63 267	NSYINASSA2 145	NSYLAM8T5 295
NSYECPLAZ124 31, 219	NSYEX608 266	NSYGFR95M65 267	NSYINBENZ1 144, 381	NSYLAMC 294
NSYECPLAZ53 31, 219	NSYEX608 88	NSYGKTS6 494	NSYINCW1 144, 381	NSYLAMC120 294
NSYECPLAZ54 31, 219	<b>NSYF...</b>	<b>NSYH...</b>	NSYINDB31 144, 381	NSYLAMCB 294
NSYECPLAZ73 31, 219	NSYFB 241	NSYHLCR40 256	NSYINDB51 144, 225, 381	NSYLAMCD 294
NSYECPLAZ74 31, 219	NSYFB45 251	NSYHLCR50 256	NSYINDIN2 145, 225	NSYLAMCF 294
NSYEDCO 251	NSYFCESD1010 497	NSYHLCR60 256, 323	NSYINE11 144, 381	NSYLAMCS 155
NSYEDCOC 17, 51, 251	NSYFCESD108 497	NSYHLCR80 256	NSYINF1301 144, 225, 381	NSYLAMCS 294
NSYEDCOS 17, 51, 61, 302	NSYFCESD1210 497	NSYHSD 497	NSYINF1401 144, 225, 381	NSYLAMCU 294
NSYEDPLA 230	NSYFCESD128 497	NSYHSDF 497	NSYINFIAT1 144, 381	NSYLAMPOR 295
NSYEL136D6 303	NSYFCESD1610 497	NSYHSMX 496	NSYINH31 144, 381	NSYLC7 100, 101
NSYEL166D6 303	NSYFCESD168 497	NSYHSMX 495	NSYINICHEL8131 144, 381	NSYLC8 100, 101
NSYEL166D8 17, 51, 61, 83, 303	NSYFCESD168 497	<b>NSYI...</b>	NSYINICHEL8371 144, 381	NSYLCK12S6 494
NSYEL1710D6 303	NSYFCESD88 497	NSYID166 19, 115, 141	NSYINICHEL8791 144, 381	NSYLCK12SF 493
NSYEL2225D8 303	NSYFCESD810 497	NSYID168 19, 115, 141	NSYINKBA2 145	NSYLCK14SF 493
NSYEL226D6 303	NSYFCESD88 497	NSYID1810 19, 115, 141	NSYINKFAC2 145, 225	NSYLCK16S6 494
NSYEL2510D6 303	NSYFCG100 286	NSYID186 19, 115, 141	NSYINKJIS2 145, 225	NSYLCK16SF 493
NSYEL3525D8 17, 51, 303	NSYFCG120 286	NSYID188 19, 115, 141	NSYINKR2 145, 225	NSYLCK18S6 494
NSYEMA20 265	NSYFCG160 286	NSYID200 19, 115, 141	NSYINLCRN 15, 50, 61, 155, 297, 330, 333	NSYLCK18SF 493
NSYEMA40 265	NSYFCG60 286	NSYID208 19, 115, 141	NSYINS61 144, 225, 381	NSYLCK20S6 494
NSYEMPOLN 494, 497	NSYFCG80 286	NSYID226 141	NSYINS71 144, 225, 381	NSYLCK20SF 493
NSYEMR 15, 86, 237	NSYFCMX 167	NSYID228 141	NSYINS81 144, 225, 381	NSYLCK22S6 494
NSYEN20 265	NSYFDLSD 497	NSYID242E1 144, 225, 381	NSYINS8G1 144, 381	NSYLCK22SF 493
NSYEN40 265	NSYFMPHD 310	NSYIN1242E2 145, 225	NSYINS8H1 144, 381	NSYLCKSF 493
NSYEN60 265	NSYFMPLA 219	NSYIN1332E1 144, 225, 381	NSYINT101 144, 381	NSYLCKWSF 493
NSYETF 251	NSYFNM6 250, 268	NSYIN1242E2 145, 225	NSYINT61 144, 225, 381	NSYLCR40 256
NSYETU118 266	NSYFNM8 250, 268	NSYIN2124E1 144, 381	NSYINT71 144, 381	NSYLCR50 256
NSYETU48 266	NSYFPLS1827 186	NSYIN2131A1 144, 225, 381	NSYINT81 144, 225, 381	NSYLCR60 256
NSYETU58 266	NSYFPLS2727 186	NSYIN2132A1 144, 225, 381		NSYLD5 100, 101
NSYETU79 266	NSYFPLS2736 186	NSYIN2331A1 144, 225, 381		NSYLSS3X10 495
NSYEVA20 265	NSYFPLS2754 186	NSYIN241 144, 381		NSYLSS3X12 495
NSYEVA40 265	NSYFPLS3636 186	NSYIN2433A1 144, 225, 381		NSYLSSDX 498
NSYEX1006 266	NSYFPLS3654 186	NSYIN2452E1 144, 225, 381		NSYLSSF14 496
NSYEX1008 266	NSYFPLS3672 186			NSYLSSF16 496
NSYEX106 266	NSYFPLS5454 186			NSYLSSF18 496
NSYEX126 266	NSYFPLS5472 186			NSYLSSF20 496
	NSYFSP27270 189			NSYLSUP 256
	NSYFSP27360 189			NSYLT27 190
	NSYFSP27540 189			
	NSYFSPLAZ 223			

Reference and Page	Reference and Page	Reference and Page	Reference and Page	Reference and Page
NSYLT8 100, 101	NSYMF106 15, 16, 50, 60, 82, 86, 155, 236	NSYMM1010WH 16, 60, 82	NSYMM43WH 16, 60	NSYMP168 19, 21, 22, 25, 115, 116, 118, 167, 242, 312
<b>NSYM...</b>	NSYMF108 15, 16, 24, 26, 27, 50, 60, 82, 86, 155, 236, 352	NSYMM106 15, 16, 50, 60, 82, 86, 155, 236, 312	NSYMM44 15, 16, 24, 50, 60, 86, 155, 236, 352, 376	NSYMP1810 19, 21, 22, 115, 116, 118, 242
NSYMB106 15, 87, 236	NSYMF1210 15, 16, 50, 60, 82, 86, 155, 236	NSYMM106WH 16, 60, 82	NSYMM44SB 42	NSYMP1812 19, 21, 22, 25, 115, 116, 118, 167, 242
NSYMB108 15, 27	NSYMF126 15, 86, 236	NSYMM108 15, 16, 24, 26, 27, 50, 60, 82, 86, 155, 236, 312, 352	NSYMM44WH 16, 60	NSYMP1816 19, 25, 115, 167, 242
NSYMB108 87, 236	NSYMF128 15, 16, 50, 60, 86, 155, 236	NSYMM108WH 16, 60, 82	NSYMM45SB 42	NSYMP186 19, 21, 22, 25, 115, 116, 118, 167, 242
NSYMB1210 15, 87, 236	NSYMF2PLAZ4 307, 310	NSYMM11SB 42	NSYMM46SB 42	NSYMP188 19, 21, 22, 25, 115, 116, 118, 167, 242
NSYMB3025 15, 27, 87, 236	NSYMF2PLAZ6 307, 310	NSYMM1210 15, 16, 24, 50, 60, 82, 86, 155, 236	NSYMM48 236	NSYMP1816 19, 25, 115, 167, 242
NSYMB32 15, 27, 87, 236	NSYMF32 15, 16, 24, 50, 60, 86, 55, 236	NSYMM1210WH 16	NSYMM48SB 42	NSYMP186 19, 21, 22, 25, 115, 116, 118, 167, 242
NSYMB33 15, 87, 236	NSYMF33 15, 16, 50, 60, 82, 86, 155, 236, 352	NSYMM1210WH 60, 82	NSYMM53 236	NSYMP188 19, 21, 22, 25, 115, 116, 118, 167, 242
NSYMB43 15, 27, 87, 236	NSYMF43 15, 16, 24, 26, 27, 50, 60, 86, 155, 236, 352	NSYMM1212 15, 86, 236	NSYMM54 15, 16, 24, 26, 27, 50, 60, 86, 155, 236, 312, 352	NSYMP1816 19, 25, 115, 167, 242
NSYMB54 15, 27, 87, 236	NSYMF44 15, 16, 50, 60, 86, 155, 236, 352, 376	NSYMM126 15, 86, 236	NSYMM54WH 16, 60	NSYMP2010 19, 21, 23, 25, 115, 116, 119, 167, 242
NSYMB64 15, 27, 87, 236	NSYMF53 236	NSYMM128 24	NSYMM55 15, 16, 50, 60, 82, 86, 236	NSYMP2012 19, 21, 23, 25, 115, 116, 119, 167, 242
NSYMB65 15, 87, 236	NSYMF54 15, 16, 24, 26, 27, 50, 60, 86, 155, 236, 352	NSYMM128 15, 16, 24, 50, 60, 86, 155, 236	NSYMM55WH 16, 60, 82	NSYMP2016 19, 21, 23, 25, 115, 116, 119, 167, 242
NSYMB75 15, 27, 87, 236	NSYMF55 15, 16, 50, 60, 82, 86, 155, 236	NSYMM128WH 16, 60	NSYMM64 15, 16, 24, 26, 27, 50, 60, 86, 155, 236, 312, 313, 352, 376	NSYMP206 19, 21, 23, 25, 115, 116, 119, 167, 242
NSYMB86 15, 27, 87, 236	NSYMF64 15, 16, 24, 26, 27, 50, 60, 86, 155, 236, 352, 376	NSYMM13SB 42	NSYMM64WH 16, 60	NSYMP2016 19, 21, 23, 25, 115, 116, 119, 167, 242
NSYMCCSD4 497	NSYMF65 15, 86, 236	NSYMM1410 15, 86, 236	NSYMM65 15, 86, 236	NSYMP206 19, 21, 23, 25, 115, 116, 119, 167, 242
NSYMCCSD6 497	NSYMF66 15, 16, 50, 60, 82, 86, 155, 236, 352	NSYMM14SB 42	NSYMM66 15, 16, 24, 50, 60, 82, 86, 155, 236, 312, 352	NSYMP208 19, 21, 23, 25, 115, 116, 119, 167, 242, 312, 323
NSYMCSX 166	NSYMF75 15, 16, 24, 26, 27	NSYMM22 15, 86, 236	NSYMM66WH 16, 60, 82	NSYMP2210 116, 119
NSYMD108 15, 24, 87, 236, 352	NSYMF75 50, 60, 82, 86, 155, 236, 352	NSYMM22SB 42	NSYMM75 15, 16, 24, 26, 27, 50, 60, 82, 86, 155, 236, 312, 352	NSYMP2210 21, 23, 242
NSYMD128 15, 87, 236, 352	NSYMF86 15, 16, 24, 26, 27, 50, 60, 82, 86, 155, 236, 352	NSYMM23 236	NSYMM75WH 16, 60, 82	NSYMP2212 21, 23, 116, 119, 242
NSYMD43 15, 24, 87, 236, 352	NSYMF88 15, 16, 50, 60, 86, 155, 236	NSYMM23SB 42	NSYMM76 236	NSYMP226 21, 23, 116, 119, 242
NSYMD54 15, 24, 87, 236, 352	NSYMF88 15, 16, 50, 60, 86, 155, 236	NSYMM24SB 42	NSYMM86 15, 16, 24, 26, 27, 50, 60, 82, 86, 155, 236, 312, 352	NSYMP228 21, 23, 116, 119, 242
NSYMD64 15, 24, 87, 236, 352	NSYMF88 15, 16, 50, 60, 86, 155, 236	NSYMM2520 15, 86, 236	NSYMM86WH 16, 60, 82	NSYMPB4SD 383
NSYMD66 15, 87, 236, 352	NSYMF88 15, 16, 50, 60, 86, 155, 236	NSYMM2540 236	NSYMM88 15, 16, 24, 155, 236, 312, 50, 60, 86	NSYMPB6SD 383
NSYMD75 15, 24, 87, 236, 352	NSYMF88 15, 16, 50, 60, 86, 155, 236	NSYMM2550 236	NSYMM88WH 16, 60	NSYMPBSD 383
NSYMD86 15, 24, 87, 236, 352	NSYMF88 15, 16, 50, 60, 86, 155, 236	NSYMM26SB 42	NSYMP1210 19, 115, 242	NSYMPFA 326
NSYMDCM20 143, 297	NSYMF88 15, 16, 50, 60, 86, 155, 236	NSYMM28SB 42	NSYMP1212 19, 115, 242, 312	NSYMP108 27, 236
NSYMDVR10 16, 50, 60, 82, 87, 241	NSYMF88 15, 16, 50, 60, 86, 155, 236	NSYMM3025 15, 24, 26, 27, 86, 155, 236, 352	NSYMP126 21, 22, 116, 118, 242, 312	NSYMP3025 27, 236
NSYMDVR12 16, 50, 60, 82, 87, 241	NSYMF88 15, 16, 50, 60, 86, 155, 236	NSYMM3045 15, 86, 236	NSYMP128 19, 21, 22, 115, 116, 118, 242, 312	NSYMP32 27, 236
NSYMDVR3 16, 50, 60, 87, 241	NSYMF88 15, 16, 50, 60, 86, 155, 236	NSYMM32 15, 16, 24, 27, 50, 60, 86, 155, 236, 312, 352	NSYMP1410 19, 25, 115, 167, 242, 382	NSYMP43 27, 236
NSYMDVR3M 241	NSYMF88 15, 16, 50, 60, 86, 155, 236	NSYMM32WH 16, 60	NSYMP1412 19, 115, 242, 382	NSYMP54 27, 236
NSYMDVR4 16, 50, 60, 87, 241	NSYMF88 15, 16, 50, 60, 86, 155, 236	NSYMM33 15, 16, 24, 50, 60, 86, 155, 236, 352	NSYMP146 19, 21, 22, 115, 116, 118, 242	NSYMP64 27, 236
NSYMDVR5 16, 50, 60, 82, 87, 241	NSYMF88 15, 16, 50, 60, 86, 155, 236	NSYMM33SB 42	NSYMP148 19, 115, 242, 382	NSYMP75 27, 236
NSYMDVR6 16, 50, 60, 82, 87, 241	NSYMF88 15, 16, 50, 60, 86, 155, 236	NSYMM33WH 16, 60	NSYMP1610 19, 115, 242	NSYMP86 27, 236
NSYMDVR7 16, 50, 60, 82, 87, 241	NSYMF88 15, 16, 50, 60, 86, 155, 236	NSYMM34SB 42	NSYMP162 19, 115, 242, 312	NSYMPRK10 243
NSYMDVR8 16, 50, 60, 82, 87, 241	NSYMF88 15, 16, 50, 60, 86, 155, 236	NSYMM35SB 42	NSYMP166 19, 21, 22, 115, 116, 118, 242, 312	NSYMPRK12 243
NSYMF1010 15, 16, 50, 60, 82, 86, 155, 236	NSYMF88 15, 16, 50, 60, 86, 155, 236	NSYMM36 236	NSYMP168 19, 21, 22, 115, 116, 118, 242, 312	NSYMPRK16 243
	NSYMF88 15, 16, 50, 60, 86, 155, 236	NSYMM36SB 42		NSYMPRK8 243
	NSYMF88 15, 16, 50, 60, 86, 155, 236	NSYMM38SB 42		NSYMR1010 15, 16, 50, 60, 82, 87, 155, 236,
	NSYMF88 15, 16, 50, 60, 86, 155, 236	NSYMM43 15, 16, 24, 26, 27, 50, 60, 86, 155, 236, 352		NSYMR1012 15, 87, 236



Reference and Page	Reference and Page	Reference and Page	Reference and Page	Reference and Page
NSYPLA553T 28, 214	NSYPLAT553 29, 215	NSYPLAZ774 28, 214	NSYPLM●●V 203	NSYPLM75T 26, 195, 196, 206
NSYPLA554 28, 214	NSYPLAT554 29, 215	NSYPLAZT10103 29, 215	NSYPLM108 16, 26, 50, 195, 196, 199, 206	NSYPLM75TV 26, 195, 196
NSYPLA554T 28, 214	NSYPLAT573 29, 215	NSYPLAZT10104 29, 215	NSYPLM108B 195	NSYPLM75V 26, 195
NSYPLA573 28, 214	NSYPLAT574 29, 215	NSYPLAZT10123 29, 215	NSYPLM108G 199, 200	NSYPLM86 16, 26, 50, 195, 196, 199, 206
NSYPLA573T 28, 214	NSYPLAT7103 29, 215	NSYPLAZT10124 29, 215	NSYPLM108G/TG 203	NSYPLM86B 195
NSYPLA574 28, 214	NSYPLAT7104 29, 215	NSYPLAZT10124 29, 215	NSYPLM108T 26, 195, 196, 206	NSYPLM86G 199
NSYPLA574T 28, 214	NSYPLAT7123 29, 215	NSYPLAZT1053 29, 215	NSYPLM3025 26, 195	NSYPLM86P 195
NSYPLA7103 28, 214	NSYPLAT7124 29, 215	NSYPLAZT1054 29, 215	NSYPLM3025B 195	NSYPLM86T 26, 195, 196, 206
NSYPLA7103T 28, 214	NSYPLAT753 29, 215	NSYPLAZT1073 29, 215	NSYPLM3025G 201	NSYPLM86TV 26, 195, 196
NSYPLA7104 28, 214	NSYPLAT754 29, 215	NSYPLAZT1074 29, 215	NSYPLM3025G/TG 207	NSYPLM86V 26, 195
NSYPLA7104T 28, 214	NSYPLAT773 29, 215	NSYPLAZT12103 29, 215	NSYPLM3025P 195	NSYPLMEX108 26, 352, 353, 355
NSYPLA7123 28, 214	NSYPLAT774 29, 215	NSYPLAZT12104 29, 215	NSYPLM3025T 26, 195	NSYPLMEX3025 26, 352, 353
NSYPLA7123T 28, 214	NSYPLAZ10103 28, 214	NSYPLAZT12104 29, 215	NSYPLM32 16, 26, 50, 195, 200	NSYPLMEX43 26, 352, 355
NSYPLA7124 28, 214	NSYPLAZ10104 28, 214	NSYPLAZT12123 29, 215	NSYPLM32B 195	NSYPLMEX54 26, 352, 355
NSYPLA7124T 28, 214	NSYPLAZ10123 28, 214	NSYPLAZT12124 29, 215	NSYPLM32P 195	NSYPLMEX64 26, 352, 355
NSYPLA753 28, 214	NSYPLAZ10124 28, 214	NSYPLAZT1253 29, 215	NSYPLM32T 26, 195, 200	NSYPLMEX75 26, 352, 355
NSYPLA753T 28, 214	NSYPLAZ1053 28, 214	NSYPLAZT1254 29, 215	NSYPLM43 16, 26, 50, 195, 196, 206	NSYPLMEX86 26, 352, 355
NSYPLA754 28, 214	NSYPLAZ1054 28, 214	NSYPLAZT1273 29, 215	NSYPLM43B 195	NSYPLS●●● 190
NSYPLA754T 28, 214	NSYPLAZ1073 28, 214	NSYPLAZT1274 29, 215	NSYPLM43P 195	NSYPLS●●●DLS●●● 190
NSYPLA773 28, 214	NSYPLAZ1074 28, 214	NSYPLAZT15103 29, 215	NSYPLM43TV 26, 195, 196	NSYPLS1827 13, 186
NSYPLA773T 28, 214	NSYPLAZ12103 28, 214	NSYPLAZT15104 29, 215	NSYPLM43V 26, 195	NSYPLS1827 186
NSYPLA774 28, 214	NSYPLAZ12104 28, 214	NSYPLAZT15123 29, 215	NSYPLM54 16, 26, 50, 195, 196, 206	NSYPLS1827DLS12 186
NSYPLA774T 28, 214	NSYPLAZ12123 28, 214	NSYPLAZT15124 29, 215	NSYPLM54B 195	NSYPLS1827L 13, 186
NSYPLAT10103 29, 215	NSYPLAZ12124 28, 214	NSYPLAZT1553 29, 215	NSYPLM54G 200	NSYPLS24 379
NSYPLAT10104 29, 215	NSYPLAZ1253 28, 214	NSYPLAZT1554 29, 215	NSYPLM54P 195	NSYPLS2727 13, 186
NSYPLAT10123 29, 215	NSYPLAZ1254 28, 214	NSYPLAZT1573 29, 215	NSYPLM54T 26, 195, 196, 206	NSYPLS2727A 13, 186
NSYPLAT10124 29, 215	NSYPLAZ1273 28, 214	NSYPLAZT1574 29, 215	NSYPLM54TG 200	NSYPLS2727AL 13, 186
NSYPLAT1053 29, 215	NSYPLAZ1274 28, 214	NSYPLAZT5103 29, 215	NSYPLM54TV 26, 195, 196	NSYPLS2727DLS24 186
NSYPLAT1054 29, 215	NSYPLAZ15103 28, 214	NSYPLAZT5104 29, 215	NSYPLM54V 26, 195	NSYPLS2727L 13, 186
NSYPLAT1073 29, 215	NSYPLAZ15104 28, 214	NSYPLAZT5123 29, 215	NSYPLM64 16, 26, 50, 195, 196, 206	NSYPLS2736 13, 186
NSYPLAT1074 29, 215	NSYPLAZ15123 28, 214	NSYPLAZT5124 29, 215	NSYPLM64B 195	NSYPLS2736A 13, 186
NSYPLAT12103 29, 215	NSYPLAZ15124 28, 214	NSYPLAZT553 29, 215	NSYPLM64G 200	NSYPLS2736AL 13, 186
NSYPLAT12104 29, 215	NSYPLAZ1553 28, 214	NSYPLAZT554 29, 215	NSYPLM64P 195	NSYPLS2736L 13, 186
NSYPLAT12123 29, 215	NSYPLAZ1554 28, 214	NSYPLAZT573 29, 215	NSYPLM64T 26, 195, 196, 206	NSYPLS2754 13, 186
NSYPLAT12124 29, 215	NSYPLAZ1573 28, 214	NSYPLAZT574 29, 215	NSYPLM64TG 200	NSYPLS2754A 13, 186
NSYPLAT1253 29, 215	NSYPLAZ1574 28, 214	NSYPLAZT7103 29, 215	NSYPLM64TV 26, 195, 196	NSYPLS2754AL 13, 186
NSYPLAT1254 29, 215	NSYPLAZ5103 28, 214	NSYPLAZT7104 29, 215	NSYPLM64V 26, 195	NSYPLS30 379
NSYPLAT1273 29, 215	NSYPLAZ5104 28, 214	NSYPLAZT7123 29, 215	NSYPLM64V 26, 195	NSYPLS3627DLS24 186
NSYPLAT1274 29, 215	NSYPLAZ5123 28, 214	NSYPLAZT7124 29, 215	NSYPLM75 26, 195, 196, 199, 206	NSYPLS3627DLS36 186
NSYPLAT15103 29, 215	NSYPLAZ5124 28, 214	NSYPLAZT7153 29, 215	NSYPLM75B 195	NSYPLS3636 13, 186
NSYPLAT15104 29, 215	NSYPLAZ553 28, 214	NSYPLAZT753 29, 215	NSYPLM75G 199	NSYPLS3636L 13, 186
NSYPLAT15123 29, 215	NSYPLAZ554 28, 214	NSYPLAZT754 29, 215	NSYPLM75P 195	NSYPLS3654 13, 186
NSYPLAT15124 29, 215	NSYPLAZ573 28, 214	NSYPLAZT773 29, 215		
NSYPLAT1553 29, 215	NSYPLAZ574 28, 214	NSYPLAZT774 29, 215		
NSYPLAT1554 29, 215	NSYPLAZ7103 28, 214	NSYPLD114P 30		
NSYPLAT1573 29, 215	NSYPLAZ7104 28, 214	NSYPLHD 310		
NSYPLAT1574 29, 215	NSYPLAZ7123 28, 214			
NSYPLAT5103 29, 215	NSYPLAZ7124 28, 214			
NSYPLAT5104 29, 215	NSYPLAZ753 28, 214			
NSYPLAT5123 29, 215	NSYPLAZ754 28, 214			
NSYPLAT5124 29, 215	NSYPLAZ773 28, 214			
	NSYPLAZ774 28, 214			



Reference and Page	Reference and Page	Reference and Page	Reference and Page	Reference and Page
NSYPLS3654A 13, 186	NSYPMA5472 186	NSYPMM1010 30, 226	NSYPMP85120 25, 382	NSYPTZ6 230
NSYPLS3654AL 13, 186	NSYPMA55 30, 226	NSYPMM1012 30, 226	NSYPMP85160 382	NSYPTZ62P 230
NSYPLS3654L 13, 186	NSYPMA710 30, 226	NSYPMM105 30, 226, 310	NSYPMP8560 25, 382	NSYPUC27 191
NSYPLS3672A 13, 186	NSYPMA712 30, 226	NSYPMM107 30, 226, 310	NSYPMP8580 25, 382	NSYPUNX 167
NSYPLS3672AL 13, 186	NSYPMA75 30, 226	NSYPMM1210 30, 226	NSYPMR105 30, 226	<b>NSYR...</b>
NSYPLS5427DLS48 186, 191	NSYPMA77 30, 226	NSYPMM1212 30, 226, 310	NSYPMR107 30, 226	NSYRCK42 323
NSYPLS5454 13, 186	NSYPMA1010 30, 226	NSYPMM125 30, 226, 310	NSYPMR125 30, 226	NSYRE26 138, 420
NSYPLS5454A 13, 186	NSYPMA1012 30, 226	NSYPMM127 30, 226, 310	NSYPMR127 30, 226	NSYRE60 138, 420
NSYPLS5454AL 13, 186	NSYPMA105 30, 226	NSYPMM1510 30, 226	NSYPMR155 30, 226	NSYRETPLA 224
NSYPLS5454L 13, 186	NSYPMA107 30, 226	NSYPMM1512 30, 226, 310	NSYPMR157 30, 226	NSYRETPLAU 224, 228, 230
NSYPLS5472A 13, 186	NSYPMA1210 30, 226	NSYPMM155 30, 226	NSYPMR1827 186	NSYRPP2 376, 377
NSYPLS5472AL 13, 186	NSYPMA1212 30, 226	NSYPMM157 30, 226, 310	NSYPMR2727 186	NSYRPPX2 376, 377
NSYPLSC1827 13, 186	NSYPMA125 30, 226	NSYPMM1827 186	NSYPMR2736 186	NSYRSF104 493
NSYPLSC2727 13, 186	NSYPMA127 30, 226	NSYPMM207 310	NSYPMR2754 186	NSYRSF105 493
NSYPLSC2727A 13, 186	NSYPMA1510 30, 226	NSYPMM2727 186	NSYPMR3654 186	NSYRSF106 493
NSYPLSC2736 13, 186	NSYPMA1512 30, 226	NSYPMM2736 186	NSYPMR3672 186	NSYRSF108 493
NSYPLSC2736A 13, 186	NSYPMA155 30, 226	NSYPMM2754 186	NSYPMR5454 186	NSYRSF124 493
NSYPLSC2754 13, 186	NSYPMA157 30, 226	NSYPMM3636 186	NSYPMR5472 186	NSYRSF125 493
NSYPLSC2754A 13, 186	NSYPMA1827 186	NSYPMM3654 186	NSYPMR55 30, 226	NSYRSF126 493
NSYPLSC3636 13, 186	NSYPMA2727 186	NSYPMM3672 186	NSYPMR57 30, 226	NSYRSF128 493
NSYPLSC3654 13, 186	NSYPMA2736 186	NSYPMM510 30, 226	NSYPMR75 30, 226	NSYRSF164 493
NSYPLSC3654A 13, 186	NSYPMA277 186	NSYPMM5454 186	NSYPMR77 30, 226	NSYRSF165 493
NSYPLSC3672A 13, 186	NSYPMA2754 186	NSYPMM5472 186	NSYPPC54HD 499	NSYRSF166 493
NSYPLSC5454 13, 186	NSYPMA3636 186	NSYPMM55 30, 226, 310	NSYPPC56HD 499	NSYRSF35 493
NSYPLSC5454A 13, 186	NSYPMA3654 186	NSYPMM710 30, 226	NSYPPC74HD 499	NSYRSF36 493
NSYPLSC5472A 13, 186	NSYPMA3672 186	NSYPMM712 30, 226	NSYPPC76HD 499	NSYRSF38 493
NSYPLSP1827 13, 186	NSYPMA510 30, 226	NSYPMM75 30, 226, 310	NSYPPS... 326	NSYRSF44 493
NSYPLSP2727 13, 186	NSYPMA5454 186	NSYPMM77 30, 226, 310	NSYPPS166 124	NSYRSF45 493
NSYPLSP2736 13, 186	NSYPMA5472 186	NSYPMP300DLM 88	NSYPPS168 124	NSYRSF64 493
NSYPLSP2754 13, 186	NSYPMA55 30, 226	NSYPMP400DLA 207	NSYPPS184 124	NSYRSF65 493
NSYPLSP3636 13, 186	NSYPMA710 30, 226	NSYPMP400DLM 88	NSYPPS185 124	NSYRSF66 493
NSYPLSP3654 13, 186	NSYPMA712 30, 226	NSYPMP45100 382	NSYPPS204 124	NSYRSF84 493
NSYPLSP5454 13, 186	NSYPMA75 30, 226	NSYPMP45120 382	NSYPPS205 124	NSYRSF85 493
NSYPMA1010 30, 226	NSYPMA77 30, 226	NSYPMP45160 382	NSYPPS206 124	NSYRSF86 493
NSYPMA1012 30, 226	NSYPMA107 30, 226	NSYPMP4580 382	NSYPPS208 124	NSYRSF88 493
NSYPMA105 30, 226	NSYPMA1210 30, 226	NSYPMP5002DLP 232	NSYPPS226 124	NSYRSW27 19, 115
NSYPMA107 30, 226	NSYPMA1212 30, 226	NSYPMP500DLA 207	NSYPPS228 124	NSYRSW31 19, 115
NSYPMA1210 30, 226	NSYPMA125 30, 226	NSYPMP500DLM 88	NSYPPS27 190	NSYRSW36 19, 115
NSYPMA1212 30, 226	NSYPMA127 30, 226	NSYPMP500DLP 232	NSYPPSB 45	NSYRSW40 19, 115
NSYPMA1827 186	NSYPMA1827 186	NSYPMP500DLA 207	NSYPS2C27 189, 191	NSYRSWC27 19, 115
NSYPMA2727 186	NSYPMA2727 186	NSYPMP500DLP 232	NSYPS4C27 189, 191	NSYRSWC31 19, 115
NSYPMA2736 186	NSYPMA2736 186	NSYPMP600DLA 207	NSYPTDS1 391, 393	NSYRSWC36 19, 115
NSYPMA2754 186	NSYPMA2754 186	NSYPMP600DLM 88	NSYPTDS2 391, 393	NSYRSWC40 19, 115
NSYPMA3636 186	NSYPMA3636 186	NSYPMP7502DLP 232	NSYPTDS3 391, 393	<b>NSYS...</b>
NSYPMA3654 186	NSYPMA3654 186	NSYPMP750DLP 232	NSYPTDS4 391	NSYS12M6H 16, 50
NSYPMA3672 186	NSYPMA3672 186	NSYPMP800DLA 207	NSYPTDS5 391	NSYS13M5HS 16, 50, 61, 83, 155, 268
NSYPMA510 30, 226	NSYPMA510 30, 226	NSYPMP800DLM 88	NSYPTZ3 230	NSYS16M5HS 155, 245, 268
NSYPMA5454 186	NSYPMA5454 186	NSYPMP85100 25, 382	NSYPTZ4 230	NSYS16M6H 16, 50
			NSYPTZ42P 230	NSYS16M6HS 155, 268



Reference and Page	Reference and Page	Reference and Page	Reference and Page	Reference and Page
NSYSBMC208012 12, 42, 45	NSYSCX6050 166	NSYSDR120 260	NSYSF1810402D 20, 116	NSYSF2010502DP 20, 116
NSYSBMC303012 12, 42, 45	NSYSCX8040 166	NSYSDR200 262	NSYSF1810402DP 20, 116	NSYSF201050P 20, 116
NSYSBMC304012 12, 42, 45	NSYSCX8050 166	NSYSDR200B 262	NSYSF181040P 20, 116	NSYSF201050T 20, 116
NSYSBMC306012 12, 42, 45	NSYSCX8060 166	NSYSDR200BD 262	NSYSF181050 20, 116	NSYSF201060 20, 116
NSYSBMC308012 12, 42, 45	NSYSD10 370, 379	NSYSDR200D 262	NSYSF181050P 20, 116	NSYSF2010602D 20, 116
NSYSBMC308012 12, 42, 45	NSYSD10R 370, 377, 379	NSYSDR30B 260	NSYSF181060 20, 116	NSYSF2010602DP 20, 116
NSYSBMC308012 12, 42, 45	NSYSD12 370, 379	NSYSDR40B 260	NSYSF1810602D 20, 116	NSYSF201060P 20, 116
NSYSBMC404012 12, 42, 45	NSYSD12R 370, 377, 379	NSYSDR50A 260	NSYSF1810602DP 20, 116	NSYSF201060T 20, 116
NSYSBMC406012 12, 42, 45	NSYSD6 370, 379	NSYSDR60 260	NSYSF181060P 20, 116	NSYSF201080 20, 116
NSYSBMC406012 12, 42, 45	NSYSD6R 370, 377, 379	NSYSDR60A 260	NSYSF1812402D 20, 116	NSYSF201080P 20, 116
NSYSBMC408012 12, 42, 45	NSYSD8 370, 379	NSYSDR80 260	NSYSF1812402DP 20, 116	NSYSF2012402D 20, 116
NSYSBPLA 231, 233	NSYSD8R 370, 377, 379	NSYSDR80A 260	NSYSF1812502D 20, 116	NSYSF2012402DP 20, 116
NSYSBTB 247	NSYSDC42 376, 377	NSYSDR 143, 326	NSYSF1812502DP 20, 116	NSYSF2012502D 20, 116
NSYSC1030 138	NSYSDC43 376, 377	NSYSDRSDCR 236, 313	NSYSF1812502DP 20, 116	NSYSF2012502DP 20, 116
NSYSC1040 138	NSYSDC62 376, 377	NSYSDRSDCR300 15, 87, 240	NSYSF1812602D 20, 116	NSYSF2012602D 20, 116
NSYSC1050 138	NSYSDC63 376, 377	NSYSDRSDCR400 15, 87, 240	NSYSF1812602DP 20, 116	NSYSF2012602DP 20, 116
NSYSC1060 138	NSYSDCR10 298	NSYSDT• 326	NSYSF18440 20, 116	NSYSF2012802D 20, 116
NSYSC1230 138	NSYSDCR200 15, 24, 60, 82, 87, 155, 240, 352	NSYSDT5 142, 298	NSYSF18450 20, 116	NSYSF2012802DP 20, 116
NSYSC1240 138	NSYSDCR250 15, 24, 60, 87, 155, 240, 352	NSYSDT6 142, 298	NSYSF18460 20, 116	NSYSF2016402D 20, 116
NSYSC1250 138	NSYSDCR300 15, 24, 60, 87, 155, 240, 352	NSYSDT8 142, 298	NSYSF18640 20, 116	NSYSF2016402DP 20, 116
NSYSC1260 138	NSYSDCR4 298	NSYSDX10 25, 370, 377, 379	NSYSF18640P 20, 116	NSYSF2016502D 20, 116
NSYSC1640 138	NSYSDCR400 15, 60, 87, 240	NSYSDX12 25, 370, 377, 379	NSYSF18640T 20, 116	NSYSF2016502DP 20, 116
NSYSC1650 138	NSYSDCR5 298	NSYSDX6 25, 370, 377, 379	NSYSF18650 20, 116	NSYSF2016602D 20, 116
NSYSC1660 138	NSYSDCR6 298	NSYSDX8 25, 370, 377, 379	NSYSF18650P 20, 116	NSYSF2016602DP 20, 116
NSYSC1850 138	NSYSDCR8 298	NSYSF12640 20, 116	NSYSF18650T 20, 116	NSYSF20350 20, 116
NSYSC1860 138	NSYSDCX42 376, 377	NSYSF12640P 20, 116	NSYSF18660 20, 116	NSYSF20360 20, 116
NSYSC2050 138	NSYSDCX43 376, 377	NSYSF12660 20, 116	NSYSF18660P 20, 116	NSYSF20380 20, 116
NSYSC2060 138	NSYSDCX62 376, 377	NSYSF12660P 20, 116	NSYSF18660PC 385	NSYSF20440 20, 116
NSYSC2450 138	NSYSDCX63 376, 377	NSYSF12840 20, 116	NSYSF18680PC 385	NSYSF20450 20, 116
NSYSC2460 138	NSYSDF1010 370, 379	NSYSF12840P 20, 116	NSYSF18680T 20, 116	NSYSF20460 20, 116
NSYSC630 138	NSYSDF108 370, 379	NSYSF12860 20, 116	NSYSF18840 20, 116	NSYSF20480 20, 116
NSYSC640 138	NSYSDF11210 370, 379	NSYSF12860P 20, 116	NSYSF18840P 20, 116	NSYSF20640 20, 116
NSYSC650 138	NSYSDF128 370, 379	NSYSF14640 20, 116	NSYSF18840T 20, 116	NSYSF20640P 20, 116
NSYSC660 138	NSYSDF1610 370, 379	NSYSF14640P 20, 116	NSYSF18850 20, 116	NSYSF20640T 20, 116
NSYSC830 138	NSYSDF168 370, 379	NSYSF14840 20, 116	NSYSF18850P 20, 116	NSYSF20650 20, 116
NSYSC840 138	NSYSDF810 370, 379	NSYSF14840P 20, 116	NSYSF18850T 20, 116	NSYSF20650P 20, 116
NSYSC850 138	NSYSDF88 370, 379	NSYSF16660 20, 116	NSYSF18860 20, 116	NSYSF20650T 20, 116
NSYSC860 138	NSYSDFLOCKDB5 497	NSYSF16660P 20, 116	NSYSF188602D 20, 116	NSYSF20660 20, 116
NSYSCCDINLG140 287	NSYSDGCR10 286	NSYSF16660PC 385	NSYSF188602DP 20, 116	NSYSF20660P 20, 116
NSYSCCDINLG75 287	NSYSDGCR5 286	NSYSF16680 20, 116	NSYSF18860P 20, 116	NSYSF20660T 20, 116
NSYSCX10030 166	NSYSDGCR6 286	NSYSF16680P 20, 116	NSYSF201040 20, 116	NSYSF20660P 20, 116
NSYSCX10040 166	NSYSDGCR8 286	NSYSF16680PC 385	NSYSF2010402D 20, 116	NSYSF20680 20, 116
NSYSCX10060 166	NSYSDH 380, 494, 497	NSYSF16680P 20, 116	NSYSF2010402DP 20, 116	NSYSF20680P 20, 116
NSYSCX12040 166	NSYSDP•M 326	NSYSF16860 20, 116	NSYSF201040P 20, 116	NSYSF20840 20, 116
NSYSCX12050 166	NSYSDP6M 142, 297	NSYSF16860P 20, 116	NSYSF201040T 20, 116	NSYSF20840P 20, 116
NSYSCX12060 166	NSYSDP8M 142, 297	NSYSF16880 20, 116	NSYSF201050 20, 116	NSYSF20840T 20, 116
NSYSCX16040 166	NSYSDF100 260	NSYSF16880P 20, 116	NSYSF2010502D 20, 116	NSYSF20850 20, 116
NSYSCX16060 166	NSYSDF100A 260	NSYSF181040 20, 116		
NSYSCX6040 166				

Reference and Page	Reference and Page	Reference and Page	Reference and Page	Reference and Page
NSYSF20850P 20, 116	NSYSFC164 23, 119	NSYSFD1810T 22, 118	NSYSFHD1212602D 312, 317	NSYSFLOCKT7 145
NSYSF20850T 20, 116	NSYSFC165 23, 119	NSYSFD18122D 22, 118	NSYSFHD12640 312, 317	NSYSFLOCKT8 145
NSYSF20860 20, 116	NSYSFC166 23, 119	NSYSFD18122DT 22, 118	NSYSFHD12660 312, 317	NSYSFLR●●● 275
NSYSF208602D 20, 116	NSYSFC35 23, 119	NSYSFD184 22, 118, 124, 141	NSYSFHD12840 312, 317	NSYSFLR105 139
NSYSF208602DP 20, 116	NSYSFC36 23, 119	NSYSFD185 124, 141	NSYSFHD12860 312, 317	NSYSFLR106 139
NSYSF20860P 20, 116	NSYSFC44 22, 23, 118, 119	NSYSFD186 22, 118, 124, 141	NSYSFHD1612402D 312, 317	NSYSFLR65 139
NSYSF20860T 20, 116	NSYSFC45 22, 23, 118, 119	NSYSFD188 22, 118, 124, 141	NSYSFHD1612602D 312, 317	NSYSFLR66 139
NSYSF20880 20, 116	NSYSFC46 22, 23, 118, 119	NSYSFD1882D 22, 118	NSYSFHD16660 312, 317	NSYSFLR85 139
NSYSF20880P 20, 116	NSYSFC48 22, 23, 118, 119	NSYSFD188T 22, 118	NSYSFHD16840 312, 317	NSYSFLR86 139
NSYSF20880T 20, 116	NSYSFC64 22, 23, 118, 119	NSYSFD2010 23, 119	NSYSFHD16860 312, 317	NSYSFMDR 298
NSYSF221060 20, 116	NSYSFC65 22, 23, 118, 119	NSYSFD20102D 23, 119	NSYSFHD2 144	NSYSFNDR 298
NSYSF221060P 20, 116	NSYSFC66 22, 23, 118, 119	NSYSFD2010T 23, 119	NSYSFHD20840 312, 317	NSYSFP300 27, 200
NSYSF2212602D 20, 116	NSYSFC68 22, 23, 118, 119	NSYSFD20122D 23, 119	NSYSFHD3 144	NSYSFP400 27, 200
NSYSF2212602DP 20, 116	NSYSFC84 22, 23, 118, 119	NSYSFD20122DT 23, 119	NSYSFHD3 144	NSYSFP500 27, 200
NSYSF2212802D 20, 116	NSYSFC85 22, 23, 118, 119	NSYSFD20162D 23, 119	NSYSFHF18660 343	NSYSFP5G20750 325
NSYSF2212802DP 20, 116	NSYSFC86 22, 23, 118, 119	NSYSFD203 23, 119	NSYSFHF18840 343	NSYSFP5G20780 325
NSYSF22460 20, 116	NSYSFC88 22, 23, 118, 119	NSYSFD204 23, 119, 124, 141	NSYSFHF18860 343	NSYSFP600 27, 200
NSYSF22660 20, 116	NSYSFC88 22, 23, 118, 119	NSYSFD205 124, 141	NSYSFHF206100 343	NSYSFPB 247
NSYSF22660P 20, 116	NSYSFC88 22, 23, 118, 119	NSYSFD206 23, 119, 124, 141	NSYSFHF20640 343	NSYSFPSC15 42
NSYSF22680 20, 116	NSYSFC88 22, 23, 118, 119	NSYSFD206T 23, 119	NSYSFHF20660 343	NSYSFPSC20 42
NSYSF22680P 20, 116	NSYSFC88 22, 23, 118, 119	NSYSFD207 493	NSYSFHF20680 343	NSYSFPSC30 42, 68, 89, 95
NSYSF22860 20, 116	NSYSFC88 22, 23, 118, 119	NSYSFD207T 493	NSYSFHF208100 343	NSYSFPSC30HD 312
NSYSF22860P 20, 116	NSYSFC88 22, 23, 118, 119	NSYSFD208 23, 119, 124, 141	NSYSFHF20840 343	NSYSFPSC40 42, 68, 89, 95
NSYSF22880 20, 116	NSYSFC88 22, 23, 118, 119	NSYSFD2082D 23, 119	NSYSFHF20860 343	NSYSFPSC40HD 312
NSYSF22880P 20, 116	NSYSFC88 22, 23, 118, 119	NSYSFD208T 23, 119	NSYSFHF20880 343	NSYSFPSC50 42, 68, 89, 95
NSYSF5G20350 325	NSYSFC88 22, 23, 118, 119	NSYSFD2210 23, 119	NSYSFHF22660 343	NSYSFPSC50HD 312
NSYSF5G20380 325	NSYSFC88 22, 23, 118, 119	NSYSFD2210T 23, 119	NSYSFHF22860 343	NSYSFPSC60 42, 68, 89, 95
NSYSF5G20680 323	NSYSFC88 22, 23, 118, 119	NSYSFD22122D 23, 119	NSYSFHF22880 343	NSYSFPSC60HD 312
NSYSF5G20860 323	NSYSFC88 22, 23, 118, 119	NSYSFD22122DT 23, 119	NSYSFHF2840 343	NSYSFPSC80 42, 68, 89, 95
NSYSFBK 126	NSYSFC88 22, 23, 118, 119	NSYSFD2220T 23, 119	NSYSFHF20860 343	NSYSFPSC80HD 312
NSYSFBK19 25, 126, 167	NSYSFC88 22, 23, 118, 119	NSYSFD2220T 23, 119	NSYSFHF20880 343	NSYSFPSC80HD 312
NSYSFBKE 126	NSYSFC88 22, 23, 118, 119	NSYSFD2222D 23, 119	NSYSFHF22660 343	NSYSFPSC80 42, 68, 89, 95
NSYSFBKF 126	NSYSFC88 22, 23, 118, 119	NSYSFD2222DT 23, 119	NSYSFHF2880 343	NSYSFSPLM 27, 200
NSYSFBKR 126	NSYSFC88 22, 23, 118, 119	NSYSFD224 23, 119, 124, 141	NSYSFHF2880 343	NSYSFTB16 136
NSYSFBKSH 126	NSYSFC88 22, 23, 118, 119	NSYSFD225 124, 141	NSYSFHF2880 343	NSYSFTB18 136
NSYSFC104 22, 23, 118, 119	NSYSFC88 22, 23, 118, 119	NSYSFD226 23, 119, 124, 141	NSYSFHF2880 343	NSYSFTB24 136
NSYSFC105 22, 23, 118, 119	NSYSFC88 22, 23, 118, 119	NSYSFD226T 23, 119	NSYSFHF2880 343	NSYSFTB32 136
NSYSFC106 22, 23, 118, 119	NSYSFC88 22, 23, 118, 119	NSYSFD228 23, 119, 124, 141	NSYSFHF2880 343	NSYSFTBS 137
NSYSFC108 22, 23, 118, 119	NSYSFC88 22, 23, 118, 119	NSYSFD228T 23, 119	NSYSFHF2880 343	NSYSFV12 22, 118
NSYSFC124 22, 23, 118, 119	NSYSFC88 22, 23, 118, 119	NSYSFEB 136	NSYSFHF2880 343	NSYSFV14 22, 118
NSYSFC125 22, 23, 118, 119	NSYSFC88 22, 23, 118, 119	NSYSFECA64HD 499	NSYSFHF2880 343	NSYSFV16 22, 118
NSYSFC126 22, 23, 118, 119	NSYSFC88 22, 23, 118, 119	NSYSFECA66HD 317, 499	NSYSFHF2880 343	NSYSFV18 22, 118
NSYSFC128 22, 23, 118, 119	NSYSFC88 22, 23, 118, 119	NSYSFELB 136	NSYSFHF2880 343	NSYSFV20 23, 119
	NSYSFC88 22, 23, 118, 119	NSYSFHD1212402D 312, 317	NSYSFHF2880 343	NSYSFV22 23, 119
	NSYSFC88 22, 23, 118, 119		NSYSFHF2880 343	NSYSFVG 493
	NSYSFC88 22, 23, 118, 119		NSYSFHF2880 343	NSYSFWFIX 140
	NSYSFC88 22, 23, 118, 119		NSYSFHF2880 343	NSYSFX181240 25, 161
	NSYSFC88 22, 23, 118, 119		NSYSFHF2880 343	NSYSFX18640 25, 161
	NSYSFC88 22, 23, 118, 119		NSYSFHF2880 343	NSYSFX18840 25, 161
	NSYSFC88 22, 23, 118, 119		NSYSFHF2880 343	NSYSFX201060 25, 161

Reference and Page	Reference and Page	Reference and Page	Reference and Page	Reference and Page
NSYSFX201260 25, 161	NSYSM1610302DP 18, 114	NSYSM18830 18, 114	NSYSM20850P 18, 114	NSYSMP2D5 248
NSYSFX20650 25, 161	NSYSM1610402D 18, 114	NSYSM18830P 18, 114	NSYSM20850T 18, 114	NSYSMP2D6 248
NSYSFX20840 25, 161	NSYSM1610402DP 18, 114	NSYSM18830T 18, 114	NSYSM20860 18, 114	NSYSMP2D8 248
NSYSFX20860 25, 161	NSYSM1612302D 18, 114	NSYSM18840 18, 114	NSYSM20860P 18, 114	NSYSMPB 247, 248
NSYSFXJG 25, 167	NSYSM1612302DP 18, 114	NSYSM18840P 18, 114	NSYSM20860T 18, 114	NSYSMPPE 326
NSYSGF 133	NSYSM1612402D 18, 114	NSYSM18840T 18, 114	NSYSMBCE10 135	NSYSMPFA 243
NSYSH180 143	NSYSM1612402DP 18, 114	NSYSM18850 18, 114	NSYSMBCE6 135	NSYSMPFB 243, 326
NSYSIBTB 247	NSYSM1612402D 18, 114	NSYSM18850P 18, 114	NSYSMBCE8 135	NSYSMPS4 247
NSYSIMP12 21, 116, 243	NSYSM1612402DP 18, 114	NSYSM18850T 18, 114	NSYSMBK 126	NSYSMPS5 247
NSYSIMP14 21, 116, 243	NSYSM1616630 18, 114	NSYSM18860 18, 114	NSYSMD12102D 493	NSYSMPS6 247
NSYSIMP16 21, 116, 243	NSYSM16630P 18, 114	NSYSM18860P 18, 114	NSYSMD12122D 493	NSYSMPS8 247
NSYSIMP18 21, 116, 243	NSYSM16640 18, 114	NSYSM2010402D 18, 114	NSYSMD14102D 493	NSYSMPSPB 247, 326
NSYSIMP20 21, 116, 243	NSYSM16640P 18, 114	NSYSM2010402DP 18, 114	NSYSMD14122D 493	NSYSMPSE10 248
NSYSIMP22 21, 116, 243	NSYSM16640T 18, 114	NSYSM2010502D 18, 114	NSYSMD16102D 493	NSYSMPSE12 248
NSYSKAV 313	NSYSM16640P 18, 114	NSYSM2010502DP 18, 114	NSYSMD16122D 493	NSYSMPSE6 248
NSYSLCKP 395	NSYSM16640T 18, 114	NSYSM2010502DP 18, 114	NSYSMD18162D 493	NSYSMPSE8 248
NSYSLCKS10 395	NSYSM16830 18, 114	NSYSM2012402D 18, 114	NSYSMDR 298	NSYSMVR12 258
NSYSLCKS6 395	NSYSM16830P 18, 114	NSYSM2012402DP 18, 114	NSYSMEB 136, 167	NSYSMVR14 258
NSYSLCKS8 395	NSYSM16830T 18, 114	NSYSM2012402DP 18, 114	NSYSMEC103 134	NSYSMVR16 258
NSYSLCR40 256	NSYSM16840 18, 114	NSYSM2012502D 18, 114	NSYSMEC1031 493	NSYSMVR18 258
NSYSLCR50 256	NSYSM16840P 18, 114	NSYSM2012502DP 18, 114	NSYSMEC104 134	NSYSMVR20 258
NSYSLCR60 256	NSYSM16840T 18, 114	NSYSM2012602D 18, 114	NSYSMEC1041 493	NSYSMWFIX 140
NSYSLCR80 256	NSYSM181040 18, 114	NSYSM2012602DP 18, 114	NSYSMEC105 134	NSYSMX141030 25, 161
NSYSM10M5HP 291	NSYSM1810402D 18, 114	NSYSM2012602DP 18, 114	NSYSMEC1051 493	NSYSMX16660PC 389
NSYSM1210302D 18, 114	NSYSM1810402DP 18, 114	NSYSM2012602D 18, 114	NSYSMEC63 134	NSYSMX16840 25, 161
NSYSM1210302DP 18, 114	NSYSM181040P 18, 114	NSYSM2016402D 18, 114	NSYSMEC631 493	NSYSMX181240 25, 161
NSYSM1212402D 18, 114	NSYSM1810502D 18, 114	NSYSM2016402DP 18, 114	NSYSMEC64 134	NSYSMX181240H 161
NSYSM1212402DP 18, 114	NSYSM1810502DP 18, 114	NSYSM2016402DP 18, 114	NSYSMEC641 493	NSYSMX181640 25, 161
NSYSM12830 18, 114	NSYSM1812402D 18, 114	NSYSM2016502D 18, 114	NSYSMEC65 134	NSYSMX181640H 161
NSYSM12830P 18, 114	NSYSM1812402DP 18, 114	NSYSM2016502DP 18, 114	NSYSMEC651 493	NSYSMX18640 25, 161
NSYSM1410402D 18, 114	NSYSM1812502D 18, 114	NSYSM2016602D 18, 114	NSYSMEC66 134	NSYSMX18660PC 389
NSYSM1410402DP 18, 114	NSYSM1812502DP 18, 114	NSYSM2016602DP 18, 114	NSYSMEC661 493	NSYSMX18840 25, 161
NSYSM1412402D 18, 114	NSYSM1816402D 18, 114	NSYSM2020630 18, 114	NSYSMEC83 134	NSYSMX18840H 161
NSYSM1412402DP 18, 114	NSYSM1816402DP 18, 114	NSYSM2020630P 18, 114	NSYSMEC831 493	NSYSMX201040 25, 161
NSYSM14630 18, 114	NSYSM1816502D 18, 114	NSYSM2020640 18, 114	NSYSMEC84 134	NSYSMX201040H 161
NSYSM14630P 18, 114	NSYSM1816502DP 18, 114	NSYSM2020640P 18, 114	NSYSMEC841 493	NSYSMX201250 25, 161
NSYSM14640 18, 114	NSYSM1818630 18, 114	NSYSM2020640T 18, 114	NSYSMEC85 134	NSYSMX201250H 161
NSYSM14640P 18, 114	NSYSM1818630P 18, 114	NSYSM2020650 18, 114	NSYSMEC851 493	NSYSMX201660 25, 161
NSYSM14830 18, 114	NSYSM1818630P 18, 114	NSYSM2020650P 18, 114	NSYSMEC86 134	NSYSMX201660H 161
NSYSM14830P 18, 114	NSYSM1818640 18, 114	NSYSM2020830 18, 114	NSYSMEC861 493	NSYSMX20850 25, 161
NSYSM14840 18, 114	NSYSM1818640P 18, 114	NSYSM2020830P 18, 114	NSYSMHF18660P 343	NSYSNLPLA 224
NSYSM14840P 18, 114	NSYSM1818640T 18, 114	NSYSM2020840 18, 114	NSYSMHF18860P 343	NSYSNM6 250, 263, 268
NSYSM14840T 18, 114	NSYSM1818650 18, 114	NSYSM2020840P 18, 114	NSYSMHF20840P 343	NSYSNM8 250, 263, 268
NSYSM1610302D 18, 114	NSYSM1818650P 18, 114	NSYSM2020840T 18, 114	NSYSMHF20860P 343	NSYSNSM6 250, 263, 268
		NSYSM2020840T 18, 114	NSYSMHR10 258	NSYSNSM8 250, 263, 268
		NSYSM2020850 18, 114	NSYSMHR12 258	NSYSODS 395
			NSYSMHR16 258	NSYSPB6100 133
			NSYSMHR6 258	NSYSPB8100 133
			NSYSMHR8 258	NSYSPC 291
			NSYSMNDR 298	NSYSPC4100 133
			NSYSMP2D4 248	

Reference and Page	Reference and Page	Reference and Page	Reference and Page	Reference and Page
NSYSPC5100 133	NSYSPFX12100H 26, 164, 165, 378	NSYSPRJ 296	NSYSPSX5200SF 25, 165	NSYSTDNCSX 157
NSYSPC6100 133	NSYSPFX12200 25, 164, 165, 312	NSYSPS3100 18, 114, 133	NSYSPSX6100 25, 164	NSYSTMP22100 242
NSYSPC8100 133	NSYSPFX12200H 25, 164, 165, 378	NSYSPS3100SD 89, 97	NSYSPSX6100H 164, 165, 389	NSYSTMP22120 242
NSYSPCP 16, 50, 291	NSYSPFX16100 25, 164	NSYSPS3200 18, 114, 133	NSYSPSX6100SF 25, 165	NSYSTMP2260 242
NSYSPCR 133	NSYSPFX16100H 164	NSYSPS3200SD 89, 97	NSYSPSX6200 25, 164	NSYSTMP2280 242
NSYSPF10100 18, 21, 89, 97, 114, 116, 133, 378	NSYSPFX16200 25, 164	NSYSPS4100 18, 21, 114, 116, 133	NSYSPSX6200H 164, 165	NSYSTMP45100 242
NSYSPF10200 18, 21, 89, 97, 114, 116, 133, 378	NSYSPFX16200H 164	NSYSPS4100SD 89, 97, 378	NSYSPSX6200SF 25, 165, 312	NSYSTMP45120 242
NSYSPF12100 18, 21, 89, 97, 378	NSYSPFX6100 25, 164, 165	NSYSPS4200 18, 21, 114, 116, 133	NSYSPV6100 133	NSYSTMP4560 242
NSYSPF12200 18, 21, 89, 97, 114, 116, 133, 378	NSYSPFX6100H 25, 378, 389	NSYSPS4200SD 89, 97, 378	NSYSPV8100 133	NSYSTMP4580 242
NSYSPF16100 18, 21, 114, 116, 133, 378	NSYSPFX6200 25, 164, 165	NSYSPS5100 18, 21, 114, 116, 133	NSYSQCR12040 493	NSYSTMP60100 242, 382
NSYSPF16200 18, 21, 114, 116, 133, 378	NSYSPFX6200 25, 312	NSYSPS5100SD 378	NSYSQCR12050 493	NSYSTMP60120 242, 382
NSYSPF3100 21, 116, 133	NSYSPFX6200H 378, 389	NSYSPS5200 18, 21, 114, 116, 133	NSYSQCR12060 493	NSYSTMP6060 242
NSYSPF3200 21, 116, 133	NSYSPFX8100 25, 97, 155, 164, 165	NSYSPS5200SD 378	NSYSQCR12080 493	NSYSTMP6080 242, 382
NSYSPF4100 21, 116, 133	NSYSPFX8100H 25, 97, 155, 164, 165, 378	NSYSPS6100 18, 21, 114, 116, 133, 386	NSYSQCR12080 493	NSYSTMP82100 242
NSYSPF4200 21, 116, 133	NSYSPFX8200 25, 97, 155, 164, 165, 378	NSYSPS6100SD 378	NSYSQCR40100 254	NSYSTMP82120 242
NSYSPF6100 18, 21, 89, 97, 114, 116, 133, 378, 386	NSYSPFX8200H 25, 97, 155, 164, 378	NSYSPS6200 18, 21, 114, 116, 133, 386	NSYSQCR40120 254	NSYSTMP8260 242
NSYSPF6200 18, 21, 89, 97, 114, 116, 133, 378, 386	NSYSPLA100 231, 233	NSYSPS6200SD 378	NSYSQCR4040 254, 259	NSYSTMP8280 242
NSYSPF8100 18, 21, 89, 97, 114, 116, 133, 378	NSYSPLA125 231, 233	NSYSPS8100 21, 116, 133, 386	NSYSQCR4050 254, 259	NSYSWTW 296
NSYSPF8200 18, 21, 89, 97, 114, 116, 133, 378	NSYSPLA150 231, 233	NSYSPS8200 21, 116, 133, 386	NSYSQCR4060 254, 259	NSYSUCR40100 254
NSYSPFC16100 133	NSYSPLA75 231, 233	NSYSPS8200SD 378	NSYSQCR4060 386	NSYSUCR40110 133, 254
NSYSPFC16200 133	NSYSPLK 131	NSYSPS8100 21, 116, 133, 386	NSYSQCR4080 254, 259, 386	NSYSUCR40120 254
NSYSPFC18100 133	NSYSPLVX3200 312	NSYSPS8200 21, 116, 133, 386	NSYSQCR65100 254	NSYSUCR40140 254
NSYSPFC18200 133	NSYSPLVX4200 312, 317	NSYSPSJ 296	NSYSQCR65120 254	NSYSUCR40150 133
NSYSPFC24100 133	NSYSPLVX4200SF 312	NSYSPSX3100 25, 97, 155, 164	NSYSQCR6540 254	NSYSUCR40160 254
NSYSPFC24200 133	NSYSPLVX6200 317	NSYSPSX3100H 97, 155, 164	NSYSQCR6550 254	NSYSUCR40180 254
NSYSPFV6100 133	NSYSPLVX6200SF 312	NSYSPSX3200 25, 97, 155, 164, 312, 317	NSYSQCR6560 254	NSYSUCR40200 254
NSYSPFV8100 133	NSYSPLVX6200SF 312	NSYSPSX3200H 97, 155, 164	NSYSQCR6580 254	NSYSUCR40220 254
NSYSPFVX12200 312, 317	NSYSPLM6 131	NSYSPSX3200H 97, 155, 164	NSYSQCR90100 254	NSYSUCR4030 133, 245
NSYSPFVX6200 312, 317	NSYSPMP25100 226, 242	NSYSPSX4100 25, 164	NSYSQCR90120 254	NSYSUCR4040 133, 254, 259
NSYSPFVX8200 312, 317	NSYSPMP25120 242	NSYSPSX4100H 164, 165	NSYSQCR9040 254	NSYSUCR4050 133, 254, 259
NSYSPFX10100 25, 97, 155, 164, 165	NSYSPMP2560 242	NSYSPSX4100SF 25, 165	NSYSQCR9050 254	NSYSUCR4060 254, 259, 386, 441
NSYSPFX10100H 25, 97, 155, 164, 165, 378	NSYSPMP2575 226, 242	NSYSPSX4200 25, 164, 312	NSYSQCR9060 254	NSYSUCR4070 133, 254
NSYSPFX10200 25, 97	NSYSPMP2580 242	NSYSPSX4200H 164, 165	NSYSQCR9080 254	NSYSUCR4080 254, 259, 386, 441
NSYSPFX10200H 25, 97, 155, 164, 165, 378	NSYSPMP40100 226, 242, 382	NSYSPSX4200SF 25, 165, 312	NSYSRCE1050 139	NSYSUCR4090 133, 254
NSYSPFX12100 25, 164, 165	NSYSPMP40120 242, 382	NSYSPSX5100 25, 164	NSYSRCE1060 139	NSYSUCR65100 254
	NSYSPMP40160 242, 382	NSYSPSX5100H 25, 164, 165, 378	NSYSRCE650 139	NSYSUCR65120 254
	NSYSPMP4060 242	NSYSPSX5100SF 25, 165	NSYSRCE660 139	NSYSUCR65140 254
	NSYSPMP4080 242, 382	NSYSPSX5200 25, 164	NSYSRCE850 139	NSYSUCR65160 254
	NSYSPMP60100 242	NSYSPSX5200H 164, 165	NSYSRCE860 139	NSYSUCR65180 254
	NSYSPMP60120 242		NSYST30M6 268	NSYSUCR65200 254
	NSYSPMP6060 242		NSYST30M6S 256, 268	NSYSUCR65220 254
	NSYSPMP6080 242		NSYST40M8 268	NSYSUCR6530 254
			NSYSTBR3 248	NSYSUCR6540 254
			NSYSTBR4 248	NSYSUCR6550 254
			NSYSTBR5 248	NSYSUCR6560 254
			NSYSTBR6 248	NSYSUCR6580 254
			NSYSTDCSX 157	
			NSYSTDCXH 157	







Reference and Page	Reference and Page
NSYZM283 27, 199	XALEK1702 173
NSYZNPLA103 31, 220	
NSYZNPLA104 31, 220	
NSYZNPLA123 31, 220	
NSYZNPLA124 31, 220	
NSYZNPLA53 31, 220	
NSYZNPLA54 31, 220	
NSYZNPLA73 31, 220	
NSYZNPLA74 31, 220	
NSYZZ2103 31, 222	
NSYZZ2104 31, 222	
NSYZZ2123 31, 222	
NSYZZ2124 31, 222	
NSYZZ2124G 310	
NSYZZ2124VHD 310, 317	
NSYZZ2126G 310	
NSYZZ2126VHD 310, 317	
NSYZZ253 31, 222	
NSYZZ254 31, 222	
NSYZZ254G 310	
NSYZZ254VHD 310, 317	
NSYZZ273 31, 222	
NSYZZ274 31, 222	
NSYZZ274G 310	
NSYZZ274VHD 310, 317	
NSYZZ276G 310	
NSYZZ276VHD 310, 317	
NSYZZ5103 31, 222	
NSYZZ5104 31, 222	
NSYZZ5123 31, 222	
NSYZZ5124 31, 222	
NSYZZ553 31, 222	
NSYZZ554 31, 222	
NSYZZ573 31, 222	
NSYZZ574 31, 222	
<b>OLPU...</b>	
OLPU186 494	
OLPU188 494	
OLPU188KT 494	
OLPU2010 494	
OLPU206 494	
OLPU208 494	
OLPU208KT 494	
<b>XALE...</b>	
XALE2 173	
XALE2141 173	
XALE3 173	
XALE3255 173	
XALEK1702 173	

**Schneider Electric USA, Inc.**

800 Federal Street  
Andover, MA 01810 USA  
888-778-2733  
[www.schneider-electric.us](http://www.schneider-electric.us)

The information provided in this documentation contains general descriptions and/or technical characteristics of the performance of the products contained herein. This documentation is not intended as a substitute for and is not to be used for determining suitability or reliability of these products for specific user applications. It is the duty of any such user or integrator to perform the appropriate and complete risk analysis, evaluation and testing of the products with respect to the relevant specific application or use thereof. Neither Schneider Electric nor any of its affiliates or subsidiaries shall be responsible or liable for misuse of the information contained herein.

Schneider Electric is the trademark and the property of Schneider Electric SE, its subsidiaries, and affiliated companies. All other trademarks are the property of their respective owners.

9993CT0901R08/16  
Replaces 9993CT0901R02/13 dated 02/2013

© 2010–2016 Schneider Electric. All Rights Reserved.