

Switches, Single Pole 20A, 120-277V AC Pre-Wired Specification Grade Commercial Toggle Switch

HUBBELL

Features

- Labor Saving
- Thread cleaning captive mounting screw
- Abuse resistant nylon toggle

Ordering Information

Description	Toggle Color	UPC	Catalog Number
Toggle, Nylon, Pre-wired leads	Gray	783585187280	CSL120GY

Listings

UL Listed
CSA Certified
Fed. Spec. W-S-896

Specifications

Top Material	Thermoplastic, Gray
Base Material	Thermoset, Gray
Toggle Material	Nylon
Contacts	Silver Alloy
Terminal Screws	Brass
Auto Grounding Mounting Bridge	Zinc Plated Steel
Lead Type	#12 AWG THHN, 8" Length

Performance

Electrical

Dielectric Voltage	Withstands 1500V AC minimum for 1 minute
Max. Continuous Current	20A
Max. Working Voltage	277V AC
Overload	Minimum 4.8 times rated current for 100 cycles
Temperature Rise	30°C maximum at rated current

Mechanical

Terminal Accommodations #14 AWG min. - #10 AWG max. solid and stranded copper wire only

Environmental

Flammability	UL 94V-2
Operating Temperature	Max. continuous: 75°C; Min. continuous: -40°C without impact

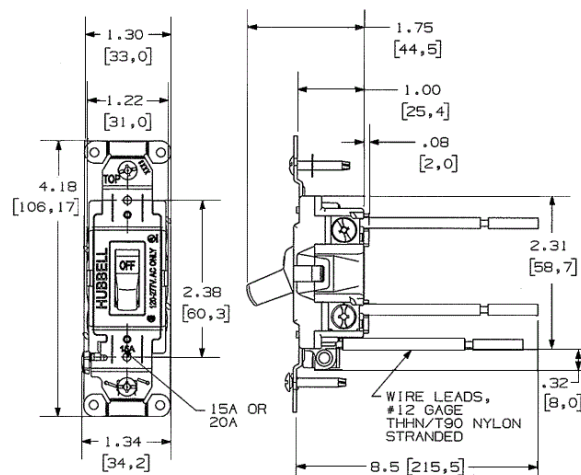

Online Resources

Customer Use Drawing
eCatalog
Installation Instructions

Dimensions in Inches (mm)

Hubbell Wiring Device-Kellems • Hubbell Incorporated (Delaware) • 40 Waterview Drive • Shelton, CT 06484

Phone (800) 288-6000 • Fax (800) 255-1031 • Specifications subject to change without notice.

